

FCC Test Report

(Part 22)

Report No.: RF140107C15L

FCC ID: JNF-Z-224X

Test Model: Z-2242

Series Model: Z-2240

Received Date: Dec. 26, 2013

Test Date: Jun. 18 ~ Aug. 25, 2015 (All tests except ERP & Radiated Emission Below 1GHz tests)

Dec. 01, 2015 ~ Jan. 31, 2016 (ERP & Radiated Emission Below 1GHz tests)

Issued Date: Feb. 02, 2016

Applicant: ZEBEX INDUSTRIES INC.

Address: B1F.-1, No. 207, Sec. 3, Beixin Rd, Xindian Dist, New Taipei City 23143, Taiwan

Issued By: Bureau Veritas Consumer Products Services (H.K.) Ltd., Taoyuan Branch

Lab Address: No. 47-2, 14th Ling, Chia Pau Vil., Lin Kou Dist., New Taipei City, Taiwan (R.O.C.)

Test Location: No.19, Hwa Ya 2nd Rd., Wen Hwa Vil., Kwei Shan Dist., Taoyuan City 33383, TAIWAN (R.O.C.)



This report is for your exclusive use. Any copying or replication of this report to or for any other person or entity, or use of our name or trademark, is permitted only with our prior written permission. This report sets forth our findings solely with respect to the test samples identified herein. The results set forth in this report are not indicative or representative of the quality or characteristics of the lot from which a test sample was taken or any similar or identical product unless specifically and expressly noted. Our report includes all of the tests requested by you and the results thereof based upon the information that you provided to us. You have 60 days from date of issuance of this report to notify us of any material error or omission caused by our negligence, provided, however, that such notice shall be in writing and shall specifically address the issue you wish to raise. A failure to raise such issue within the prescribed time shall constitute your unqualified acceptance of the completeness of this report, the tests conducted and the correctness of the report contents. Unless specific mention, the uncertainty of measurement has been explicitly taken into account to declare the compliance or non-compliance to the specification. The report must not be used by the client to claim product certification, approval, or endorsement by TAF or any government agencies

Table of Contents

Release Control Record	3
1 Certificate of Conformity	4
2 Summary of Test Results	5
2.1 Measurement Uncertainty	5
2.2 Test Site And Instruments	6
3 General Information	8
3.1 General Description of EUT	8
3.2 Configuration of System Under Test	10
3.2.1 Description Of Support Units.....	11
3.3 Test Mode Applicability and Tested Channel Detail	12
3.4 EUT Operating Conditions	13
3.5 General Description of Applied Standards	13
4 Test Types and Results	14
4.1 Output Power Measurement	14
4.1.1 Limits of Output Power Measurement.....	14
4.1.2 Test Procedures.....	14
4.1.3 Test Setup.....	15
4.1.4 Test Results	16
4.2 Frequency Stability Measurement	23
4.2.1 Limits of Frequency Stability Measurement	23
4.2.2 Test Procedure	23
4.2.3 Test Setup.....	23
4.2.4 Test Results	24
4.3 Occupied Bandwidth Measurement	25
4.3.1 Test Procedure	25
4.3.2 Test Setup.....	25
4.3.3 Test Result.....	26
4.4 Band Edge Measurement	27
4.4.1 Limits of Band Edge Measurement	27
4.4.2 Test Setup.....	27
4.4.3 Test Procedures.....	27
4.4.4 Test Results	28
4.5 Peak To Average Ratio.....	30
4.5.1 Limits of Peak To Average Ratio Measurement	30
4.5.2 Test Setup.....	30
4.5.3 Test Procedures	30
4.5.4 Test Results.....	31
4.6 Conducted Spurious Emissions	32
4.6.1 Limits of Conducted Spurious Emissions Measurement.....	32
4.6.2 Test Setup.....	32
4.6.3 Test Procedure	32
4.6.4 Test Results	33
4.7 Radiated Emission Measurement	51
4.7.1 Limits of Radiated Emission Measurement.....	51
4.7.2 Test Procedure	51
4.7.3 Deviation from Test Standard	51
4.7.4 Test Setup.....	52
4.7.5 Test Results	53
5 Pictures of Test Arrangements	61
Appendix – Information on the Testing Laboratories	62



A D T

Release Control Record

Issue No.	Description	Date Issued
RF140107C15L	Original release.	Feb. 02, 2016

1 Certificate of Conformity

Product: Rugged Mobile Handheld Computer

Brand: ZEBEX

Test Model: Z-2242

Series Model: Z-2240

Sample Status: MASS-PRODUCT

Applicant: ZEBEX INDUSTRIES INC.

Test Date: Jun. 18 ~ Aug. 25, 2015 (All tests except ERP & Radiated Emission Below 1GHz tests)

Dec. 01, 2015 ~ Jan. 31, 2016 (ERP & Radiated Emission Below 1GHz tests)

Standards: FCC Part 22, Subpart H

The above equipment has been tested by **Bureau Veritas Consumer Products Services (H.K.) Ltd., Taoyuan Branch**, and found compliance with the requirement of the above standards. The test record, data evaluation & Equipment Under Test (EUT) configurations represented herein are true and accurate accounts of the measurements of the sample's EMC characteristics under the conditions specified in this report.

Prepared by :  , **Date:** Feb. 02, 2016
Ivy Lin / Specialist

Approved by :  , **Date:** Feb. 02, 2016
Dylan Chiou / Project Engineer

2 Summary of Test Results

Applied Standard: FCC Part 22 & Part 2			
FCC Clause	Test Item	Result	Remarks
2.1046 22.913 (a)	Effective radiated power	PASS	Meet the requirement of limit.
---	Peak To Average Ratio	PASS	Meet the requirement of limit.
2.1055 22.355	Frequency Stability	PASS	Meet the requirement of limit.
2.1049	Occupied Bandwidth	PASS	Meet the requirement of limit.
22.917	Band Edge Measurements	PASS	Meet the requirement of limit.
2.1051 22.917	Conducted Spurious Emissions	PASS	Meet the requirement of limit.
2.1053 22.917	Radiated Spurious Emissions	PASS	Meet the requirement of limit. Minimum passing margin is -19.90dB at 2546.40MHz.

2.1 Measurement Uncertainty

Where relevant, the following measurement uncertainty levels have been estimated for tests performed on the EUT as specified in CISPR 16-4-2:

Measurement	Frequency	Expanded Uncertainty (k=2) (
-------------	-----------	------------------------------



2.2 Test Site And Instruments

Test date: Jun. 18 ~ Aug. 25, 2015

Description & Manufacturer	Model No.	Serial No.	Cal. Date	Cal. Due
Test Receiver ROHDE & SCHWARZ	ESCS30	100289	Dec. 01, 2014	Nov. 30, 2015
Spectrum Analyzer ROHDE & SCHWARZ	FSP40	100269	Mar. 30, 2015	Mar. 29, 2016
BILOG Antenna SCHWARZBECK	VULB9168	9168-156	Feb. 06, 2015	Feb. 05, 2016
HORN Antenna SCHWARZBECK	BBHA 9120 D	9120D-1169	Feb. 09, 2015	Feb. 08, 2016
HORN Antenna SCHWARZBECK	BBHA 9170	BBHA9170241	Feb. 09, 2015	Feb. 08, 2016
Preamplifier Agilent	8449B	3008A01911	Aug. 09, 2014	Aug. 08, 2015
			Aug. 09, 2015	Aug. 08, 2016
Preamplifier Agilent	8447D	2944A10638	Aug. 09, 2014	Aug. 08, 2015
			Aug. 09, 2015	Aug. 08, 2016
RF signal cable HUBER+SUHNNER	SUCOFLEX 104	248780/4 309222/4 274092/4	Aug. 09, 2014	Aug. 08, 2015
			Aug. 09, 2015	Aug. 08, 2016
RF signal cable Worken	8D-FB	Cable-CH9-01	Aug. 11, 2014	Aug. 10, 2015
			Aug. 11, 2015	Aug. 10, 2016
Software BV ADT	ADT_Radiated_ V7.6.15.9.4	NA	NA	NA
Antenna Tower EMCO	2070/2080	512.835.4684	NA	NA
Turn Table EMCO	2087-2.03	NA	NA	NA
Antenna Tower & Turn BV ADT	AT100	AT93021705	NA	NA
Turn Table BV ADT	TT100	TT93021705	NA	NA
Turn Table Controller BV ADT	SC100	SC93021705	NA	NA
Mini-Circuits Power Splitter	ZN2PD-9G	NA	Jun. 09, 2015	Jun. 08, 2016
JFW 20dB attenuation	50HF-020-SMA	NA	NA	NA

- Note:
1. The calibration interval of the above test instruments is 12 months and the calibrations are traceable to NML/ROC and NIST/USA.
 2. The test was performed in HwaYa Chamber 9.
 3. The horn antenna and HP preamplifier (model: 8449B) are used only for the measurement of emission frequency above 1GHz if tested.
 4. The FCC Site Registration No. is 215374.
 5. The IC Site Registration No. is IC 7450F-9.



A D T

Test date: Dec. 01, 2015 ~ Jan. 31, 2016

Description & Manufacturer	Model No.	Serial No.	Cal. Date	Cal. Due
Test Receiver ROHDE & SCHWARZ	ESIB7	100187	Apr. 10, 2015	Apr. 09, 2016
Spectrum Analyzer ROHDE & SCHWARZ	FSP40	100269	Mar. 30, 2015	Mar. 29, 2016
BILOG Antenna SCHWARZBECK	VULB9168	9168-148	Feb. 02, 2015	Feb. 01, 2016
HORN Antenna SCHWARZBECK	BBHA 9120 D	9120D-1169	Feb. 09, 2015	Feb. 08, 2016
HORN Antenna SCHWARZBECK	BBHA 9170	BBHA9170241	Feb. 09, 2015	Feb. 08, 2016
Preamplifier Agilent	8449B	3008A01911	Aug. 09, 2015	Aug. 08, 2016
Preamplifier Agilent	8447D	2944A10638	Aug. 09, 2015	Aug. 08, 2016
RF signal cable HUBER+SUHNER	SUCOFLEX 104	CABLE-CH9-02(309222 +248780)	Aug. 09, 2015	Aug. 08, 2016
RF signal cable HUBER+SUHNER	SUCOFLEX 104	CABLE-CH9-03(274092)	Aug. 09, 2015	Aug. 08, 2016
RF signal cable Woken	8D-FB	Cable-CH9-01	Aug. 11, 2015	Aug. 10, 2016
Software BV ADT	ADT_Radiated_ V7.6.15.9.4	NA	NA	NA
Antenna Tower EMCO	2070/2080	512.835.4684	NA	NA
Turn Table EMCO	2087-2.03	NA	NA	NA
Antenna Tower & Turn BV ADT	AT100	AT93021705	NA	NA
Turn Table BV ADT	TT100	TT93021705	NA	NA
Turn Table Controller BV ADT	SC100	SC93021705	NA	NA
WIT Standard Temperature And Humidity Chamber	TH-4S-C	W981030	Jun. 08, 2015	Jun. 07, 2016
Mini-Circuits Power Splitter	ZN2PD-9G	NA	Jun. 09, 2015	Jun. 08, 2016
JFW 20dB attenuation	50HF-020-SMA	NA	NA	NA

- Note: 1. The calibration interval of the above test instruments is 12 months and the calibrations are traceable to NML/ROC and NIST/USA.
2. The test was performed in HwaYa Chamber 9.
3. The horn antenna and preamplifier (model: 8449B) are used only for the measurement of emission frequency above 1GHz if tested.
4. The FCC Site Registration No. is 215374.
5. The IC Site Registration No. is IC 7450F-9.

3 General Information

3.1 General Description of EUT

Product	Rugged Mobile Handheld Computer
Brand	ZEBEX
Test Model	Z-2242
Series Model	Z-2240
Model Difference	Refer to note as below
Status of EUT	Engineering sample
Power Supply Rating	3.7Vdc (Battery) 5.35Vdc (Adapter) 5.0Vdc (Cradle) 19Vdc (Wireless Power Charger)
Modulation Type	GSM, GPRS: GMSK EDGE: 8PSK WCDMA: BPSK, QPSK HSPDA: BPSK HUPDA: QPSK
Operating Frequency	GSM, GPRS, EDGE: 824.2MHz ~ 848.8MHz WCDMA, HSUPA, HSDPA: 826.4MHz ~ 846.6MHz
Max. ERP Power	GSM: 1202.264mW (30.8dBm) GPRS: 1621.810mW (32.1dBm) EDGE: 436.516 mW (26.4dBm) WCDMA: 165.959mW (22.2dBm) HSPDA: 204.174mW (23.1dBm) HUPDA: 186.209mW (22.7dBm)
Antenna Type	PIFA antenna with 1.21dBi gain
Antenna Connector	ipex
Accessory Device	Refer to Note as below
Data Cable Supplied	Refer to Note as below

Note:

1. All brands and models are listed as below. After pretesting, the model of the Z-2242 was worst case and chosen for final test.

Brand	Model	Description	
ZEBEX	Z-2242	Barcode scanner	Marketing Different
	Z-2240	Non-barcode scanner	

2. The EUT contains the following accessories.

No.	Product	Brand	Model	Description	Remark
1	Adapter	Sunny COMPUTER TECHNOLOGY CO., LTD.	SYS1561-1105-1	Input: 100-240Vac, 1.0A MAX, 50-60Hz Output: +5.35Vdc/ 2A	Accessory
2	Battery 1	ETI CA Battery inc.	BP13-001080	Rating: 3.7Vdc Capacity, 3450mA Type: Li-ion	Accessory
3	Battery 2		BP14-001160		Accessory
4	Micro USB cable	-	-	1m shielded USB to Micro B cable without core	Accessory
5	Cradle 1	ZEBEX	CRD-40	Input: 5Vdc	Support unit
6	Wireless Power Charger	yardiX	CXT31106	Input: 19Vdc, 0.5A Output: 19Vdc, 0.5A	Support unit
7	Adapter (for Wireless Power Charger)	-	HNC190050U	Input: 100-240Vac, 50/60Hz, 0.35A Max Output: 19.0Vdc, 0.5A 1.55m cable with 1 core attached on adapter	Support unit

* The Battery models are electrically identical, different model names are for marketing purpose. Battery 1 was chosen for final test.

3. The above EUT information is declared by manufacturer and for more detailed features description, please refer to the manufacturer's specifications or user's manual.

3.2 Configuration of System Under Test

Adapter Mode

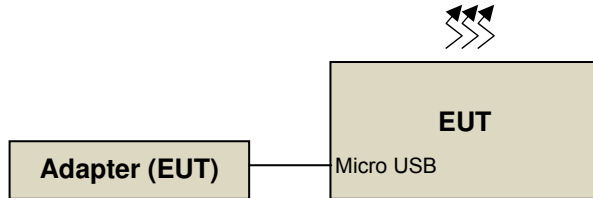

Remote site



Wireless Power Charger Mode

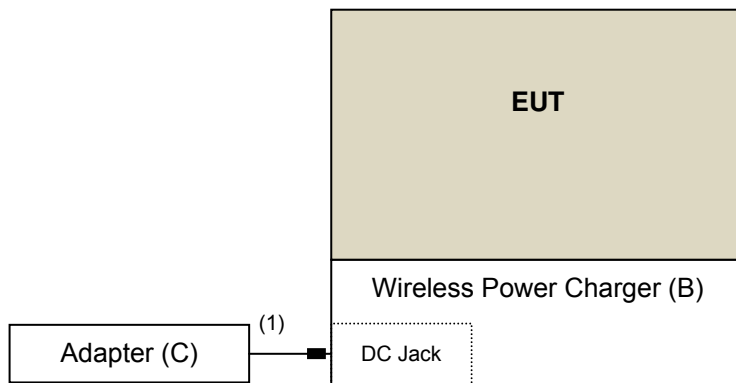

3.2.1 Description Of Support Units

The EUT has been tested as an independent unit together with other necessary accessories or support units. The following support units or accessories were used to form a representative test configuration during the tests.

ID	Product	Brand	Model No.	Serial No.	FCC ID	Remarks
A.	Universal Radio Communication Tester	R&S	CMU200	117260	NA	-
B.	Wireless Power Charger	yardiX	CXT31106	NA	NA	Provided by the manufacturer
C.	Adapter (for Wireless Power Charger)	NA	HNC190050U	NA	NA	Provided by the manufacturer

Note:

1. All power cords of the above support units are non-shielded (1.8m).
2. Item A acted as a communication partner to transfer data.

ID	Descriptions	Qty.	Length (m)	Shielding (Yes/No)	Cores (Qty.)	Remarks
1.	Power cable	1	1.55	-	1	Provided by the manufacturer

3.3 Test Mode Applicability and Tested Channel Detail

Pre-Scan has been conducted to determine the worst-case mode from all possible combinations between available modulations, data rates, XYZ axis and antenna ports

The worst case was found when positioned on Z-plane. Following channel(s) was (were) selected for the final test as listed below:

Test results are presented in the report as below.

Test Mode	Test Condition
A	Power from adapter
B	Power from battery
C	Power from Wireless Power Charger

* After pre-tested adapter, cradle and EUT only modes, we found adapter mode was the worst case, therefore chosen for final tests and presented in the test report.

GSM MODE

EUT Configure Mode	Test Item	Available Channel	Tested Channel	Mode
A	ERP	128 to 251	128, 189, 251	GSM, GPRS, EDGE
B	Frequency Stability	128 to 251	189	GSM
A	Occupied Bandwidth	128 to 251	128, 189, 251	GSM, GPRS, EDGE
A	Band Edge	128 to 251	128, 251	GSM, GPRS, EDGE
A	Peak To Average Ratio	128 to 251	128, 189, 251	GSM, GPRS, EDGE
A	Condcudeted Emission	128 to 251	128, 189, 251	GSM, GPRS, EDGE
A, C	Radiated Emission Below 1GHz	128 to 251	189	GSM
A	Radiated Emission Above 1GHz	128 to 251	128, 189, 251	GSM

WCDMA MODE

EUT Configure Mode	Test Item	Available Channel	Tested Channel	Mode
A	ERP	4132 to 4233	4132, 4182, 4233	WCDMA, HSDPA, HSUPA
B	Frequency Stability	4132 to 4233	4182	WCDMA
A	Occupied Bandwidth	4132 to 4233	4132, 4182, 4233	WCDMA, HSDPA, HSUPA
A	Band Edge	4132 to 4233	4132, 4233	WCDMA, HSDPA, HSUPA
A	Peak To Average Ratio	4132 to 4233	4132, 4182, 4233	WCDMA, HSDPA, HSUPA
A	Condcudeted Emission	4132 to 4233	4132, 4182, 4233	WCDMA, HSDPA, HSUPA
A, C	Radiated Emission Below 1GHz	4132 to 4233	4182	WCDMA
A	Radiated Emission Above 1GHz	4132 to 4233	4132, 4182, 4233	WCDMA

Test Condition:

Test Item	Environmental Conditions	Input Power	Tested By
ERP	24deg. C, 65%RH	120Vac, 60Hz	Tank Wu, Bayu Chen
Frequency Stability	24deg. C, 64%RH	3.7Vdc	Match Tsui
Occupied Bandwidth	24deg. C, 64%RH	120Vac, 60Hz	Match Tsui
Band Edge	24deg. C, 64%RH	120Vac, 60Hz	Match Tsui
Peak To Average Ratio	24deg. C, 64%RH	120Vac, 60Hz	Match Tsui
Condcudeted Emission	24deg. C, 64%RH	120Vac, 60Hz	Match Tsui
Radiated Emission	25deg. C, 65%RH, 24deg. C, 65%RH, 18deg. C, 70%RH	120Vac, 60Hz	Ted Chang, Tank Wu, Nick Hsu, Bayu Chen, Jones Chang

3.4 EUT Operating Conditions

The EUT makes a call to the communication simulator. The communication simulator station system controlled a EUT to export maximum output power under transmission mode and specific channel frequency

3.5 General Description of Applied Standards

The EUT is a RF Product. According to the specifications of the manufacturer, it must comply with the requirements of the following standards:

FCC 47 CFR Part 2

FCC 47 CFR Part 22

KDB 971168 D01 Power Meas License Digital Systems v02r02

ANSI/TIA/EIA-603-C 2004

All test items have been performed and recorded as per the above standards.

NOTE: The EUT has been verified to comply with the requirements of FCC Part 15, Subpart B, Class B (DoC). The test report has been issued separately.

4 Test Types and Results

4.1 Output Power Measurement

4.1.1 Limits of Output Power Measurement

Mobile / Portable station are limited to 7 watts e.r.p.

4.1.2 Test Procedures

EIRP / ERP Measurement:

- a. All measurements were done at low, middle and high operational frequency range. RBW and VBW is 1MHz for GSM, GPRS, EDGE and 5MHz for WCDMA, HSDPA & HSUPA mode.
- b. Substitution method is used for E.I.R.P measurement. In the semi-anechoic chamber, EUT placed on the 0.8m height of Turn Table, rotated the table around 360 degrees to search the maximum radiation power and receiver antenna shall be rotated vertical and horizontal polarization and moved height from 1m to 4m to find the maximum polar radiated power. The "Read Value" is the spectrum reading the maximum power value.
- c. The substitution horn antenna is substituted for EUT at the same position and signals generator export the CW signal to the substitution antenna via a TX cable. Rotated the Turn Table and moved receiving antenna to find the maximum radiation power. Adjust output power level of S.G to get a Value of spectrum reading equal to "Read Value" of step b. Record the power level of S.G
- d. $EIRP = \text{Output power level of S.G} - \text{TX cable loss} + \text{Antenna gain of substitution horn.}$ E.R.P power can be calculated form E.I.R.P power by subtracting the gain of dipole, $E.R.P \text{ power} = E.I.R.P \text{ power} - 2.15\text{dBi.}$

Conducted Power Measurement:

The EUT was set up for the maximum power with GSM, GPRS, EDGE, WCDMA, HSDPA & HSUPA link data modulation and link up with simulator. Set the EUT to transmit under low, middle and high channel and record the power level shown on simulator.

4.1.3 Test Setup
EIRP / ERP MEASUREMENT:

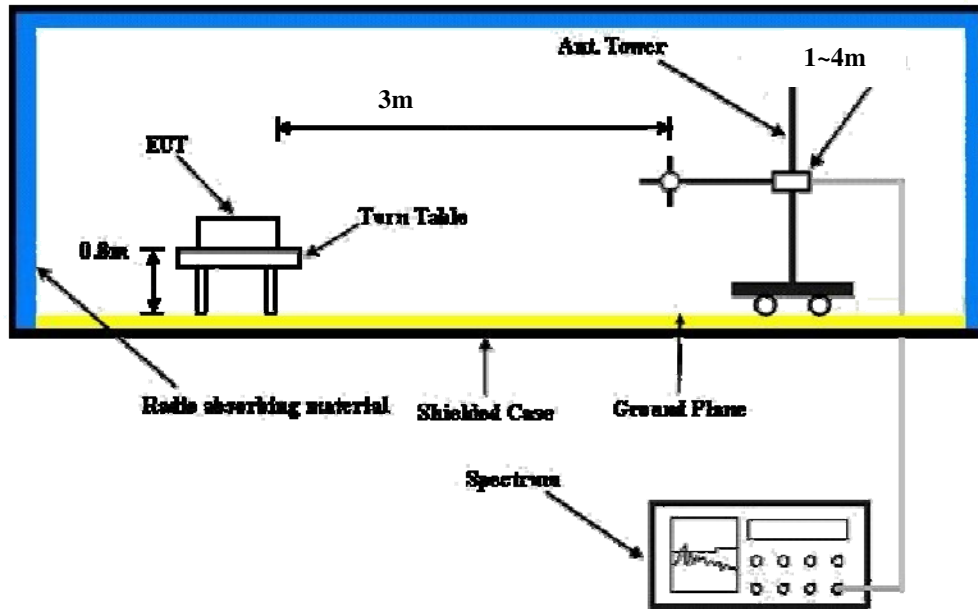

For the actual test configuration, please refer to the attached file (Test Setup Photo).

CONDUCTED POWER MEASUREMENT:

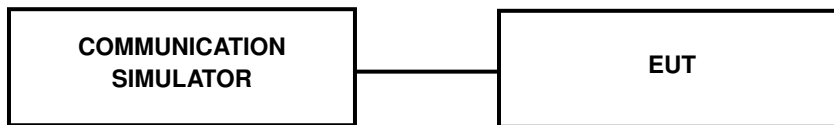

For the actual test configuration, please refer to the attached file (Test Setup Photo).

4.1.4 Test Results
CONDUCTED OUTPUT POWER (dBm)

Band	GSM850		
Channel	128	189	251
Frequency (MHz)	824.2	836.4	848.8
GSM	32.23	31.96	32.10
GPRS 8	32.22	31.95	32.09
GPRS 10	32.12	31.85	31.99
GPRS 11	31.99	31.72	31.86
GPRS 12	31.82	31.55	31.69
GPRS 30	32.07	31.80	31.94
GPRS 31	32.02	31.75	31.89
GPRS 32	31.91	31.64	31.78
GPRS 33	31.78	31.51	31.65
DTM 9 (GPRS)	31.87	31.60	31.74
DTM 11 (GPRS)	31.71	31.44	31.58
EDGE 8 (MCS9)	25.92	25.65	25.79
EDGE 10 (MCS9)	25.86	25.59	25.73
EDGE 11 (MCS9)	25.76	25.49	25.63
EDGE 12 (MCS9)	25.69	25.42	25.56
EDGE 30 (MCS9)	25.87	25.60	25.74
EDGE 31 (MCS9)	25.83	25.56	25.70
EDGE 32 (MCS9)	25.79	25.52	25.66
EDGE 33 (MCS9)	25.69	25.42	25.56
DTM 9 (EDGE)	31.76	31.49	31.63
DTM 11 (EDGE)	31.70	31.43	31.57

Band	WCDMA V		
Channel	4132	4182	4233
Frequency (MHz)	826.4	836.4	846.6
RMC 12.2K	23.24	23.09	23.13
HSDPA Subtest-1	23.21	23.06	23.10
HSDPA Subtest-2	23.22	23.07	23.11
HSDPA Subtest-3	22.72	22.57	22.61
HSDPA Subtest-4	22.75	22.60	22.64
HSUPA Subtest-1	22.76	22.61	22.65
HSUPA Subtest-2	21.08	20.93	20.97
HSUPA Subtest-3	21.85	21.70	21.74
HSUPA Subtest-4	21.71	21.55	21.41
HSUPA Subtest-5	23.20	23.05	23.09



ERP Power (dBm)

For GSM Mode:

MODE		TX channel 128					
Antenna Polarity & Test Distance: Horizontal at 3 M							
No.	Freq. (MHz)	Reading (dBm)	S.G Power Value (dBm)	Correction Factor (dB)	ERP (dBm)	Limit (dBm)	Margin (dB)

1



For GPRS Mode:

MODE		TX channel 128					
Antenna Polarity & Test Distance: Horizontal at 3 M							
No.	Freq. (MHz)	Reading (dBm)	S.G Power Value (dBm)	Correction Factor (dB)	ERP (dBm)	Limit (dBm)	Margin (dB)

1



For EDGE Mode:

MODE		TX channel 128					
Antenna Polarity & Test Distance: Horizontal at 3 M							
No.	Freq. (MHz)	Reading (dBm)	S.G Power Value (dBm)	Correction Factor (dB)	ERP (dBm)	Limit (dBm)	Margin (dB)

1



For WCDMA Mode:

MODE		TX channel 4132					
Antenna Polarity & Test Distance: Horizontal at 3 M							
No.	Freq. (MHz)	Reading (dBm)	S.G Power Value (dBm)	Correction Factor (dB)	ERP (dBm)	Limit (dBm)	Margin (dB)

1



For HSDPA Mode:

MODE		TX channel 4132					
Antenna Polarity & Test Distance: Horizontal at 3 M							
No.	Freq. (MHz)	Reading (dBm)	S.G Power Value (dBm)	Correction Factor (dB)	ERP (dBm)	Limit (dBm)	Margin (dB)

1



For HSUPA Mode:

MODE		TX channel 4132					
Antenna Polarity & Test Distance: Horizontal at 3 M							
No.	Freq. (MHz)	Reading (dBm)	S.G Power Value (dBm)	Correction Factor (dB)	ERP (dBm)	Limit (dBm)	Margin (dB)

1

4.2 Frequency Stability Measurement

4.2.1 Limits of Frequency Stability Measurement

1.5 ppm is for base and fixed station. 2.5 ppm is for mobile station.

4.2.2 Test Procedure

- a. Device is placed at the oven room. The oven room could control the temperatures and humidity. Power warm up is at least 15 min and power applied should perform before recording frequency error.
- b. EUT is connected the external power supply to control the DC input power. The test voltage range is from minimum to maximum working voltage. Each step shall be record the frequency error rate.
- c. The temperature range step is 10 degrees in this test items. All temperature levels shall be hold the

4.2.4 Test Results

Frequency Error vs. Voltage

Voltage (Volts)	Frequency Error (ppm)		Limit (ppm)
	GSM	WCDMA	
4.15	-0.023	-0.023	2.5
3.7	-0.019	-0.017	2.5
3.67	-0.020	-0.019	2.5

NOTE: The applicant defined the normal working voltage of the battery is from 3.7Vdc to 4.15Vdc.

Frequency Error vs. Temperature.

TEMP. (

4.3 Occupied Bandwidth Measurement

4.3.1 Test Procedure

The EUT makes a call to the communication simulator. All measurements were done at low, middle and high operational frequency range. The communication simulator station system controlled a EUT to export maximum output power under transmission mode and specific channel frequency. Use OBW measurement function of Spectrum analyzer to measure 99 % occupied bandwidth.

4.3.2 Test Setup

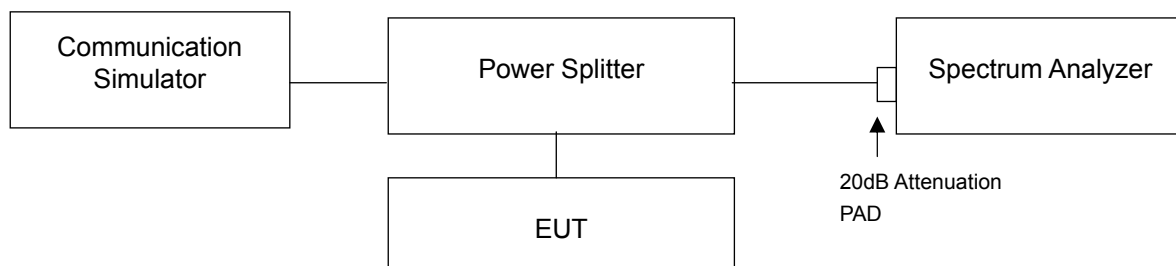

4.3.3 Test Result

Channel	Frequency (MHz)	99% Occupied Bandwidth (kHz)			Channel	Frequency (MHz)	99% Occupied Bandwidth (MHz)		
		GSM	GPRS	EDGE			WCDMA	HSDPA	HSUPA
128	824.20	255.0	255.0	260.0	4132	826.4	4.15	4.13	4.13
189	836.40	250.0	250.0	255.0	4182	836.4	4.17	4.15	4.17
251	848.80	250.0	250.0	260.0	4233	846.6	4.17	4.18	4.17

Spectrum Plot Of Worst Value

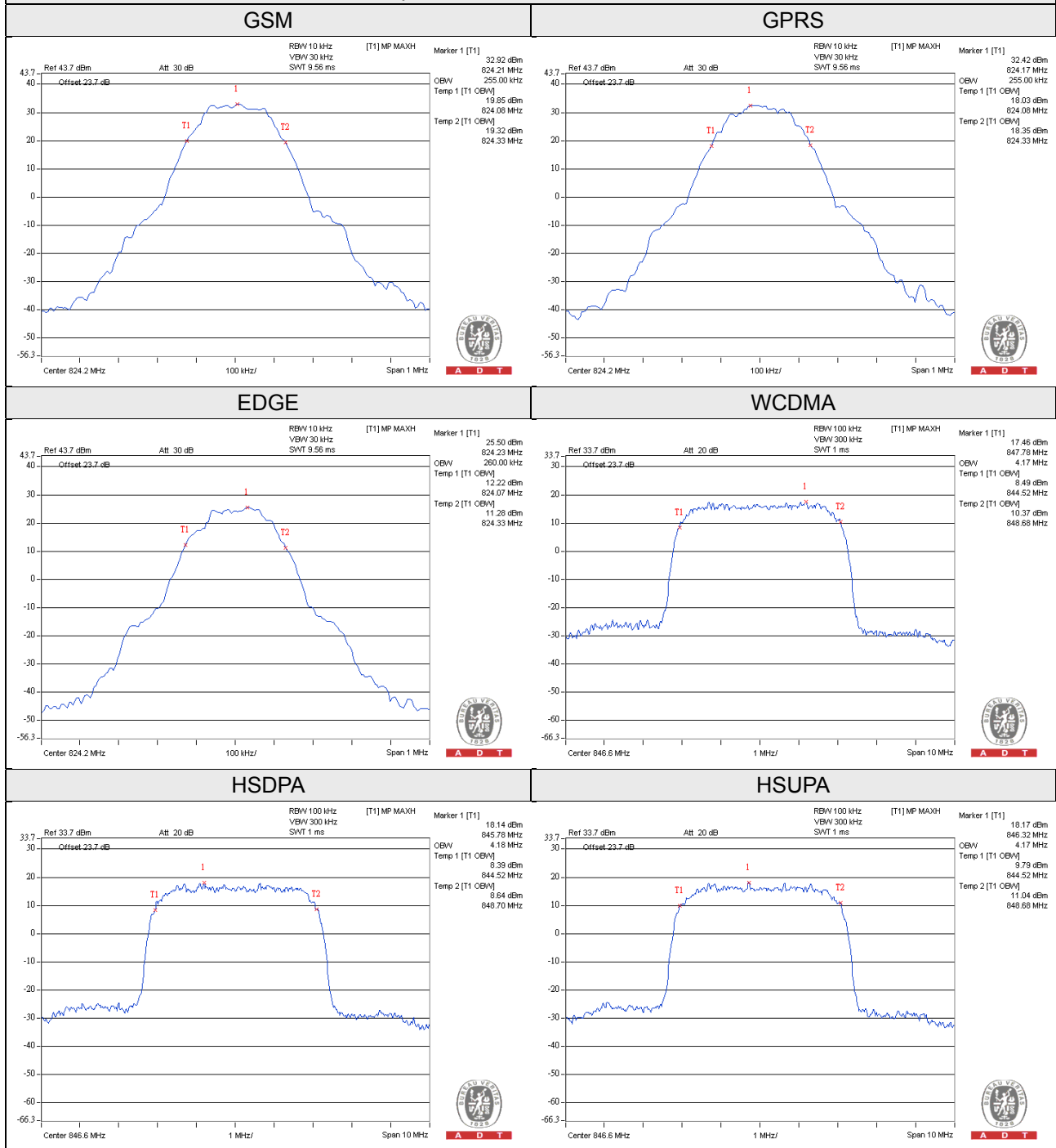

4.4 Band Edge Measurement

4.4.1 Limits of Band Edge Measurement

Power of any emission outside of the authorized operating frequency ranges must be attenuated below the transmitting power (P) by a factor of at least $43 + 10 \log(P)$ dB. In the 1 MHz bands immediately outside and adjacent to the frequency block a resolution bandwidth of at least one percent of the emission bandwidth of the fundamental emission of the transmitter may be employed.

4.4.2 Test Setup

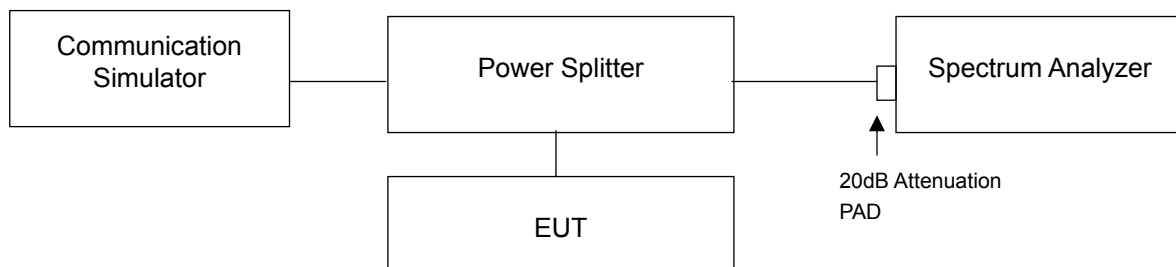

4.4.3 Test Procedures

- All measurements were done at low and high operational frequency range.
- The center frequency of spectrum is the band edge frequency and span is 1.5MHz. RB of the spectrum is 3kHz and VB of the spectrum is 10kHz (GSM/GPRS/EDGE).
- The center frequency of spectrum is the band edge frequency and span is 10MHz. RB of the spectrum is 100kHz and VB of the spectrum is 300kHz (WCDMA/ HSDPA/ HSUPA).
- Record the max trace plot into the test report.

4.4.4 Test Results

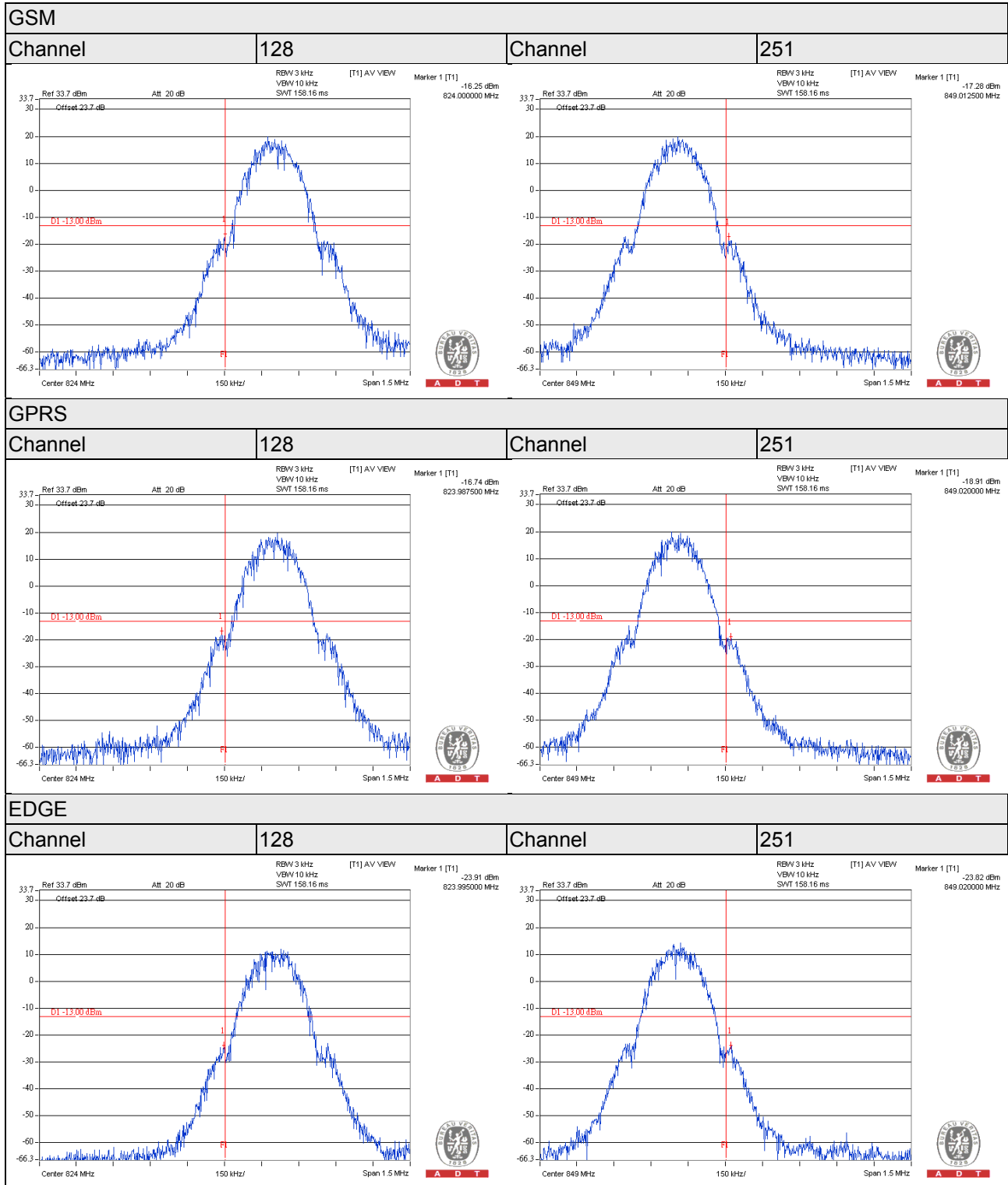

WCDMA

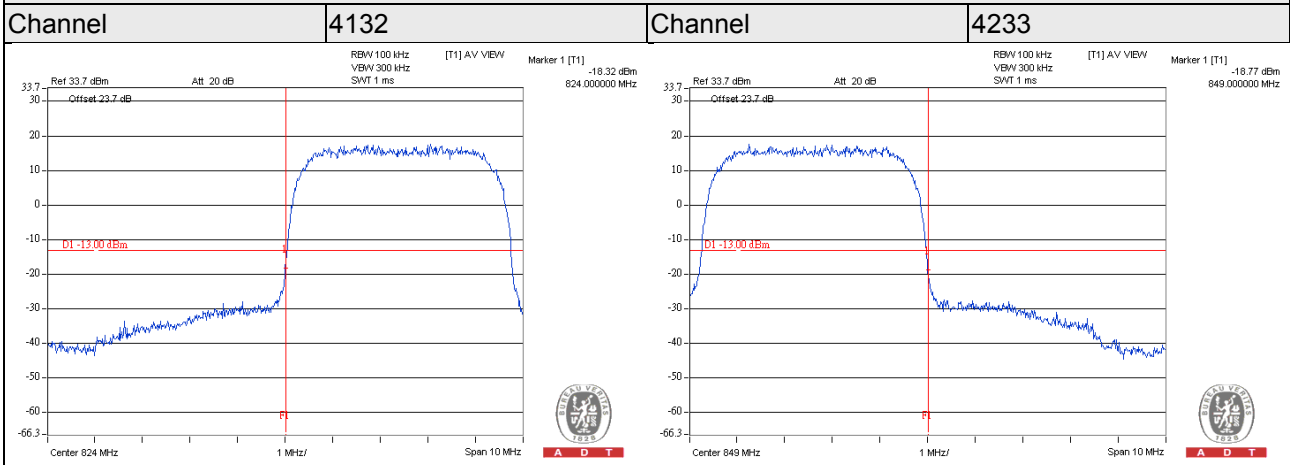

HSDPA

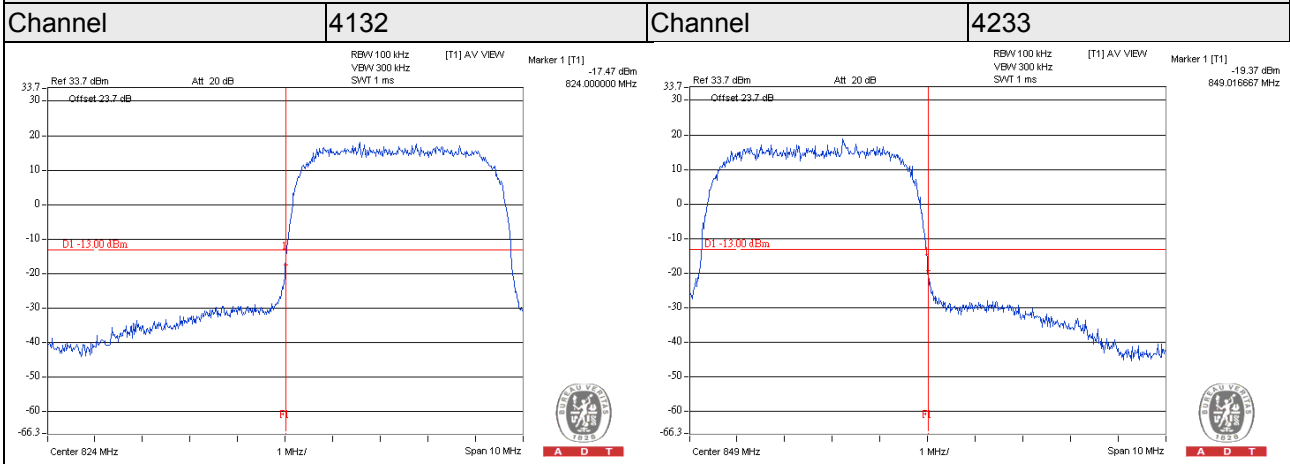

HSUPA

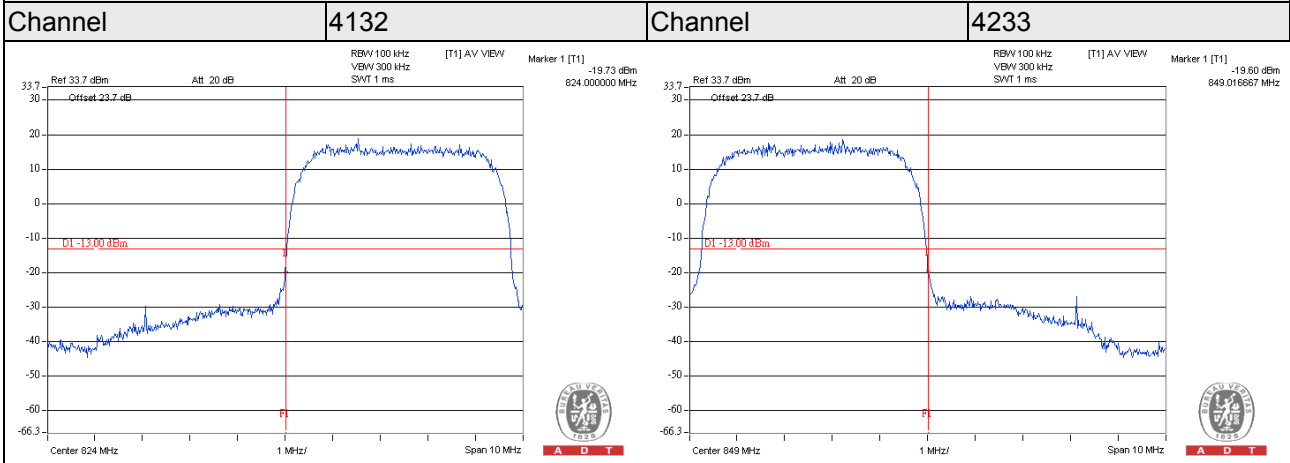

4.5 Peak To Average Ratio

4.5.1 Limits of Peak To Average Ratio Measurement

In measuring transmissions in this band using an average power technique, the peak to-average ratio (PAR) of the transmission may not exceed 13 dB

4.5.2 Test Setup

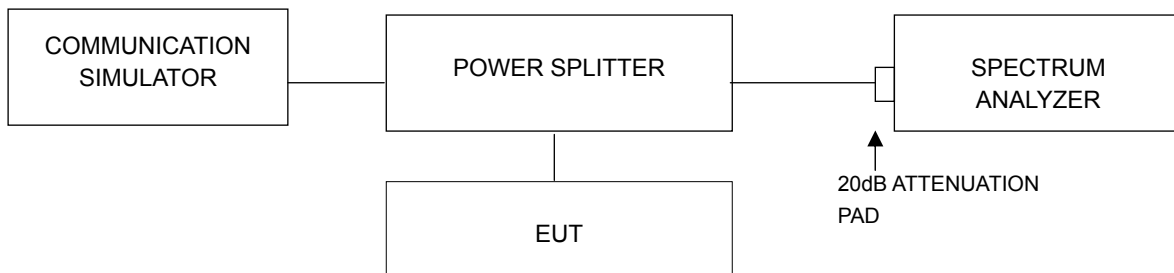

4.5.3 Test Procedures

1. Set resolution/measurement bandwidth \geq signal's occupied bandwidth;
2. Set the number of counts to a value that stabilizes the measured CCDF curve;
3. Record the maximum PAPR level associated with a probability of 0.1%.

4.5.4 Test Results

Channel	Frequency (MHz)	Peak To Average Ratio (dB)			Channel	Frequency (MHz)	Peak To Average Ratio (dB)		
		GSM	GPRS	EDGE			WCDMA	HSDPA	HSUPA
128	824.20	4.56	4.21	3.49	4132	826.4	3.23	3.23	3.22
189	836.40	3.87	4.68	3.37	4182	836.4	3.26	3.24	3.24
251	848.80	4.67	3.10	2.39	4233	846.6	3.25	3.24	3.23

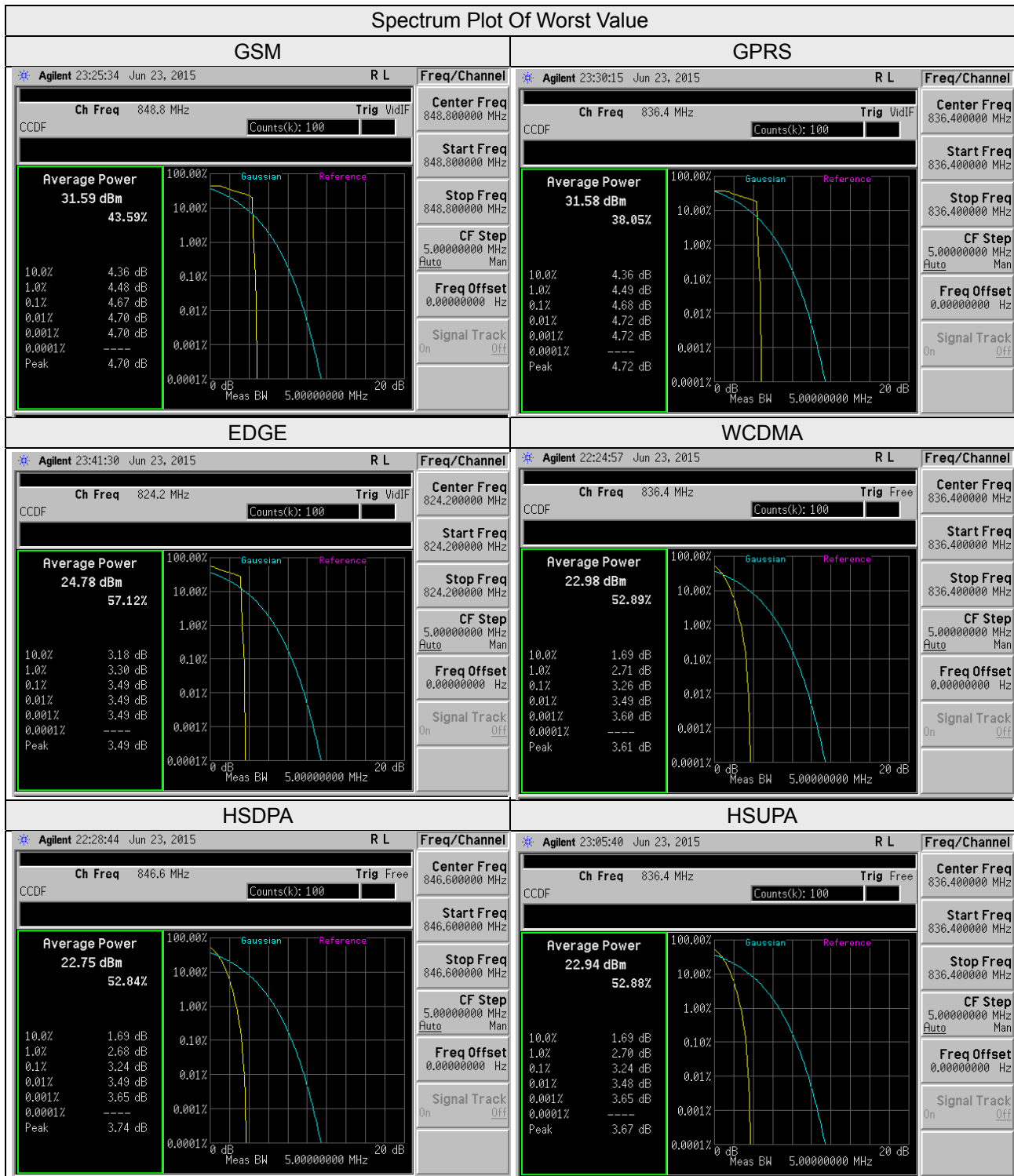

4.6 Conducted Spurious Emissions

4.6.1 Limits of Conducted Spurious Emissions Measurement

The power of any emission outside of the authorized operating frequency ranges must be attenuated below the transmitting power (P) by a factor of at least $43 + 10 \log(P)$ dB. The emission limit equal to -13dBm .

4.6.2 Test Setup

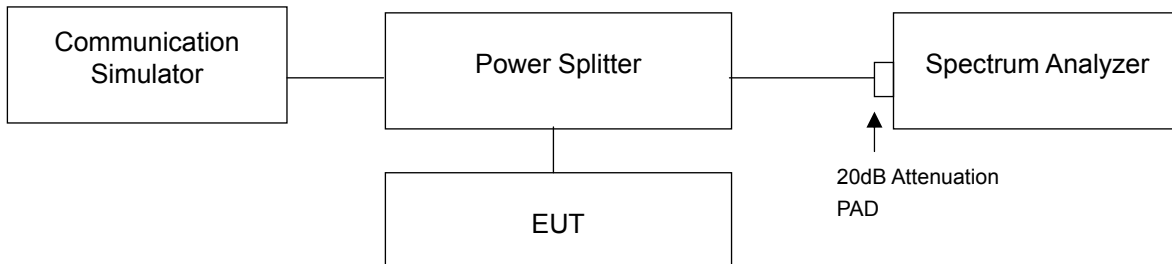

4.6.3 Test Procedure

- a. The EUT makes a phone call to the communication simulator. All measurements were done at low, middle and high operational frequency range.
- b. Measuring frequency range is from 9 kHz to 9GHz. 20dB attenuation pad is connected with spectrum. RBW=1MHz and VBW=3MHz is used for conducted emission measurement.

4.6.4 Test Results

GSM

Channel 128

Frequency Range : 9kHz~1GHz

Frequency Range : 1GHz~4GHz

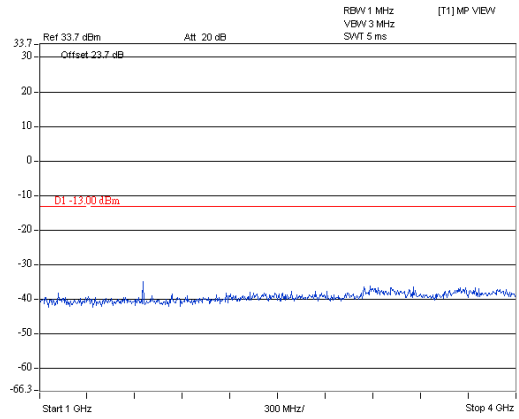
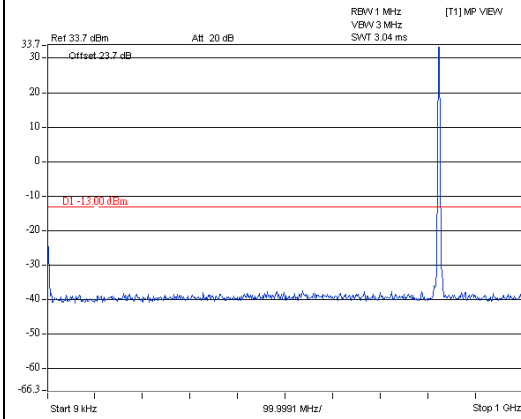

Frequency Range : 4GHz~7GHz

Frequency Range : 7GHz~9GHz

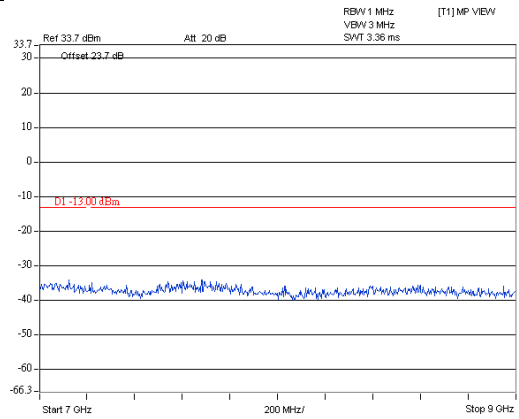
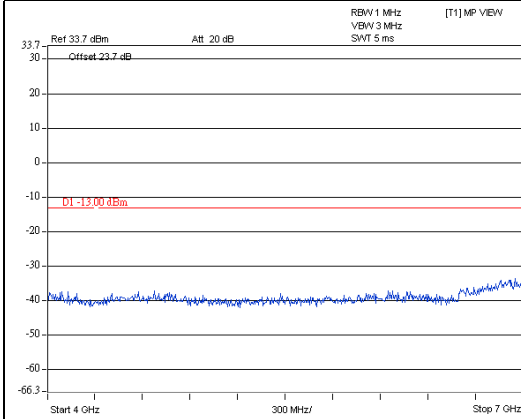

GSM

Channel 189

Frequency Range : 9kHz~1GHz

Frequency Range : 1GHz~4GHz

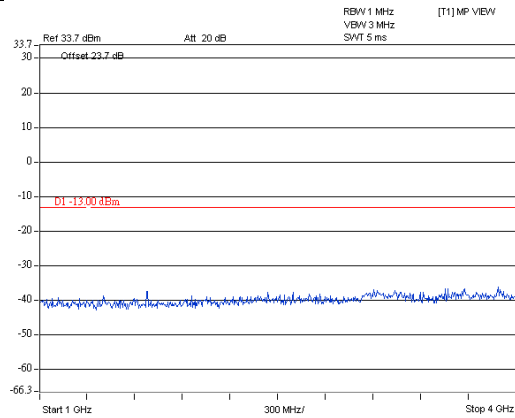
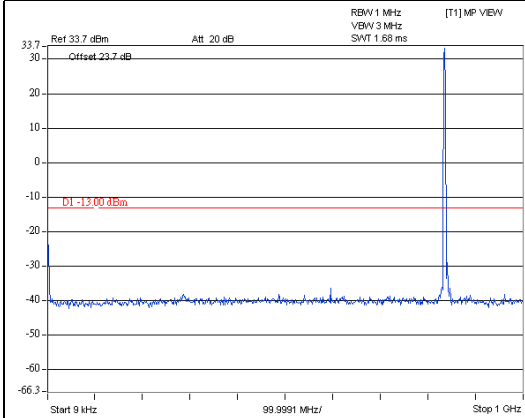

Frequency Range : 4GHz~7GHz

Frequency Range : 7GHz~9GHz

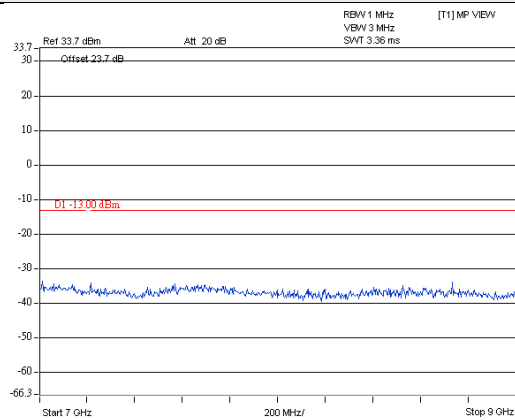
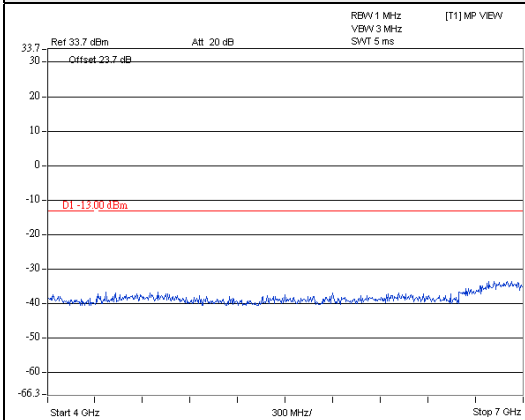

GSM

Channel 251

Frequency Range : 9kHz~1GHz

Frequency Range : 1GHz~4GHz

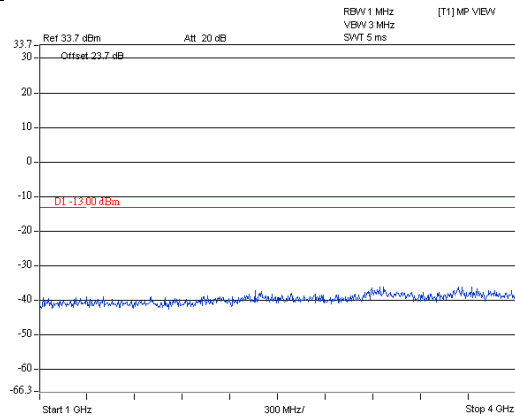
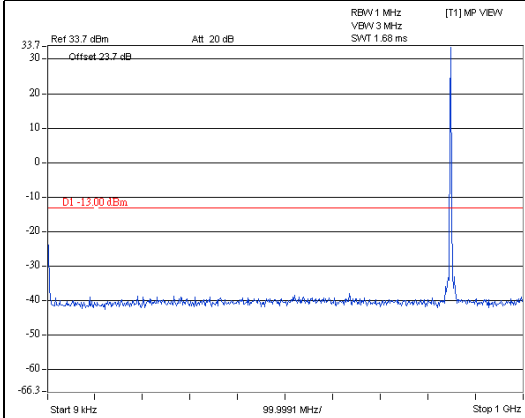

Frequency Range : 4GHz~7GHz

Frequency Range : 7GHz~9GHz

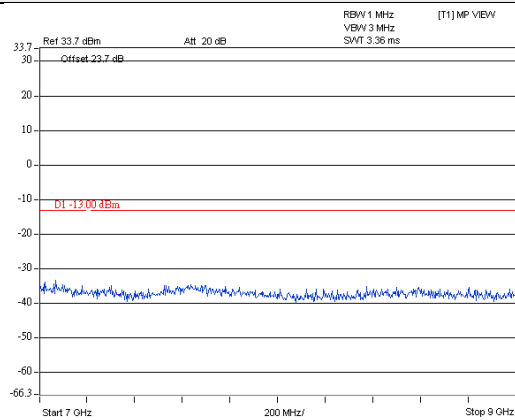
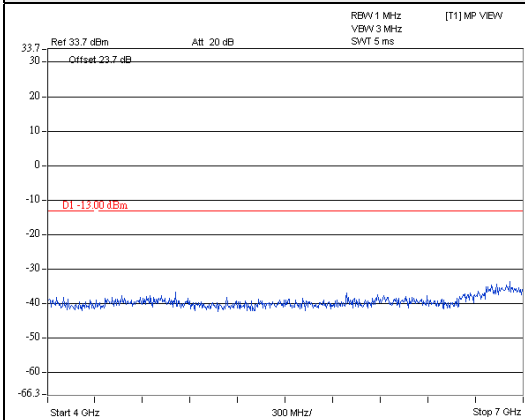

GPRS

Channel 128

Frequency Range : 9kHz~1GHz

Frequency Range : 1GHz~4GHz

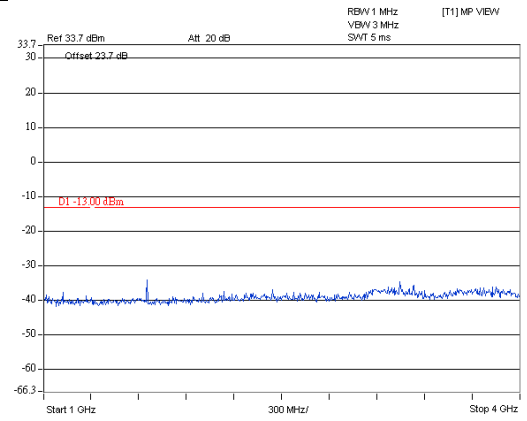
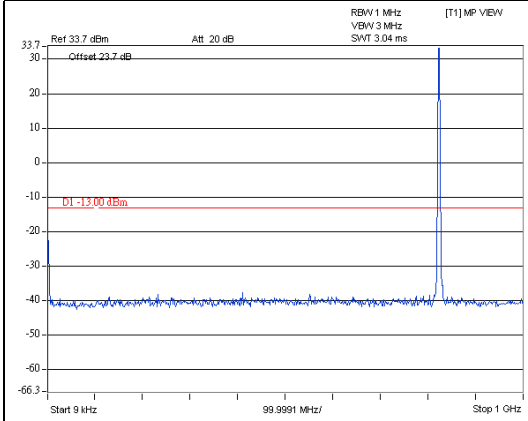

Frequency Range : 4GHz~7GHz

Frequency Range : 7GHz~9GHz

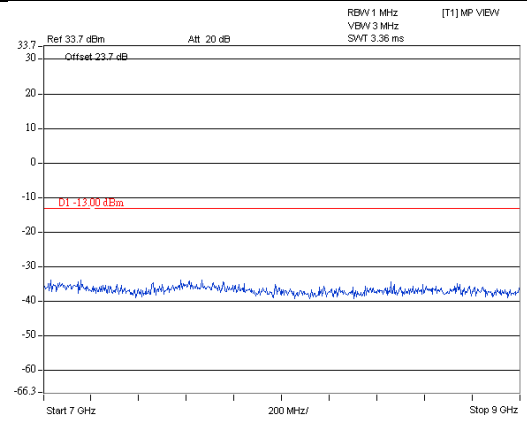
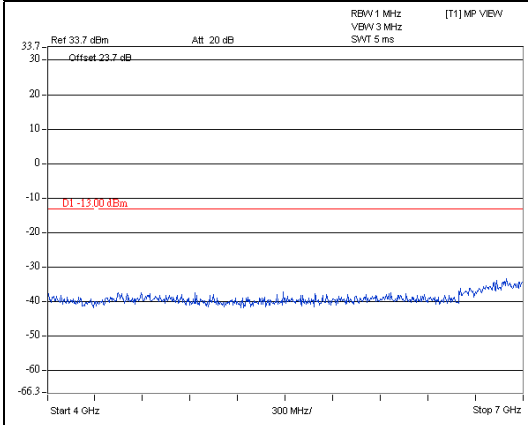

GPRS

Channel 189

Frequency Range : 9kHz~1GHz

Frequency Range : 1GHz~4GHz

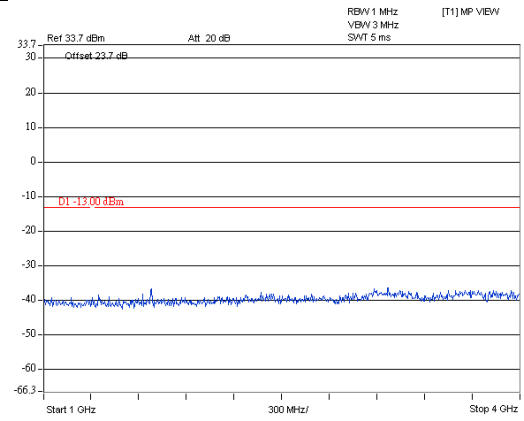
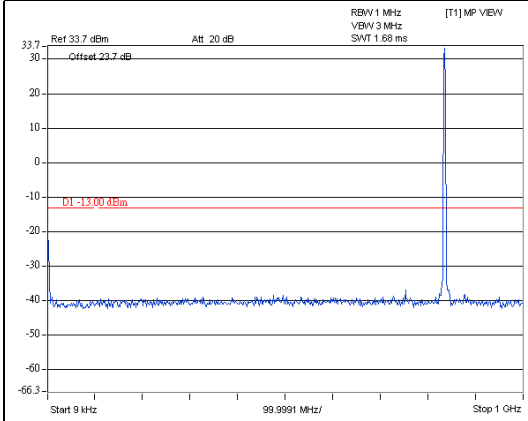

Frequency Range : 4GHz~7GHz

Frequency Range : 7GHz~9GHz

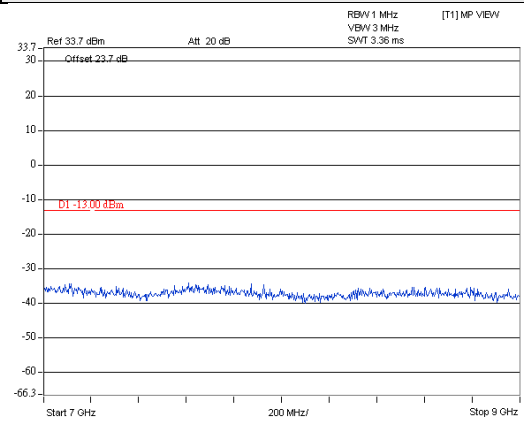
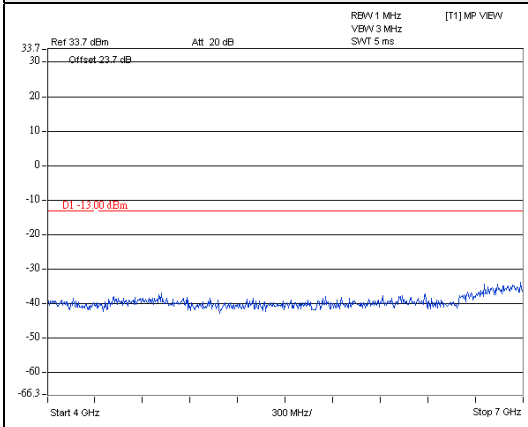

GPRS

Channel 251

Frequency Range : 9kHz~1GHz

Frequency Range : 1GHz~4GHz

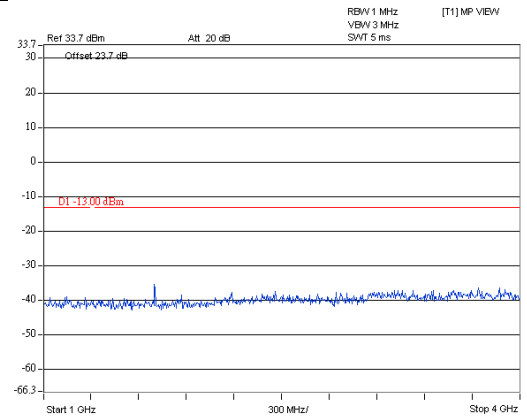
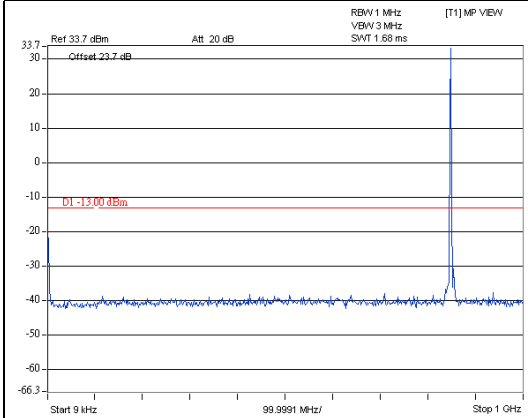

Frequency Range : 4GHz~7GHz

Frequency Range : 7GHz~9GHz

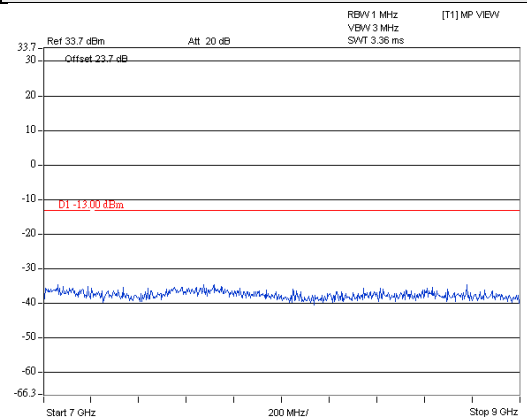
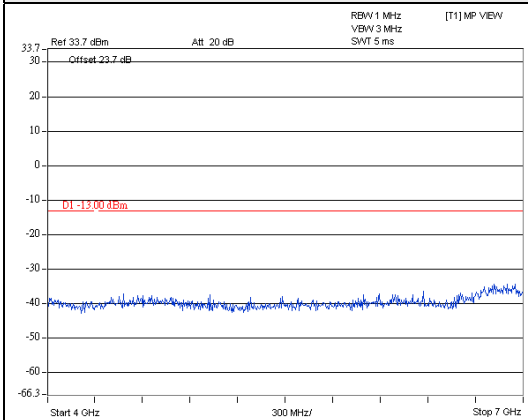

EDGE**Channel 128**

Frequency Range : 9kHz~1GHz

Frequency Range : 1GHz~4GHz

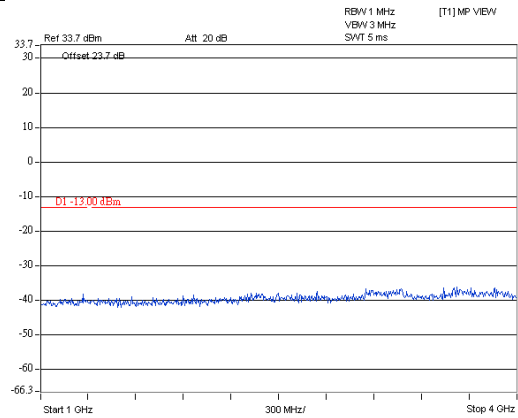
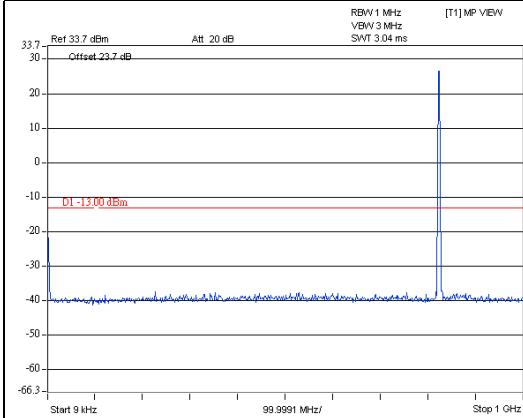

Frequency Range : 4GHz~7GHz

Frequency Range : 7GHz~9GHz

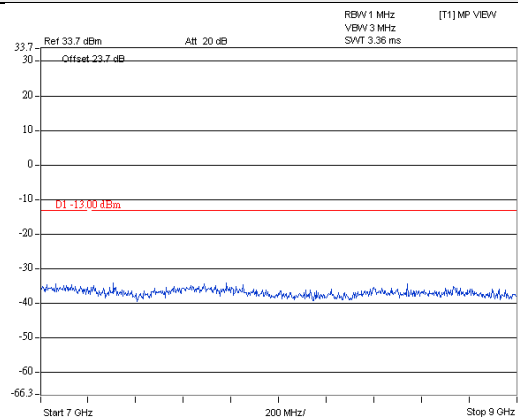
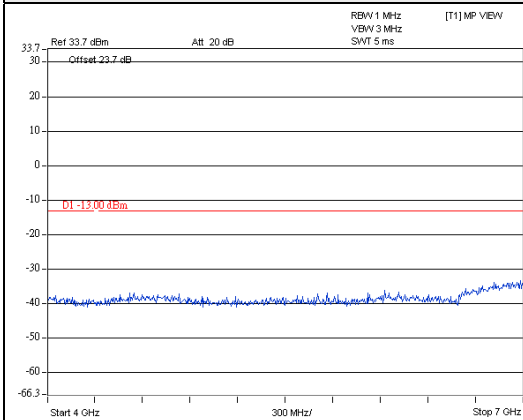

EDGE

Channel 189

Frequency Range : 9kHz~1GHz

Frequency Range : 1GHz~4GHz

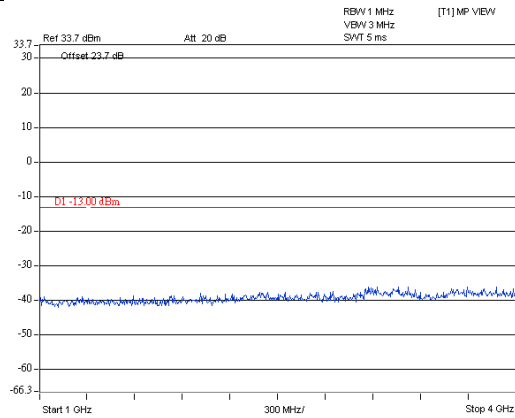
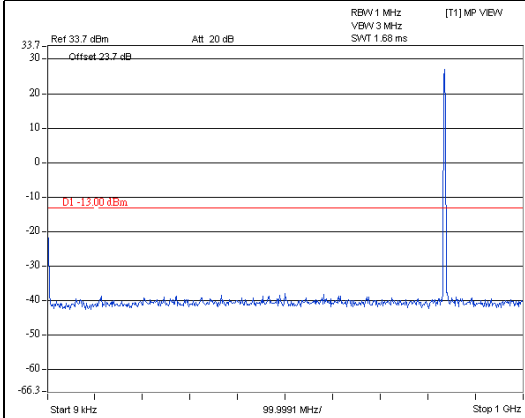

Frequency Range : 4GHz~7GHz

Frequency Range : 7GHz~9GHz

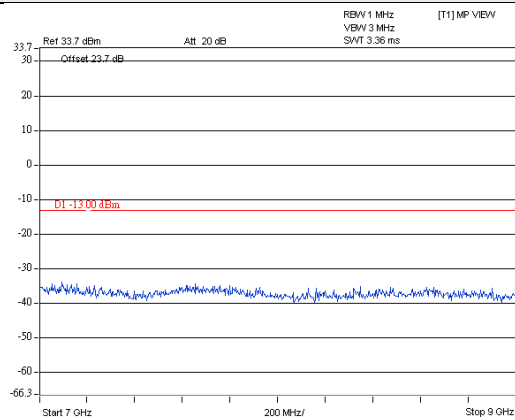
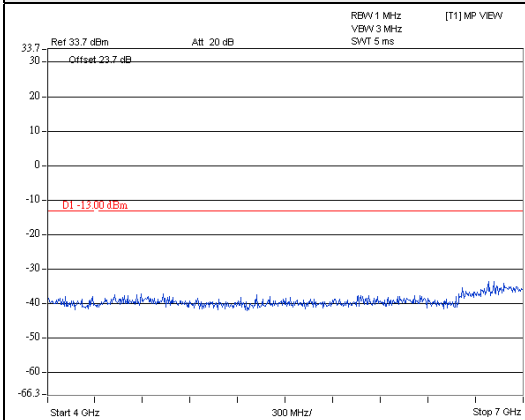

EDGE

Channel 251

Frequency Range : 9kHz~1GHz

Frequency Range : 1GHz~4GHz

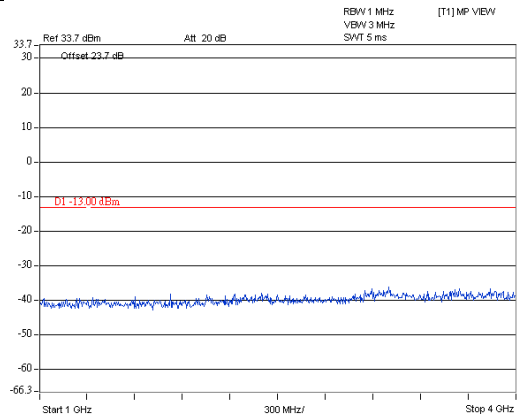
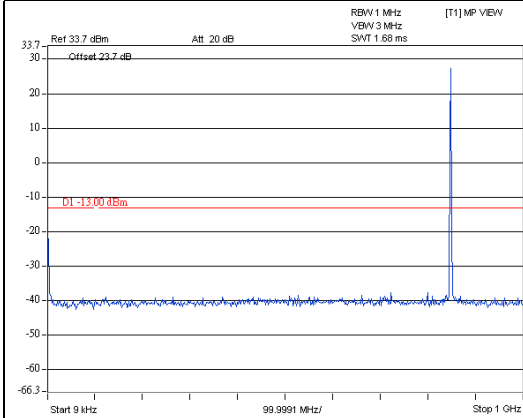

Frequency Range : 4GHz~7GHz

Frequency Range : 7GHz~9GHz

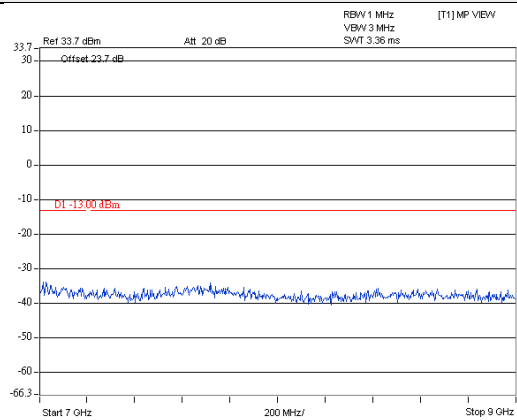
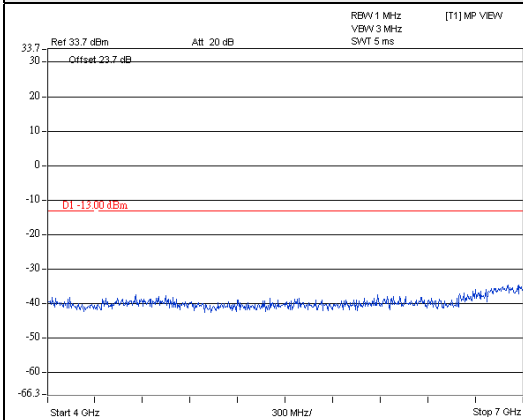

WCDMA

Channel 4132

Frequency Range : 9kHz~1GHz

Frequency Range : 1GHz~4GHz

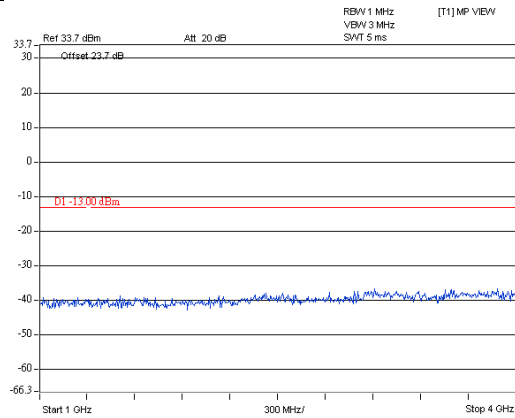
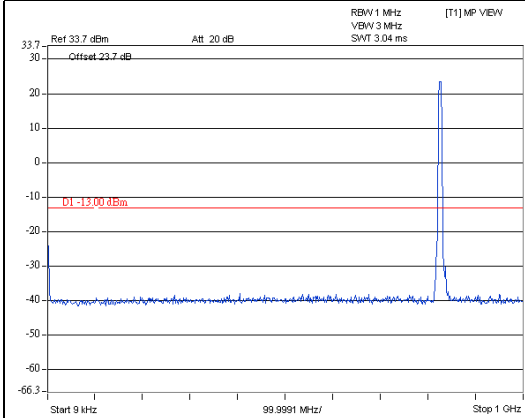

Frequency Range : 4GHz~7GHz

Frequency Range : 7GHz~9GHz

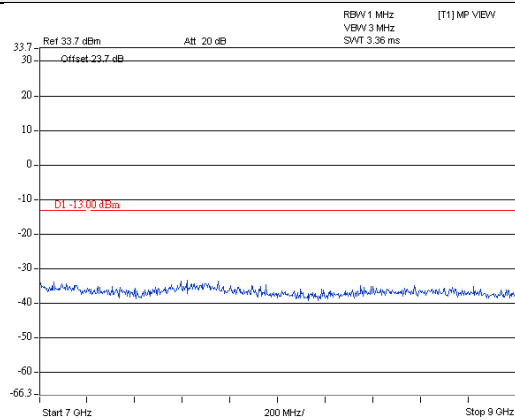
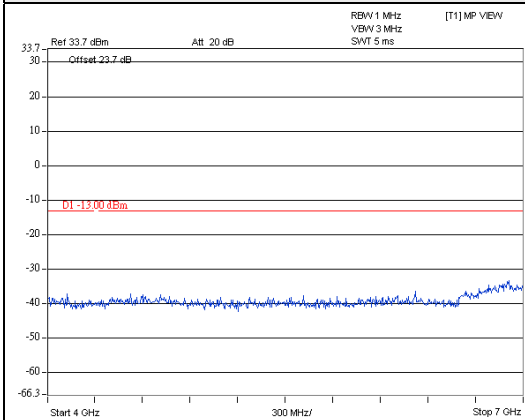

WCDMA

Channel 4182

Frequency Range : 9kHz~1GHz

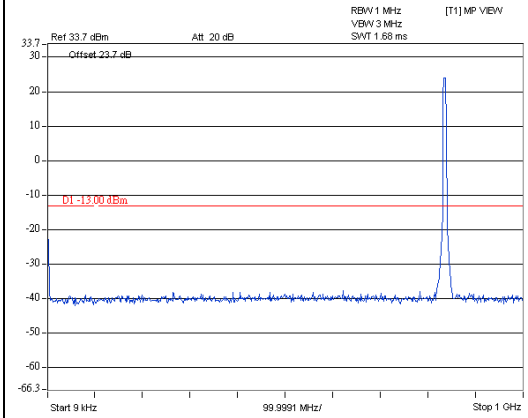

Frequency Range : 1GHz~4GHz

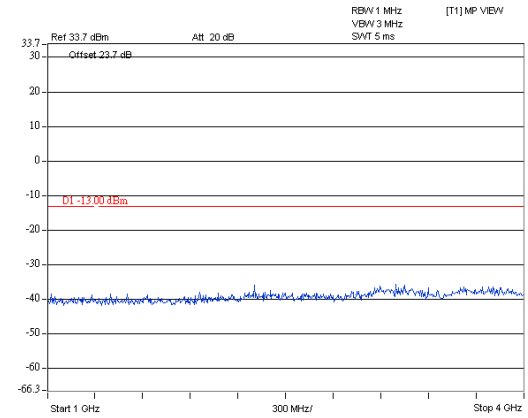

Frequency Range : 4GHz~7GHz

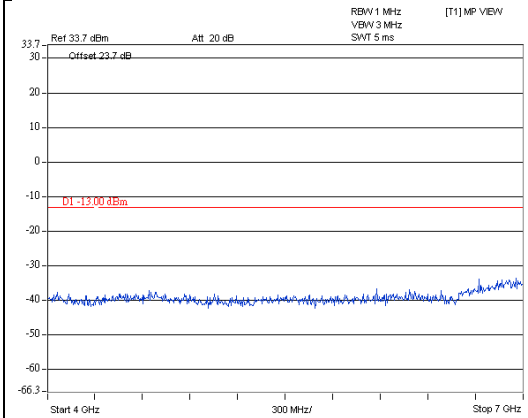

Frequency Range : 7GHz~9GHz

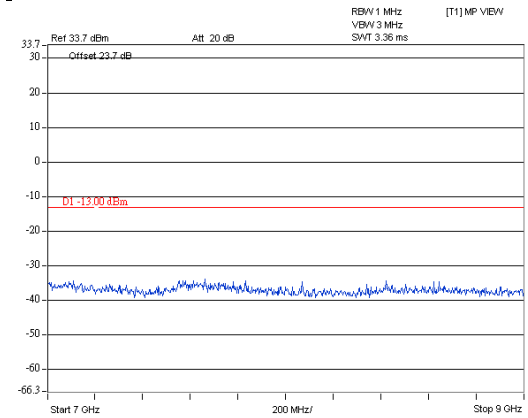

WCDMA

Channel 4233

Frequency Range : 9kHz~1GHz

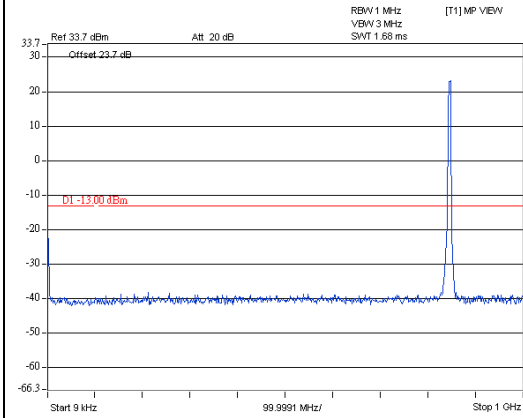

Frequency Range : 1GHz~4GHz

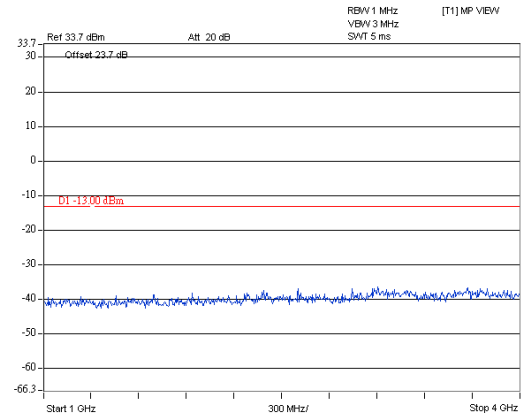

Frequency Range : 4GHz~7GHz

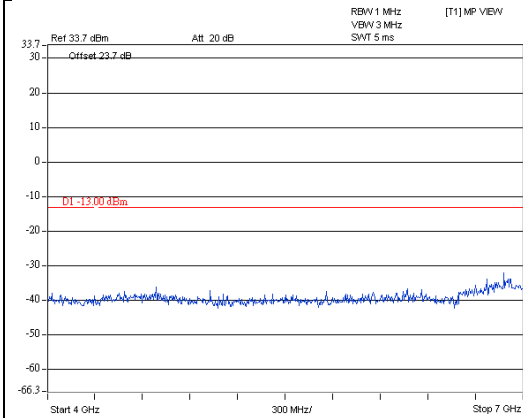

Frequency Range : 7GHz~9GHz

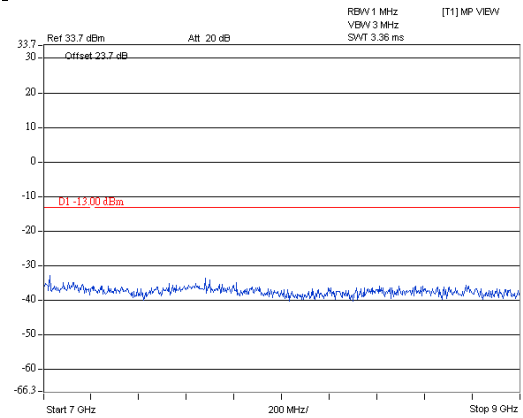

HSDPA

Channel 4132

Frequency Range : 9kHz~1GHz

Frequency Range : 1GHz~4GHz

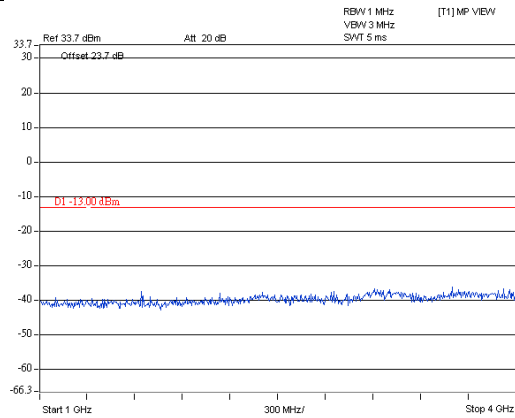
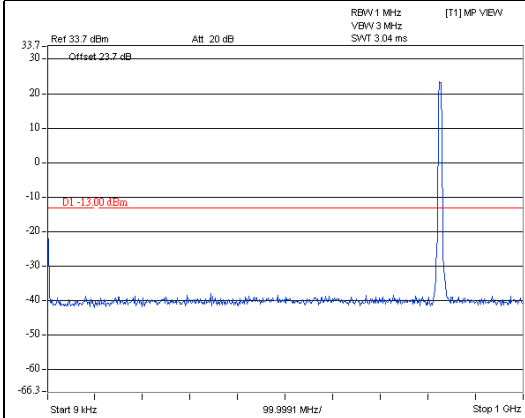

Frequency Range : 4GHz~7GHz

Frequency Range : 7GHz~9GHz

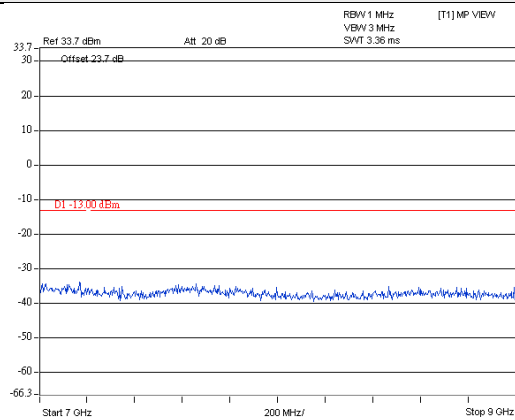
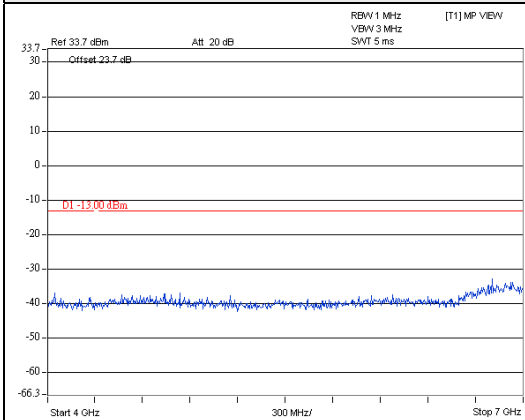

HSDPA

Channel 4182

Frequency Range : 9kHz~1GHz

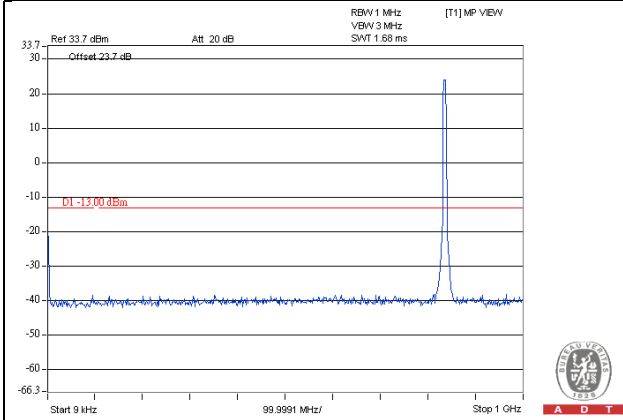

Frequency Range : 1GHz~4GHz

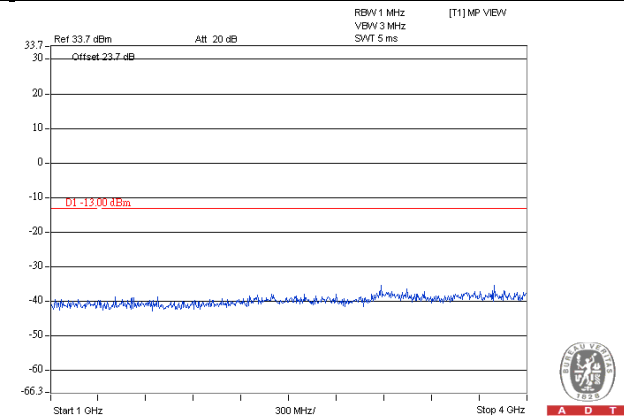

Frequency Range : 4GHz~7GHz

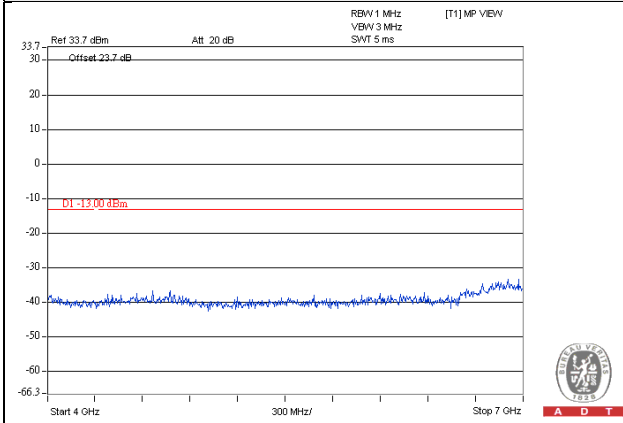

Frequency Range : 7GHz~9GHz

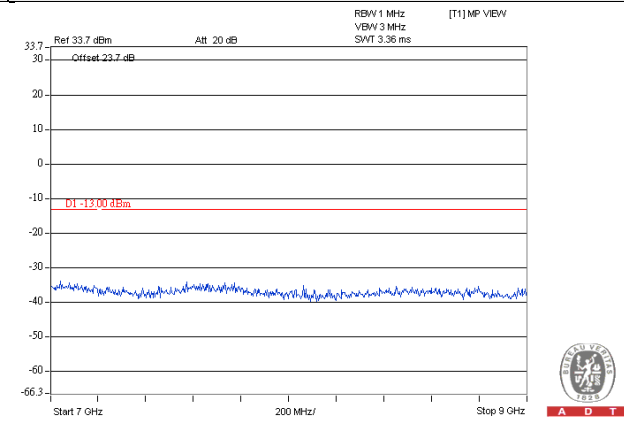

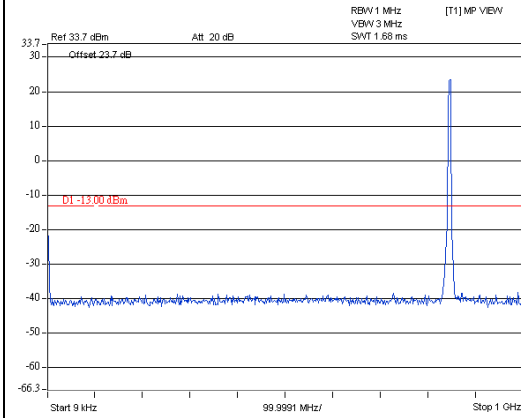
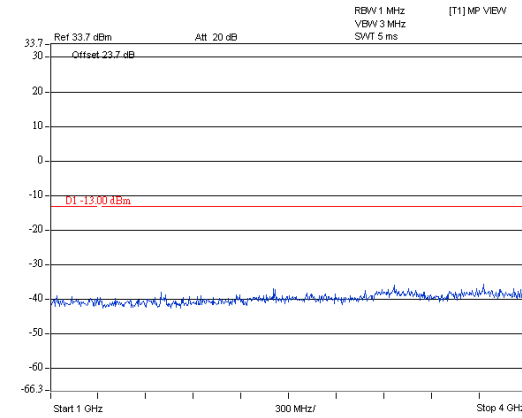
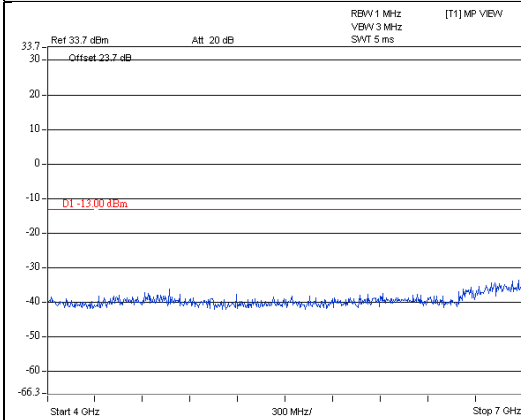
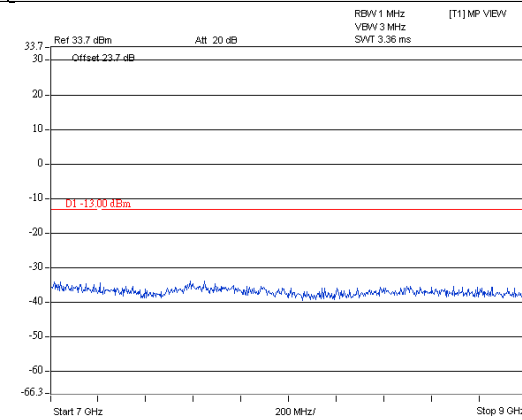
HSDPA**Channel 4233****Frequency Range : 9kHz~1GHz****Frequency Range : 1GHz~4GHz****Frequency Range : 4GHz~7GHz****Frequency Range : 7GHz~9GHz**

HSUPA

Channel 4132

Frequency Range : 9kHz~1GHz

Frequency Range : 1GHz~4GHz

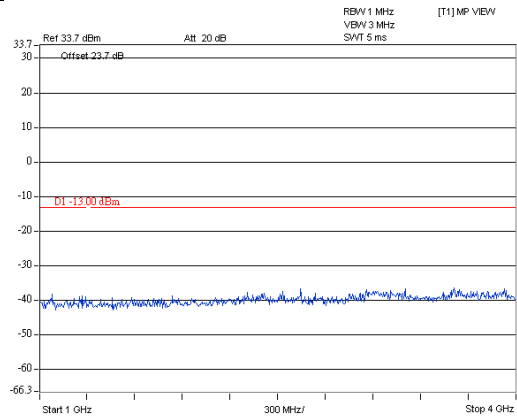
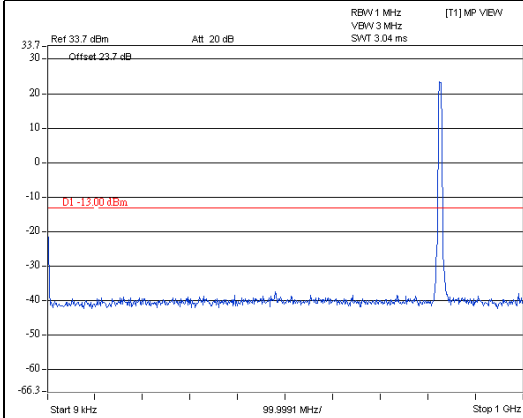

Frequency Range : 4GHz~7GHz

Frequency Range : 7GHz~9GHz

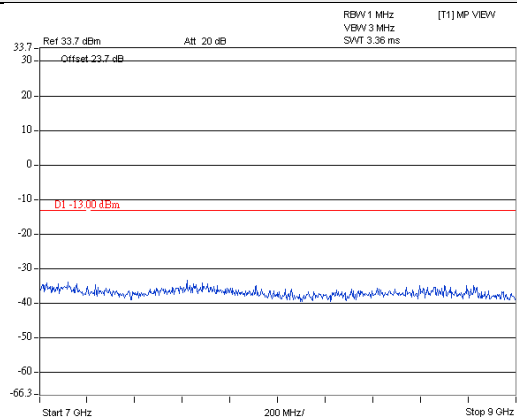
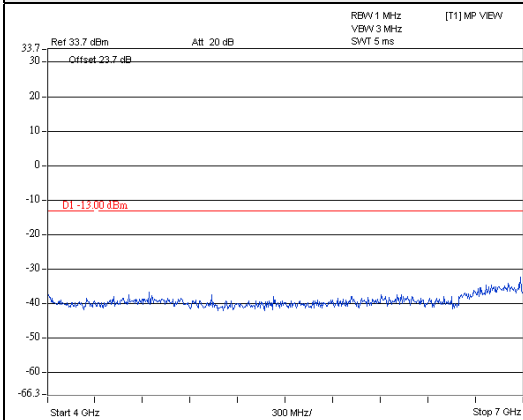

HSUPA

Channel 4182

Frequency Range : 9kHz~1GHz

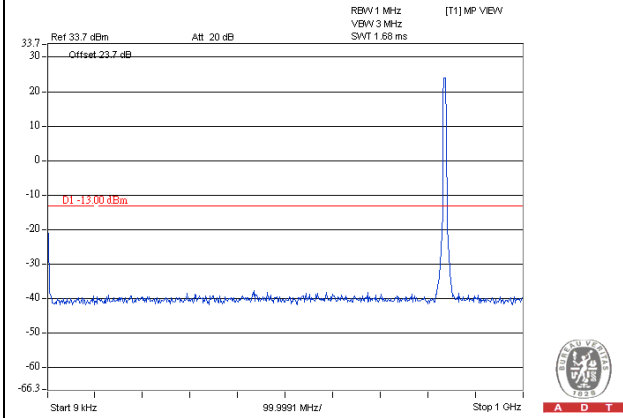

Frequency Range : 1GHz~4GHz

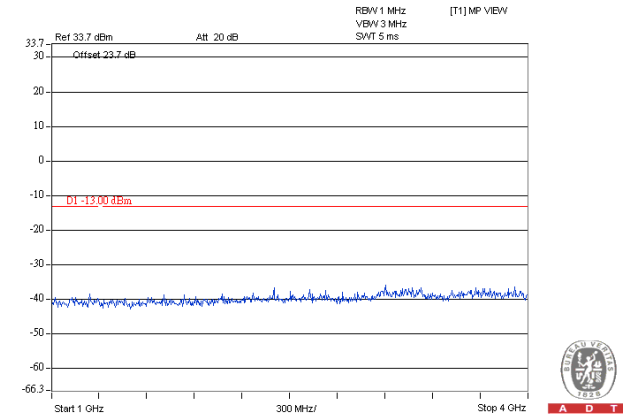

Frequency Range : 4GHz~7GHz

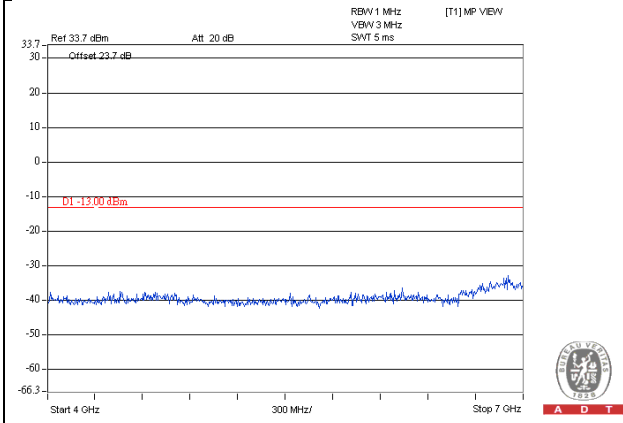

Frequency Range : 7GHz~9GHz

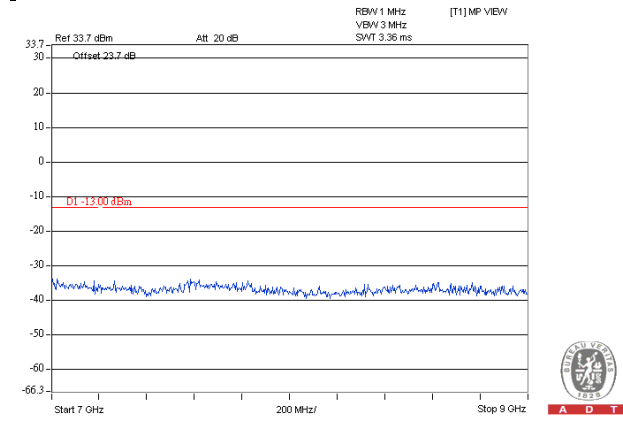

HSUPA

Channel 4233

Frequency Range : 9kHz~1GHz

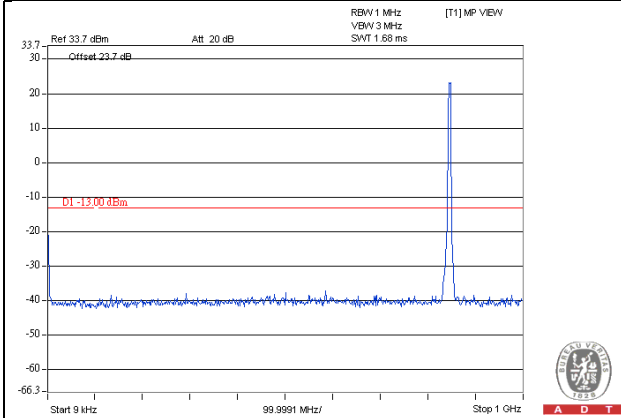

Frequency Range : 1GHz~4GHz

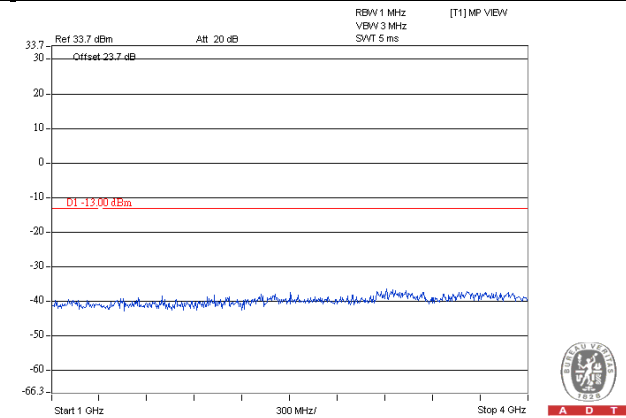

Frequency Range : 4GHz~7GHz

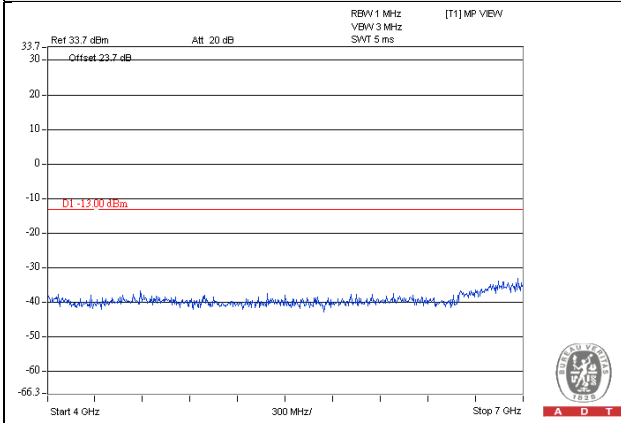

Frequency Range : 7GHz~9GHz

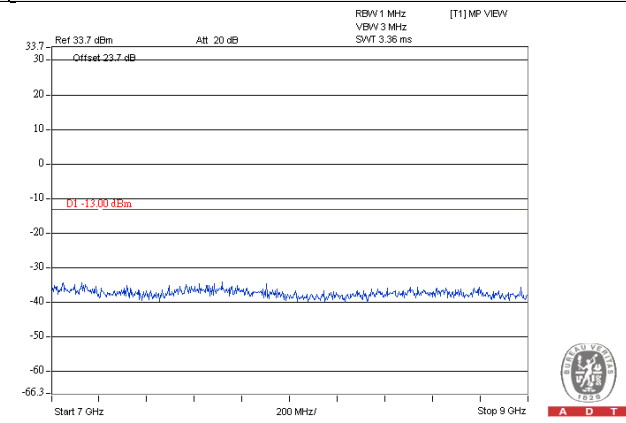

4.7 Radiated Emission Measurement

4.7.1 Limits of Radiated Emission Measurement

The power of any emission outside of the authorized operating frequency ranges must be attenuated below the transmitting power (P) by a factor of at least $43 + 10 \log(P)$ dB. The emission limit equal to -13dBm .

4.7.2 Test Procedure

- a. Substitution method is used for E.I.R.P measurement. In the semi-anechoic chamber, EUT placed on the 0.8m height of Turn Table, rotated the table around 360 degrees to search the maximum radiation power and receiver antenna shall be rotated vertical and horizontal polarization and moved height from 1m to 4m to find the maximum polar radiated power. The "Read Value" is the spectrum reading the maximum power value.
- b. The substitution horn antenna is substituted for EUT at the same position and signals generator export the CW signal to the substitution antenna via a TX cable. Rotated the Turn Table and moved receiving antenna to find the maximum radiation power. Adjust output power level of S.G to get a Value of spectrum reading equal to "Read Value" of step a. Record the power level of S.G
- c. $\text{EIRP} = \text{Output power level of S.G} - \text{TX cable loss} + \text{Antenna gain of substitution horn}$.
- d. E.R.P power can be calculated form E.I.R.P power by subtracting the gain of dipole, $\text{E.R.P power} = \text{E.I.R.P power} - 2.15\text{dBi}$.

NOTE: The resolution bandwidth and video bandwidth of test receiver/spectrum analyzer is 1MHz/3MHz.

4.7.3 Deviation from Test Standard

No deviation.

4.7.4 Test Setup

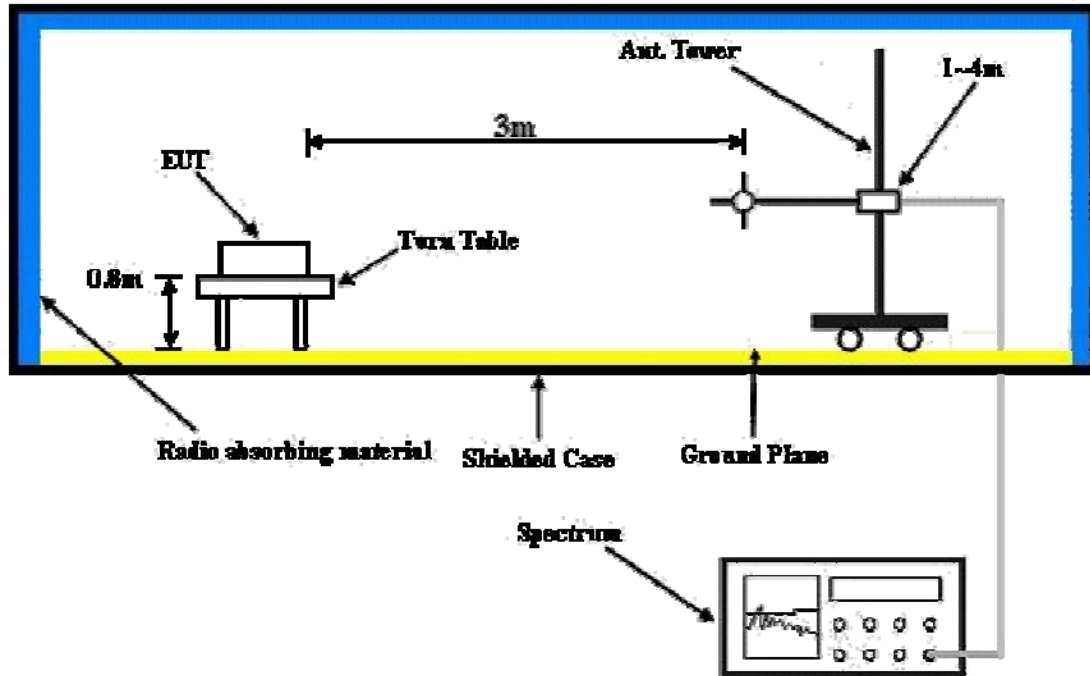

For the actual test configuration, please refer to the attached file (Test Setup Photo).



4.7.5 Test Results

Below 1GHz

For GSM Mode:

Mode	TX channel 189	Frequency Range	Below 1000 MHz
Environmental Conditions	18deg. C, 70%RH	Input Power	120Vac, 60Hz
Tested By	Nick Hsu	Test Mode	A

Antenna Polarity & Test Distance: Horizontal at 3 M

No.	Freq. (MHz)	Reading (dBm)	S.G Power Value (dBm)	Correction Factor (dB)	ERP (dBm)	Limit (dBm)	Margin (dB)
1	30.00	-71.5	-58.4	-12.2	-70.6	-13.0	-57.6
2	57.12	-58.3	-55.4	-8.2	-63.6	-13.0	-50.6
3	84.34	-66.5	-74.8	-0.4	-75.2	-13.0	-62.2
4	134.89	-61.3	-69.5	-0.2	-69.7	-13.0	-56.7
5	160.17	-64.1	-72.3	0.4	-71.9	-13.0	-58.9
6	185.44	-51.1	-65.2	3.6	-61.6	-13.0	-48.6

Antenna Polarity & Test Distance: Vertical at 3 M

No.	Freq. (MHz)	Reading (dBm)	S.G Power Value (dBm)	Correction Factor (dB)	ERP (dBm)	Limit (dBm)	Margin (dB)
1	57.12	-56.9	-57.8	-8.2	-66.0	-13.0	-53.0
2	103.78	-60.6	-71.3	0.7	-70.6	-13.0	-57.6
3	129.06	-68.1	-75.7	-0.1	-75.8	-13.0	-62.8
4	189.33	-60.6	-69.8	4.1	-65.7	-13.0	-52.7
5	235.99	-72.3	-81.7	5.4	-76.3	-13.0	-63.3
6	304.04	-66.5	-72.7	5.1	-67.5	-13.0	-54.5

Remarks:

1. Output Power (dBm) = S.G Value (dBm) + Correction Factor (dB).
2. Correction Factor (dB) = Substitution Antenna Gain (dB) + Cable Loss (dB).



Mode	TX channel 189	Frequency Range	Below 1000 MHz
Environmental Conditions	25deg. C, 65%RH	Input Power	120Vac, 60Hz
Tested By	Bayu Chen	Test Mode	C

Antenna Polarity & Test Distance: Horizontal at 3 M

No.	Freq. (MHz)	Reading (dBm)	S.G Power Value (dBm)	Correction Factor (dB)	ERP (dBm)	Limit (dBm)	Margin (dB)
1	35.82	-42.6	-25.3	-15.9	-41.2	-13.0	-28.2
2	47.46	-55.2	-48.0	-9.2	-57.2	-13.0	-44.2
3	82.38	-44.8	-52.7	0.4	-52.3	-13.0	-39.3
4	179.38	-36.8	-44.0	-2.9	-46.9	-13.0	-33.9
5	276.38	-49.1	-54.1	-1.6	-55.7	-13.0	-42.7
6	313.24	-51.8	-62.0	4.0	-58.0	-13.0	-45.0

Antenna Polarity & Test Distance: Vertical at 3 M

No.	Freq. (MHz)	Reading (dBm)	S.G Power Value (dBm)	Correction Factor (dB)	ERP (dBm)	Limit (dBm)	Margin (dB)
1	31.94	-38.1	-32.4	-18.3	-50.7	-13.0	-37.7
2	49.40	-40.5	-41.9	-8.3	-50.2	-13.0	-37.2
3	82.38	-42.0	-49.0	0.4	-48.6	-13.0	-35.6
4	177.44	-44.5	-47.4	-3.0	-50.4	-13.0	-37.4
5	270.56	-56.4	-55.1	-1.4	-56.5	-13.0	-43.5
6	313.24	-51.1	-57.4	4.0	-53.4	-13.0	-40.4

Remarks:

1. Output Power (dBm) = S.G Value (dBm) + Correction Factor (dB).
2. Correction Factor (dB) = Substitution Antenna Gain (dB) + Cable Loss (dB).



For WCDMA Mode:

Mode	TX channel 4182	Frequency Range	Below 1000 MHz
Environmental Conditions	18deg. C, 70%RH	Input Power	120Vac, 60Hz
Tested By	Nick Hsu	Test Mode	A

Antenna Polarity & Test Distance: Horizontal at 3 M

No.	Freq. (MHz)	Reading (dBm)	S.G Power Value (dBm)	Correction Factor (dB)	ERP (dBm)	Limit (dBm)	Margin (dB)
1	30.00	-74.4	-61.3	-12.2	-73.5	-13.0	-60.5
2	57.62	-55.9	-53.5	-8.1	-61.6	-13.0	-48.6
3	86.34	-60.7	-70.4	0.1	-70.3	-13.0	-57.3
4	158.28	-66.3	-73.8	0.3	-73.5	-13.0	-60.5
5	185.50	-61.9	-76.1	3.6	-72.4	-13.0	-59.4
6	219.66	-53.3	-69.4	5.5	-64.0	-13.0	-51.0

Antenna Polarity & Test Distance: Vertical at 3 M

No.	Freq. (MHz)	Reading (dBm)	S.G Power Value (dBm)	Correction Factor (dB)	ERP (dBm)	Limit (dBm)	Margin (dB)
1	33.84	-55.6	-54.7	-11.7	-66.4	-13.0	-53.4
2	59.12	-59.0	-60.4	-7.8	-68.2	-13.0	-55.2
3	110.56	-65.5	-76.0	0.5	-75.6	-13.0	-62.6
4	159.17	-66.8	-71.4	0.3	-71.1	-13.0	-58.1
5	191.33	-64.9	-74.1	4.4	-69.7	-13.0	-56.7
6	206.77	-64.1	-73.2	5.5	-67.8	-13.0	-54.8

Remarks:

1. Output Power (dBm) = S.G Value (dBm) + Correction Factor (dB).
2. Correction Factor (dB) = Substitution Antenna Gain (dB) + Cable Loss (dB).



A D T

Mode	TX channel 4182	Frequency Range	Below 1000 MHz
Environmental Conditions	18deg. C, 70%RH	Input Power	120Vac, 60Hz
Tested By	Jones Chang	Test Mode	C

Antenna Polarity & Test Distance: Horizontal at 3 M

No.	Freq. (MHz)	Reading (dBm)	S.G Power Value (dBm)	Correction Factor (dB)	ERP (dBm)	Limit (dBm)	Margin (dB)
1	57.12	-61.5	-58.6	-8.2	-66.8	-13.0	-53.8
2	178.72	-67.4	-80.3	2.7	-77.6	-13.0	-64.6
3	199.00	-67.6	-83.1	5.3	-77.8	-13.0	-64.8
4	299.16	-57.0	-66.6	5.1	-61.5	-13.0	-48.5
5	371.21	-63.2	-72.5	5.2	-67.3	-13.0	-54.3
6	599.47	-69.0	-73.9	4.4	-69.5	-13.0	-56.5

Antenna Polarity & Test Distance: Vertical at 3 M

No.	Freq. (MHz)	Reading (dBm)	S.G Power Value (dBm)	Correction Factor (dB)	ERP (dBm)	Limit (dBm)	Margin (dB)
1	49.29	-53.1	-52.6	-9.9	-62.5	-13.0	-49.5
2	110.56	-65.8	-76.3	0.5	-75.8	-13.0	-62.8
3	169.89	-59.7	-65.9	1.6	-64.3	-13.0	-51.3
4	191.33	-59.0	-68.2	4.4	-63.9	-13.0	-50.9
5	255.44	-72.4	-78.3	5.4	-73.0	-13.0	-60.0
6	325.49	-69.6	-76.9	5.2	-71.7	-13.0	-58.7

Remarks:

1. Output Power (dBm) = S.G Value (dBm) + Correction Factor (dB).
2. Correction Factor (dB) = Substitution Antenna Gain (dB) + Cable Loss (dB).

Above 1GHz

For GSM Mode:

Mode	TX channel 128	Frequency Range	Above 1000MHz
Environmental Conditions	25deg. C, 65%RH	Input Power	120Vac, 60Hz
Tested By	Tank Wu		

Antenna Polarity & Test Distance: Horizontal at 3 M							
No.	Freq. (MHz)	Reading (dBm)	S.G Power Value (dBm)	Correction Factor (dB)	ERP (dBm)	Limit (dBm)	Margin (dB)
1	1648.40	-47.2	-39.5	0.9	-38.6	-13.0	-25.6
2	2472.60	-45.0	-38.7	0.1	-38.6	-13.0	-25.6
Antenna Polarity & Test Distance: Vertical at 3 M							
No.	Freq. (MHz)	Reading (dBm)	S.G Power Value (dBm)	Correction Factor (dB)	ERP (dBm)	Limit (dBm)	Margin (dB)
1	1648.40	-47.6	-40.3	0.9	-39.4	-13.0	-26.4
2	2472.60	-48.0	-44.0	0.1	-43.9	-13.0	-30.9

Remarks:

1. Output Power (dBm) = S.G Value (dBm) + Correction Factor (dB).
2. Correction Factor (dB) = Substitution Antenna Gain (dB) + Cable Loss (dB).

Mode	TX channel 189	Frequency Range	Above 1000MHz
Environmental Conditions	25deg. C, 65%RH	Input Power	120Vac, 60Hz
Tested By	Tank Wu		

Antenna Polarity & Test Distance: Horizontal at 3 M							
No.	Freq. (MHz)	Reading (dBm)	S.G Power Value (dBm)	Correction Factor (dB)	ERP (dBm)	Limit (dBm)	Margin (dB)
1	1672.80	-55.5	-47.9	0.8	-47.1	-13.0	-34.1
2	2509.20	-41.9	-35.6	0.2	-35.4	-13.0	-22.4
Antenna Polarity & Test Distance: Vertical at 3 M							
No.	Freq. (MHz)	Reading (dBm)	S.G Power Value (dBm)	Correction Factor (dB)	ERP (dBm)	Limit (dBm)	Margin (dB)
1	1672.80	-45.2	-37.9	0.8	-37.1	-13.0	-24.1
2	2509.20	-46.9	-43.0	0.2	-42.8	-13.0	-29.8

Remarks:

1. Output Power (dBm) = S.G Value (dBm) + Correction Factor (dB).
2. Correction Factor (dB) = Substitution Antenna Gain (dB) + Cable Loss (dB).



Mode	TX channel 251	Frequency Range	Above 1000MHz
Environmental Conditions	25deg. C, 65%RH	Input Power	120Vac, 60Hz
Tested By	Tank Wu		

Antenna Polarity & Test Distance: Horizontal at 3 M							
No.	Freq. (MHz)	Reading (dBm)	S.G Power Value (dBm)	Correction Factor (dB)	ERP (dBm)	Limit (dBm)	Margin (dB)
1	1697.60	-53.2	-45.7	0.7	-45.0	-13.0	-32.0
2	2546.40	-39.1	-33.1	0.2	-32.9	-13.0	-19.9

Antenna Polarity & Test Distance: Vertical at 3 M							
No.	Freq. (MHz)	Reading (dBm)	S.G Power Value (dBm)	Correction Factor (dB)	ERP (dBm)	Limit (dBm)	Margin (dB)
1	1697.60	-46.2	-38.9	0.7	-38.2	-13.0	-25.2
2	2546.40	-43.9	-39.8	0.2	-39.6	-13.0	-26.6

Remarks:

- 1. Output Power (dBm) = S.G Value (dBm) + Correction Factor (dB).
- 2. Correction Factor (dB) = Substitution Antenna Gain (dB) + Cable Loss (dB).



For WCDMA Mode:

Mode	TX channel 4132	Frequency Range	Above 1000MHz
Environmental Conditions	25deg. C, 65%RH	Input Power	120Vac, 60 Hz
Tested By	Tank Wu		

Antenna Polarity & Test Distance: Horizontal at 3 M							
No.	Freq. (MHz)	Reading (dBm)	S.G Power Value (dBm)	Correction Factor (dB)	ERP (dBm)	Limit (dBm)	Margin (dB)
1	1652.80	-56.9	-49.1	0.9	-48.2	-13.0	-35.2
Antenna Polarity & Test Distance: Vertical at 3 M							
No.	Freq. (MHz)	Reading (dBm)	S.G Power Value (dBm)	Correction Factor (dB)	ERP (dBm)	Limit (dBm)	Margin (dB)
1	1652.80	-52.1	-44.9	0.9	-44.0	-13.0	-31.0

Remarks:

1. Output Power (dBm) = S.G Value (dBm) + Correction Factor (dB).
2. Correction Factor (dB) = Substitution Antenna Gain (dB) + Cable Loss (dB).

Mode	TX channel 4182	Frequency Range	Above 1000MHz
Environmental Conditions	25deg. C, 65%RH	Input Power	120Vac, 60 Hz
Tested By	Tank Wu		

Antenna Polarity & Test Distance: Horizontal at 3 M							
No.	Freq. (MHz)	Reading (dBm)	S.G Power Value (dBm)	Correction Factor (dB)	ERP (dBm)	Limit (dBm)	Margin (dB)
1	1672.80	-57.5	-49.9	0.8	-49.1	-13.0	-36.1
Antenna Polarity & Test Distance: Vertical at 3 M							
No.	Freq. (MHz)	Reading (dBm)	S.G Power Value (dBm)	Correction Factor (dB)	ERP (dBm)	Limit (dBm)	Margin (dB)
1	1672.80	-50.4	-43.1	0.8	-42.3	-13.0	-29.3

Remarks:

1. Output Power (dBm) = S.G Value (dBm) + Correction Factor (dB).
2. Correction Factor (dB) = Substitution Antenna Gain (dB) + Cable Loss (dB).



Mode	TX channel 4233	Frequency Range	Above 1000MHz
Environmental Conditions	25deg. C, 65%RH	Input Power	120Vac, 60 Hz
Tested By	Tank Wu		

Antenna Polarity & Test Distance: Horizontal at 3 M							
No.	Freq. (MHz)	Reading (dBm)	S.G Power Value (dBm)	Correction Factor (dB)	ERP (dBm)	Limit (dBm)	Margin (dB)
1	1693.2	-56.8	-49.2	0.7	-48.5	-13.0	-35.5

Antenna Polarity & Test Distance: Vertical at 3 M							
No.	Freq. (MHz)	Reading (dBm)	S.G Power Value (dBm)	Correction Factor (dB)	ERP (dBm)	Limit (dBm)	Margin (dB)
1	1693.2	-51.6	-44.3	0.7	-43.6	-13.0	-30.6

Remarks:

1. Output Power (dBm) = S.G Value (dBm) + Correction Factor (dB).
2. Correction Factor (dB) = Substitution Antenna Gain (dB) + Cable Loss (dB).

5 Pictures of Test Arrangements

Please refer to the attached file (Test Setup Photo).

Appendix – Information on the Testing Laboratories

We, Bureau Veritas Consumer Products Services (H.K.) Ltd., Taoyuan Branch, were founded in 1988 to provide our best service in EMC, Radio, Telecom and Safety consultation. Our laboratories are accredited and approved according to ISO/IEC 17025.

If you have any comments, please feel free to contact us at the following:

Linko EMC/RF Lab

Tel: 886-2-26052180

Fax: 886-2-26051924

Hsin Chu EMC/RF/Telecom Lab

Tel: 886-3-6668565

Fax: 886-3-6668323

Hwa Ya EMC/RF/Safety

Tel: 886-3-3183232

Fax: 886-3-3270892

Email: service.adt@tw.bureauveritas.com

Web Site: www.bureauveritas-adt.com

The address and road map of all our labs can be found in our web site also.

--- END ---