

Handheld Computer

Z-2170 series

(Version 1.0)

User's Manual

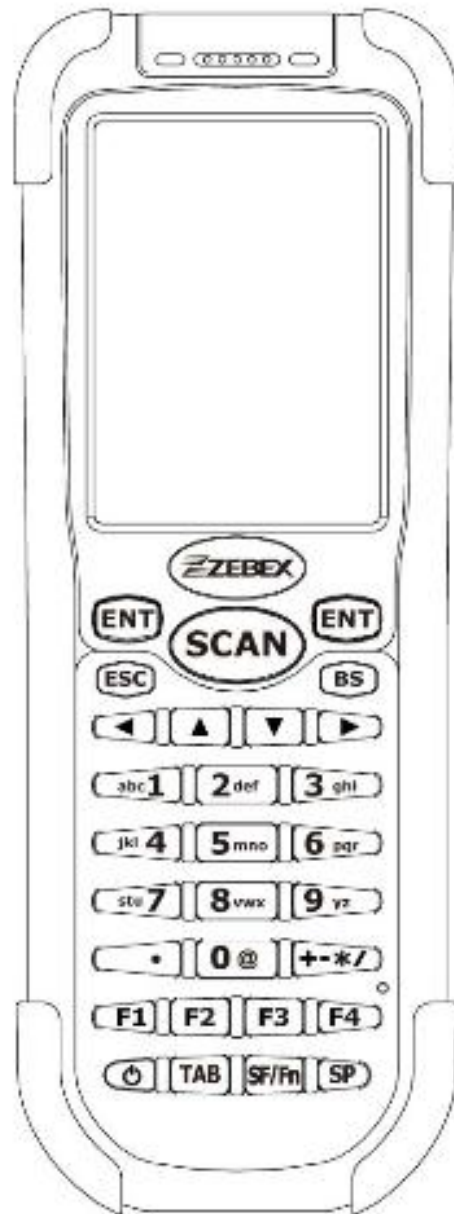

ZEBEX INDUSTRIES INC.
www.zebex.com

Table of Contents

Preface

About This Manual	5
Symbols used in this manual	5
Copyright.....	6
Safety Information.....	6
Laser Safety	6
Safety Operation	7
Federal Communication Commission (FCC) Statement.....	8

Unpacking

Package Contents	9
Optional Parts	10
Cradle package.....	10
Purchaseable accessories	11
General Guide	12

Getting Start

Inserting the Battery.....	15
Remove the Battery	15
Charging the Battery	16
Charging by cable.....	16
Charging by cradle	16
Charging the battery separately in the cradle.....	18
System Reset.....	19
Using the Warm reset function	19
Using the Cold reset function.....	19
PC System Requirements	20
Connecting To PC	20
Connecting via USB Cradle.....	20
Connecting the Z-2170 directly via USB cable	21
About The Product	22
Prerequisites.....	22
Specifications	23

Using Barcode Scanner

Scanning Barcodes	24
-------------------------	----

Using Zebex Power Pack

Backlight	26
Calculator.....	28

File Transfer	29
File Transfer Operation	30
Preload Manager	32
Preload operation	33
Switch	36
Scan Manager	38
Backup/Restore	42
Firmware Information	45
Function Key Manager.....	46

Preface

About This Manual

Thank you for your purchase of the ZEBEX Z-2170 handheld computer. ZEBEX Z-2170 product is at the forefront of handheld computer technology, and this manual will provide the necessary information on the many and varied options available to you.

The Z-2170 product is a compact, ergonomic, modular and durable handheld computer. It is designed for easy upgrade with an integrated WiFi wireless communication, 1D barcode scanner, 2D Imager, The design is complies with IP54 regulations and ideal for the mobile worker as it simple and easy to use anywhere along a supply chain.

Symbols used in this manual



A triangular shape indicates you should exercise caution.



A circle shape indicates something you should not to do.



A black circle indicates something you must to do.



A note symbol indicates the information is important and you should observe.

Copyright

ZEBEX Industries Inc. makes no warranty of any kind with regard to this material. Including but not limited to the implied warranties of merchantability and fitness for a particular purpose. ZEBEX Industries Inc. shall not be liable for errors contained herein or for incidental consequential damages in connection with the furnishing, performance or use of this product.

ZEBEX Industries Inc. will be under no liability in respect of any defect arising from fair wear and tear, willful damage, negligence, abnormal working conditions, failure to follow the instructions and warnings, or misuse or alteration or repair of the products without written approval.

No part of this document may be reproduced, transmitted, stored in a retrieval system, transcribed or translated into any language or computer language in any form or by any means electronic, mechanical, magnetic, optical, chemical, manual or otherwise, with express written consent and authorization.

We reserve the right to make changes in product design without reservation and without notification. The material in this guide is for information only and is subject to change without notice.

ZEBEX is a registered trademark of ZEBEX INDUSTRIES INC.

© Copyright 2012 ZEBEX.

Safety Information

Your safety is of the utmost importance so please observe and follow the following guidelines that allow you to use the scanner in a safe and responsible way.

Laser Safety

The Z-2170 series handheld computer complies with safety standard IEC825-1(1993) for a Class 2 laser product. It also complies with U.S.21CFR1040 as applicable to a Class II laser product. Avoid staring at direct laser light as the laser beam may hurt your eyes.



LASER BEAM

Never look directly into the laser beam. Doing so can cause eye damage.

Safety Operation

WARNING



Disassembly and Modification

Never try to disassemble or modify the device in any way. All servicing should be carried out by qualified Zebex personnel or Zebex- approved engineers.



Interior Parts and Components

Never touch interior high voltage parts or components. Doing so creates the danger of electrical shock.



Drop and Knock the Device

Be careful when using the device; do not drop or knock the device as irreversible damage to the unit may occur.



Extreme temperature

Do not operate the device under extreme temperature.



Battery and Charger

The use of third-party battery or charger may either damage the device or shorten the life of the device.

CAUTION



Dropping and Damage

Should the drop the device and damage it, immediately turn off the power and contact your original dealer or an authorized ZEBEX service provider. Continued use creates the danger of fire and electrical shock.



Abnormal Conditions

Should the device become hot or start to emit smoke or an original dealer or an authorized ZEBEX service provider. Continued use creates the danger of fire and electrical shock.



Foreign Objects

Should any foreign matter ever get into the device, immediately turn off the power and contact your original dealer or an authorized ZEBEX service provider. Continued use creates the danger of fire and electrical shock.



Moisture

Keep the device away from vases, planters, cups, glasses and other containers of liquid. Also keep it away from metal. Water and metal getting into the device creates the danger of fire and electrical shock.

Federal Communication Commission (FCC) Statement

This equipment has been tested and found to comply with the limits for a Class B digital device, pursuant to part 15 of the FCC rules. These limits are designed to provide reasonable protection against harmful interference in a residential installation. This equipment generates, uses and can radiate radio frequency energy and, if not installed and used in accordance with the instructions, may cause harmful interference to radio communications. However, there is no guarantee that interference will not occur in a particular installation. If this equipment does cause harmful interference to radio or television reception, which can be determined by turning the equipment off and on, the user is encouraged to try to correct the interference by one or more of the following measures:

- Reorient or relocate the receiving antenna.
- Increase the separation between the equipment and receiver.
- Connect the equipment into an outlet on a circuit different from that to which the receiver is connected.
- Consult the dealer or an experienced radio/TV technician for help.

FCC Caution

This device complies with Part 15 of the FCC Rules. Operation is subject to the following two conditions:

- (1) this device may not cause harmful interference and
- (2) this device must accept any interference received, including interference that may cause undesired operation

RF exposure warning: The equipment complies with RF exposure limits set forth for an uncontrolled environment. The antenna(s) used for this transmitter must not be co-located or operating in conjunction with any other antenna or transmitter.

You are cautioned that changes or modifications not expressly approved by the party responsible for compliance could void your authority to operate the equipment.

CE Certification **CE1177** ⓘ

This indicates compliance with the R&TTE Directive 1999/5/EC and meets the relevant parts of following technical specifications:
ETSI EN 300 328 V1.7.1: 2006, ETSI EN301489-17 V2.1.1: 2009
ETSI EN301489-1 V1.8.1: 2008, EN55022:2006+A1:2007
EN55024:1998+A1:2001+A2:2003,
EN60950-1:2006 / A11:2009 / A1:2010 / A12:2011 and/or
IEC60950-1:2005(2nd Edition) / A1:2009
EN 62311: 2008

This equipment complies with CE RF radiation exposure limits set forth for an uncontrolled environment.

This equipment should be installed and operated with a minimum distance of 20 centimeters between the radiator and your body.

Unpacking

Package Contents

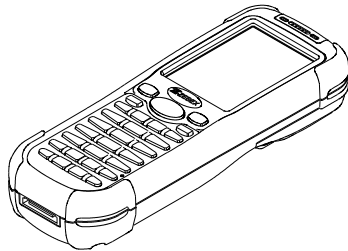

Z-2170 series
Mobile Data Terminal

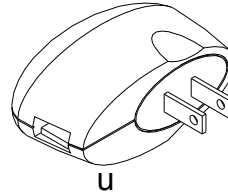

Travel charger
selection Type: North America/Japan/
Taiwan/Europe

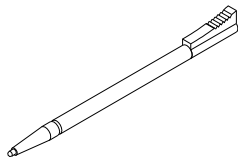

Stylus Pen

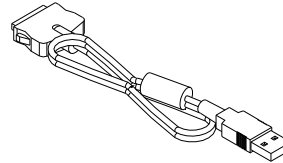

USB cable
(Terminal connect to PC USB port)



Sling (for stylus Pen)

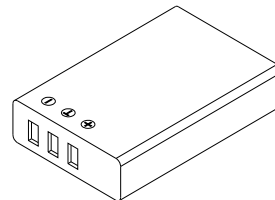

Battery Pack

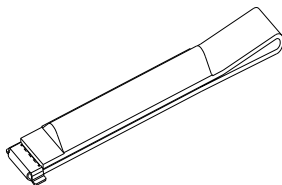

Hand Strip

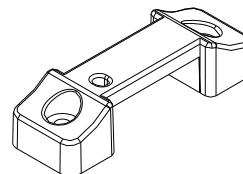

Hand strip Holder

Optional Parts

Cradle package

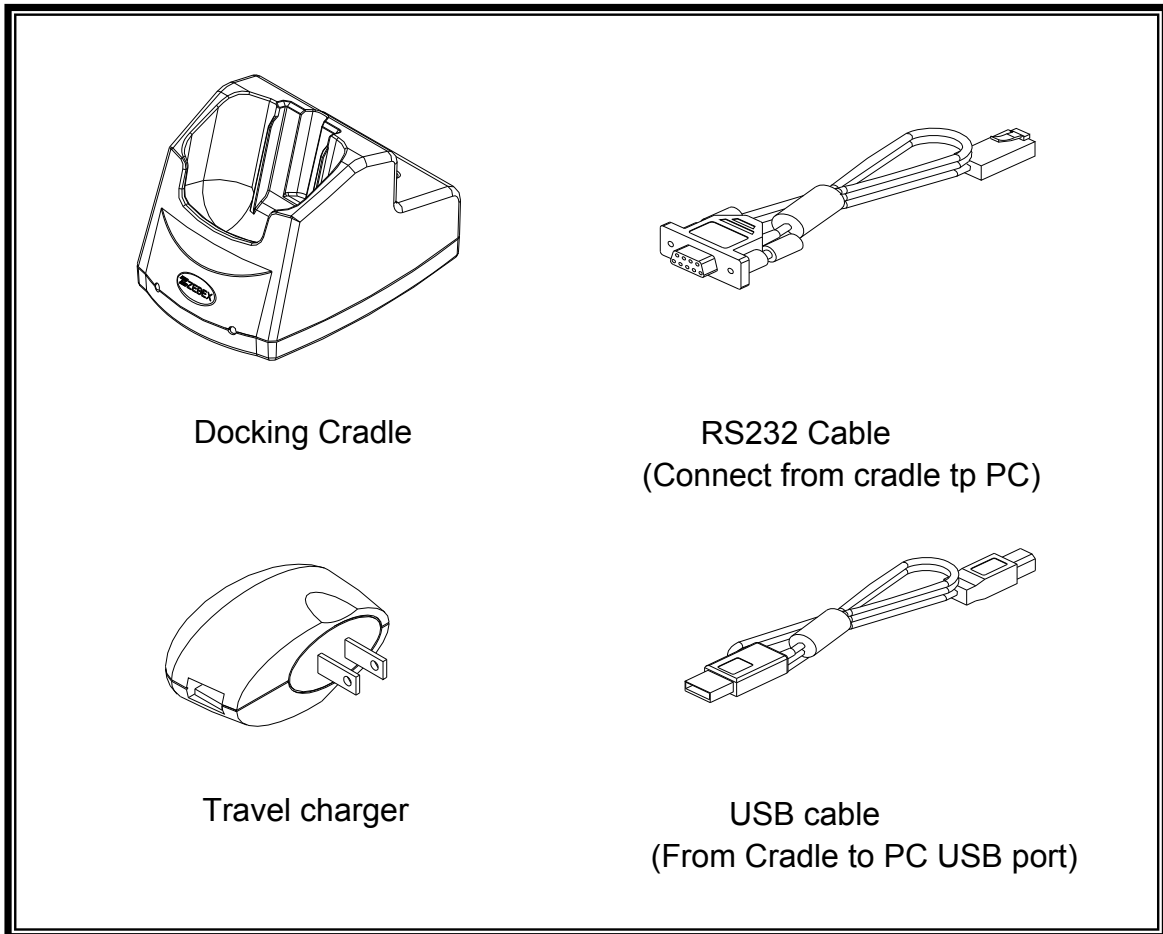

Purchaseable accessories

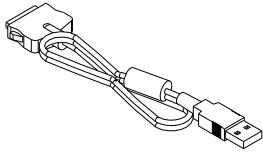

USB Cable
(Terminal connect to PC USB port)

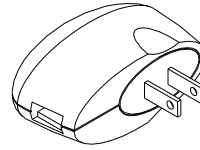

Travel charger

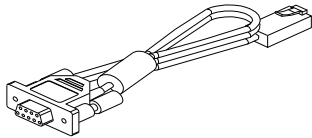

RS232 Cable

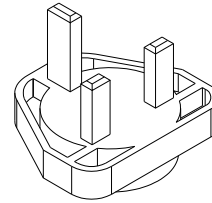

Britain Plug head

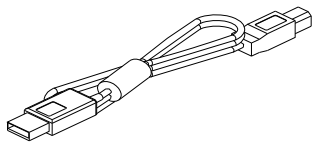

USB cable
(From Cradle to PC USB port)

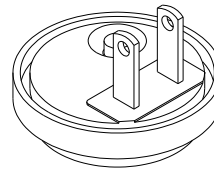

U.S. Plug head

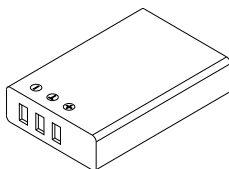

Main Battery

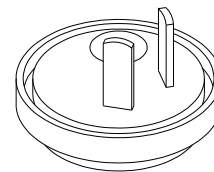

Australia Plug head

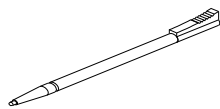

Stylus Pen

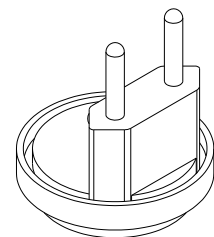

Europe Plug head



Sling (for stylus Pen)

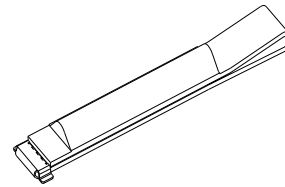

Hand Strip

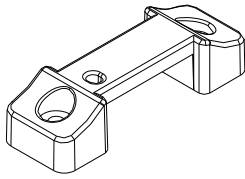

Hand strip Holder

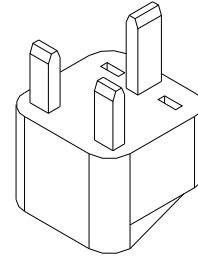

Britain Adapter Head

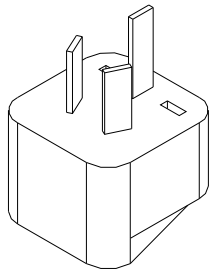

Australia Adapter Head

General Guide

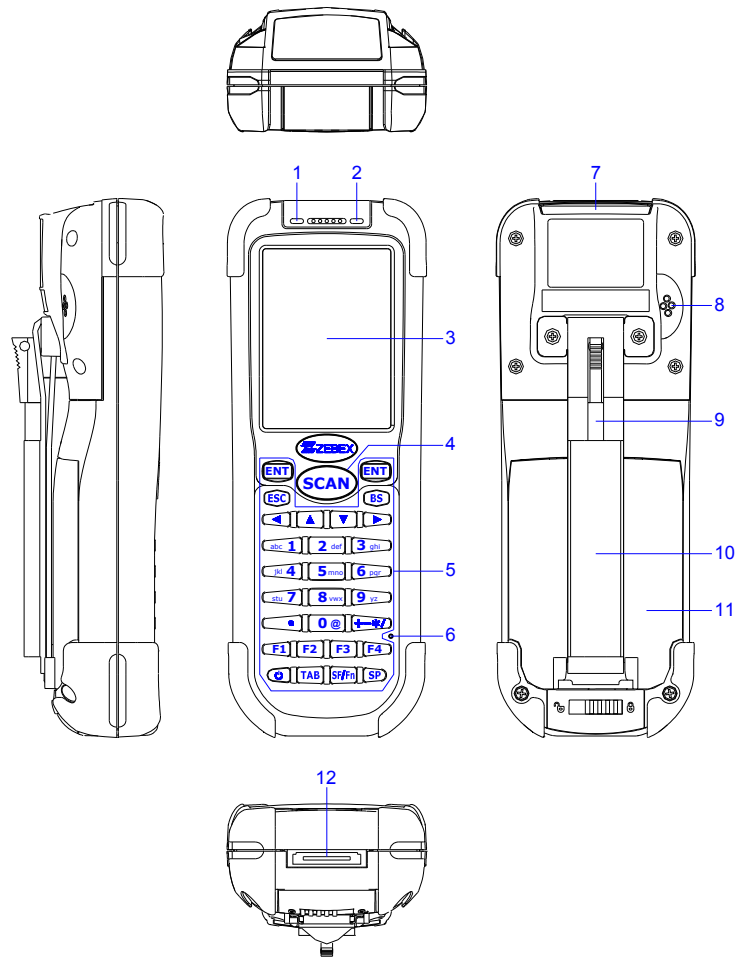

1	LED indicator (Left)	Indicates the status of read bar code : Green for successful read.
2	LED indicator (Right)	Indicates the status of battery charge : Red for battery just on charging and Green for full.
3	LCD screen	Display various data when a program is being run.
4	Scan button	The trigger of Barcode reading.
5	Keypad	A total of 29 keys are provided to the power and other function keys.
6	Reset switch (inside the hole)	Use reset needle (take off the other side of stylus pen cover) to press the RESET switch located inside the hole.
7	Scan windows	Emits a laser for bar code reading.
8	Buzzer	Outputs operation confirmation tones.
9	Stylus pen	For touch screen operation and needle for press RESET switch.
10	Hand strip	Protects the Handheld Terminal to drop.
11	Battery	Main battery
12	Communication port	Communication with PC or charge by USB port

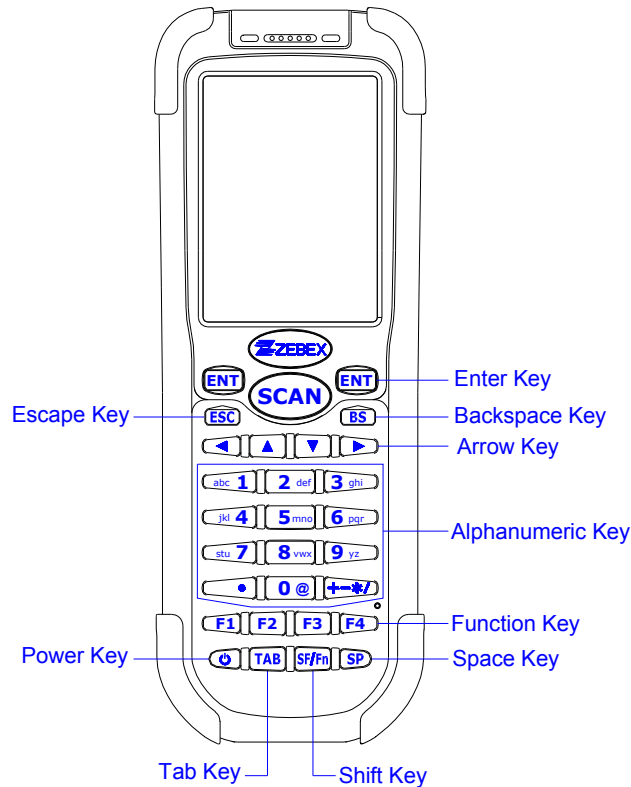

Using the Keypad

ENT	Enter key	Press to confirm entries or commands.
BS	Backspace key	Press to move cursor and deletes the previous character each time.
Arrow	Arrow keys	Press these to move around the screen.
0-9	Alphanumeric keypad	Press to enter numerical or alphabetical data.
F1-F4	Function keys	Press to access function keys 1-4.
SP	Space key	Press to add a space character.
SF/Fn	Shift key	<p>The key is used in combination with other keys to type special characters or perform other function keys.</p> <ol style="list-style-type: none"> 1. Press after SF/Fn key and press Up key to turn the input method into upper alphabetical. 2. Press after SF/Fn key and press Down key to turn the input method into lower alphabetical. 3. Press after SF/Fn key and press Left or Right key to turn the input method into numerical. 4. Press after SF/Fn key and press F1-F4 key to perform F5 - F8 key.
TAB	Tab key	Press to add a tab indentation.
	Power	<ol style="list-style-type: none"> 1. Press to turn the power on. 2. Press more then 3 seconds for turn the terminal power off and go into the suspend mode.
ESC	Escape key	Press to perform a cancel action.

Getting Started

Inserting the Battery

Insert the battery pack as shown and watch the battery direction..

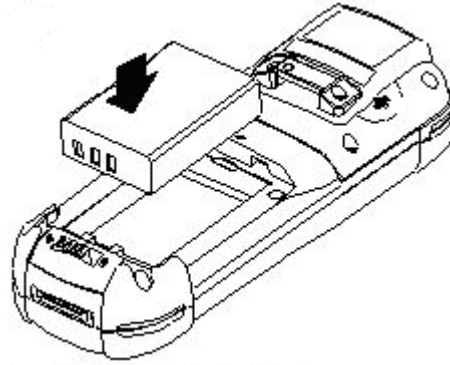

Remove the Battery

Push the side lock to pick up the battery pack.

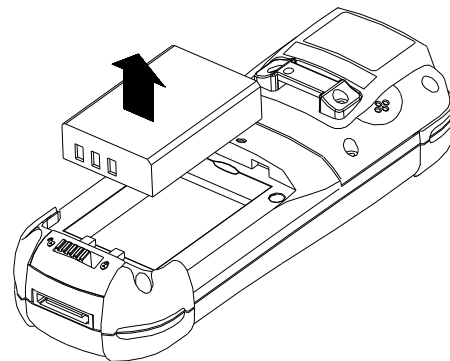
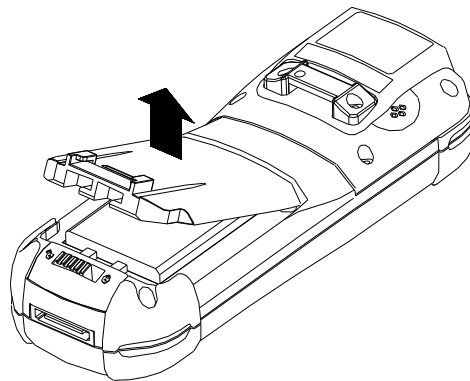

Charging the Battery

The Li-ion rechargeable battery can be charged while inserted in the device itself or independently via the recharging slot at the back of the cradle.

Charging by cable

Connect the charging cable and USB AC adaptor as shown.

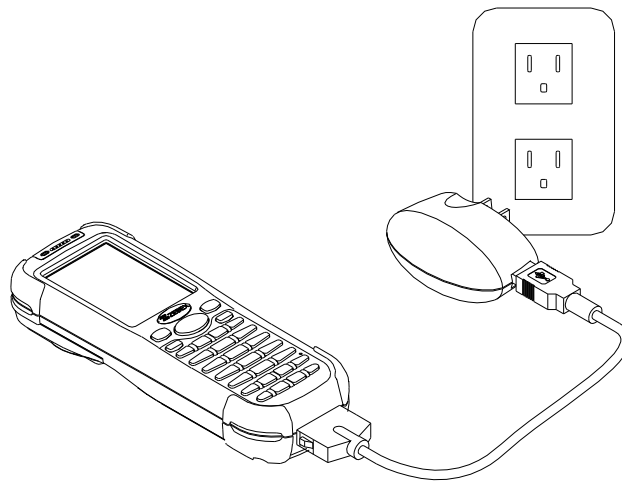

Charging by cradle

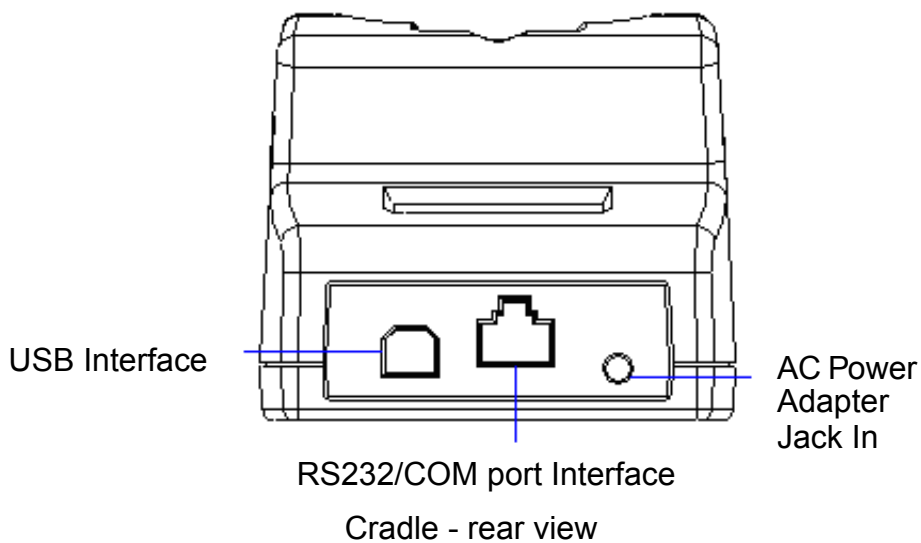

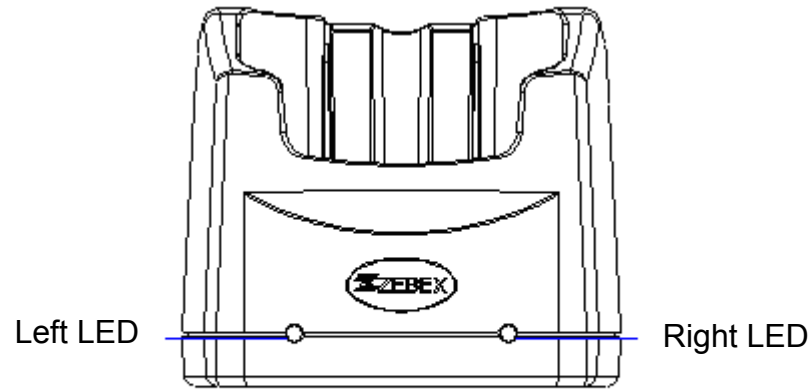

Cradle-front view

Cradle LEDs

Left LED - The LED lit when a battery is inserted into the rear battery slot of the cradle for recharge. It remains lit until the charge is complete.

Right LED - The LED lit when the cradle is connected to AC power.

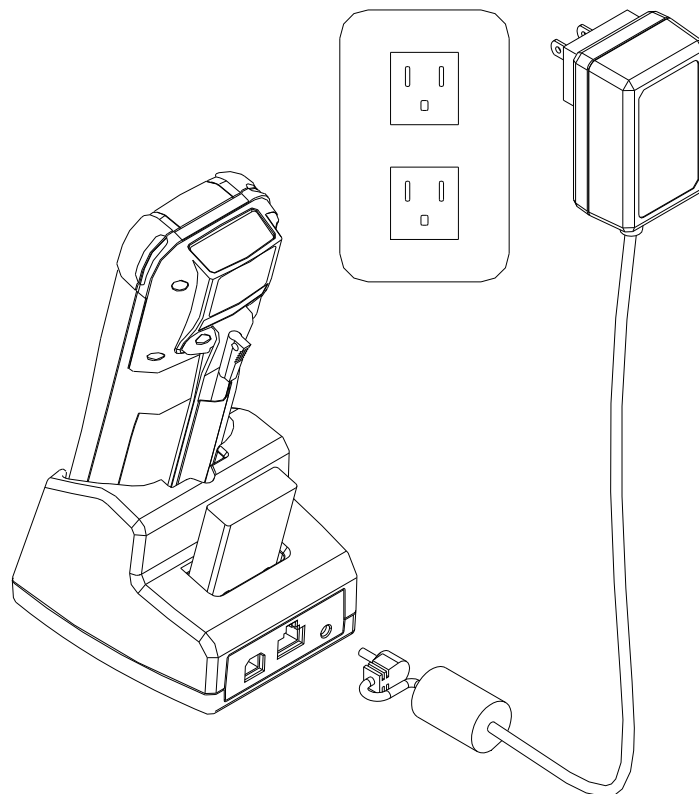

Charging the battery separately in the cradle

Insert the battery into the compartment at the rear of the cradle.

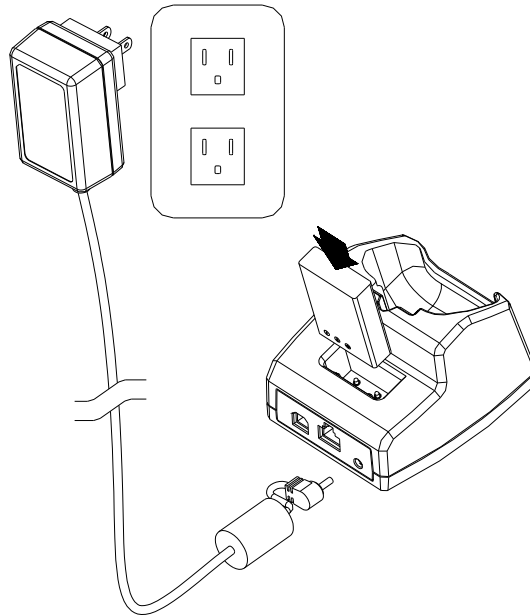

Connect the power jack to the cradle and plug AC adapter into the socket.



NOTES

When charging the battery for the first time, charge for at least 12 hours prior to use.

System Reset

Using the Warm reset function

Warm reset function allows you to return the device to the default settings, while not wiping all data from the memory.

Insert the needle into the reset hole as shown and press down gently, to reset the device.

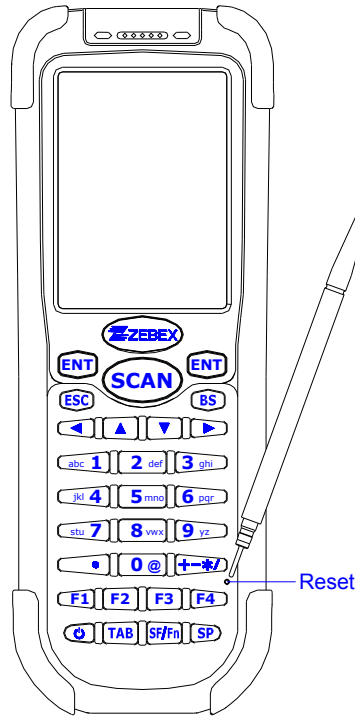

Using the Cold reset function

Cool reset function allows you to return the device to the factory settings, while wiping all data from the memory.

Press down and hold the power key and Insert the needle into the reset hole to cool reset the device.



WARNING

Cold reset will erase ALL pre-configured data on the scanner. Check carefully to make sure you have uploaded all important files to your PC before proceeding with the reset.

PC System Requirements

Windows XP Operating System
256 MB RAM
1 GB free HDD space
USB ports communication Interface
WLAN transmitter (optional)
Bluetooth transmitter/receiver (optional)

Connecting To PC

In order to use the software supplied with the Terminal, the mobile data terminal must be connected to a PC.

Connecting via USB Cradle

The cradle must also be connected via one of your PC's USB ports. Attach one end of the cable to the USB interface on the cradle and the other to your PC.

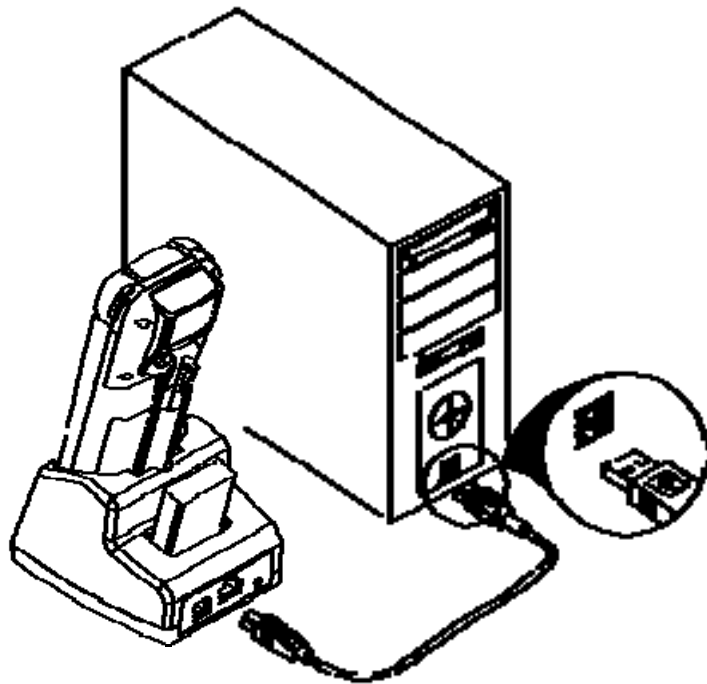

Connecting the Z-2170 directly via USB cable

You can connect the Z-2170 directly to your PC, without the need for the cradle, using the Mini USB cable, attaching it to the port on the left hand side of the device.

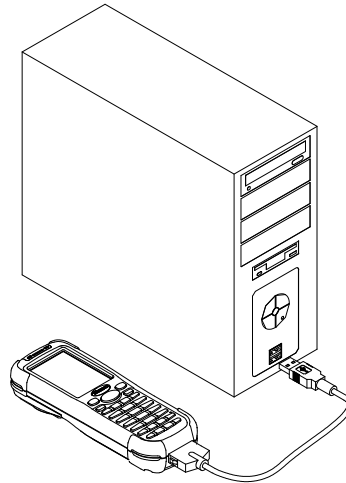

About The Product

The Z-2170 is a compact, ergonomic and durable portable data terminal. It is designed with an integrated wireless communication and 1D laser barcode scanner, touch screen and 29-keys keypad. The design is ideal for the mobile worker as it simple and easy to use anywhere along a supply chain. It complies with IP54 regulations.

The Z-2170 features a Intel PXA-310 processor (806MHz) with Windows CE.NET version 6.0 operation system. This combination delivers high performance, low power consumption and the diversity of a wireless networking platform. Compared with other systems currently available on the market, Z-2170 is the most cost-effective to offering optimum performance.

Features

- Pocket size design
- Microsoft Windows CE.NET 6.0 operating system
- 2.4" TFT color display with touch pane
- Micro SD I/O Slot for extra storage or Wireless solution with IEEE802.11b/g
- Easy system control tools – PowerPack, saving time and cost for software development

Prerequisites

Skills Required

The following skills are required by developers aiming to develop application software for the ZEBEX Z-2170 series.

- Windows programming
- Good knowledge of one or more of the following:
 - * Visual C++
 - * Visual Basic .NET
 - * Visual studio .NET
 - * Visual C#
 - * Active Server Pages and web programming

The following skills or experiences are also desirable.

- Windows CE devices
- IE 6.0 ActiveSync
- Some thing networking experience.

Specifications

Model	Z-2170
System	
CPU	Marvell XScale PXA 310 806MHz 32 bits Processor
RAM	256 Mbytes
F-ROM	1GB Mbytes
LCD Display	2.4", QVGA 240 X 320 TFT color panel with touch screen
Audio	One speaker output, AC97 Codec with speaker output and touch panel control Internal Microphone input
Operating System	Microsoft Windows CE.NET 6.0
Power Management	
Main Battery	3.7V 2,200mAH Li-ion rechargeable battery
Backup Battery	One rechargeable Li-ion backup battery
Vibrator	Only Barcode Scan OK
Scanning Performance	
Scan Engine	1D engine or 2D Imager
Light Source	650 nm visible Laser Diode
Scan Rate	100 scans per second
Print Contrast	30% @ UPC/EAN 100%
Decoding Capability	
Barcode Symbologies	UPC/ EAN/ JAN, Code 128/EAN 128, Code 39, Code 93, Interleaved 2 of 5, Discrete 2 of 5, Codabar, MSI/Plessey
Card Slots	1 x Micro SD I/O card
Communications / Interfaces	
USB	1.1 Client
RS-232	Programmable up to 115,200 bps
WLAN	802.11b/g (optional)
Bluetooth	V2.1 class II (SPP, HID)
RF Reader	support ISO-14443 a/b, ISO-15693, Mifare
Dimensions	(L) 162 mm x (W) 60.0 mm x (H) 37.3 mm
Weight	Approx. 240 g (battery included)
Environmental	
Operating Temp.	-10°C ~ 50°C
Storage Temp	-20°C ~ 60°C
Operating Humidity	5% ~ 85% (non-condensing)
Drop Durability	Withstand 1.2M drop to concrete
Environmental Sealing	IP54 rated sealing
Regulatory Approvals	CE & FCC Part 15B
Cradle	Single slot USB / RS-232 charging cradle with spare battery slot
Software & Development	IE6.0 Active sync / Update from Micro-SD card / PowerPack Utility / Support Software SDK / Support Wave Link Application

Using Barcode Scanner

Scanning Barcodes

The Z-2170 is a highly versatile tool that can scan a wide range of barcodes but it is imperative that it is used in the correct manner.

To scan a barcode:

1. Hold the Z-2170 horizontally and point it directly at the barcode you wish to scan.
2. Once in the correct position, press the **SCAN** button.

An audible alarm is heard and the barcode digits will appear on the LCD screen if the scan is successful.

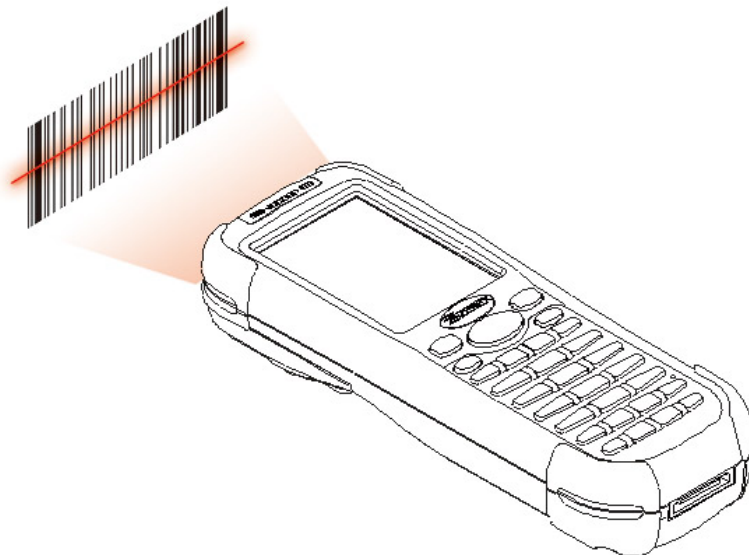

Barcode Scanning Position

This device can read from 30 to 180mm distance.

1. Position the laser scanner close to the barcode when scanning small barcodes. And position it is a distance from the barcode when scanning large barcodes
2. The reader can be detected by a red beam.

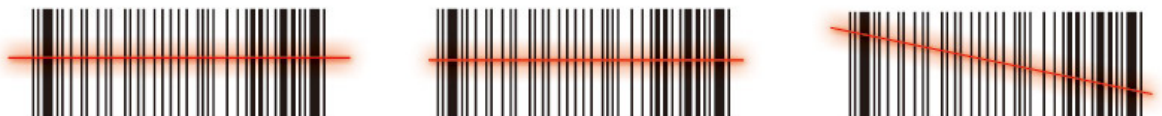

Band Scanning Position

Make sure that the bars enter the laser beam when scanning large barcodes.

Scanning operations may fail if the laser beam position as below.

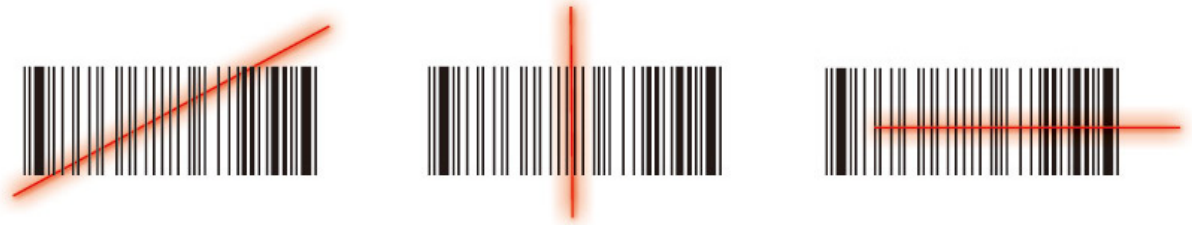

Note: this product scans using laser light. Never look directly into the laser light or shine the laser light into the eyes.

Using the Zebex PowerPack

To save your time and effort in developing applications on Z-2170, ZEBEX provides its own design system management tool called "PowerPack" to let you control it directly.

The PowerPack management tools which install in each of our WinCE product. It is free charge for you. We offer several functions for let you control your device without any programming.

Backlight

This application is set up the Backlight of LCD Panel and Key pad. It allows operators to set backlight duration, and also backlight can be set up as On & Off.

The Backlight Setting screen including 3 parts:

1. LCD
2. Keypad
3. Brightness Control Bar

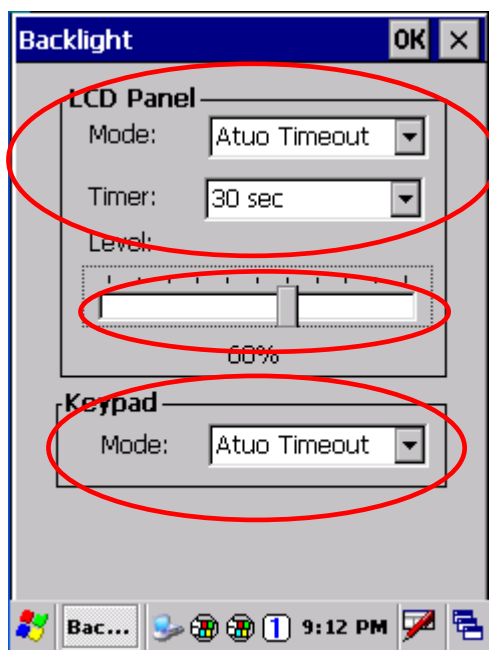

1. LCD

The LCD backlight setting.

Auto Mode: This function can be set up the LCD backlight to be auto off as Device hasn't been activated for certain interval.
You can set up the Auto off time from 15 sec to 15 min.

Always ON: This function can set up the backlight to be always on
Until the system into suspend mode.

Always OFF: This function can set up the backlight to be always off.

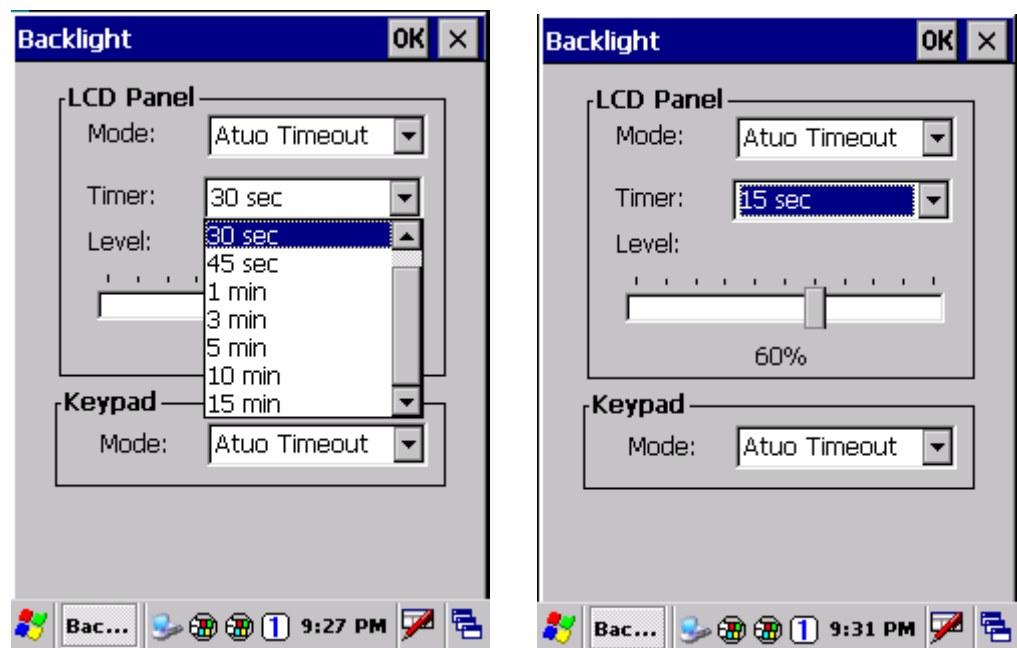

2. Keypad

The Keypad Backlight setting.

Auto Mode: This function can be set up the keypad backlight to be auto off as device hasn't been activated for certain interval.
The interval of the time for auto off was fixed on 5 seconds.

Always ON: This function can set up the keypad backlight to be
always on until the system into suspend mode.

Always OFF: This function can set up the backlight to be always off.

3. Brightness Control Bar

The brightness of the backlight can be changed via control bar. Put up to light and put down to dark.

Calculator

This calculator function allows operators to add, subtract, multiply, and divide that simply provide basic logistic function in our daily basis.

The upper zone of the display area displays the memory content, and the lower zone is key pad.



Button description:

- MC : Clear buffer of memory.
- MR : Got the value of buffer.
- MS : Storage the value to buffer.
- M+ : Append the value to the buffer.
- CE : Clear the display area to "0", but keep the value in buffer.
- C : Clear the display and the buffer of memory.
- +/- : Change the value sign form Plus to Minus or Minus to Plus.
- 0~9 : Numeric key.
- / : Division function.
- * : Multiplication function.
- : Subtraction function.
- + : Addition function.
- . : A decimal point of dot.
- = : To be equal to, The amount.

File Transfer

File Transfer is a simple file transferring function tool, the tool can transfer file to another devices via blue tooth. Communication agreement of file transferring was adopted with OBEX agreement which shared with cell phone or Notebook PC. So you can simply use this function to transfer file to cell phone or Notebook PC, or doing file transferring between two terminals.

File Transfer is capable to auto-search devices with Bluetooth communication, so all devices within valid range will be listed in window of “**1. Select Remote Device.**”

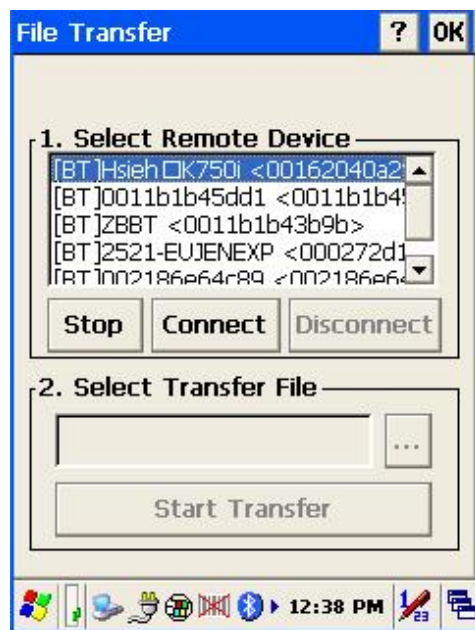

Function Instructions:

1. Select Remote Device

All devices with Bluetooth Communication functions are listed on the display.

- Query** : For searching usable devices.
- Stop** : Stop searching.
- Connect** : For connecting with one device.
- Disconnect** : For disconnecting with current devices.

2. Select Transfer File

Select file need to be transferred, press  bottom for selecting file.

- Start Transfer** : Start transferring file to targeted devices.

File Transfer Operation

1. File Transferring by using Bluetooth:

Make sure Bluetooth devices was activated, Bluetooth Communication devices can be activated under Switch Function within PowerPack software utilities.

- 1.1 Select “**Query**” for searching Bluetooth devices, below window will pop up on display.

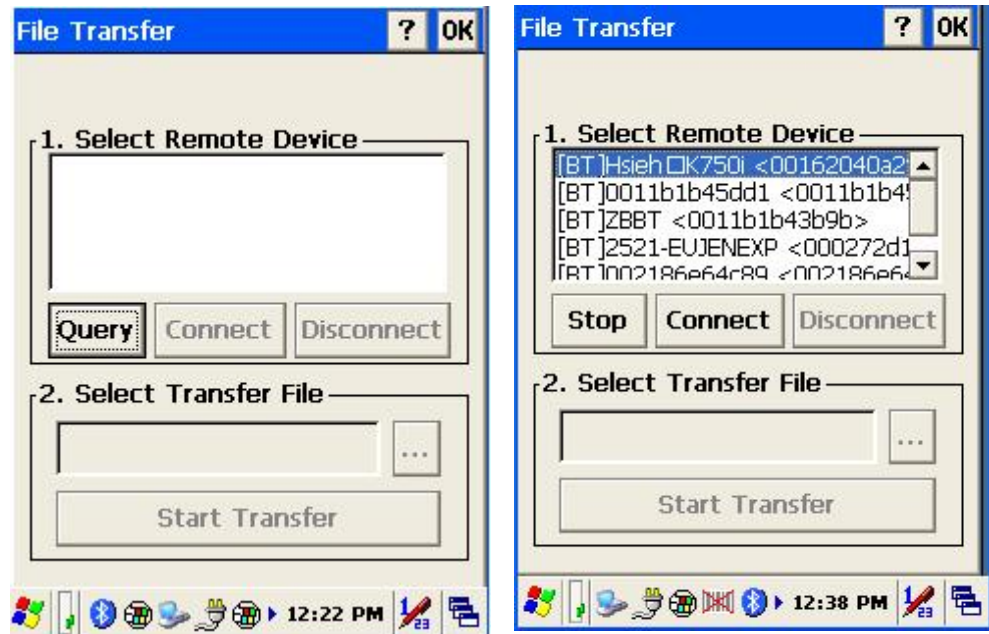

- 1.2 Select Bluetooth devices for receiving file, select “**Connect**” for connecting with devices, or select “**Disconnect**” to disconnect with current devices.

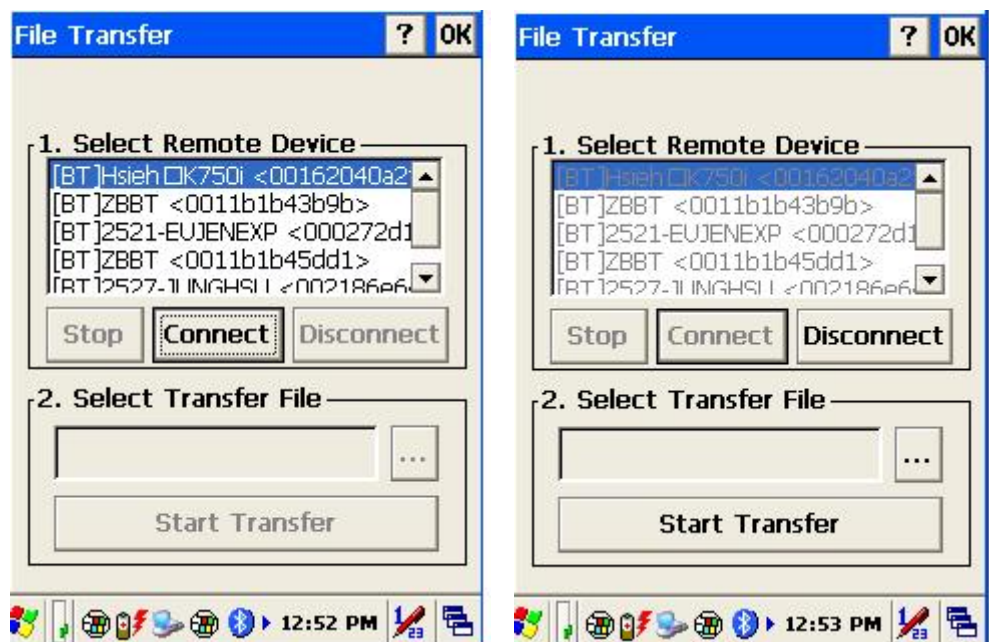

- 1.3 Click " ... " bottom to select the file need to be transferred, then click " OK " bottom to confirm.

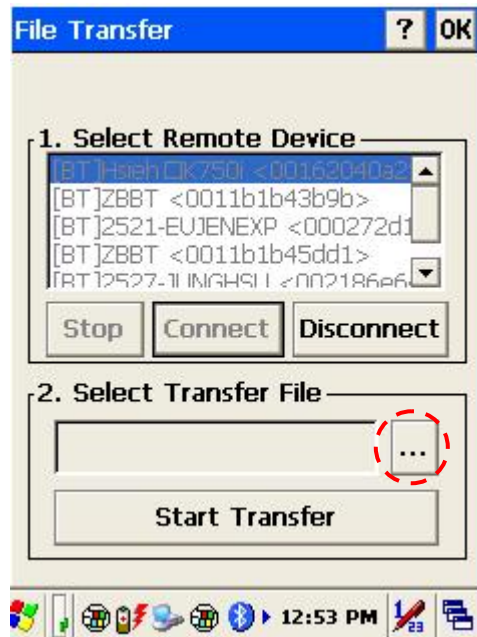

- 1.4 Select " Start Transfer " bottom to start file transferring.

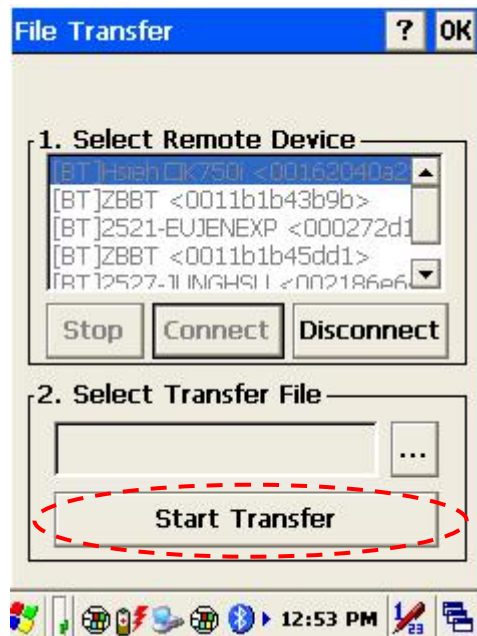

Preload Manager

The Preload Manager is an auto execution program for ZEBEX's WinCE device. You may set programs into the Preload list box and running the program by automatically or manually.

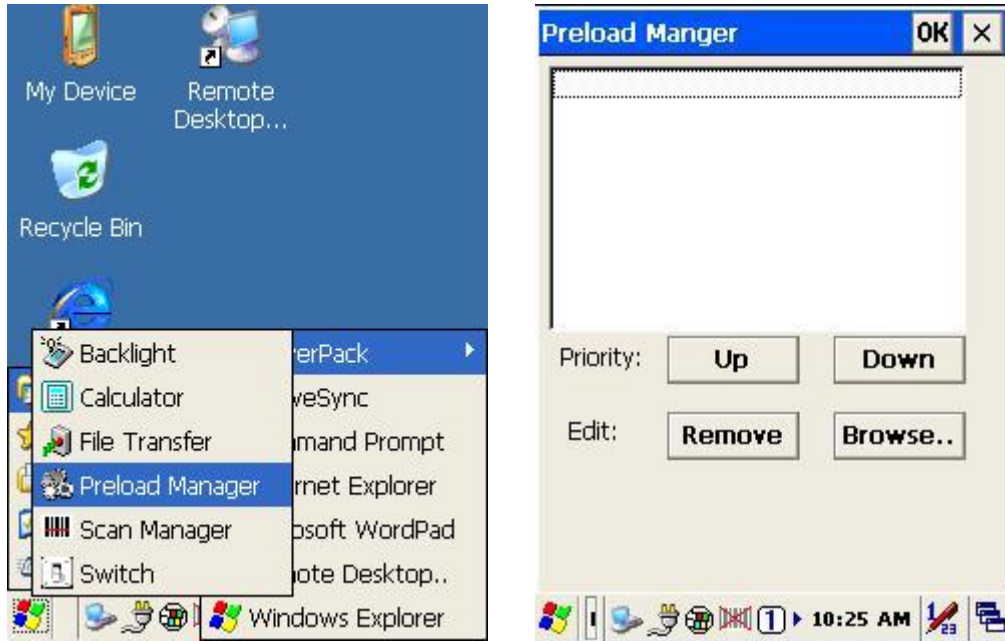

1. Modify Window located on top of display, providing functionalities of Priority, Remove and Browse.
2. Priority : Providing “UP ”and “DOWN ” two bottoms for adjusting priority on the lists.
3. Edit : Providing ”Remove “ 與 “Browse..” two functionalities , below are instructions:
Remove : Deleting selected functionalities.
Browse. : Selecting program for preloading, files can be selected from window by clicking Browse bottoms.

Preload Operation

1. Selected Program :

1.1 By clicking "Browse.." , Below menu will appear, select preload program by using folder. Programs can be selected more than once.

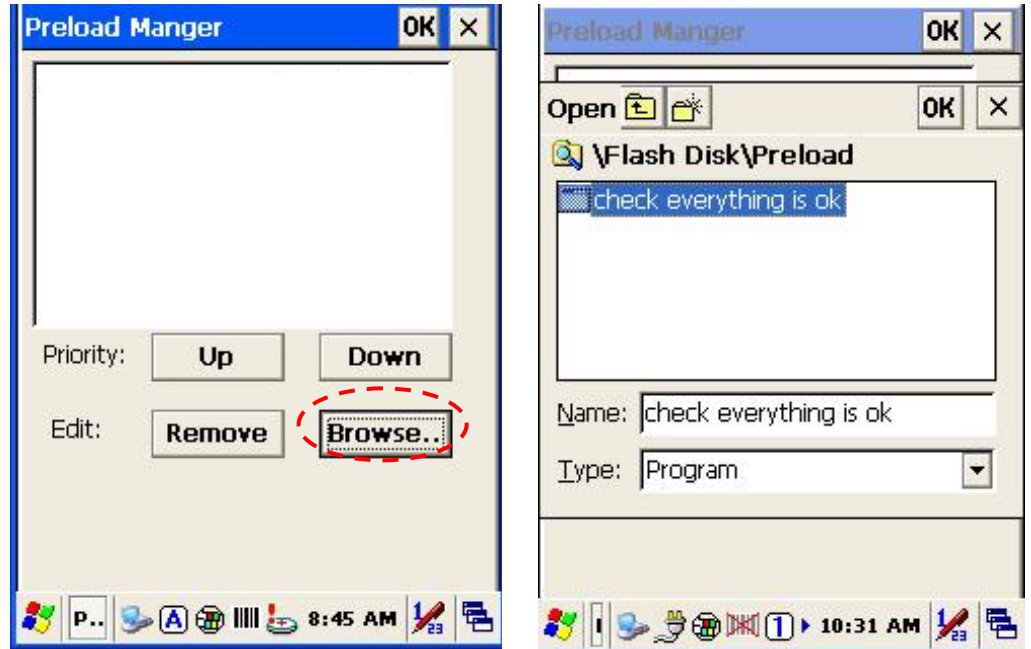

Confirming file by clicking "OK" will get back to Preload Manager main page. Then complete its process.

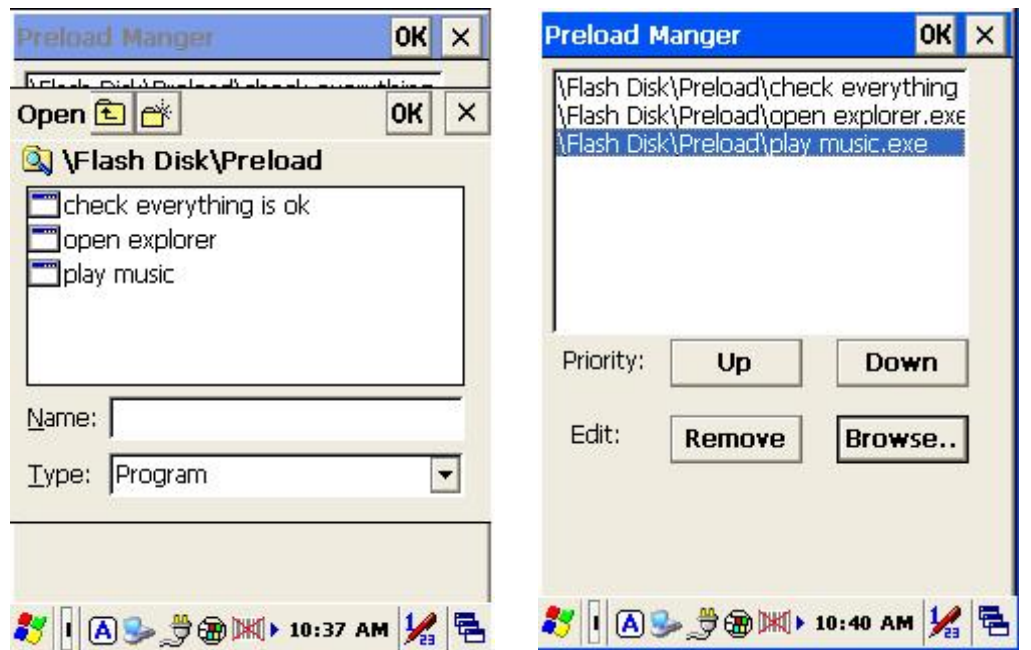

2. Reset preload priority:

If the preload priority need to be set up as below :

(1)play music -> (2)open explorer -> (3)check everything

Follow steps listed below :

2.1 Select by clicking play music.exe program and click” **Up** ” bottom, Therefore, play music.exe will be shifted up.

2.2 Then select by clicking check everything program and click “**Down**” bottom. Therefore, check everything program will be shifted down.

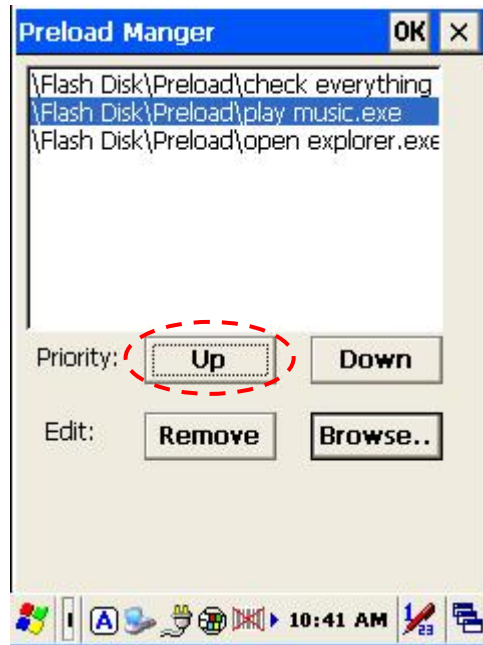

3. Remove a program:

In order to remove “open explorer” program, select by clicking program, then select “Remove” by clicking on bottom to finish command.

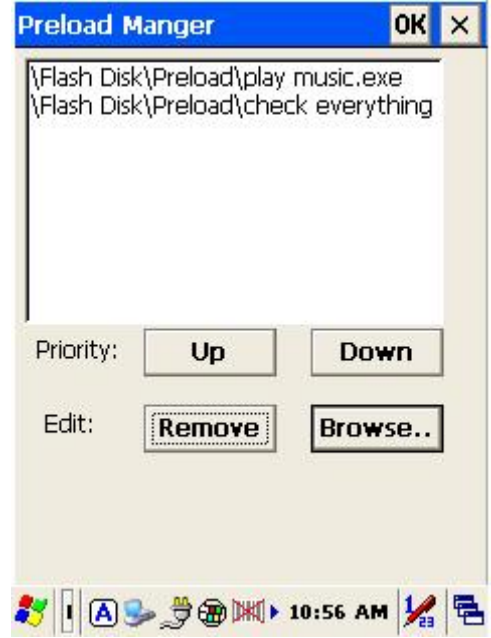
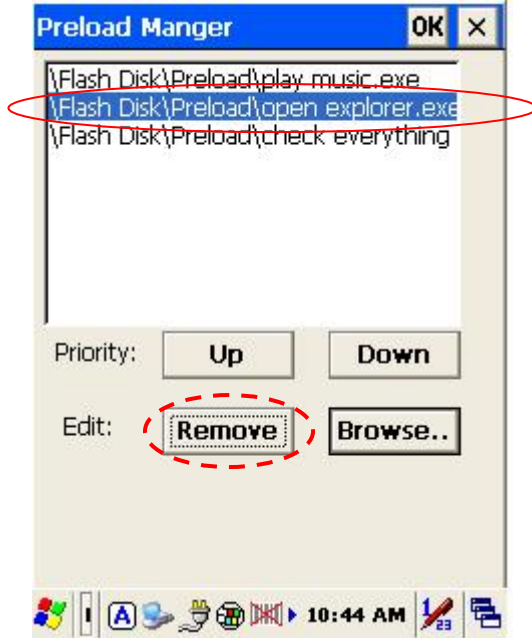

Switch

The WiFi & Bluetooth switch utility. This application provides as a switch function to let you easy turn on or off the function and power for WiFi and Bluetooth interface.



Under the content of "Profile", the available wireless network access point will be searching by clicking "Scan" button. You can select an access point and press "Configure" button to connect with that network.

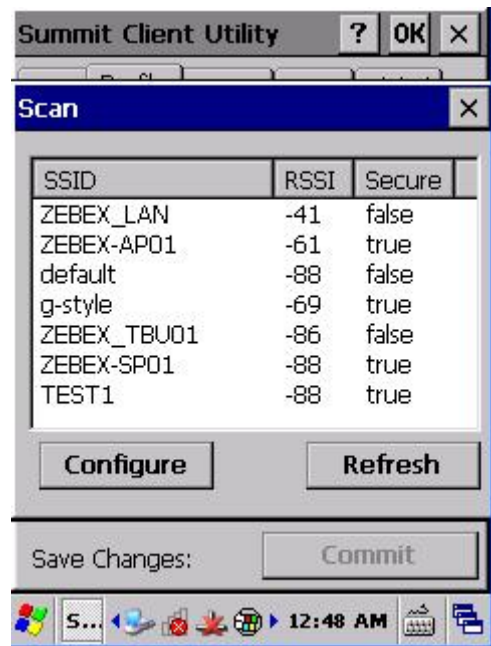
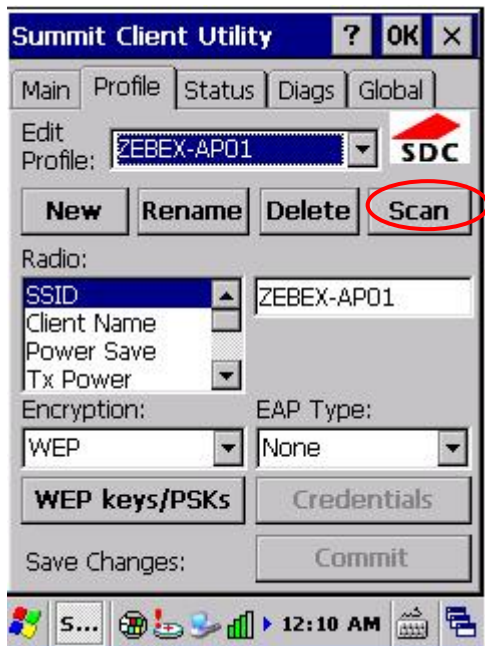

Existing access point can also be selected from Edit Profile shown as below diagram.



Under content of main menu, existing profile (WiFi) can be set up as Auto Profile. Existing Profile lists can be viewed existing profile by clicking “**List**” button, check profile and click on “**OK**” button. Select “On” from Auto Profile menu to complete Auto Profile setting.



TrayScan

The TrayScan program is a barcode reader set up program, it offer you an easy way to enable or disable the barcode scanner, and also offer you to set up each barcode symbolic properties.

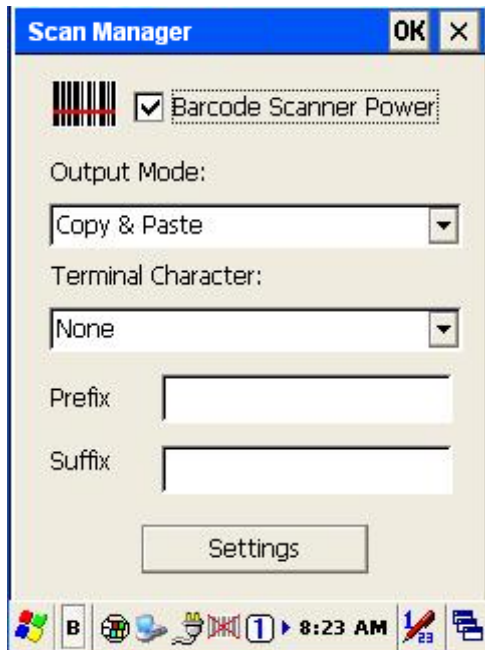

Below are instructions of functions on main page:

1. Output Mode

Providing three output methods such as Copy & Paste / Key Emulation / None (Copy to Clipboard).

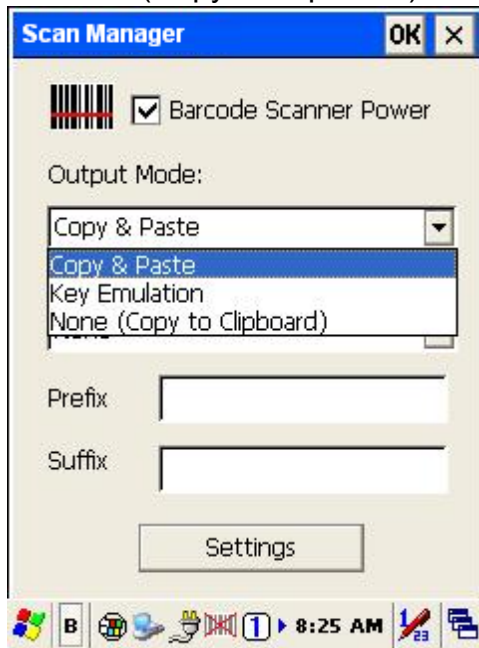

1.1 Copy & Paste

Copy and paste the barcode information into application that need to execute data as input. (ex. WordPad) ,

1.2 Key Emulation

Transfer barcode information via Key Emulation to executed software's edit window. Key Emulation function can also be used for barcode scanning under conditions of Terminal Emulation, Command Promp and some other program without touch panel. Read data will be transferred to application program.

1.3 None(copy to clipboard)

Function provide required barcode information to application program, after this function was activated, scanner will read barcode information and save data into clipboard.

2. Terminal Character

Set the terminator control code with barcode data. We offer "Enter", "Space", "Tab", and "None" for selections. Terminator control code will be sent every time when barcode was read.

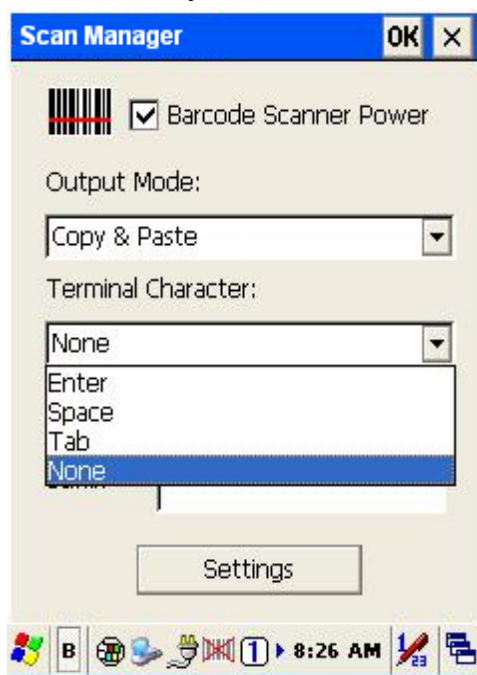

3. Suffix

Set the suffix character with barcode data.

4. Prefix

Set the preamble character with barcode data.

5. Setting

To set the barcode parameter value of each kind of barcode for barcode scanner. Press the " Setting " button in TrayScan application to start the barcode setting.

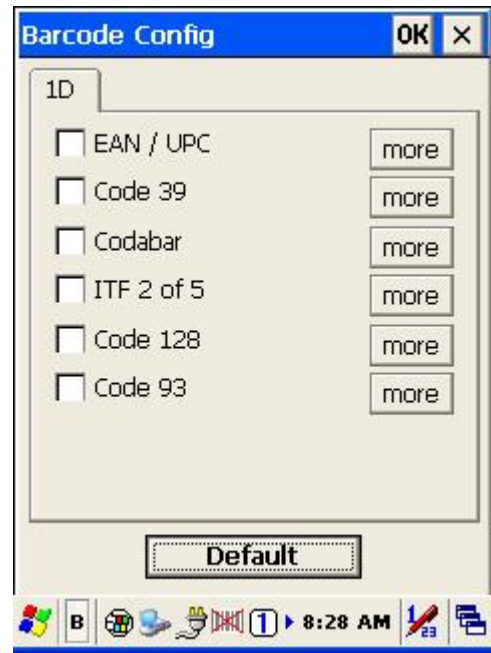
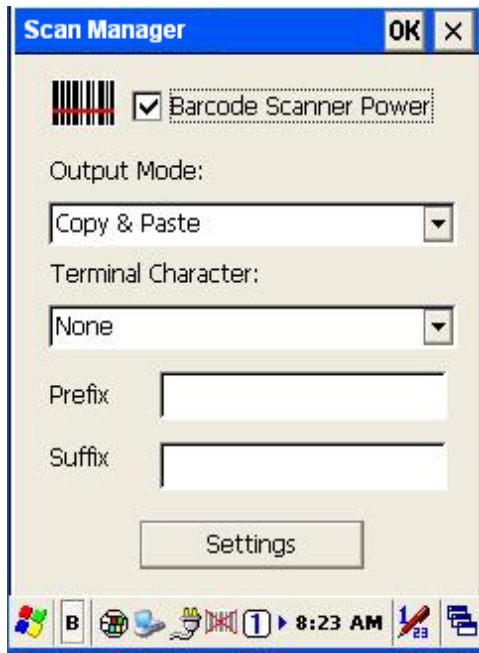

To check the barcode type selection for enable the type of barcode for read.

Press " **more** " button to setting the barcode parameter value of each kind of barcode.

Press " **Default** "button to use system default value to set up the barcode parameter. The default value was show in below pictures.

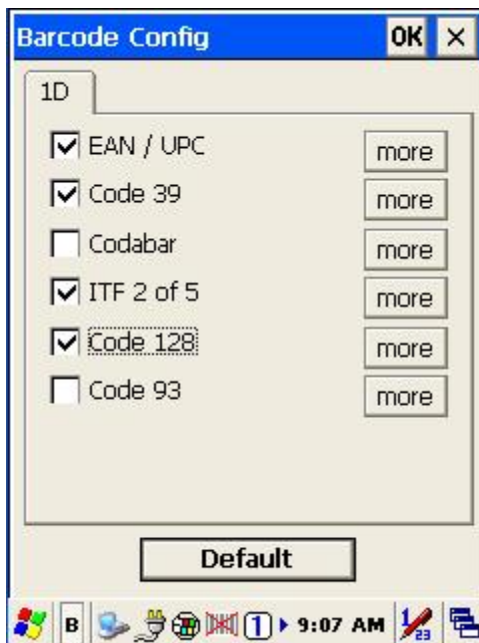

The default values of EAN/UPC code and Code39.

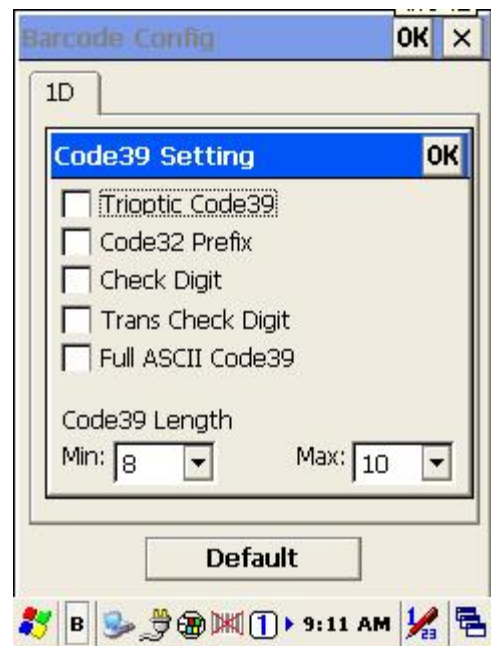
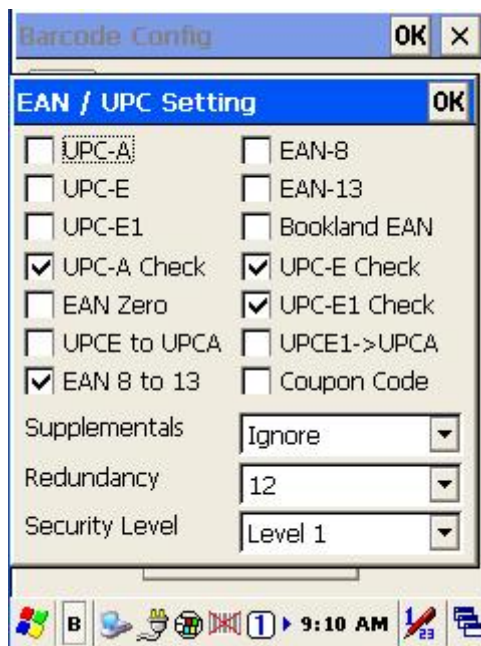

The default values of ITF 2 of 5 code and Code128.

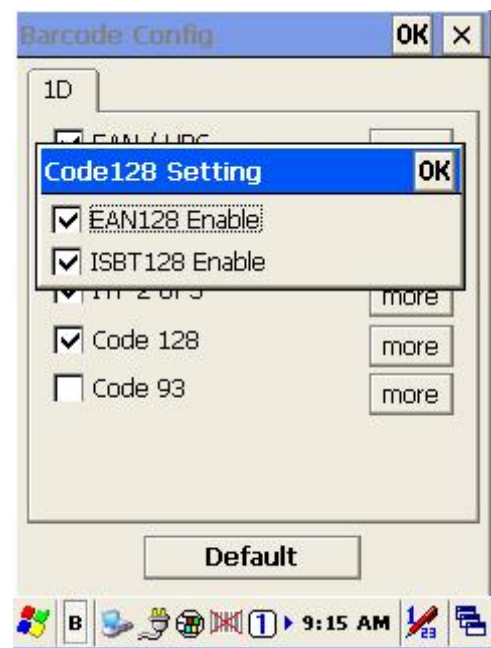
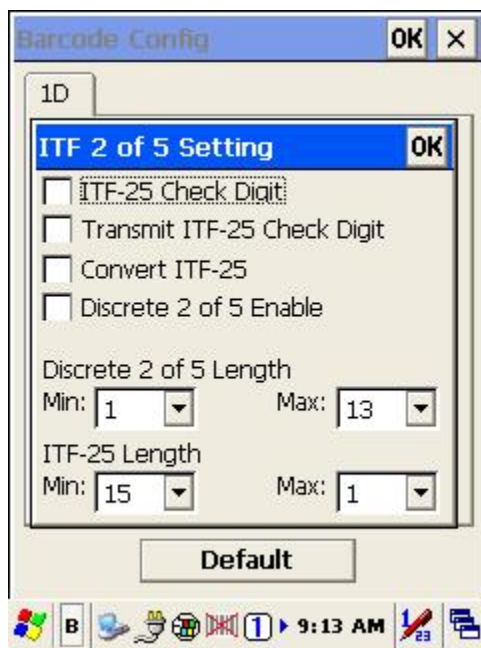

Backup/Restore

You can find this application is located on path “\settings\control Panel”.

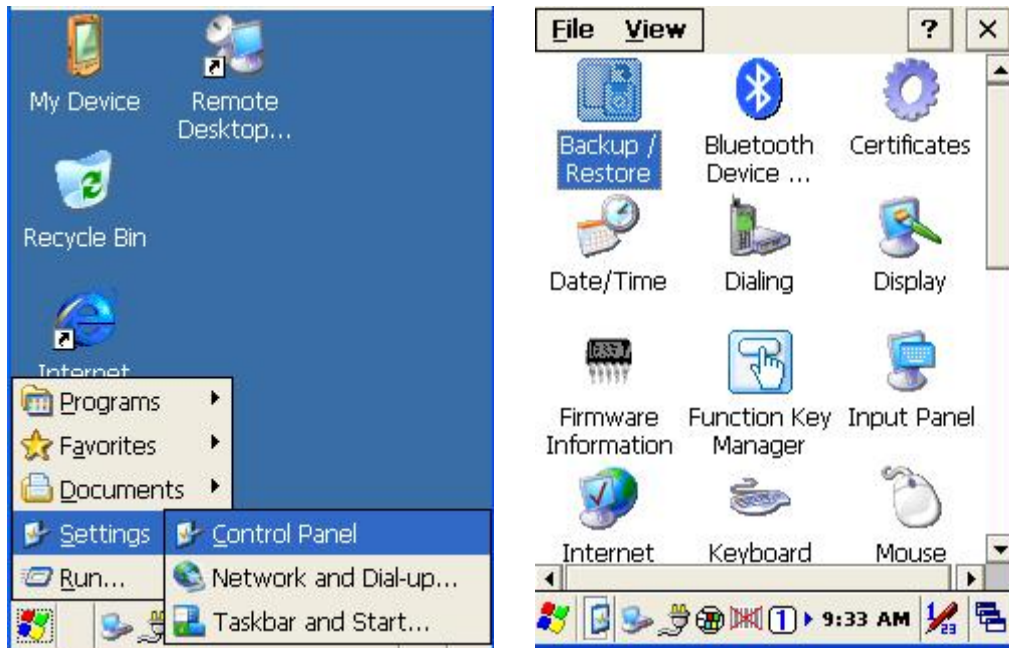

This application provides you an easy way to backup or restore the device setting information into Flash Disk and storage card. Application also provides selection of Flash Disk when there is no storage card. When Mini SD Card was installed into devices, program will auto-search and provides selection of SD Card from menu.



Backup : Select backup data as saved devices, press ” **Backup** ” bottom to proceed backup. Display will restore when backup was finished.

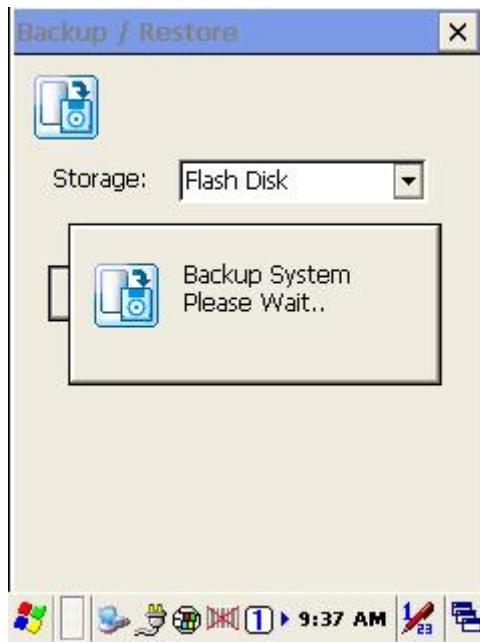

Firmware Information

This application will check and display the version information of the device's operation system and PowerPack utility.

You can find this application is located on path " \settings\control Panel\".

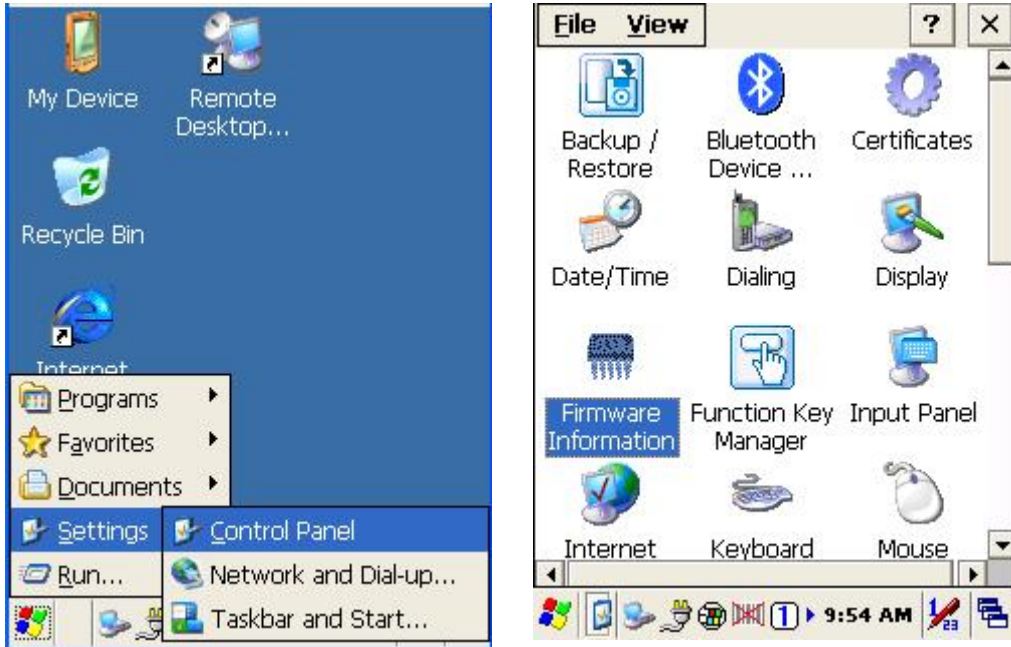

This information is good for identify device firmware version for future update or maintenance.

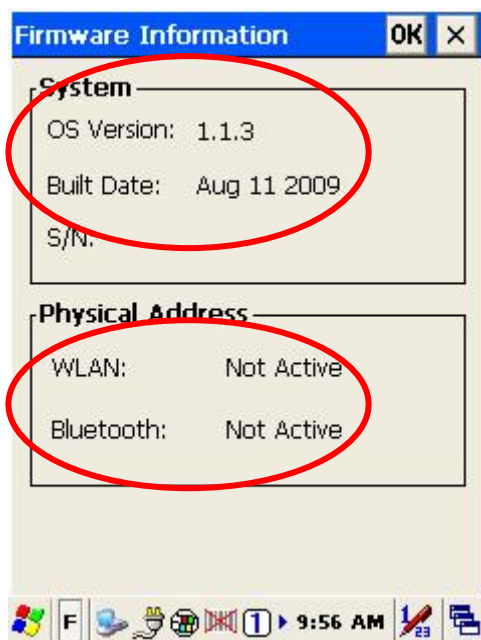

Function Key Manager

This application utility provides you an easier way to set up function key for your device. Through using this function key set up utility you will easily and quickly to start the application program like, Window Media Player, Calculator... etc, or your own designed application program, and even the windows system function, like increasing or decreasing the volume or doing the adjustment of brightness on LCD panel.

You can find this application is located on path “\settings\control Panel”.

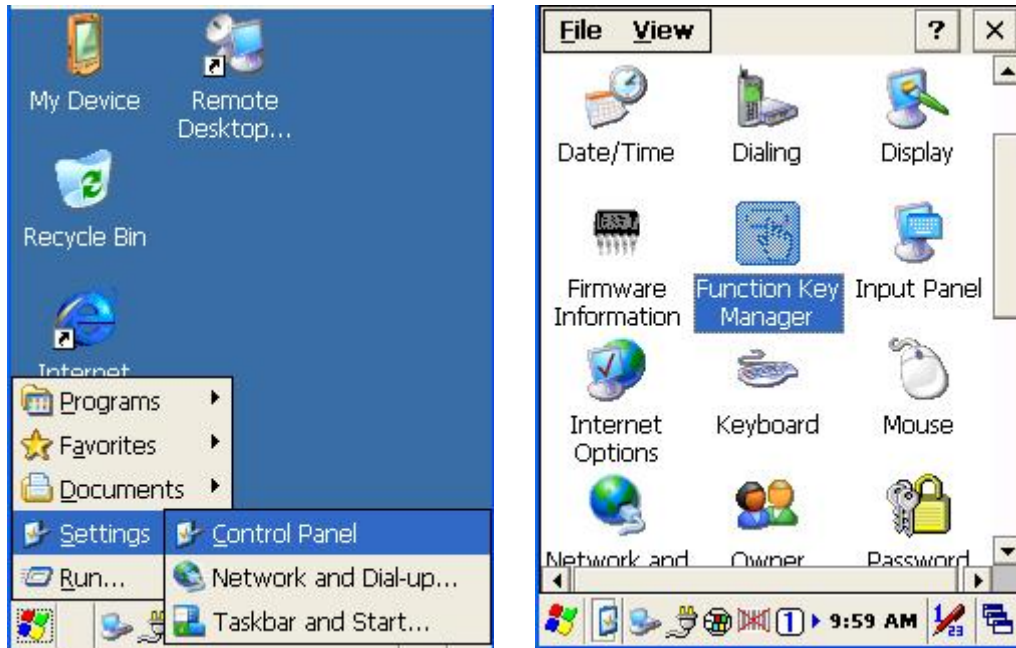

Program provides eight different function key (F1~F8) for set up, default setting was shown as below:

- F1: SIP ON/OFF ◦
- F2: Backlight Manager ◦
- F3: Power Switch ◦
- F4: Calculator.exe ◦
- F5: Volume + ◦
- F6: Volume - ◦
- F7: Backlight + ◦
- F8: Backlight - ◦

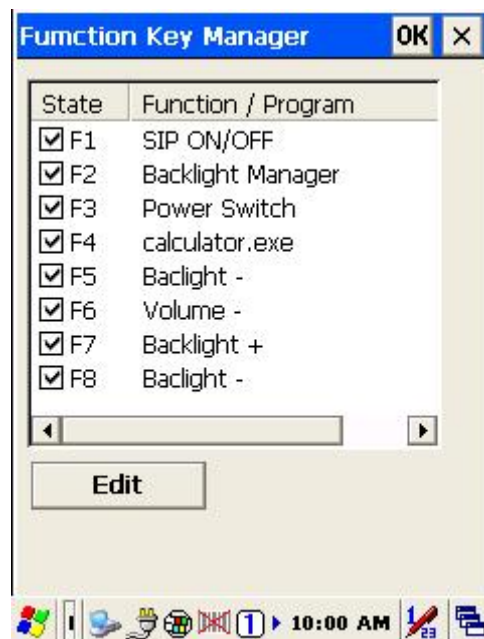

Function Key Manager Set Up Instruction:

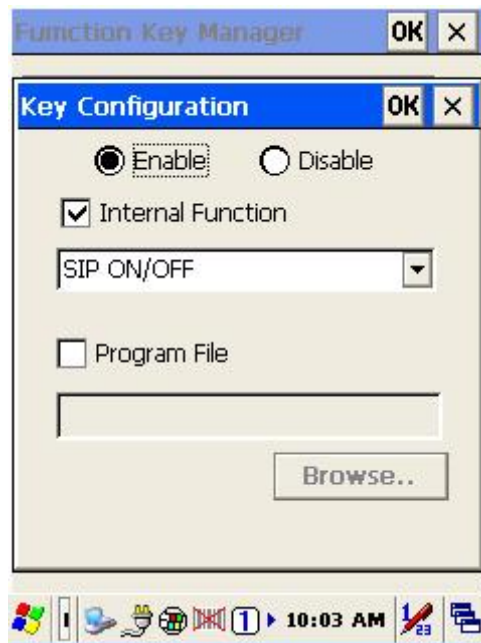

Enable/ Disable : Enable or Disable Function Key

Provide two set up methods of Internal Function and Program File

Internal Function : Provide following options,

- SIP ON/OFF
- Backlight Manager
- Power Switch
- Stylus Calibration
- Wi-Fi ON/OFF
- Bluetooth ON/OFF
- Volume +
- Volume -
- Backlight +
- Backlight -
- Cut
- Copy
- Paste

Program File : Install application program according to demand, this function can be used for setting up auto-execution.

1. Edit Internal Function items :

1.1 Select items need to be modified, select by clicking " **Edit** " bottom to enter set up window as below:

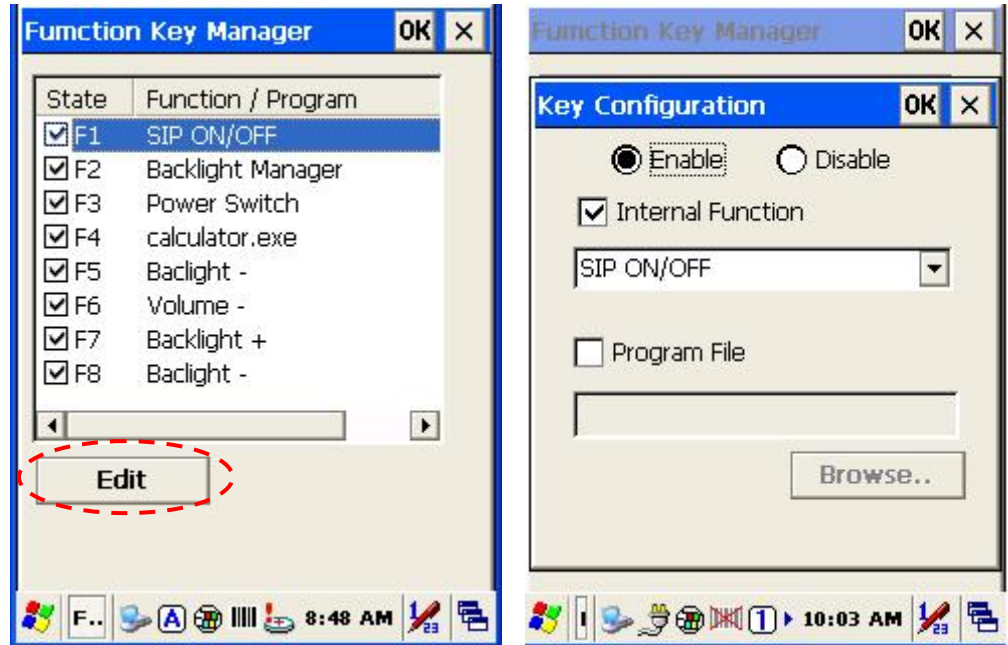

1.2 Select new functional item and complete editing.

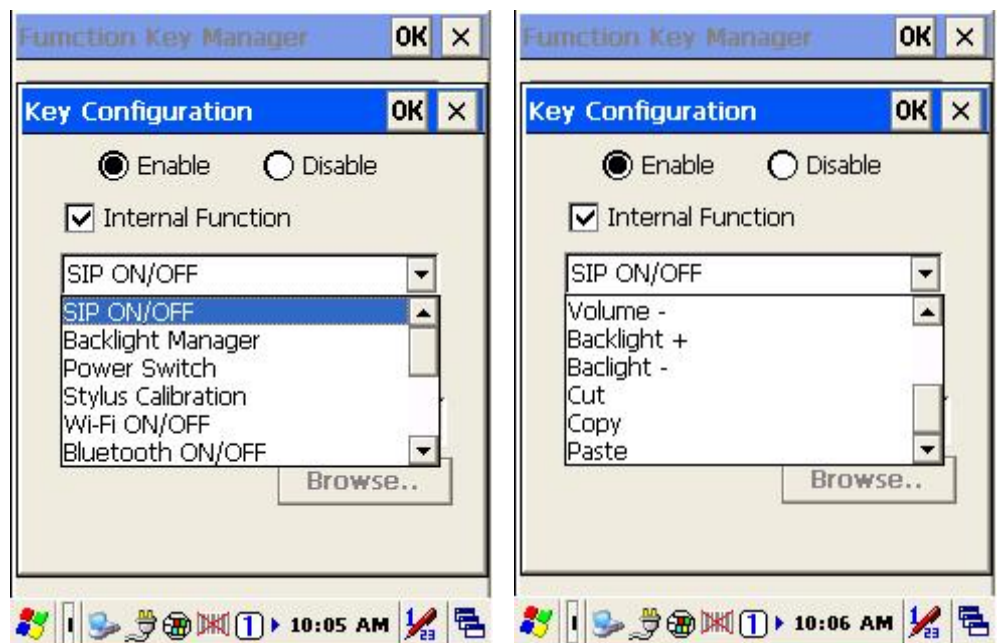

2. Edit application software for auto-execution :

2.1 Select Program File item , then click ” **Browse** ” bottom to enter File Opening Window.

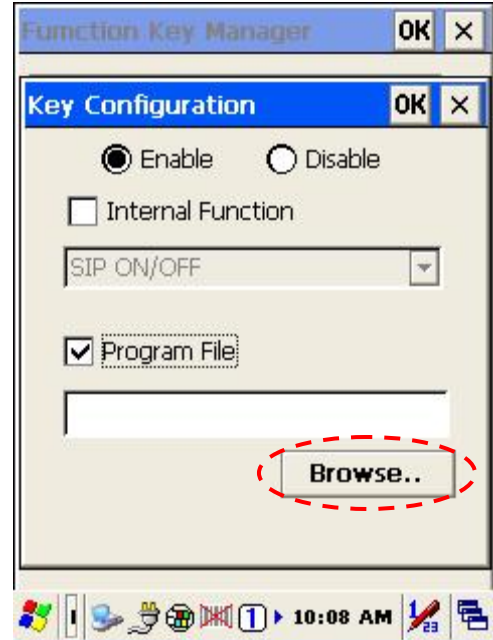
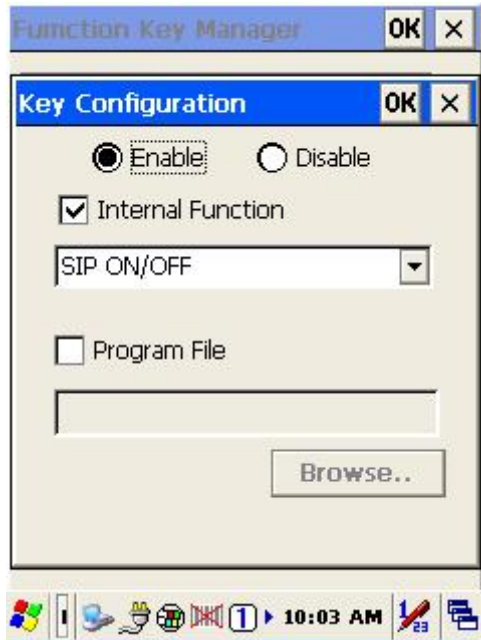

2.2 Select software required auto-execution, then select ” **OK** ” bottom to complete selecting process.



2.3 Confirmed Function / Program had been updated within column. Select by clicking " **OK** " bottom to complete editing process. When Function Key Manager Main Page reappear on the display, F1 on function key item lists had been updated to testkeypadChar.

