



FCC 47 CFR PART 15 SUBPART C

TEST REPORT

For

Handheld Computer

Model: Z-217x (x: 0~9)

Trade Name: ZEBEX

Issued to

ZEBEX INDUSTRIES INC
B1-1, No. 207, Sec. 3, Beisin Road, Sindian-Tien City Taiwan

Issued by

Compliance Certification Services Inc.
No.11, Wu-Gong 6th Rd., Wugu Industrial Park,
New Taipei City 248, Taiwan (R.O.C.)
<http://www.ccsrf.com>
service@ccsrf.com

Issued Date: February 24, 2012



Note: This report shall not be reproduced except in full, without the written approval of Compliance Certification Services Inc. This document may be altered or revised by Compliance Certification Services Inc. personnel only, and shall be noted in the revision section of the document.



Revision History

Rev.	Issue Date	Revisions	Effect Page	Revised By
00	February 24, 2012	Initial Issue	ALL	Eunice Shen



TABLE OF CONTENTS

1. TEST RESULT CERTIFICATION.....	4
2. EUT DESCRIPTION	5
3. TEST METHODOLOGY	6
3.1 EUT CONFIGURATION	6
3.2 EUT EXERCISE.....	6
3.3 GENERAL TEST PROCEDURES.....	6
3.4 FCC PART 15.205 RESTRICTED BANDS OF OPERATIONS.....	7
3.5 DESCRIPTION OF TEST MODES	8
4. INSTRUMENT CALIBRATION.....	9
4.1 MEASURING INSTRUMENT CALIBRATION	9
4.2 MEASUREMENT EQUIPMENT USED	9
4.3 MEASUREMENT UNCERTAINTY	10
5. FACILITIES AND ACCREDITATIONS	11
5.1 FACILITIES	11
5.2 EQUIPMENT.....	11
5.3 TABLE OF ACCREDITATIONS AND LISTINGS.....	12
6. SETUP OF EQUIPMENT UNDER TEST	13
6.1 SETUP CONFIGURATION OF EUT.....	13
6.2 SUPPORT EQUIPMENT	13
7. FCC PART 15.247 REQUIREMENTS.....	14
7.1 20 DB BANDWIDTH.....	14
7.2 PEAK POWER.....	18
7.3 BAND EDGES MEASUREMENT	19
7.4 FREQUENCY SEPARATION.....	29
7.5 NUMBER OF HOPPING FREQUENCY.....	32
7.6 TIME OF OCCUPANCY (DWELL TIME)	35
7.7 SPURIOUS EMISSIONS	39
7.8 POWERLINE CONDUCTED EMISSIONS.....	51
APPENDIX I RADIO FREQUENCY EXPOSURE.....	54
APPENDIX II PHOTOGRAPHS OF TEST SETUP	55



1. TEST RESULT CERTIFICATION

Applicant: ZEBEX INDUSTRIES INC.
 B1-1, No. 207, Sec. 3, Beisin Road, Sindian-Tien City Taiwan

Equipment Under Test: Handheld Computer

Trade Name: ZEBEX

Model: Z-217x (x: 0~9)

Date of Test: January 19, 2012

APPLICABLE STANDARDS	
STANDARD	TEST RESULT
FCC 47 CFR Part 15 Subpart C	No non-compliance noted

We hereby certify that:

The above equipment was tested by Compliance Certification Services Inc. The test data, data evaluation, test procedures, and equipment configurations shown in this report were made in accordance with the procedures given in **ANSI C63.4: 2003** and the energy emitted by the sample EUT tested as described in this report is in compliance with the requirements of FCC Rules Part 15.207, 15.209, 15.247.

The test results of this report relate only to the tested sample EUT identified in this report.

Approved by:

Reviewed by:

Jason Lin
 Section Manager
 Compliance Certification Services Inc.

Gina Lo
 Section Manager
 Compliance Certification Services Inc.



2. EUT DESCRIPTION

Product	Handheld Computer
Brand Name	ZEBEX
Model	Z-217x (x: 0~9)
Model Discrepancy	All the specification and layout are identical except they come with different model numbers for marketing purposes.
Received Date	February 24, 2012
Power Supply	A) Power from Power Adapter Powertron Electronics Corp. / PA1015-1SI I/P: 100-240V, 50-60Hz, 0.4A O/P: 5V, 2A B) Power from Battery Model: ZEBEX Z-2050 Rating: 3.7V, 2200mAh
Frequency Range	2402 ~ 2480 MHz
Transmit Power	2.25 dBm
Modulation Technique	FHSS (GFSK)
Transmit Data Rate	1Mbps
Number of Channels	79 Channels
Antenna Specification	Gain: 2dBi
Antenna Designation	Chip Antenna

Remark:

1. The sample selected for test was production product and was provided by manufacturer.
2. This submittal(s) (test report) is intended for FCC ID: **JNF-Z-217X** filing to comply with Section 15.207, 15.209 and 15.247 of the FCC Part 15, Subpart C Rules.
3. Test method of measurement according to FCC's Public Notice DA 00-705.



3. TEST METHODOLOGY

The tests documented in this report were performed in accordance with ANSI C63.4: 2003 and FCC CFR 47 Part 15.207, 15.209 and 15.247.

3.1 EUT CONFIGURATION

The EUT configuration for testing is installed on RF field strength measurement to meet the Commissions requirement and operating in a manner that intends to maximize its emission characteristics in a continuous normal application.

3.2 EUT EXERCISE

The EUT was operated in the engineering mode to fix the TX frequency that was for the purpose of the measurements.

According to its specifications, the EUT must comply with the requirements of the Section 15.207, 15.209 and 15.247 under the FCC Rules Part 15 Subpart C.

3.3 GENERAL TEST PROCEDURES

Conducted Emissions

The EUT is placed on the turntable, which is 0.8 m above ground plane. According to the requirements in Section 13.1.4.1 of ANSI C63.4: 2003 Conducted emissions from the EUT measured in the frequency range between 0.15 MHz and 30MHz using CISPR Quasi-peak and average detector modes.

Radiated Emissions

The EUT is placed on a turn table, which is 0.8 m above ground plane. The turntable shall rotate 360 degrees to determine the position of maximum emission level. EUT is set 3m away from the receiving antenna, which varied from 1m to 4m to find out the highest emission. And also, each emission was to be maximized by changing the polarization of receiving antenna both horizontal and vertical. In order to find out the maximum emissions, exploratory radiated emission measurements were made according to the requirements in Section 13.1.4.1 of ANSI C63.4: 2003.



3.4 FCC PART 15.205 RESTRICTED BANDS OF OPERATIONS

(a) Except as shown in paragraph (d) of this section, only spurious emissions are permitted in any of the frequency bands listed below:

MHz	MHz	MHz	GHz
0.090 - 0.110	16.42 - 16.423	399.9 - 410	4.5 - 5.15
¹ 0.495 - 0.505	16.69475 - 16.69525	608 - 614	5.35 - 5.46
2.1735 - 2.1905	16.80425 - 16.80475	960 - 1240	7.25 - 7.75
4.125 - 4.128	25.5 - 25.67	1300 - 1427	8.025 - 8.5
4.17725 - 4.17775	37.5 - 38.25	1435 - 1626.5	9.0 - 9.2
4.20725 - 4.20775	73 - 74.6	1645.5 - 1646.5	9.3 - 9.5
6.215 - 6.218	74.8 - 75.2	1660 - 1710	10.6 - 12.7
6.26775 - 6.26825	108 - 121.94	1718.8 - 1722.2	13.25 - 13.4
6.31175 - 6.31225	123 - 138	2200 - 2300	14.47 - 14.5
8.291 - 8.294	149.9 - 150.05	2310 - 2390	15.35 - 16.2
8.362 - 8.366	156.52475 -	2483.5 - 2500	17.7 - 21.4
8.37625 - 8.38675	156.52525	2655 - 2900	22.01 - 23.12
8.41425 - 8.41475	156.7 - 156.9	3260 - 3267	23.6 - 24.0
12.29 - 12.293	162.0125 - 167.17	3332 - 3339	31.2 - 31.8
12.51975 - 12.52025	167.72 - 173.2	3345.8 - 3358	36.43 - 36.5
12.57675 - 12.57725	240 - 285	3600 - 4400	(²)
13.36 - 13.41	322 - 335.4		

¹ Until February 1, 1999, this restricted band shall be 0.490-0.510 MHz.

² Above 38.6

(b) Except as provided in paragraphs (d) and (e), the field strength of emissions appearing within these frequency bands shall not exceed the limits shown in Section 15.209. At frequencies equal to or less than 1000 MHz, compliance with the limits in Section 15.209 shall be demonstrated using measurement instrumentation employing a CISPR quasi-peak detector. Above 1000 MHz, compliance with the emission limits in Section 15.209 shall be demonstrated based on the average value of the measured emissions. The provisions in Section 15.35 apply to these measurements.



3.5 DESCRIPTION OF TEST MODES

The EUT (model: Z-2170) had been tested under operating condition.

Software used to control the EUT for staying in continuous transmitting mode was programmed.

After verification, all tests were carried out with the worst case test modes as shown below except radiated spurious emission below 1GHz and power line conducted emissions below 30MHz, which worst case was in normal link mode only.

Channel Low (2402MHz), Mid (2441MHz) and High (2480MHz) with 1Mbps data rate was chosen for full testing.

The field strength of spurious emission was measured in the following position: EUT stand-up position (Z axis), lie-down position (X, Y axis). The worst emission was found in lie-down position (X axis) and the worst case was recorded.



4. INSTRUMENT CALIBRATION

4.1 MEASURING INSTRUMENT CALIBRATION

The measuring equipment, which was utilized in performing the tests documented herein, has been calibrated in accordance with the manufacturer's recommendations for utilizing calibration equipment, which is traceable to recognized national standards.

4.2 MEASUREMENT EQUIPMENT USED

Equipment Used for Emissions Measurement

Remark: Each piece of equipment is scheduled for calibration once a year and Loop Antenna is scheduled for calibration once three years.

Conducted Emissions Test Site				
Name of Equipment	Manufacturer	Model	Serial Number	Calibration Due
Spectrum Analyzer	Agilent	E4446A	MY43360131	03/17/2012
Power Meter	Anritsu	ML2495A	1012009	04/27/2012
Power Sensor	Anritsu	MA2411B	0917072	04/27/2012

Wugu 966 Chamber A				
Name of Equipment	Manufacturer	Model	Serial Number	Calibration Due
Spectrum Analyzer	Agilent	E4446A	US42510252	11/02/2012
EMI Test Receiver	R&S	ESCI	100064	02/16/2013
Pre-Amplifier	Mini-Circuits	ZFL-1000LN	SF350700823	01/12/2013
Pre-Amplifier	MITEQ	AFS44-00102650-42-10P-44	1415367	11/19/2012
Bilog Antenna	Sunol Sciences	JB3	A030105	10/03/2012
Horn Antenna	EMCO	3117	00055165	01/11/2013
Horn Antenna	EMCO	3116	00026370	10/12/2012
Loop Antenna	EMCO	6502	8905/2356	06/10/2013
Turn Table	CCS	CC-T-1F	N/A	N.C.R
Antenna Tower	CCS	CC-A-1F	N/A	N.C.R
Controller	CCS	CC-C-1F	N/A	N.C.R
Site NSA	CCS	N/A	N/A	12/25/2012
Test S/W	EZ-EMC (CCS-3A1RE)			

Conducted Emission room # B				
Name of Equipment	Manufacturer	Model	Serial Number	Calibration Due
TEST RECEIVER	R&S	ESCI	100234	06/13/2012
LISN (EUT)	FCC	FCC-LISN-50-32-2	08009	03/27/2012
LISN	SCHWARZBECK	NSLK 8127	8127382	01/02/2013
BNC CABLE	MIYAZAKI	5D-FB	BNC B3	08/07/2012
Pulse Limiter	R&S	ESH3-Z2	100374	01/08/2013
THERMO-HYGRO METER	WISEWIND	201A	1006	05/23/2012
Test S/W	EZ-EMC			



4.3 MEASUREMENT UNCERTAINTY

PARAMETER	UNCERTAINTY
Powerline Conducted Emission	+/- 1.1089
3M Semi Anechoic Chamber / 30M~200M	+/- 4.0138
3M Semi Anechoic Chamber / 200M~1000M	+/- 3.9483
3M Semi Anechoic Chamber / 1G~8G	+/- 2.5975
3M Semi Anechoic Chamber / 8G~18G	+/- 2.6112
3M Semi Anechoic Chamber / 18G~26G	+/- 2.7389
3M Semi Anechoic Chamber / 26G~40G	+/- 2.9683

Remark: This uncertainty represents an expanded uncertainty expressed at approximately the 95% confidence level using a coverage factor of $k=2$.



5. FACILITIES AND ACCREDITATIONS

5.1 FACILITIES

All measurement facilities used to collect the measurement data are located at

No.199, Chungshen Road, Hsintien City, Taipei Hsien, Taiwan, R.O.C.

Tel: 886-2-2217-0894 / Fax: 886-2-2217-1029

*Remark: The Powerline Conducted Emissions was tested at Compliance Certification Services. (Hsintien Lab.)
The test equipments were listed in page 9 and the test data were recorded in page 52-53.*

No.11, Wu-Gong 6th Rd., Wugu Industrial Park, New Taipei City 248, Taiwan (R.O.C.)

Tel: 886-2-2299-9720 / Fax: 886-2-2298-4045

No.81-1, Lane 210, Bade 2nd Rd., Lujhu Township, Taoyuan County 33841, TAIWAN, R.O.C.

Tel: 886-3-324-0332 / Fax: 886-3-324-5235

The sites are constructed in conformance with the requirements of ANSI C63.7, ANSI C63.4 and CISPR Publication 22.

5.2 EQUIPMENT

Radiated emissions are measured with one or more of the following types of linearly polarized antennas: tuned dipole, biconical, log periodic, bi-log, and/or ridged waveguide, horn. Spectrum analyzers with pre-selectors and quasi-peak detectors are used to perform radiated measurements.



Conducted emissions are measured with Line Impedance Stabilization Networks and EMI Test Receivers.

Calibrated wideband preamplifiers, coaxial cables, and coaxial attenuators are also used for making measurements.

All receiving equipment conforms to CISPR Publication 16-1, "Radio Interference Measuring Apparatus and Measurement Methods."



5.3 TABLE OF ACCREDITATIONS AND LISTINGS

Country	Agency	Scope of Accreditation	Logo
USA	FCC	3M Semi Anechoic Chamber (FCC MRA: TW1039) to perform FCC Part 15 measurements	 FCC MRA: TW1039
Taiwan	TAF	LP0002, RTTE01, FCC Method-47 CFR Part 15 Subpart C, D, E, RSS-210, RSS-310 IDA TS SRD, AS/NZS 4268, AS/NZS 4771, TS 12.1 & 12.2, ETSI EN 300 440-1, ETSI EN 300 440-2, ETSI EN 300 328, ETSI EN 300 220-1, ETSI EN 300 220-2, ETSI EN 301 893, ETSI EN 301 489-1/3/7/17 FCC OET Bulletin 65 + Supplement C, EN 50360, EN 50361, EN 50371, RSS 102, EN 50383, EN 50385, EN 50392, IEC 62209, CNS 14958-1, CNS 14959 FCC Method -47 CFR Part 15 Subpart B IEC / EN 61000-3-2, IEC / EN 61000-3-3, IEC / EN 61000-4-2/3/4/5/6/8/11	
Canada	Industry Canada	3M Semi Anechoic Chamber (IC 2324G-1 / IC 2324G-2) to perform	 IC 2324G-1 IC 2324G-2

* No part of this report may be used to claim or imply product endorsement by A2LA or any agency of the US Government.



6. SETUP OF EQUIPMENT UNDER TEST

6.1 SETUP CONFIGURATION OF EUT

See test photographs attached in Appendix II for the actual connections between EUT and support equipment.

6.2 SUPPORT EQUIPMENT

No.	Equipment	Model No.	Serial No.	FCC ID / BSMI ID	Brand Name	Data Cable	Power Cord
1	Notebook PC	dv6-1332TX	CNF9491GPS	PD9112BNHU	HP	N/A	AC I/P: Unshielded, 1.8m DC O/P: Unshielded, 1.8m with a core
2	PS/2 Mouse	M071KC	443029438	DoC BSMI: R41108	DELL	Shielded, 1.8m	N/A
3	PS/2 Keyboard	SK-8110	N/A	DoC BSMI: T3A002	DELL	Shielded, 1.8m	N/A
4	Modem	AL-56ERM	0MERM04A0212	DoC	GALILEO	Shielded, 1.0m	Unshielded, 1.8m
5	Host PC	T3500	8X36VBX	DoC BSMI: R33002	DELL	Shielded, 1.8m	Unshielded, 1.8m
6	Monitor	933SN+	CM19HVKSB00002	DoC BSMI: R33475	SAMSUNG	Shielded, 1.8m with two cores	Unshielded, 1.8m
7.	Printer	Deskjet D2360	TH73C1492F	DoC BSMI: R33001	HP	Shielded, 1.8m	Unshielded, 1.8m
8.	Notebook PC (Remote)	PP19L	61G6Q1S	FCC DoC	DELL	N/A	AC I/P: Unshielded, 1.8m DC O/P: Unshielded, 1.8m with a core

Remark:

1. All the equipment/cables were placed in the worst-case configuration to maximize the emission during the test.
2. Grounding was established in accordance with the manufacturer's requirements and conditions for the intended use.



7. FCC PART 15.247 REQUIREMENTS

7.1 20 DB BANDWIDTH

LIMIT

None; for reporting purposes only.

Test Configuration

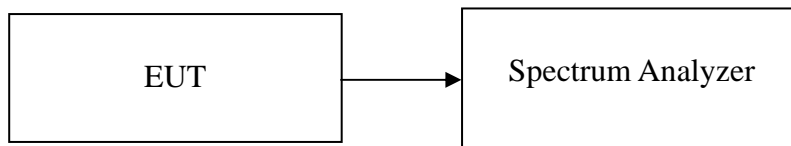

TEST PROCEDURE

1. Place the EUT on the table and set it in the transmitting mode.
2. Remove the antenna from the EUT and then connect a low loss RF cable from the antenna port to the spectrum analyzer.
3. Set the spectrum analyzer as RBW=30kHz, VBW = 100kHz, Span = 3MHz, Sweep = 3.2ms, Att = 10dB.
4. Mark the peak frequency and 20dB (upper and lower) frequency.
5. Repeat until all the rest channels are investigated.

TEST RESULTS

No non-compliance noted.

Test Data

Channel	Frequency (MHz)	20dB Bandwidth (MHz)
Low	2402	1.045
Mid	2441	1.04
High	2480	1.05



Test Plot

20dB Bandwidth (CH Low)

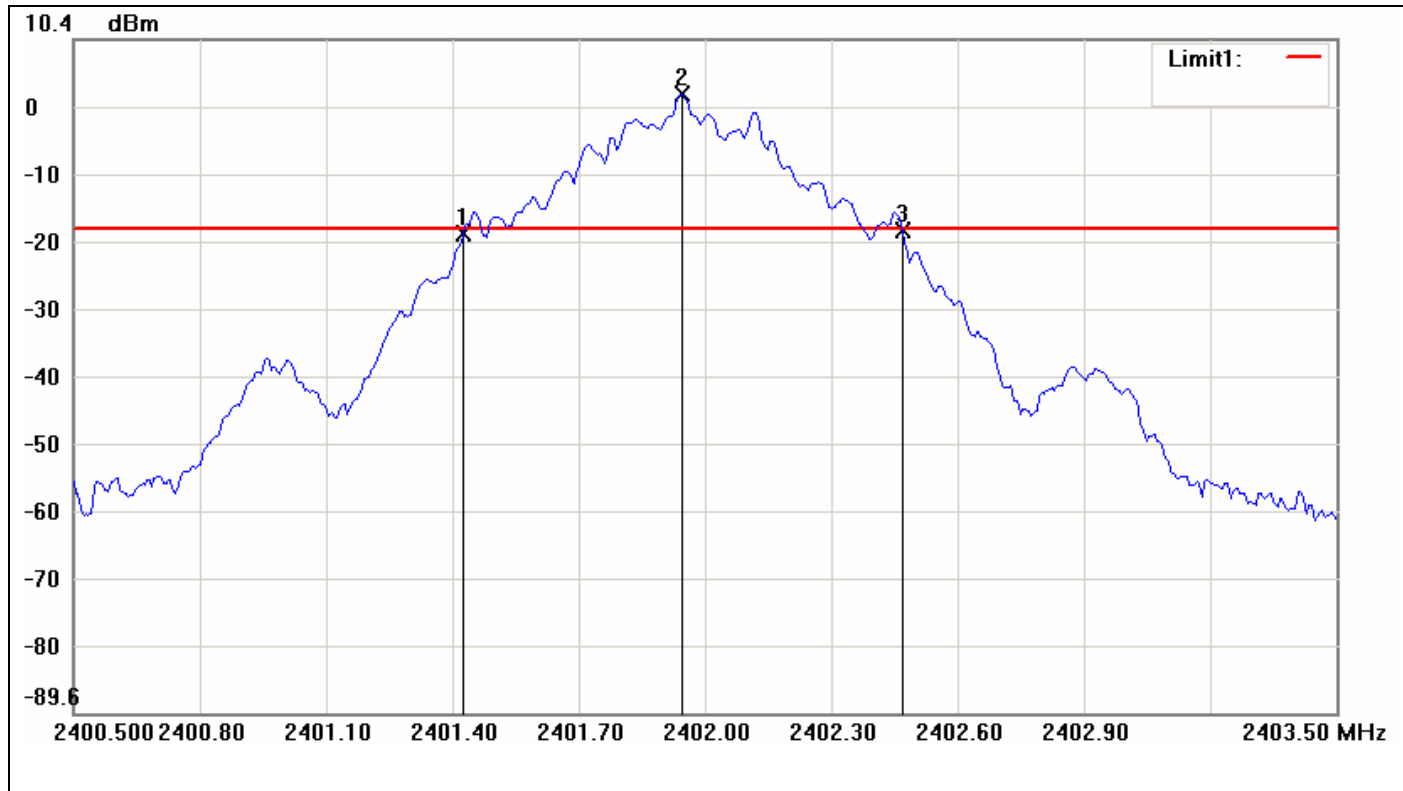

No.	Frequency(MHz)	Level(dBm)	Limit(dBm)	Margin(dBm)
1	2401.4250	-18.37	-17.72	-0.65
2	2401.9450	2.28	-17.72	20.00
3	2402.4700	-18.04	-17.72	-0.32

No.		Δ Frequency(MHz)	Δ Level(dB)
1	mk3-mk1	1.045	0.33



20dB Bandwidth (CH Mid)

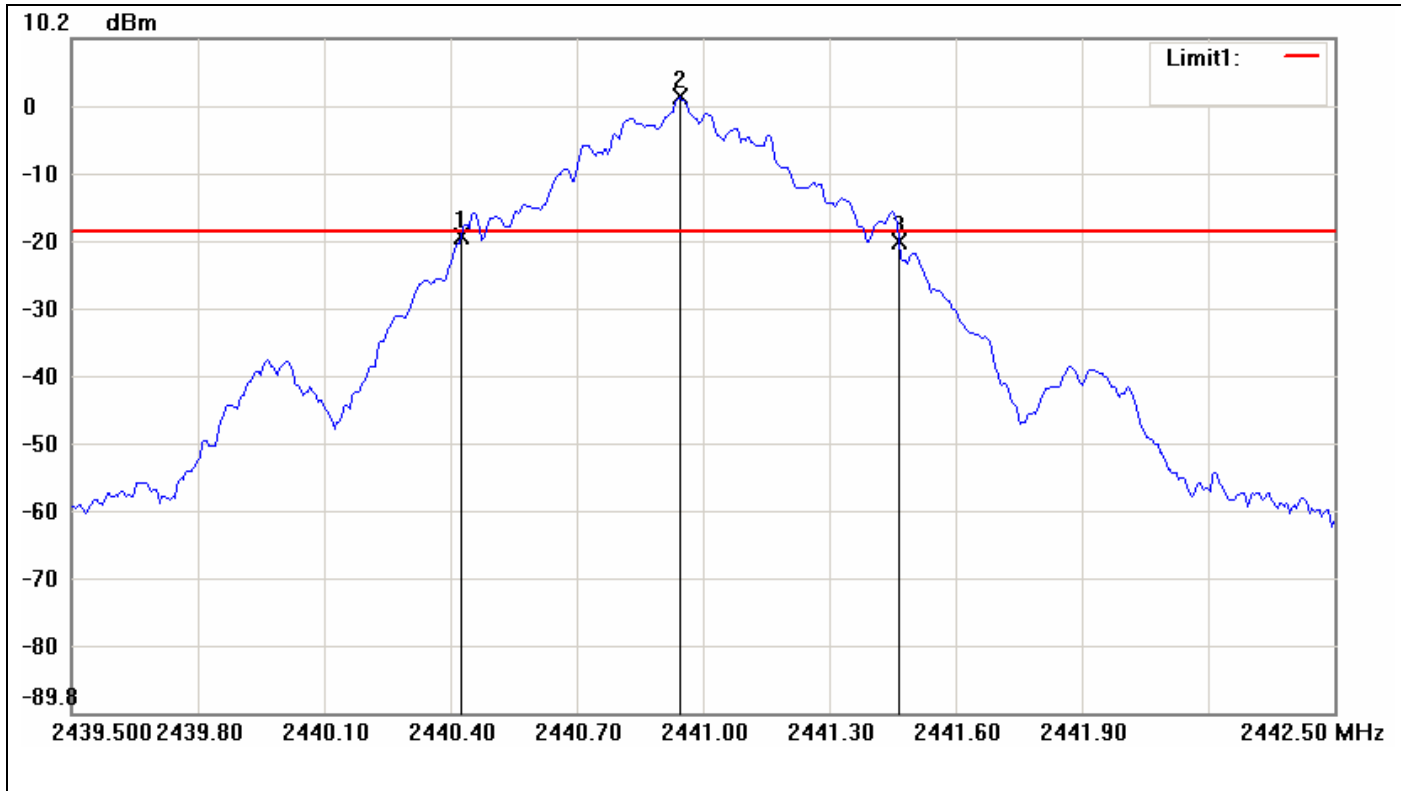

No.	Frequency(MHz)	Level(dBm)	Limit(dBm)	Margin(dBm)
1	2440.4250	-19.24	-18.58	-0.66
2	2440.9450	1.42	-18.58	20.00
3	2441.4650	-20.02	-18.58	-1.44

No.		Δ Frequency(MHz)	Δ Level(dB)
1	mk3-mk1	1.04	-0.78



20dB Bandwidth (CH High)

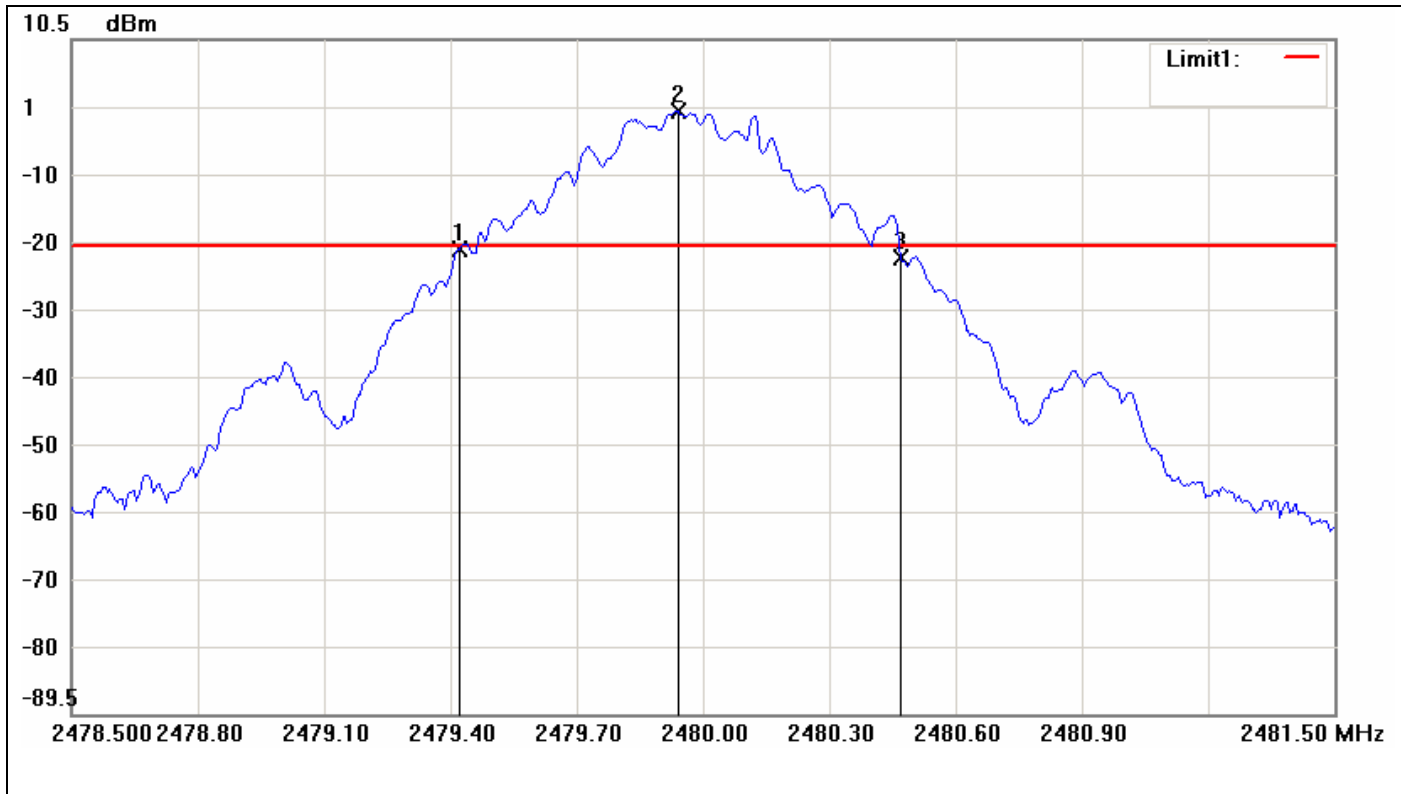

No.	Frequency(MHz)	Level(dBm)	Limit(dBm)	Margin(dBm)
1	2479.4200	-20.60	-20.23	-0.37
2	2479.9400	-0.23	-20.23	20.00
3	2480.4700	-21.89	-20.23	-1.66

No.		Δ Frequency(MHz)	Δ Level(dB)
1	mk3-mk1	1.05	-1.29



7.2 PEAK POWER

LIMIT

The maximum peak output power of the intentional radiator shall not exceed the following:

1. According to §15.247(a)(1), Frequency hopping systems shall have hopping channel carrier frequencies separated by a minimum of 25 kHz or the 20 dB bandwidth of the hopping channel, whichever is greater. Alternatively, frequency hopping systems operating in the 2400-2483.5 MHz band may have hopping channel carrier frequencies that are separated by 25 kHz or two-thirds of the 20 dB bandwidth of the hopping channel, whichever is greater, provided the systems operate with an output power no greater than 125 mW.
2. According to §15.247(b)(3), for systems using digital modulation in the bands of 902-928 MHz, 2400-2483.5 MHz, and 5725-5850 MHz: 1 Watt.
3. According to §15.247(b)(4), the conducted output power limit specified in paragraph (b) of this section is based on the use of antennas with directional gains that do not exceed 6 dBi. Except as shown in paragraph (c) of this section, if transmitting antennas of directional gain greater than 6 dBi are used, the conducted output power from the intentional radiator shall be reduced below the stated values in paragraphs (b)(1), (b)(2), and (b)(3) of this section, as appropriate, by the amount in dB that the directional gain of the antenna exceeds 6 dBi.

Test Configuration

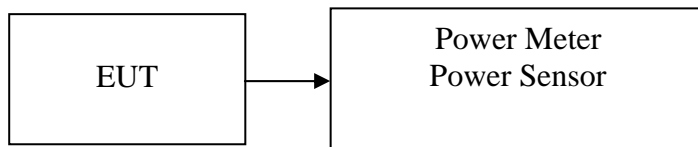

TEST PROCEDURE

The transmitter output is connected to the Power Meter. The Power Meter is set to the peak power detection.

TEST RESULTS

No non-compliance noted.

Test Data

Channel	Frequency (MHz)	Output Power (dBm)	Output Power (W)	Limit (W)	Result
Low	2402	2.24	0.0017	0.125	PASS
Mid	2441	1.96	0.0016		PASS
High	2480	2.25	0.0017		PASS



7.3 BAND EDGES MEASUREMENT

LIMIT

According to §15.247(d), in any 100 kHz bandwidth outside the frequency band in which the spread spectrum or digitally modulated intentional radiator is operating, the radio frequency power that is produced by the intentional radiator shall be at least 20 dB below that in the 100 kHz bandwidth within the band that contains the highest level of the desired power, based on either an RF conducted or a radiated measurement, provided the transmitter demonstrates compliance with the peak conducted power limits. If the transmitter complies with the conducted power limits based on the use of RMS averaging over a time interval, as permitted under paragraph (b)(3) of this section, the attenuation required under this paragraph shall be 30 dB instead of 20 dB. Attenuation below the general limits specified in §15.209(a) is not required. In addition, radiated emissions which fall in the restricted bands, as defined in §15.205(a), must also comply with the radiated emission limits specified in §15.209(a) (see §15.205(c)).

Test Configuration

For Radiated

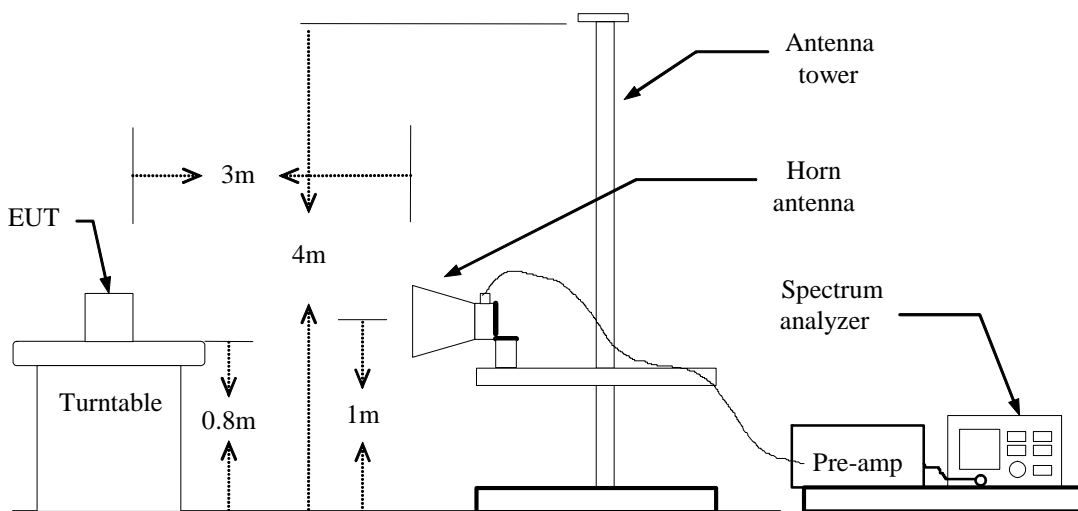

For Conducted

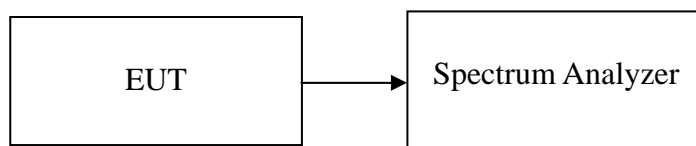



TEST PROCEDURE

For Radiated

1. The EUT is placed on a turntable, which is 0.8m above the ground plane.
2. The turntable shall be rotated for 360 degrees to determine the position of maximum emission level.
3. EUT is set 3m away from the receiving antenna, which is varied from 1m to 4m to find out the highest emission.
4. Set the spectrum analyzer in the following setting in order to capture the lower and upper band-edges of the emission:
 - (a) PEAK: RBW=1MHz / VBW=3MHz / Sweep=AUTO
 - (b) AVERAGE: RBW=1MHz / VBW=10Hz / Sweep=AUTO
5. Repeat the procedures until all the PEAK and AVERAGE versus POLARIZATION are measured.

For Conducted

Conducted RF measurements of the transmitter output were made to confirm that the EUT antenna port conducted emissions meet the specified limit and to identify any spurious signals that require further investigation or measurements on the radiated emissions site.

The transmitter output is connected to the spectrum analyzer. The resolution bandwidth is set to 300 kHz. The video bandwidth is set to 300 kHz.

TEST RESULTS

Refer to attach spectrum analyzer data chart.



Band Edges (CH Low)

Detector mode: Peak

Polarity: Vertical

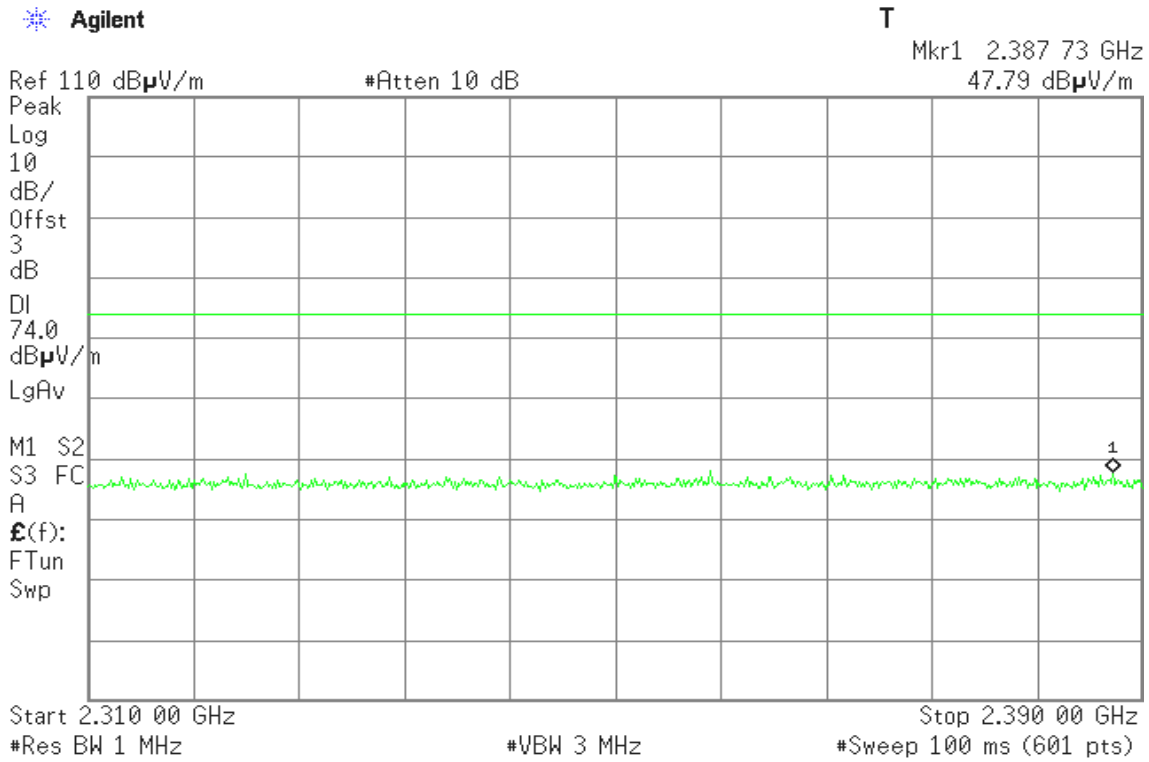

Detector mode: Average

Polarity: Vertical

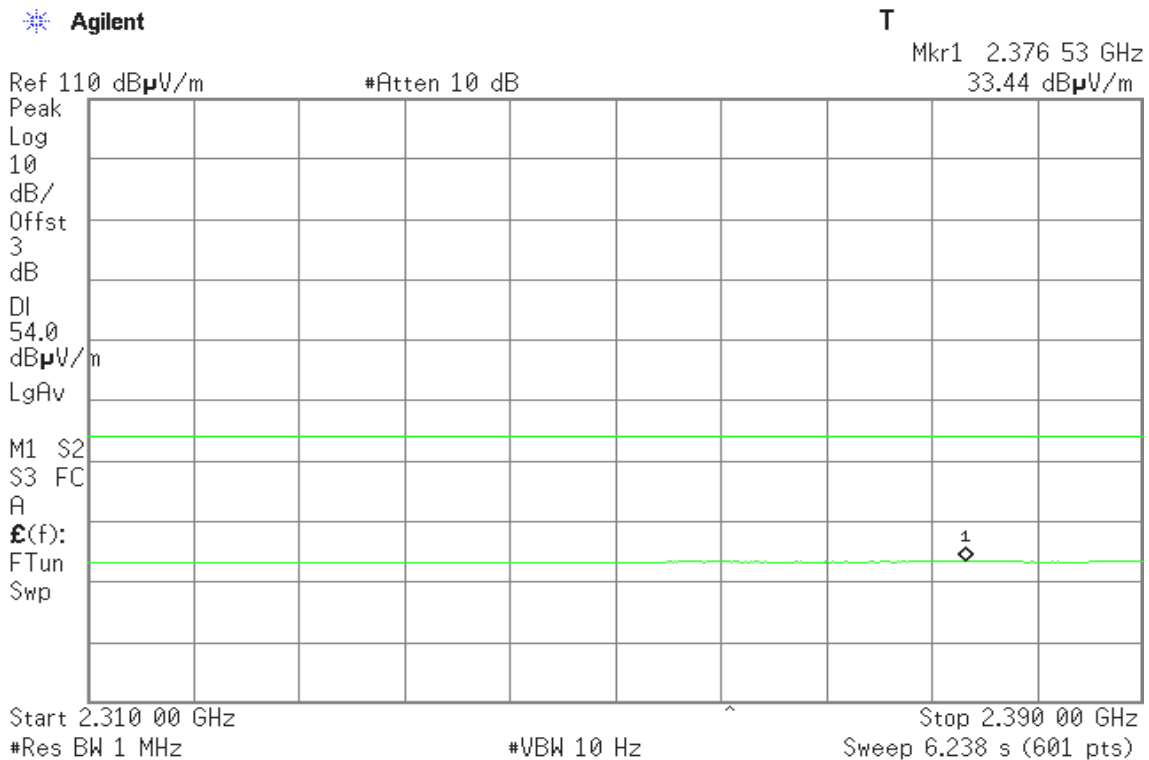



Detector mode: Peak

Polarity: Horizontal

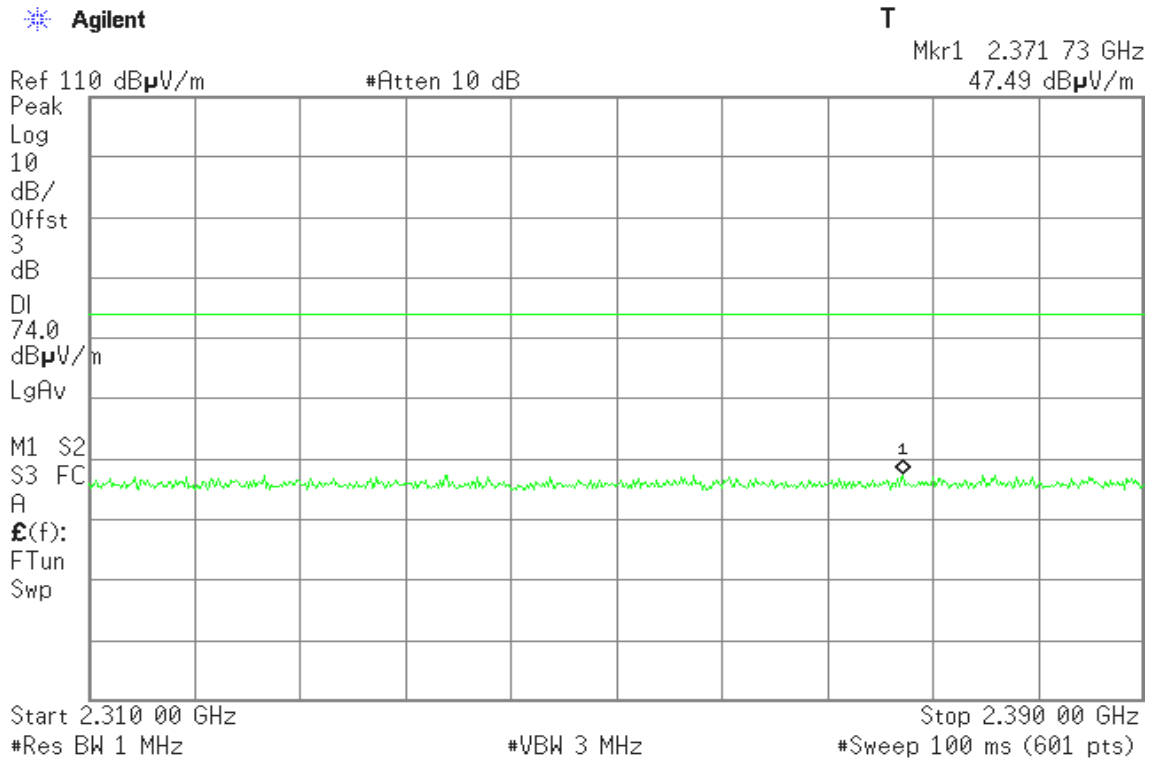

Detector mode: Average

Polarity: Horizontal

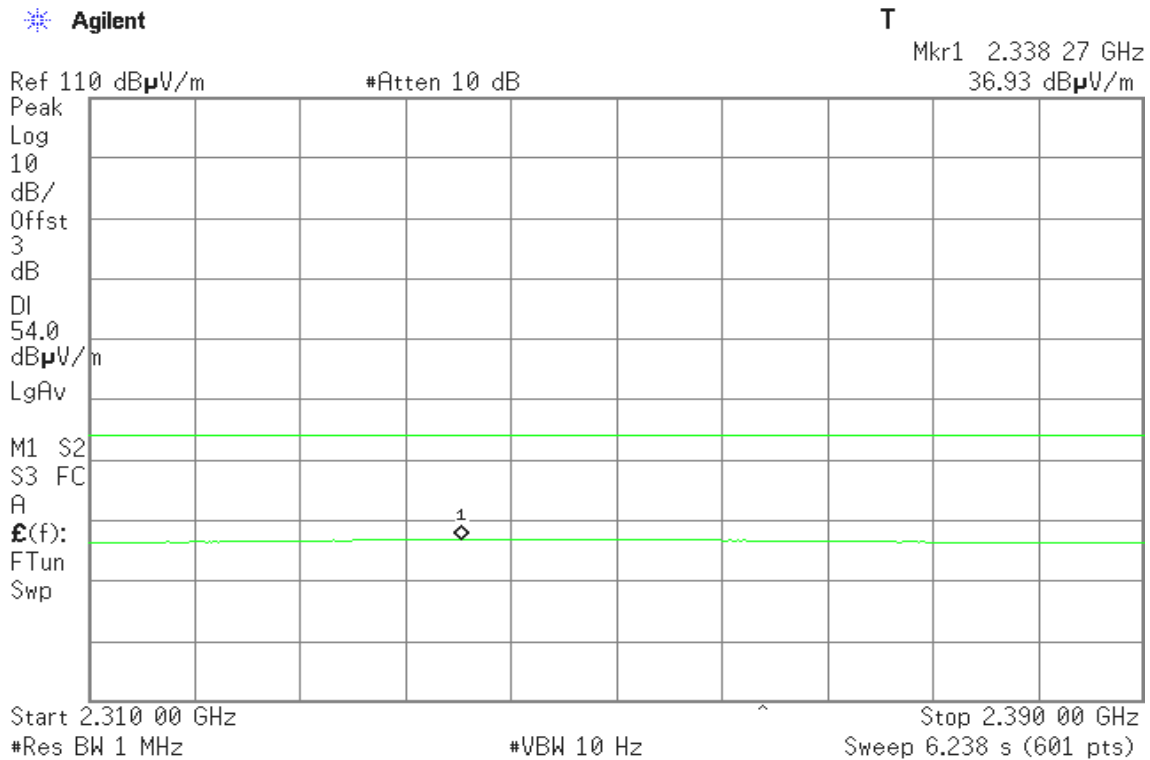



Band Edges (CH High)

Detector mode: Peak

Polarity: Vertical

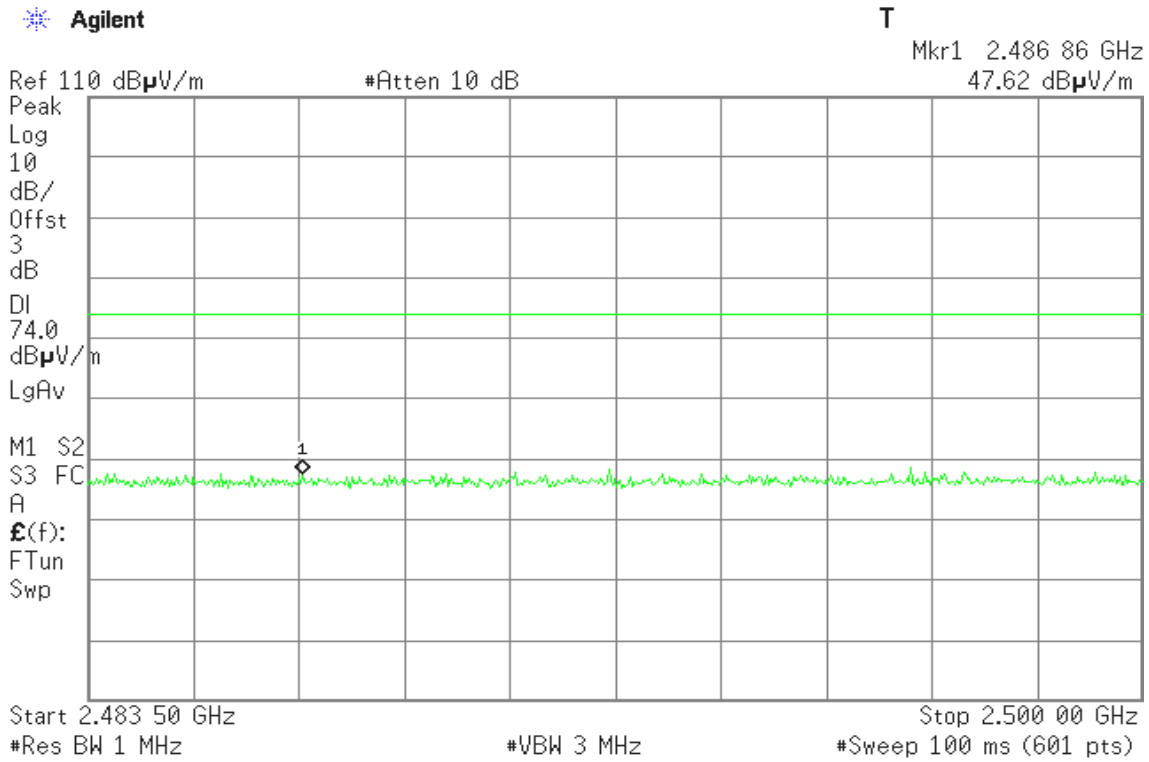

Detector mode: Average

Polarity: Vertical

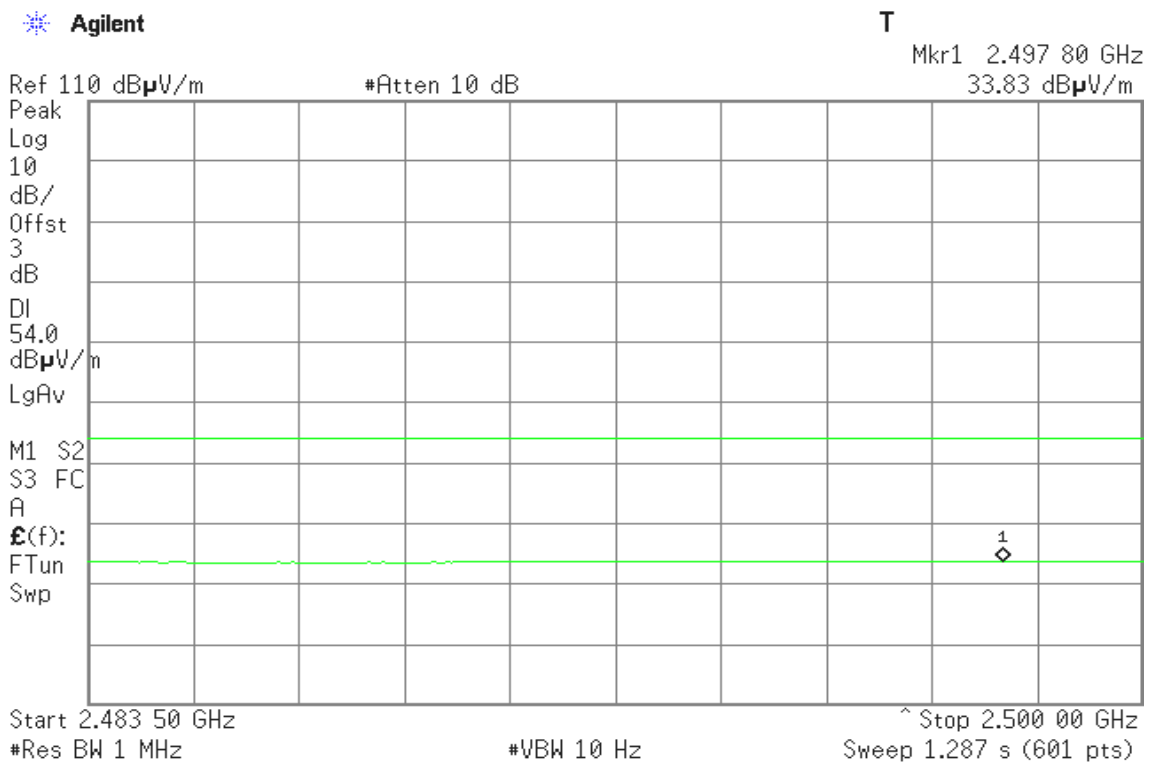



Detector mode: Peak

Polarity: Horizontal

Agilent

T

Mkr1 2.484 13 GHz
47.38 dB μ V/m

Ref 110 dB μ V/m

#Atten 10 dB

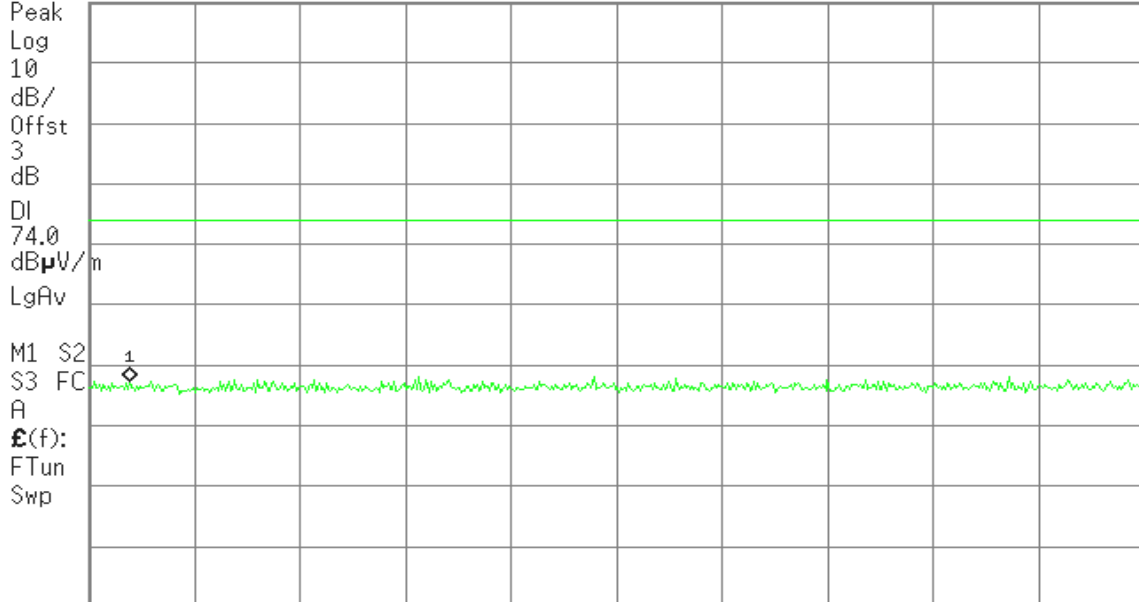

Start 2.483 50 GHz

Stop 2.500 00 GHz

#Res BW 1 MHz

#VBW 3 MHz

#Sweep 100 ms (601 pts)

Detector mode: Average

Polarity: Horizontal

Agilent

T

Mkr1 2.495 98 GHz
33.84 dB μ V/m

Ref 110 dB μ V/m

#Atten 10 dB

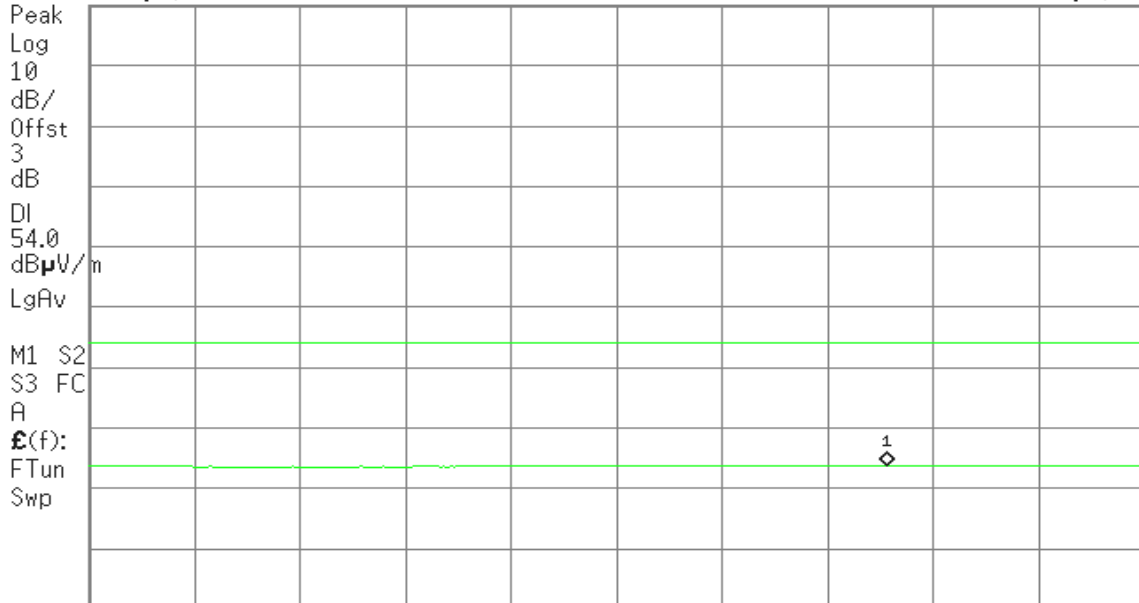

Start 2.483 50 GHz

Stop 2.500 00 GHz

#Res BW 1 MHz

#VBW 10 Hz

Sweep 1.287 s (601 pts)



Conducted Bandedge

(CH Low)

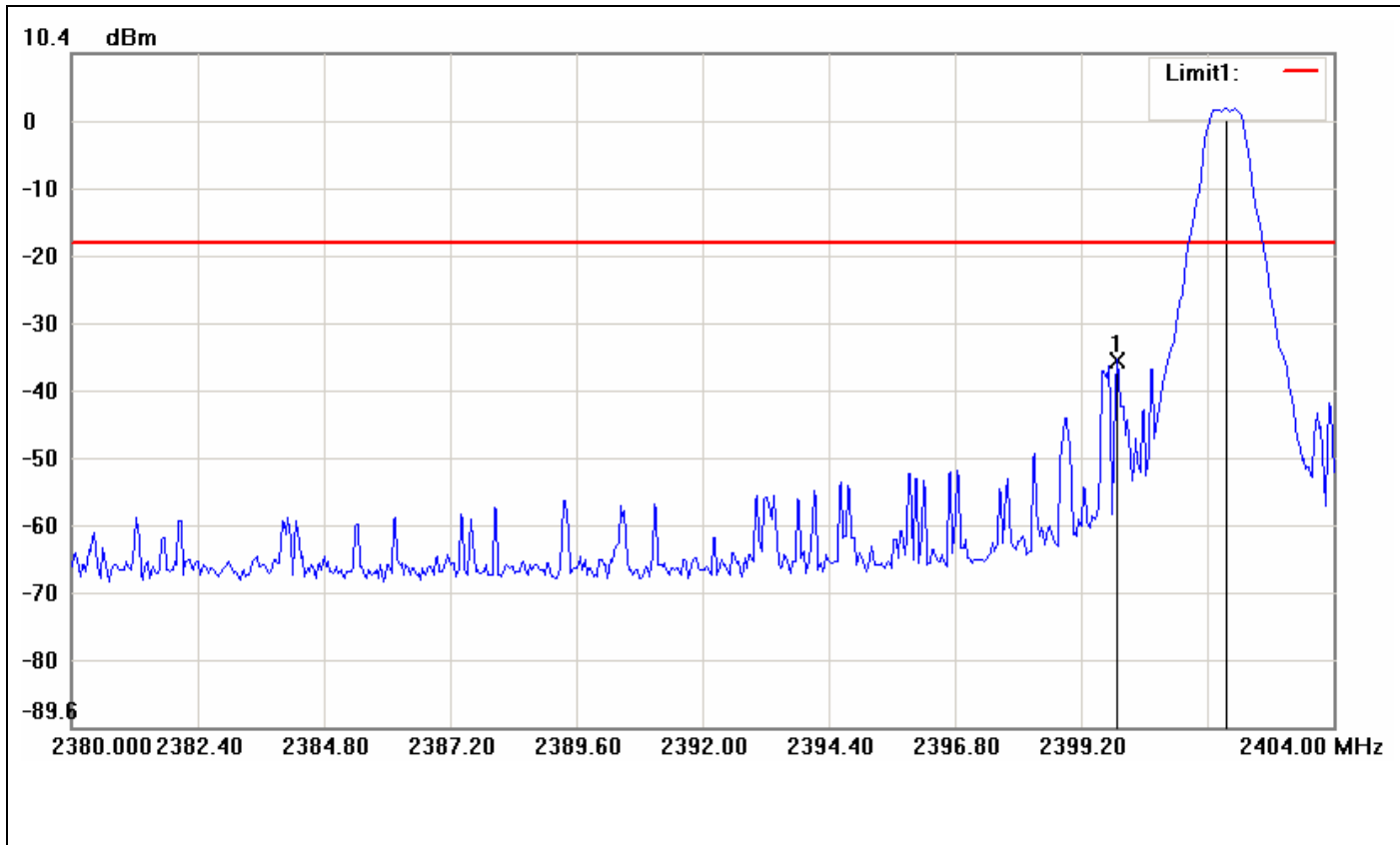

No.	Frequency(MHz)	Level(dBm)	Limit(dBm)	Margin(dBm)
1	2399.8800	-35.09	-17.81	-17.28
2	2401.9600	2.19	-17.81	20.00



(CH High)

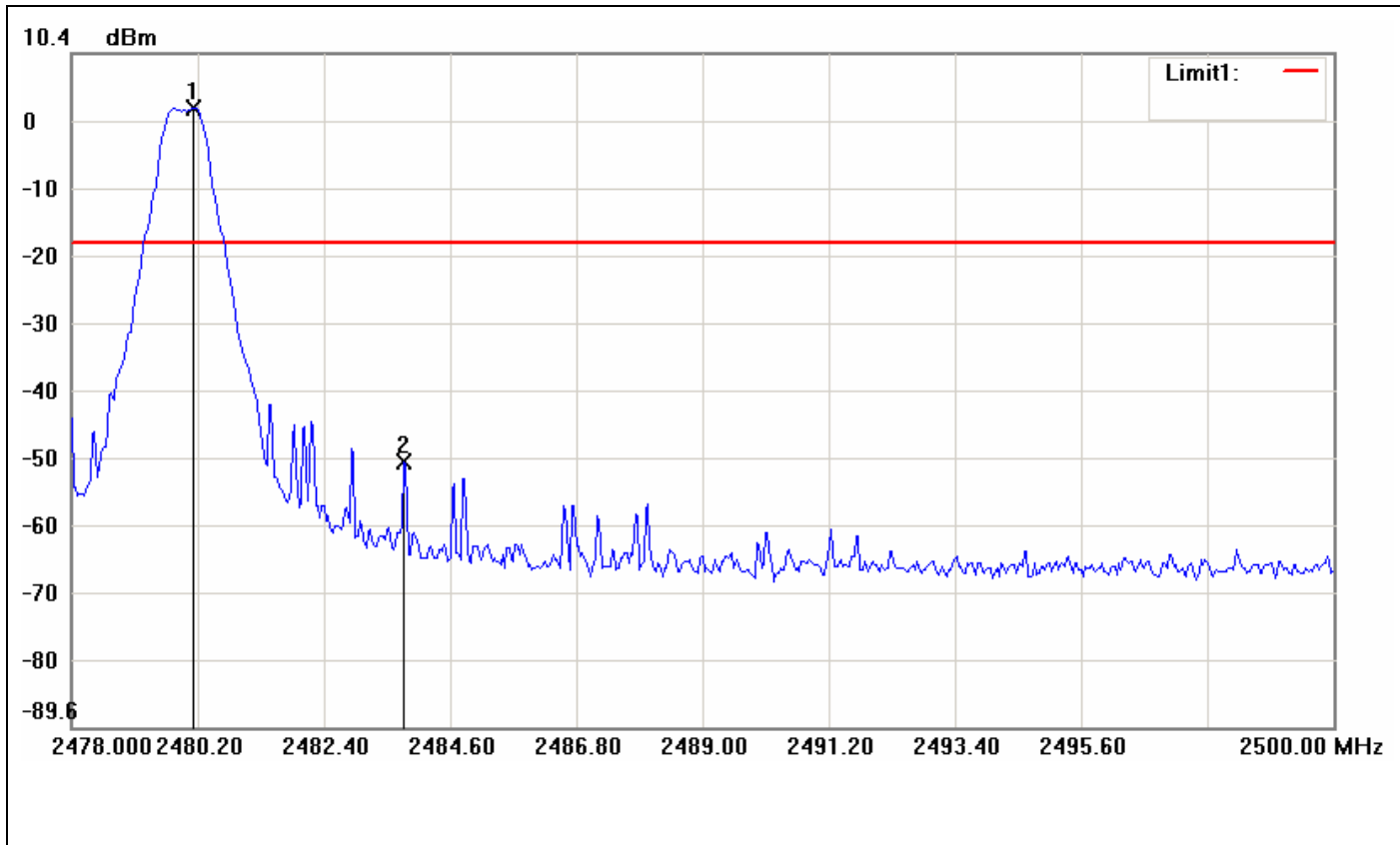

No.	Frequency(MHz)	Level(dBm)	Limit(dBm)	Margin(dBm)
1	2480.1267	2.22	-17.78	20.00
2	2483.7933	-50.23	-17.78	-32.45



Hopping Mode

(CH Low)

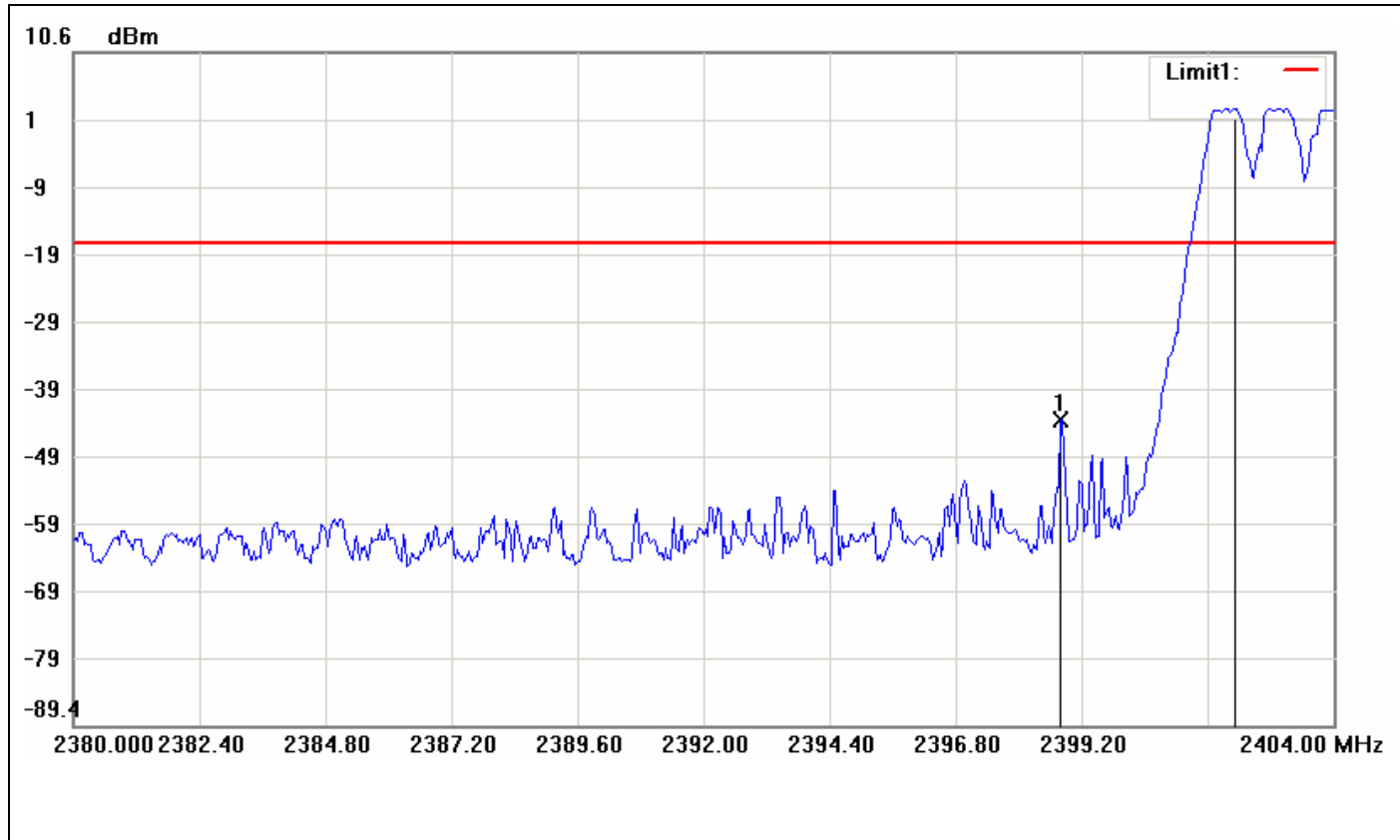

No.	Frequency(MHz)	Level(dBm)	Limit(dBm)	Margin(dBm)
1	2398.8000	-44.09	-17.79	-26.30
2	2402.1200	2.21	-17.79	20.00



(CH High)

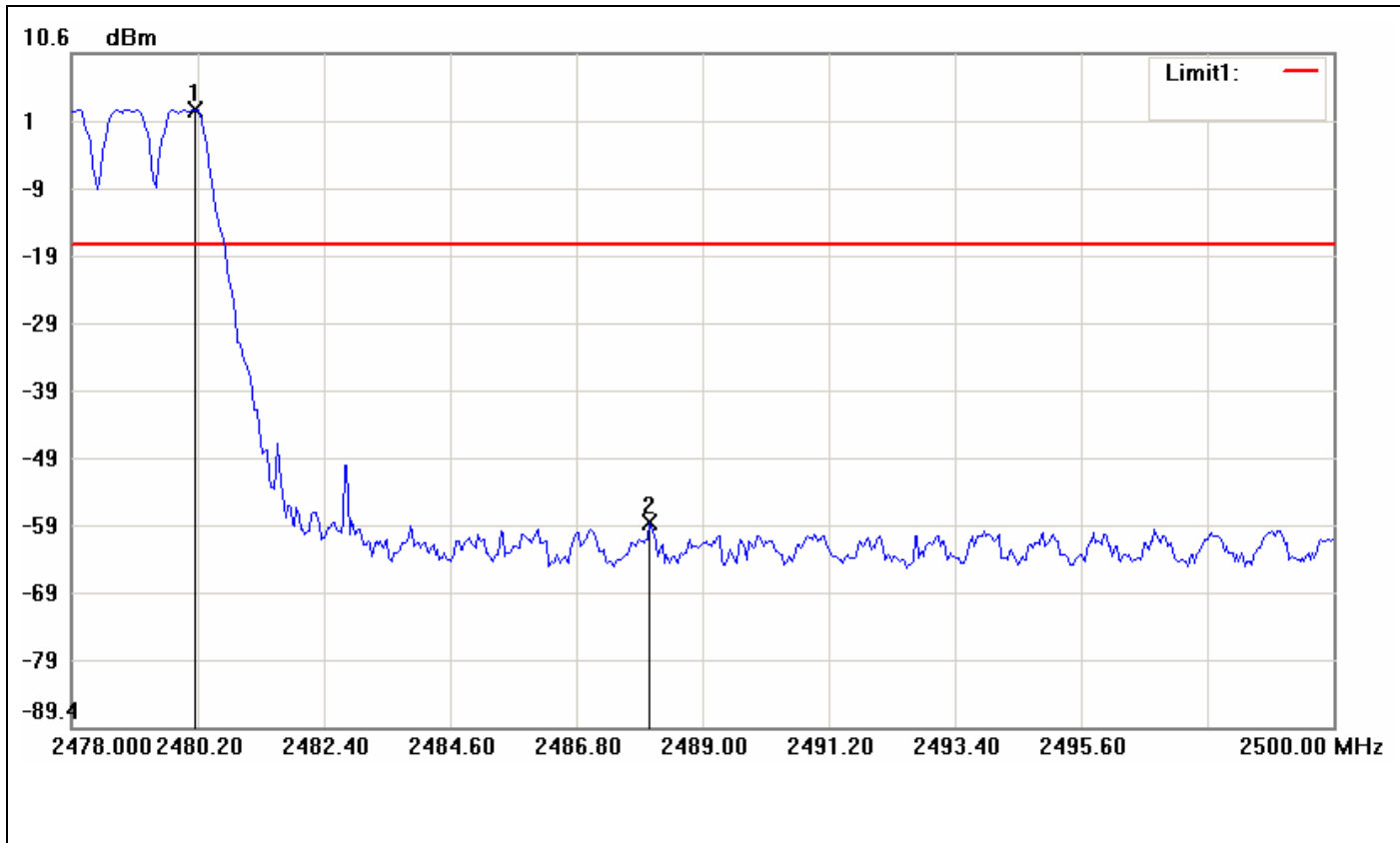

No.	Frequency(MHz)	Level(dBm)	Limit(dBm)	Margin(dBm)
1	2480.1633	2.22	-17.78	20.00
2	2488.0833	-59.00	-17.78	-41.22



7.4 FREQUENCY SEPARATION

LIMIT

According to §15.247(a)(1), Frequency hopping systems shall have hopping channel carrier frequencies separated by a minimum of 25 kHz or the 20 dB bandwidth of the hopping channel, whichever is greater. Alternatively, frequency hopping systems operating in the 2400-2483.5 MHz band may have hopping channel carrier frequencies that are separated by 25 kHz or two-thirds of the 20 dB bandwidth of the hopping channel, whichever is greater, provided the systems operate with an output power no greater than 125 mW.

Test Configuration

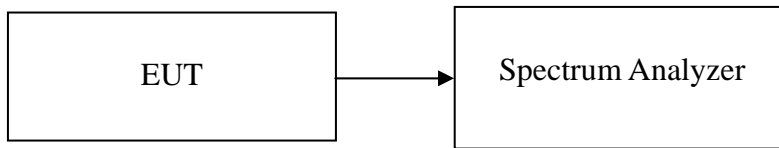

TEST PROCEDURE

1. Place the EUT on the table and set it in transmitting mode.
2. Remove the antenna from the EUT and then connect a low loss RF cable from the antenna port to the spectrum analyzer.
3. Set center frequency of spectrum analyzer = middle of hopping channel.
4. Set the spectrum analyzer as RBW = 30kHz, VBW = 100kHz, Span = 3MHz, Sweep = auto.
5. Max hold, mark 3 peaks of hopping channel and record the 3 peaks frequency.

TEST RESULTS

No non-compliance noted

Test Data

Channel Separation (MHz)	two-thirds of the 20 dB bandwidth (kHz)	Channel Separation Limit	Result
1.195	700	>two-thirds of the 20 dB bandwidth	Pass



Test Plot

Measurement of Channel Separation

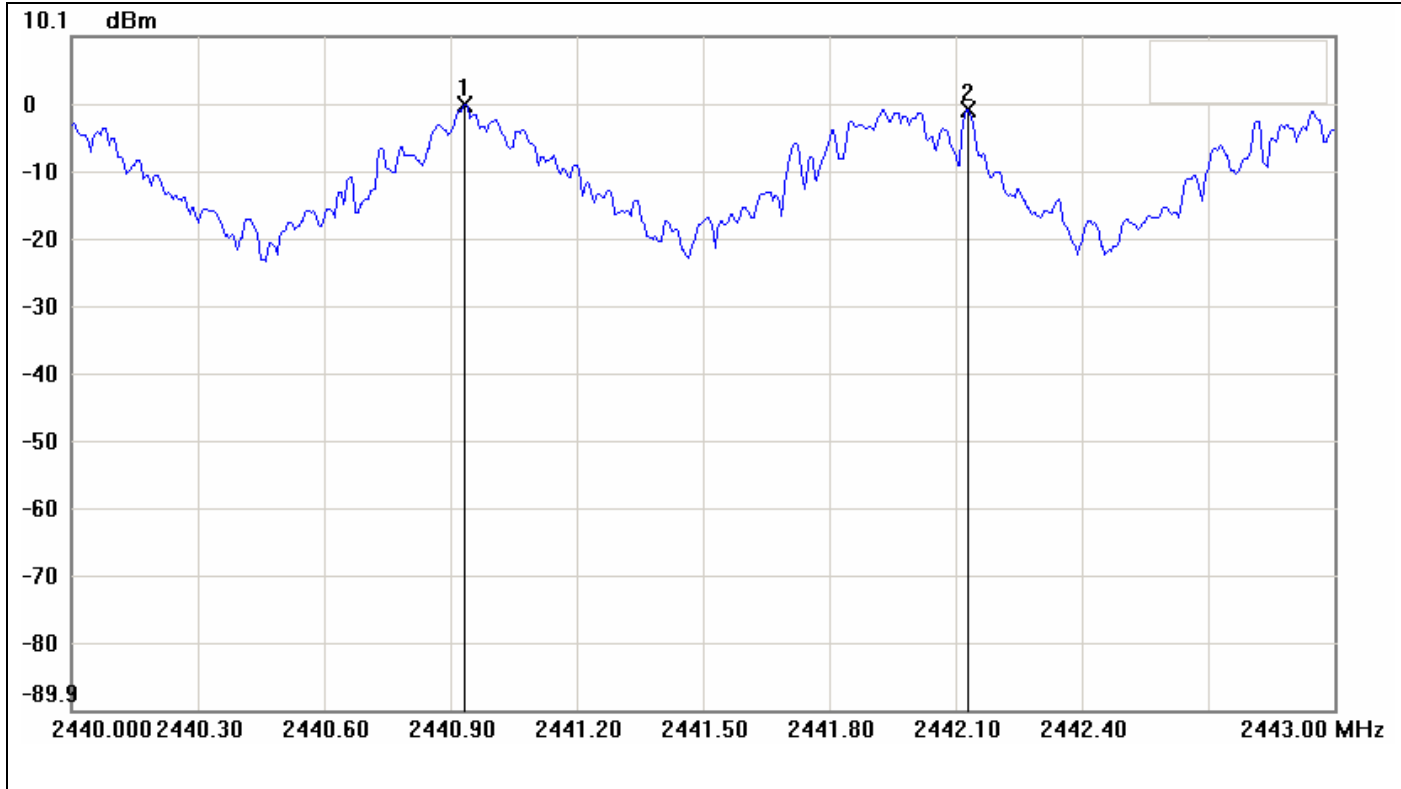

No.	Frequency(MHz)	Level(dBm)	Limit(dBm)	Margin(dBm)
1	2440.9350	-0.02		
2	2442.1300	-0.68		

No.		Δ Frequency(MHz)	Δ Level(dB)
1	mk2-mk1	1.195	-0.66



Measurement of 20dB Bandwidth

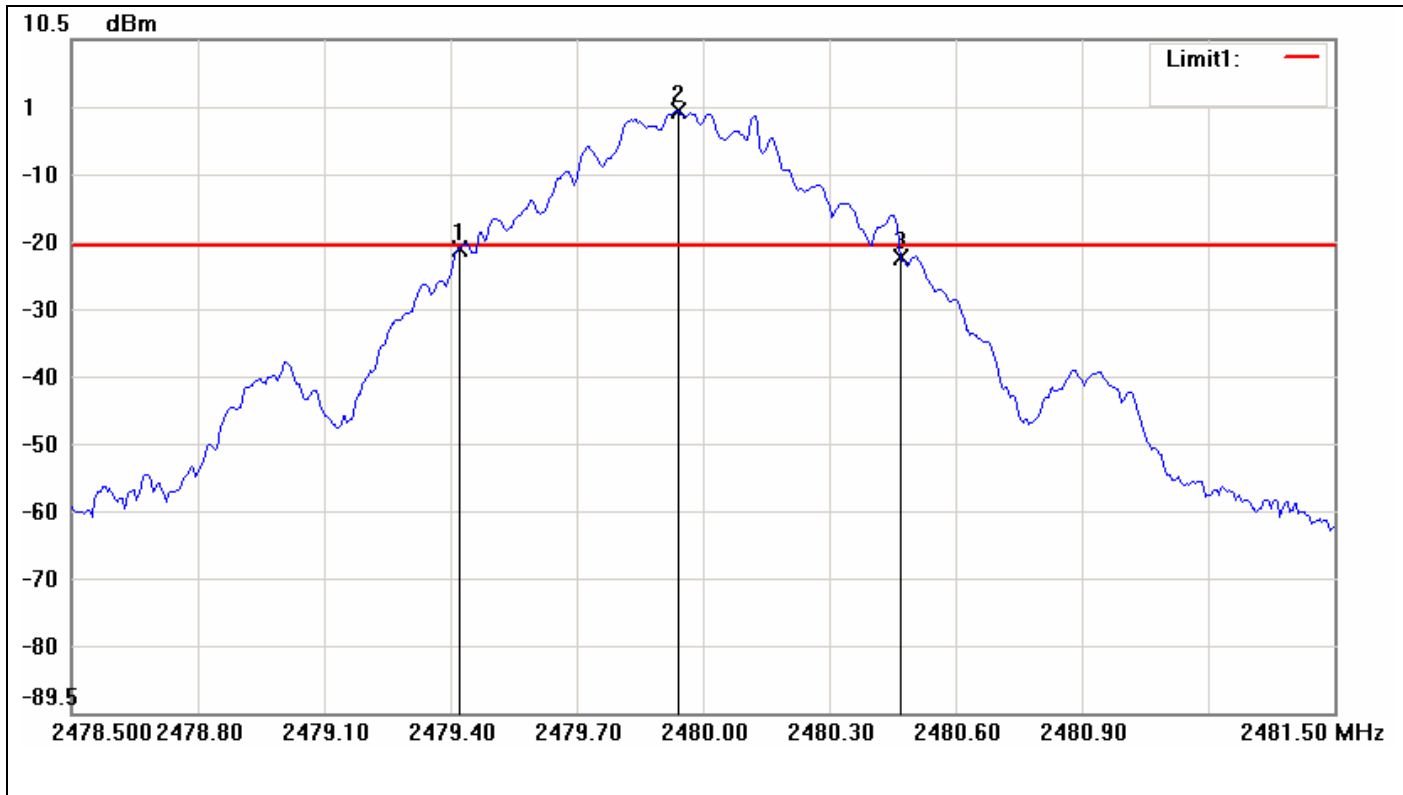

No.	Frequency(MHz)	Level(dBm)	Limit(dBm)	Margin(dBm)
1	2479.4200	-20.60	-20.23	-0.37
2	2479.9400	-0.23	-20.23	20.00
3	2480.4700	-21.89	-20.23	-1.66

No.		Δ Frequency(MHz)	Δ Level(dB)
1	mk3-mk1	1.05	-1.29



7.5 NUMBER OF HOPPING FREQUENCY

LIMIT

According to §15.247(a)(1)(ii), Frequency hopping systems operating in the 2400MHz-2483.5 MHz bands shall use at least 75 hopping frequencies.

Test Configuration

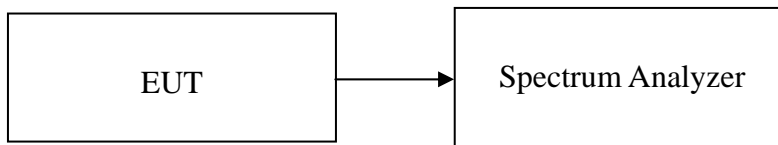

TEST PROCEDURE

1. Place the EUT on the table and set it in transmitting mode.
2. Remove the antenna from the EUT and then connect a low loss RF cable from the antenna port to the spectrum analyzer.
3. Set spectrum analyzer Start=2400MHz, Stop = 2430.5MHz, Sweep = auto, Start=2430.5MHz, Stop = 2460.5MHz, Sweep = auto and Start=2460.5MHz, Stop = 2485.5MHz, Sweep = auto.
4. Set the spectrum analyzer as RBW, VBW=300kHz.
5. Max hold, view and count how many channel in the band.

TEST RESULTS

No non-compliance noted

Test Data

Result (No. of CH)	Limit (No. of CH)	Result
79	>75	PASS



Test Plot

Channel Number

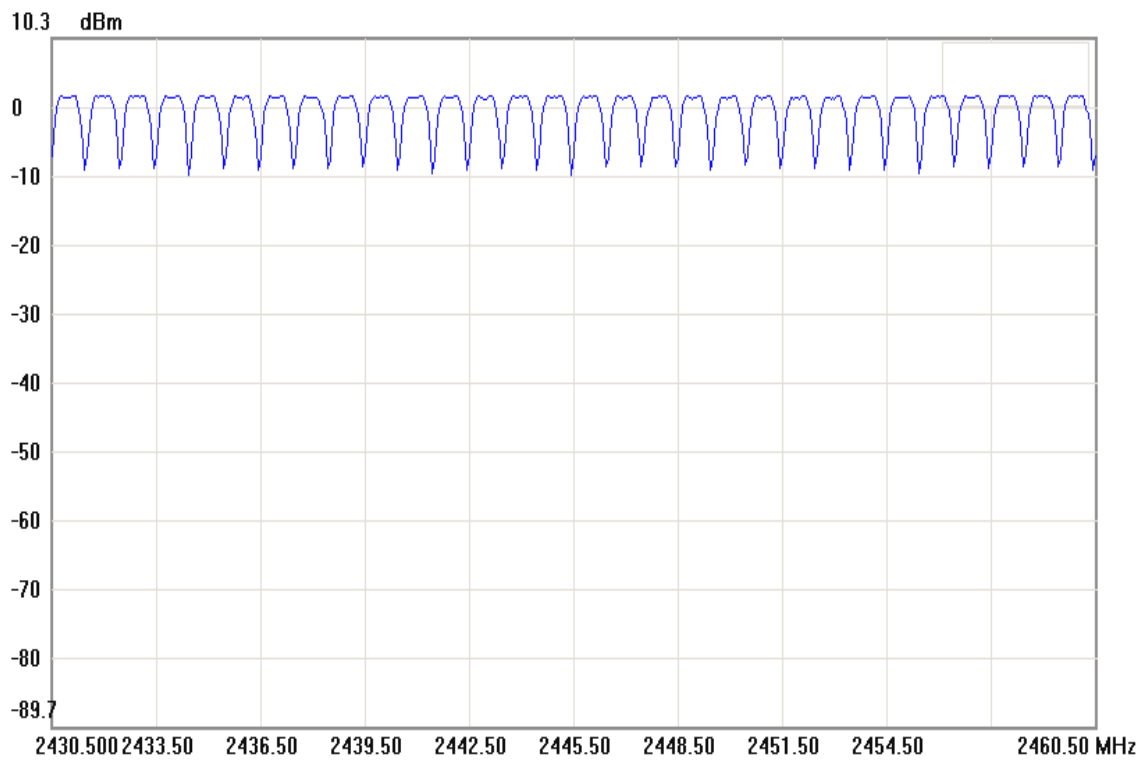
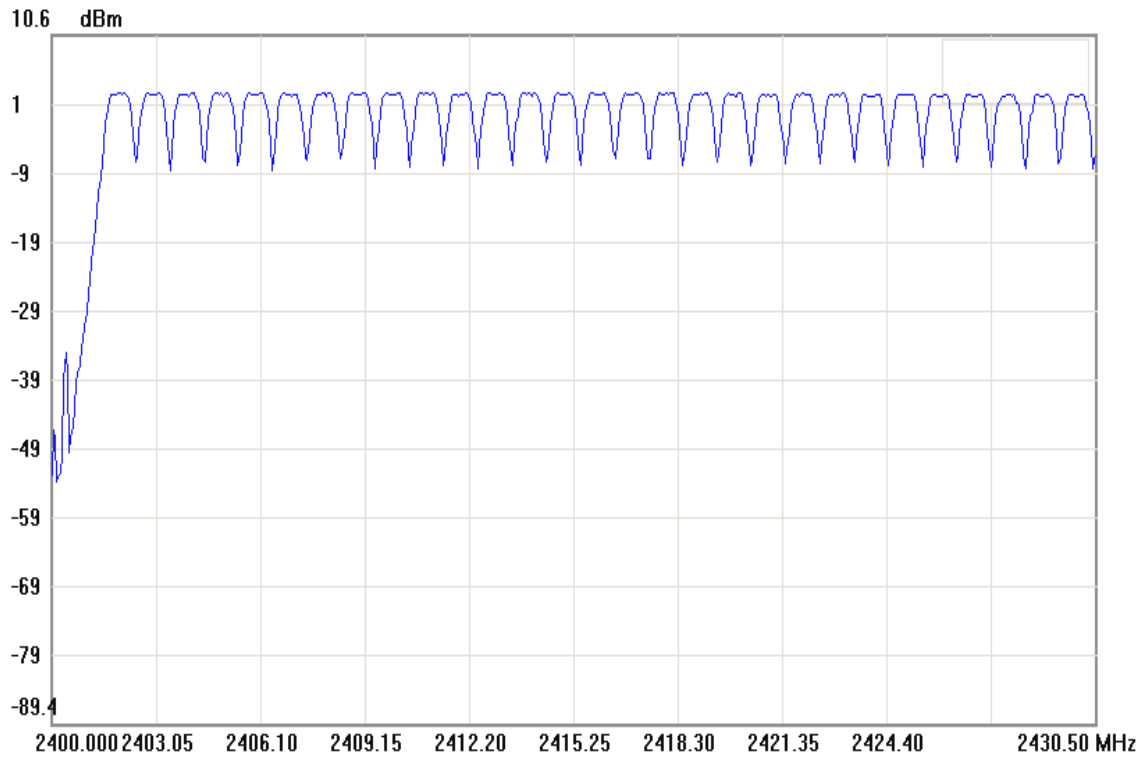

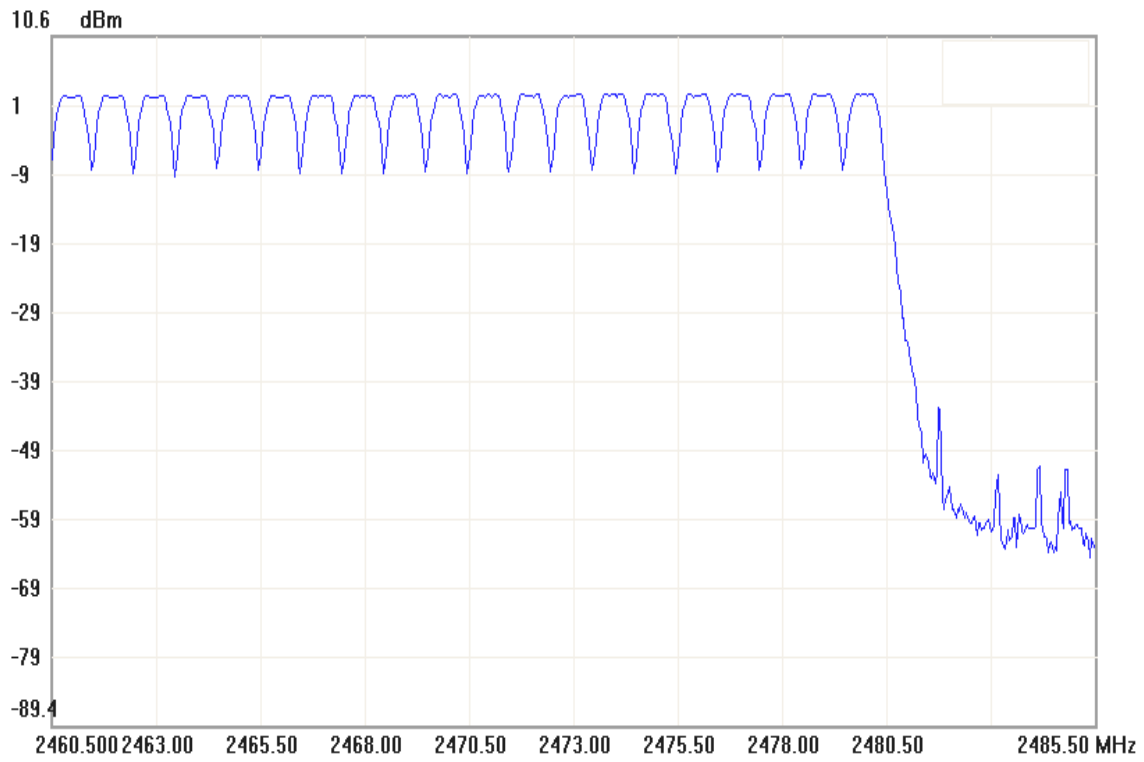



7.6 TIME OF OCCUPANCY (DWELL TIME)

LIMIT

According to §15.247(a)(1)(iii), Frequency hopping systems operating in the 2400MHz-2483.5 MHz bands. The average time of occupancy on any channels shall not greater than 0.4 s within a period 0.4 s multiplied by the number of hopping channels employed.

Test Configuration

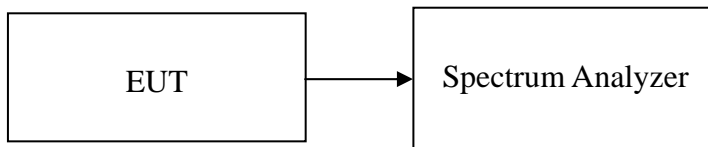

TEST PROCEDURE

1. Place the EUT on the table and set it in transmitting mode.
2. Remove the antenna from the EUT and then connect a low loss RF cable from the antenna port to the spectrum analyzer.
3. Set center frequency of spectrum analyzer = operating frequency.
4. Set the spectrum analyzer as RBW, VBW=1MHz, Span = 0Hz, Sweep = auto.
5. Repeat above procedures until all frequency measured were complete.

Test Data

DH 1: $0.4333 * (1600/2)/79 * 31.6 = 138.656$ (ms)

DH 3: $1.695 * (1600/4)/79 * 31.6 = 271.200$ (ms)

DH 5: $2.95 * (1600/6)/79 * 31.6 = 314.667$ (ms)

	Pulse Time (ms)	Total of Dwell (ms)	Period Time (s)	Limit (ms)	Result
DH 1	0.4333	138.656	31.60	400.00	PASS
DH 3	1.695	271.200	31.60		PASS
DH 5	2.95	314.667	31.60		PASS



Test Plot

DH 1

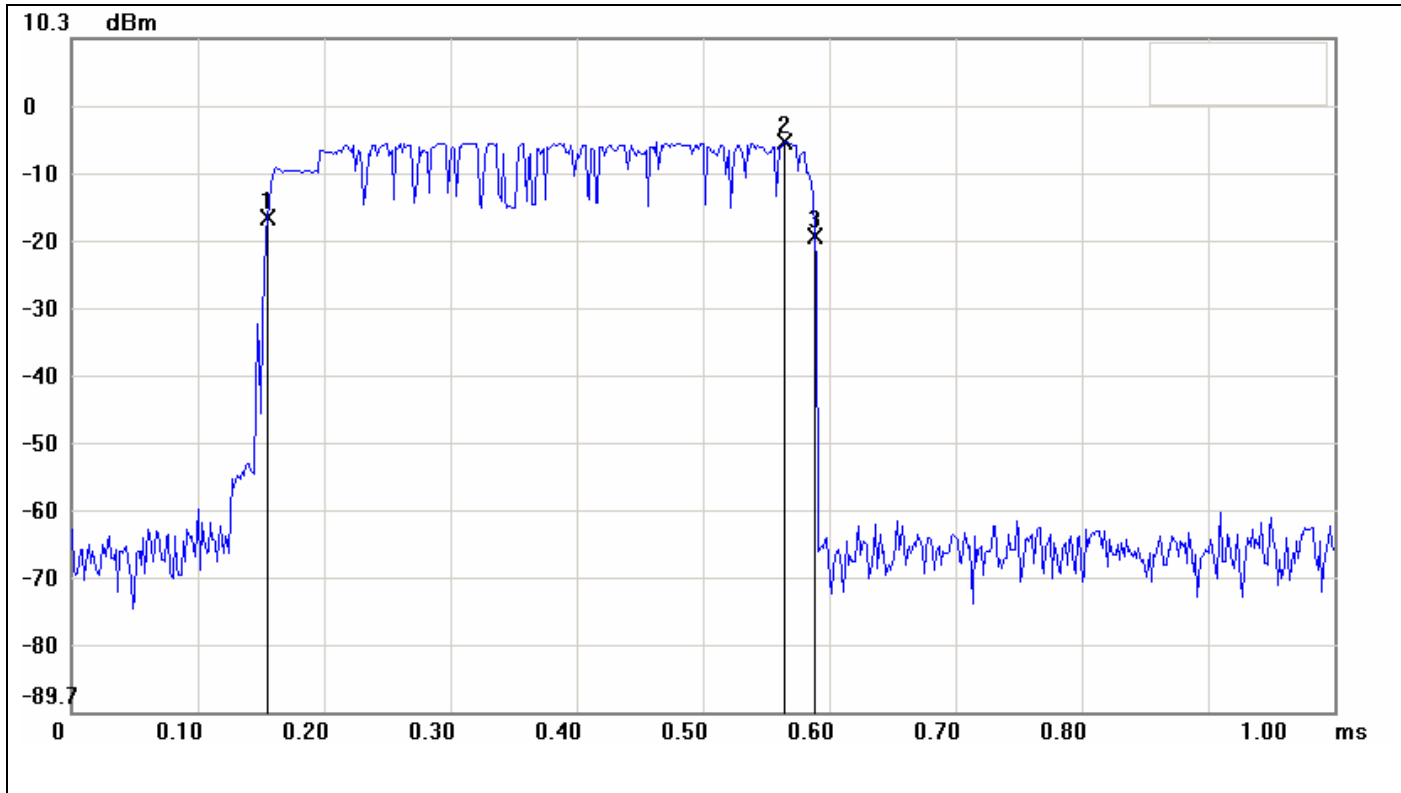

No.	Sweep time(ms)	Level(dBm)	Limit(dBm)	Margin(dBm)
1	0.1550	-16.38		
2	0.5650	-5.13		
3	0.5883	-19.09		

No.		Δ Time(ms)	Δ Level(dB)
1	mk3-mk1	0.4333	-2.71



DH 3



No.	Sweep time(ms)	Level(dBm)	Limit(dBm)	Margin(dBm)
1	0.7900	-8.82		
2	0.8200	1.92		
3	2.4850	-9.07		

No.		Δ Time(ms)	Δ Level(dB)
1	mk3-mk1	1.695	-0.25



DH 5

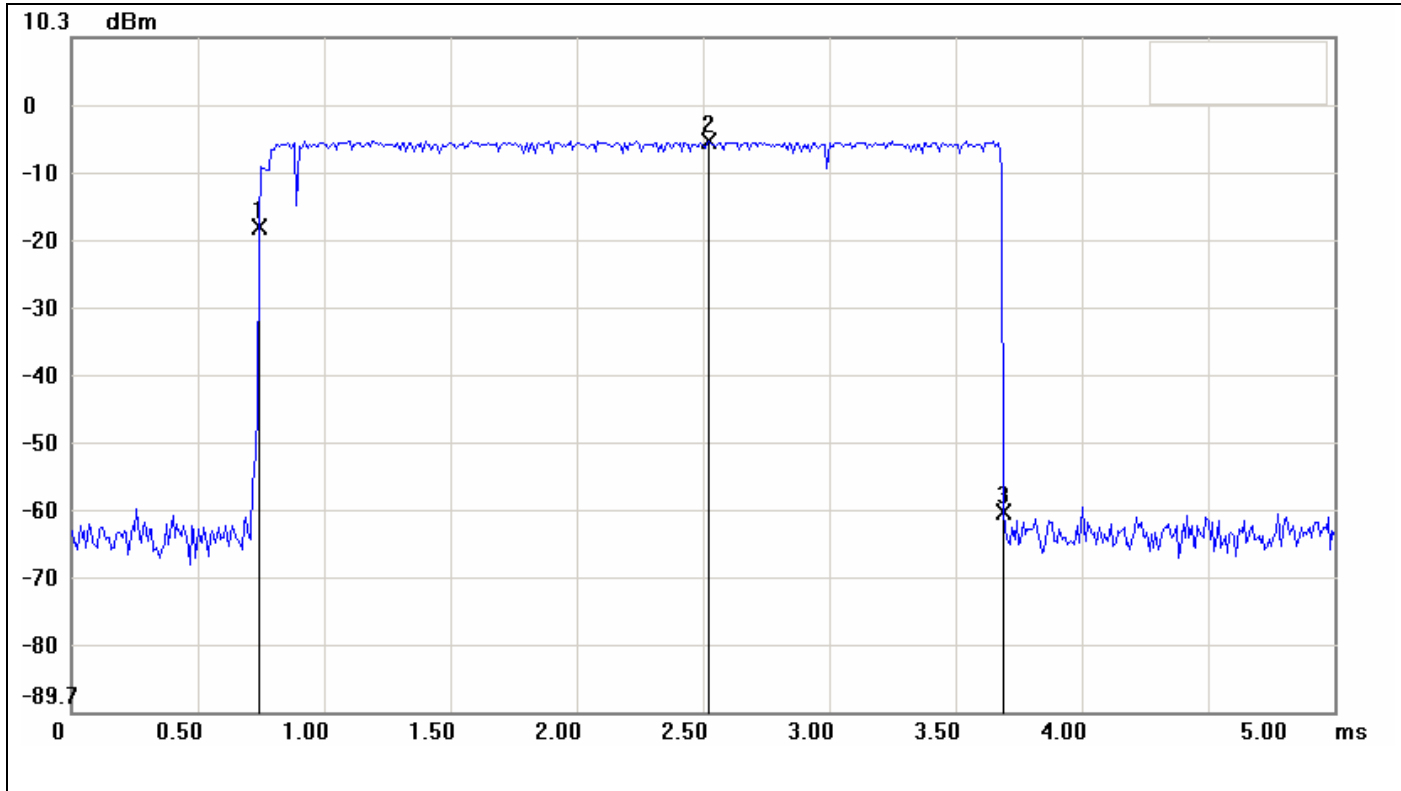

No.	Sweep time(ms)	Level(dBm)	Limit(dBm)	Margin(dBm)
1	0.7417	-17.83		
2	2.5250	-5.02		
3	3.6917	-59.97		

No.		Δ Time(ms)	Δ Level(dB)
1	mk3-mk1	2.95	-42.14



7.7 SPURIOUS EMISSIONS

7.7.1 Conducted Measurement

LIMIT

According to §15.247(d), in any 100 kHz bandwidth outside the frequency bands in which the spread spectrum intentional radiator is operating, the radio frequency power that is produced by the intentional radiator shall be at least 20 dB below that in the 100 kHz bandwidth within the band that contains the highest level of the desired power, based on either an RF conducted or a radiated measurement, provided the transmitter demonstrates compliance with the peak conducted power limits. In addition, radiated emissions which fall in the restricted bands, as defined in §15.205(a), must also comply with the radiated emission limits specified in 15.209(a) (see Section 15.205(c)).

Test Configuration

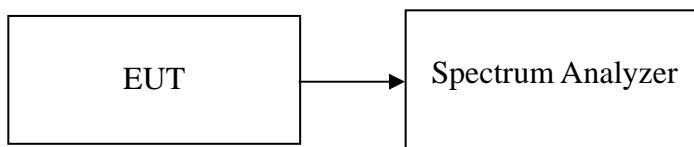

TEST PROCEDURE

Conducted RF measurements of the transmitter output were made to confirm that the EUT antenna port conducted emissions meet the specified limit and to identify any spurious signals that require further investigation or measurements on the radiated emissions site.

The transmitter output is connected to the spectrum analyzer. The resolution bandwidth is set to 100 kHz. The video bandwidth is set to 300 kHz.

Measurements are made over the 30MHz to 26GHz range with the transmitter set to the lowest, middle, and highest channels.

TEST RESULTS

No non-compliance noted



Test Plot

CH Low

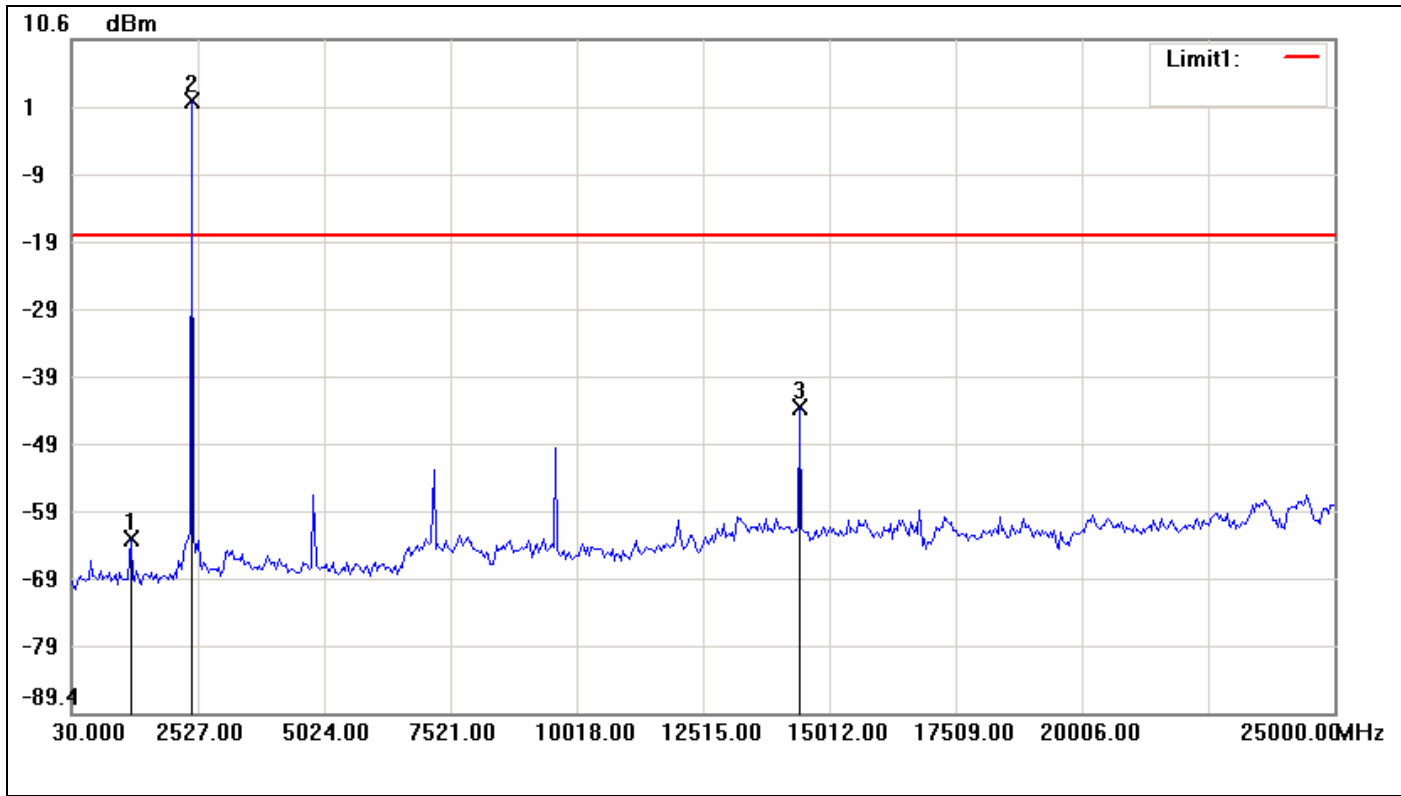

No.	Frequency(MHz)	Level(dBm)	Limit(dBm)	Margin(dBm)
1	1195.2667	-63.43	-18.50	-44.93
2	2402.1500	1.50	-18.50	20.00
3	14429.3667	-43.97	-18.50	-25.47



CH Mid

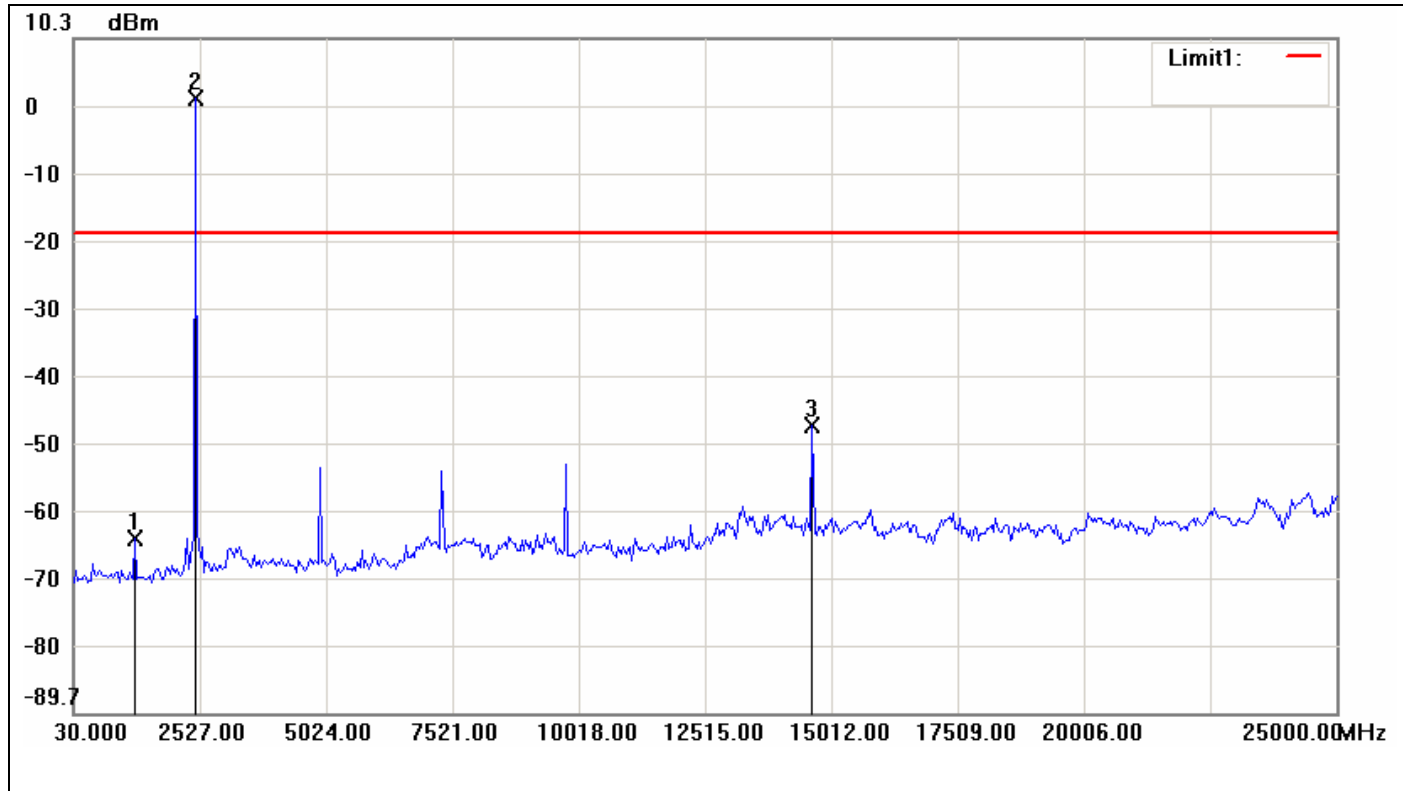

No.	Frequency(MHz)	Level(dBm)	Limit(dBm)	Margin(dBm)
1	1236.8833	-63.90	-18.48	-45.42
2	2443.7667	1.52	-18.48	20.00
3	14637.4500	-47.07	-18.48	-28.59



CH High

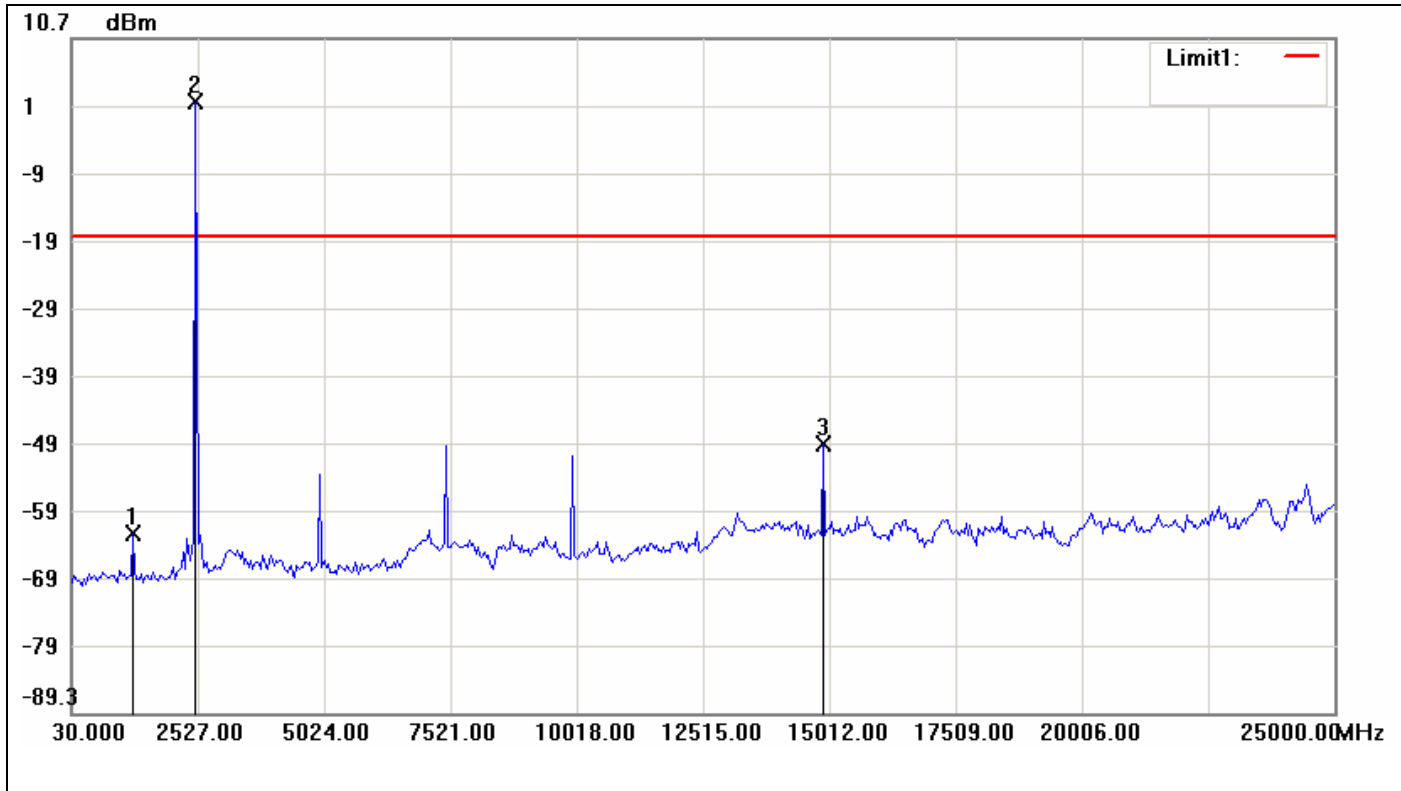

No.	Frequency(MHz)	Level(dBm)	Limit(dBm)	Margin(dBm)
1	1236.8833	-62.70	-18.70	-44.00
2	2485.3833	1.30	-18.70	20.00
3	14887.1500	-49.42	-18.70	-30.72



7.7.2 Radiated Emissions

LIMIT

1. According to §15.209(a), except as provided elsewhere in this Subpart, the emissions from an intentional radiator shall not exceed the field strength levels specified in the following table:

Frequency (MHz)	Field Strength ($\mu\text{V}/\text{m}$)	Measurement Distance (m)
30-88	100*	3
88-216	150*	3
216-960	200*	3
Above 960	500	3

Remark: Except as provided in paragraph (g), fundamental emissions from intentional radiators operating under this Section shall not be located in the frequency bands 54-72 MHz, 76-88 MHz, 174-216 MHz or 470-806 MHz. However, operation within these frequency bands is permitted under other sections of this Part, e.g., Sections 15.231 and 15.241.

2. In the emission table above, the tighter limit applies at the band edges.

Frequency (MHz)	Field Strength ($\mu\text{V}/\text{m}$ at 3-meter)	Field Strength (dB $\mu\text{V}/\text{m}$ at 3-meter)
30-88	100	40
88-216	150	43.5
216-960	200	46
Above 960	500	54



Test Configuration

9kHz ~ 30MHz

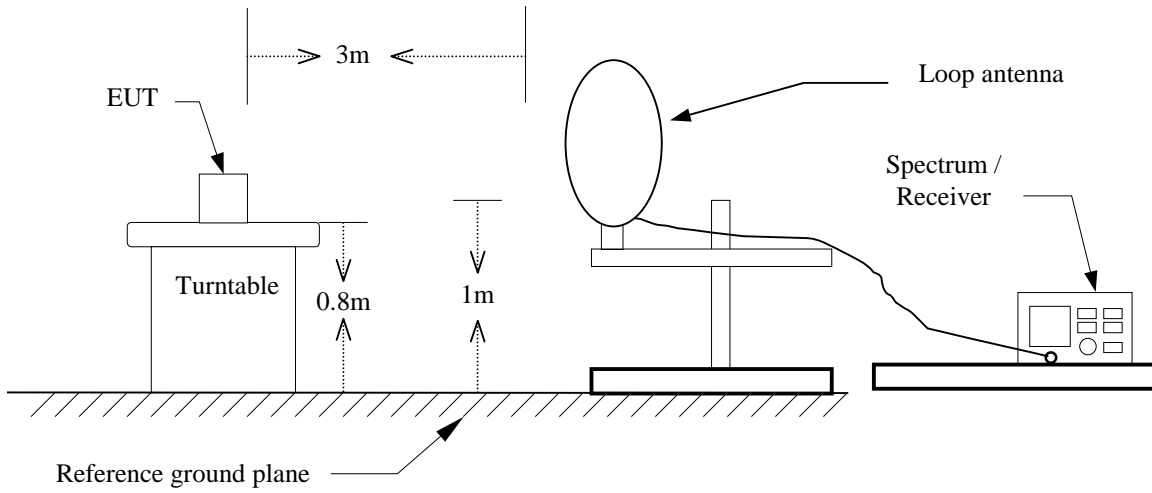

30MHz ~ 1GHz

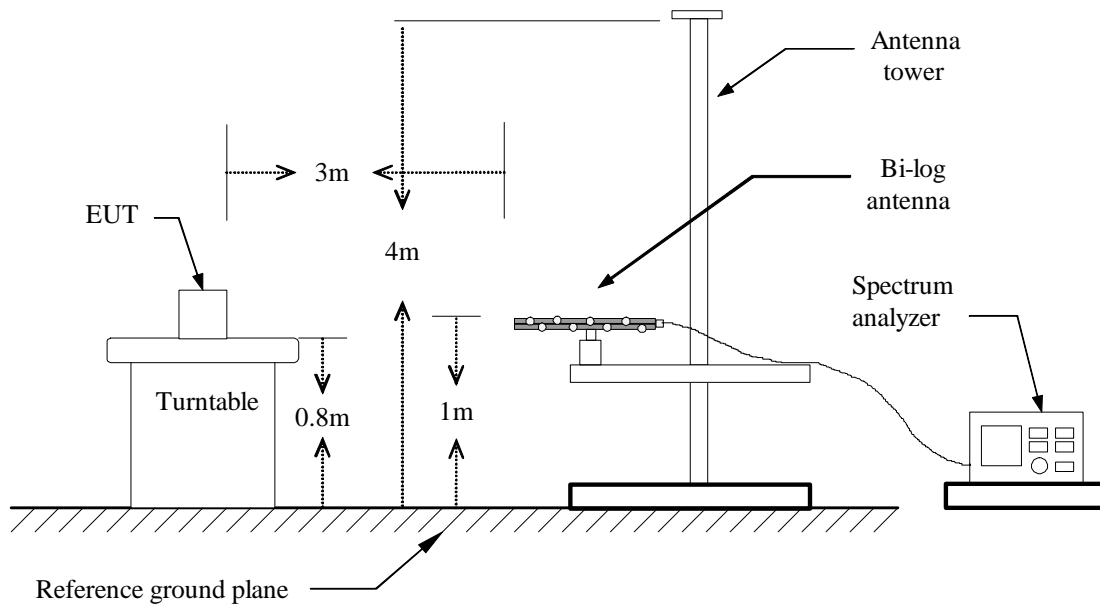



Above 1 GHz

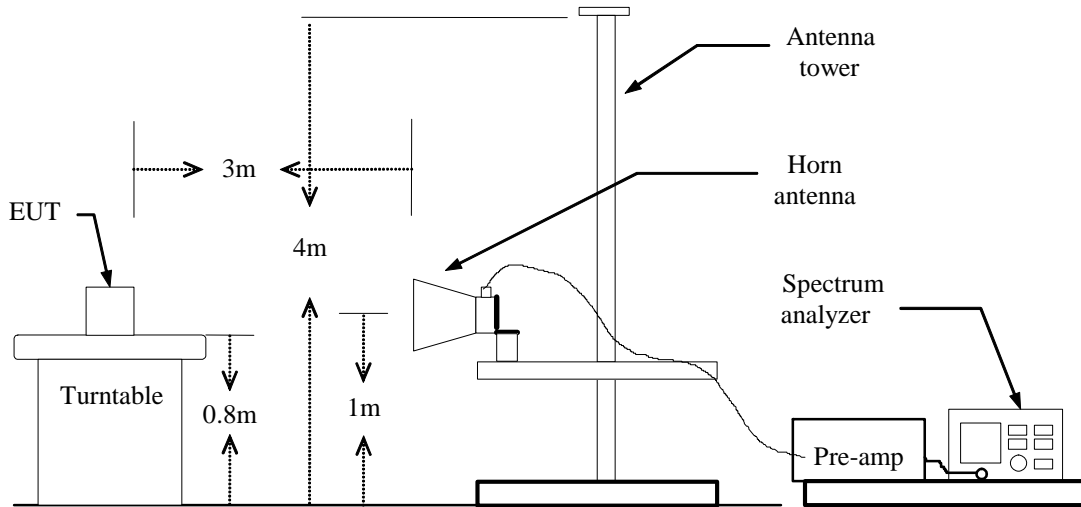



TEST PROCEDURE

1. The EUT is placed on a turntable, which is 0.8m above ground plane.
2. The turntable shall be rotated for 360 degrees to determine the position of maximum emission level.
3. EUT is set 3m away from the receiving antenna, which is varied from 1m to 4m to find out the highest emissions.
4. Maximum procedure was performed on the six highest emissions to ensure EUT compliance.
5. And also, each emission was to be maximized by changing the polarization of receiving antenna both horizontal and vertical.
6. Set the spectrum analyzer in the following setting as:
Below 1GHz:
RBW=100kHz / VBW=300kHz / Sweep=AUTO
Above 1GHz:
(a) PEAK: RBW=1MHz / VBW=3MHz / Sweep=AUTO
(b) AVERAGE: RBW=1MHz / VBW=10Hz / Sweep=AUTO
7. Repeat above procedures until the measurements for all frequencies are complete.

**Below 1 GHz**

Operation Mode: Normal Link **Test Date:** January 19, 2012
Temperature: 23°C **Tested by:** Ali Shu
Humidity: 46 % RH **Polarity:** Ver. / Hor.

Frequency (MHz)	Reading (dBuV)	Correction Factor (dB/m)	Result (dBuV/m)	Limit (dBuV/m)	Margin (dB)	Remark	Ant.Pol. (H/V)
38.08	60.54	-25.90	34.64	40.00	-5.36	QP	V
42.93	65.33	-29.24	36.09	40.00	-3.91	QP	V
73.65	67.55	-33.04	34.51	40.00	-5.49	Peak	V
429.32	61.36	-23.26	38.10	46.00	-7.90	Peak	V
896.53	57.13	-16.04	41.09	46.00	-4.91	Peak	V
935.33	56.98	-16.13	40.85	46.00	-5.15	QP	V
975.75	57.37	-15.60	41.77	54.00	-12.23	Peak	V
70.42	66.36	-32.85	33.51	40.00	-6.49	Peak	H
311.30	62.42	-26.12	36.30	46.00	-9.70	Peak	H
663.73	61.58	-19.34	42.24	46.00	-3.76	QP	H
676.67	58.99	-19.21	39.78	46.00	-6.22	Peak	H
702.53	59.14	-18.94	40.20	46.00	-5.80	Peak	H
741.33	57.94	-18.26	39.68	46.00	-6.32	Peak	H
896.53	58.96	-16.04	42.92	46.00	-3.08	QP	H

Remark:

1. No emission found between lowest internal used/generated frequency to 30MHz (9kHz~30MHz).
2. Radiated emissions measured were made with an instrument using peak/quasi-peak detector mode.
3. Quasi-peak test would be performed if the peak result were greater than the quasi-peak limit or as required by the applicant.
4. Measurements above show only up to 6 maximum emissions noted, or would be lesser; with " N/A " remark, if no specific emissions from the EUT are recorded (ie: margin>20dB from the applicable limit) and considered that's already beyond the background noise floor.
5. $Margin (dB) = Remark\ result (dBuV/m) - Quasi-peak\ limit (dBuV/m)$.



Above 1 GHz

Operation Mode: TX / CH Low **Test Date:** January 19, 2012
Temperature: 23°C **Tested by:** Ali Shu
Humidity: 46 % RH **Polarity:** Ver. / Hor.

Frequency (MHz)	Reading (Peak) (dBuV)	Reading (Average) (dBuV)	Correction Factor (dB/m)	Result (Peak) (dBuV/m)	Result (Average) (dBuV/m)	Limit (Peak) (dBuV/m)	Limit (Average) (dBuV/m)	Margin (dB)	Remark	Ant.Pol. (H/V)
1603.33	61.75	55.51	-9.50	52.25	46.01	74.00	54.00	-7.99	AVG	V
4808.33	51.13	49.27	2.58	53.71	51.85	74.00	54.00	-2.15	AVG	V
N/A										
1603.33	59.82	59.79	-9.50	50.32	50.29	74.00	54.00	-3.71	AVG	H
4808.33	48.98	---	2.58	51.55	---	74.00	54.00	-2.45	Peak	H
N/A										

Remark:

1. Measuring frequencies from 1 GHz to the 10th harmonic of highest fundamental frequency.
2. Radiated emissions measured in frequency above 1000MHz were made with an instrument using peak/average detector mode.
3. Average test would be performed if the peak result were greater than the average limit or as required by the applicant.
4. Data of measurement within this frequency range shown “ --- ” in the table above means the reading of emissions are attenuated more than 20dB below the permissible limits or the field strength is too small to be measured.
5. Measurements above show only up to 6 maximum emissions noted, or would be lesser, with “ N/A ” remark, if no specific emissions from the EUT are recorded (ie: margin>20dB from the applicable limit) and considered that's already beyond the background noise floor.
6. Peak Margin (dB) = Peak result (dBuV/m) – Peak limit (dBuV/m).
Average Margin (dB) = Peak result (dBuV/m) – Average limit (dBuV/m).



Operation Mode: TX / CH Mid **Test Date:** January 19, 2012
Temperature: 23°C **Tested by:** Ali Shu
Humidity: 46 % RH **Polarity:** Ver. / Hor.

Frequency (MHz)	Reading (Peak) (dBuV)	Reading (Average) (dBuV)	Correction Factor (dB/m)	Result (Peak) (dBuV/m)	Result (Average) (dBuV/m)	Limit (Peak) (dBuV/m)	Limit (Average) (dBuV/m)	Margin (dB)	Remark	Ant.Pol. (H/V)
1626.67	61.74	60.31	-9.26	52.47	51.05	74.00	54.00	-2.95	AVG	V
4883.33	52.99	50.59	2.73	55.72	53.32	74.00	54.00	-0.68	AVG	V
N/A										
1626.67	56.45	---	-9.26	47.18	---	74.00	54.00	-6.82	Peak	H
N/A										

Remark:

1. Measuring frequencies from 1 GHz to the 10th harmonic of highest fundamental frequency.
2. Radiated emissions measured in frequency above 1000MHz were made with an instrument using peak/average detector mode.
3. Average test would be performed if the peak result were greater than the average limit or as required by the applicant.
4. Data of measurement within this frequency range shown “ --- ” in the table above means the reading of emissions are attenuated more than 20dB below the permissible limits or the field strength is too small to be measured.
5. Measurements above show only up to 6 maximum emissions noted, or would be lesser, with “ N/A ” remark, if no specific emissions from the EUT are recorded (ie: margin>20dB from the applicable limit) and considered that's already beyond the background noise floor.
6. Peak Margin (dB) = Peak result (dBuV/m) – Peak limit (dBuV/m).
Average Margin (dB) = Peak result (dBuV/m) – Average limit (dBuV/m).



Operation Mode: TX / CH High **Test Date:** January 19, 2012
Temperature: 23°C **Tested by:** Ali Shu
Humidity: 46 % RH **Polarity:** Ver. / Hor.

Frequency (MHz)	Reading (Peak) (dBuV)	Reading (Average) (dBuV)	Correction Factor (dB/m)	Result (Peak) (dBuV/m)	Result (Average) (dBuV/m)	Limit (Peak) (dBuV/m)	Limit (Average) (dBuV/m)	Margin (dB)	Remark	Ant. Pol. (H/V)
1653.33	61.07	59.66	-8.99	52.08	50.67	74.00	54.00	-3.33	AVG	V
4958.33	53.14	50.08	2.88	56.01	52.96	74.00	54.00	-1.04	AVG	V
N/A										
1653.33	55.25	---	-8.99	46.26	---	74.00	54.00	-7.74	Peak	H
N/A										

Remark:

1. Measuring frequencies from 1 GHz to the 10th harmonic of highest fundamental frequency.
2. Radiated emissions measured in frequency above 1000MHz were made with an instrument using peak/average detector mode.
3. Average test would be performed if the peak result were greater than the average limit or as required by the applicant.
4. Data of measurement within this frequency range shown “ --- ” in the table above means the reading of emissions are attenuated more than 20dB below the permissible limits or the field strength is too small to be measured.
5. Measurements above show only up to 6 maximum emissions noted, or would be lesser, with “ N/A ” remark, if no specific emissions from the EUT are recorded (ie: margin>20dB from the applicable limit) and considered that's already beyond the background noise floor.
6. Peak Margin (dB) = Peak result (dBuV/m) – Peak limit (dBuV/m).
Average Margin (dB) = Peak result (dBuV/m) – Average limit (dBuV/m).



7.8 POWERLINE CONDUCTED EMISSIONS

LIMIT

According to §15.207(a), except as shown in paragraphs (b) and (c) of this section, for an intentional radiator that is designed to be connected to the public utility (AC) power line, the radio frequency voltage that is conducted back onto the AC power line on any frequency or frequencies within the band 150 kHz to 30 MHz shall not exceed the limits in the following table, as measured using a 50 μ H/50 ohms line impedance stabilization network (LISN). Compliance with the provisions of this paragraph shall be based on the measurement of the radio frequency voltage between each power line and ground at the power terminal. The lower limit applies at the boundary between the frequency ranges.

Frequency Range (MHz)	Limits (dB μ V)	
	Quasi-peak	Average
0.15 to 0.50	66 to 56*	56 to 46*
0.50 to 5	56	46
5 to 30	60	50

* Decreases with the logarithm of the frequency.

Test Configuration

See test photographs attached in Appendix II for the actual connections between EUT and support equipment.

TEST PROCEDURE

1. The EUT was placed on a table, which is 0.8m above ground plane.
2. Maximum procedure was performed on the six highest emissions to ensure EUT compliance.
3. Repeat above procedures until all frequency measured were complete.

TEST RESULTS

The initial step in collecting conducted data is a spectrum analyzer peak scan of the measurement range. Significant peaks are then marked as shown on the following data page, and these signals are then quasi-peaked.



Test Data

Model No.	Z-217x (x: 0~9)	6dB Bandwidth	10 kHz
Environmental Conditions	24°C, 60% RH, 1003mbar	Test Mode	Mode 1
Tested by	Kevin Wang	Phase	L1

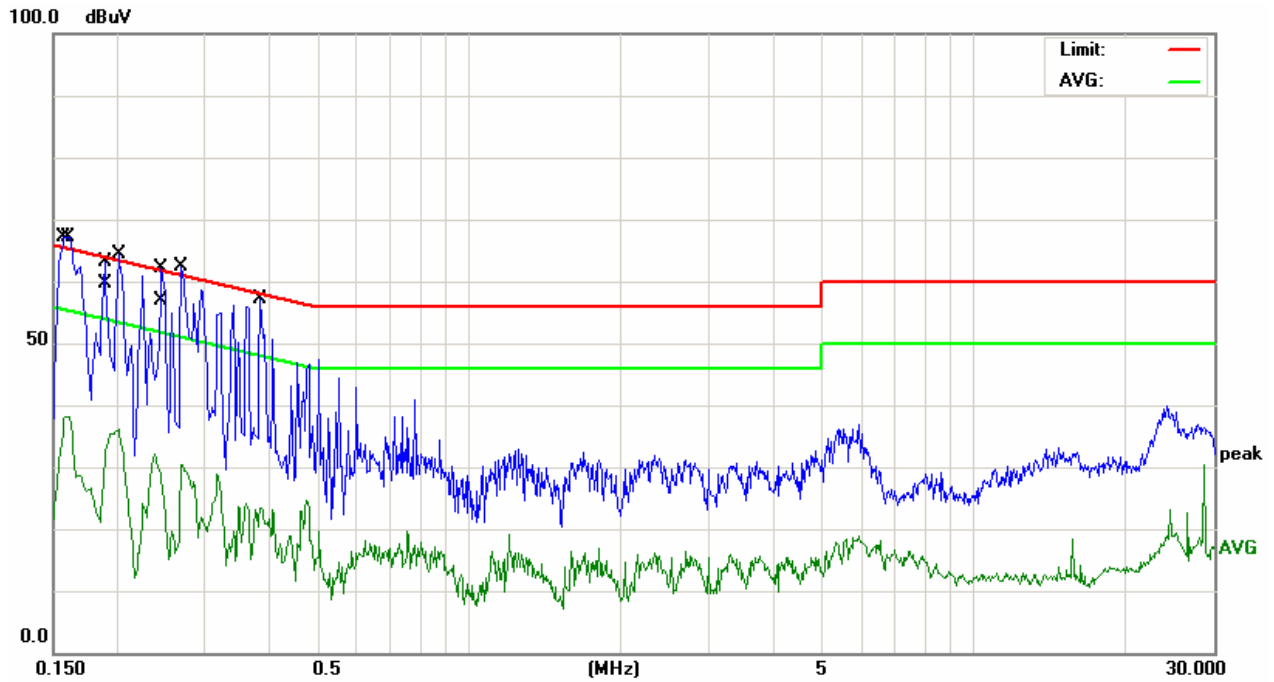

Conducted Emission Readings							
Frequency Range Investigated				150 kHz to 30 MHz			
Freq. (MHz)	Reading (dBuV)	Factor (dB)	Result (dBuV)	Limit (dBuV)	Margin (dB)	Detector (P/Q/A)	Line (L1/L2)
0.1580	48.19	10.30	58.49	65.56	-7.07	Q	L1
0.1607	27.87	10.29	38.16	55.42	-17.26	A	L1
0.1900	44.61	10.21	54.82	64.03	-9.21	Q	L1
0.1924	23.84	10.20	34.04	53.93	-19.89	A	L1
0.2020	43.94	10.18	54.12	63.52	-9.40	Q	L1
0.2020	25.97	10.18	36.15	53.52	-17.37	A	L1
0.2404	20.75	10.16	30.91	52.08	-21.17	A	L1
0.2460	36.55	10.15	46.70	61.89	-15.19	Q	L1
0.2700	38.43	10.16	48.59	61.12	-12.53	Q	L1
0.2700	20.12	10.16	30.28	51.12	-20.84	A	L1
0.3860	28.77	10.08	38.85	58.15	-19.30	Q	L1
0.3860	13.35	10.08	23.43	48.15	-24.72	A	L1



Model No.	Z-217x (x: 0~9)	6dB Bandwidth	10 kHz
Environmental Conditions	24°C, 60% RH, 1003mbar	Test Mode	Mode 1
Tested by	Kevin Wang	Phase	L2

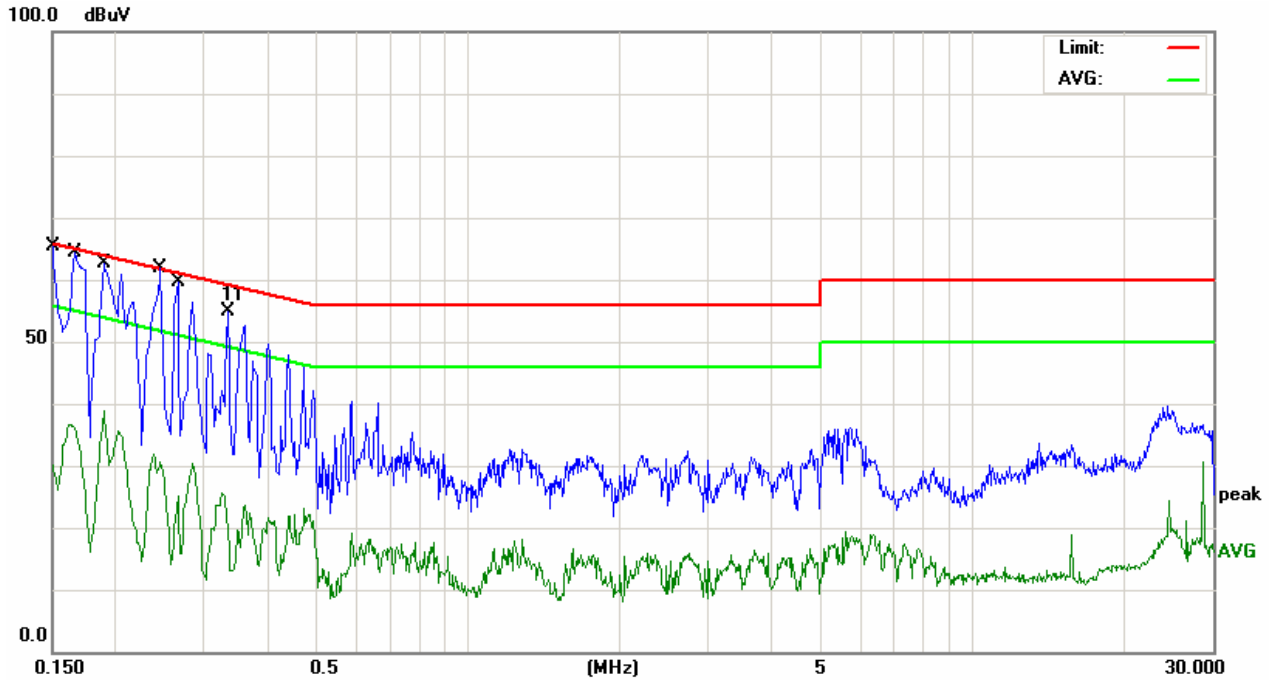

Conducted Emission Readings							
Frequency Range Investigated				150 kHz to 30 MHz			
Freq. (MHz)	Reading (dBuV)	Factor (dB)	Result (dBuV)	Limit (dBuV)	Margin (dB)	Detector (P/Q/A)	Line (L1/L2)
0.1500	51.00	10.15	61.15	65.99	-4.84	Q	L2
0.1500	20.06	10.15	30.21	55.99	-25.78	A	L2
0.1660	49.08	10.12	59.20	65.15	-5.95	Q	L2
0.1660	26.08	10.12	36.20	55.15	-18.95	A	L2
0.1883	26.19	10.06	36.25	54.11	-17.86	A	L2
0.1900	48.46	10.06	58.52	64.03	-5.51	Q	L2
0.2460	42.37	10.02	52.39	61.89	-9.50	Q	L2
0.2460	20.61	10.02	30.63	51.89	-21.26	A	L2
0.2660	39.38	10.03	49.41	61.24	-11.83	Q	L2
0.2672	12.24	10.03	22.27	51.20	-28.93	A	L2
0.3339	44.90	10.00	54.90	59.35	-4.45	P	L2
0.3339	9.49	10.00	19.49	49.35	-29.86	A	L2