

Handheld Computer

Z-2060 series

(Version 1.00)

User's Manual

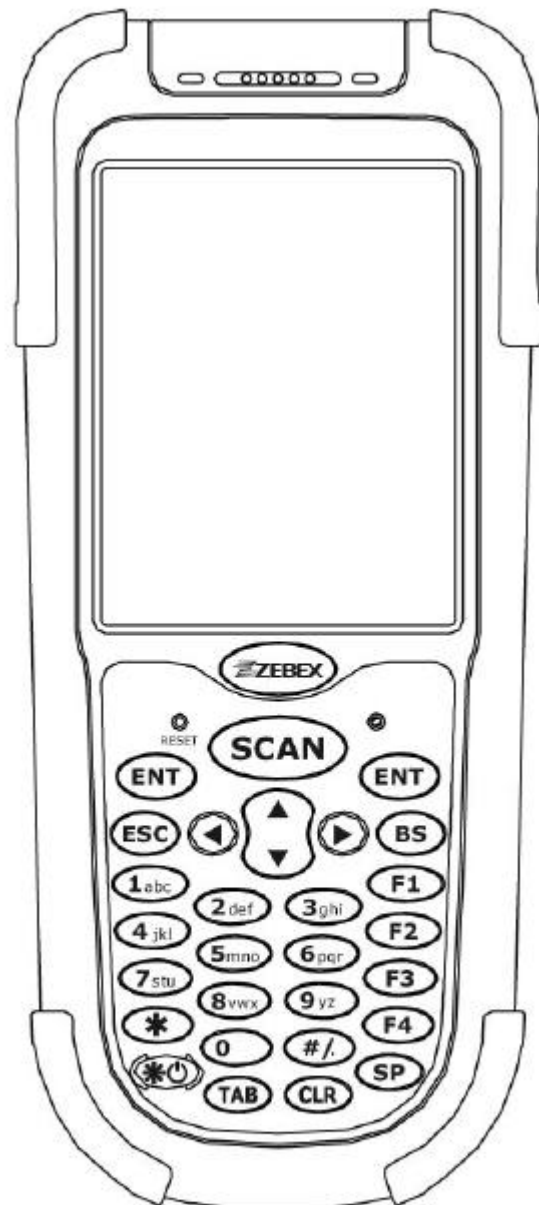

ZEBEX INDUSTRIES INC.

www.zebex.com

Editorial Record

Version	Date of edited	Page	Content
1.00	2008.12.18	20	Available models and the features
1.00	2008.12.18	21	Specifications

Table of Contents

Preface

About This Manual	4
Symbols used in this manual	4
Copyright	5
Safety Information	5
Laser Safety.....	5
Safety Operation	6
Federal Communication Commission (FCC) Statement	7

Unpacking

Package Contents	8
Optional Parts.....	9
Cradle package	9
Purchaseable accessories.....	9
General Guide.....	10

Getting Start

Inserting the Battery	12
Remove the Battery.....	12
Charging the Battery.....	13
Charging by cable	13
Charging by cradle.....	13
Charging the battery separately in the cradle	14
System Reset	16
Using the Warm reset function	16
Using the Cold reset function	16
PC System Requirements	17
Connecting To a PC.....	17
Connecting via the RS232	17
Connecting via USB Cradle	18
Connecting the Z-2060 directly via Mini USB	18
Inserting SD Card	19
Remove the SD Card.....	19
About The Product	20
Prerequisites	20
Specifications	21

Using Barcode Scanner

Scanning Barcodes.....	22
------------------------	----

Preface

About This Manual

Thank you for your purchase of the ZEBEX Z-2060 series handheld computer. ZEBEX Z-2060 series product is at the forefront of handheld computer technology, and this manual will provide the necessary information on the many and varied options available to you.

The Z-2060 series product is a compact, ergonomic and durable handheld computer. It is designed with an integrated 802.11b/g wireless communication, 1D/2D barcode scanner, touch screen and 29-keys keypad. The design complies with IP64 regulations and is ideal for the mobile worker as it is simple and easy to use anywhere along a supply chain.

Symbols used in this manual



A triangular shape indicates you should exercise caution.



A circle shape indicates something you should not do.



A black circle indicates something you must do.



A note symbol indicates you the information that is important and you should be observed.

FCC RF Radiation Exposure Statement:

This transmitter must not be co-located or operating in conjunction with any other antenna or transmitter.

1. This equipment complies with FCC RF radiation exposure limits set forth for an uncontrolled environment. This equipment should be installed and operated with a minimum distance of 20 centimeters between the radiator and your body.

Copyright

ZEBEX Industries Inc. makes no warranty of any kind with regard to this material. Including but not limited to the implied warranties of merchantability and fitness for a particular purpose. ZEBEX Industries Inc. shall not be liable for errors contained herein or for incidental consequential damages in connection with the furnishing, Performance or use of this product.

ZEBEX Industries Inc. will be under no liability in respect of any defect arising from fair wear and tear, willful damage, negligence, abnormal working conditions, failure to follow the instructions and warnings, or misuse or alteration or repair of the products without written approval.

No part of this document may be reproduced, transmitted, stored in a retrieval system, transcribed or translated into any language or computer language in any form or by any means electronic, mechanical, magnetic, optical, chemical, manual or otherwise, with express written consent and authorization.

We reserve the right to make changes in product design without reservation and without notification. The material in this guide is for information only and is subject to change without notice.

ZEBEX is a registered trademark of ZEBEX INDUSTRIES INC.

©Copyright 2008 ZEBEX.

Safety Information

Your safety is of the utmost importance so please observe and follow the following guidelines that allow you to use the scanner in a safe and responsible way.

Laser Safety

The Z-2060 series handheld computer complies with safety standard IEC825-1(1993) for a Class 2 laser product. It also complies with U.S.21CFR1040 as applicable to a Class II laser product. Avoid staring at direct laser light as the laser beam may hurt your eyes.



LASER BEAM

Never look directly into the laser beam. Doing so can cause serious eye damage.

Safety Operation

WARNING



Disassembly and Modification

Never try to disassemble or modify the device in any way. All servicing should be carried out by qualified Zebex personnel or Zebex- approved engineers.



Interior Parts and Components

Never touch interior high voltage parts or components. Doing so creates the danger of electrical shock.



Drop and Knock the Device

Be careful when using the device; do not drop or knock the device as irreversible damage to the unit may occur.



Extreme temperature

Do not operate the device under extreme temperature.



Battery and Charger

The use of third-party battery or charger may either damage the device or shorten the life of the device.

CAUTION



Dropping and Damage

Should the drop the device and damage it, immediately turn off the power and contact your original dealer or an authorized ZEBEX service provider. Continued use creates the danger of fire and electrical shock.



Abnormal Conditions

Should the device become hot or start to emit smoke or an original dealer or an authorized ZEBEX service provider. Continued use creates the danger of fire and electrical shock.



Foreign Objects

Should any foreign matter ever get into the device, immediately turn off the power and contact your original dealer or an authorized ZEBEX service provider. Continued use creates the danger of fire and electrical shock.



Moisture

Keep the device away from vases, planters, cups, glasses and other containers of liquid. Also keep it away from metal. Water and metal getting into the device creates the danger of fire and electrical shock.

Keep the device away from vases, planters, cups, glasses and other containers of liquid. Also keep it away from metal. Water and metal getting into the device creates the danger of fire and electrical shock.

Federal Communication Commission (FCC) Statement

15.21

You are cautioned that changes or modifications not expressly approved by the part responsible for compliance could void the user's authority to operate the equipment.

15.105(b)

This equipment has been tested and found to comply with the limits for a Class B digital device, pursuant to part 15 of the FCC rules. These limits are designed to provide reasonable protection against harmful interference in a residential installation. This equipment generates uses and can radiate radio frequency energy and, if not installed and used in the accordance with the instructions, may cause harmful interference to radio communications. However, there is no guarantee that interference will not occur in a particular installation. If this equipment does cause harmful interference to radio or television reception, which can be determined by turning the equipment off and on, the user is encouraged to try to correct the interference by one or more of the following measures:

- Reorient or relocate the receiving antenna.
- Increase the separation between the equipment and receiver.
- Connect the equipment into an outlet on a circuit different from that to which the receiver is connected.
- Consult the dealer or an experienced radio/TV technician for help.

Operation is subject to the following two conditions: This device may not cause interference;

This device must accept any interference, including interference that may cause undesired operation of the device.

Unpacking

Package Contents

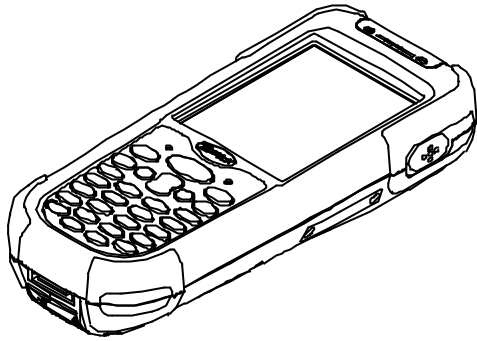

Z-2060 series
Mobile Data Terminal

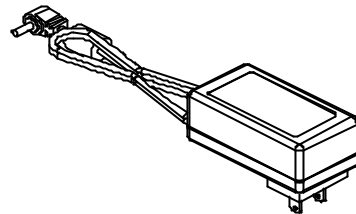

AC Adapter

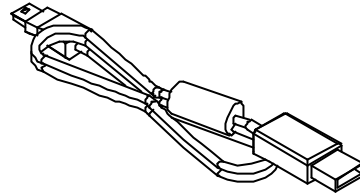

USB cable
(Terminal to PC USB port)

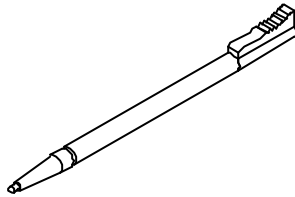

Stylus Pen

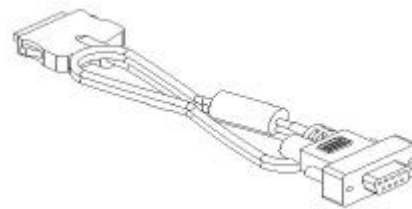

RS-232 DB9 (F) Cable

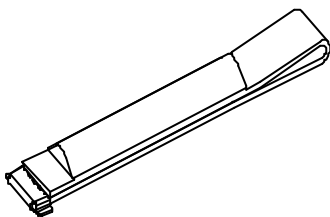

Hand Strip

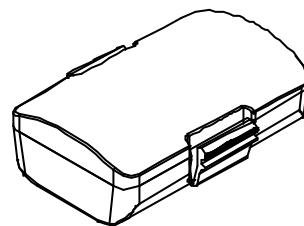

Battery Pack

Optional Parts

Cradle package

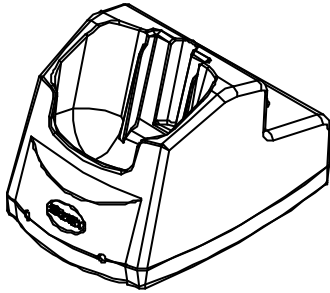
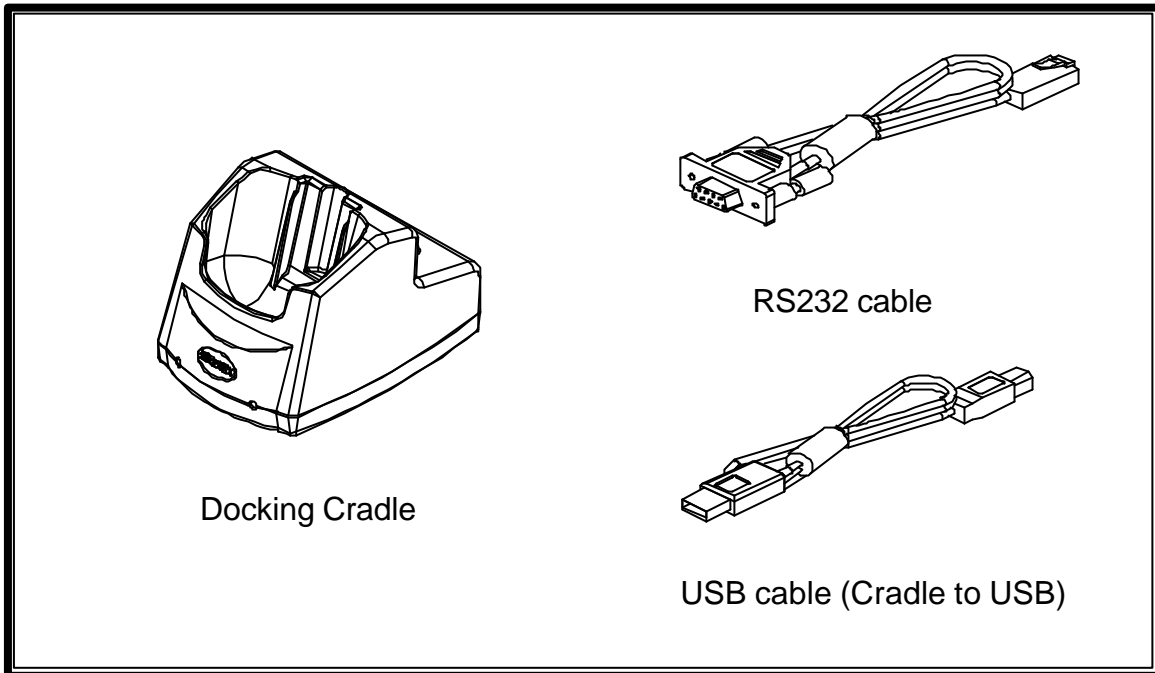

Docking Cradle

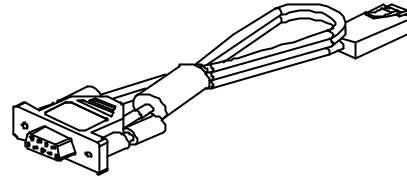

RS232 cable

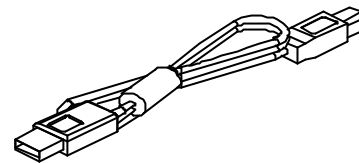

USB cable (Cradle to USB)

Purchaseable accessories

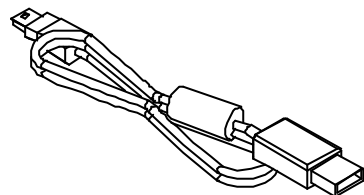
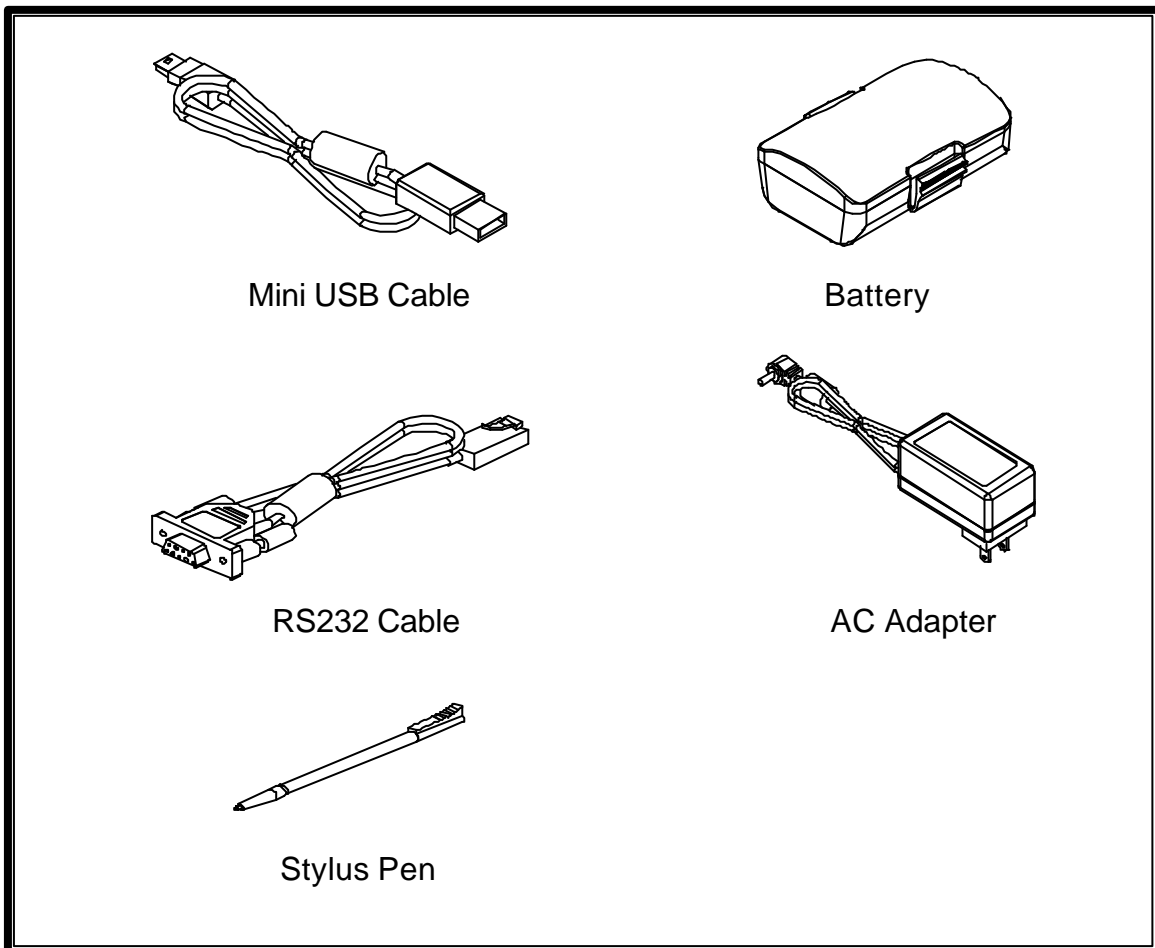

Mini USB Cable

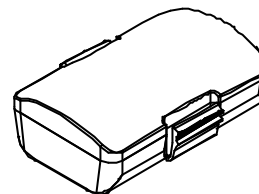

Battery

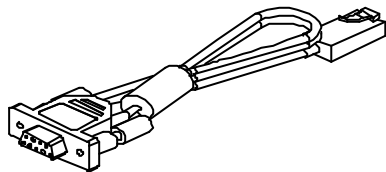

RS232 Cable

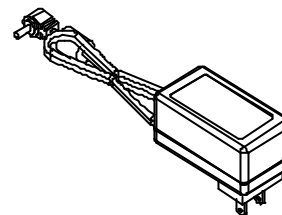

AC Adapter

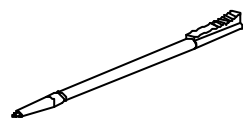

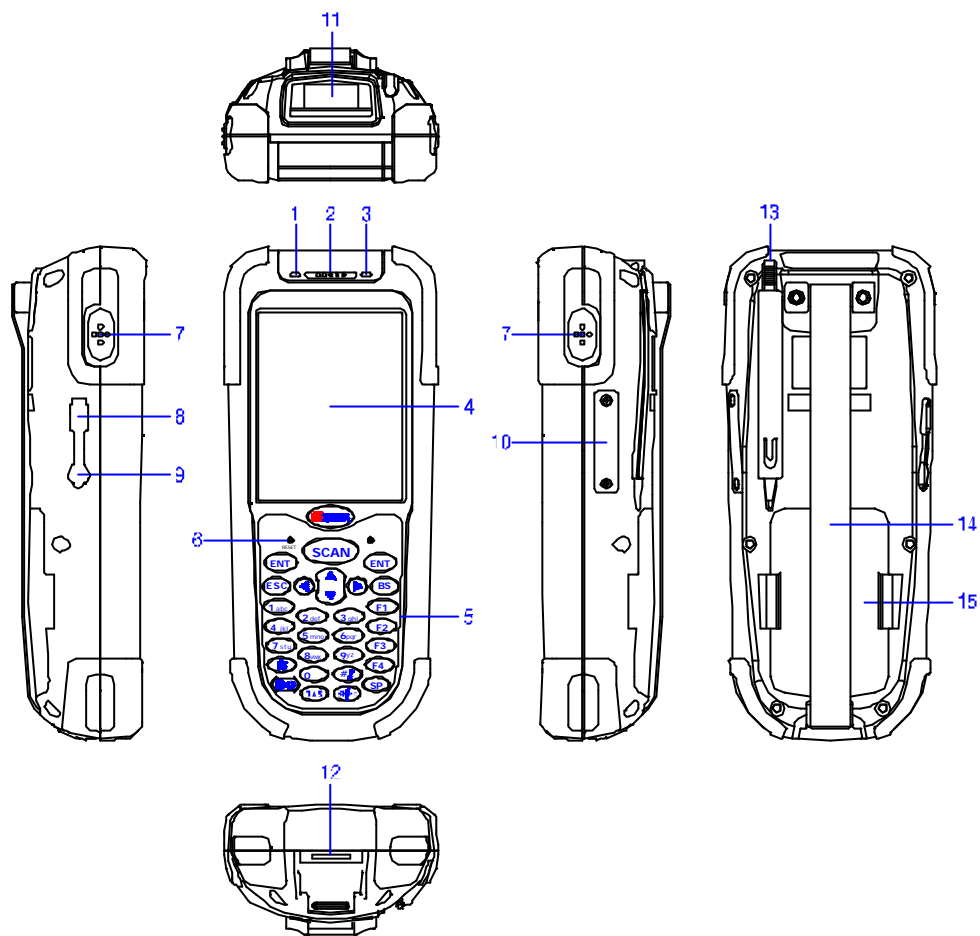

Stylus Pen

General Guide

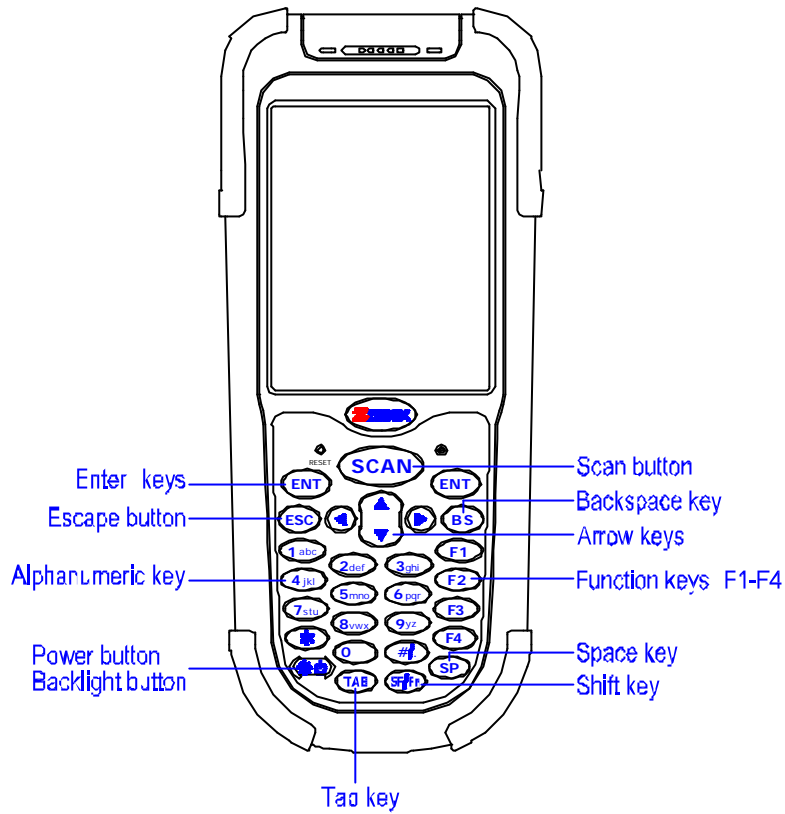

1	LED indicator	Indicates the status of read bar code or battery charge : Green for successful read barcode or full charge of battery. Red for battery just on charging.
2	Buzzer	Outputs operation confirmation tones.
3	LED indicator for WI-FI	Flashes in red when operating via WLAN communication
4	LCD screen	Display various data when a program is being run.
5	Stroke keys	A total of 29 keys are provided to turn power ON or OFF and other operations.
6	Reset switch (inside the hole)	Use reset needle (take off the other side of stylus pen cover) to press the RESET switch located inside the hole.
7	Scan button	For Barcode reading.
8	Mini USB port	This port is for USB communication with PC.
9	Ear Jack	Listens to the voice.
10	Mini SD I/O card slot	Install the Mini SD I/O card
11	Scan windows	Emits a laser for bar code reading.
12	RS-232 port	This port is for RS-232 communication with PC
13	Stylus pen	For touch screen operation and press RESET switch.
14	Hand strip	Protects the Handheld Terminal to drop.
15	Battery	Main battery



Arrow	Arrow keys	Press these to move around the screen.
ENT	Enter key	Press to confirm entries or commands.
0-9	Alphanumeric keypad	Press to enter numerical or alphabetical data.
F1-F4	Function keys	Press to access function keys 1-4.
BS	Backspace key	Press to move cursor and deletes the previous character each time.
	Power/Backlight on key	<ol style="list-style-type: none"> 1. Press to turn the power on. 2. Press more then 3 seconds for turn the terminal power off and go into the suspend mode. 3. Press to turn the LCD backlight on when it is off.
ESC	Escape key	Press to perform a cancel action.
SCAN	Scan key	Press and hold to scan a barcode.
SF/Fn	Shift key	<p>The key is used in combination with other keys to type special characters or perform other function keys.</p> <ol style="list-style-type: none"> 1. Press after SF/Fn key and press Up key to turn the input method into upper alphabetical. 2. Press after SF/Fn key and press Down key to turn the input method into lower alphabetical. 3. Press after SF/Fn key and press Left or Right key to turn the input method into numerical. 4. Press after SF/Fn key and press F1-F4 key to perform F5 - F8 key.
TAB	Tab key	Press to add a tab indention.
SP	Space key	Press to add a space character.

Getting Started

Inserting the Battery

Insert the battery pack as shown and watch the battery direction..

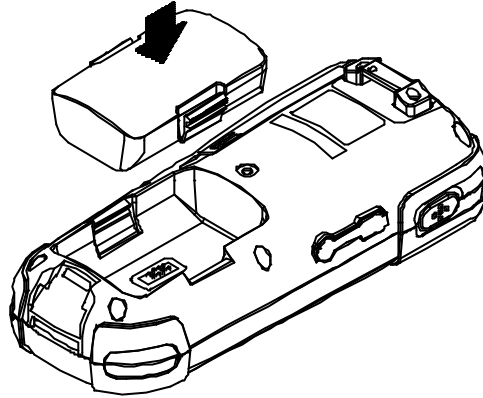

Remove the Battery

Push the side lock to pick up the battery pack.

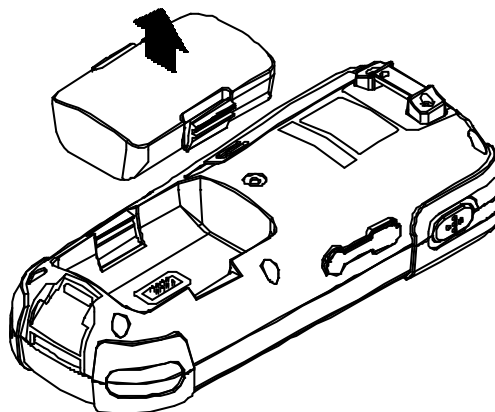
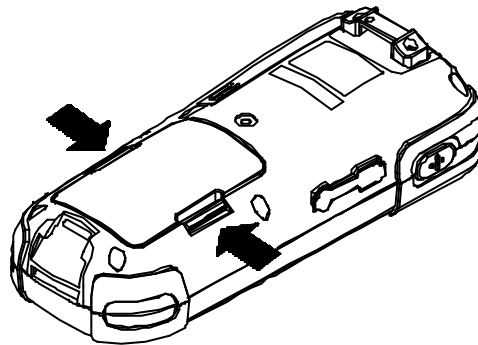

Charging the Battery

The Li-ion rechargeable battery can be charged while inserted in the device itself or independently via the recharging slot at the back of the cradle.

Charging by cable

Connect the charging cable and AC adaptor as shown.

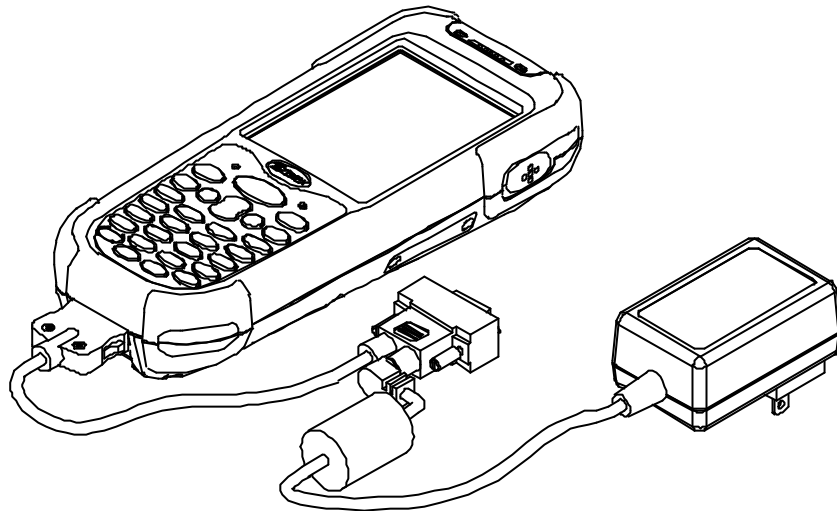

Charging by cradle

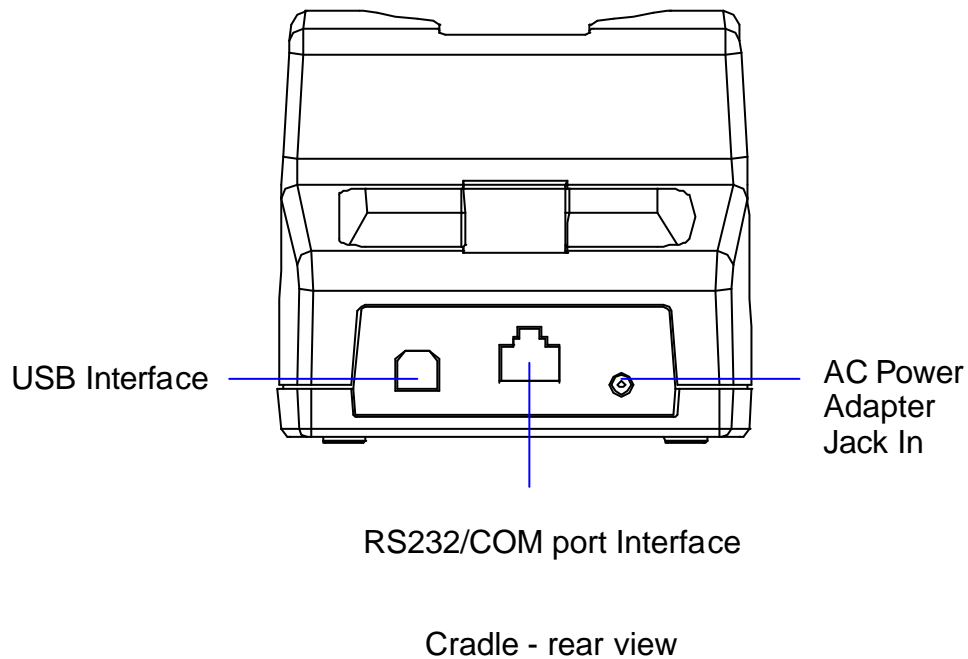

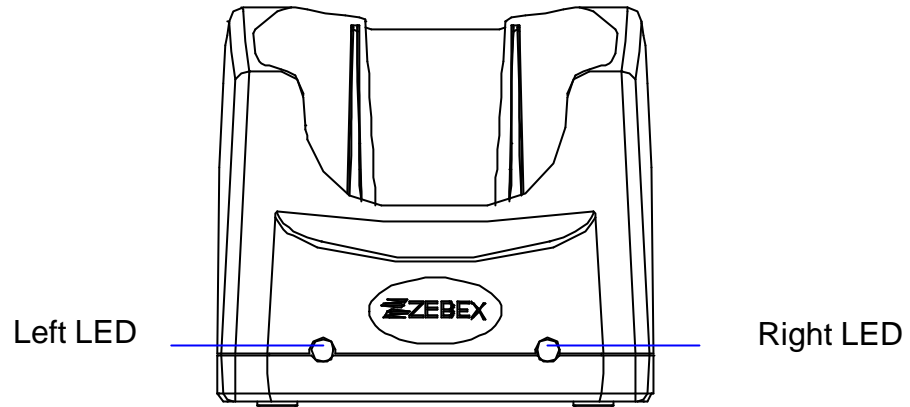

Cradle - front view

Cradle LEDs

Left LED - The LED lit when a battery is inserted into the rear battery slot of the cradle for recharge. It remains lit until the charge is complete.

Right LED - The LED lit when the cradle is connected to AC power.

Charging the battery separately in the cradle

Insert the battery into the compartment at the rear of the cradle.

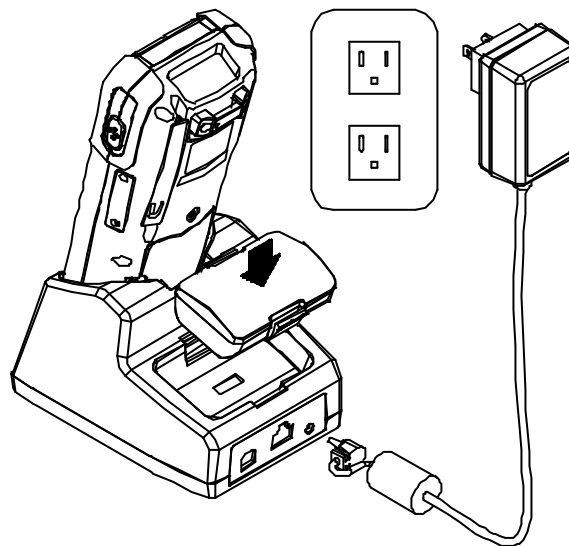

Connect the power jack to the cradle and plug AC adapter into the socket.

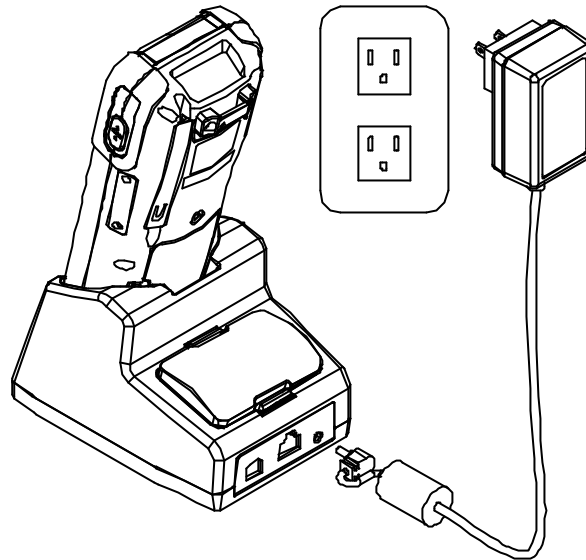

NOTES

When charging the battery for the first time, charge for at least 12 hours prior to use.

System Reset

Using the Warm reset function

Warm reset function allows you to return the device to the default settings, while not wiping all data from the memory.

Insert the needle into the reset hole as shown and press down gently, to reset the device.

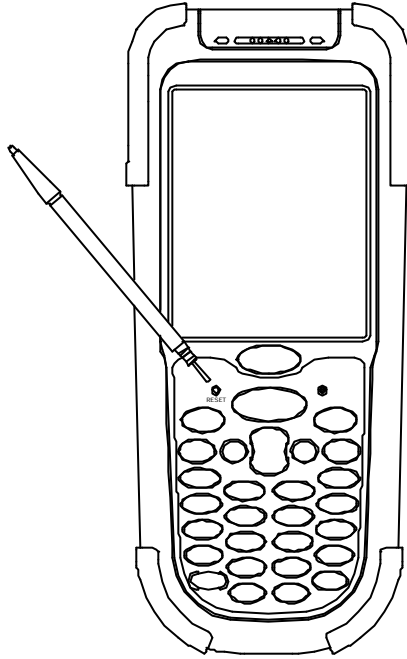

Using the Cold reset function

Cool reset function allows you to return the device to the factory settings, while wiping all data from the memory.

Press down and hold the power key and Insert the needle into the reset hole to cool reset the device.



WARNING

Cold reset will erase ALL pre-configured data on the scanner. Check carefully to make sure you have uploaded all important files to your PC before proceeding with the reset.

PC System Requirements

Windows XP Operating System
64 MB RAM
50 MB free HDD space
Interface : USB / RS-232 ports
WLAN transmitter (optional)

Connecting To a PC

In order to use the software supplied with the Z-2060, the mobile data terminal must be connected to a PC.

Connecting via the RS232

In order for the sync software to work properly, the cradle must be connected to your computer's COM port. Attach one end of the RS232 cable to the RS232/COM interface connector on the cradle and the other to the COM1 port on your PC.

1. Or can use attach one RS-232 cable to connect with your computer's COM port directly.

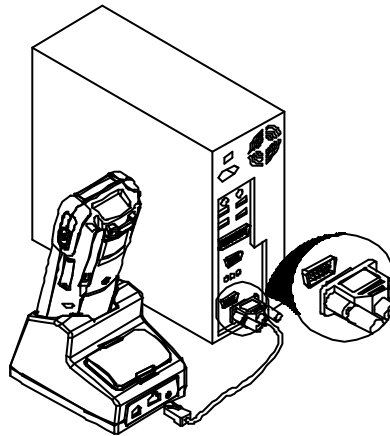

Connecting via USB Cradle

The cradle must also be connected via one of your PC's USB ports. Attach one end of the cable to the USB interface on the cradle and the other to your PC.

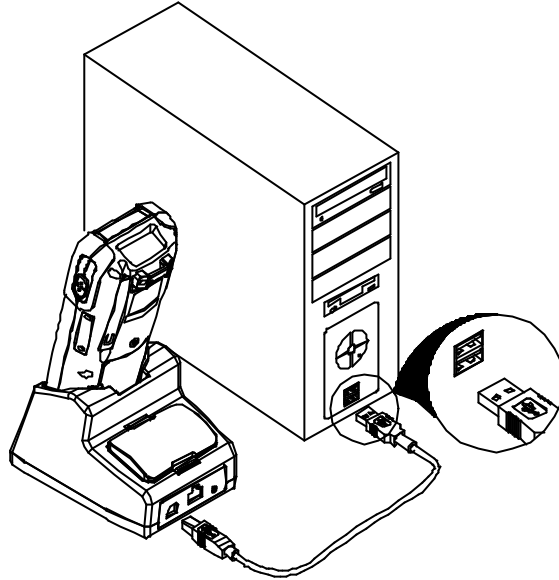

Connecting the Z-2060 directly via Mini USB

You can connect the Z-2060 directly to your PC, without the need for the cradle, using the Mini USB cable, attaching it to the port on the left hand side of the device.

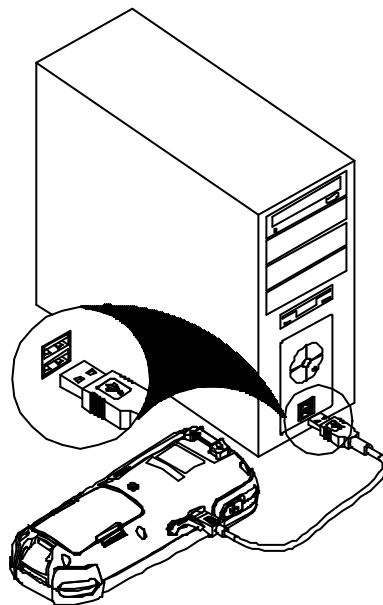

Inserting SD Card

1. Make sure the power is turn off.
2. Open the SD Slot cover as shown, Insert the SD card.
3. Close the SD slot Cover.

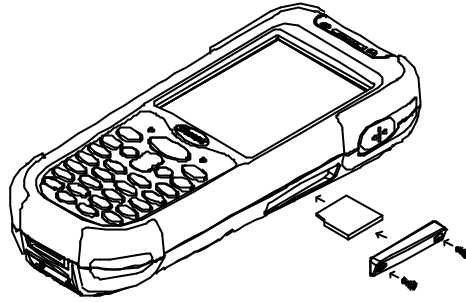

Remove the SD Card

1. Make sure the power is turn off.
2. Open the SD Slot cover as shown, Take off the SD card.
3. Closed the SD slot cover.

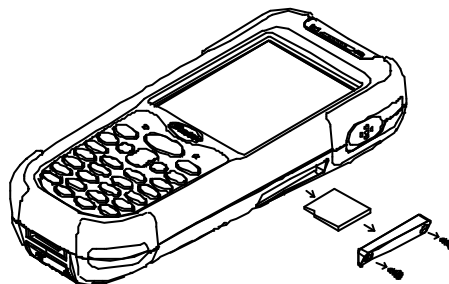

About The Product

The Z-2060 is a compact, ergonomic and durable portable data terminal. It is designed with an integrated wireless communication and 1D/2D barcode data capture touch screen and 29-key keypad. The design is ideal for the mobile worker as it simple and easy to use anywhere along a supply chain. It complies with IP64 regulations, and also support the WLAN communication model by Z-2060WL.

The Z-2060 features a Intel PXA-270 processor (520MHz) and Windows CE.NET version 5.0 operation system. This combination delivers high performance, low power consumption and the diversity of a wireless networking platform. Compared with other systems currently available on the market, Z-2060 is the most cost-effective to offering optimum performance.

Prerequisites

Skills Required

The following skills are required by developers aiming to develop application software for the ZEBEX Z-2060 series.

- ? Windows programming
- ? Good knowledge of one or more of the following:
 - * Visual C++
 - * Visual Basic .NET
 - * Visual studio .NET
 - * Visual C#
 - * Active Server Pages and web programming

The following skills or experiences are also desirable .

- ? Windows CE devices
- ? ActiveSync
- ? Some thing networking experience.

Hardware Required

The following models of the ZEBEX Z-2060 series and the dedicated options are available.

Available models and the features:

Model name	Barcode scanner	IEEE802.11b/g

Specifications

Model	Z-2060 series
System	
CPU	Inter PXA 270 processor (Max. 520MHz)
RAM	64 Mbyte
F-ROM	64 Mbyte
LCD Display	3.5", QVGA 240 X 320 TFT color panel with touch screen
Operating System	Microsoft Windows CE.NET 5.0
Power Management	
Main Battery	3.7V 5,000mAH Li-ion rechargeable battery
Battery Life	8 hours (without wireless communication activated)
Scanning Performance	
Scan Engine	Symbol SE-955 1D laser engine
Light Source	650 nm visible Laser Diode
Scan Rate	100 scans per second
Print Contrast	30% @ UPC/EAN 100%
Decoding Capability	
Barcode Symbologies	UPC/ EAN/ JAN, Code 128/EAN 128, Code 39, Code 93, Interleaved 2 of 5, Discrete 2 of 5, Codabar, MSI/Plessey
Card Slots	1 x Mini SD I/O card
Communications / Interfaces	
IrDA	Standard IrDA 1.3
USB	USB 2.0
RS-232	Programmable up to 115,200 bps
WLAN	802.11 b/g (optional)
Dimensions	190.0 mm (L) x 75.0 mm (W) x 46.6 mm (H)
Weight	Approx. 480 g (battery included)
Environmental	
Operating Temp.	0°C ~ 50°C
Storage Temp	-10°C ~ 60°C
Operating Humidity	10% ~ 70% (non-condensing)
Storage Humidity	5% ~ 70% (non-condensing)
Drop Durability	Withstand 1.2m (4 feet) drop to concrete
Environmental Sealing	IP64 rated sealing
Regulatory Approvals	CE & FCC Part 15B, 15 C
Cradle	Single slot USB / RS-232 charging cradle with spare battery slot
Software & Development	Microsoft VC 6.0 development environment Supports SDK for program development

Using Barcode Scanner

Scanning Barcodes

The Z-2060 is a highly versatile tool that can scan a wide range of barcodes but it is imperative that it is used in the correct manner.

To scan a barcode:

1. Hold the Z-2060 horizontally and point it directly at the barcode you wish to scan.
2. Once in the correct position, press the **SCAN** button.

An audible alarm is heard and the barcode digits will appear on the LCD screen if the scan is successful.

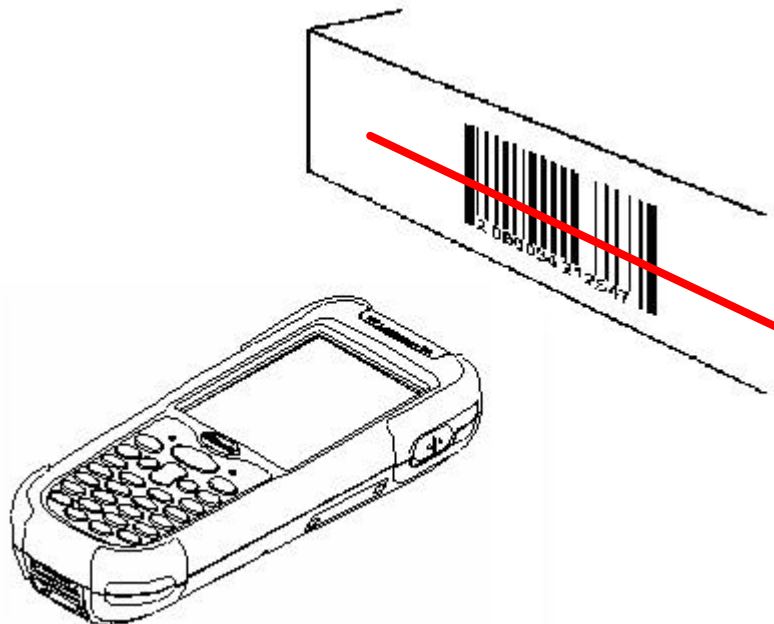

<< MEMO >>

Table of Contents

Preface	
About This Manual.....	4
Dsing the Zebex Power Pack	
Backlight	8
Calculator	10
EasyBeam	11
File Transfer Operation	12
Launcher	14
Launcher Operation	15
Switch	19
TrayScan.....	21
Backup/Restore.....	24
Firmware Information.....	26
Shortcut Manager	27

Preface

About This Manual

Thank you for your purchase of the ZEBEX WinCE base handheld computer product. For reduced your software development effort and save your time to development the application program on our WinCE device. ZEBEX create our own design management solution, called "Power Pack" utility, for let you control our WinCE device system function easily.

The Power Pack utility was separated into two parts, single device management utilities and group device management utilities. Single device management utility was installed in each of our WinCE product. It is free charge for you. We offer several function for let you control your device without any programming. And group device management utility was offer you manage effectively the application software install and upgrade in the sets of device, and also help you to take care of data synchronization and communication. You do not need to cost more time and money to develop such as the administrative system for the large-scale special project again.

This manual is description and focus on single device management of Power Pack utility, if you have interesting about our group device management of Power Pack utility, please consult with our sales person or district business partner for more information.

The Single Device Management of Zebex Power Pack utility, Deposits separately according to its function classification and located in your device different path.

1. Location one: C:\Programs\PowerPack



2. Location two: C:\Control Panel



Location one (C:\Programs\PowerPack) altogether deposits six tool software utilities:

1. Backlight : Screen and keyboard back light adjustment program.
2. Calculator : Calculator program.
3. EasyBeam : The file transfer program.
4. Launcher : Application auto launch program.
5. Switch : WiFi switch program.
6. TrayScan : Barcode setting program.

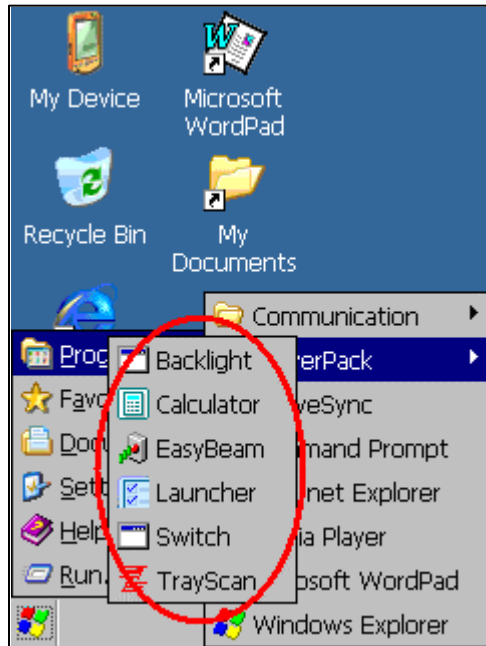

Location two (C:\Control Panel) altogether deposits three tool software utilities:

1. Backup/Restore : System backup and restore program.
2. Firmware Information : System firmware edition information program
3. Shortcut Manager : Function key set up program.

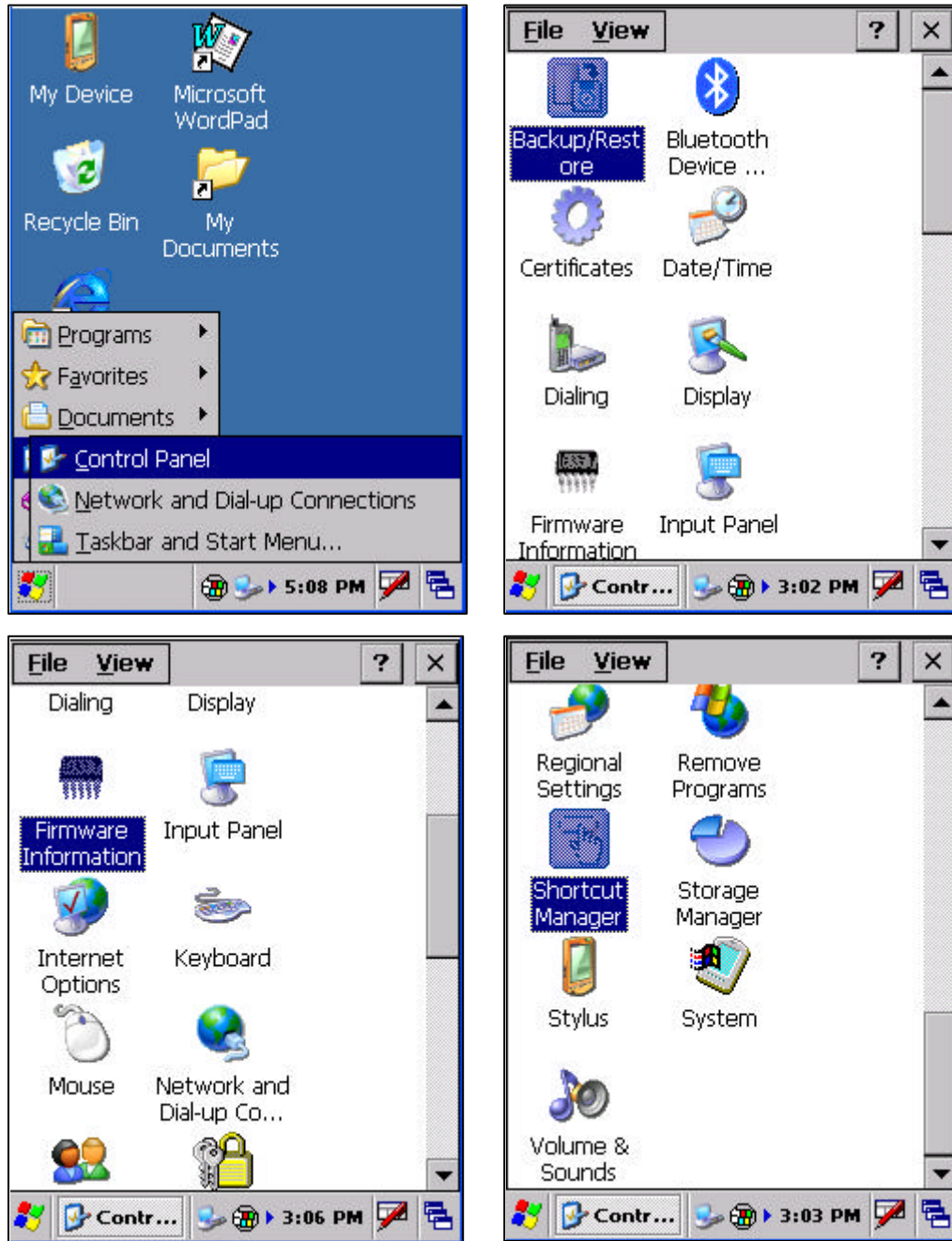

Afterwards various chapters will be detailed introduced the step of operation for each tool of Zebex Single Device Power Pack.

Using the Zebex Power Pack

Backlight

This application is set up the Backlight of LCD Panel and Key pad. It allows operators to set backlight duration, and also backlight can be set up as On & Off.

The Backlight Setting screen including 3 parts:

1. LCD
2. Keypad
3. Brightness Control Bar

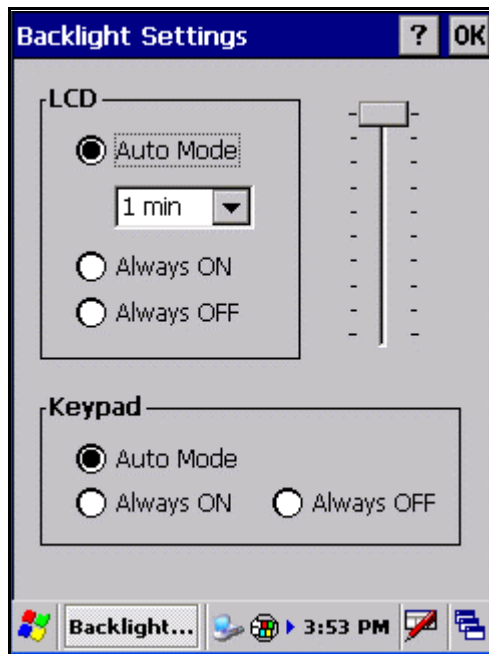

1. **LCD:** The LCD backlight setting.

Auto Mode: This model can be used to set up LCD backlight lighting automatically off when the LCD hasn't been activated for certain interval from 15 sec.(Min) to 15 min.(Max).

Always ON: This function can set up the backlight to be always on until the system into suspend or sleeping mode.

Always OFF: This function can set up the backlight to be always off.

2. **Keypad:** The Keypad Backlight setting.

Auto Mode: This function can be set up the keypad backlight to be auto off as keypad hasn't been activated for certain interval.

Always ON: This function can set up the keypad backlight to be always on until the system into suspend or sleeping mode.

Always OFF: This function can set up the backlight to be always off.

3. **Brightness Control Bar:** The brightness of the backlight can be changed via control bar. Put up to light and put down to dark.

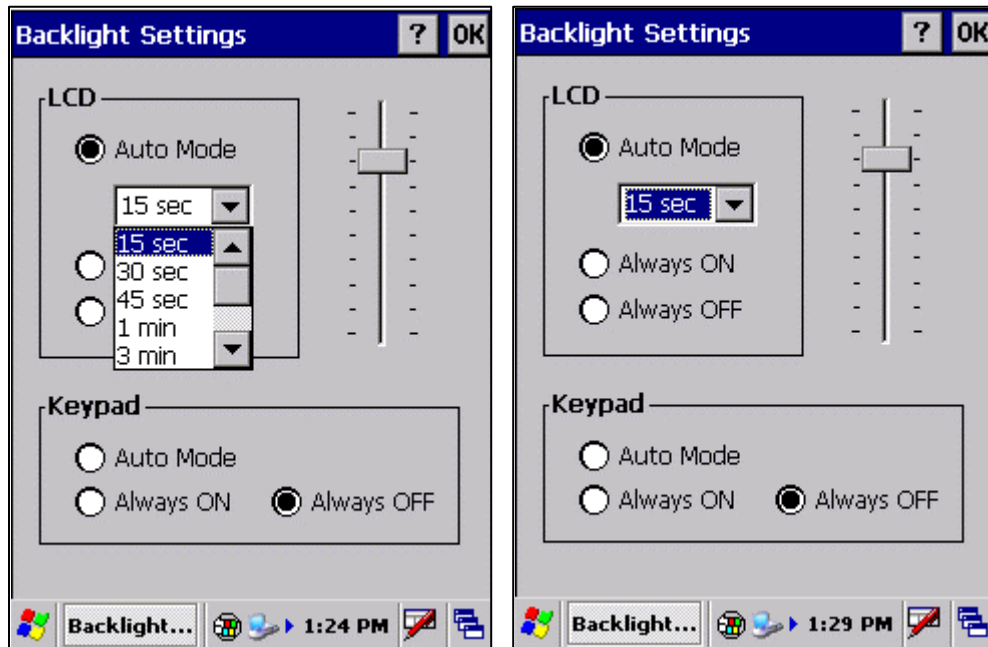

Calculator

This calculator function allows operators to add, subtract, multiply, and divide that simply provide basic logistic function in our daily basis.

The upper zone of the display area displays the memory content, and the lower zone is key pad.



Button description:

- MC : Clear buffer of memory.
- MR : Got the value of buffer.
- MS : Storage the value to buffer.
- M+ : Append the value to the buffer.
- CE : Clear the display area to "0", but keep the value in buffer.
- C : Clear the display and the buffer of memory.
- +/- : Change the value sign form Plus to Minus or Minus to Plus.
- 0~9 : Numeric key.
- / : Division function.
- * : Multiplication function.
- : Subtraction function.
- + : Addition function.
- . : A decimal point of dot.
- = : To be equal to, The amount.

EasyBeam

The EasyBeam utility is a file transfer program which transiting a data file from one device to another. It was follow the public OBEX communication protocol for file transfer. The OBEX communication protocol was also a very popular protocol for Notebook PC or cell phone device. So you can very easy to send a data file from ZEBEX's WinCE device into Notebook PC or cell phone for enhance the device application solution.

The EasyBeam file transfer program will check the device interface of IrDA automatically. The all available transiting interface will be list in the list box of "1. Select Remote Device".

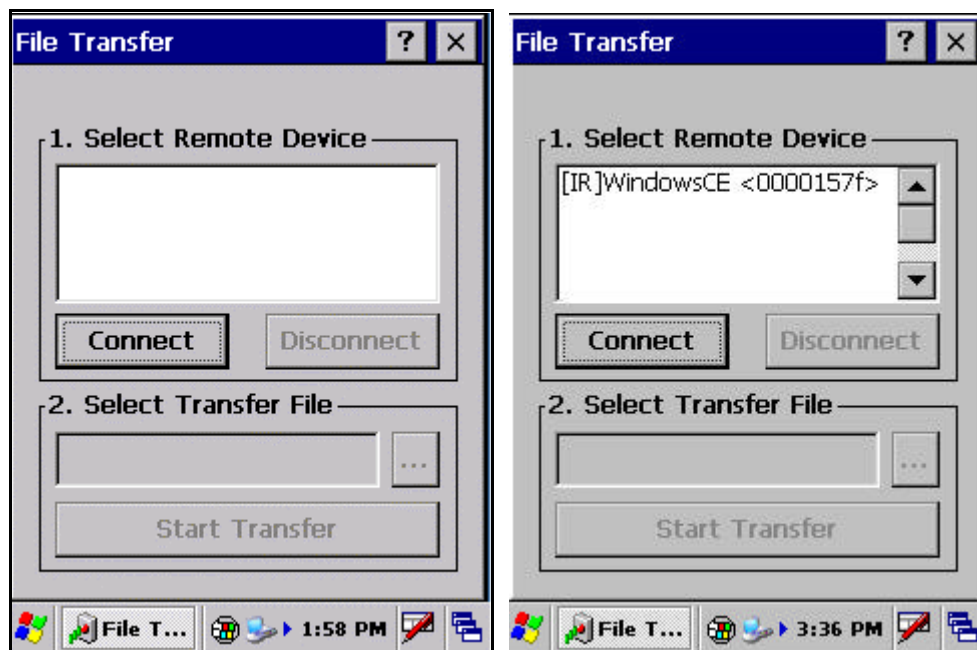

1. Select Remote Device:

All IrDA or Bluetooth transit interface will be detected and listed in the box automatically.

Connect : To connect to the selected device.

Disconnect : To disconnect the selected device.

2. Select Transfer File,

Choose the file to transfer.

Start Transfer : To start the file translation processes.

File Transfer Operation

1. Transfer the data file via IrDA:

- 1.1 Prepare a pair of devices and making it as close as possible with IrDA interface, then the device will detected other one like the following picture shown.

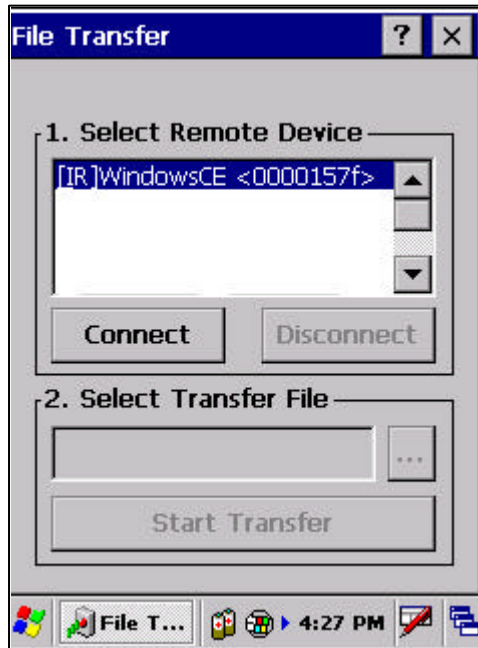

- 1.2 Select the receive device and press “**Connect**” button for start the connection or press “**Disconnect**” button for stop the connection.

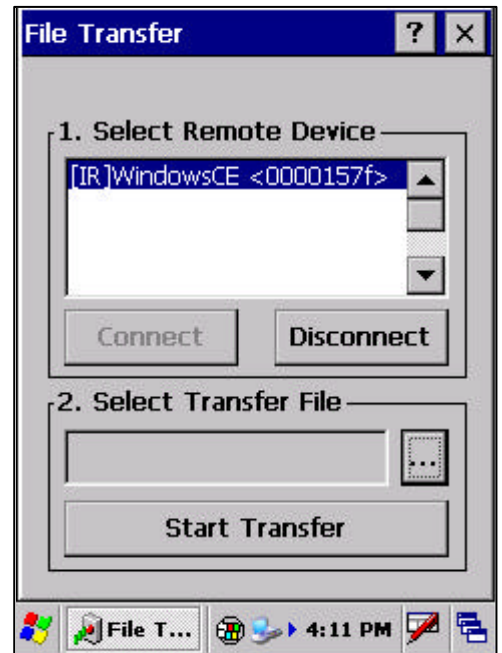
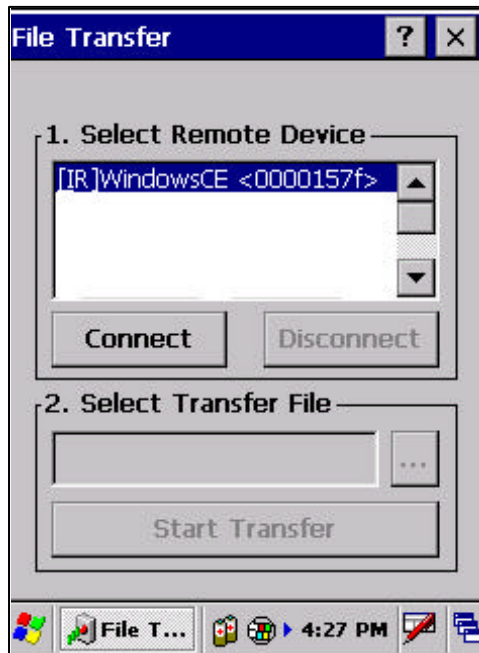

- 1.3 Click the “...” button choose the file to transfer.

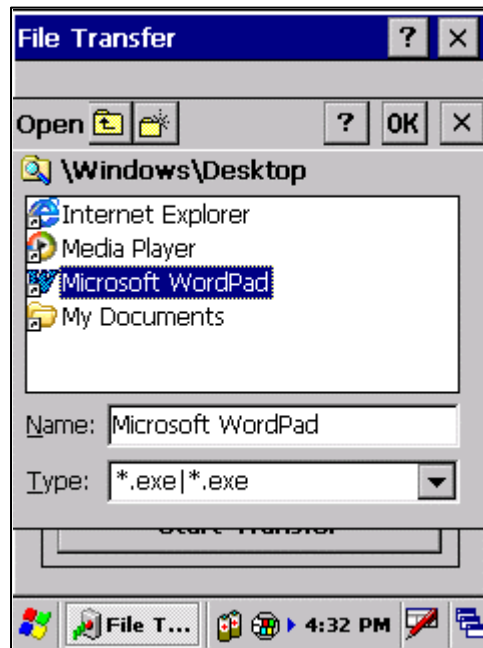

- 1.4 Click the “Start Transfer” button, start the file transfer.

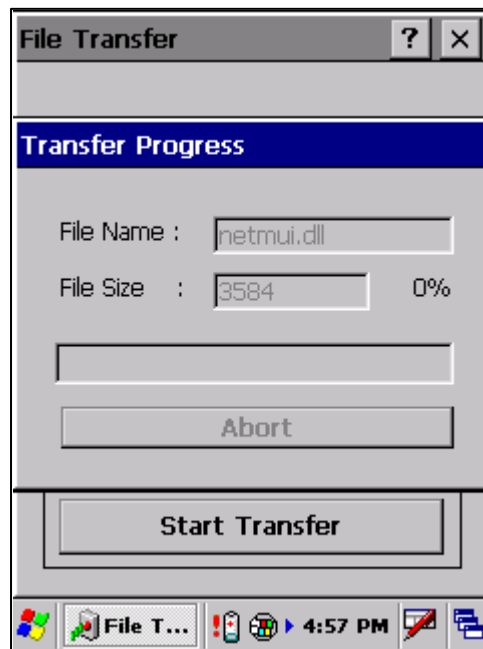

Launcher

The Launcher utility is an auto execution program for ZEBEX's WinCE device. You may set programs into the Launcher list box and running the program by automatically or manually.

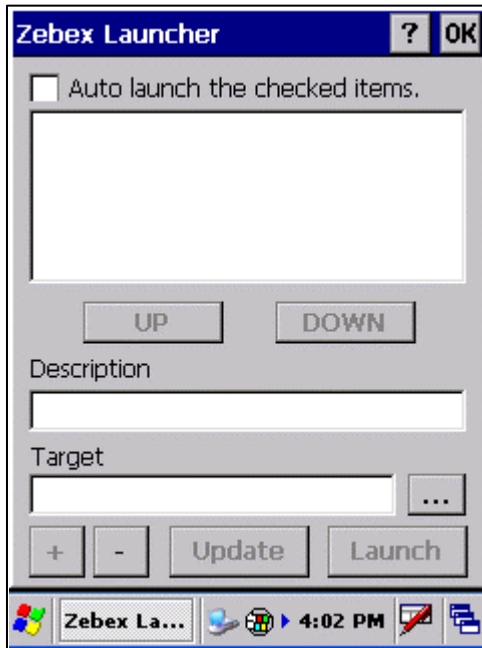

1. Selected the check box of “ **Auto launch** the checked items” will running whole programs listed in the box automatically one by one.
2. The “**Up**” and “**Down**” button is to change the priority sequence of each program. You can use it to arrange the sequence of list according to its running priority.
3. “**Description**” dialog is description the function for the program.
4. “**Target**” dialog will be showing out the path of file. Click the “...” button and selected the target program then click the “OK” button to finish and return to the Auto launch menu.
5. The “**+**” button is for adding a new program into the list by the description of the program. You can not use the same description for difference program.
6. The “**-**” button is for removing a program from the list. After select a program on list, this button will be enabled and click it to remove it.
7. The “**Update**” Button is to rename the description and file path for a program. As a program selected this button will be enable, after input the new description name or file path and click this button to update.
8. The “**Launch**” button is to execution all program on the list right away.

Launcher Operation

1. Create a new program:

1.1 Input the description for the program.

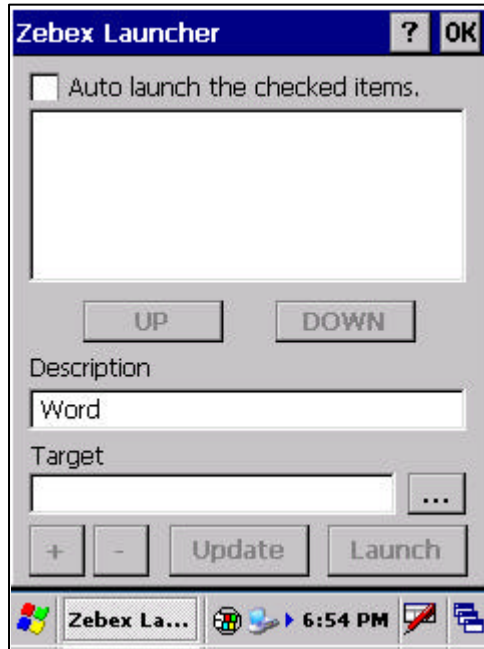

1.2 Select the target file. Click the “...” button and select the program file then click “OK” button to confirmed and return back to the Launcher menu.

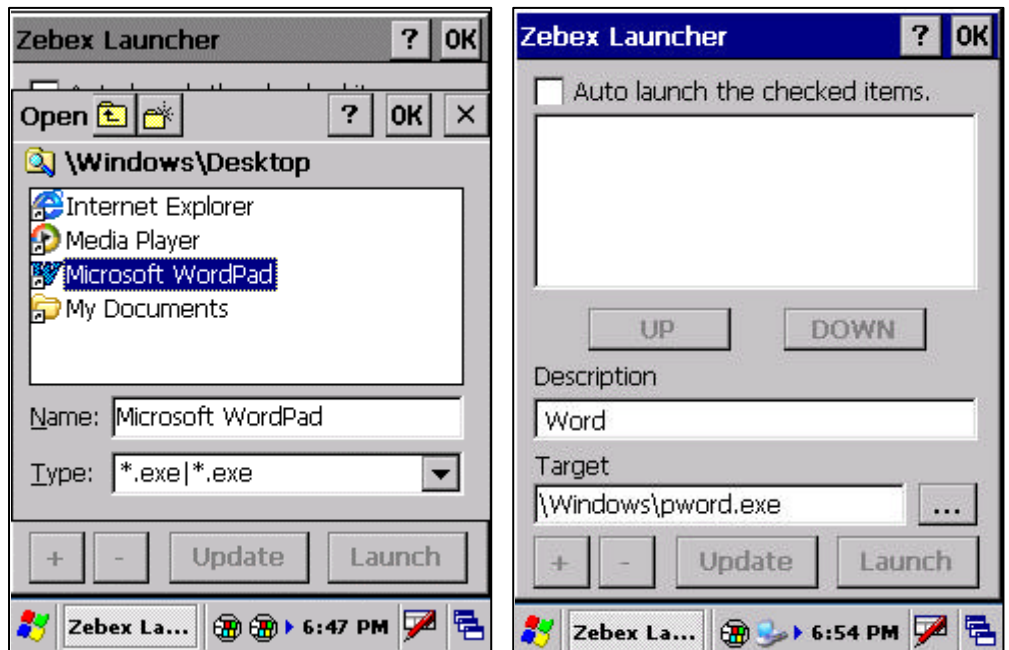

1.3 Click “+” button to add the program into list box.

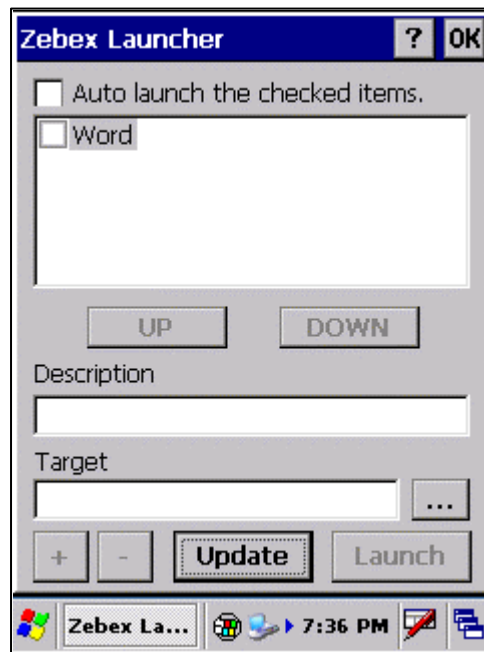

2. Launch a program:

Selected the program and click the “Launch” button to execute the program.

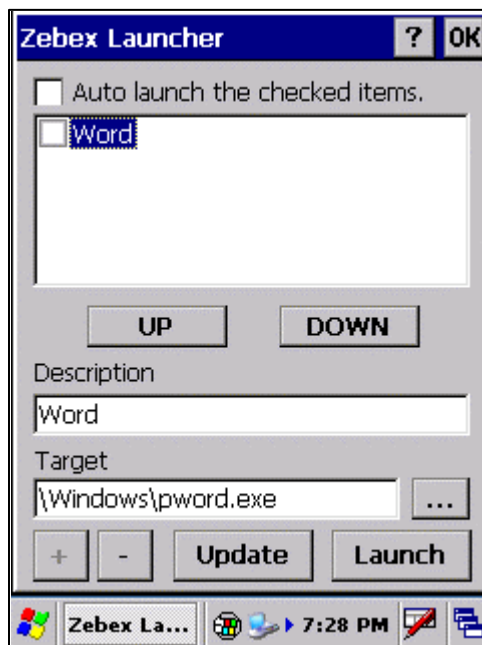

3. Update the program description:

Select the program from list box and input the new description on the “Description” field or use “...” button to re-select the target path. Then click “Update” button to confirm the change.

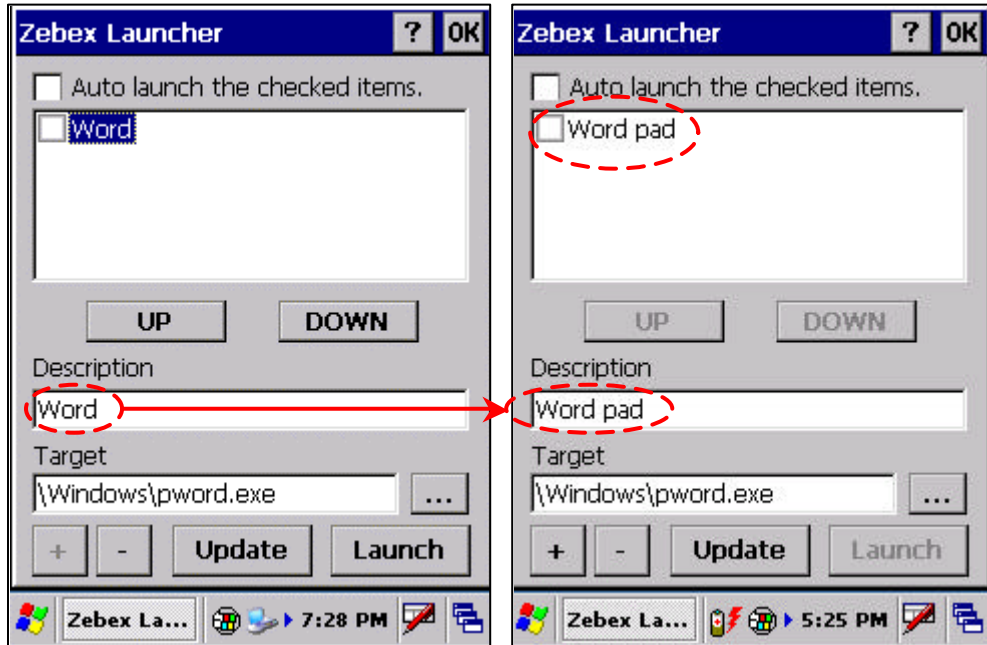

4. Remove a program:

Select a program from list box and click the “-” button to remove it.

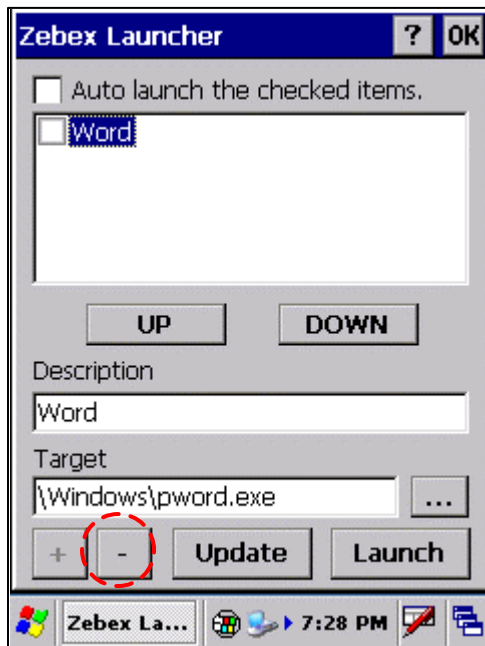

5. Change the running sequence of program:

Select the program which is desired to rearrange its running priority sequence.

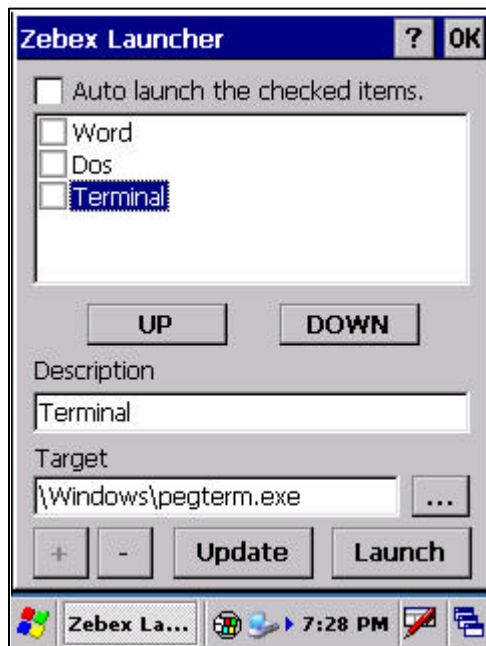

Click **“UP”** or **“Down”** button to adjust the running priority sequence.

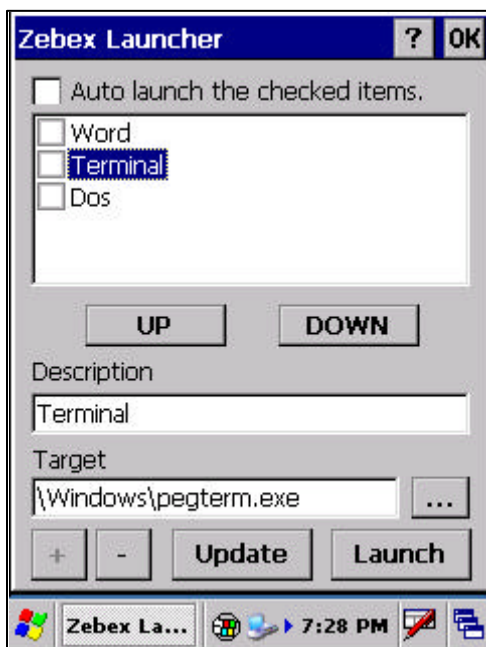

Switch

The WiFi switch utility. This application provides as a switch function to let you easy turn on or off the function and power for WiFi interface.

To check the “**OFF**” selection from WiFi check box will disable the WiFi function. On the other hand check the “**ON**” selection will enable the WiFi function.

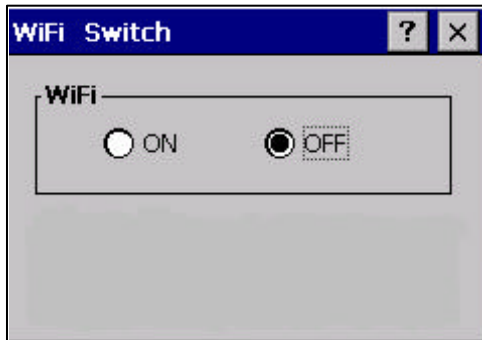

The available wireless network access point will be searching automatically when you check the “**ON**” selection for enable WiFi function. You can select an access point and press “Connect” button to connect with that network.

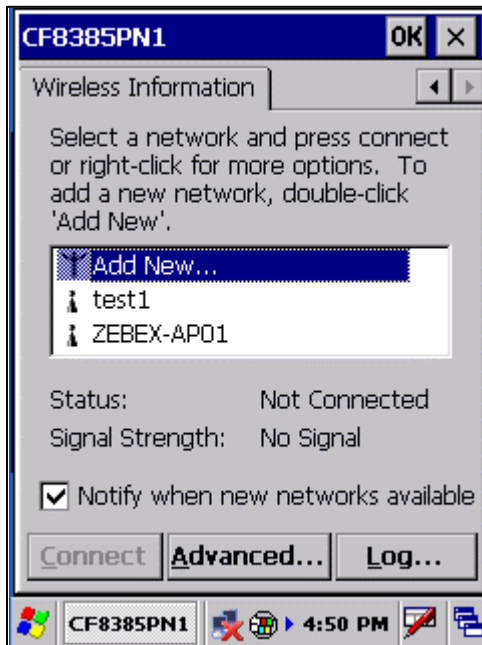

Double-click the “Add New...” on the list box will add a new wireless network, or double-click an existed access point on the list box for open the wireless properties for setting. You also can use “?” or “?” button for display more information for network setting.

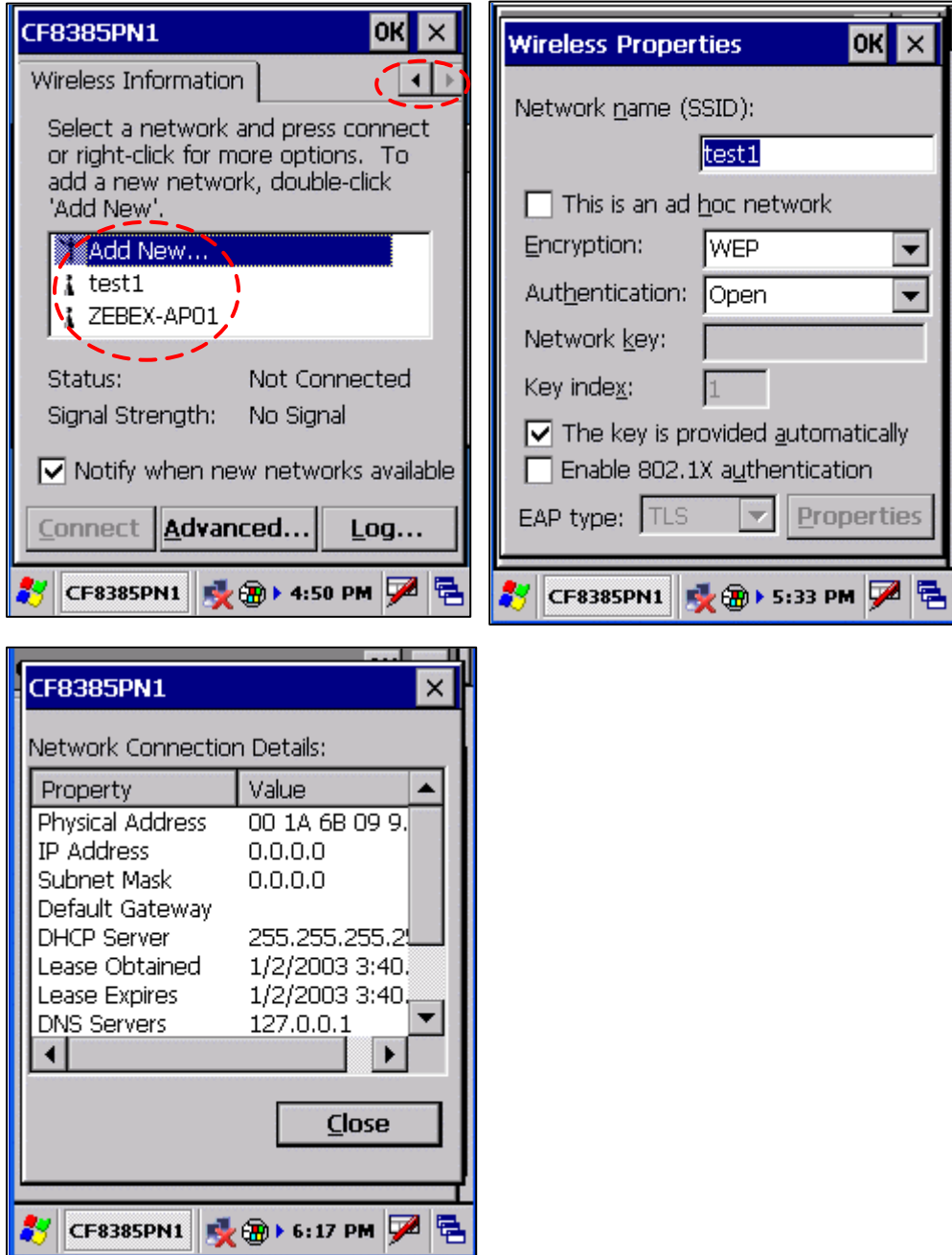

TrayScan

The TrayScan program is a barcode reader set up program, it offer you an easy way to enable or disable the barcode scanner, and also offer you to set up each barcode symbolic properties.

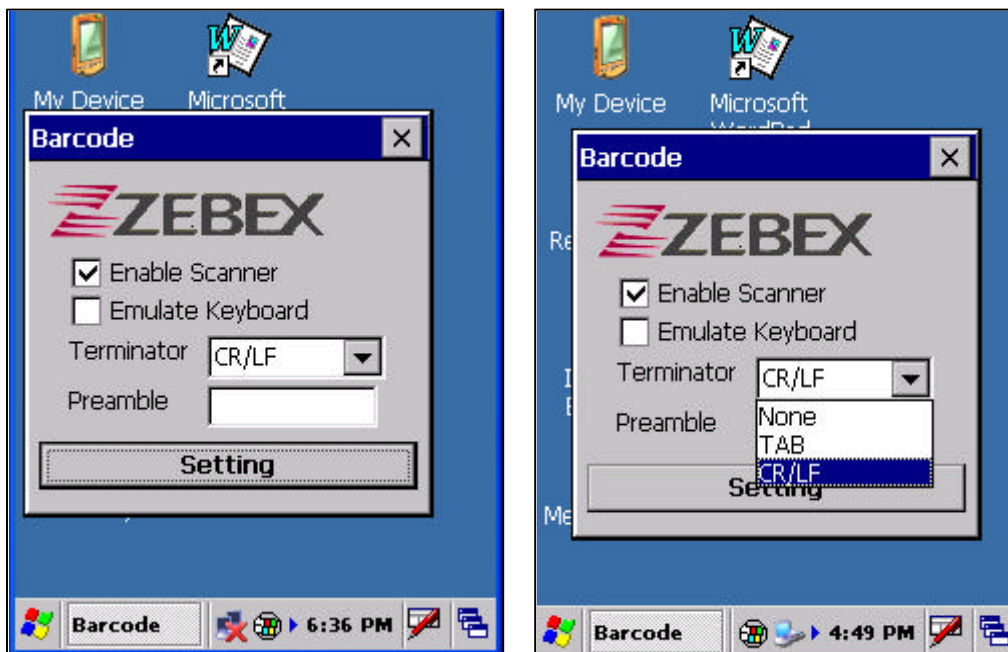

1. Enable Scanner
To check the selection will enable barcode scanner for ready to read, uncheck the selection to disable barcode scanner function.
2. Emulate keyboard
Set the barcode scanner to send the barcode data to operation system via emulate keyboard input. It will allow you to using terminal emulation or command prompt application to use barcode scanner for read the barcode data into your application,
3. Terminator
Set the terminator control code with barcode data. We offer “None”, “Tab” and “CR/LF” for selection.
4. Preamble
Set the preamble character with barcode data.
5. Setting
To set the barcode parameter value of each kind of barcode for barcode scanner.

Barcode Setting:

Press the “**Setting**” button in TrayScan application to start the barcode setting.

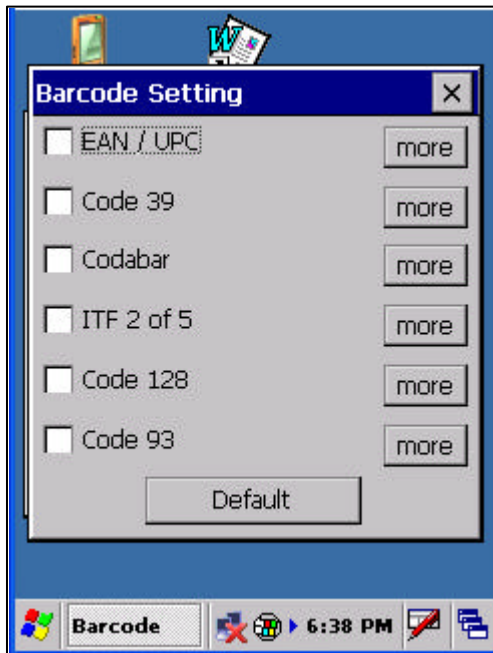

To check the barcode type selection for enable the type of barcode for read.

Press “more” button to setting the barcode parameter value of each kind of barcode.

Press “**Default**” button to use system default value to set up the barcode parameter. The default value was show in below pictures.

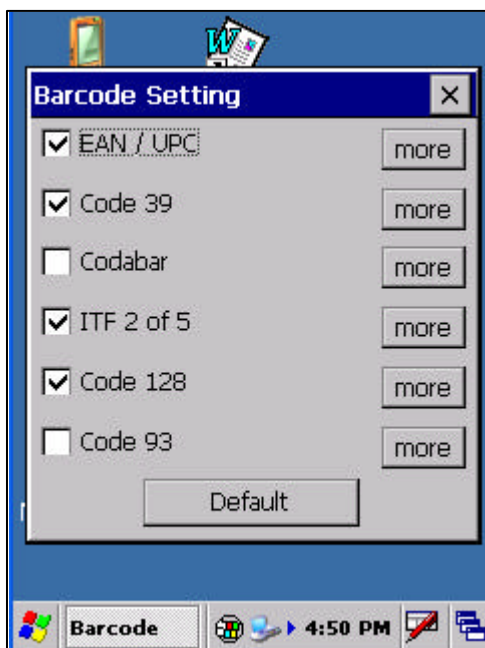

The default values of EAN/UPC code and Code39.

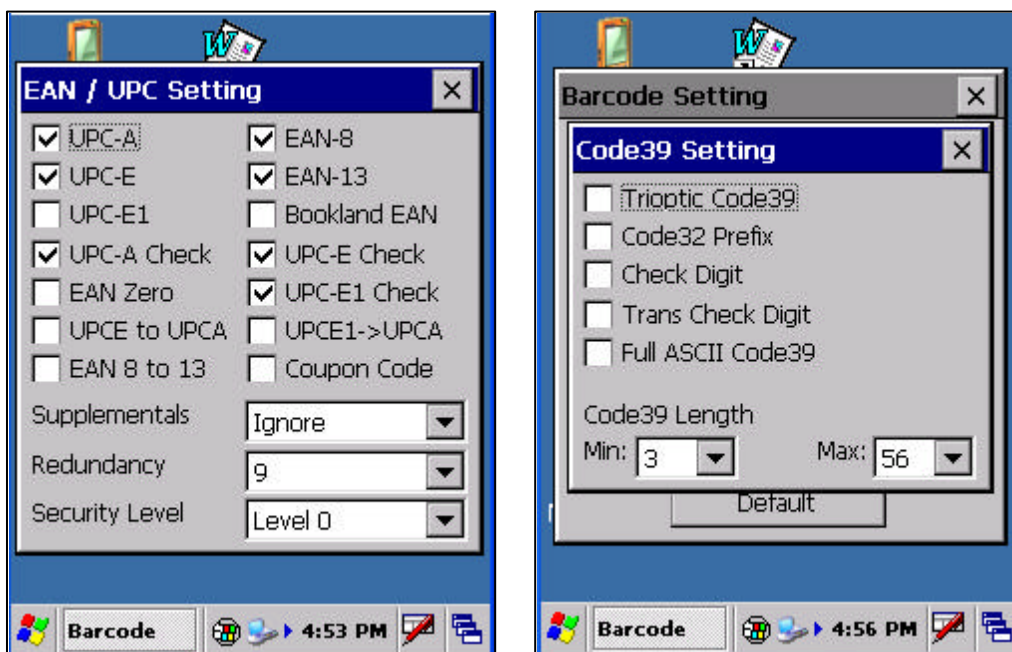

The default values of ITF 2 of 5 code and Code128.

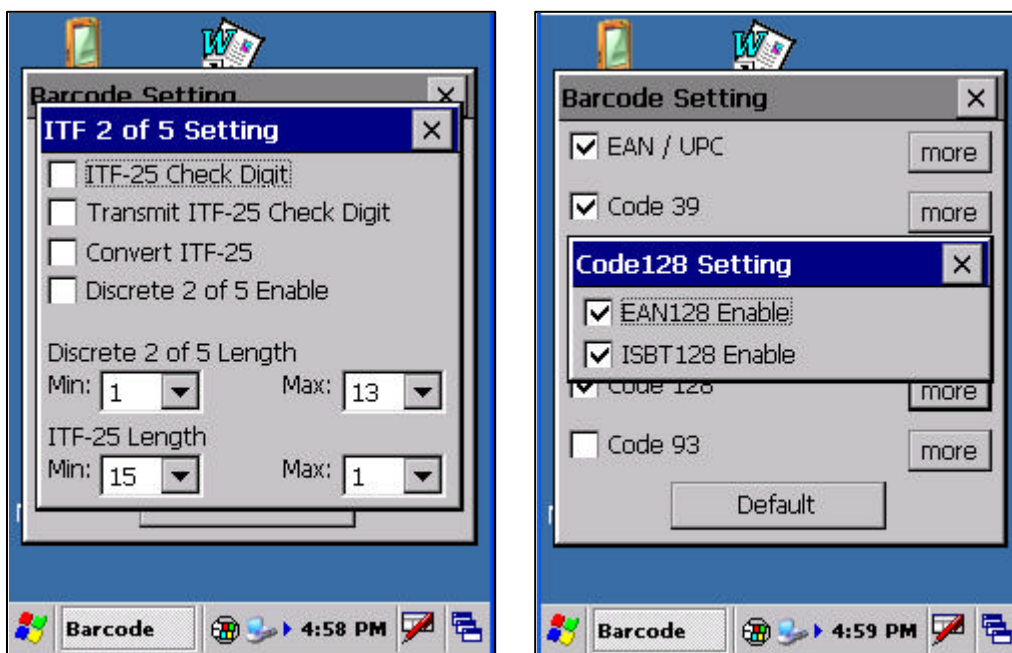

Backup/Restore

This application provides you an easy way to backup or restore the device setting information into storage card or PC via cradle connection. So, don't forget prepare a mini-SD storage card or cradle connected with PC before you running the backup function.

You can find this application is located on path "settings\control Panel".

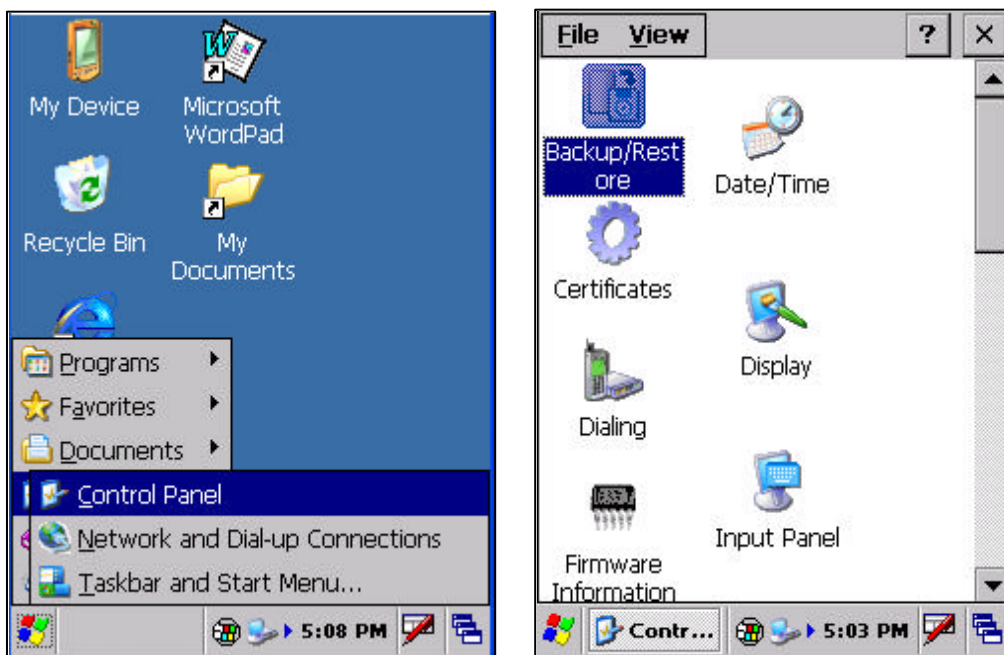

There is a pop-up warning message advice you close all application and stop running any program when you start the application.

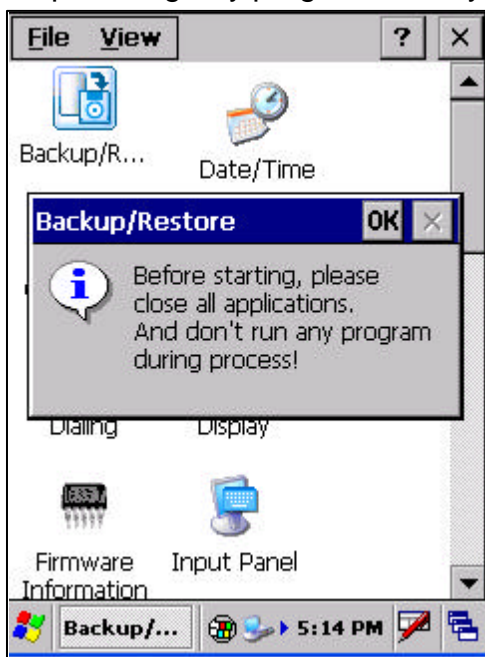

To click "OK" button go to the Backup / Restore menu.

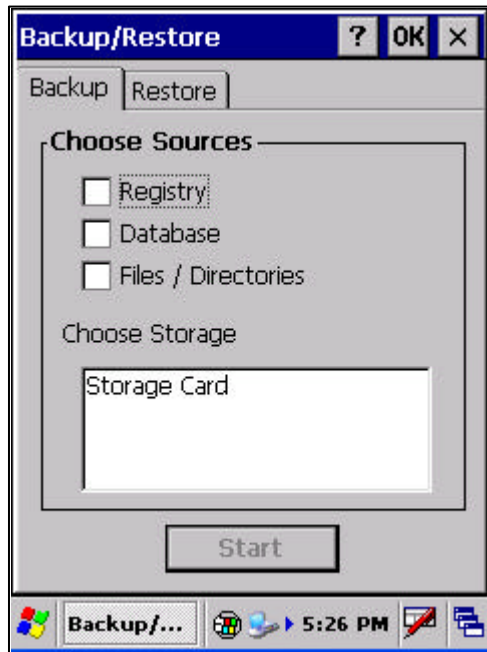

Choose sources:

To select what kind the data you want to backup.

1. Registry
2. Database
3. Files/Directories

Choose Storage:

If you already insert the mini-SD memory storage card or connected with PC via cradle, then you can choose the destination to store the data.

To click **“Start”** button start the Backup or Restore procedure.

Firmware Information

This application will check and display the version information of the device's operation system and Power Pack utility.

You can find this application is located on path "settings\control Panel".



This information is good for identify device firmware version for future update or maintenance.

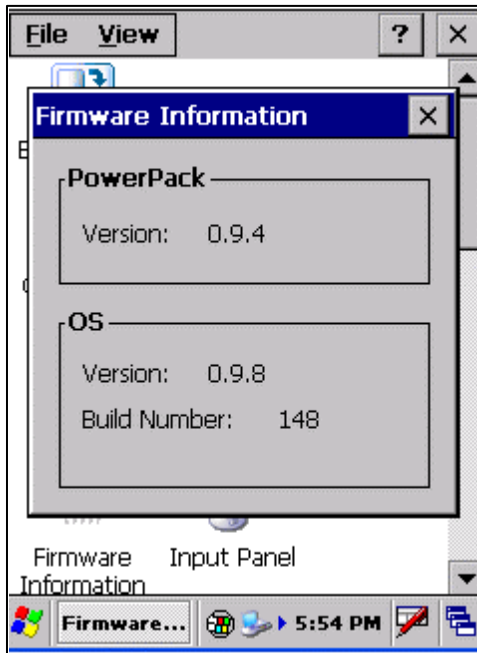

Shortcut Manager

This application utility provides you an easier way to set up function key for your device. Through using this function key set up utility you will easily and quickly to start the application program like, Window Media Player, Calculator... etc, or your own designed application program, and even the windows system function, like increasing or decreasing the volume or doing the adjustment of brightness on LCD panel.

You can find this application is located on path "settings\control Panel".

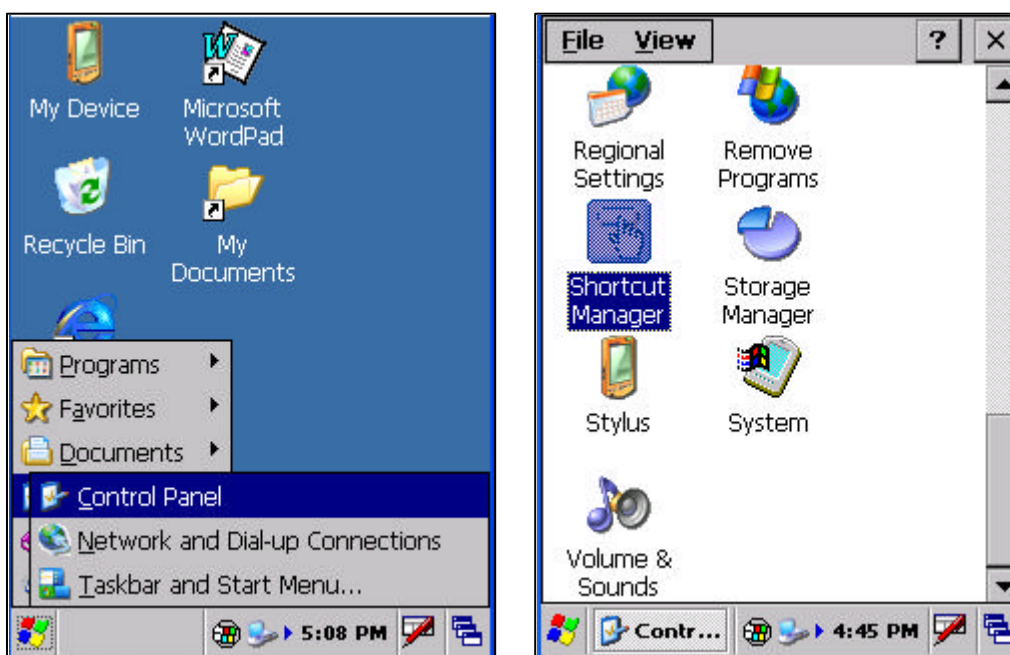

This application has two pages display, "**Configuration**" and "**Assign Function**". There are two buttons on the first page of "**Configuration**", button "**Reset**" and button ">>".

Button "**Reset**" will restore the function key setting as factory default. The factory default set is:

- F1 & F5: Software Input Method On/Off
It is let you easy to wakeup or close the software keyboard on the screen. You can use F1 or F5 function key to open or close the software keyboard.
- F2 & F6: Panel Brighter
Turn the screen backlight to bright.
- F3 & F7: Panel Darker
Turn the screen backlight to dark.
- F4 & F8: Calculator
Start the Calculator program.

There are four function keys information display in one page. Button “>>” for change to next page to display the other four function key’s setting.

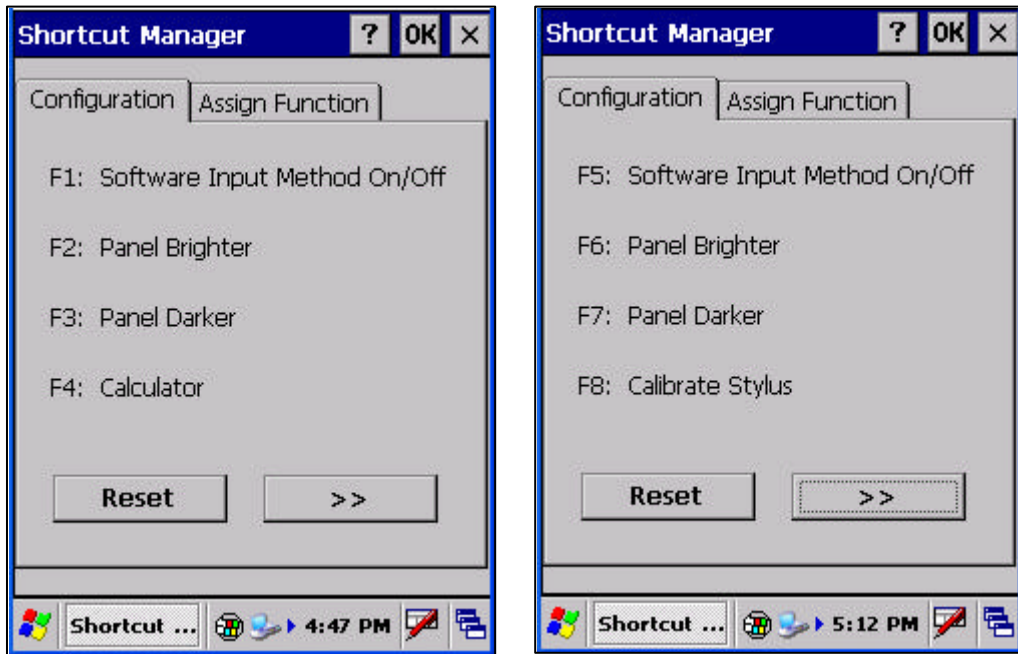

In the page of “Assign Function” offer you to reset the function keys. This program use pushbutton operation to assign the function key you want to setting. The program will catch the function key scan code and display the set up page for setting. If you want to set F5 function key, you need to press “SF/Fn” button first then press F1 to assign it. It’s mean F5~F8 function key is compose of “SF/Fn” with F1~F4.

- SF/Fn + F1 = F5
- SF/Fn + F2 = F6
- SF/Fn + F3 = F7
- SF/Fn + F4 = F8

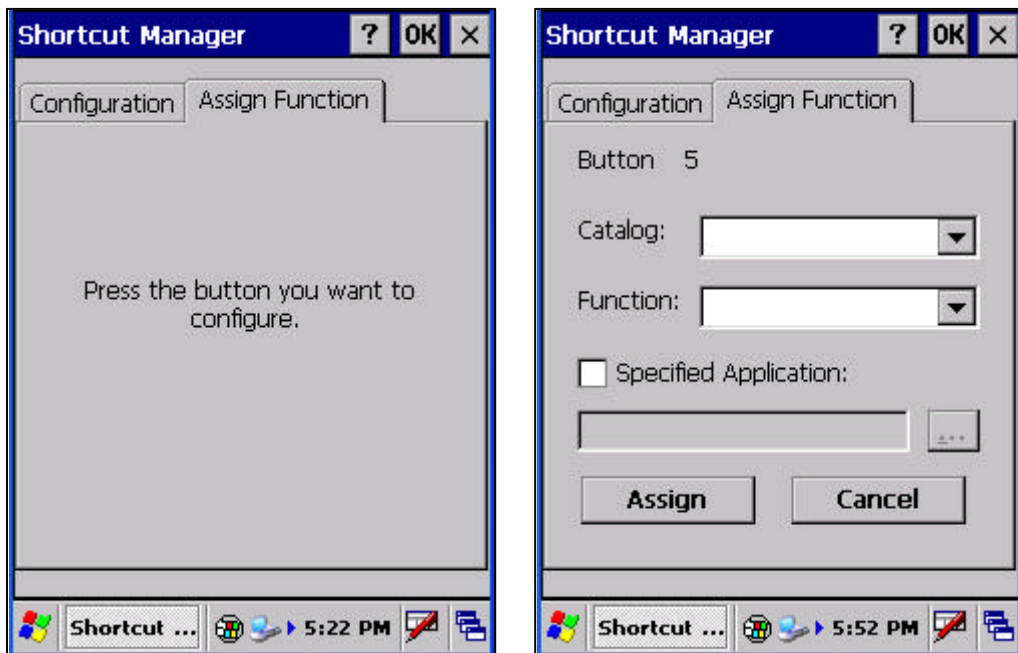

The message on the page of “Assign Function” was explain in below.

1. **Button X:** Indicates which function key of pushbutton being assigned. For example, “Button 5” means F5 function key being assigned.
2. **Catalog:** Including 4 standard catalogs for selection.
 - (1) Applications
 - (2) Z-2060 Shortcuts (for Z-2060 device)
 - (3) Windows Shortcuts
 - (4) IE Shortcuts

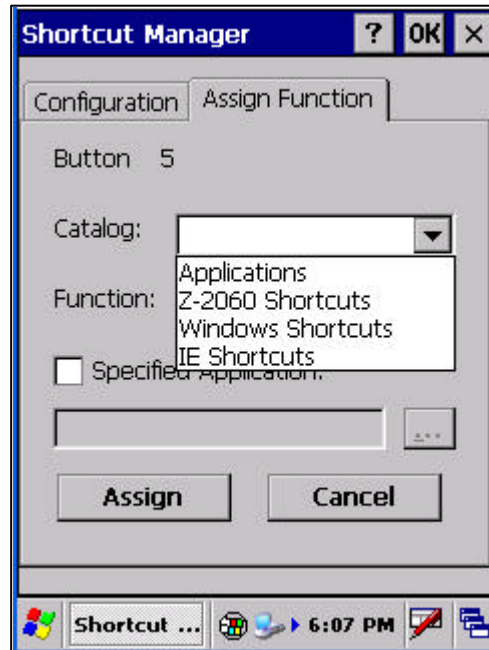

3. **Function:** Defines the standard function by deferent the “Catalog” being selected.

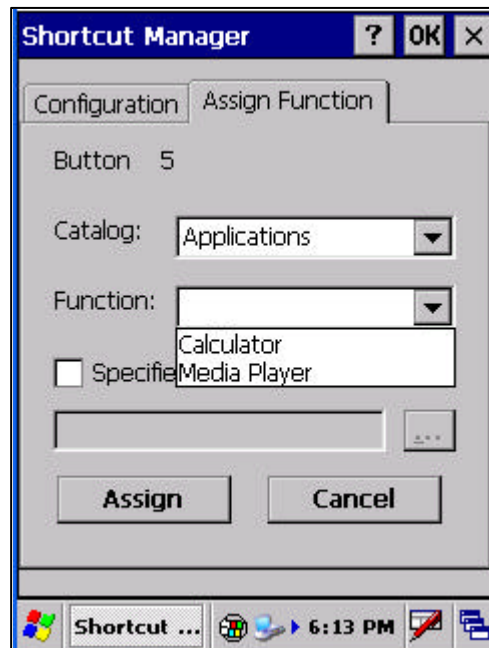

4. **Specified Application:** Setting others application program on the device for the assigned function key.

After select this function, then press “...” button to assign an application for this function key.

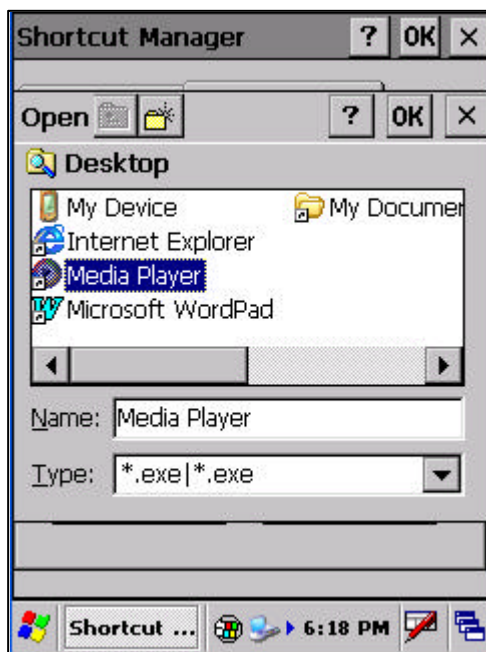
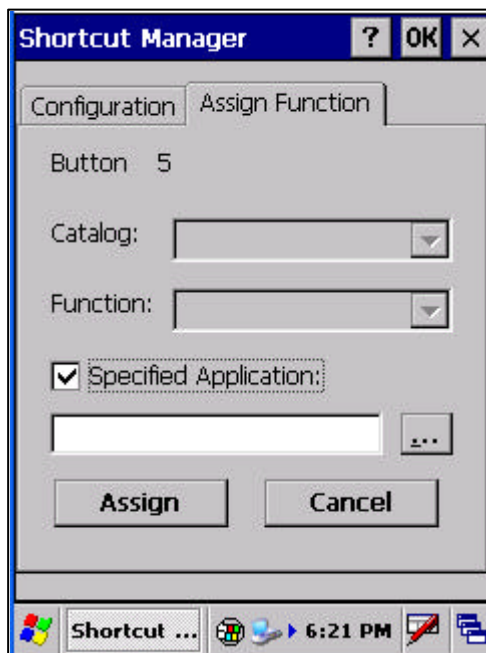

5. **Assign:**

Assigning the function key setting.

Press **“Assign”** button after you selected an application of the shortcut for a function key. The screen will change to the page of **“Configuration”** and update the function key setting information.

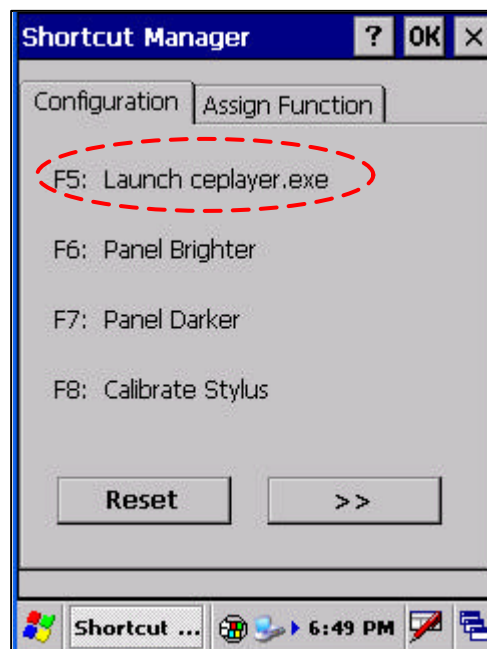
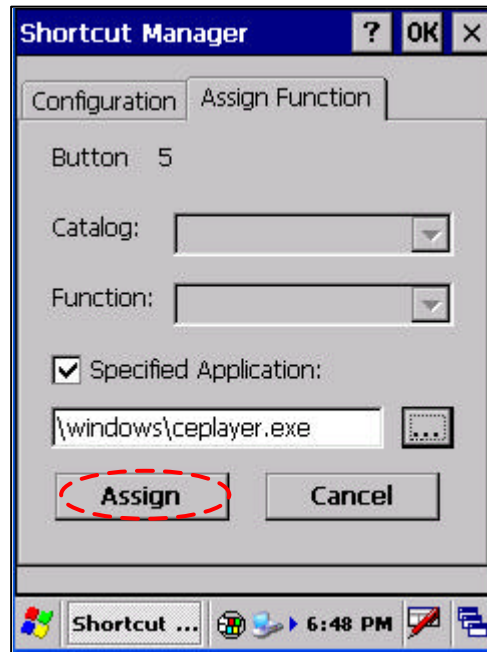

6. **Cancel:**

Cancel the function key setting.

Press “**Cancel**” button to cancel the current function key setting and back to the original display of page “**Assign Function**”.

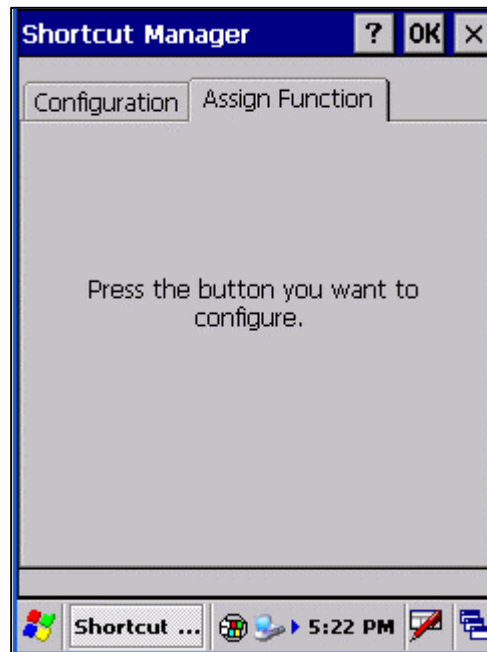
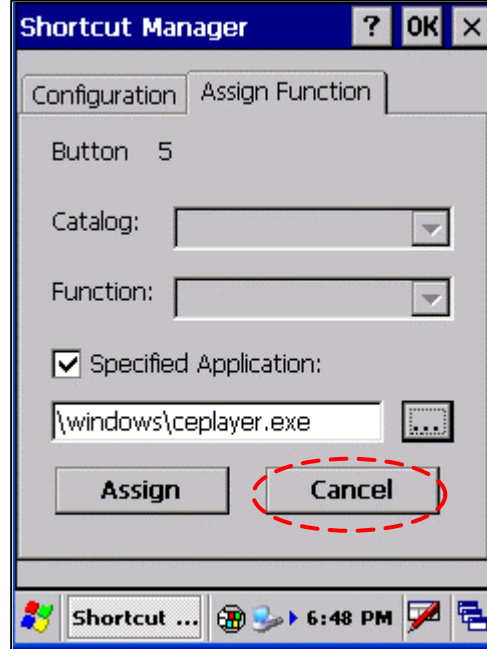

<< MEMO >>