



Flom Test Labs
EMI, EMC, RF Testing Experts Since 1963

toll-free: (866) 311-3268
fax: (480) 926-3598
<http://www.flomlabs.com>
info@flomlabs.com

Transmitter Certification

of

Model: Outdoor Intercom
FCC ID: JLFODI1

to

Federal Communications Commission

Rule Part(s) 15.249

Date Of Report: March 24, 2006
Revised: May 30, 2006

On the Behalf of the Applicant:

International Electronics Inc.

At the Request of:

P.O. 13653

International Electronics Inc.
5913-C NE 127th Ave, Suite 800
Vancouver, WA 98682

Attention of:

Shary Nassimi, President
(360) 241-9090
email: iei@nmlink.com

Supervised By:

David E. Lee, FCC/IC Compliance Manager

The Applicant has been cautioned as to the following:

15.21 Information to User.

The users manual or instruction manual for an intentional radiator shall caution the user that changes or modifications not expressly approved by the party responsible for compliance could void the user's authority to operate the equipment.

15.27(a) Special Accessories.

Equipment marketed to a consumer must be capable of complying with the necessary regulations in the configuration in which the equipment is marketed. Where special accessories, such as shielded cables and/or special connectors are required to enable an unintentional or intentional radiator to comply with the emission limits in this part, the equipment must be marketed with, i.e. shipped and sold with, those special accessories. However, in lieu of shipping or packaging the special accessories with the unintentional or intentional radiator, the responsible party may employ other methods of ensuring that the special accessories are provided to the consumer, without additional charge.

Information detailing any alternative method used to supply the special accessories for a grant of equipment authorization or retained in the verification records, as appropriate. The party responsible for the equipment, as detailed in § 2.909 of this chapter, shall ensure that these special accessories are provided with the equipment. The instruction manual for such devices shall include appropriate instructions on the first page of text concerned with the installation of the device that these special accessories must be used with the device. It is the responsibility of the user to use the needed special accessories supplied with the equipment.

Table Of Contents

Rule	Description	Page
	Standard Test Conditions and Engineering Practices	5
2.1053(a)	Field Strength of Spurious Radiation	6
2.1049(c)(1)	Emission Masks (Occupied Bandwidth)	11
2.202(g)	Necessary Bandwidth and Emission Bandwidth	16

Required information per ISO/IEC Guide 25-1990, paragraph 13.2:

- a) **Test Report**
- b) Laboratory: M. Flom Associates, Inc.
(FCC: 31040/SIT) 3356 N. San Marcos Place, Suite 107
(Canada: IC 2044) Chandler, AZ 85225
- c) Report Number: d0630049
- d) Client: International Electronics Inc.
5913-C NE 127th Ave, Suite 800
Vancouver, WA 98682
- e) Identification: Outdoor Intercom
FCC ID: JLFODI1
Description: Wireless Intercom
- f) EUT Condition: Not required unless specified in individual tests.
- g) Report Date: March 24, 2006
EUT Received: February 17, 2006
- h, j, k): As indicated in individual tests.
- i) Sampling method: No sampling procedure used.
- l) Uncertainty: In accordance with MFA internal quality manual.
- m) Supervised by: 
David E. Lee, FCC/IC Compliance Manager
- n) Results: The results presented in this report relate only to the item tested.
- o) Reproduction: This report must not be reproduced, except in full, without written permission from this laboratory.

List Of General Information Required For Certification

In Accordance with FCC Rules and Regulations,
Volume II, Part 2 and to 15.249

Sub-Part 2.1033

(c)(1): **Name and Address of Applicant:**

International Electronics Inc.
5913-C NE 127th Ave, Suite 800
Vancouver, WA 98682

Manufacturer:

Applicant

(c)(2): **FCC ID:** JLFODI1

Model Number: Outdoor Intercom

(c)(3): **Instruction Manual(s):**

Please See Attached Exhibits

(c)(4): **Type of Emission:** FM

(c)(5): **FREQUENCY RANGE, MHz:** 902 - 928

(c)(6): **Power Rating, mV/m @ 3m:** 49.48
 Switchable Variable N/A

(c)(7): **Maximum Power Rating, W:** 50 mv/m @ 3m

15.203: **Antenna Requirement:**

- The antenna is permanently attached to the EUT
- The antenna uses a unique coupling
- The EUT must be professionally installed
- The antenna requirement does not apply

Subpart 2.1033 (continued)

(c)(8): Voltages & Currents in All Elements in Final RF Stage, Including Final Transistor or Solid State Device:

Collector Current, A	=	See manual
Collector Voltage, Vdc	=	See manual
Supply Voltage, Vdc	=	6.0

(c)(9): **Tune-Up Procedure:**

Please See Attached Exhibits

(c)(10): **Circuit Diagram/Circuit Description:**

Including description of circuitry & devices provided for determining and stabilizing frequency, for suppression of spurious radiation, for limiting modulation and limiting power.

Please See Attached Exhibits

(c)(11): **Label Information:**

Please See Attached Exhibits

(c)(12): **Photographs:**

Please See Attached Exhibits

(c)(13): **Digital Modulation Description:**

Attached Exhibits
 N/A

(c)(14): **Test and Measurement Data:**

Follows

Sub-part
2.1033(b):

Test and Measurement Data

All tests and measurement data shown were performed in accordance with FCC Rules and Regulations, Volume II; Part 2, Sub-part J, Sections 2.1031, 2.1033, 2.1035, 2.1041, 2.1043, 2.1045, and the following individual Parts:

_____	15.209	Radiated emission limits; general requirements
_____	15.211	Tunnel radio systems
_____	15.213	Cable locating equipment
_____	15.214	Cordless telephones
_____	15.217	Operation in the band 160-190 kHz
_____	15.219	Operation in the band 510-1705 kHz
_____	15.221	Operation in the band 525-1705 kHz (leaky coax)
_____	15.223	Operation in the band 1.705-10 MHz
_____	15.225	Operation in the band 13.553-13.567 MHz
_____	15.227	Operation in the band 26-27.28 MHz (remote control)
_____	15.229	Operation in the band 40.66-40.70 MHz
_____	15.231	Periodic operation in the band 40.66-40.70 MHz and above 70 MHz
_____	15.233	Operation within the bands 43.71-44.49, 46.60-46.98 MHz 48.75-49.51 MHz and 49.66-50.0 MHz
_____	15.235	Operation within the band 49.82-49.90 MHz
_____	15.237	Operation within the bands 72.0-73.0 MHz, 74.6-74.8 MHz and 75.2-76.0 MHz (auditory assistance)
_____	15.239	Operation in band 88-108 MHz
_____	15.241	Operation in the band 174-216 MHz (biomedical)
_____	15.243	Operation in the band 890-940 MHz (materials)
_____	15.245	Operation within the bands 902-928 MHz, 2435-2465 MHz, 5785-5815 MHz, 10500-10550 MHz, and 24075-24175 MHz (filed disturbance sensors)
_____	15.247	Operation within bands 902-928 MHz, 2400-2483.5 MHz, and 5725-5850 MHz (spread spectrum)
X _____	15.249	Operation within the bands 902-928 MHz, 2400-2483.5 MHz, 5725-5875 MHz, and 24.0- 24.25 GHz
_____	15.251	Operation within the bands 2.9-3.26 GHz, 3.267-3.332 GHz, 3.339-3.3458 GHz, and 3.358- 3.6 GHz (vehicle identification systems)
_____	15.321	Specific requirements for asynchronous devices operating in the 1910-1920 MHz and 2390- 2400 MHz bands (Unlicensed PCS)
_____	15.323	Specific requirements for isochronous devices operating in the 1920-1930 MHz sub-band (Unlicensed PCS)

Standard Test Conditions And Engineering Practices

Except as noted herein, the following conditions and procedures were observed during the testing:

In accordance with ANSIC63.4-1992/2003, and unless otherwise indicated in the specific measurement results, the ambient temperature of the actual EUT was maintained within the range of 10° to 40°C (50° to 104 °F) unless the particular equipment requirements specify testing over a different temperature range. Also, unless otherwise indicated, the humidity levels were in the range of 10% to 90% relative humidity.

Prior to testing, the EUT was tuned up in accordance with the manufacturer's alignment procedures. All external gain controls were maintained at the position of maximum and/or optimum gain throughout the testing.

Measurement results, unless otherwise noted, are worst-case measurements.

	<h3 style="margin: 0;">A2LA</h3> <hr/> <p>“A2LA has accredited M. Flom Associates, Inc. Chandler, AZ for technical competence in the field of Electrical Testing. The accreditation covers the specific tests and types of tests listed on the agreed scope of accreditation. This laboratory meets the requirements of ISO/IEC 17025 – 1999 ‘General Requirements for the Competence of Testing and Calibration Laboratories’ and any additional program requirements in the identified field of testing.”</p> <hr/> <p>Certificate Number: 2152-01</p>
--	---

Name of Test: Field Strength of Radiated Emissions

Specification: 47 CFR 2.1053(a)

Guide: ANSI C63.4-2003

Measurement Procedure

After performing any exploratory testing or pre-scan the EUT was moved to the OATS.

The testing was performed with the EUT rotated 360°, the antenna scanned between 1 m and 4 m, and the antenna rotated to repeat the measurements for both horizontal and vertical antenna polarizations. During the full frequency spectrum investigation, particular focus was made on those frequencies found in exploratory testing that were used to find the final test configuration, mode of operation, and arrangement (associated with achieving the least margin with respect to the limit). This full spectrum test constitutes the compliance measurement.

Radiated Test Setup

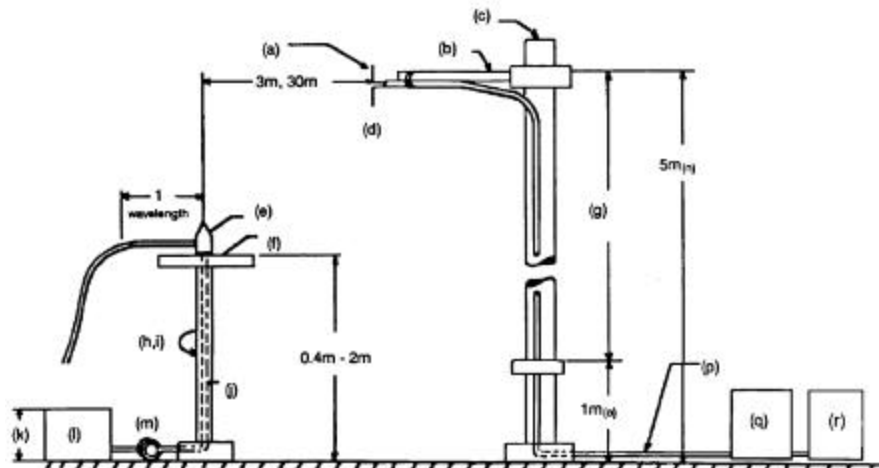

Notes:

- | | |
|--|---|
| (a) Search Antenna - Rotatable on boom | (j) Cables routed through hollow turntable center |
| (b) Non-metallic boom | (k) 30 cm or less |
| (c) Non-metallic mast | (l) External power source |
| (d) Adjustable horizontally | (m) 10 cm diameter coil of excess cable |
| (e) Equipment Under Test | (n) 25 cm (V), 1 m-7 m (V, H) |
| (f) Turntable | (o) 25 cm from bottom end of 'V', 1m normally |
| (g) Boom adjustable in height. | (p) Calibrated Cable at least 10m in length |
| (h) External control cables routed horizontally at least one wavelength. | (q) Amplifier (optional) |
| (i) Rotatable | (r) Spectrum Analyzer |

Test Equipment

Asset (as applicable)	Description	s/n	Cycle	Last Cal <small>Per ANSI C63.4-1992/2000 Draft, 10.1.4</small>
Transducer				
x	I00088	EMCO 3109-B 25MHz-300MHz	2336	24 mo. Sep-05
x	I00089	Aprcl 2001 200MHz-1GHz	001500	24 mo. Sep-05
X	i00103	EMCO 3115 1GHz-18GHz	9208-3925	24 mo. Sep-05
Amplifier				
	i00028	HP 8449A	2749A00121	12 mo. May-05
Spectrum Analyzer				
	i00029	HP 8563E	3213A00104	12 mo. Jan-06
x	i00033	HP 85462A	3625A00357	12 mo. Sep-05
Miscellaneous				
	Microphone	<u>No</u>		
	Antenna	<u>Yes</u>	(Internal)	
	All Ports Terminated	<u>Yes</u>		

Test Setup:

Radiated Emissions



Name of Test: Field Strength of Radiated Emissions (Harmonic)
 g0630105: 2006-Mar-22 Wed 15:27:00
 State: 2:High Power

Frequency Tuned, MHz	Frequency Emission, MHz	Meter, dBuV	CF, dB	uV/m @ 3m	ERP, dBm	Margin, dB
903.000000	903.000000	50.22	43.58	48978	-13.20	-0.20
903.000000	1806.415000	-2.30	51.37	284	-57.93	-4.93
903.000000	2709.632000	-6.70	55.46	274	-58.24	-5.24
903.000000	3612.849000	-10.00	56.55	213	-60.45	-7.45
903.000000	4516.066000	-15.30	58.51	145	-63.79	-10.79
903.000000	5419.283000	-24.70	59.33	54	-72.37	-19.37

g0630108: 2006-Mar-23 Thu 10:20:00
 State: 2:High Power

Frequency Tuned, MHz	Frequency Emission, MHz	Meter, dBuV	CF, dB	uV/m @ 3m	ERP, dBm	Margin, dB
915.660000	915.660000	49.67	43.81	47206	-13.52	-0.52
915.660000	1831.320000	-3.10	51.70	269	-58.40	-5.40
915.660000	2746.980000	-7.20	55.57	262	-58.63	-5.63
915.660000	3662.640000	-10.90	56.75	196	-61.15	-8.15
915.660000	4578.300000	-16.20	58.59	132	-64.61	-11.61
915.660000	5493.960000	-24.70	59.37	54	-72.33	-19.33

g0630109: 2006-Mar-23 Thu 10:30:00
 State: 2:High Power

Frequency Tuned, MHz	Frequency Emission, MHz	Meter, dBuV	CF, dB	uV/m @ 3m	ERP, dBm	Margin, dB
926.000000	926.000000	49.88	44.01	49488	-13.11	-0.11
926.000000	1853.415000	-4.60	51.98	234	-59.62	-6.62
926.000000	2780.135000	-7.10	55.67	268	-58.43	-5.43
926.000000	3706.855000	-11.10	56.92	195	-61.18	-8.18
926.000000	4633.575000	-13.90	58.68	173	-62.22	-9.22
926.000000	5560.295000	-24.70	59.40	54	-72.30	-19.30

All other readings more than 20dB below limit.



Performed By:

David E. Lee, FCC/IC Compliance Manager

Name of Test: Radiated Emissions (Non-Harmonic)
Specification: 47 CFR 15.249(c)
Test Equipment: As for Radiated Spurious Emissions (Harmonic)

15.249(c):

Emissions radiated outside of the specified frequency bands, except for harmonics, shall be attenuated by at least 50 dB below the level of the fundamental or to the general radiated emissions limits in § 15.209, whichever is the lesser attenuation.

General Radiated Emission Limits Per 15.209:

Frequency, MHz	Field Strength, $\mu\text{V}/\text{m}$ @ 3m
30 – 88	100
88 – 216	150
216 – 960	200
Above 960	300

Frequency of Carrier, MHz	= 903.00, 915.66, 926.00
Spectrum Searched	= 0 to $10 \times F_C$
All Other Emissions	= = 20 dB Below Limit
Limit, $\mu\text{V}/\text{m}$ @ 3m	= 50 dBc or § 15.209

All Spurious Emissions Were 20 dB or More Below Limit

System Sensitivity is -130 dBm

All Non-Harmonic Spurious Emissions Were, -130 dBm



Performed By:

David E. Lee, FCC/IC Compliance Manager

Name of Test: Emission Masks (Occupied Bandwidth)

Specification: 47 CFR 2.1049(c)(1)

Measurement Procedure

1. The EUT and test equipment were set up as shown on the following page, with the Spectrum Analyzer connected.
2. For EUTs supporting digital modulation, the digital modulation mode was operated to its maximum extent.
3. The Occupied Bandwidth was measured with the Spectrum Analyzer controls set as shown on the test results.

Test Equipment

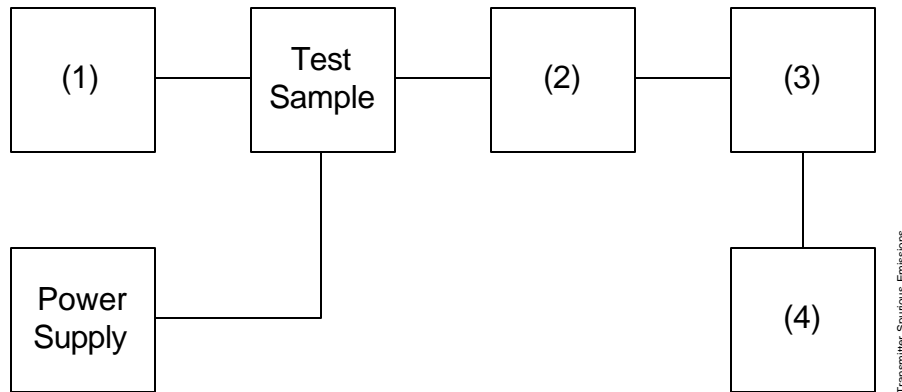

Asset (as applicable)	Description	s/n		
(1)	Audio Oscillator/Generator None			
(2)	Coaxial Attenuator None			
(3)	Filters; Notch, HP, LP, BP None			
(4)	Spectrum Analyzer			
	i00048 HP 8566B	2511A01467	12 mo.	Jul-05
X	i00029 HP 8563E	3213A00104	12 mo.	Jan-06

Name of Test: Emission Masks (Occupied Bandwidth)



Occupied Bandwidth
International Electronics
Low Channel

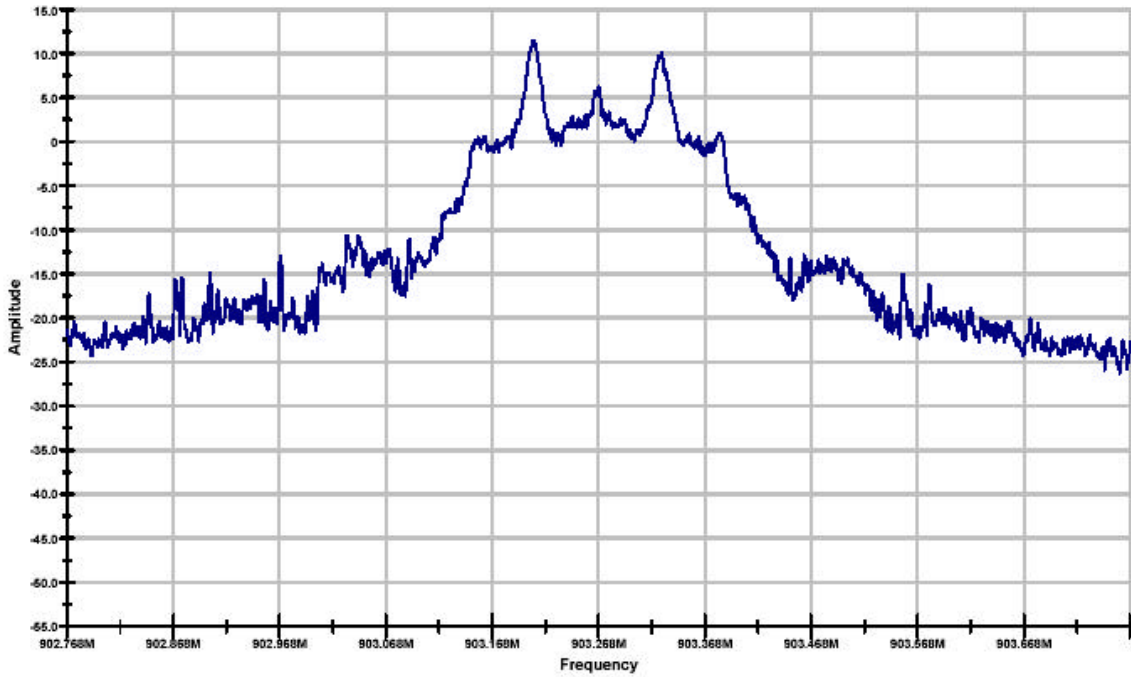

Power:
Channel:

High
Low
Loose Coupled

Performed By:

David E. Lee, FCC/IC Compliance Manager

Name of Test: Emission Masks (Occupied Bandwidth)



Occupied Bandwidth

International Electronics

Mid Channel

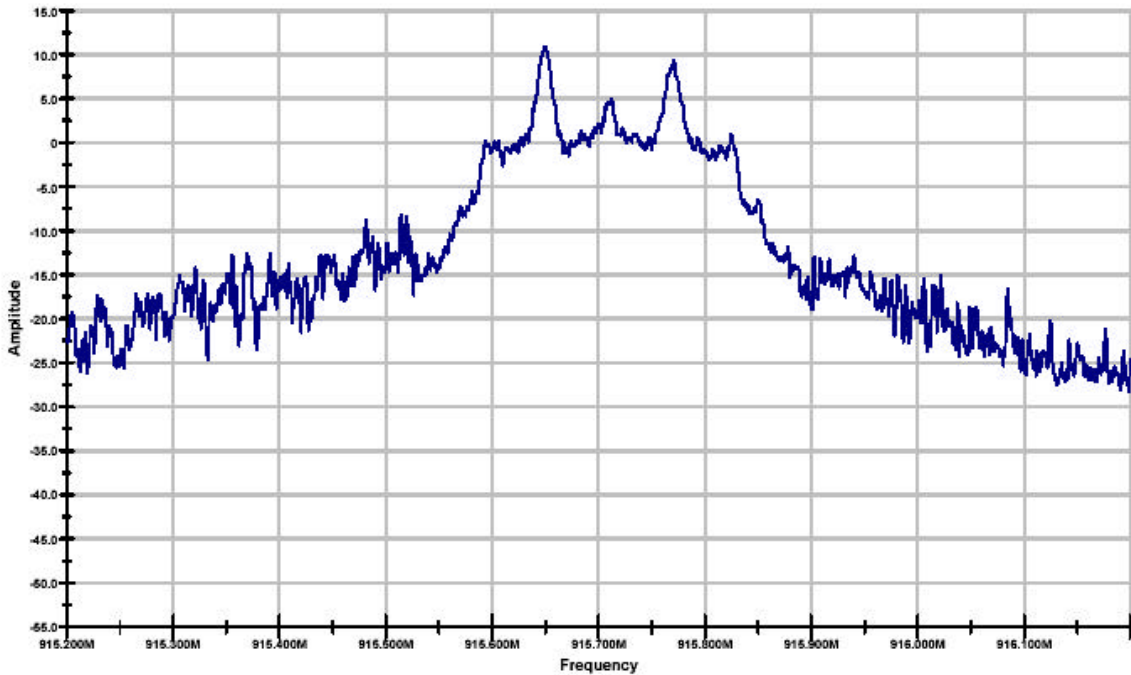

Power:
Channel:

High
Mid
Loose Coupled

Performed By:

David E. Lee, FCC/IC Compliance Manager

Name of Test: Emission Masks (Occupied Bandwidth)



Occupied Bandwidth
International Electronics
High Channel

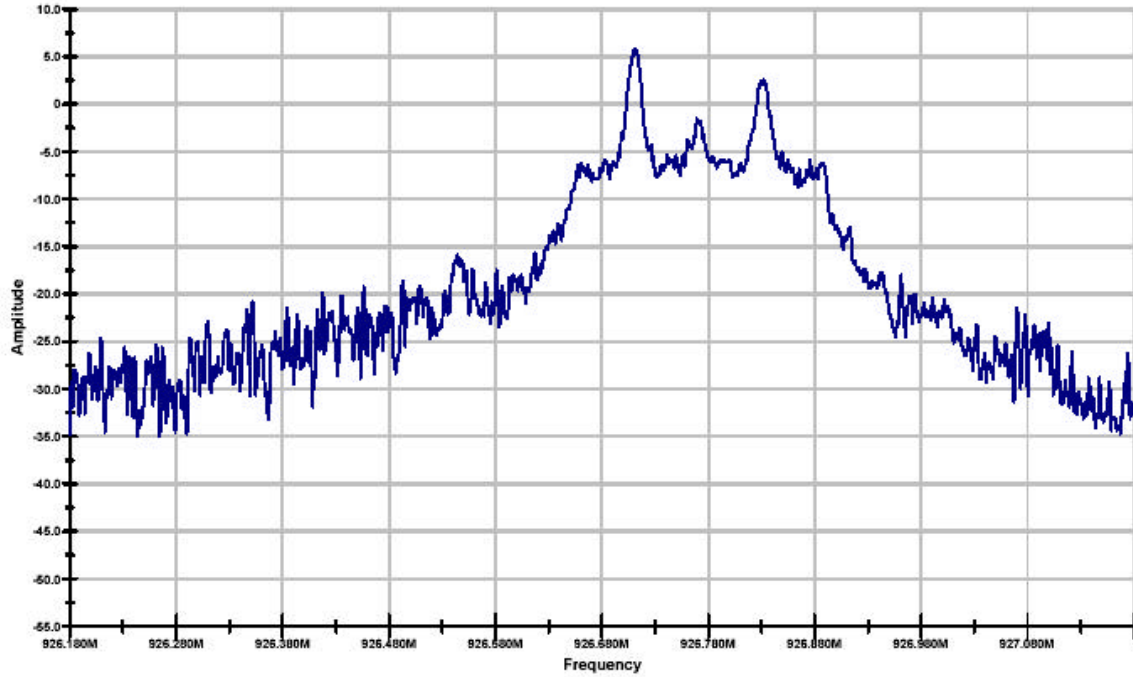

Power:
Channel:

High
High
Loose Coupled

Performed By:

David E. Lee, FCC/IC Compliance Manager

Name of Test: Emission Masks (Occupied Bandwidth)



Occupied Bandwidth
International Electronics
99% = 355kHz

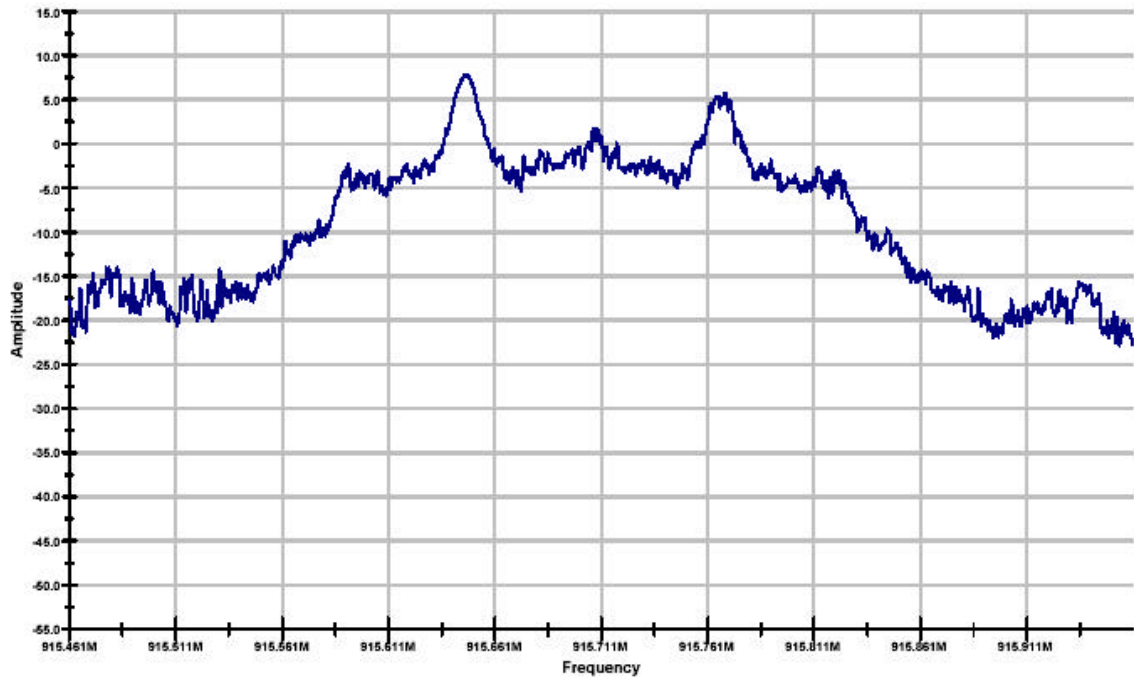

Power:
99% Power Bandwidth:

High
355kHz
Loose Coupled

Performed By:

David E. Lee, FCC/IC Compliance Manager

Name of Test: Necessary Bandwidth and Emission Bandwidth

Specification: 47 CFR 2.202(g)

Modulation = F1D

Necessary Bandwidth Measured, kHz: 355.0



Supervised By:

David E. Lee, FCC/IC Compliance Manager

Radiated Measurements For Part 15 Transmitters with Integral Antennas

Radiated Measurements

Range Of Measurement	Specification	Resolution B/W	Video B/A
30 to 1000 MHz	CISPR	=100 kHz	=100 kHz
>1000 MHz (if averaging)	FCC, 15.37(b)	1 MHz	=1 MHz
	FCC, 15.37(b)	1 MHz	10 Hz

Measuring Equipment

a. Antennas:

EMCO 3109	20 - 300 MHz
APREL AALP2001	200 - 1000 MHz
APREL AAB20200	20 - 200 MHz
APREL AAH118	1 - 18 GHz

b. Instruments:

HP8566B	Spectrum Analyzer
HP85685A	Preselector, w/ preamp below 2 GHz
HP85650A	Quasi Peak Adapter
HP8449	Preamp, above 2 GHz

Occupied Bandwidth

Occupied Bandwidth is measured as a radiated signal without attenuators and/or filter. RBW, VBW and scan settings as shown were set to produce a meaningful result in accordance with ANSI C63.4 (2003)

Part 15.21, Information to User

The users manual or instruction manual for an intentional or unintentional radiator shall caution the user that changes or modifications not expressly avoided by the party responsible for compliance could void the user's authority to operate the equipment.

§ 15.205 Restricted Bands of Operation

(a) Except as shown in paragraph (b) of this section, only spurious emissions are permitted in any of the frequency bands listed below:

MHz	MHz	MHz	GHz
0.090-0.110	16.42-16.423	399.9-410	4.5-5.25
0.495-0.505	16.69475-16.69625	608-614	5.35-5.46
2.1735-2.1905	16.80425-16.80475	960-1240	7.25-7.75
4.125-4.128	25.5-25.67	1300-1427	8.025-8.5
4.17725-4.17775	37.5-38.25	1435-1626.5	9.0-9.2
4.20725-4.20775	73-74.6	1645.5-1646.5	9.3-9.5
6.215-6.218	74.8-75.2	1660-1710	10.6-12.7
6.26775-6.26825	108-121.94	1718.8-1722.2	13.25-13.4
6.31175-6.31225	123-138	2200-2300	14.47-14.5
8.291-8.294	149.9-150.05	2310-2390	15.35-16.2
8.362-8.366	156.52475-156.52525	2483.5-2500	17.7-21.4
8.37625-8.38675	156.7-156.9	2655-2900	22.01-23.12
8.41425-8.41475	162.0125-167.17	3260-3267	23.6-24.0
12.29-12.293	167.72-173.2	3332-3339	31.2-31.8
12.51975-12.52025	240-285	3345.8-3358	36.43-36.5
12.57675-12.57725	322-339.4	3600-4400	
13.36-13.41			

**Testimonial
and
Statement of Certification**

This is to certify:

1. **That** the application was prepared either by, or under the direct supervision of, the undersigned.
2. **That** the technical data supplied with the application was taken under my direction and supervision.
3. **That** the data was obtained on representative units, randomly selected.
4. **That**, to the best of my knowledge and belief, the facts set forth in the application and accompanying technical data are true and correct.



Certifying Engineer:

David E. Lee, FCC/IC Compliance Manager