



Prüfbericht-Nr.: <i>Test Report No.:</i>	50280227 001	Auftrags-Nr.: <i>Order No.:</i>	238107582	Seite 1 von 34 <i>Page 1 of 34</i>
Kunden-Referenz-Nr.: <i>Client Reference No.:</i>	N/A	Auftragsdatum: <i>Order date:</i>	8-Jul-2019	
Auftraggeber: <i>Client:</i>	Kingston Technology Company, Inc., 17600 Newhope St, Fountain Valley, CA 92708, USA			
Prüfgegenstand: <i>Test item:</i>	HyperX CloudX Flight Wireless Gaming Headset			
Bezeichnung / Typ-Nr.: <i>Identification / Type No.:</i>	HX-HSCFX-BK/WW,HX-HSCFX-BK,HX-HSCFX***** (* = 0-9, A-Z, a-z, - or blank; to indicate different colors, packaging and shipping locations)			
Auftrags-Inhalt: <i>Order content:</i>	FCC Part 15C/ISED RSS-247/ Test report			
Prüfgrundlage: <i>Test specification:</i>	FCC 47CFR Part 15: Subpart C Section 15.247(DTS) RSS-247 ISSUE 2 FEB 2017			
Wareneingangsdatum: <i>Date of receipt:</i>	13-Jun-2019			
Prüfmuster-Nr.: <i>Test sample No.:</i>	A000958406-003 A000958406-002			
Prüfzeitraum: <i>Testing period:</i>	17-Jun-2019 - 11-Sep-2019			
Ort der Prüfung: <i>Place of testing:</i>	EMC/RF Laboratory Taipei			
Prüflaboratorium: <i>Testing laboratory:</i>	TUV Rheinland Taiwan Ltd.			
Prüfergebnis*: <i>Test result*:</i>	Pass			
geprüft von / tested by:		kontrolliert von / reviewed by:		
				
15-Aug-2019	Mars Y.J. Lin/Project Engineer	15-Aug-2019	Jack H. C. Chang/Project Manager	
Datum	Name / Stellung	Unterschrift	Datum	Name / Stellung
Date	Name / Position	Signature	Date	Name / Position
Sonstiges / Other:				
Zustand des Prüfgegenstandes bei Anlieferung: <i>Condition of the test item at delivery:</i>		Prüfmuster vollständig und unbeschädigt <i>Test item complete and undamaged</i>		
* Legende: 1 = sehr gut 2 = gut 3 = befriedigend 4 = ausreichend 5 = mangelhaft P(ass) = entspricht o.g. Prüfgrundlage(n) F(ail) = entspricht nicht o.g. Prüfgrundlage(n) N/A = nicht anwendbar N/T = nicht getestet		Legend: 1 = very good 2 = good 3 = satisfactory 4 = sufficient 5 = poor P(ass) = passed a.m. test specification(s) F(ail) = failed a.m. test specification(s) N/A = not applicable N/T = not tested		
Dieser Prüfbericht bezieht sich nur auf das o.g. Prüfmuster und darf ohne Genehmigung der Prüfstelle nicht auszugsweise vervielfältigt werden. Dieser Bericht berechtigt nicht zur Verwendung eines Prüfzeichens. <i>This test report only relates to the a. m. test sample. Without permission of the test center this test report is not permitted to be duplicated in extracts. This test report does not entitle to carry any test mark.</i>				

TEST SUMMARY

5.1.1 ANTENNA REQUIREMENT

RESULT: *Passed*

5.1.2 PEAK OUTPUT POWER

RESULT: *Passed*

5.1.3 6dB BANDWIDTH AND 99% BANDWIDTH

RESULT: *Passed*

5.1.4 POWER DENSITY

RESULT: *Passed*

5.1.5 CONDUCTED SPURIOUS EMISSIONS AND FREQUENCY BAND EDGE MEASURED IN 100KHZ BANDWIDTH

RESULT: *Passed*

5.1.6 SPURIOUS EMISSION

RESULT: *Passed*

5.2.1 MAINS CONDUCTED EMISSIONS

RESULT: *Passed*

6.1.1 ELECTROMAGNETIC FIELDS

RESULT: *Passed*

Contents

1.	GENERAL REMARKS	5
1.1	COMPLEMENTARY MATERIALS.....	5
1.2	DECISION RULE OF CONFORMITY	5
2.	TEST SITES	6
2.1	TEST LABORATORY	6
2.2	TEST FACILITY.....	6
2.3	LIST OF TEST AND MEASUREMENT INSTRUMENTS.....	7
2.4	TRACEABILITY	8
2.5	CALIBRATION	8
2.6	MEASUREMENT UNCERTAINTY	8
3.	GENERAL PRODUCT INFORMATION.....	9
3.1	PRODUCT FUNCTION AND INTENDED USE	9
3.2	SYSTEM DETAILS AND RATINGS.....	9
3.3	INDEPENDENT OPERATION MODES.....	10
3.4	NOISE GENERATING AND NOISE SUPPRESSING PARTS	10
3.5	SUBMITTED DOCUMENTS.....	10
4.	TEST SET-UP AND OPERATION MODES.....	11
4.1	PRINCIPLE OF CONFIGURATION SELECTION	11
4.2	TEST OPERATION AND TEST SOFTWARE.....	11
4.3	SPECIAL ACCESSORIES AND AUXILIARY EQUIPMENT	11
4.4	COUNTERMEASURES TO ACHIEVE EMC COMPLIANCE.....	12
4.5	TEST SETUP DIAGRAM	12
5.	TEST RESULTS	14
5.1	TRANSMITTER REQUIREMENT & TEST SUITES.....	14
5.1.1	<i>Antenna Requirement.....</i>	<i>14</i>
5.1.2	<i>Peak Output Power.....</i>	<i>15</i>
5.1.3	<i>6dB Bandwidth and 99% Bandwidth.....</i>	<i>16</i>
5.1.4	<i>Power Density.....</i>	<i>19</i>
5.1.5	<i>Conducted spurious emissions and Frequency Band Edge measured in 100kHz Bandwidth.....</i>	<i>22</i>
5.1.6	<i>Spurious Emission</i>	<i>26</i>
5.2	MAINS EMISSIONS.....	27
5.2.1	<i>Mains Conducted Emissions.....</i>	<i>27</i>
6.	SAFETY HUMAN EXPOSURE	28

6.1	RADIO FREQUENCY EXPOSURE COMPLIANCE	28
6.1.1	<i>Electromagnetic Fields.....</i>	<i>28</i>
7.	PHOTOGRAPHS OF THE TEST SET-UP.....	29
8.	LIST OF TABLES	34
9.	LIST OF PHOTOGRAPHS.....	34

1. General Remarks

1.1 Complementary Materials

The following attachments are integral parts of this test report:

Appendix P: Photo Documentation internal view
(File Name: 50280227APPENDIX P)

Appendix D: Test Result of Radiated Emissions
(File Name: 50280227APPENDIX D)

Test Specifications

The following standards were applied.

Table 1: Applied Standard and Test Levels

Radio
FCC CFR47 Part 15: Subpart C Section 15.247 RSS-247 Issue 2 Feb 2017 RSS-Gen, Issue 5, April 2018 ANSI C63.10:2013 KDB558074 D01 DTS Meas Guidance v05

1.2 Decision Rule of conformity

The decision rule of conformity of this test report is following the requirements of the requested standard in the quotation, and agreed among testing laboratory and manufacturer (applicant) to exclude the consideration of Measurement Uncertainty, unless it is required by the specific standard

2. Test Sites

2.1 Test Laboratory

TUV Rheinland Taiwan Ltd.
Taipei Testing Laboratories

11F. No.758, Sec. 4, Bade Rd., Songshan Dist.
Taipei City 105
Taiwan (R.O.C.)

2.2 Test Facility

TUV Rheinland Taiwan Ltd.

11F. No.758, Sec. 4, Bade Rd., Songshan Dist.
Taipei City 105
Taiwan (R.O.C.)

FCC RegistrationNo.: 180491
IC Canada Registration No.: 9465A
TAF Accredited NCC Test Lab. No.:3567
TAF ISO17025 Certification effective period: 6th-May-2019 to 05th-May-2022



Testing Laboratory
3567

2.3 List of Test and Measurement Instruments

Table 2: List of Test and Measurement Equipment

Kind of Equipment	Manu-facturer	Type	S/N	Last Calibration	Next Calibration
Test Software	Audix	e3	Ver.9	N/A	N/A
EMI Test Receiver	R&S	ESR 7	101549	2018/11/12	2019/11/10
Spectrum Analyzer	R&S	FSV 40	101514	2019/02/07	2020/02/07
EXA Signal Analyzer	KEYSIGHT	N9010A	MY52221334	2019/02/15	2020/02/14
Preamplifier (30MHz -1GHz)	Hewlett Packard	8447D	2944A06641	2019/01/08	2020/01/08
Preamplifier (18 GHz -40 GHz)	EMC Instruments	EMC184045SE	980652	2019/02/25	2020/02/25
Pre-Amplifier (1GHz~18GHz)	EM Electronics	EM01G18G	60649	2018/08/24	2019/09/24
Bilog Antenna	TESEQ	CBL 6111D	40101	2018/10/03	2019/10/03
Horn Antenna	ETS-Lindgren	3117	218931	2018/12/27	2019/12/27
Horn Antenna (18GHz~40GHz)	COM-POWER	AH-840	101029	2018/12/22	2019/12/22
Loop Antenna	Schwarzbeck	FMZB 1513	1513-076	2019/07/11	2020/07/11
EMI Test Receiver	R&S	ESR 7	101549	2018/11/12	2019/11/10
Two-Line V-Network	R&S	ENV216	101243	2019/06/23	2020/06/23
LISN	R&S	ENV216	101262	2019/07/16	2020/07/16
power Meter	Anritsu	ML2495A	1901008	2019/04/29	2020/04/28
Power Sensor	Anritsu	MA2411B	1725269	2019/04/29	2020/04/28

2.4 Traceability

All measurement equipment calibrations are traceable to NML(Taiwan)/NIST(USA) or where calibration is performed outside Taiwan, to equivalent nationally recognized standards organizations.

2.5 Calibration

Equipment requiring calibration is calibrated periodically in a suitably accredited Calibration Lab. Additionally all equipment is verified for proper performance on a regular schedule using in house standards or comparisons.

2.6 Measurement Uncertainty

The estimated combined standard uncertainty for radiated emissions and conducted emissions measurements .

Table 3: Emission Measurement Uncertainty

Parameter	Uncertainty
Radio Frequency	± 0.1 ppm
RF power/RF Exposure(MPE), conducted	± 1.5 dB
RF power density, conducted	± 3 dB
spurious emissions, conducted	± 3 dB
all emissions, radiated	± 6 dB
Temperature	± 1 °C
Humidity	± 5 %
DC and low frequency voltages	± 3 %

3. General Product Information

3.1 Product Function and Intended Use

The EUT is a Wireless adapter. It contains a 2.4GHz compatible chip enabling the user to communicate data through a Wireless interface.
 For details refer to the User Guide, Data Sheet and Circuit Diagram.

3.2 System Details and Ratings

Table 4: Basic Information of EUT

Item	EUT information
Kind of Equipment/Test Item	HyperX CloudX Flight Wireless Gaming Headset
Type Identification	HX-HSCFX-BK/WW,HX-HSCFX-BK,HX-HSCFX***** (*= 0-9, A-Z, a-z, - or blank; to indicate different colors, packaging and shipping locations)
Brand Name	HyperX
FCC ID	JIC-HSCFX
Canada ID	3880A-HSCFX
Canada HVIN	CLOUDX FLIGHT

Table 5: Technical Specification of EUT

Technical Specification	Value
Operating Frequencies	2405.35 - 2477.35MHz
Channel Spacing	2 MHz
Channel number	40
Operation Voltage	3.7 Vdc
Modulation	Pi/4 DQPSK
Antenna gain	2.99dBi

3.3 Independent Operation Modes

Basic operation modes are:

- A. Transmitting
 - 1. Low channel
 - 2. Middle channel
 - 3. High channel
- B. Receiving
- C. Standby
- D. Off

3.4 Noise Generating and Noise Suppressing Parts

Refer to the Circuit Diagram.

3.5 Submitted Documents

- Circuit Diagram
- Instruction Manual
- Rating Label
- Technical Description

4. Test Set-up and Operation Modes

4.1 Principle of Configuration Selection

The equipment under test (EUT) was configured to measure its maximum power level. The test modes were adapted accordingly in reference to the instructions for use.

4.2 Test Operation and Test Software

Setup for testing: Test samples are provided with a USB interface which makes it possible to control them through a test software installed on a notebook computer.

This software was running on the laptop computer connected to the EUT. It was used to enable the operation modes listed in section 3.3 as appropriate.

The samples were used as follows:

Conducted: A000958406-002

Radiation: A000958406-003

Full test was applied on all test modes, but only worst case was shown

Test Software	VMIttest-1.1.6.56
Frequency	Setting
2405.53	0x14
2439.35	0x14
2477.35	0x14

4.3 Special Accessories and Auxiliary Equipment

The product has been tested together with the following additional accessories:

Description	Manufacturer	Model No.	Serial No.
Notebook(EMC-06)	Lenovo	TP00048A	PB-0F8B2

4.4 Countermeasures to achieve EMC Compliance

The test sample which has been tested contained the noise suppression parts as described in the Constructional Data Form or the Technical Construction File. No additional measures were employed to achieve compliance.

4.5 Test Setup Diagram

Diagram of Measurement Configuration for Radiation Test

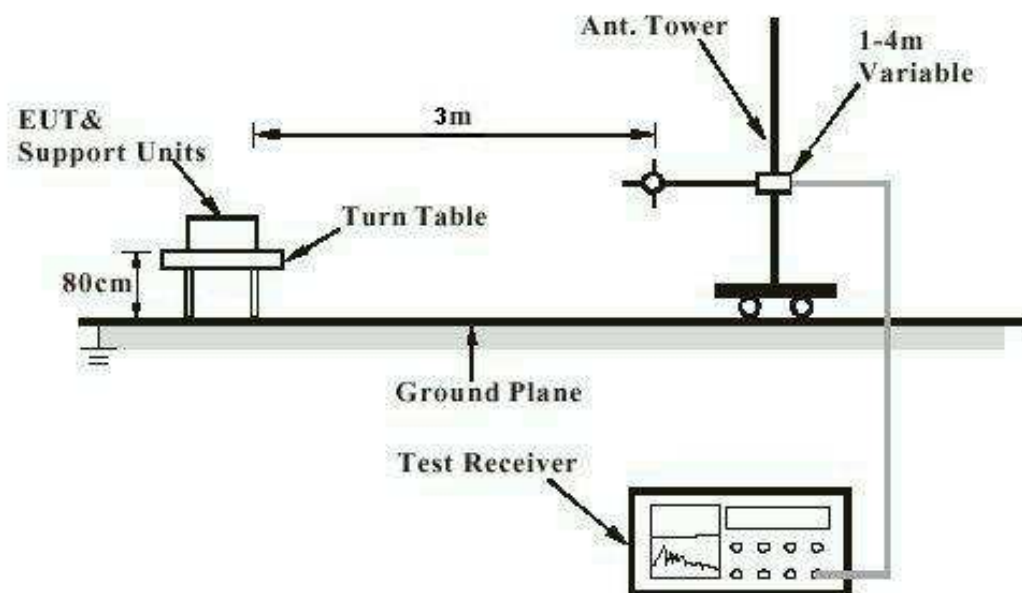

Note: Measurements above 1 GHz are done with a table height of 1.5m

Diagram of Measurement Equipment Configuration for Mains Conduction Measurement (if applicable)

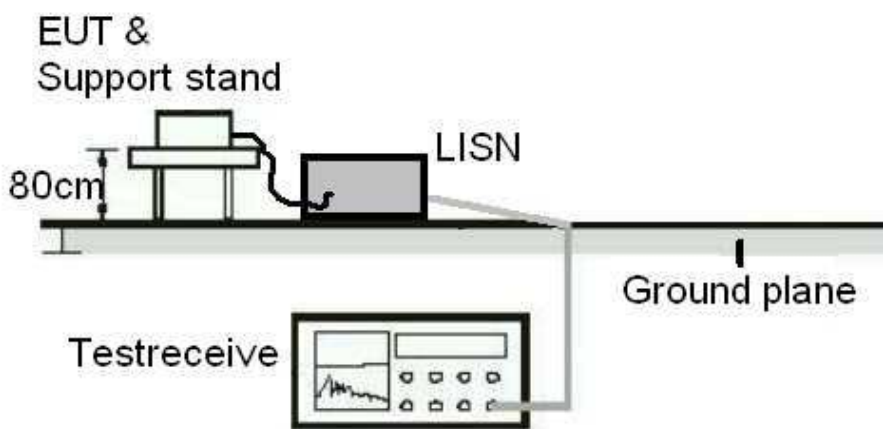
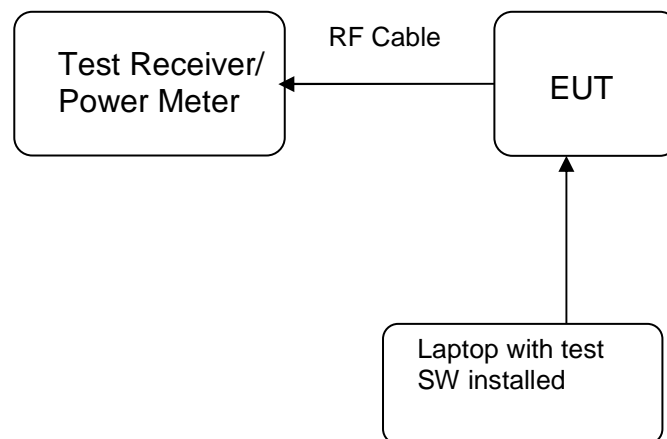

Diagram of Measurement Equipment Configuration for Conducted Transmitter Measurement



5. Test Results

5.1 Transmitter Requirement & Test Suites

5.1.1 Antenna Requirement

RESULT: **Passed**

Test standard : FCC Part 15.247(b)(4), Part 15.203 and RSS-Gen 6.8

Requirement : use of approved antennas only with directional gains that do not exceed 6 dBi

According to the manufacturer declaration, the EUT has an antenna with a directional gain of 2.99dBi. The antenna is a printed PCB trace with no possibility of replacement with a non-approved antenna by the end-user. Therefore, the EUT is considered to comply with this provision.

Refer to EUT photo for details.

5.1.2 Peak Output Power

RESULT:
Passed

Test standard : FCC Part 15.247(b)(3), RSS-247 5.4(d)
 Basic standard : ANSI C63.10:2013, KDB558074
 Limit : 1 Watt
 Kind of test site : Shielded room

Test setup

Test Channel : Low/ Middle/ High
 Operation Mode : A

 Ambient temperature : 20-24 °C
 Relative humidity : 50-65 %
 Atmospheric pressure : 100-103 kPa

Table 6: Test result of Peak Output Power (ANT0)

Channel	Channel Frequency (MHz)	Output Power		Limit (W)
		(dBm)	(W)	
Low Channel	2405.35	1.01	0.00126	1
Middle Channel	2439.35	1.07	0.00128	1
High Channel	2477.35	0.72	0.00118	1

Table 7: Test result of Peak Output Power (ANT1)

Channel	Channel Frequency (MHz)	Output Power		Limit (W)
		(dBm)	(W)	
Low Channel	2405.35	0.84	0.00121	1
Middle Channel	2439.35	0.66	0.00116	1
High Channel	2477.35	0.51	0.00112	1

Pmax: 1.2794 mW
 Pmax(avg): -1.71 dBm (0.67mW)

5.1.3 6dB Bandwidth and 99% Bandwidth

RESULT:
Passed

Test standard : FCC Part 15.247(a)(2), RSS-247 5.2(a)
 RSS-Gen (Issue 5)
 Basic standard : ANSI C63.10:2013, KDB558074
 Kind of test site : Shielded room

Test setup

Test Channel : Low/ Middle/ High
 Operation Mode : A

 Ambient temperature : 20-24°C
 Relative humidity : 50-65%
 Atmospheric pressure : 100-103 kPa

Table 8: Test result of 6dB Bandwidth

Channel	Channel Frequency (MHz)	6dB Bandwidth (kHz)	Limit (kHz)	Result
Low Channel	2405.35	1667	>500	Pass
Mid Channel	2439.35	1646	>500	Pass
High Channel	2477.35	1670	>500	Pass

Table 9: Test result of 99% Bandwidth,

Channel	Channel Frequency (MHz)	99% Bandwidth (kHz)
Mid Channel	2439.35	1920.8

Test Plot of 6dB Bandwidth

Low Channel

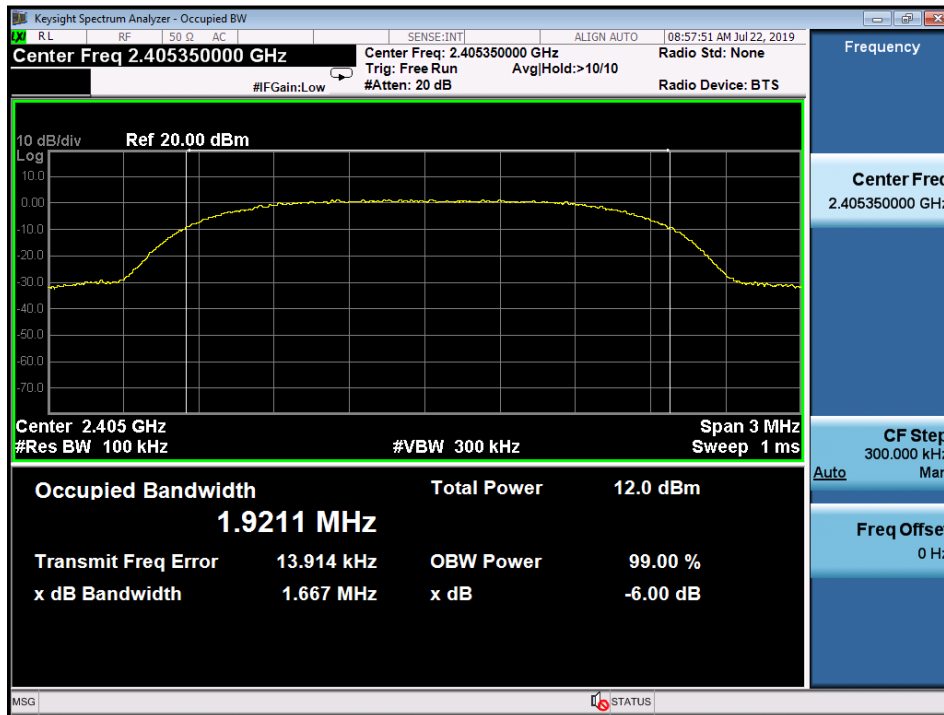

Middle Channel

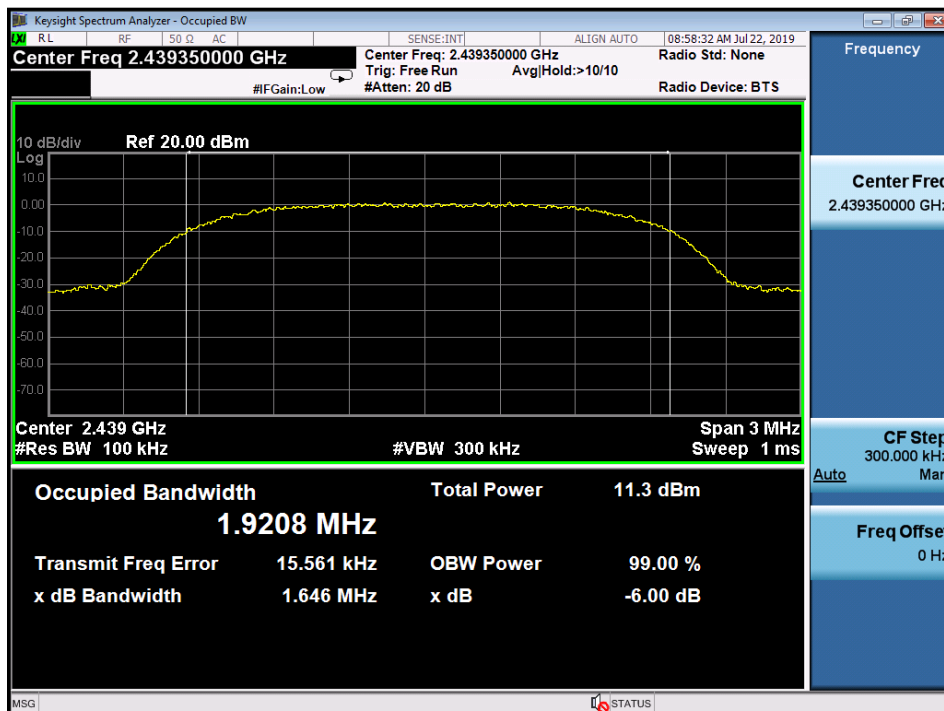

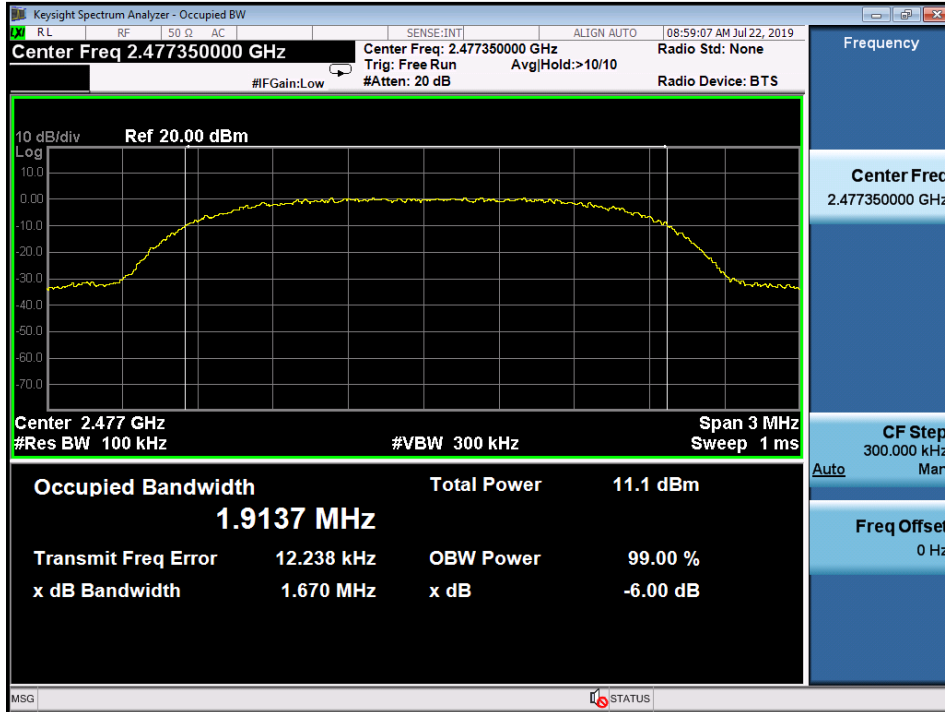
High Channel

5.1.4 Power Density

RESULT:
Passed

Test standard : FCC Part 15.247(e) , RSS-247 5.2(b)
 Basic standard : ANSI C63.10:2013, KDB558074
 Kind of test site : Shielded room

Test setup

Test Channel : Low/ Middle/ High
 Operation Mode : A
 Ambient temperature : 20-24°C
 Relative humidity : 50-65%
 Atmospheric pressure : 100-103 kPa

Table 10: Test result of Power Density

Channel	Channel Frequency (MHz)	Power Density	Limit
		(dBm)	(dBm)
Low Channel	2405.35	-12.68	8
Middle Channel	2439.35	-12.72	8
High Channel	2477.35	-13.64	8

Test Plot of Power Density

Low Channel

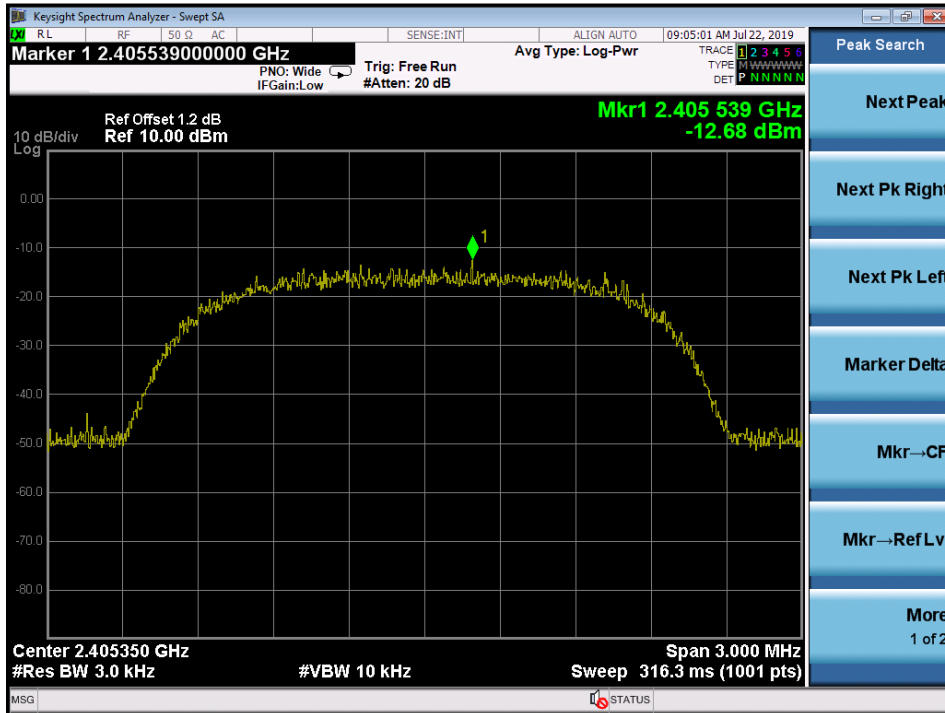

Middle Channel

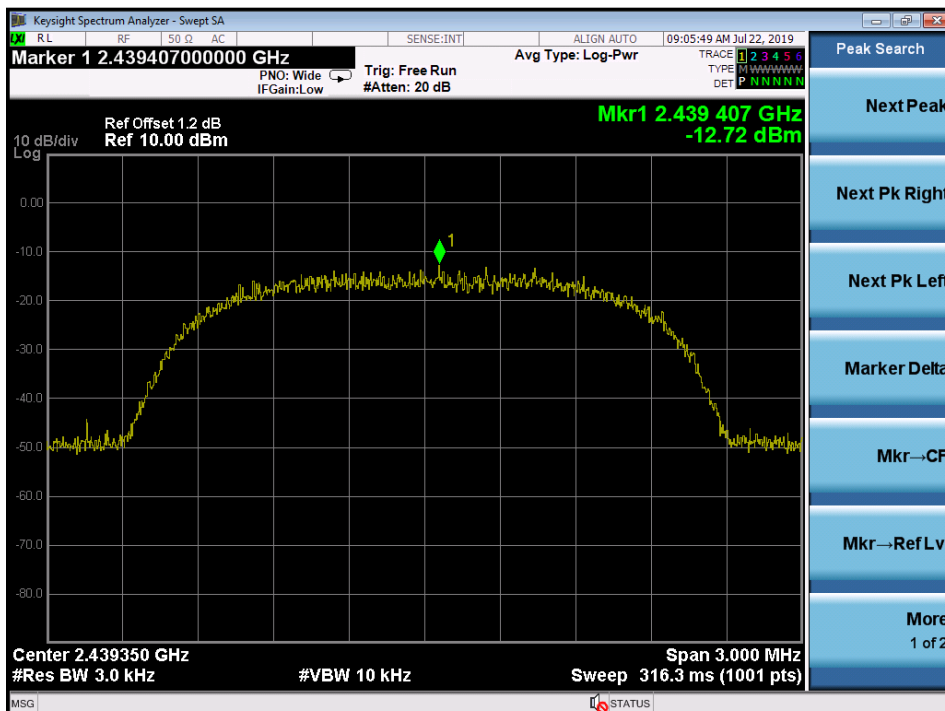

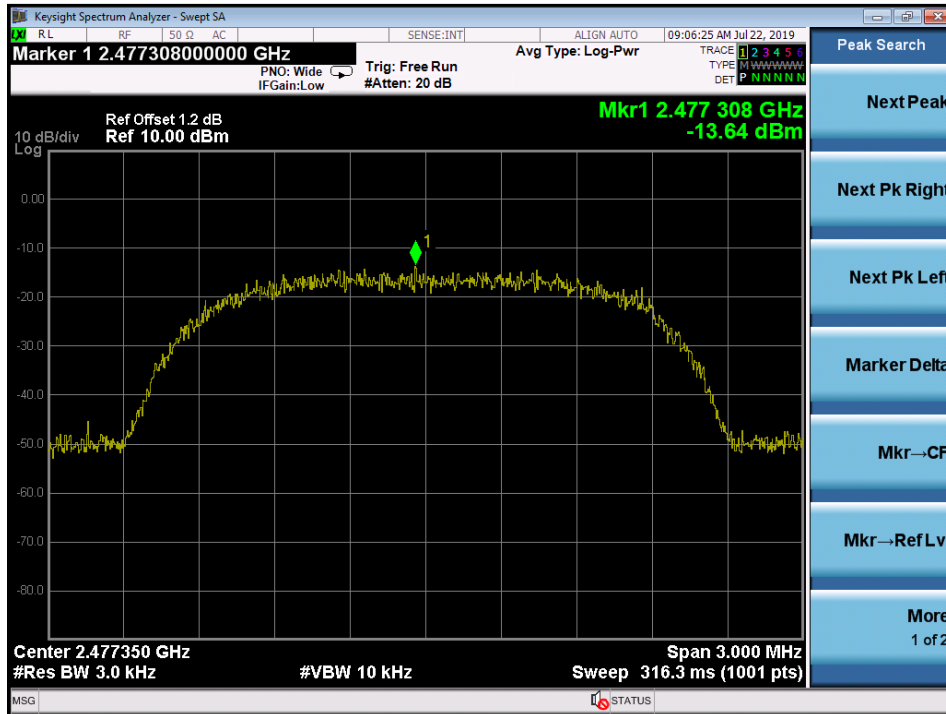
High Channel

5.1.5 Conducted spurious emissions and Frequency Band Edge measured in 100kHz Bandwidth

RESULT:**Passed**

Test standard	:	FCC part 15.247(d), RSS-247 5.5
Basic standard	:	ANSI C63.10:2013, KDB558074
Limit	:	20dB (below that in the 100kHz bandwidth within the band that contains the highest level of the desired power)
Kind of test site	:	Shielded room

Test setup

Test Channel	:	Low/ Middle/ High for Conducted Spurious Emissions Low/ High for Frequency Band Edge
Operation Mode	:	A
Ambient temperature	:	20-24°C
Relative humidity	:	50-65%
Atmospheric pressure	:	100-103 kPa

All emissions are more than 20dB below fundamental, details refer to following test plot, and compliance is achieved as well.

Due to the small size of the RF circuit and that there are no inductive components of significant size connected to the antenna port, 9kHz to 30MHz frequency range is not tested based on technical judgment.

Test Plot 100kHz RBW of Band Edge

Low Channel

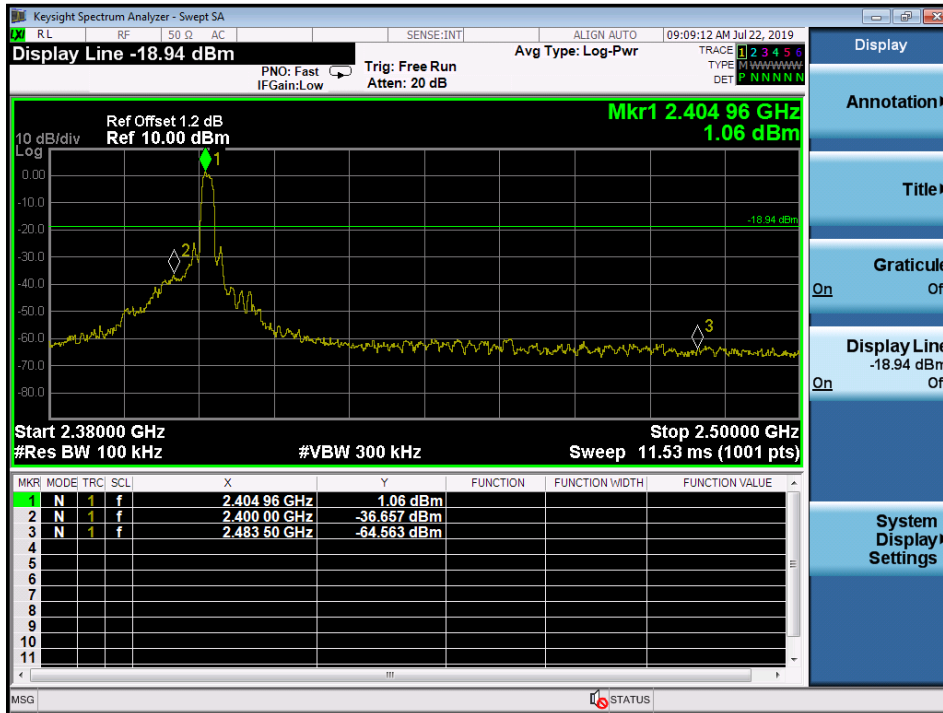

High Channel

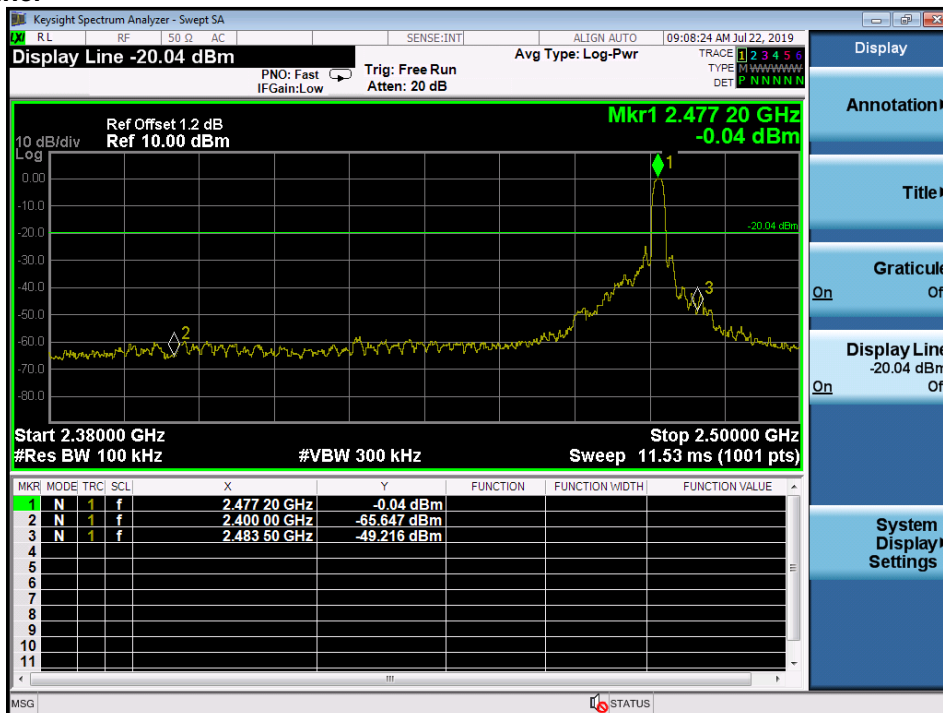

5.1.6 Spurious Emission

RESULT:**Passed**

Test standard	:	FCC part 15.247(d), FCC 15.205, FCC 15.209 and RSS-Gen 8.9 and RSS-Gen 8.10
Basic standard	:	ANSI C63.10: 2013
Limits	:	Radiated emissions which fall in the restricted bands, as defined in FCC 15.205(a) and RSS-Gen i5, 8.10 (Table 7), must comply with the radiated emission limits specified in FCC 15.209(a) and RSS-Gen 5, 8.9 (Table 5 and 6).
		Emission radiated outside the restricted and authorized frequency bands must either comply with the radiated emission limits specified for the restricted bands or in FCC15.247(d) and RSS-247 i2, 5.5
Kind of test site	:	3m Semi-Anechoic Chamber

Test setup

Test Channel	:	Low/ Middle/ High
Operation mode	:	A, B
Ambient temperature	:	20-24 °C
Relative humidity	:	50-65 %
Atmospheric pressure	:	100-103 kPa

Factor (dB/m)=Antenna Factor(dB/m)+Cable loss (dB)

Level(dBuV/m)=Reading(dBuV)+ Factor(dB/m)

For details refer to Appendix D.

Testing was carried out within frequency range 9kHz to the tenth harmonic. For details refer to Appendix D. The Radiated Emissions testing was performed in the X, Y and Z axis orientation. The worst-case Axis orientation is recorded in this test report.

5.2 Mains Emissions

5.2.1 Mains Conducted Emissions

RESULT:**Passed**

Test standard : FCC Part 15.207
FCC Part 15.107
RSS-Gen 8.8

Limits : Mains Conducted emissions as defined in
above test standards must comply with the
mains conducted emission limits specified

Kind of test site : Shielded Room

Test setup

Test Channel : Normal link
Operation mode : Normal link

Ambient temperature : 20-24 °C
Relative humidity : 50-65 %
Atmospheric pressure : 100-103 kPa

Remark: For details refer to Appendix D.

6. Safety Human exposure

6.1 Radio Frequency Exposure Compliance

6.1.1 Electromagnetic Fields

RESULT:**Passed**Test standard : FCC KDB Publication 447498 D01
RSS-102 issue 5, Table 1FCC:

Since maximum average output power of the transmitter is 0.67 mW < 10mW, hence the EUT is excluded from SAR evaluation according to FCC KDB publication 447498: Mobile Portable RF Exposure

Canada:

Maximum conducted average power: 0.67 mW

Antenna Gain: 2.99 dbi -> x 1.99

Maximum EIRP available 2.8274 mW

=====
Maximum Power available: 2.8274 mW
(higher of EIRP or conducted)

Since maximum output power of the transmitter is 2.8274 mW < 4mW at 5mm, hence the EUT is excluded from SAR evaluation according to Table 1 in RSS-102

8. List of Tables

Table 1: Applied Standard and Test Levels	5
Table 2: List of Test and Measurement Equipment	7
Table 3: Emission Measurement Uncertainty.....	8
Table 4: Basic Information of EUT	9
Table 5: Technical Specification of EUT	9
Table 6: Test result of Peak Output Power (ANT0).....	15
Table 7: Test result of Peak Output Power (ANT1).....	15
Table 8: Test result of 6dB Bandwidth	16
Table 9: Test result of 99% Bandwidth,.....	16
Table 10: Test result of Power Density	19

9. List of Photographs

Photograph 1: Set-up for Spurious Emissions (Front View).....	29
Photograph 2: Set-up for Spurious Emissions (Back View 1)	30
Photograph 3: Set-up for Spurious Emissions (Back View 2)	30
Photograph 4: Set-up for Spurious Emissions (X axis orientation pre-test)	31
Photograph 5: Set-up for Spurious Emissions (Y axis orientation pre-test)	31
Photograph 6: Set-up for Spurious Emissions (Z axis orientation pre-test)	32
Photograph 4: Set-up for Conducted testing	32
Photograph 5: Set-up for for Mains Conducted testing Back	33
Photograph 6: Set-up for for Mains Conducted testing Front.....	33