

Prüfbericht-Nr.: <i>Test report no.:</i>	60395865 001	Auftrags-Nr.: <i>Order no.:</i>	238487847	Seite 1 von 32 Page 1 of 32
Kunden-Referenz-Nr.: <i>Client reference no.:</i>	N/A	Auftragsdatum: <i>Order date:</i>	15-Jun-2020	
Auftraggeber: <i>Client:</i>	Kingston Technology Company, Inc., 17600 Newhope St, Fountain Valley, CA 92708, USA			
Prüfgegenstand: <i>Test item:</i>	HyperX Cloud II Wireless Adapter			
Bezeichnung / Typ-Nr.: <i>Identification / Type no.:</i>	CL002WA			
Auftrags-Inhalt: <i>Order content:</i>	FCC Part 15C/ISED RSS-247/ Test report			
Prüfgrundlage: <i>Test specification:</i>	FCC 47CFR Part 15: Subpart C Section 15.247(DTS) ISED RSS-247 ISSUE 2 FEB 2017			
Wareneingangsdatum: <i>Date of sample receipt:</i>	16-Jun-2020			
Prüfmuster-Nr.: <i>Test sample no.:</i>	A002844544-013 A002844544-016			
Prüfzeitraum: <i>Testing period:</i>	06-Jul-2020 - 09-Jul-2020			
Ort der Prüfung: <i>Place of testing:</i>	EMC/RF Laboratory Taipei			
Prüflaboratorium: <i>Testing laboratory:</i>	Taipei Testing laboratories			
Prüfergebnis*: <i>Test result*:</i>	Pass			
überprüft von: <i>reviewed by:</i>	genehmigt von: <i>authorized by:</i>			
Datum: 20-Jul-2020 <i>Date:</i>	Datum: 20-Jul-2020 <i>Date:</i>			
Stellung / Position: <i>Project Manager</i>	Jack H.C. Chang	Stellung / Position: <i>Project Manager</i>	Ryan W.T. Chen	
Sonstiges / Other:				
Zustand des Prüfgegenstandes bei Anlieferung: <i>Condition of the test item at delivery:</i>		Prüfmuster vollständig und unbeschädigt <i>Test item complete and undamaged</i>		
* Legende:	1 = sehr gut P(ass) = entspricht o.g. Prüfgrundlage(n)	2 = gut F(ail) = entspricht nicht o.g. Prüfgrundlage(n)	3 = befriedigend N/A = nicht anwendbar	4 = ausreichend N/T = nicht getestet
* Legend:	1 = very good P(ass) = passed a.m. test specification(s)	2 = good F(ail) = failed a.m. test specification(s)	3 = satisfactory N/A = not applicable	4 = sufficient N/T = not tested
<p>Dieser Prüfbericht bezieht sich nur auf das o.g. Prüfmuster und darf ohne Genehmigung der Prüfstelle nicht auszugsweise vervielfältigt werden. Dieser Bericht berechtigt nicht zur Verwendung eines Prüfzeichens. <i>This test report only relates to the a. m. test sample. Without permission of the test center this test report is not permitted to be duplicated in extracts. This test report does not entitle to carry any test mark.</i></p>				

TEST SUMMARY

5.1.1 ANTENNA REQUIREMENT

RESULT: *Passed*

5.1.2 PEAK OUTPUT POWER

RESULT: *Passed*

5.1.3 6dB BANDWIDTH AND 99% BANDWIDTH

RESULT: *Passed*

5.1.4 POWER DENSITY

RESULT: *Passed*

5.1.5 CONDUCTED SPURIOUS EMISSIONS AND FREQUENCY BAND EDGE MEASURED IN 100KHZ BANDWIDTH

RESULT: *Passed*

5.1.6 SPURIOUS EMISSION

RESULT: *Passed*

5.2.1 MAINS CONDUCTED EMISSIONS

RESULT: *Passed*

6.1.1 ELECTROMAGNETIC FIELDS

RESULT: *Passed*

Contents

1.	GENERAL REMARKS	5
1.1	COMPLEMENTARY MATERIALS.....	5
1.2	DECISION RULE OF CONFORMITY	5
2.	TEST SITES	6
2.1	TEST LABORATORY	6
2.2	TEST FACILITY.....	6
2.3	LIST OF TEST AND MEASUREMENT INSTRUMENTS.....	7
2.4	TRACEABILITY	8
2.5	CALIBRATION	8
2.6	MEASUREMENT UNCERTAINTY	8
3.	GENERAL PRODUCT INFORMATION.....	9
3.1	PRODUCT FUNCTION AND INTENDED USE	9
3.2	SYSTEM DETAILS AND RATINGS.....	9
3.3	INDEPENDENT OPERATION MODES.....	10
3.4	NOISE GENERATING AND NOISE SUPPRESSING PARTS	10
3.5	SUBMITTED DOCUMENTS.....	10
4.	TEST SET-UP AND OPERATION MODES.....	11
4.1	PRINCIPLE OF CONFIGURATION SELECTION	11
4.2	TEST OPERATION AND TEST SOFTWARE.....	11
4.3	SPECIAL ACCESSORIES AND AUXILIARY EQUIPMENT	12
4.4	COUNTERMEASURES TO ACHIEVE EMC COMPLIANCE.....	12
4.5	TEST SETUP DIAGRAM	13
5.	TEST RESULTS	15
5.1	TRANSMITTER REQUIREMENT & TEST SUITES.....	15
5.1.1	<i>Antenna Requirement</i>	<i>15</i>
5.1.2	<i>Peak Output Power</i>	<i>16</i>
5.1.3	<i>6dB Bandwidth and 99% Bandwidth.....</i>	<i>17</i>
5.1.4	<i>Power Density</i>	<i>22</i>
5.1.5	<i>Conducted spurious emissions and Frequency Band Edge measured in 100kHz Bandwidth.....</i>	<i>25</i>
5.1.6	<i>Spurious Emission</i>	<i>29</i>
5.2	MAINS EMISSIONS.....	30
5.2.1	<i>Mains Conducted Emissions.....</i>	<i>30</i>
6.	SAFETY HUMAN EXPOSURE	31

6.1	RADIO FREQUENCY EXPOSURE COMPLIANCE	31
6.1.1	<i>Electromagnetic Fields.....</i>	<i>31</i>
7.	LIST OF TABLES	32

1. General Remarks

1.1 Complementary Materials

The following attachments are integral parts of this test report:

Appendix P: Photo Documentation internal view
(File Name: 60395865 001 Appendix P)

Appendix D: Test Result of Radiated Emissions
(File Name: 60395865 001 Appendix D)

Appendix X: Photographs of the Test Set-Up
(File Name: 60395865 001 Appendix X)

Test Specifications

The following standards were applied.

Table 1: Applied Standard and Test Levels

Radio
FCC CFR47 Part 15: Subpart C Section 15.247 ISED RSS-247 Issue 2 Feb 2017 ISED RSS-Gen, Issue 5, April 2018 ANSI C63.10:2013 KDB558074 D01 DTS Meas Guidance v05

1.2 Decision Rule of conformity

The decision rule of conformity of this test report is following the requirements of the requested standard in the quotation, and agreed among testing laboratory and manufacturer (applicant) to exclude the consideration of Measurement Uncertainty, unless it is required by the specific standard

2. Test Sites

2.1 Test Laboratory

Taipei Testing laboratories

11F. No.758, Sec. 4, Bade Rd., Songshan Dist.
Taipei City 105
Taiwan (R.O.C.)

2.2 Test Facility

Taipei Testing laboratories

No. 458-18, Sec 2, Fenliao., Linkou Dist.
New Taipei City 244
Taiwan (R.O.C.)
FCC Registration No.: 226631
IC Canada Registration No.: 25563

TAF Accredited NCC Test Lab. No.:3567

TAF ISO17025 Certification effective period: 6th-May-2019 to 05th-May-2022



Testing Laboratory
3567

2.3 List of Test and Measurement Instruments

Table 2: List of Test and Measurement Equipment

Equipment	Manufacturer	Model No.	Serial No.	Cal. Date	Cal. Due Date
Spectrum Analyzer	R&S	FSV40	101512	2020/2/18	2021/2/16
Power Meter	Anritsu	ML2495A	1901008	2020/4/6	2021/4/5
Power Sensor	Anritsu	MA2411B	1725269	2020/4/7	2021/4/6
Signal Analyzer	R&S	FSV40	101508	2020/3/16	2021/3/15
Receiver	R&S	ESR7	102108	2020/3/16	2021/3/15
Bilog Antenna	SCHWARZBECK	VULB-9168	00951	2020/2/14	2021/2/12
Horn Antenna	ETS-Lindgren	3117	00218930	2019/12/6	2020/12/4
LF-AMP	Agilent	8447D	2944A10772	2020/2/11	2021/2/9
HF-AMP + AC source	EMCI	EMC051845SE	980633	2020/2/17	2021/2/15
HF-AMP + AC source	EMCI	EMC184045SE	980657	2020/2/17	2021/2/15
Horn Antenna	SCHWARZBECK	BBHA 9170	00887	2020/4/10	2021/4/9
Microwave Cable	HUBER+SUHNER	SUCOFLEX 104EA	800056/4EA	2020/3/25	2021/3/24
Microwave Cable	HUBER+SUHNER	SUCOFLEX 104	804680/4	2020/3/25	2021/3/24
Microwave Cable	HUBER+SUHNER	SUCOFLEX 104	MY37202/4	2020/3/25	2021/3/24
Microwave Cable	HUBER+SUHNER	SUCOFLEX 102EA	800898/2EA	2020/4/22	2021/4/21
Microwave Cable	HUBER+SUHNER	SUCOFLEX 102EA	800901/2EA	2020/4/22	2021/4/21
Microwave Cable	HUBER+SUHNER	SUCOFLEX 102EA	801027/2EA	2020/4/22	2021/4/21
EMI Test Receiver	R&S	ESR7	102108	2020/3/16	2021/3/15
TWO-LINE V-NETWORK	SCHWARZBECK	NSLK 8127	8127-00976	2019/10/2	2020/9/30
Pulse Limiter	Rohde & Schwarz	ESH3-Z2	0357.8810.54-102102-HN	2019/07/25	2020/07/25
Test Software	Audix	e3	Ver. 9	N/A	N/A

2.4 Traceability

All measurement equipment calibrations are traceable to NML(Taiwan)/NIST(USA) or where calibration is performed outside Taiwan, to equivalent nationally recognized standards organizations.

2.5 Calibration

Equipment requiring calibration is calibrated periodically in a suitably accredited Calibration Lab. Additionally all equipment is verified for proper performance on a regular schedule using in house standards or comparisons.

2.6 Measurement Uncertainty

The estimated combined standard uncertainty for radiated emissions and conducted emissions measurements .

Table 3: Emission Measurement Uncertainty

Parameter	Uncertainty
Radio Frequency	± 0.1 ppm
RF power/RF Exposure(MPE), conducted	± 1.5 dB
RF power density, conducted	± 3 dB
spurious emissions, conducted	± 3 dB
all emissions, radiated	± 6 dB
Temperature	± 1 °C
Humidity	± 5 %
DC and low frequency voltages	±3 %

3. General Product Information

3.1 Product Function and Intended Use

The EUT is a Wireless Adapter. It contains a 2.4GHz compatible RF chip enabling the user to communicate data through a Wireless interface.
For details refer to the User Guide, Data Sheet and Circuit Diagram.

3.2 System Details and Ratings

Table 4: Basic Information of EUT

Item	EUT information
Kind of Equipment/Test Item	HyperX Cloud II Wireless Adapter
Type Identification	CL002WA
FCC ID	JIC-CL002WA
IC ID	3880A-CL002WA
HVIN	CL002WA

Table 5: Technical Specification of EUT

Technical Specification	Value
Operating Frequencies	2405.35 - 2477.35MHz
Channel Spacing	2 MHz
Channel number	37
Operation Voltage	5 Vdc (USB)
Modulation	Pi/4 DQPSK
Antenna gain	1.21 dBi

3.3 Independent Operation Modes

Basic operation modes are:

- A. Transmitting
 - 1. Low channel
 - 2. Middle channel
 - 3. High channel
- B. Receiving
- C. Standby
- D. Off

3.4 Noise Generating and Noise Suppressing Parts

Refer to the Circuit Diagram.

3.5 Submitted Documents

- Circuit Diagram
- Instruction Manual
- Rating Label
- Technical Description

4. Test Set-up and Operation Modes

4.1 Principle of Configuration Selection

The equipment under test (EUT) was configured to measure its maximum power level. The test modes were adapted accordingly in reference to the instructions for use.

4.2 Test Operation and Test Software

Setup for testing: Test samples are provided with a USB interface which makes it possible to control them through a test software installed on a notebook computer.

This software was running on the laptop computer connected to the EUT. It was used to enable the operation modes listed in section 3.3 as appropriate.

The samples were used as follows:

Conducted: A002844544-016

Radiation: A002844544-013

Full test was applied on all test modes, but only worst case was shown

Test Software	VMI Debug v1.1.6.48
Frequency	Setting
2405.53 MHz	0X8
2439.35 MHz	0X8
2477.35 MHz	0X8

4.3 Special Accessories and Auxiliary Equipment

The product has been tested together with the following additional accessories:

Accessory of EUT

N/A

Support Unit

Item NO.	Description	Manufacturer	Model No.	Serial No.	Length(m)
1	Notebook	Lenovo	81BL	MP1DCD6Y	-
2	Adapter	Lenovo	ADLX65NCC3A	-	-
A	Adapter Cable	-	-	-	1.6

4.4 Countermeasures to achieve EMC Compliance

The test sample which has been tested contained the noise suppression parts as described in the Constructional Data Form or the Technical Construction File. No additional measures were employed to achieve compliance.

4.5 Test Setup Diagram

Diagram of Measurement Configuration for Radiation Test

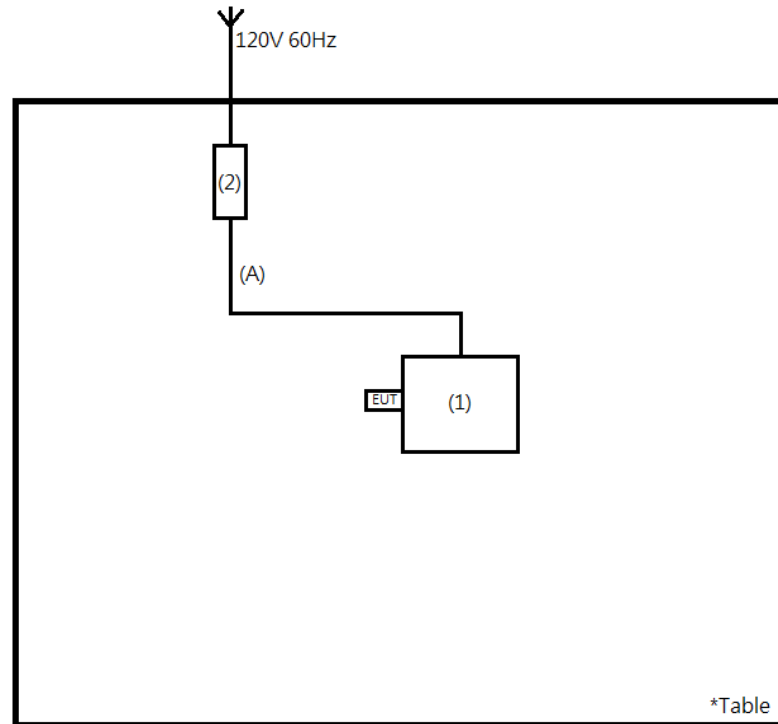

Diagram of Measurement Equipment Configuration for Mains Conduction Measurement (if applicable)

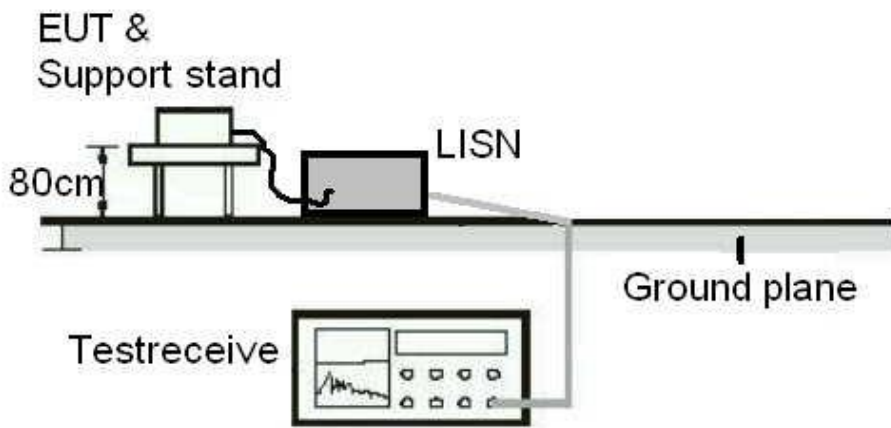
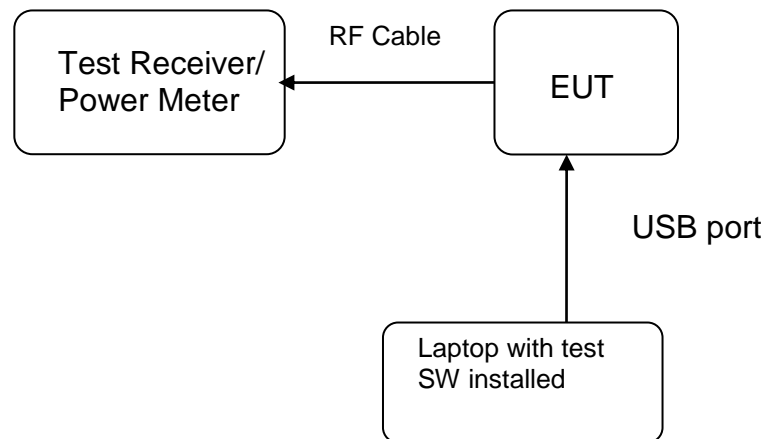

Diagram of Measurement Equipment Configuration for Conducted Transmitter Measurement



5. Test Results

5.1 Transmitter Requirement & Test Suites

5.1.1 Antenna Requirement

RESULT: **Passed**

Test standard : FCC Part 15.247(b)(4), Part 15.203,
ISED RSS-Gen 6.8

According to the manufacturer declaration, the EUT has an antenna with a directional gain of 1.21 dBi. The antenna is a printed PCB trace with no possibility of replacement with a non-approved antenna by the end-user. Therefore, the EUT is considered to comply with this provision.

This device contains two equivalent antennas, named as Ant0 and Ant 1, only SISO mode supported.

Refer to EUT photo for details.

5.1.2 Peak Output Power

RESULT:
Passed

Test standard : FCC Part 15.247(b)(3), ISED RSS-247 5.4(d)
 Basic standard : ANSI C63.10:2013, KDB558074
 Limit : 1 Watt
 Kind of test site : Shielded room

Test setup

Test Channel : Low/ Middle/ High
 Operation Mode : A

 Ambient temperature : 20-24 °C
 Relative humidity : 50-65 %
 Atmospheric pressure : 100-103 kPa

Table 6: Test result of Peak Output Power
ANT0

Channel	Channel Frequency (MHz)	Output Power		Average output power (W)	Limit (W)
		(dBm)	(W)		
Low Channel	2405.35	6.89	0.00489	0.00313	1
Middle Channel	2439.35	6.62	0.00459	0.00278	1
High Channel	2477.35	6.21	0.00418	0.00252	1

ANT1

Channel	Channel Frequency (MHz)	Output Power		Average output power (W)	Limit (W)
		(dBm)	(W)		
Low Channel	2405.35	5.79	0.00379	0.00234	1
Middle Channel	2439.35	5.31	0.00340	0.00211	1
High Channel	2477.35	4.38	0.00274	0.00170	1

Remark: This device contains two equivalent antennas, named as Ant0 and Ant 1, only SISO mode supported. The two antenna ports are identical in RF characteristics, full tests were performed on ant 0, which producing a higher radiated power. See antenna specification for more details.

Pmax: 4.89 mW

5.1.3 6dB Bandwidth and 99% Bandwidth

RESULT:
Passed

Test standard : FCC Part 15.247(a)(2), ISED RSS-247 5.2(a)
 : ISED RSS-Gen (Issue 5)
 Basic standard : ANSI C63.10:2013, KDB558074
 Kind of test site : Shielded room

Test setup

Test Channel : Low/ Middle/ High
 Operation Mode : A

 Ambient temperature : 20-24°C
 Relative humidity : 50-65%
 Atmospheric pressure : 100-103 kPa

Table 7: Test result of 6dB Bandwidth

Channel	Channel Frequency (MHz)	6dB Bandwidth (MHz)	Limit (kHz)	Result
Low Channel	2405.35	1.668	>500	Pass
Mid Channel	2439.35	1.638	>500	Pass
High Channel	2477.35	1.643	>500	Pass

Table 8: Test result of 99% Bandwidth

Channel	Channel Frequency (MHz)	99% Bandwidth (MHz)
Low Channel	2405.35	1.93
Mid Channel	2439.35	1.92
High Channel	2477.35	1.92

Test Plot of 6dB

Low Channel

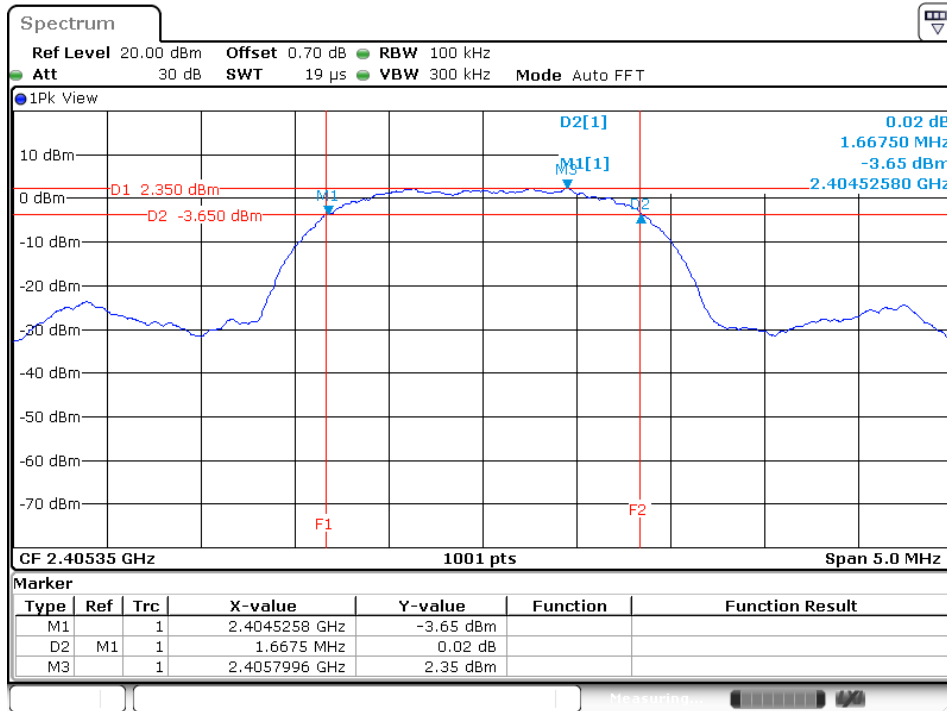

Date: 6.JUL.2020 15:26:48

Middle Channel

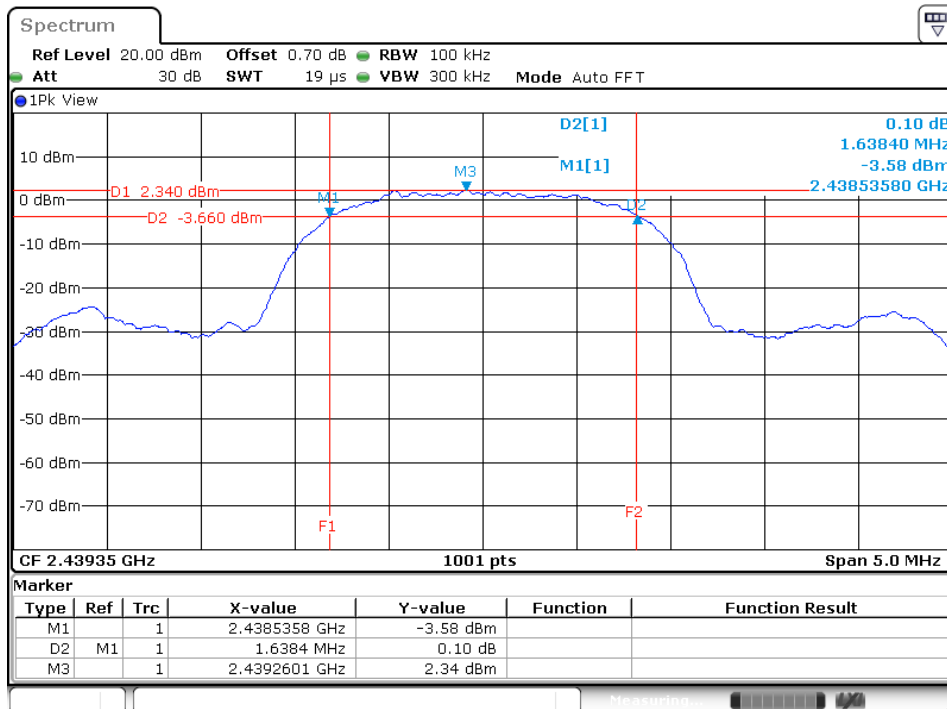

Date: 6.JUL.2020 15:28:51

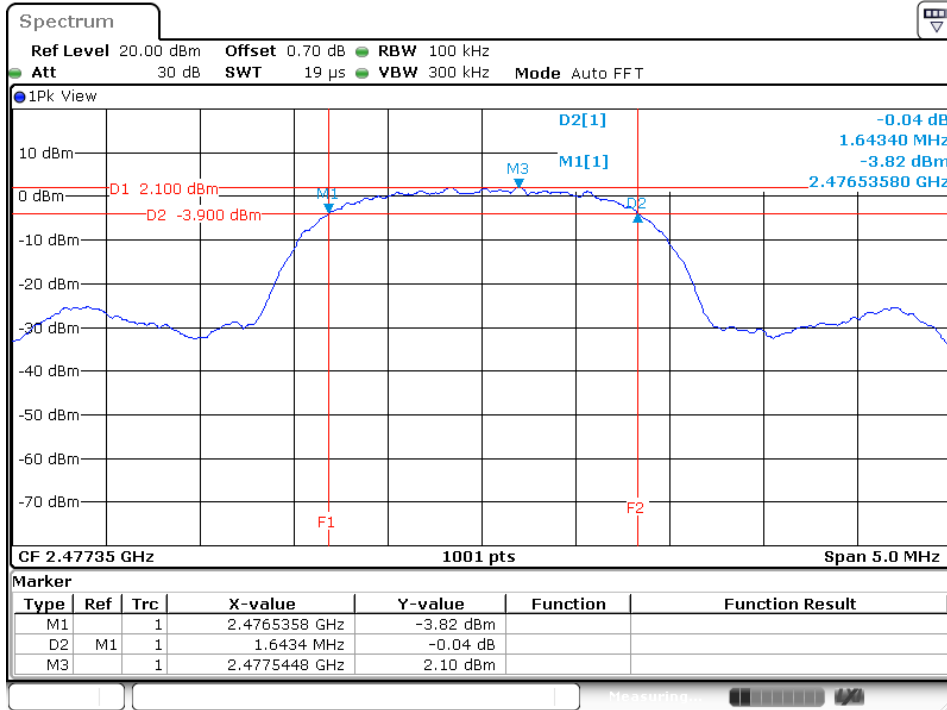
High Channel

Date: 6.JUL.2020 15:31:09

Test Plot of 99% Bandwidth

Low Channel

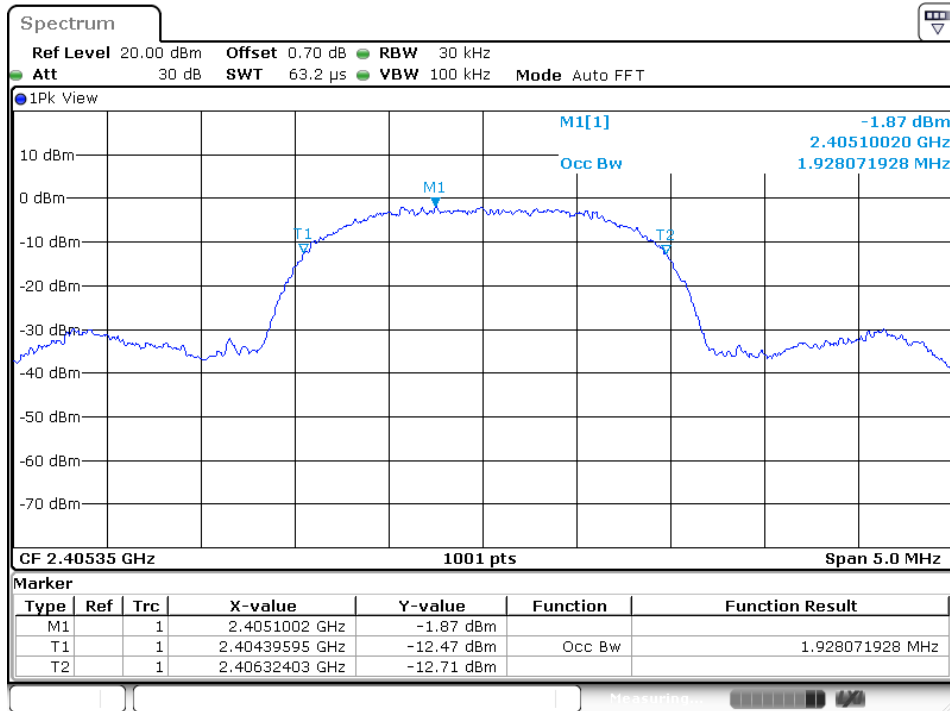

Date: 6.JUL.2020 15:33:17

Middle Channel

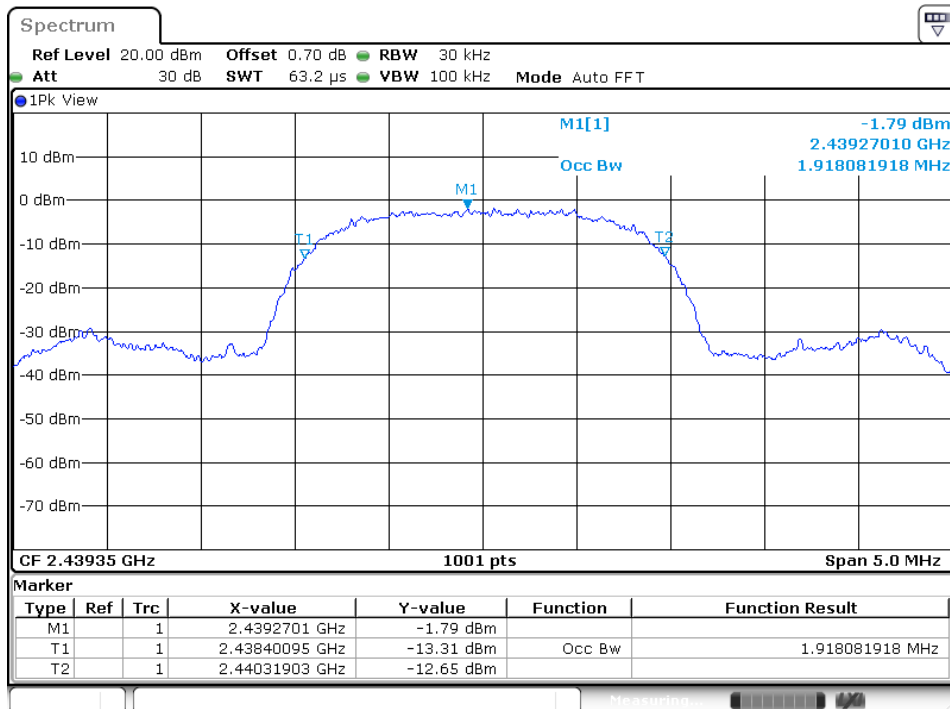

Date: 6.JUL.2020 15:34:30

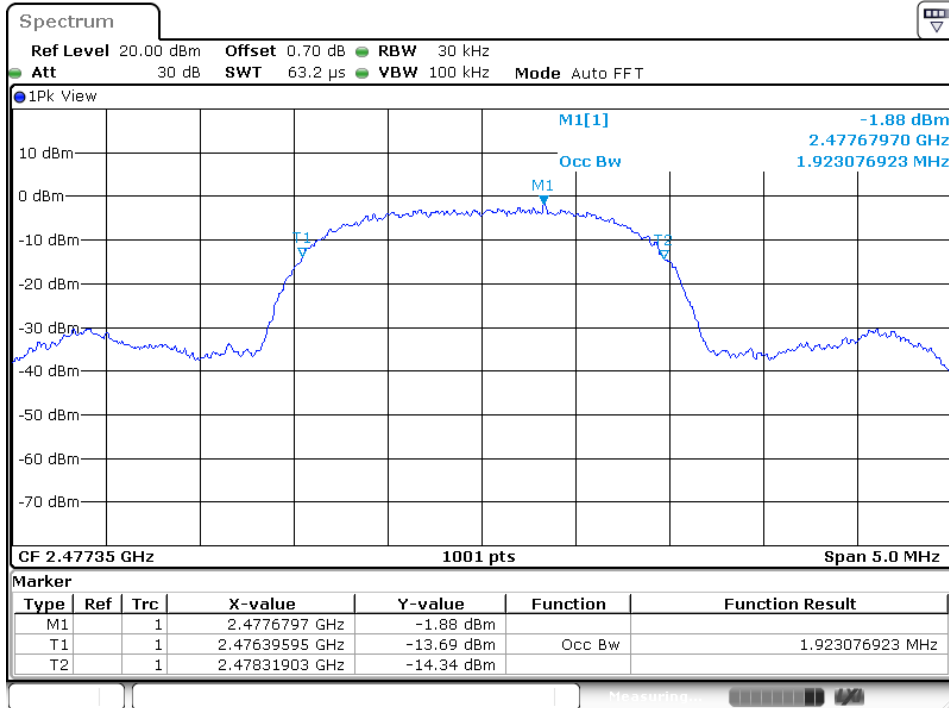
High Channel

Date: 6.JUL.2020 15:35:16

5.1.4 Power Density

RESULT:**Passed**

Test standard : FCC Part 15.247(e) , ISED RSS-247 5.2(b)
Basic standard : ANSI C63.10:2013, KDB558074
Kind of test site : Shielded room

Test setup

Test Channel : Low/ Middle/ High
Operation Mode : A
Ambient temperature : 20-24°C
Relative humidity : 50-65%
Atmospheric pressure : 100-103 kPa

Table 9: Test result of Power Density

Channel	Channel Frequency (MHz)	Power Density	Limit
		(dBm)	(dBm)
Low Channel	2405.35	-11.01	8
Middle Channel	2439.35	-11.66	8
High Channel	2477.35	-11.81	8

Test Plot of Power Density

Low Channel

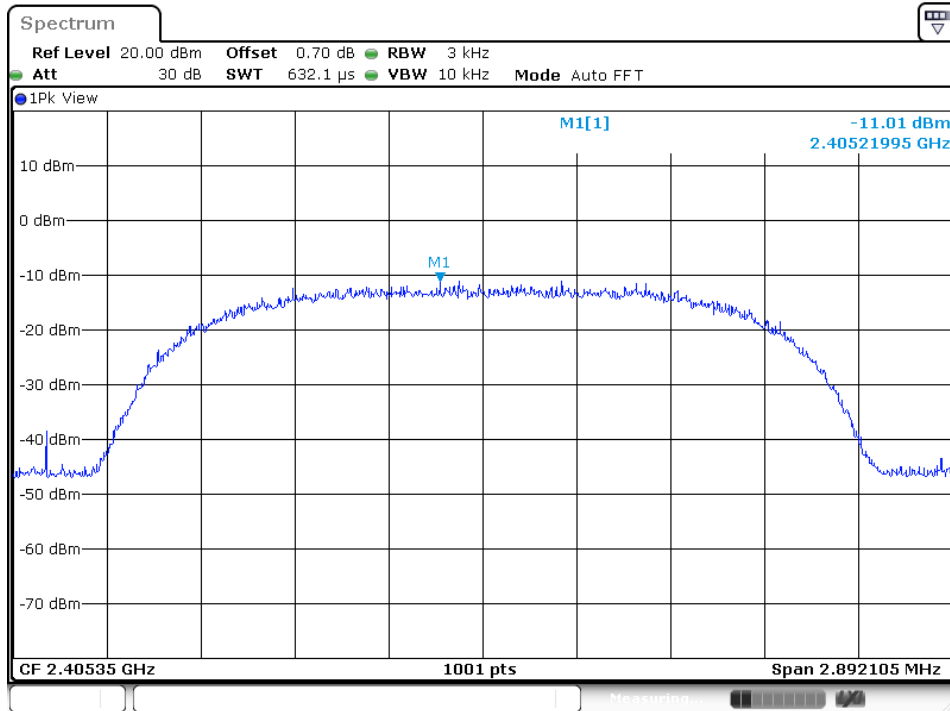

Middle Channel

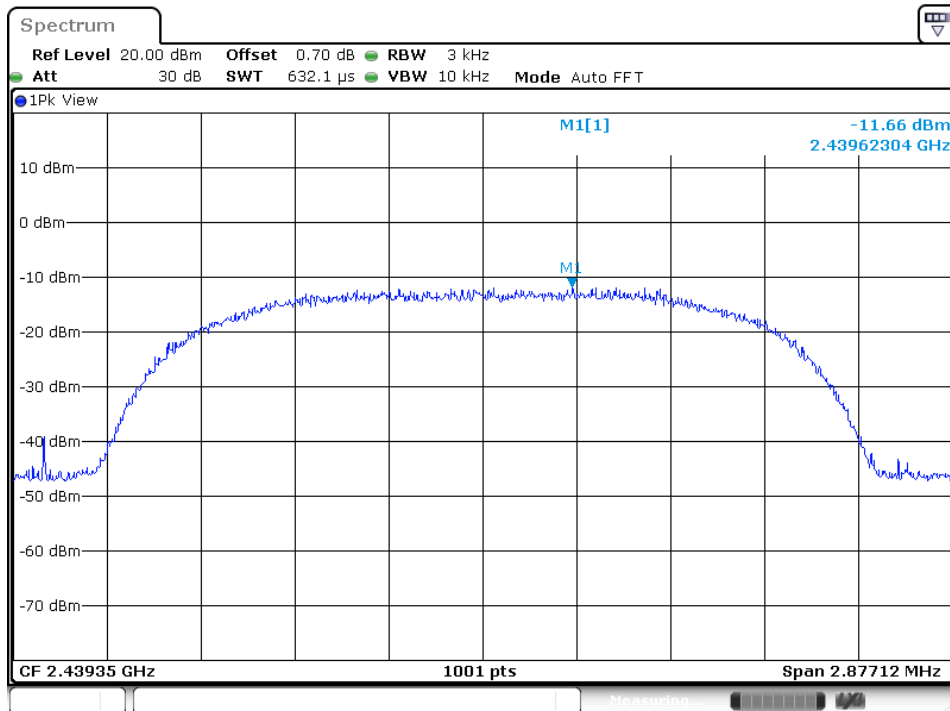

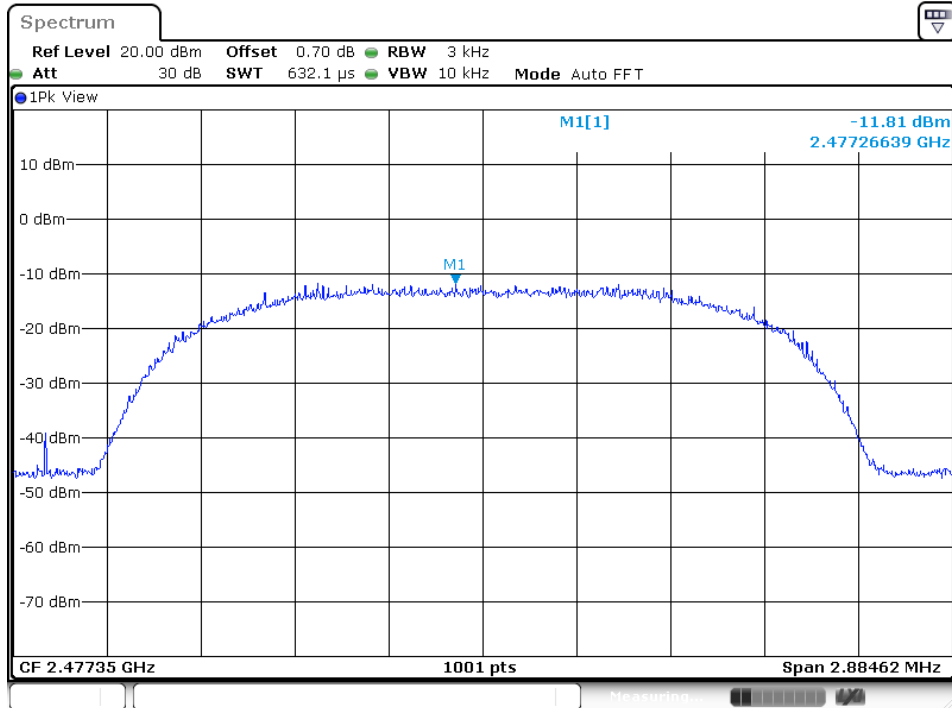
High Channel

Date: 6.JUL.2020 15:38:22

5.1.5 Conducted spurious emissions and Frequency Band Edge measured in 100kHz Bandwidth

RESULT:**Passed**

Test standard	:	FCC part 15.247(d), ISED RSS-247 5.5
Basic standard	:	ANSI C63.10:2013, KDB558074
Limit	:	20dB (below that in the 100kHz bandwidth within the band that contains the highest level of the desired power)
Kind of test site	:	Shielded room

Test setup

Test Channel	:	Low/ Middle/ High for Conducted Spurious Emissions Low/ High for Frequency Band Edge
Operation Mode	:	A
Ambient temperature	:	20-24°C
Relative humidity	:	50-65%
Atmospheric pressure	:	100-103 kPa

All emissions are more than 20dB below fundamental, details refer to following test plot, and compliance is achieved as well.

Due to the small size of the RF circuit and that there are no inductive components of significant size connected to the antenna port, 9kHz to 30MHz frequency range is not tested based on technical judgment.

Test Plot 100kHz Conducted Emissions

Low Channel

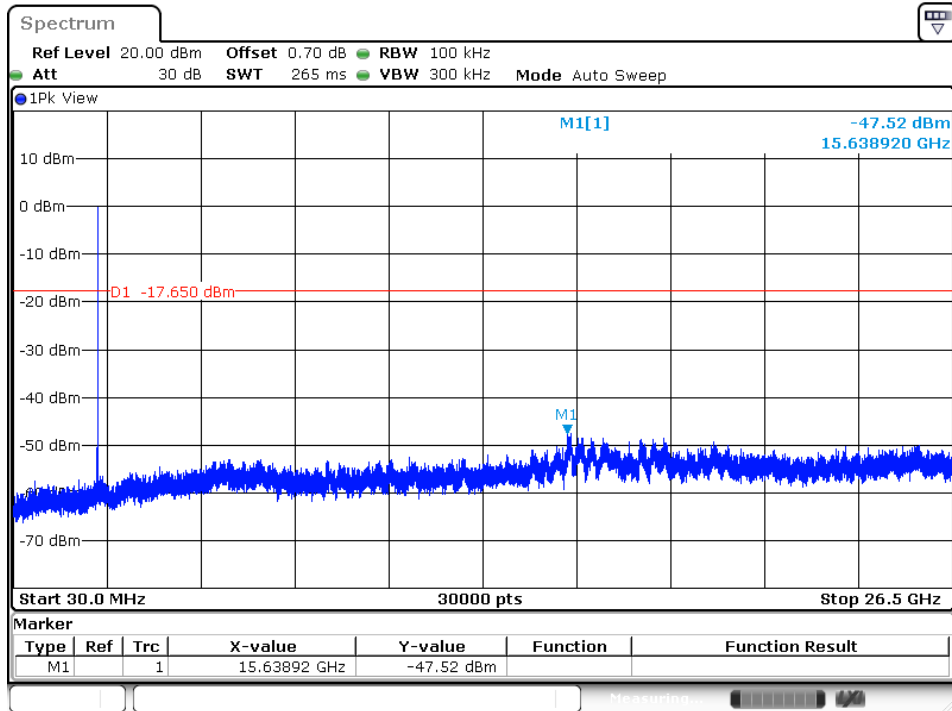

Date: 6.JUL.2020 15:41:22

Middle Channel

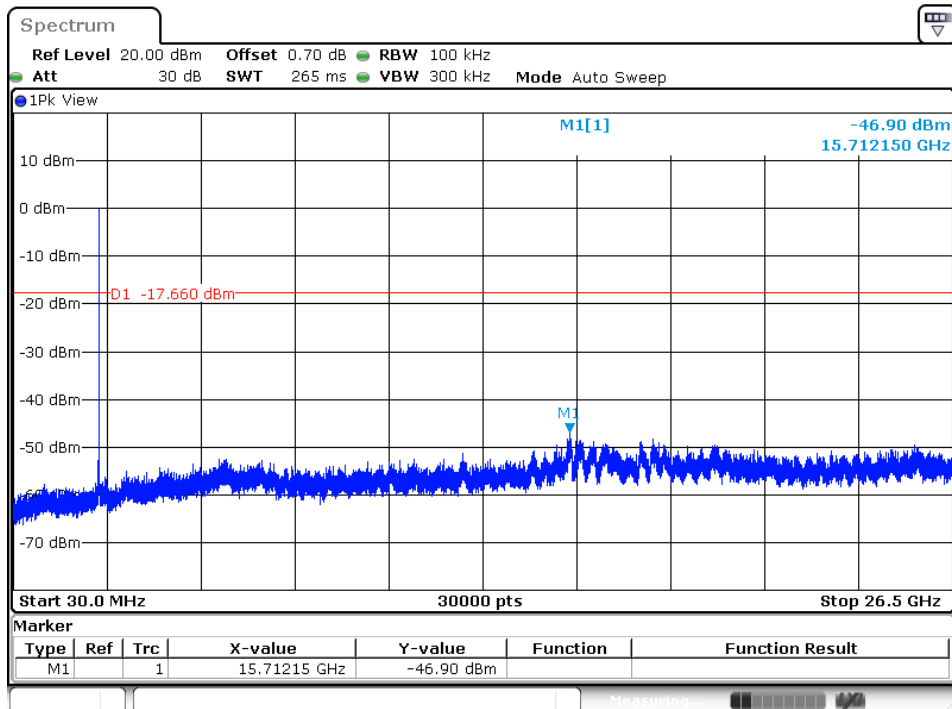

Date: 6.JUL.2020 15:41:53

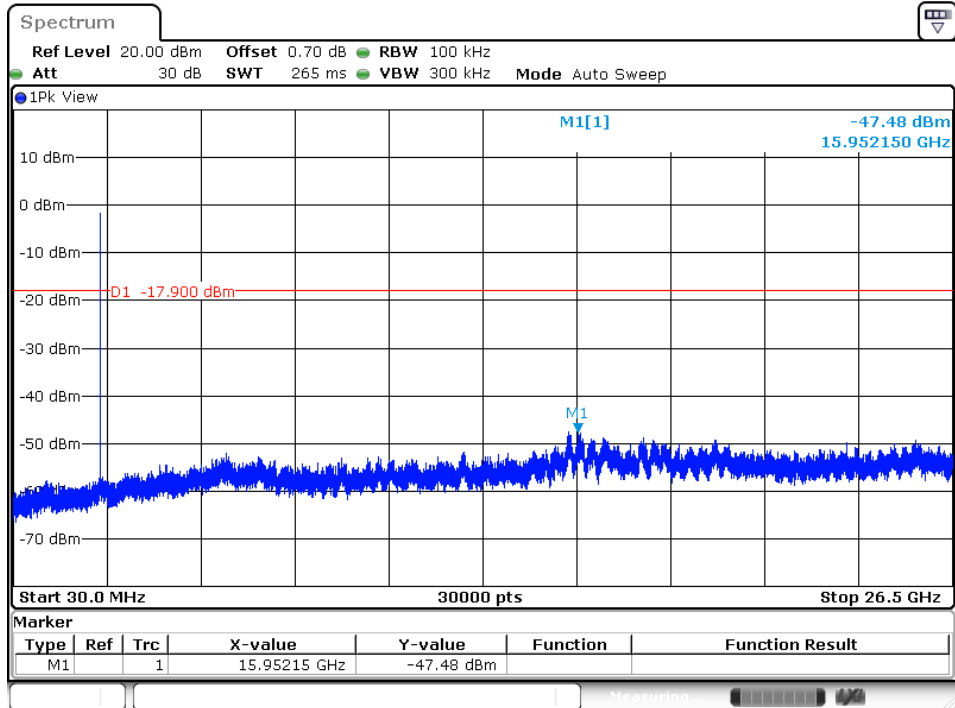
High Channel

Date: 6.JUL.2020 15:42:43

Test Plot 100kHz RBW of Band Edge

Low Channel

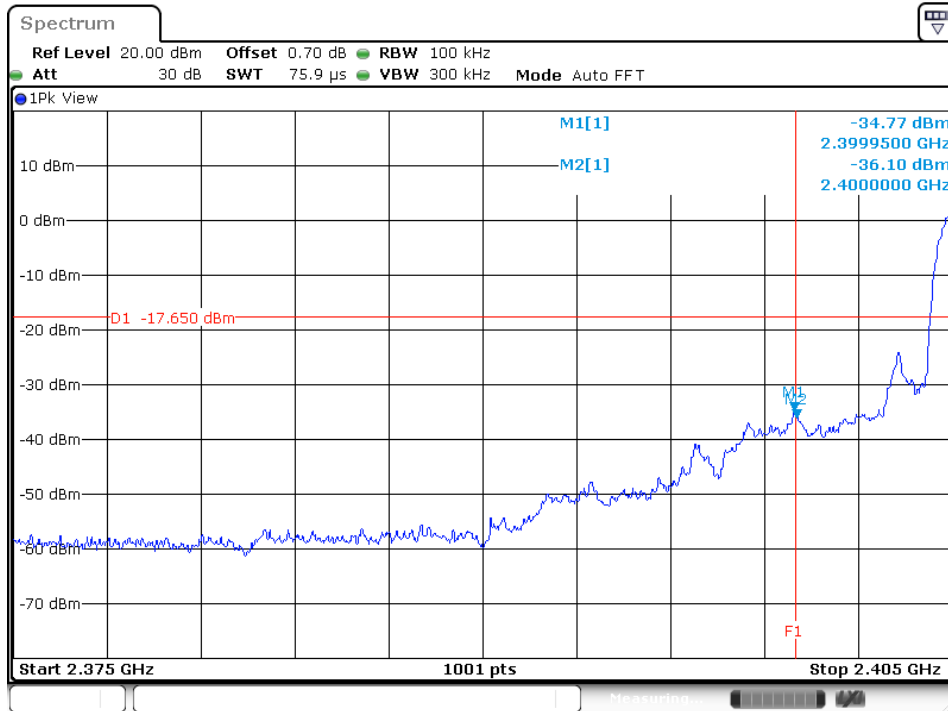

High Channel

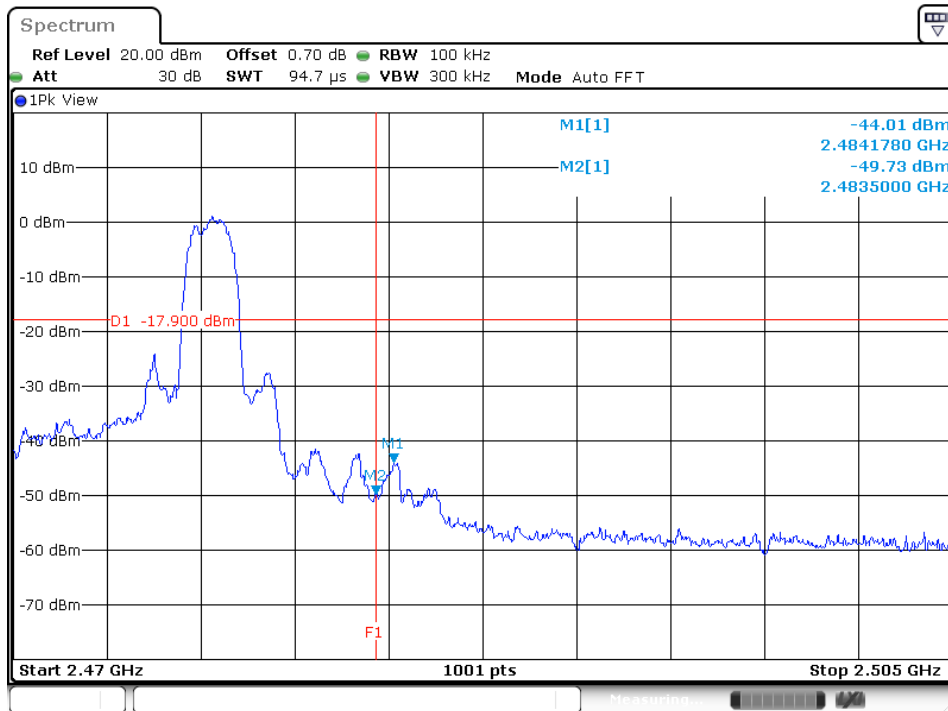

5.1.6 Spurious Emission

RESULT:**Passed**

Test standard : FCC part 15.247(d), FCC 15.205, FCC 15.209 and ISED
RSS-Gen 8.9 and ISED RSS-Gen 8.10

Basic standard : ANSI C63.10: 2013

Limits : Radiated emissions which fall in the restricted bands, as
defined in FCC 15.205(a) and ISED RSS-Gen i5, 8.10
(Table 7), must comply with the radiated emission limits
specified in FCC 15.209(a) and ISED RSS-Gen 5, 8.9
(Table 5 and 6).

Emission radiated outside the restricted and authorized
frequency bands must either comply with the radiated
emission limits specified for the restricted bands or in
FCC15.247(d) and ISED RSS-247 i2, 5.5

Kind of test site : 3m Semi-Anechoic Chamber

Test setup

Test Channel : Low/ Middle/ High

Operation mode : A

Ambient temperature : 20-24 °C

Relative humidity : 50-65 %

Atmospheric pressure : 100-103 kPa

Factor (dB/m)=Antenna Factor(dB/m)+Cable loss (dB)

Level(dBuV/m)=Reading(dBuV)+ Factor(dB/m)

For details refer to Appendix D.

5.2 Mains Emissions

5.2.1 Mains Conducted Emissions

RESULT:**Passed**

Test standard	:	FCC Part 15.207 FCC Part 15.107 ISED RSS-Gen 8.8
Limits	:	Mains Conducted emissions as defined in above test standards must comply with the mains conducted emission limits specified
Kind of test site	:	Shielded Room

Test setup

Test Channel	:	High
Operation mode	:	Normal link
Ambient temperature	:	20-24 °C
Relative humidity	:	50-65 %
Atmospheric pressure	:	100-103 kPa

Remark: For details refer to Appendix D.

6. Safety Human exposure

6.1 Radio Frequency Exposure Compliance

6.1.1 Electromagnetic Fields

RESULT:
Passed

Test standard : FCC KDB Publication 447498 D01
 ISED RSS-102 issue 5, Table 1

FCC:

Therefore maximum average output power of the transmitter is 3.13 mW < 10mW, hence the EUT is excluded from SAR evaluation according to FCC KDB publication 447498: Mobile Portable RF Exposure.

Canada:
ANT0

Frequency	Average power	Average power	Antenna gain	Numeric antenna gain	EIRP
(MHz)	(dBm)	(mW)	(dBi)	(dBi)	(mW)
2405.35	4.95	3.13	0.87	1.22	3.82
2439.35	4.44	2.78	1.16	1.31	3.63
2477.35	4.01	2.52	1.21	1.32	3.33

Since maximum EIRP of the transmitter is 3.82 mW < 4mW at 5mm, hence the EUT is excluded from SAR evaluation according to Table 1 in ISED RSS-102.

ANT1

Frequency	Average power	Average power	Antenna gain	Numeric antenna gain	EIRP
(MHz)	(dBm)	(mW)	(dBi)	(dBi)	(mW)
2405.35	3.7	2.34	0.87	1.22	2.86
2439.35	3.24	2.11	1.16	1.31	2.75
2477.35	2.3	1.70	1.21	1.32	2.24

Since maximum EIRP of the transmitter is 2.86 mW < 4mW at 5mm, hence the EUT is excluded from SAR evaluation according to Table 1 in ISED RSS-102.

7. List of Tables

Table 1: Applied Standard and Test Levels	5
Table 2: List of Test and Measurement Equipment	7
Table 3: Emission Measurement Uncertainty.....	8
Table 4: Basic Information of EUT	9
Table 5: Technical Specification of EUT	9
Table 6: Test result of Peak Output Power	16
Table 7: Test result of 6dB Bandwidth	17
Table 8: Test result of 99% Bandwidth.....	17
Table 9: Test result of Power Density	22