

5000 Series

User Manual

UHF Wireless Systems

ATW-R5220

Dual Receiver

ATW-R5220DAN

Dual Receiver with Dante Output

ATW-T5201

Body-Pack Transmitter

ATW-T5202

Handheld Transmitter (without capsule)

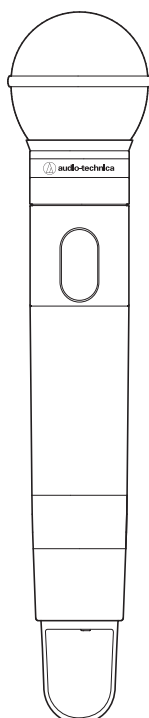
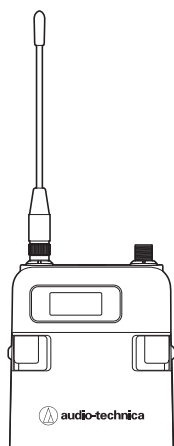
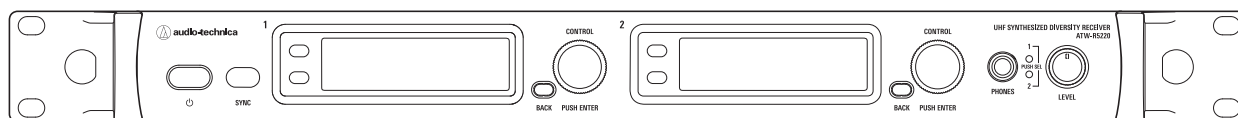

Contents

Introduction	2	Making connections (basic connections)	27
Important information	2	Using IR SYNC	28
Notes on use	4	Achieving stable reception	28
Maintenance	4	Rack-mounting the receiver	28
Part names and functions	5	Troubleshooting	29
ATW-R5220/ATW-R5220DAN	5	ATW-R5220/ATW-R5220DAN	29
ATW-T5201	7	ATW-T5201/ATW-T5202	29
ATW-T5202	8	Dimensions	30
How to insert batteries	9	ATW-R5220/ATW-R5220DAN	30
ATW-T5201	9	ATW-T5201	31
ATW-T5202	9	ATW-T5202	31
How to attach and detach the interchangeable microphone capsule (only for ATW-T5202)	10	Specifications	32
How to attach	10	Overall system specifications	32
How to remove	10	ATW-R5220/ATW-R5220DAN	32
How to read the display	11	ATW-T5201	32
ATW-R5220/ATW-R5220DAN	11	ATW-T5202	33
ATW-T5201/ATW-T5202	13		
How to operate	14		
Basic operation	14		
Using SYNC shortcut	14		
Settings	15		
ATW-R5220/ATW-R5220DAN	15		
ATW-T5201/ATW-T5202	15		
Setting ATW-R5220/ATW-R5220DAN	16		
List of setting items	16		
Setting the operating frequency	16		
Setting the channel (receiver) name	16		
Setting the audio output level	17		
Scanning for open channels	17		
Setting transmitters via IR SYNC	17		
Setting the squelch level	18		
Setting the system-related functions	18		
Setting network	21		
Using test mode	22		
Setting DANTE	22		
Setting ATW-T5201/ATW-T5202	23		
List of setting items	23		
Setting the transmission frequency	23		
Setting the channel (transmitter) name	23		
Setting the gain	24		
Setting the microphone input gain	24		
Setting the RF transmission output	24		
Setting HPF (High-Pass Filter)	24		
Setting lock	24		
Setting the function	25		
Setting the system-related functions	25		
How to attach the transmitter (ATW-T5201)	27		

Introduction

Thank you for purchasing this Audio-Technica product.

Before using the product, read through this user manual to ensure that you will use the product correctly. Please keep this manual for future reference.

Important information

Warning:

- To prevent fire or shock hazard, do not expose this apparatus to rain or moisture.



Caution:

- Do not expose this apparatus to drips or splashes.
- To avoid electric shock, do not open the cabinet.
- Refer servicing to qualified personnel only.
- Do not expose this apparatus to excessive heat such as that generated by sunshine, fire or other heat sources.
- Do not subject this apparatus to strong impact.
- This apparatus should be located close enough to the AC outlet so that you can easily grasp the power cord plug at any time.
- In case of emergency, disconnect the power cord plug of this apparatus quickly.
- Do not place any objects filled with liquids, such as vases, on this apparatus.
- To prevent fire, do not place any naked flame sources (such as lighted candles) on this apparatus.
- Do not install this apparatus in a confined space such as a bookcase or similar unit.
- Install this apparatus only in the places with good ventilation.
- To prevent fire, do not cover the ventilation of this apparatus with newspapers, table-clothes, curtains, etc.
- This apparatus with Class I construction shall be connected to the AC outlet with a protective grounding connection.
- This apparatus is not disconnected from the mains as long as it is connected to the AC outlet, even if the unit itself has been turned off.
- In order to maintain proper ventilation, do not place any objects around the rear of this apparatus.
- This apparatus should be placed at least 15 cm away from a rear wall. This apparatus should not be placed near to other electrical apparatuses. Keep the top and sides of this apparatus at least 10 mm away from any other surface if sitting on shelving, such as an audio apparatus rack. Failure to do so may cause this apparatus to overheat which in turn may cause it or surrounding items to catch fire.

Battery caution:

- Keep batteries out of the reach of children.
- Observe correct polarity as marked.
- Do not expose the battery to excessive heat such as sunshine, fire or the like.
- Always consider the environment issues and follow local regulations when disposing of batteries.
- Remove depleted battery immediately.
- Danger of explosion if battery is incorrectly replaced. Replace only with the same or equivalent type.
- Use only disposable LR06(AA) alkaline or Ni-MH batteries.
- Do not use new batteries and old one at the same time.
- Do not use different batteries type or model.
- Do not use a leaking battery. If battery leakage occurs, avoid contact with skin. If contact occurs, immediately wash thoroughly with soap and water.
- If battery leakage comes into contact with your eyes, immediately flush with water and seek medical attention.

For customers in the USA/Canada

	CAUTION RISK OF ELECTRIC SHOCK DO NOT OPEN	
Caution: To prevent electric shock, do not remove the cover. There are no user-serviceable parts inside. Internal adjustments are for qualified professionals only. Refer all servicing to qualified service personnel.		

	The lightning flash with arrowhead symbol, within an equilateral triangle, is intended to alert the user to the presence of uninsulated "dangerous voltage" within the product's enclosure that may be of sufficient magnitude to constitute a risk of shock to persons.
--	--

	The exclamation point symbol within an equilateral triangle is intended to alert the user to the presence of important operating and maintenance (servicing) instructions in the literature accompanying the product.
--	---

Important information

Important Safety Instructions

1. Read these instructions.
2. Keep these instructions.
3. Heed all warnings.
4. Follow all instructions.
5. Do not use this apparatus near water.
6. Clean only with dry cloth.
7. Do not block any of ventilation openings. Install in accordance with the manufacturer's instructions.
8. Do not install near any heat sources such as radiators, heat registers, stoves, or other apparatus (including amplifiers) that produce heat.
9. Do not defeat the safety purpose of the polarized or grounding plug. A polarized plug has two blades with one wider than the other. A grounding plug has two blades and a third grounding prong. The wide blade or the third prong is provided for your safety. If the provided plug does not fit into your outlet, consult an electrician for replacement of the obsolete outlet.
10. Protect the power cord from being walked on or pinched particularly at plugs, convenience receptacles, and the point where they exit from the apparatus.
11. Only use attachments/accessories specified by the manufacturer.
12. Use only with a cart, stand, tripod, bracket or table specified by the manufacturer, or sold with the apparatus. When a cart is used, use caution when moving the cart/apparatus combination to avoid injury from tip-over.
13. Unplug this apparatus during lightning storms or when unused for long periods of time.
14. Refer all servicing to qualified service personnel. Servicing is required when the apparatus has been damaged in any way, such as power-supply cord or plug is damaged, liquid has been spilled or objects have fallen into the apparatus, the apparatus has been exposed to rain or moisture, does not operate normally, or has been dropped.



FCC Notice

Warning:

This device complies with Part 15 of the FCC Rules. Operation is subject to the following two conditions: (1) This device may not cause harmful interference, and (2) this device must accept any interference received, including interference that may cause undesired operation.

Caution:

You are cautioned that any changes or modifications not expressly approved in this manual could void your authority to operate this equipment. Wireless microphone users shall rely on the white space databases in part 15, Subpart H to determine that their intended operating frequencies are available for unlicensed wireless microphone operation at the location where they will be used. Wireless microphone users must register with and check a white space database to determine available channels prior to beginning operation at a given location. A user must re-check the database for available channels if it moves to another location.

Note: This equipment has been tested and found to comply with the limits for a Class B digital device, pursuant to part 15 of the FCC Rules. These limits are designed to provide reasonable protection against harmful interference in a residential installation. This equipment generates, uses and can radiate radio frequency energy and, if not installed and used in accordance with the instructions, may cause harmful interference to radio communications. However, there is no guarantee that interference will not occur in a particular installation. If this equipment does cause harmful interference to radio or television reception, which can be determined by turning the equipment off and on, the user is encouraged to try to correct the interference by one or more of the following measures:

- Reorient or relocate the receiving antenna.
- Increase the separation between the equipment and receiver.
- Connect the equipment into an outlet on a circuit different from that to which the receiver is connected.
- Consult the dealer or an experienced radio/TV technician for help.

For customers in Canada

IC statement

CAN RSS-Gen/CNR-Gen

This device complies with INDUSTRY CANADA R.S.S. 210. Operation is subject to the following conditions: (1) This device may not cause harmful interference and (2) this device must accept any interference received, including interference which may cause undesired operation.

This device complies with RSS-102 radiation exposure limits set forth for an uncontrolled environment.

Notes on use

- Be sure to read the user manual for any microphone or cable that you attach to the product.
- Disconnect the power cable from the outlet when this product is not in use.
- Turn off the power of this product before connecting or disconnecting cables.
- If you use the product near a TV or radio antenna, you may hear unwanted noise in the television or radio. If this occurs, move the product away from the device.
- Two waves of the same frequency can't be used simultaneously.
- Be careful of interference noise caused by the surrounding radio wave environment and use of multiple systems.
- Wireless systems may be affected by the spark noise of vehicles, dimmer of lighting apparatus, computers, office automation apparatus and electronic musical instruments. Place and use the product where it is less likely to be affected by the above.
- Be sure to use this product in combination with components specified by our company.
- Be sure the connected cable is plugged all the way into the product.
- When you connect the product with a mixer, turn off the phantom power source.
- If you use the product close to an electronic or communications device (such as a mobile phone), the product may produce unwanted noise. If this occurs, move the product away from the device.
- When setting up the product, make sure there are no obstacles between the transmitter and the receiver that might block the signal.
- To prevent the batteries from wearing out, turn the transmitter off when not in use.
- Over time, discoloration may occur due to ultraviolet rays (especially direct sunlight) and friction.
- It is legally prohibited to dismantle and modify this product. In addition, this product is so precisely manufactured that dismantling it could cause electric shock, failure or fire. Never dismantle this product.

Using multiple wireless systems

- If you use more than one device at the same time, use them in the same group.
- When using multiple units simultaneously, maintain 1 meter or more between individual transmitters and 3 meters or more between transmitters and receivers' antennas.
- When using multiple units, power on transmitters one by one, making sure there is no unwanted noise.
- When a howling (beeping or squealing) sound is produced during use, turn down the output volume of the connected mixer/amplifier.

Maintenance



- If the product becomes stained or covered with dust, be sure to disconnect the power cable before wiping it off with a dry and soft cloth.
- Do not use benzine, thinner or electrical contact cleaner, etc. They may deform or otherwise damage the product, or cause operational failure.

Part names and functions

ATW-R5220/ATW-R5220DAN

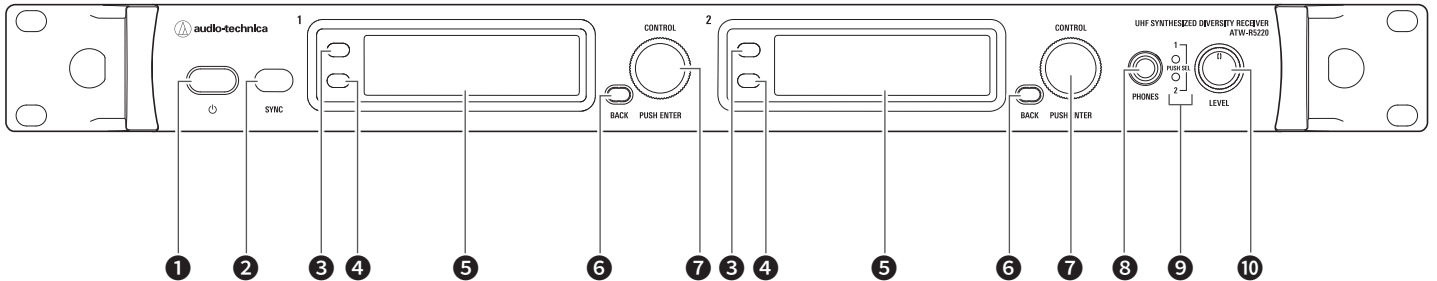
Front panel



- 1** Power button ()
Use to turn the receiver on or standby.
( : Symbol indicates standby.)
- 2** IR sync window
Use to IR SYNC with the transmitter (ATW-T5201, ATW-T5202).
- 3** Function button 1
Press to switch the main display and the level meter display.
- 4** Function button 2
Press to switch the main display..
- 5** Display
Displays the receiver state and setting menus.
- 6** BACK button
Press to take the display back one screen.
Returns to the Main screen when pressed and held.
- 7** Control dial
Displays the setting menu when you press the dial. Turn the dial to select a setting and press to confirm.
When you press and hold the dial, "TX SYNC" setting screen is displayed.
- 8** Headphone monitor(6.3 mm) output jack
This is the headphone output jack used for monitoring. It allows you to monitor receivers 1 and 2.
- 9** Headphone channel indicator
Displays which receiver is being monitored, receiver 1 or 2.
- 10** Headphone volume/Channel switch
Use when adjusting the volume of the headphones for monitoring.
Press and release the dial to switch between receivers 1 and 2.
 - Does not affect receiver audio output level.

Part names and functions

Rear panel

The figure below is ATW-R5220.

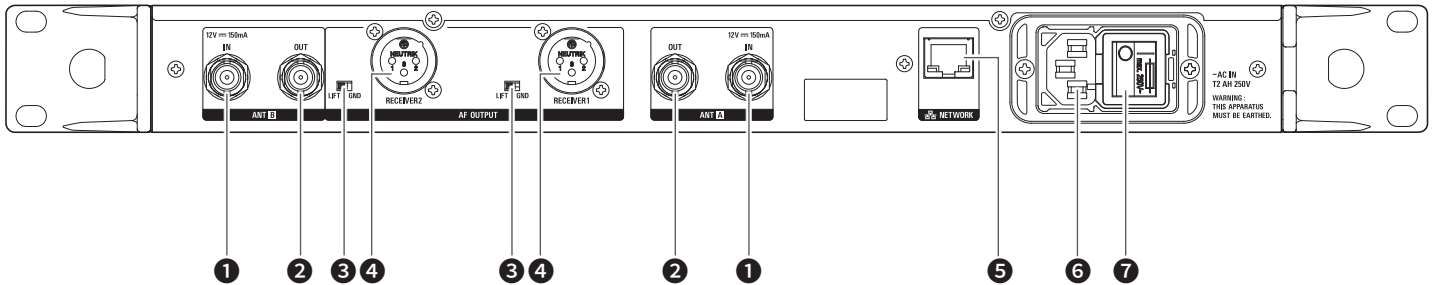

- 1** Antenna input jack
 (— — — : Symbol indicates direct current.)
 Each jack supplies DC12 V to a connected antenna.
 Additionally other compatible accessories (sold separately) can be connected.
- 2** Antenna output jack
 Distributes and outputs signals input to antennas A and B.
 By using this jack, it is possible to connect up to seven receivers (8 total).
- 3** Ground lift switch
 This switch isolates the GND pin of the balanced/unbalanced output from the ground.
 Normally this is kept in the GND position, but if a hum develops due to a ground loop, switch to the LIFT side.
- 4** Balanced output jack (XLR 3-pin male)



- 5** Network interface
 By connecting to a PC via Ethernet, you can use the PC for monitoring or control.
 In the case of ATW-R5220DAN, it will be the DANTE output port.
- 6** AC inlet
 Connect the power cable.
 (~: Symbol indicates the current.)
- 7** Main power switch
 Press the main power switch to turn the power on.
 Turn the main power switch on before turning the front panel power switch on.

Part names and functions

ATW-T5201

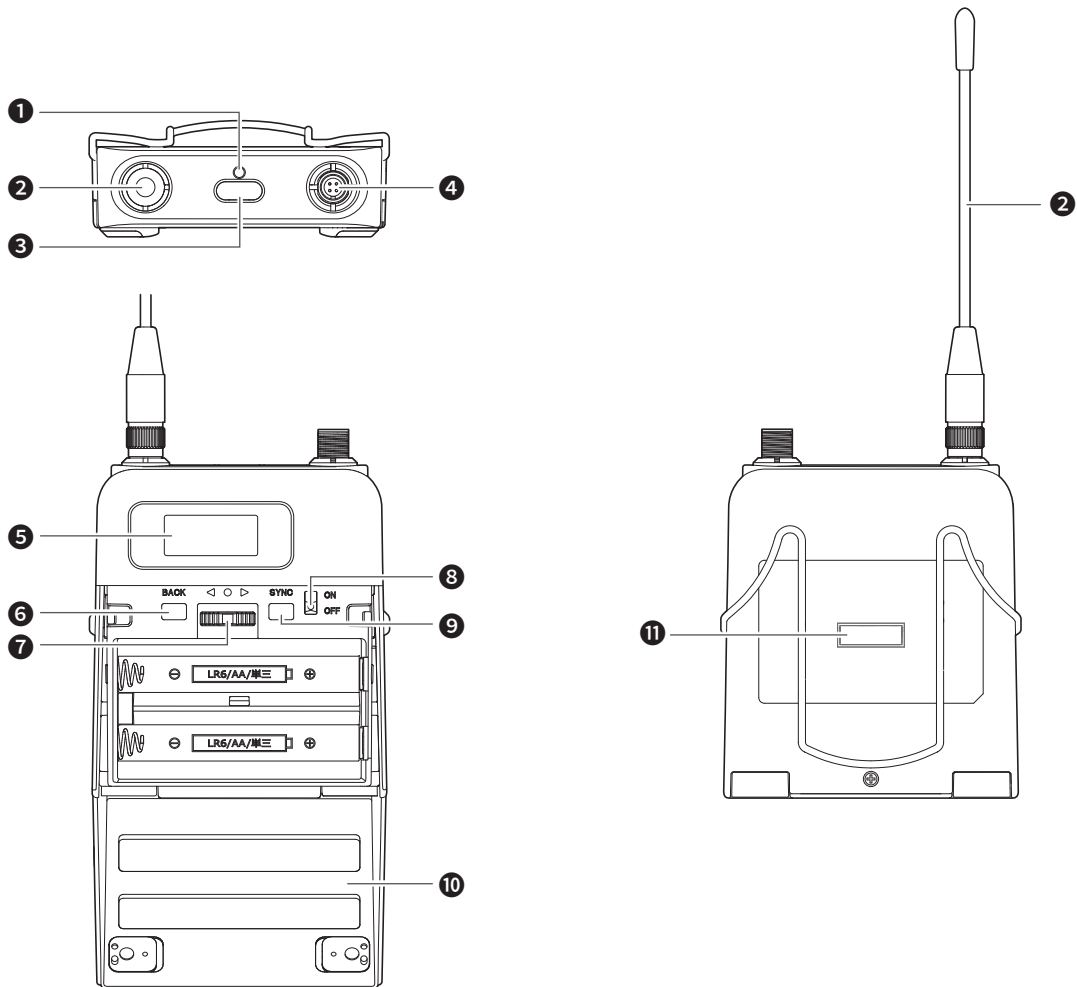

1 Indicator

LED that shows the status of the transmitter.
 When the power is turned ON: Solid green
 When the transmitter is muted: Solid red

2 Transmission antenna

3 Function button

Press briefly to turn the screen back on if it shuts off. Press and hold to perform preselected function.

4 Input connector

Connect a microphone, a headworn microphone, a guitar cable, etc.

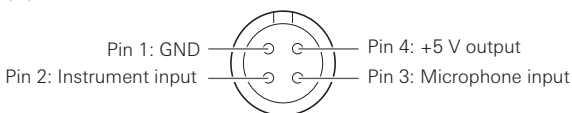

5 Display

Shows the current status.
 If no buttons are pressed for a period of 30 seconds, the display will turn off.

6 BACK button

Press to take the display back one screen.
 Returns to the Main screen when pressed and held.

7 Lever push switch

Use to select various settings.
 UP (▶)
 Turn to the right to change a selection.
 DOWN (●)
 Turn to the left to change a selection.
 SET (◀)
 Press to confirm a selection.

8 Power switch

Use to turn the power on or off.

9 SYNC button

Use to IR SYNC with the receiver (ATW-R5220/ATW-R5220DAN).

10 Battery cover

11 IR sync window

Use to IR SYNC with the receiver.

Part names and functions

ATW-T5202

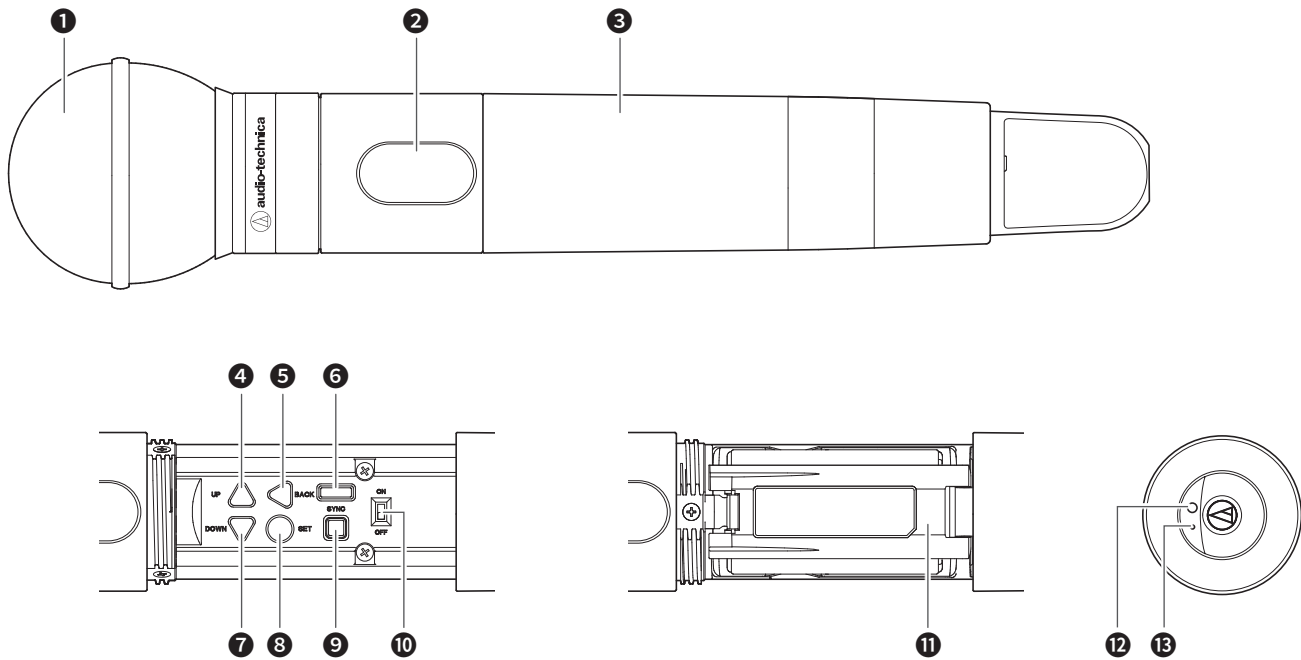

- 1** Interchangeable microphone capsule
- 2** Display
Shows the current status.
If no buttons are pressed for a period of 30 seconds, the display will turn off.
- 3** Grip case
- 4** UP button
Used for selecting various settings.
- 5** BACK button
Press to take the display back one screen.
Returns to the Main screen when pressed and held.
- 6** IR sync window
Use to IR SYNC with the receiver.
- 7** DOWN button
Used for selecting various settings.
- 8** SET button
Press to confirm a selection.
- 9** SYNC button
Use to IR SYNC with the receiver (ATW-R5220/ATW-R5220DAN).
- 10** Power switch
Use to turn the power on or off.
- 11** Battery cover
- 12** Function button
Press briefly to turn the screen back on if it shuts off. Press and hold to perform preselected function.
- 13** Indicator
LED that shows the status of the transmitter.
When the power is turned ON: Solid green
When the transmitter is muted: Solid red

How to insert batteries

ATW-T5201

1. Slide the battery cover latches inward as shown by the arrows.

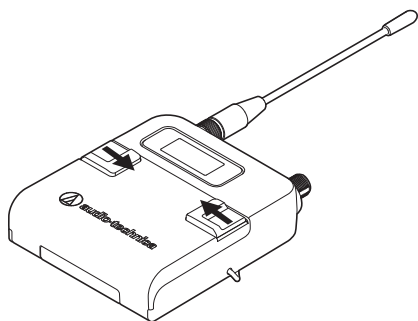

2. With the latches pressed in, slide the cover down as shown by the arrow.

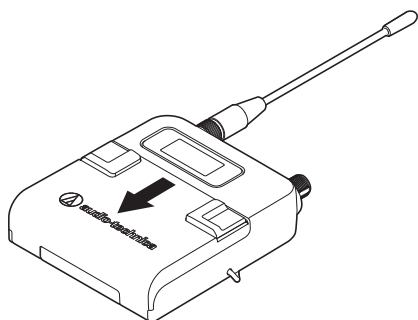

3. Open the battery cover.

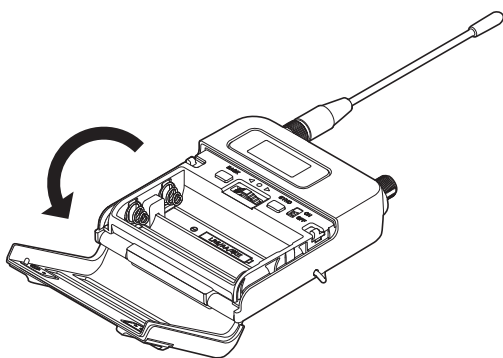

4. Insert the batteries according to the plus (+) and minus (-) marks found inside the battery compartment.

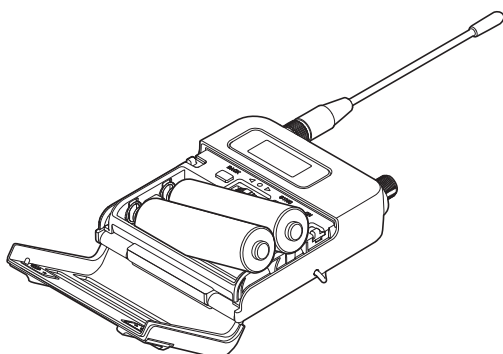

ATW-T5202

1. Rotate the grip case of the battery compartment.

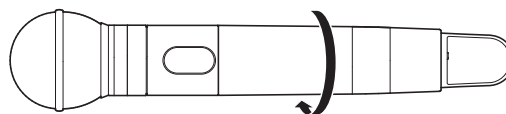

2. Open the battery cover.

- Put your finger on the hook of the battery cover and pull it to open the battery cover.

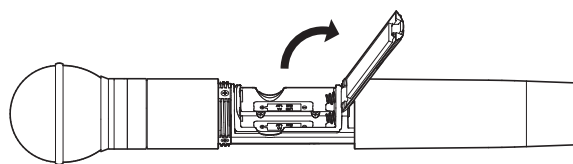

3. Insert the batteries according to the plus (+) and minus (-) marks found inside the battery compartment.

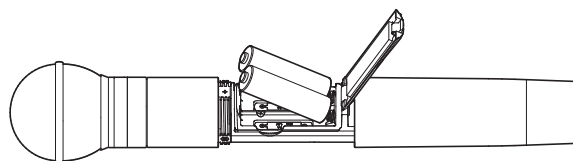

How to attach and detach the interchangeable microphone capsule (only for ATW-T5202)

How to attach

1. Attach the microphone capsule to the body of the transmitter.

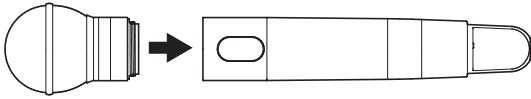

2. Rotate the microphone capsule clockwise to tighten it.

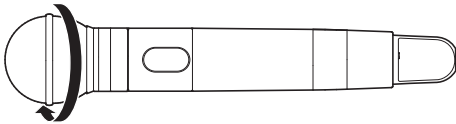

How to remove

1. Rotate the microphone capsule counterclockwise to loosen it.

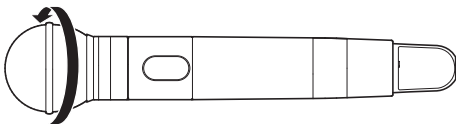

2. Detach the microphone capsule from the body of the transmitter.

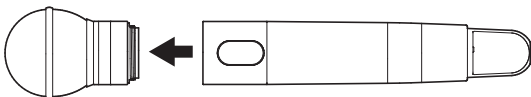

- Do not directly touch or scratch the connection surface.
- Be sure to turn off the power of the transmitter before attaching/detaching the microphone capsule.
- Do not forcibly attach the microphone capsule. Doing so may damage the transmitter or microphone capsule.

How to read the display

ATW-R5220/ATW-R5220DAN

Main screen

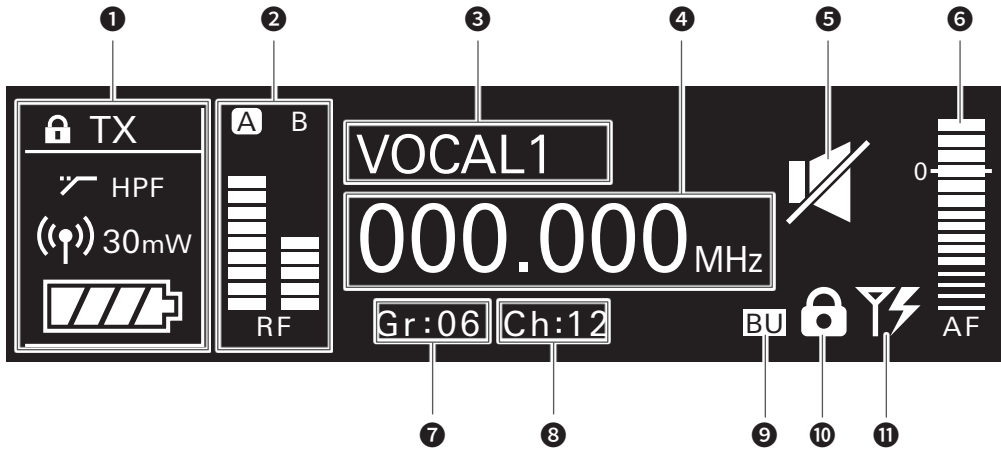

- 1** Transmitter information display area
Information on the connected transmitter is displayed. Refer to "Transmitter information display area" (p. 10) for screen display.
- 2** RF level indicator
Displays the strength of RF reception for antennas A & B.
- 3** Name display
Displays the specified name.
- 4** Frequency indicator
Displays the set frequency.
- 5** Receiver mute indicator
A speaker icon with a slash through it is displayed when the receiver is muted.
- 6** AF level indicator
Displays the strength of the received audio signal.
- 7** Group indicator
- 8** Channel indicator
- 9** Backup frequency indicator
"BU" icon is displayed when the backup frequency mode is ON.
- 10** Lock status indicator
- 11** Antenna input power indicator
Icon is displayed when the antenna power supply is ON.

Transmitter information display area

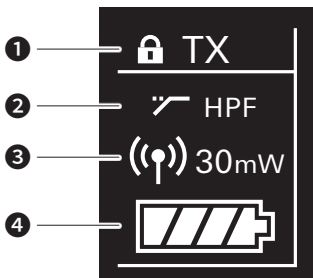

Normal

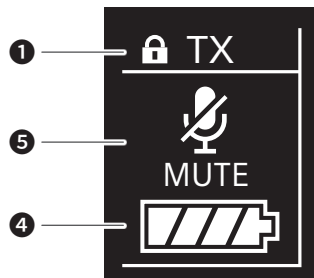

Muted

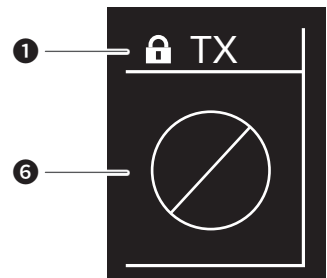

Non-communication

- 1** Lock status indicator
- 2** High-pass filter indicator
- 3** RF transmission output indicator
- 4** Battery level indicator
- 5** Transmitter mute indicator
A microphone with a slash through it is displayed when the transmitter is muted.
- 6** Transmitter non-communication indicator

How to read the display

Level meter screen

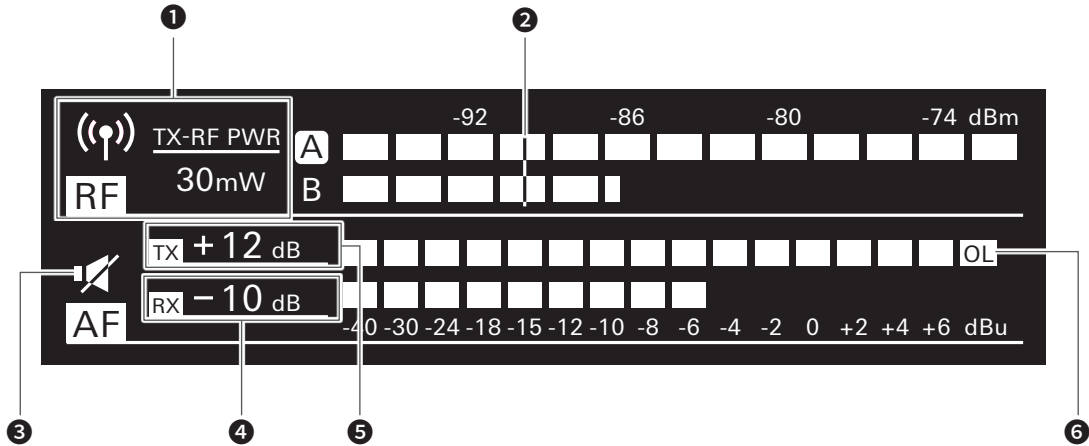

- 1** RF transmission output indicator (transmitter)
- 2** Marker (when the minimum hold function is on)
Shows the minimum level at which the RF is held.
- 3** Mute indicator
A speaker icon with a slash through it is displayed when transmitter is muted.
- 4** Audio output indicator (receiver)
- 5** Gain indicator (transmitter)
- 6** Overload (excessive input) indicator

Minimum hold function

If you press the BACK button on the level meter screen, the minimum hold function turns on and its marker is displayed.

- The marker indicates the lowest level of RF signal received from the transmitter.
- The marker does not move if the input RF level is higher than the marker position.
- If the RF level input is lower than the marker position, the marker moves in tandem with the RF level.
- To reset the marker position, press the BACK button again.

Switching between screens

The screen is switched every time the function button 1 is pressed.



Main screen

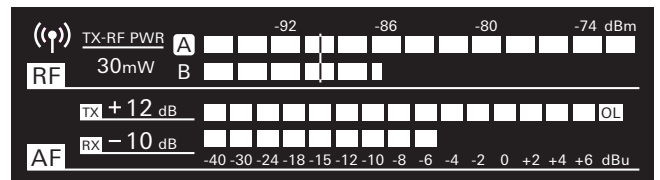

Level meter screen

How to read the display

ATW-T5201/ATW-T5202

The main screen is displayed when the power is switched on. If you press the UP/Down button on the main screen, the screen display is switched.

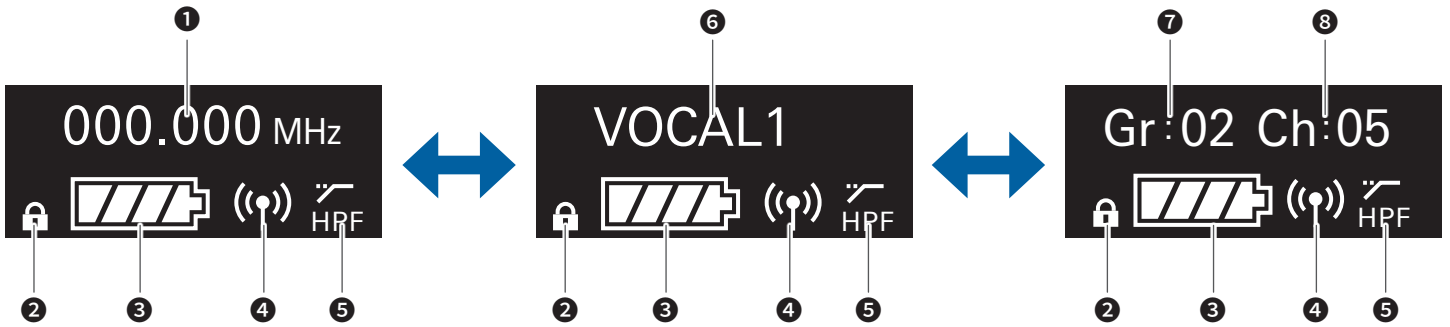

1 Frequency indicator
Displays the set frequency.

2 Lock status indicator

3 Battery level indicator

- : 75% or more battery power remaining.
- : 50 to 75% battery power remaining.
- : 25 to 50% battery power remaining.
- : 25% or less battery power remaining.
- (Flicker): Replace the batteries.

4 RF transmission output indicator

- : RF Power High (50mW)
- : RF Power Mid (10mW)
- : RF Power Low (2mW)
- : RF Power Off

5 High-pass filter indicator

6 Name display
Displays the specified name.

7 Group indicator

8 Channel indicator

How to operate

Basic operation

1. Turn on the main power button of the receiver (ATW-R5220/ATW-R5220DAN).

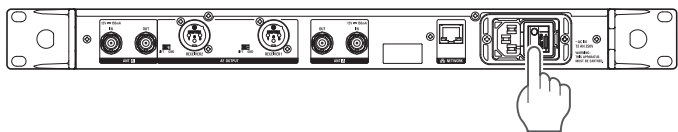

2. Turn on the power button of the receiver (ATW-R5330/ATW-R5220DAN).

- The display lights and the main screen is displayed.

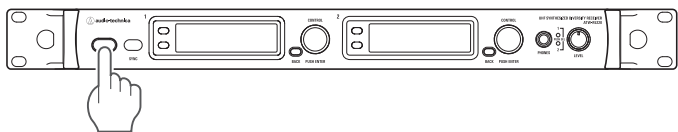

3. Set the operating frequency.

4. Turn on the power switch of the transmitter (ATW-T5201/ATW-T5202).

- The indicator lights and the display shows the main screen.

ATW-T5201

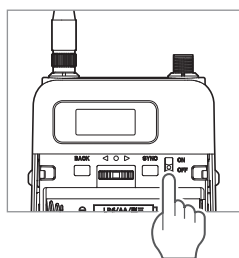

ATW-T5202

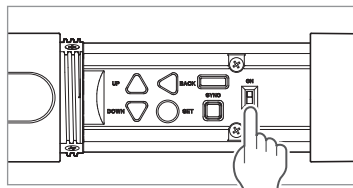

5. Set the transmission frequency.

6. Check the RF level indicator on the receiver.

- Check that antenna A or B lights up.

7. Speak into the microphone.

- Make sure the AF level indicator lights up on the receiver.

Using SYNC shortcut

You can easily move to the setting screen that you can set the settings of the receiver with SYNC shortcut.

1. Press and hold (for approximately 2 seconds) the control dial on the main screen.
2. "TX SYNC" setting screen is displayed.
 - Refer to "Using IR SYNC" (p.p. 17) for subsequent steps.

Settings

Various settings can be made from the menu screen shown on the display.

ATW-R5220/ATW-R5220DAN

1. Press the control dial.

- The main menu screen appears.

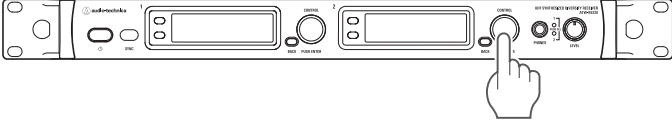

2. Turn the control dial to select the item you wish to set.



3. Press the control dial to open the settings menu of the selected item.

- Press the BACK button to go back one screen.
- To cancel partway through making a setting, press the BACK button.
- While on the settings screen, the display will return to the main screen if approximately 60 seconds pass without a button or the control dial being used.

ATW-T5201/ATW-T5202

The transmitter's (ATW-T5201/ATW-T5202) UP/DOWN button operation is explained below. In this user manual, the text is indicated as the button operation.

ATW-T5201: Slide to the UP/DOWN position.

ATW-T5202: Press the UP/DOWN button.

1. Press the SET button.

- The menu screen appears.

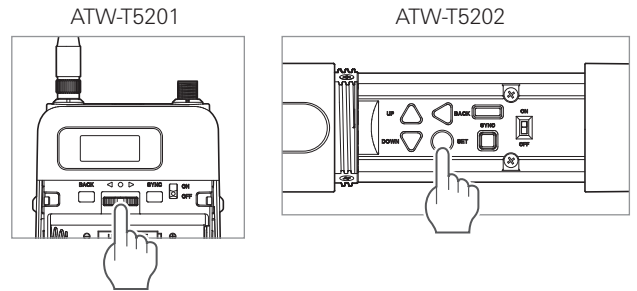

2. Press the UP/DOWN button to select the item you wish to set.

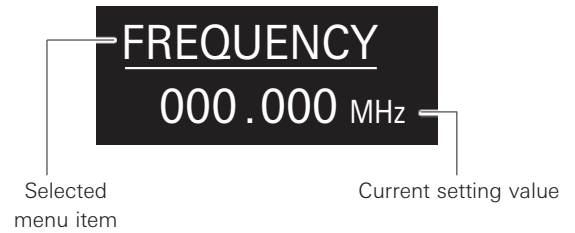

3. Press the SET button to display the settings screen for the selected item.

- Press the BACK button to go back one screen.
- To cancel partway through making a setting, press the BACK button.
- While on the settings screen, the display will return to the main screen if approximately 30 seconds pass without a button or the control dial being used.

Setting ATW-R5220/ATW-R5220DAN

List of setting items

FREQUENCY	MANUAL	Set the operating frequency.
	Gr/Ch	
NAME		Set the channel name.
AUDIO		Set the audio output level.
SCAN		Scan for open channels.
TX SYNC		Set transmitters via IR SYNC.
SQUELCH	AUTO	Set the squelch level.
	MANUAL	
UTILITIES	LOCK	Set this function to prevent the receiver settings from being changed.
	ANT PWR	Set whether to turn power on or off to the antenna input terminals.
	Gr/Ch	Edit the groups/channels 01 to 10.
	BACKUP FREQ	Set the backup frequency.
	AF METER	Switch the level meter on the main screen between receiver and transmitter.
	BRIGHTNESS	Set the display brightness.
	ACCESS	Set the user access level.
	RESET	This returns the receiver settings to their factory defaults.
	VERSION	This function displays product information such as the version of the receiver.
NETWORK	DEVICE ID	Set the receiver's ID No.
	IP SETTING	Set the IP.
	REMOTE CTRL	Set the remote control.
	SYSLOG	Set whether to send the log message to the Syslog server.
	DISCOVERY	Set automatic detection by the application.
	NTP	Set the NTP (Network Time Protocol).
	MAC ADDRESS	Display the MAC address.
TOOLS	WALK TEST	Record for 90 sec. the RF level being received.
	MONITOR MODE	This mode will enable monitoring with headphones only. (The audio OUT and DANTE OUT will be muted.)
DANTE*	INFO	Display the device name and channel label.
	IP SETTING	Set the DANTE's IP.
	MAC ADDRESS	Display the MAC address.
	VERSION	This function displays product information such as the version of the receiver.

* ATW-R5220DAN only

Setting the operating frequency

Manual setting

- From the menu screen, turn the control dial, select [FREQUENCY] and then press the control dial.
- Select [MANUAL] and press the control dial.
- Turn the control dial to set the first 3 digits. When finished setting them, press the control dial.
- Turn the control dial to set the last 3 digits. When finished setting them, press the control dial.
 - The setting is complete.

Setting by group/channel

- From the menu screen, turn the control dial, select [FREQUENCY] and then press the control dial.
- Select [Gr/Ch] and press the control dial.
- Turn the control dial to set the group. When finished setting it, press the control dial.
- Turn the control dial to set the channel. When finished setting it, press the control dial.
 - The setting is complete.

Setting the channel (receiver) name

The following characters can be entered:

- The maximum number of characters that can be entered is 8.

Alphabetic (uppercase letters)	Numeric
Symbols (+, -, #, &, period)	Space

- From the menu screen, turn the control dial, select [NAME] and then press the control dial.
- Turn the control dial, select the desired character and then press the control dial.
 - The character is input and the cursor moves.
- Repeat the operation in Step 2 to enter all characters.
- Turn the control dial, select [End] and then press the control dial.
 - The setting is complete.

Setting ATW-R5220/ATW-R5220DAN

Setting the audio output level

1. From the menu screen, turn the control dial, select [AUDIO] and then press the control dial.
2. Turn the control dial to set the audio output level.
 - The level changes 2dB +/- each time you turn the control dial.
 - It can be set from -60 to 0dB.
3. Press the control dial.
 - The setting is complete.

Scanning for open channels

Scan for unused channels in the current environment for use.

1. From the menu screen, turn the control dial, select [SCAN] and then press the control dial.
2. Turn the control dial to select the group you want to scan. After selecting a group, press the control dial.
 - Selecting "ALL" will scan all the groups.
3. Turn the control dial to select the preferred threshold. selecting the threshold, press the control dial.
 - You can select [Normal], [High] or [Low] sensitivity.

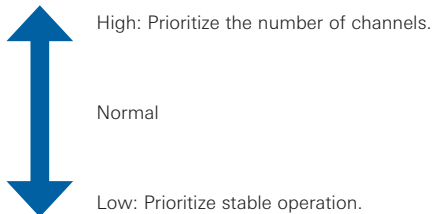

- Scan starts.

Selecting [ALL]:

4. Confirm the scan result, select the group and then press the control dial.
5. Select the channel selection method, and then press the control dial.
 - When selecting [Manual] and pressing the control dial, available channels and frequencies are shown in a list. Turn the control dial, select an available channel and then press the control dial. The setting is complete.
 - When selecting [Find Best] and pressing the control dial, the optimum channel and frequency are shown. Turn the control dial, select [Set] and then press the control dial. The setting is complete.

Selecting the group you want to scan:

4. Confirm the scan result by selecting [OK] and then pressing the control dial.
 - If you want to scan over again, select [Retry].
5. Select the channel selection method, and then press the control dial.
 - When selecting [Manual] and pressing the control dial, available channels and frequencies are shown in a list. Turn the control dial, select an available channel and then press the control dial. The setting is complete.
 - When selecting [Find Best] and pressing the control dial, the optimum channel and frequency are shown. Turn the control dial, select [Set] and then press the control dial. The setting is complete.

Setting transmitters via IR SYNC

This function allows you to make transmitter settings on the receiver and then automatically configure the transmitter via IR SYNC. The following are the available settings and setting values:

Settings	Setting values
Freq	Current setting value, NoChange
Name	Current setting value, NoChange
RF Pwr	Low:2mW, Mid:10mW, High:50mW, NoChange
Gain	-10 to +20dB, NoChange
Sens.*	0, +10dB, NoChange
Lock	Lock, Unlock, NoChange
Batt	Alkaline, Ni-MH, NoChange
HPF	OFF, ON, NoChange

* ATW-T5201 only

1. From the menu screen, turn the control dial, select [TX SYNC] and then press the control dial.
2. Turn the control dial to select a setting you would like to sync to the transmitter and then press the control dial.
3. Turn the control dial to select the setting value and then press the control dial.
4. Repeat Steps 2 and 3 for each setting you would like to sync to the transmitter.
5. Turn the control dial, select [SYNC START] and then press the control dial.
 - Communication function is in standby. Refer to "Using IR SYNC" (p. 28) for subsequent steps.

Setting ATW-R5220/TW-R5220DAN

Setting the squelch level

Setting automatically

1. From the menu screen, turn the control dial, select [SQUELCH] and then press the control dial.
2. Turn the control dial, select [AUTO] and then press the control dial.
3. Turn the control dial, select [Normal], [High] or [Low] and then press the control dial.

- You can select one from [Normal], [High] or [Low].



High: Prioritize the sound/voice quality.

Normal

Low: Prioritize the available range.

- Scan starts.
 - If an error message is displayed, change the operating frequency. The error indicates that the current frequency is already in use or that there is excessive noise.
4. Scan starts. Press the control dial.
 - The setting is complete.

Setting manually

1. From the menu screen, turn the control dial, select [SQUELCH] and then press the control dial.
2. Turn the control dial, select [MANUAL] and then press the control dial.
3. Turn the control dial to select the value you wish to set.
 - The meter indicates the RF level.
 - It can be set from levels 1 to 16.
 - While the available range of the transmitter becomes wider as the squelch level is lower, there may be cases when noises occur under the influence of other radio waves. While the available range of the transmitter becomes narrower as the squelch level is made higher, noises are less likely to occur due to the less influence of other radio waves.
4. Press the control dial.
 - The setting is complete.

Setting the system-related functions

Setting the lock

Set this function to prevent the receiver settings from being changed.

- The default setting is [Unlock].
1. From the menu screen, turn the control dial, select [UTILITIES] and then press the control dial.
 2. Turn the control dial, select [LOCK] and then press the control dial.
 3. Turn the control dial to select [Lock] or [Unlock], and then press the control dial.
 - The setting is complete.

Setting the antenna power

Set whether to turn power on or off to the antenna input terminals.

- The default setting is [OFF].
 - If set to [ON], power is supplied to both antennas A and B.
1. From the menu screen, turn the control dial, select [UTILITIES] and then press the control dial.
 2. Turn the control dial, select [ANT PWR] and then press the control dial.
 3. Turn the control dial, select [ON] or [OFF] and then press the control dial.
 - The setting is complete.

Setting ATW-R5220/ATW-R5220DAN

Setting group/channel editing

Setting group/channel

Groups/Channels 01 to 10 can be edited.

1. From the menu screen, turn the control dial, select [UTILITIES] and then press the control dial.
2. Turn the control dial, select [Gr/Ch EDIT] and then press the control dial.
3. Turn the control dial, select [EDIT] and then press the control dial.
4. Turn the control dial, select a channel and then press the control dial.
5. Turn the control dial, select [ON] or [OFF] and then press the control dial.
 - If you select [OFF], the group can not be used.
6. Turn the control dial, select a channel and then press the control dial.
7. Turn the control dial, select [EDIT] and then press the control dial.
 - By pressing [SET], you can set the frequency of the selected channel.
 - If you press [RESET], the frequency of the selected channel becomes blank.
8. After setting all channels, turn the control dial, select [Sync] or [Save] and then press the control dial.
 - If you press [Save], the setting is completed.
 - If you press [Sync], the screen turns to an IR SYNC standby screen. Refer to "Using IR SYNC" (p. 28) for subsequent steps.

Syncing the Group/Channel

The Groups/Channels that have been set with [EDIT] can be set to the transmitter in groups with IR SYNC.

1. From the menu screen, turn the control dial, select [UTILITIES] and then press the control dial.
2. Turn the control dial, select [Gr/Ch EDIT] and then press the control dial.
3. Turn the control dial, select [Gr/Ch SYNC] and then press the control dial.
4. Turn the control dial to select group and then press the control dial.
 - The screen turns to an IR SYNC standby screen. Refer to "Using IR SYNC" (p. 28) for subsequent steps.

Setting the backup frequency mode

If you set the backup frequency in advance, you can switch the frequency of the transmitter and receiver with the transmitter. It is convenient to set this function when you want to switch the frequency easily.

- The default setting is [OFF].
1. From the menu screen, turn the control dial, select [UTILITIES] and then press the control dial.
 2. Turn the control dial, select [BACKUP FREQ] and then press the control dial.
 3. Turn the control dial, select [ON] and then press the control dial.
 4. Turn the control dial, select [Manual] or [Gr/Ch] and then press the control dial.
 - If you select [Manual], you can set the frequency.
 - If you select [Gr/Ch], you can set the group/channel.
 5. After setting each item, turn the control dial, select [Set] or [Sync] and then press the control dial.
 - If you press [SET], the setting is completed but you must still sync the setting with the transmitter or set the backup frequency manually on the transmitter in order to use the backup frequency.
 - If you press [Sync], the screen turns to an IR SYNC standby screen. Refer to "Using IR SYNC" (p. 28) for subsequent steps.

Setting ATW-R5220/ATW-R5220DAN

Setting the AF level meter on the main screen

Switch the AF level meter on the main screen between [Receiver (Rx)] and [Transmitter (Tx)].

- The default setting is [RX].
1. From the menu screen, turn the control dial, select [UTILITIES] and then press the control dial.
 2. Turn the control dial, select [AF METER] and then press the control dial.
 3. Turn the control dial, select [RX] or [TX] and then press the control dial.
 - The setting is complete.

Setting the display brightness

The default setting is [High].

1. From the menu screen, turn the control dial, select [UTILITIES] and then press the control dial.
2. Turn the control dial, select [BRIGHTNESS] and then press the control dial.
3. Turn the control dial, select [High] or [Low] and then press the control dial.
 - The setting is complete.

Setting the user access level

Set the user access level.

- The default setting is [Free Tuning].
1. From the menu screen, turn the control dial, select [UTILITIES] and then press the control dial.
 2. Turn the control dial, select [ACCESS] and then press the control dial.
 3. Turn the control dial, select [Free Tuning] or [Group Only] and then press the control dial.

Free Tuning	No limit
Group Only	Selection of frequency can be made only from group.

- The setting is complete.

Resetting

This returns the receiver settings to their factory defaults.

1. From the menu screen, turn the control dial, select [UTILITIES] and then press the control dial.
2. Turn the control dial, select [RESET] and then press the control dial.
3. Turn the control dial, select [Yes] and then press the control dial.
4. After the confirmation screen is displayed, turn the control dial again to select [Yes] and then press the control dial.
 - Reset starts.

Checking the receiver information

This function displays product information such as the version of the receiver.

1. From the menu screen, turn the control dial, select [UTILITIES] and then press the control dial.
2. Turn the control dial, select [VERSION].

Setting ATW-R5220/ATW-R5220DAN

Setting network

By connecting the receiver and PC, you can use the dedicated app for monitoring or controlling with the PC.

Setting the receiver's ID No.

1. From the menu screen, turn the control dial, select [NETWORK] and then press the control dial.
2. Turn the control dial, select [DEVICE ID] and then press the control dial.
3. Turn the control dial, select the device ID and then press the control dial.
 - The setting is complete.

Setting the IP

1. From the menu screen, turn the control dial, select [NETWORK] and then press the control dial.
2. Turn the control dial, select [IP SETTING] and then press the control dial.
3. Select an item you want to set and press the control dial.

IP Mode	Set how to obtain IP addresses. [Auto]: IP addresses are automatically assigned. [Static]: Set to use the specified static IP addresses.
IP Address*	Specify static IP addresses.
Subnet Mask*	Set the subnet mask.
Gateway*	Set the gateway.

*This item can be set only when [IP Mode] is set to [Static].

4. Set each item.

Setting the remote control

1. From the menu screen, turn the control dial, select [NETWORK] and then press the control dial.
2. Turn the control dial, select [REMOTE CTRL] and then press the control dial.
3. Select an item you want to set and press the control dial.

Port	Set the receiver's ID No.
Notification	Receive notifications from the receiver.
LVL Notify	Set whether to include the AF and RF level in the notification from the receiver during remote control.
Multicast IP	Set the address for multicast.
Multicast Port	Set the port number for multicast.

4. Set each item.

Setting the log message

Set whether to send the log message to the Syslog server.

1. From the menu screen, turn the control dial, select [NETWORK] and then press the control dial.
2. Turn the control dial, select [SYSLOG] and then press the control dial.
3. Turn the control dial, select [ON] or [OFF] and then press the control dial.
 - The setting is complete.

• Syslog is a standard for transferring log messages across IP networks. It is used for administration of computer systems and security monitoring.

Setting automatic detection by the application

1. From the menu screen, turn the control dial, select [NETWORK] and then press the control dial.
2. Turn the control dial, select [DISCOVERY] and then press the control dial.
3. Turn the control dial, select [ON] or [OFF] and then press the control dial.
 - The setting is complete.

Setting NTP

Set the NTP (Network Time Protocol).

1. From the menu screen, turn the control dial, select [NETWORK] and then press the control dial.
2. Turn the control dial, select [NTP] and then press the control dial.
3. Select an item you want to set and press the control dial.

NTP	Set whether to enable or disable the NTP (Network Time Protocol).
Server adrs	Set the NTP server address.
Port	Set the NTP port number.
Time Zone	Set the time difference from the UTC (Coordinated Universal Time).
DST	Turn on/off the daylight saving time.
DST Start Date	Set the starting date of daylight saving time.
DST Start Time	Set the starting time of daylight saving time.
DST End Date	Set the ending date of daylight saving time.
DST End Time	Set the ending time of daylight saving time.

4. Set each item.

Setting ATW-R5220/TW-R5220DAN

Setting MAC address

1. From the menu screen, turn the control dial, select [NETWORK] and then press the control dial.
2. Turn the control dial, select [MAC ADDRESS].

Using test mode

Using the walk test function

When using the walk test function, record for 90 sec. the RF level being received.

1. From the menu screen, turn the control dial, select [TOOLS] and then press the control dial.
2. Turn the control dial, select [WALK TEST] and then press the control dial.
3. Select [START] and press the control dial.
 - Walk test starts.

Setting monitor mode

This mode will enable monitoring with headphones only. (The audio OUT and DANTE OUT will be muted.)

1. From the menu screen, turn the control dial, select [TOOLS] and then press the control dial.
2. Turn the control dial, select [MONITOR MODE] and then press the control dial.
 - Monitor mode is set.

Setting DANTE

This setting is used only for ATW-R5220DAN.

Displaying the device name and channel label

1. From the menu screen, turn the control dial, select [DANTE] and then press the control dial.
2. Turn the control dial, select [INFO].

Setting the DANTE's IP

1. From the menu screen, turn the control dial, select [DANTE] and then press the control dial.
2. Turn the control dial, select [IP SETTING] and then press the control dial.
3. Select an item you want to set and press the control dial.

IP Mode	Set how to obtain IP addresses. [Auto]: IP addresses are automatically assigned. [Static]: Set to use the specified static IP addresses.
IP Address*	Specify static IP addresses.
Subnet Mask*	Set the subnet mask.
Gateway*	Set the gateway.

*This item can be set only when [IP Mode] is set to [Static].

4. Set each item.

Setting MAC address

1. From the menu screen, turn the control dial, select [DANTE] and then press the control dial.
2. Turn the control dial, select [MAC ADDRESS].

Checking the receiver information

This function displays product information such as the version of the receiver.

1. From the menu screen, turn the control dial, select [DANTE] and then press the control dial.
2. Turn the control dial, select [VERSION].

Setting ATW-T5201/ATW-T5202

List of setting items

FREQUENCY	MANUAL	Set the transmission frequency.
	Gr/Ch	
NAME		Set the channel name.
GAIN		Set the microphone input gain.
SENSITIVITY*		Set the gain.
RF POWER		Set the transmission output.
HPF		Set HPF (High-Pass Filter).
LOCK		Set a lock.
TOOLS	Fn BUTTON	Set the function allocation for function button.
	TEST TONE	Output a test signal from the transmitter.
UTILITIES	BATTERY	Set the type of batteries used.
	LED	Set whether to constantly keep indicator turned on or off.
	ACCESS	Set the user access level.
	RESET	This returns the transmitter settings to their factory defaults.
	VERSION	It shows the version of the transmitter.

* ATW-T5201 only

Setting the transmission frequency

Setting manually

- From the menu screen, press the UP/DOWN button to select [FREQUENCY], and then press the SET button.

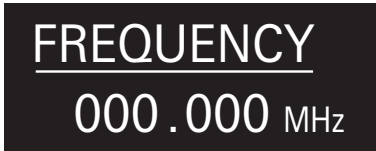

- After selecting [MANUAL], press the SET button.



- Press the UP/DOWN button to set the first 3 digits. After completing the setting, press the SET button.
- Press the UP/DOWN button to set the last 3 digits. After completing the setting, press the SET button.
 - The setting is complete.

Setting by group/channel

- From the menu screen, press the UP/DOWN button to select [FREQUENCY], and then press the SET button.



- After selecting [Gr/Ch], press the SET button.



- Press the UP/DOWN button to set the group. After completing the setting, press the SET button.
- Press the UP/DOWN button to set the channel. After completing the setting, press the SET button.
 - The setting is complete.

Setting the channel (transmitter) name

The following characters can be entered:

- The maximum number of characters that can be entered is 8.

Alphabetic (uppercase letters)	Numeric
Symbols (+, -, #, &, period)	Space

- From the menu screen, press the UP/DOWN button to select [NAME], and then press the SET button.



- Press the UP/DOWN to select a desired character and press the SET button.
 - The character is input and the cursor moves.
- Repeat the operation in Step 2 to enter all characters.
 - If you don't enter 8 characters, press the UP/DOWN button and select [End] and then press the SET button.
- After entering the 8th character, press the SET button.
 - [End] is displayed.
- Press the SET button.
 - The setting is complete.

Setting ATW-T5201/ATW-T5202

Setting the gain

1. From the menu screen, press the UP/DOWN button to select [GAIN], and then press the SET button.



2. Press the UP/DOWN button to select the gain you wish to set.
 - The level changes 2dB +/- each time you press the UP/DOWN button.
 - It can be set from -10 to +20 dB.
3. Press the SET button.
 - The setting is complete.

Setting the microphone input gain

1. From the menu screen, press the UP/DOWN button to select [SENSITIVITY], and then press the SET button.



2. Press the UP/DOWN button and select [0dB] or [+10dB].
3. Press the SET button.
 - The setting is complete.

Setting the RF transmission output

1. From the menu screen, press the UP/DOWN button to select [RF POWER], and then press the SET button.



2. Press the UP/DOWN button and select [High:50mW], [Mid:10mW], [Low:2mW] or [Off].
3. Press the SET button.
 - The setting is complete.

Setting HPF (High-Pass Filter)

1. From the menu screen, press the UP/DOWN button to select [HPF], and then press the SET button.



2. Press the UP/DOWN button to select [On] or [Off].
3. Press the SET button.
 - The setting is complete.

Setting lock

1. From the menu screen, press the UP/DOWN button to select [LOCK], and then press the SET button.



2. Press the UP/DOWN button to select [Lock] or [Unlock].

Lock	Locks transmitter buttons
Unlock	Unlocks transmitter buttons

3. Press the SET button.
 - The setting is complete.

Setting ATW-T5201/ATW-T5202

Setting the function

Setting the function for the function button

Select the function to be performed when the function button is pressed and held

1. From the menu screen, press the UP/DOWN button to select [TOOLS], and then press the SET button.



2. Press the UP/DOWN button to select [Fn BUTTON], and then press the SET button.

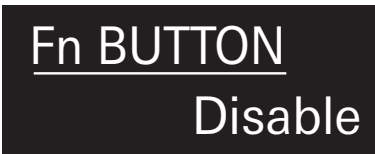

3. Press the UP/DOWN button to select the function you wish to set.

Disable	No function
Mute (only for ATW-T5202)	Mutes the transmitter
MuteOnLock (only for ATW-T5202)	Mutes the transmitter (even when transmitter buttons are locked)
Bkup Freq	Switches to backup frequency (When selected, set the frequency, group, and channel.)
RF Off	Turns off RF transmission output

4. Press the SET button.
 - The setting is complete.

Outputting a test signal from the transmitter

1. From the menu screen, press the UP/DOWN button to select [TOOLS], and then press the SET button.



2. Press the UP/DOWN button to select [TEST TONE], and then press the SET button.



3. Press the UP/DOWN button to select [On], and then press the SET button.
 - Outputting a test signal starts.
 - While outputting a test signal, a microphone input will be muted.

Setting the system-related functions

Setting the battery type

Set the type of batteries used.

- The default setting is [Alkaline].

1. From the menu screen, press the UP/DOWN button to select [UTILITIES], and then press the SET button.



2. Press the UP/DOWN button to select [BATTERY] and press the SET button.



3. Press the UP/DOWN button to select the battery you wish to set.

Alkaline	Select when using alkaline batteries.
NiMH	Select when using nickel-metal hydride batteries.

4. Press the SET button.
 - The setting is complete.

- If the appropriate setting is not made for the batteries used, the battery power indicator will not display the correct information. Always set the type of battery according to the batteries used.

Setting ATW-T5201/ATW-T5202

Setting the indicator

The indicator LED can be turned [On] or [Off].

- The default setting is [On].
1. From the menu screen, press the UP/DOWN button to select [UTILITIES], and then press the SET button.



2. Press the UP/DOWN button to select [LED] and press the SET button.



3. Press the UP/DOWN button to select [On] or [Off].
4. Press the SET button.
 - The setting is complete.

Setting the user access level

Set the user access level.

- The default setting is [Free].
1. From the menu screen, press the UP/DOWN button to select [UTILITIES], and then press the SET button.



2. Press the UP/DOWN button to select [ACCESS] and press the SET button.



3. Press the UP/DOWN button to select [Free] or [Group].

Free	No limit
Group	Selection of frequency can be made only from group.

4. Press the SET button.
 - The setting is complete.

Resetting

This returns the transmitter settings to their factory defaults.

1. From the menu screen, press the UP/DOWN button to select [UTILITIES], and then press the SET button.



2. Press the UP/DOWN button to select [RESET] and press the SET button.



3. Press the UP/DOWN button to select [Yes].
4. When the confirmation screen is shown, press the UP/DOWN button again to select [Yes].
5. Press the SET button.
 - Reset starts.

Checking the transmitter information

This function displays the firmware version for the transmitter.

1. From the menu screen, press the UP/DOWN button to select [UTILITIES], and then press the SET button.



2. Press the UP/DOWN button to select [VERSION] and press the SET button.
 - The version is shown.



How to attach the transmitter (ATW-T5201)

The ATW-T5201 transmitter is equipped with a clip that can be used to attach the transmitter to a belt, etc.

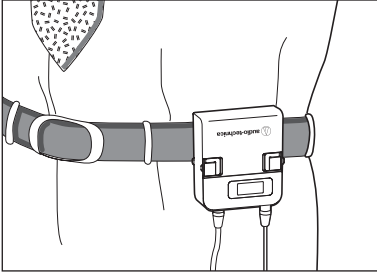

You can reverse the direction of the input connector by attaching the clip in the opposite direction.

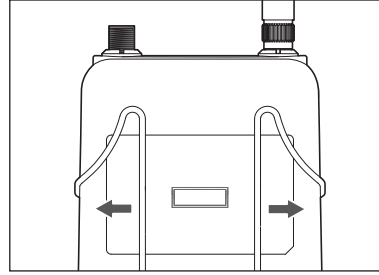

Pull both sides of the clip firmly to the outside to remove the clip from the transmitter.

Making connections (basic connections)

This is an example of connections made when using one receiver.

When connecting more than one receiver via a distributor (sold separately), refer to the distributor's user manual.

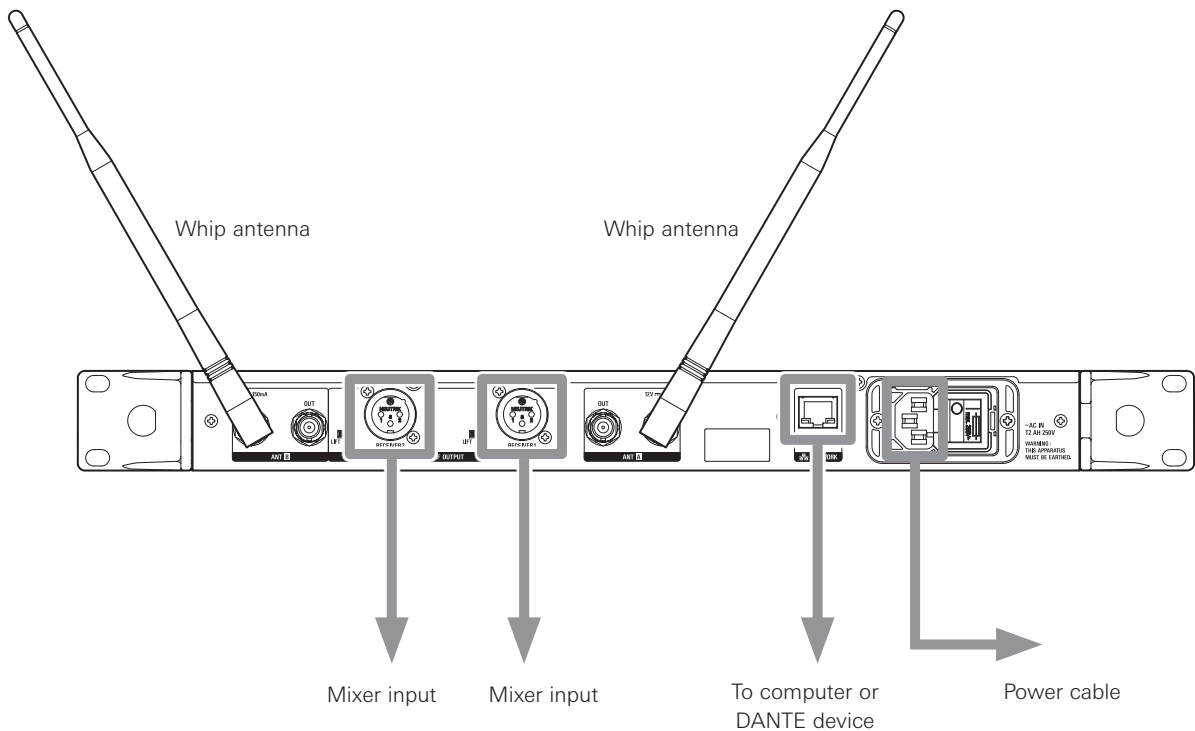

Using IR SYNC

This function allows you to make settings on the receiver that are specified for the transmitter.

1. When IR SYNC is started as part of setting the receiver, the “Communication in standby” screen is displayed.
2. Position the IR sync windows of the receiver and transmitter so they face each other.
3. Press the SYNC button on the transmitter.
 - Wait several seconds until communication is established.
4. When the SYNC is complete, the “completed” screen is displayed.
 - The settings made on the receiver are automatically synced to the transmitter.
 - If an error occurs in the SYNC process, an error screen opens and then the display returns to the menu screen. Check the IR SYNC windows of the receiver and transmitter and then SYNC again.
 - To cancel the SYNC process, press the BACK button on the receiver. You will be returned to the previous screen.

Achieving stable reception

Low RF signal may result if there are obstructions between receiver antennas and transmitter(s). In such a case, reposition the antennas to get better reception. Use external antennas (sold separately) if the installation space is limited.

Rack-mounting the receiver

- Screws for rack-mounting the receiver are not included.
- Consider ventilation when rack-mounting to avoid heat building up in the rack.

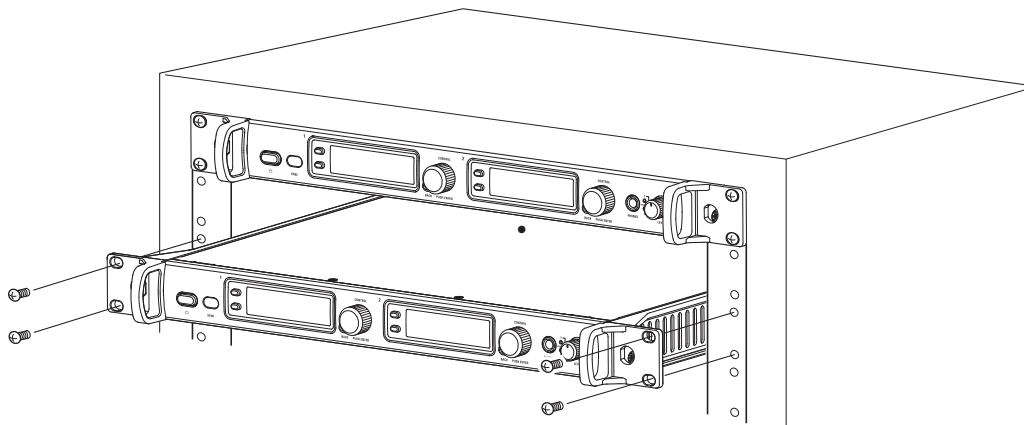

Troubleshooting

ATW-R5220/ATW-R5220DAN

Symptoms	Causes and countermeasures	Reference page
The power can't be turned on.	Confirm that the power cable is correctly connected.	-
There is no voice output. The voice output level is low.	Confirm that the transmitter/receiver channels are correct	p. 15, p. 20
	Confirm that the power buttons of the transmitter/receiver are not turned OFF.	p. 13
	Confirm that the antennas are correctly connected.	-
	Confirm that all connected components, such as a mixer, are correctly connected to the receiver.	-
	Confirm that the audio output isn't set to the minimum level.	p. 16
	Confirm that the audio output level of connected components (such as a mixer) is not minimized.	-
Sound is distorted.	Confirm that the audio output level isn't too high.	p. 16
	Confirm that the volume of any connected component isn't too high.	-
There is unwanted noise.	Confirm that there is no noise source, such as a fluorescent lamp or electric component, near the receiver.	-
	Confirm that each transmitter is using a different frequency.	-
	Confirm that the output terminal of the receiver is correctly connected.	p. 24
	Confirm that the receiver isn't taking power from an electrical outlet that is also being used by another noisy component.	-
	Confirm that there isn't any other nearby wireless system using the same frequency band. Adjust the squelch level.	p. 17

ATW-T5201/ATW-T5202

Symptoms	Causes and countermeasures	Reference page
The power can't be turned on.	Confirm that batteries are in place.	-
	Confirm that batteries are not depleted.	-
	Confirm that batteries are inserted in the right direction.	p. 8
There is no voice output. The voice output level is low.	Confirm that the transmitter/receiver channels are correct	p. 15, p. 20
	Confirm that the power switch is not turned OFF.	p. 13
	Confirm that RF Power isn't OFF.	p. 21
	Confirm that the transmitter isn't in mute mode.	p. 21
	Confirm that the transmission output of the transmitter is not too low.	p. 21
	Confirm that the microphone or the guitar cable is not disconnected (only for ATW-T5201).	-
	Confirm that the output volume of the musical instrument, such as a guitar, isn't set at the minimum level.	-
	Confirm that the microphone capsule is connected properly (only for ATW-T5202).	p. 9
Sound is distorted.	Confirm that the gain setting of the transmitter is not too high.	p. 21
There is unwanted noise.	Confirm that there is no noise source, such as a fluorescent lamp, LED lamp, or electric component, near the transmitter.	-
	Confirm that each transmitter is using a different frequency.	-
	Confirm that the transmission output setting of the transmitter is not too high.	p. 21

Dimensions

ATW-R5220/ATW-R5220DAN

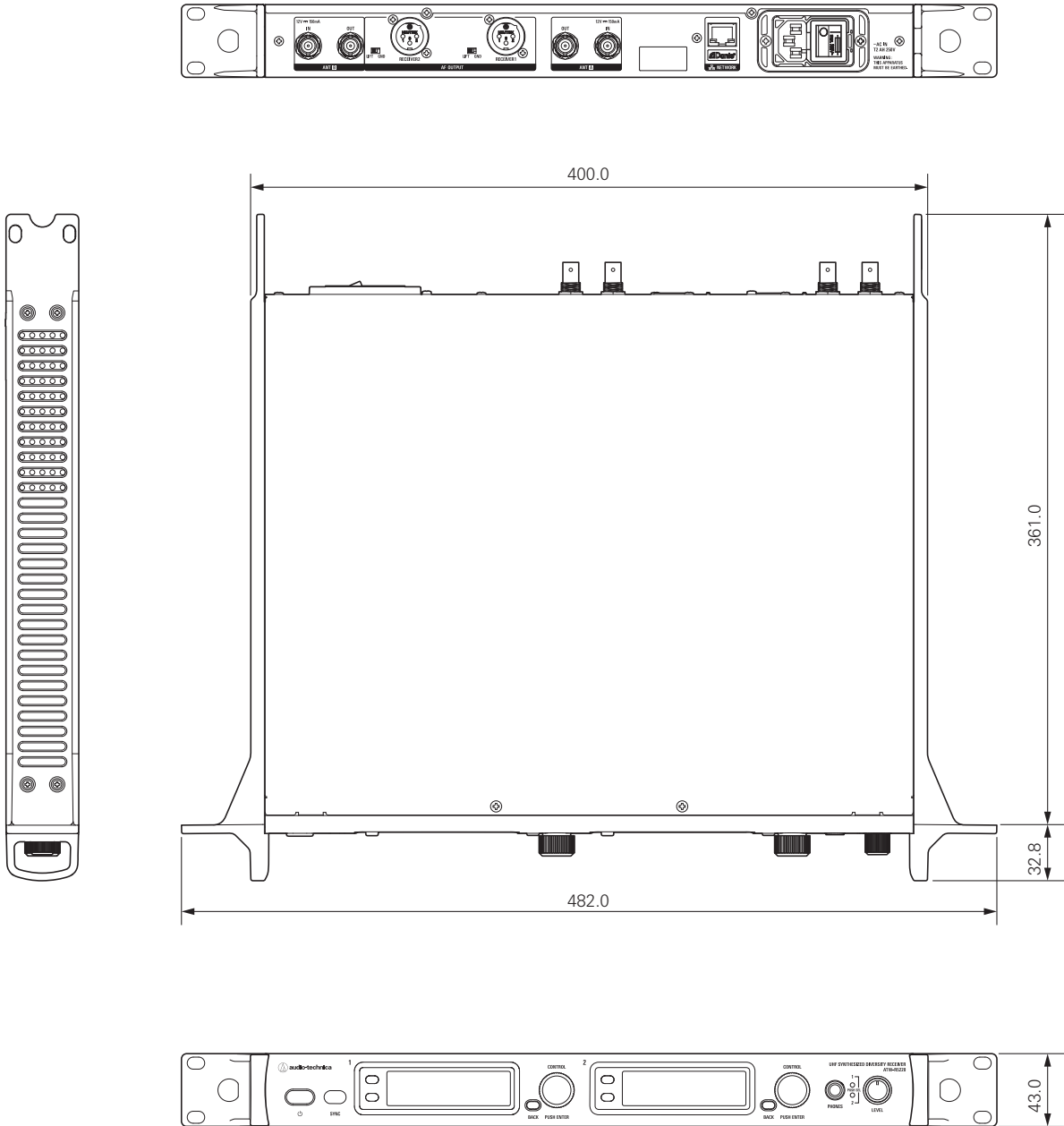

(Unit: mm)

Dimensions

ATW-T5201

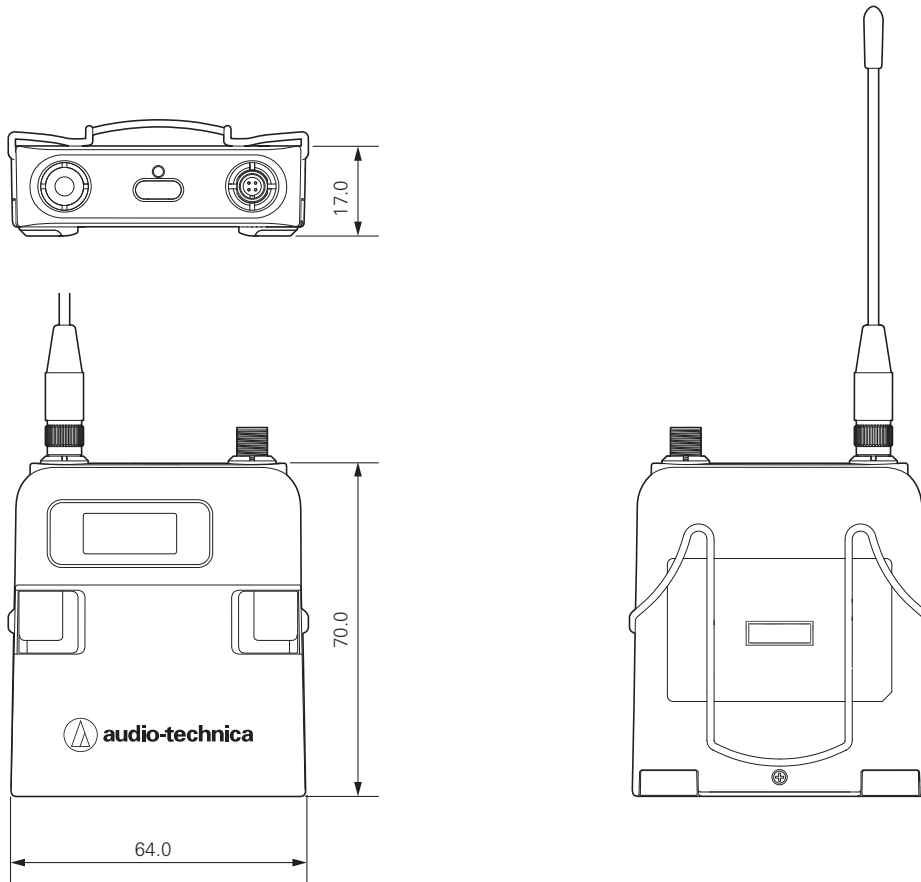

(Unit: mm)

ATW-T5202

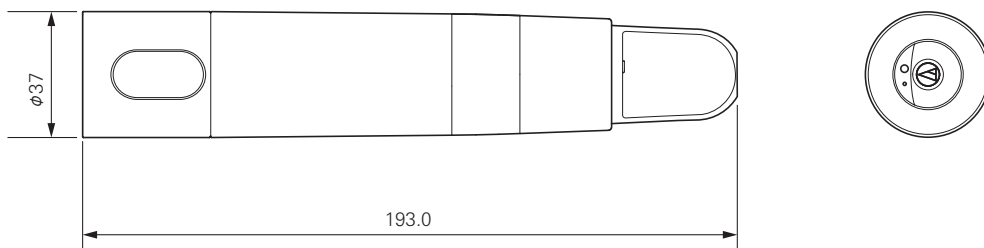

(Unit: mm)

Specifications

Overall system specifications

Operating frequencies*1	Frequency range	Number of frequencies
ATW-R5220		
Band DG1:	470.125 to 699.875 MHz	9,191
Band DF1:	470.125 to 607.875 MHz, 657.100 to 662.900 MHz	5,511+233
ATW-T5201/ATW-T5202		
Band DE1:	470.125 to 590.000 MHz	4,796
Band EG1:	580.000 to 699.875 MHz	4,796
Band FE2:	580.000 to 607.875 MHz, 657.100 to 662.900 MHz	1,116+223
Minimum frequency step	25 kHz	
Modulation mode	FM	
Maximum deviation	ATW-T5201: ± 40 kHz (THD:10%) ATW-T5202: ± 40 kHz (THD:10%)	
Dynamic range	ATW-T5201 Mic input: 120 dB or higher (A-weighted), typical ATW-T5201 Inst input: 107 dB or higher (A-weighted), typical ATW-T5202: 116 dB or higher (A-weighted), typical	
Total harmonic distortion	1.0 % or less (at 1 kHz, ± 17.5 kHz deviation)	
Operating range*2	100 m (328')	
Frequency response*3	ATW-T5201: 23 Hz to 16,300 Hz ATW-T5202: 33 Hz to 16,300 Hz	

*1 Please note that some frequency bands might not be available in your territory or could come with a limited tuning bandwidth/transmitting power due to local regulations.

*2 Open range environment with no interfering signals.

*3 Frequency response depends on attached microphone element.

ATW-R5220/ATW-R5220DAN

Receiving system	True diversity
Image rejection	80 dB nominal
RF sensitivity	18 dBuV at 60 dBA S/N ratio (50 ohms termination)
Maximum output level	XLR, Balanced, +18 dBV
Headphone output connector	6.3 mm (1/4") TRS Stereo
Headphone output power	180 mW, typical
Antenna input	BNC-type, 50 ohms
Antenna power	12 V DC, 150 mA (combined)
Power supply	100 to 240 V AC (50/60 Hz)
Operating temperature range	-5 °C to +45 °C (23 ° F to 113 °F)
Dimensions	482.0 mm (18.98") x 361.0 mm (14.21") x 43.0 (1.69") mm (W x D x H)
Weight (without accessories)	4.8 kg (169.3 oz)
Included accessories	Rack-mount (large, small), Rack-mount screw set, Flexible UHF antenna x 2, AC adapter (country dependent)

ATW-T5201

RF output power	High: 50 mW, Mid: 10 mW, Low: 2 mW (switchable), at 50 ohms
Spurious emissions	Following federal and national regulations
Input connection	Four pin locking connector
	Pin 1: GND
	Pin 2: INST INPUT
	Pin 3: MIC INPUT
	Pin 4: DC BIAS +5 V
High-pass (low-freq. roll-off)	80 Hz, 12 dB/octave
Batteries	Two 1.5V AA, not included
Battery life*	High: 7 hours, Mid: 9 hours Low: 10.5 hours (alkaline)
Dimensions	62 mm (2.44") x 70 mm (2.75") x 17 mm (0.67") (W x D x H)
Weight (without batteries)	92 g (3.2 oz)
Operating temperature range	-5 °C to +45 °C (23 ° F to 113 °F)
Included accessories	AT-BG3 Protective Carrying Case

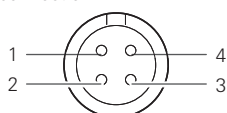

* Depending on battery type, usage and environmental conditions.

Specifications

ATW-T5202

RF output power	High: 50 mW, Mid: 10 mW, Low: 2 mW (switchable), at 50 ohms
Spurious emissions	Following federal and national regulations
Microphone capsule	Interchangeable industry standard thread
High-pass (low-freq. roll-off)	80 Hz, 6dB/octave
Batteries	Two 1.5V AA, not included
Battery life*	High: 6.5 hours, Mid: 8 hours, Low: 9.5 hours (alkaline)
Dimensions	ATW-T5202 (without capsule): 193 mm (7.60") long, 37 mm (1.46") maximum diameter ATW-T5202/C510: 265 mm (10.43") long, 54 mm (2.13") maximum diameter ATW-T5202/C710: 271 mm (10.67") long, 50 mm (1.97") maximum diameter
Weight (without batteries)	ATW-T3202 (without capsule): 200 g (7.1 oz) ATW-T5202/C510: 330 g (11.6 oz) ATW-T5202/C710: 314 g (11.1 oz)
Operating temperature range	-5 °C to +40 °C (23 °F to 104 °F)
Included accessories	AT8456a Quiet-Flex™ stand clamp (5/8"-27 male to 3/8"-16 female threaded screw adapter)

* Depending on battery type, usage and environmental conditions.

For product improvement, the product is subject to modification without notice.

Audio-Technica Corporation

2-46-1 Nishi-naruse, Machida, Tokyo 194-8666, Japan

www.audio-technica.com

©2018 Audio-Technica Corporation

Global Support Contact: www.at-globalsupport.com

232417000-02-01 ver.1 2018.08.01