

TIMCO ENGINEERING INC.

849 NW State Road 45

Newberry, Florida 32669

<http://www.timcoengr.com>

888.472.2424 F 352.472.2030 email: sid@timcoengr.com



Test Report

Product Name: LICENSED BROADCAST TRANSMITTER

FCC ID: JFZT310C

Applicant:

**AUDIO TECHNICA CORPORATION
2206 NARUSE MACHIDA
TOKYO 194
JAPAN**

Date Receipt: JANUARY 21, 2004

Date Tested: FEBRUARY 16, 2004

APPLICANT: AUDIO TECHNICA CORPORATION

FCC ID: JFZT310C

REPORT #: A\AudioTechnica_JFZ\69UT4\69UT4TestReport.doc

COVER SHEET

TIMCO ENGINEERING INC.

849 NW State Road 45
Newberry, Florida 32669
<http://www.timcoengr.com>
888.472.2424 F 352.472.2030 email: sid@timcoengr.com

TABLE OF CONTENTS LIST

TEST REPORT CONTAINING:

PAGE 1.....	GENERAL INFORMATION & TECHNICAL DESCRIPTION
PAGE 2.....	TECHNICAL DESCRIPTION & RF OUTPUT POWER
PAGE 3.....	MODULATION CHARACTERISTICS AUDIO FREQUENCY RESPONSE GRAPH AUDIO LOW PASS FILTER
PAGE 4.....	AUDIO INPUT VERSUS MODULATION GRAPH
PAGE 5.....	OCCUPIED BANDWIDTH
PAGE 6.....	OCCUPIED BANDWIDTH PLOT
PAGE 7-9.....	RADIATED EMISSIONS TEST DATA
PAGE 10.....	METHOD OF MEASURING RADIATED SPURIOUS EMISSIONS
PAGE 11.....	FREQUENCY STABILITY TEST DATA
PAGE 12-13.....	EQUIPMENT LIST

EXHIBITS CONTAINING:

REQUEST FOR CONFIDENTIALITY LETTER
BLOCK DIAGRAM
SCHEMATICS
USER'S MANUAL
PARTS LIST
LABEL SAMPLE
LABEL LOCATION
EXTERNAL PHOTOGRAPHS
INTERNAL PHOTOGRAPHS
TUNING PROCEDURE
CIRCUIT DESCRIPTION
TEST SET UP PHOTOGRAPH

TIMCO ENGINEERING INC.

849 NW State Road 45
Newberry, Florida 32669
<http://www.timcoengr.com>
888.472.2424 F 352.472.2030 email: sid@timcoengr.com

GENERAL INFORMATION REQUIRED FOR TYPE ACCEPTANCE

2.1033(c)(1)(2) AUDIO TECHNICA CORPORATION will manufacture the T310C in quantity, for use under FCC RULES PART 74.801, LOW POWER AUXILIARY STATIONS.

AUDIO TECHNICA CORPORATION
2206 NARUSE, MACHIDA
TOKYO, 194
JAPAN

2.1033 TECHNICAL DESCRIPTION

(c)(3) Instruction book. The instruction manual is included in the exhibits.

(c)(4) Type of Emission: 13K0F3E

Bn = 2M + 2DK
M = 20000
D = 45 kHz(Peak Deviation)
K = 1
Bn = 2(20k) + 2(45k)(1) = 130k

74.861 (e)(5) ALLOWED AUTHORIZED BANDWIDTH = 200kHz.

(c)(6) Frequency Range: Part 74: 541.5 - 566.375 MHz

(c)(7) Power Range and Controls: UNIT has no controls.

(c)(8) Maximum Output Power Rating: .020 Watts into 50 ohms resistive load.

(c)(9) DC Voltages and Current into Final Amplifier:

FINAL AMPLIFIER ONLY - 9.0V BATTERY

Vce = 3.0 Volts
Ice = 0.2 mA.

(c)(10) Tune-up procedure. The tune-up procedure is included in the exhibits.

(c)(11) Complete Circuit Diagrams: The circuit diagram and block diagram are in the exhibits.

APPLICANT: AUDIO TECHNICA CORPORATION
FCC ID: JFZT310C
REPORT #: A\AudioTechnica_JFZ\69UT4\69UT4TestReport.doc

TIMCO ENGINEERING INC.

849 NW State Road 45

Newberry, Florida 32669

<http://www.timcoengr.com>

888.472.2424 F 352.472.2030 email: sid@timcoengr.com

2.1033(c)(12) Photo or Drawing of Label and sketch of location:
Included in the exhibits.

2.1033(c)(13) Photos of Equipment:
Included in the exhibits.

(c)(14) Description of all circuitry and devices provided
for determining and stabilizing frequency.

Description of any circuits or devices employed
for suppression of spurious radiation, for limit-
ing modulation, and for limiting power.

This circuitry is in the exhibits.

Limiting Modulation:

The transmitter audio circuitry is contained
in IC101, IC102 and IC103.

Limiting Power:

There is no provision for limiting power.

(15) Digital modulation. This unit does not use digital
modulation.

2.1033(c)(16) The data required by 2.1046 through 2.1057 is
submitted below.

2.1046 **RF power output**

RF power measured is:

OUTPUT POWER: .008 WATTS

R.F. POWER OUTPUT TEST PROCEDURE

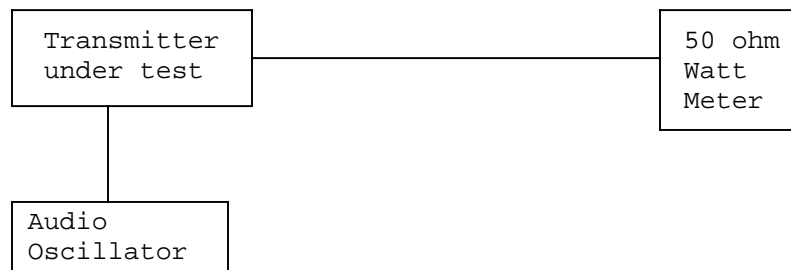

APPLICANT: AUDIO TECHNICA CORPORATION

FCC ID: JFZT310C

REPORT #: A\AudioTechnica_JFZ\69UT4\69UT4TestReport.doc

TIMCO ENGINEERING INC.

849 NW State Road 45
Newberry, Florida 32669
<http://www.timcoengr.com>
888.472.2424 F 352.472.2030 email: sid@timcoengr.com

2.1047(a)(b) **Modulation characteristics:**

AUDIO FREQUENCY RESPONSE

The audio frequency response was measured in accordance with TIA/EIA Specification 603. The audio frequency response curve is shown below.

Audio Frequency Response

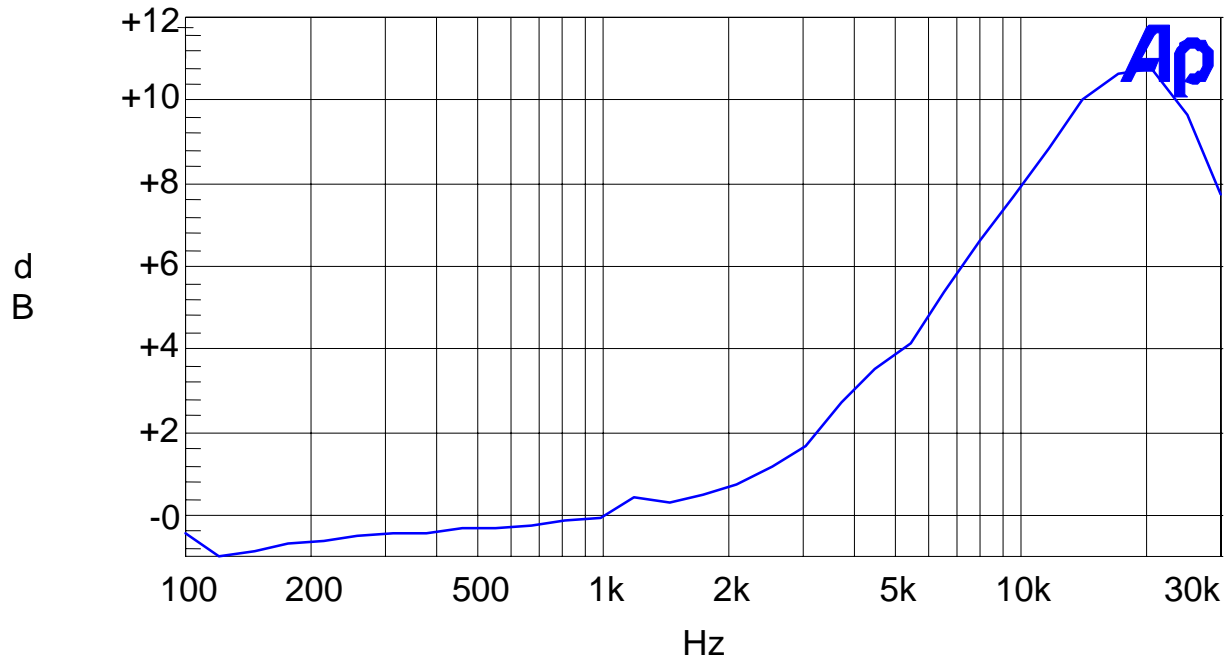

AUDIO LOW PASS FILTER

The audio low pass filter is not required in this unit.

APPLICANT: AUDIO TECHNICA CORPORATION

FCC ID: JFZT310C

REPORT #: A\AudioTechnica_JFZ\69UT4\69UT4TestReport.doc

TIMCO ENGINEERING INC.

849 NW State Road 45
Newberry, Florida 32669
<http://www.timcoengr.com>
888.472.2424 F 352.472.2030 email: sid@timcoengr.com

0 2.1047(b) Audio_input_versus_modulation
80.213 (d) A plot of the audio input versus deviation is
shown in the following plot.

Modulation Limiting Plots:
15KHz (Cyan), 2.5KHz (Green), 1.0KHz (Blue), and 300Hz

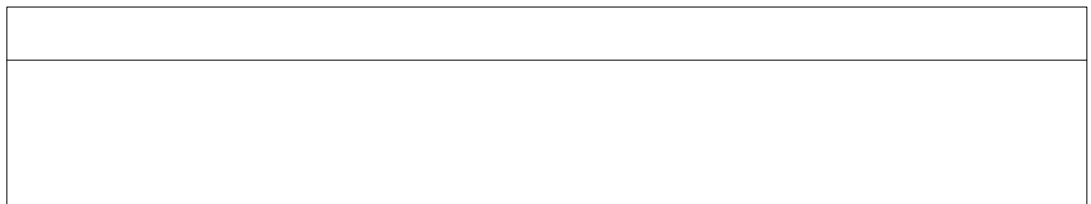
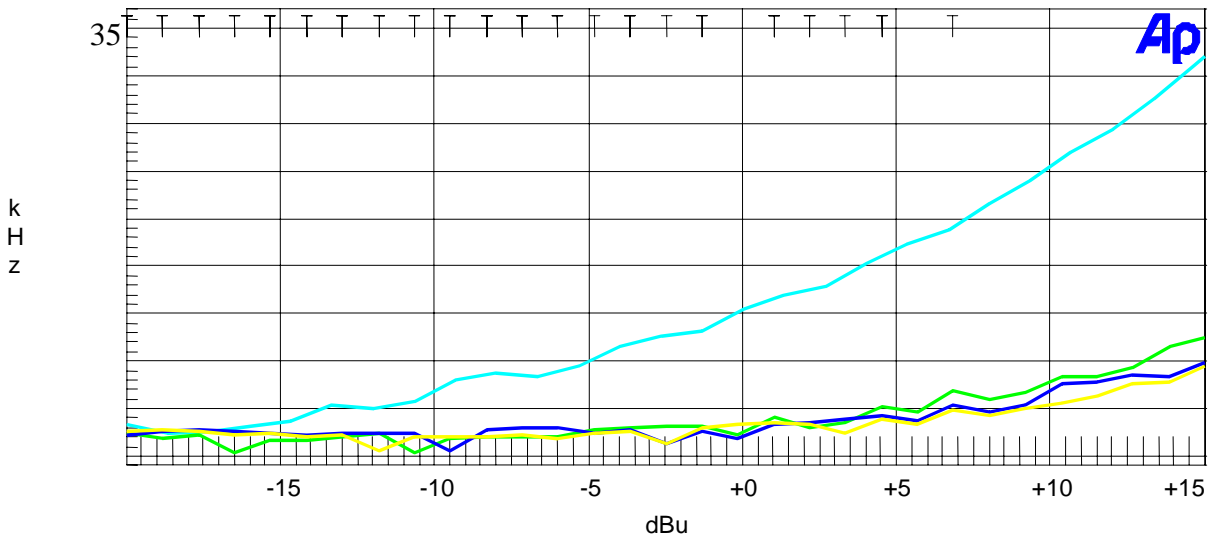

TIMCO ENGINEERING INC.

849 NW State Road 45
Newberry, Florida 32669
<http://www.timcoengr.com>
888.472.2424 F 352.472.2030 email: sid@timcoengr.com

2.1049(c)

Occupied Bandwidth:

Data in the plots show that all sidebands between 50 & 100% for the authorized bandwidth are attenuated by at least 25dB. From 100 to 250% of the authorized bandwidth they are attenuated by at least 35dB and beyond 250% $43 \log(P_o)$ dB. The plot shows the transmitter modulated with 15000 Hz (the highest modulation frequency), adjusted for 50% modulation plus 16 dB. The spectrum analyzer was set with the un-modulated carrier at the top of the screen. The test procedure diagram and occupied bandwidth plots follow.

Wireless Microphone transmitter:

Test procedure diagram

OCCUPIED BANDWIDTH MEASUREMENT

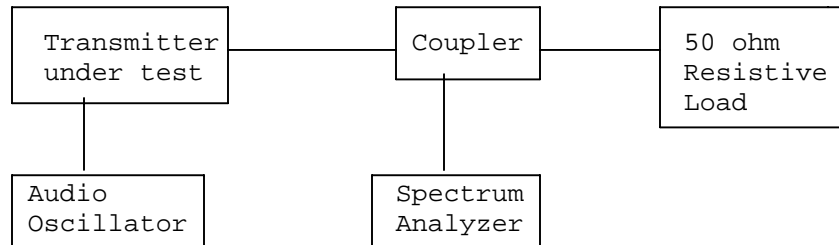

REQUIREMENT: PART 74: 200kHz EMISSION BANDWIDTH.

TIMCO ENGINEERING INC.

849 NW State Road 45
 Newberry, Florida 32669
 http://www.timcoengr.com
 888.472.2424 F 352.472.2030 email: sid@timcoengr.com

OCCUPIED BANDWIDTH

NOTES:

AUDIO TECHNICA CORPORATION - FCC ID: JFZT310C
 OCCUPIED BANDWIDTH PLOT

FCC 74.535 Mask A

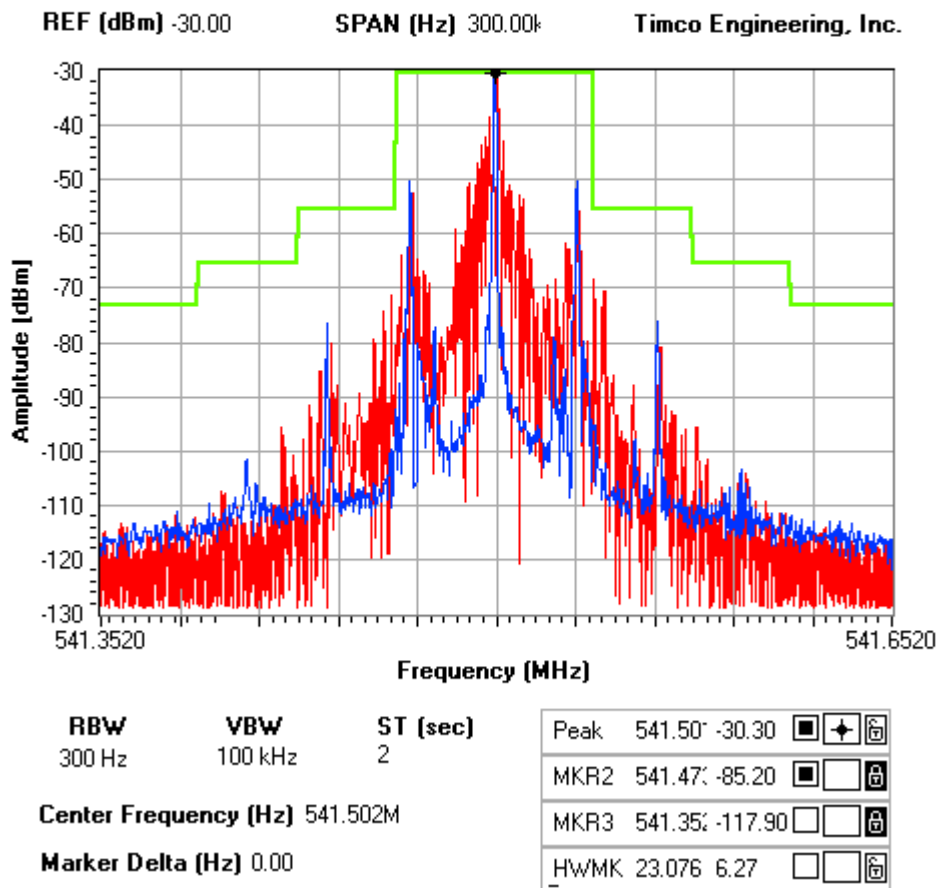

APPLICANT: AUDIO TECHNICA CORPORATION

FCC ID: JFZT310C

REPORT #: A\AudioTechnica_JFZ\69UT4\69UT4TestReport.doc

TIMCO ENGINEERING INC.

849 NW State Road 45
Newberry, Florida 32669
<http://www.timcoengr.com>
888.472.2424 F 352.472.2030 email: sid@timcoengr.com

2.1051 **Spurious emissions at antenna terminals (conducted):**
Not Applicable no antenna connector.

2.1053(a)(b) **Field strength of spurious emissions:**

NAME OF TEST: RADIATED SPURIOUS EMISSIONS (541.5 MHz)

REQUIREMENTS: Emissions must be $43 + 10\log(P_o)$ dB below the mean power output of the transmitter.

$$43 + 10\log(0.01) = 23.00 \text{ dB}$$

TEST DATA:

Emission Frequency MHz	Ant. Polarity	Corrected EUT Signal Reading	Coax Loss (dB)	Substitution Antenna (dBd)	dB Below Carrier (dBc)
541.50	V	9.00	0	0	0
1083.00	V	-43.50	1.02	3.28	50.23
1624.50	V	-46.60	1.12	5.05	51.68
2166.00	V	-46.70	1.23	5.81	51.12
2707.50	V	-46.00	1.32	6.92	49.40
3249.00	V	-47.10	1.37	7.35	50.13
3790.50	V	-37.30	1.43	7.61	40.12
4332.00	V	-43.60	1.48	8.05	46.03
4873.50	V	-52.00	1.57	7.80	54.77
5415.00	V	-50.30	1.68	8.23	52.75

APPLICANT: AUDIO TECHNICA CORPORATION

FCC ID: JFZT310C

REPORT #: A\AudioTechnica_JFZ\69UT4\69UT4TestReport.doc

TIMCO ENGINEERING INC.

849 NW State Road 45
Newberry, Florida 32669
http://www.timcoengr.com
888.472.2424 F 352.472.2030 email: sid@timcoengr.com

2.1051 **Spurious emissions at antenna terminals (conducted):**
Not Applicable no antenna connector.

2.1053(a)(b) **Field strength of spurious emissions:**

NAME OF TEST: RADIATED SPURIOUS EMISSIONS (553.875 MHz)

REQUIREMENTS: Emissions must be $43 + 10\log(P_o)$ dB below the mean power output of the transmitter.

$$43 + 10\log(0.01) = 23.00 \text{ dB}$$

TEST DATA:

Emission Frequency MHz	Ant. Polarity	Corrected EUT Signal Reading	Coax Loss (dB)	Substitution Antenna (dBd)	dB Below Carrier (dBc)
553.88	V	9.50	0	0	0
1107.75	V	-44.30	1.02	3.38	51.44
1661.63	V	-49.10	1.14	5.08	54.66
2215.50	V	-48.30	1.24	5.95	53.09
2769.38	V	-45.50	1.33	6.97	49.36
3323.25	V	-44.60	1.38	7.41	48.07
3877.13	V	-37.30	1.44	7.63	40.61
4431.00	V	-44.70	1.49	8.17	47.53
4984.88	V	-46.70	1.60	7.67	50.13
5538.75	V	-54.00	1.72	8.40	56.81

APPLICANT: AUDIO TECHNICA CORPORATION

FCC ID: JFZT310C

REPORT #: A\AudioTechnica_JFZ\69UT4\69UT4TestReport.doc

TIMCO ENGINEERING INC.

849 NW State Road 45
Newberry, Florida 32669
<http://www.timcoengr.com>
888.472.2424 F 352.472.2030 email: sid@timcoengr.com

2.1051 **Spurious emissions at antenna terminals (conducted):**
Not Applicable no antenna connector.

2.1053(a)(b) **Field strength of spurious emissions:**

NAME OF TEST: RADIATED SPURIOUS EMISSIONS (566.375 MHz)

REQUIREMENTS: Emissions must be $43 + 10\log(P_o)$ dB below the mean power output of the transmitter.

$$43 + 10\log(0.01) = 23.00 \text{ dB}$$

TEST DATA:

Emission Frequency MHz	Ant. Polarity	Corrected EUT Signal Reading	Coax Loss (dB)	Substitution Antenna (dBd)	dB Below Carrier (dBc)
566.38	V	8.80	0	0	0
1132.75	V	-46.60	1.03	3.48	52.95
1699.13	V	-52.60	1.14	5.11	57.43
2265.50	V	-51.00	1.25	6.09	54.96
2831.88	H	-43.40	1.33	7.02	46.52
3398.25	V	-37.70	1.39	7.47	40.42
3964.63	V	-30.50	1.45	7.64	33.10
4531.00	H	-49.90	1.51	8.21	51.99
5097.38	V	-45.80	1.62	7.79	48.43
5663.75	H	-56.20	1.77	8.58	58.19

APPLICANT: AUDIO TECHNICA CORPORATION

FCC ID: JFZT310C

REPORT #: A\AudioTechnica_JFZ\69UT4\69UT4TestReport.doc

TIMCO ENGINEERING INC.

849 NW State Road 45

Newberry, Florida 32669

<http://www.timcoengr.com>

888.472.2424 F 352.472.2030 email: sid@timcoengr.com

Method of Measuring Radiated Spurious Emissions

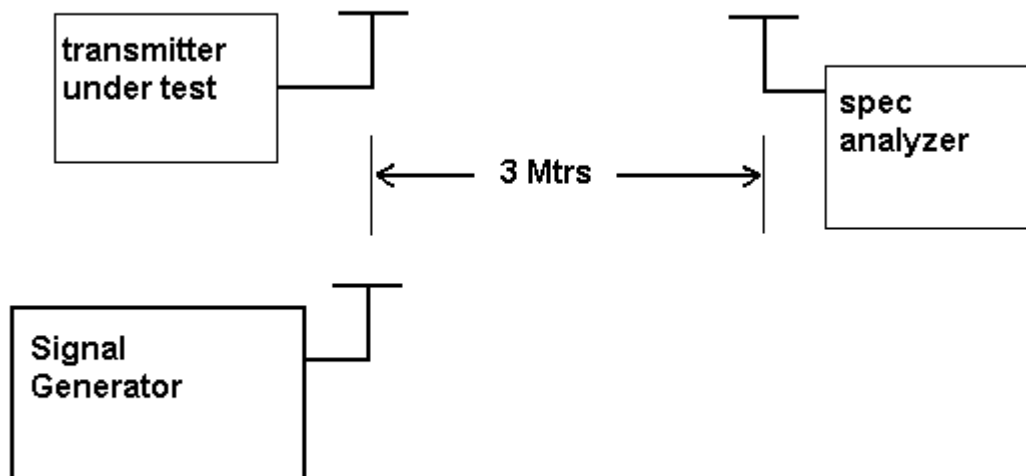

METHOD OF MEASUREMENT: The procedure used was TIA/EIA STANDARD 603. The spectrum was scanned from 30 to at least the tenth harmonic of the fundamental using a HP model 8566B spectrum analyzer and an appropriate antenna. Measurements were made at the open field test site of TIMCO ENGINEERING INC. located at 849 NW SR 45 Newberry, Florida 32669.

APPLICANT: AUDIO TECHNICA CORPORATION

FCC ID: JFZT310C

REPORT #: A\AudioTechnica_JFZ\69UT4\69UT4TestReport.doc

Page 10 of 13

TIMCO ENGINEERING INC.

849 NW State Road 45
Newberry, Florida 32669
<http://www.timcoengr.com>
888.472.2424 F 352.472.2030 email: sid@timcoengr.com

2.1055 Frequency stability: S74.861(e)(4)

Temperature and voltage tests were performed to verify that the frequency remains within the .0050%, (50 ppm)(74.861 e.4) specification limit.

The test was conducted as follows: The transmitter was placed in the temperature chamber at 25 degrees C and allowed to stabilize for one hour. The transmitter was keyed ON for one minute during which four frequency readings were recorded at 15-second intervals. The worse case number was taken for temperature plotting. The assigned channel frequency was considered to be the reference frequency. The temperature was then reduced to -30 degrees C after which the transmitter was again allowed to stabilize for one hour. The transmitter was keyed ON for one minute, and again frequency readings were noted at 15-second intervals. The worst-case number was recorded for temperature plotting. This procedure was repeated in 10-degree increments up to + 50 degrees C.

MEASUREMENT DATA:

Assigned Frequency (Ref. Frequency): 541.501 582

<u>TEMPERATURE °C</u>	<u>FREQUENCY MHz</u>	<u>PPM</u>
-30	541.510 503	16.48
-20	541.510 338	16.17
-10	541.508 919	13.55
0	541.507 067	10.13
10	541.504 788	5.92
20	541.502 318	1.36
30	541.499 746	-3.39
40	541.497 922	-6.76
50	541.496 623	-9.16

	<u>VOLTS</u>	<u>Batt. Data</u>	<u>Batt. PPM</u>
-15%	2.55	541.502 306	1.34

RESULTS OF MEASUREMENTS: The test results indicates that the EUT meets the requirements.

APPLICANT: AUDIO TECHNICA CORPORATION

FCC ID: JFZT310C

REPORT #: A\AudioTechnica_JFZ\69UT4\69UT4TestReport.doc

TIMCO ENGINEERING INC.

849 NW State Road 45
Newberry, Florida 32669
<http://www.timcoengr.com>
888.472.2424 F 352.472.2030 email: sid@timcoengr.com

EMC Equipment List

Device	Manufacturer	Model	Serial Number	Cal/Char Date	Due Date
3/10-Meter OATS	TEI	N/A	N/A	Listed 3/26/01	3/26/04
3-Meter OATS	TEI	N/A	N/A	Listed 1/13/03	1/13/06
AC Voltmeter	HP	400FL	2213A14499	CAL 10/9/01	10/9/03
Blue Tower Quasi-Peak Adapter	HP	85650A	2811A01279	CAL 4/15/03	4/15/05
Blue Tower RF Preselector	HP	85685A	2926A00983	CAL 4/15/03	4/15/05
Blue Tower Spectrum Analyzer	HP	8568B	2928A04729	CAL 4/15/03	4/15/05
Coaxial Cable #64	Semflex Inc.	60637	Timco #64	CHAR 1/24/02	1/24/04
Dipole Antenna Kit	Electro-Metrics	TDA-30/1-4	152	CAL 3/21/01	3/21/04
Dipole Antenna Kit	Electro-Metrics	TDA-30/1-4	153	CAL 9/26/02	9/26/05
Frequency Counter	HP	5385A	2730A03025	CAL 3/7/03	3/7/05
Hygro-Thermometer	Extech	445703	0602	CAL 10/4/02	10/4/04
Log-Periodic Antenna	Electro-Metrics	LPA-25	1122	CAL 10/2/01	10/2/03
Measuring Tape-7.5M	Kraftixx	7.5M		CHAR 2/1/02	2/1/04
Modulation Analyzer	HP	PROFI 8901A	3435A06868	CAL 9/5/01	9/5/03
Multimeter	Fluke	FLUKE-77-3	79510405	CHAR 9/26/01	9/26/03
Silver Tower Preamplifier	HP	8449B	3008A01075	CHAR 1/28/02	1/28/04
Silver Tower Quasi-Peak Adapter	HP	85650A	3303A01844	CAL 10/14/02	10/14/04
Silver Tower RF Preselector	HP	85685A	2620A00294	CAL 10/14/02	10/14/04

APPLICANT: AUDIO TECHNICA CORPORATION

FCC ID: JFZT310C

REPORT #: A\AudioTechnica_JFZ\69UT4\69UT4TestReport.doc

TIMCO ENGINEERING INC.

849 NW State Road 45

Newberry, Florida 32669

<http://www.timcoengr.com>

888.472.2424 F 352.472.2030 email: sid@timcoengr.com

Silver Tower	HP	8566B	3552A22064	CAL	10/14/04
Spectrum Analyzer		Opt 462	3638A08608	10/14/02	
System One	Audio Precision	System One	SYS1-45868	CHAR	4/25/04
Tan Tower Preamplifier	HP	8449B-H02	3008A00372	CAL	9/23/05
Tan Tower Quasi-Peak Adapter	HP	85650A	3303A01690	CAL	9/23/05
Tan Tower RF Preselector	HP	85685A	3221A01400	CAL	9/23/05
Tan Tower Spectrum Analyzer	HP	8566B Opt 462	3138A07786 3144A20661	CAL	9/23/05
Temperature Chamber	Tenney Engineering	TTRC	11717-7	CHAR	1/22/04

APPLICANT: AUDIO TECHNICA CORPORATION

FCC ID: JFZT310C

REPORT #: A\AudioTechnica_JFZ\69UT4\69UT4TestReport.doc

Page 13 of 13