





RADIO TEST REPORT

Test Report No. 14983817H-A-R1

Customer	Audio-Technica Corporation
Description of EUT	Body-Pack Transmitter
Model Number of EUT	ATW-T1401
FCC ID	JFZT1401
Test Regulation	FCC Part 15 Subpart C
Test Result	Complied
Issue Date	January 18, 2024
Remarks	-

Representative Test Engineer	Approved By
	
Tomoya Sone Engineer	Satofumi Matsuyama Engineer
	 
CERTIFICATE 5107.02	
<input type="checkbox"/> The testing in which "Non-accreditation" is displayed is outside the accreditation scopes in UL Japan, Inc.	
<input checked="" type="checkbox"/> There is no testing item of "Non-accreditation".	

Report Cover Page - Form-ULID-003532 (DCS:13-EM-F0429) Issue# 23.0

ANNOUNCEMENT

- This test report shall not be reproduced in full or partial, without the written approval of UL Japan, Inc.
- The results in this report apply only to the sample tested. (Laboratory was not involved in sampling.)
- This sample tested is in compliance with the limits of the above regulation.
- The test results in this test report are traceable to the national or international standards.
- This test report must not be used by the customer to claim product certification, approval, or endorsement by the A2LA accreditation body.
- This test report covers Radio technical requirements.
It does not cover administrative issues such as Manual or non-Radio test related Requirements. (if applicable)
- The all test items in this test report are conducted by UL Japan, Inc. Ise EMC Lab.
- The opinions and the interpretations to the result of the description in this report are outside scopes where UL Japan, Inc. has been accredited.
- The information provided from the customer for this report is identified in Section 1.
- For test report(s) referred in this report, the latest version (including any revisions) is always referred.

REVISION HISTORY

Original Test Report No.: 14983817H-A

This report is a revised version of 14983817H-A. 14983817H-A is replaced with this report.

Revision	Test Report No.	Date	Page Revised Contents
- (Original)	14983817H-A	October 31, 2023	-
1	14983817H-A-R1	January 18, 2024	Cover page, Section 2.1: Identification of EUT, Section 4.2: Configuration and Peripherals -Correction of Description of EUT. Belt-pack type transmitter → Body-Pack Transmitter
1	14983817H-A-R1	January 18, 2024	Section 2.2: Product Description -Correction of Antenna Type. Antenna 1: Pattern Antenna Antenna 2: Wire Antenna → Antenna 1: $\lambda/4$ Monopole PCB Antenna Antenna 2: $\lambda/4$ Monopole Wire Antenna

Reference: Abbreviations (Including words undescribed in this report)

A2LA	The American Association for Laboratory Accreditation	ICES	Interference-Causing Equipment Standard
AC	Alternating Current	IEC	International Electrotechnical Commission
AFH	Adaptive Frequency Hopping	IEEE	Institute of Electrical and Electronics Engineers
AM	Amplitude Modulation	IF	Intermediate Frequency
Amp, AMP	Amplifier	ILAC	International Laboratory Accreditation Conference
ANSI	American National Standards Institute	ISED	Innovation, Science and Economic Development Canada
Ant, ANT	Antenna	ISO	International Organization for Standardization
AP	Access Point	JAB	Japan Accreditation Board
ASK	Amplitude Shift Keying	LAN	Local Area Network
Atten., ATT	Attenuator	LIMS	Laboratory Information Management System
AV	Average	MCS	Modulation and Coding Scheme
BPSK	Binary Phase-Shift Keying	MRA	Mutual Recognition Arrangement
BR	Bluetooth Basic Rate	N/A	Not Applicable
BT	Bluetooth	NIST	National Institute of Standards and Technology
BT LE	Bluetooth Low Energy	NS	No signal detect.
BW	BandWidth	NSA	Normalized Site Attenuation
Cal Int	Calibration Interval	NVLAP	National Voluntary Laboratory Accreditation Program
CCK	Complementary Code Keying	OBW	Occupied Band Width
Ch., CH	Channel	OFDM	Orthogonal Frequency Division Multiplexing
CISPR	Comite International Special des Perturbations Radioelectriques	P/M	Power meter
CW	Continuous Wave	PCB	Printed Circuit Board
DBPSK	Differential BPSK	PER	Packet Error Rate
DC	Direct Current	PHY	Physical Layer
D-factor	Distance factor	PK	Peak
DFS	Dynamic Frequency Selection	PN	Pseudo random Noise
DQPSK	Differential QPSK	PRBS	Pseudo-Random Bit Sequence
DSSS	Direct Sequence Spread Spectrum	PSD	Power Spectral Density
EDR	Enhanced Data Rate	QAM	Quadrature Amplitude Modulation
EIRP, e.i.r.p.	Equivalent Isotropically Radiated Power	QP	Quasi-Peak
EMC	ElectroMagnetic Compatibility	QPSK	Quadri-Phase Shift Keying
EMI	ElectroMagnetic Interference	RBW	Resolution Band Width
EN	European Norm	RDS	Radio Data System
ERP, e.r.p.	Effective Radiated Power	RE	Radio Equipment
EU	European Union	RF	Radio Frequency
EUT	Equipment Under Test	RMS	Root Mean Square
Fac.	Factor	RSS	Radio Standards Specifications
FCC	Federal Communications Commission	Rx	Receiving
FHSS	Frequency Hopping Spread Spectrum	SA, S/A	Spectrum Analyzer
FM	Frequency Modulation	SG	Signal Generator
Freq.	Frequency	SVSWR	Site-Voltage Standing Wave Ratio
FSK	Frequency Shift Keying	TR	Test Receiver
GFSK	Gaussian Frequency-Shift Keying	Tx	Transmitting
GNSS	Global Navigation Satellite System	VBW	Video BandWidth
GPS	Global Positioning System	Vert.	Vertical
Hori.	Horizontal	WLAN	Wireless LAN

CONTENTS	PAGE
SECTION 1: Customer Information	5
SECTION 2: Equipment Under Test (EUT).....	5
SECTION 3: Test Specification, Procedures & Results	6
SECTION 4: Operation of EUT during testing	9
SECTION 5: Radiated Spurious Emission.....	11
SECTION 6: Antenna Terminal Conducted Tests	13
APPENDIX 1: Test Data	14
99 % Occupied Bandwidth and 6 dB Bandwidth.....	14
Maximum Peak Output Power	16
Average Output Power.....	17
Radiated Spurious Emission.....	19
Conducted Spurious Emission.....	31
Power Density	33
APPENDIX 2: Test Instruments	35
APPENDIX 3: Photographs of Test Setup	37
Radiated Spurious Emission.....	37
Worst Case Position	38
Antenna Terminal Conducted Tests	39

SECTION 1: Customer Information

Company Name	Audio-Technica Corporation
Address	2-46-1 Nishi-naruse, Machida, Tokyo 194-8666, Japan
Telephone Number	+81-42-739-9121
Contact Person	Hirohisa Yamamoto

The information provided from the customer is as follows;

- Customer, Description of EUT, Model Number of EUT, FCC ID on the cover and other relevant pages
- Operating/Test Mode(s) (Mode(s)) on all the relevant pages
- SECTION 1: Customer Information
- SECTION 2: Equipment Under Test (EUT) other than the Receipt Date and Test Date
- SECTION 4: Operation of EUT during testing

* The laboratory is exempted from liability of any test results affected from the above information in SECTION 2 and 4.

SECTION 2: Equipment Under Test (EUT)

2.1 Identification of EUT

Description	Body-Pack Transmitter
Model Number	ATW-T1401
Serial Number	Refer to SECTION 4.2
Condition	Production prototype (Not for Sale: This sample is equivalent to mass-produced items.)
Modification	No Modification by the test lab
Receipt Date	September 26, 2023
Test Date	September 27 to October 1, 2023

2.2 Product Description

General Specification

Rating	DC 3.0 V (Battery)
Operating temperature	5 deg. C to 40 deg. C

Radio Specification

Equipment Type	Transceiver
Frequency of Operation	2402 MHz to 2480 MHz
Type of Modulation	GFSK
Antenna Type	Antenna 1: $\lambda/4$ Monopole PCB Antenna Antenna 2: $\lambda/4$ Monopole Wire Antenna
Antenna Gain	Antenna 1: 2.79 dBi Antenna 2: -0.06 dBi

SECTION 3: Test Specification, Procedures & Results

3.1 Test Specification

Test Specification	FCC Part 15 Subpart C The latest version on the first day of the testing period
Title	FCC 47 CFR Part 15 Radio Frequency Device Subpart C Intentional Radiators Section 15.207 Conducted limits Section 15.247 Operation within the bands 902-928 MHz, 2400-2483.5 MHz, and 5725-5850 MHz

* Also the EUT complies with FCC Part 15 Subpart B.

3.2 Procedures and Results

Item	Test Procedure	Specification	Worst Margin	Results	Remarks
Conducted Emission	FCC: ANSI C63.10-2013 6. Standard test methods ISED: RSS-Gen 8.8	FCC: Section 15.207 ISED: RSS-Gen 8.8	N/A	N/A	*1)
6dB Bandwidth	FCC: KDB 558074 D01 15.247 Meas Guidance v05r02 ISED: -	FCC: Section 15.247(a)(2) ISED: RSS-247 5.2(a)	See data.	Complied	Conducted
Maximum Peak Output Power	FCC: KDB 558074 D01 15.247 Meas Guidance v05r02 ISED: RSS-Gen 6.12	FCC: Section 15.247(b)(3) ISED: RSS-247 5.4(d)		Complied	Conducted
Power Density	FCC: KDB 558074 D01 15.247 Meas Guidance v05r02 ISED: -	FCC: Section 15.247(e) ISED: RSS-247 5.2(b)		Complied	Conducted
Spurious Emission Restricted Band Edges	FCC: KDB 558074 D01 15.247 Meas Guidance v05r02 ISED: RSS-Gen 6.13	FCC: Section 15.247(d) ISED: RSS-247 5.5 RSS-Gen 8.9 RSS-Gen 8.10	1.6 dB 2483.5 MHz, AV, Horizontal	Complied	Conducted (below 30 MHz)/ Radiated (above 30 MHz) *2)

Note: UL Japan, Inc.'s EMI Work Procedures: Work Instructions-ULID-003591 and Work Instructions-ULID-003593.

* In case any questions arise about test procedure, ANSI C63.10: 2013 is also referred.

*1) The test is not applicable since the EUT is a battery operated device.

*2) Radiated test was selected over 30 MHz based on section 15.247(d) and KDB 558074 D01 15.247 Meas Guidance v05r02 8.5 and 8.6.

FCC Part 15.31 (e)

This EUT provides the stable voltage constantly to RF Part regardless of input voltage. Therefore, this EUT complies with the requirement.

FCC Part 15.203 Antenna requirement

It is impossible for end users to replace the antenna, because the antenna is mounted inside of the EUT. Therefore, the equipment complies with the antenna requirement of Section 15.203.

3.3 Addition to Standard

Item	Test Procedure	Specification	Worst Margin	Results	Remarks
99% Occupied Bandwidth	ISED: RSS-Gen 6.7	ISED: -	N/A	-	Conducted

Other than above, no addition, exclusion nor deviation has been made from the standard.

3.4 Uncertainty

Measurement uncertainty is not taken into account when stating conformity with a specified requirement. Note: When margins obtained from test results are less than the measurement uncertainty, the test results may exceed the limit.

The following uncertainties have been calculated to provide a confidence level of 95 % using a coverage factor $k = 2$.

Radiated emission

Measurement distance	Frequency Range		Unit	Calculated Uncertainty (+/-)
3 m	9 kHz to 30 MHz		dB	3.3
10 m			dB	3.1
3 m	30 MHz to 200 MHz	Horizontal	dB	4.8
		Vertical	dB	5.0
	200 MHz to 1000 MHz	Horizontal	dB	5.1
		Vertical	dB	6.2
10 m	30 MHz to 200 MHz	Horizontal	dB	4.8
		Vertical	dB	4.8
	200 MHz to 1000 MHz	Horizontal	dB	4.9
		Vertical	dB	5.0
3 m	1 GHz to 6 GHz		dB	4.9
	6 GHz to 18 GHz		dB	5.2
1 m	10 GHz to 26.5 GHz		dB	5.5
	26.5 GHz to 40 GHz		dB	5.4
10 m	1 GHz to 18 GHz		dB	5.3

Antenna Terminal Conducted Tests

Item	Unit	Calculated Uncertainty (+/-)
Antenna Terminated Conducted Emission / Power Density / Burst Power	dB	3.28
Adjacent Channel Power (ACP)	dB	2.27
Bandwidth (OBW)	%	0.96
Time Readout (Time span upto 100 msec)	%	0.11
Time Readout (Time span upto 1000 msec)	%	0.11
Time Readout (Time span upto 60 sec)	%	0.02
Power Measurement (Power meter)	dB	1.50
Frequency Readout (Frequency counter)	ppm	0.67
Frequency Readout (Spectrum analyzer frequency readout function)	ppm	1.61
Temperature (Constant temperature bath)	deg. C	0.78
Humidity (Constant temperature bath)	%RH	2.80
Modulation Characteristics	%	6.93
Frequency for Mobile	ppm	0.08

3.5 Test Location

UL Japan, Inc. Ise EMC Lab.

4383-326 Asama-cho, Ise-shi, Mie-ken 516-0021 Japan

Telephone: +81-596-24-8999

A2LA Certificate Number: 5107.02 / FCC Test Firm Registration Number: 884919

ISED Lab Company Number: 2973C / CAB identifier: JP0002

Test site	Width x Depth x Height (m)	Size of reference ground plane (m) / horizontal conducting plane	Other rooms	Maximum measurement distance
No.1 semi-anechoic chamber	19.2 x 11.2 x 7.7	7.0 x 6.0	No.1 Power source room	10 m
No.2 semi-anechoic chamber	7.5 x 5.8 x 5.2	4.0 x 4.0	-	3 m
No.3 semi-anechoic chamber	12.0 x 8.5 x 5.9	6.8 x 5.75	No.3 Preparation room	3 m
No.3 shielded room	4.0 x 6.0 x 2.7	N/A	-	-
No.4 semi-anechoic chamber	12.0 x 8.5 x 5.9	6.8 x 5.75	No.4 Preparation room	3 m
No.4 shielded room	4.0 x 6.0 x 2.7	N/A	-	-
No.5 semi-anechoic chamber	6.0 x 6.0 x 3.9	6.0 x 6.0	-	-
No.5 measurement room	6.4 x 6.4 x 3.0	6.4 x 6.4	-	-
No.6 shielded room	4.0 x 4.5 x 2.7	4.0 x 4.5	-	-
No.6 measurement room	4.75 x 5.4 x 3.0	4.75 x 4.15	-	-
No.7 shielded room	4.7 x 7.5 x 2.7	4.7 x 7.5	-	-
No.8 measurement room	3.1 x 5.0 x 2.7	3.1 x 5.0	-	-
No.9 measurement room	8.8 x 4.6 x 2.8	2.4 x 2.4	-	-
No.10 shielded room	3.8 x 2.8 x 2.8	3.8 x 2.8	-	-
No.11 measurement room	4.0 x 3.4 x 2.5	N/A	-	-
No.12 measurement room	2.6 x 3.4 x 2.5	N/A	-	-
Large Chamber	16.9 x 22.1 x 10.17	16.9 x 22.1	-	10 m
Small Chamber	5.3 x 6.69 x 3.59	5.3 x 6.69	-	-

SECTION 4: Operation of EUT during testing

4.1 Operating Mode(s)

*The Details of Operating Mode(s)

Test Item	Operating Mode	Tested Antenna	Tested Frequency
Radiated Spurious Emission (Below 1 GHz)	Tx Transmitting	Antenna 1 Antenna 2	2402 MHz *1)
Maximum Peak Output Power, Radiated Spurious Emission (Above 1 GHz), Conducted Spurious Emission	Tx Transmitting	Antenna 1 Antenna 2	2402 MHz 2441 MHz 2480 MHz
6dB Bandwidth, 99% Occupied Bandwidth, Power Density	Tx Transmitting	Antenna 2 *2)	2402 MHz 2441 MHz 2480 MHz
*1) The Frequency was tested as a representative, because it had the highest power at antenna terminal test.			
*2) After the comparison between Antenna 1 and Antenna 2, test was performed with the antenna that had higher power as a representative.			
*Power of the EUT was set by the software as follows; Power Setting: 4 dBm Software: System20 Control (Date: September 27, 2023 Storage location: Driven by connected PC)			
*This setting of software is the worst case. Any conditions under the normal use do not exceed the condition of setting. In addition, end users cannot change the settings of the output power of the product.			

4.2 Configuration and Peripherals

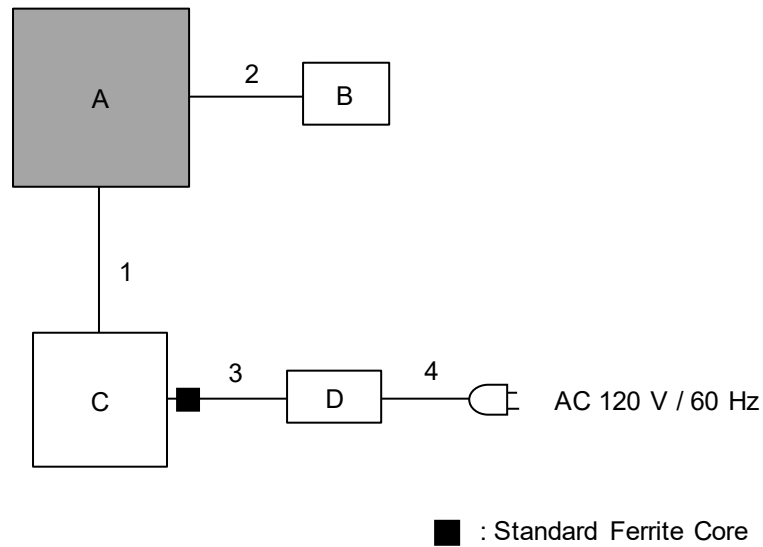

* Cabling and setup(s) were taken into consideration and test data was taken under worse case conditions.

Description of EUT and Support Equipment

No.	Item	Model number	Serial Number	Manufacturer	Remarks
A	Body-Pack Transmitter	ATW-T1401	23300023 *1) 23300022 *2)	Audio-Technica Corporation	EUT
B	Microphone	MT830cW	-	Audio-Technica Corporation	-
C	Laptop PC	X1 Carbon	R9-OH8TU 15/9	LENOVO	*1)
		CF-NX1GWWGYS	2KKSA14614	Panasonic	*2)
D	AC Adapter	ADLX45NCC2A	8SSA10E75794C 1SG59R0GHF	LENOVO	*1)
		CF-AA6412C	6412CM112714770A	Panasonic	*2)

List of Cables Used

No.	Name	Length (m)	Shield		Remarks
			Cable	Connector	
1	USB Cable	1.5	Shielded	Shielded	-
2	Signal Cable	1.5	Unshielded	Unshielded	-
3	DC Cable	1.7 *1) 0.9 *2)	Unshielded	Unshielded	-
4	AC Cable	1.0 *1) 0.8 *2)	Unshielded	Unshielded	-

*1) Used for Antenna Terminal conducted test

*2) Used for Radiated Emission test

SECTION 5: Radiated Spurious Emission

Test Procedure

It was measured based on "8.5 and 8.6 of KDB 558074 D01 15.247 Meas Guidance v05r02".

[For below 1 GHz]

EUT was placed on a urethane platform of nominal size, 1.0 m by 1.5 m, raised 0.8 m above the conducting ground plane. The Radiated Electric Field Strength has been measured in a Semi Anechoic Chamber with a ground plane.

[For above 1 GHz]

EUT was placed on a urethane platform of nominal size, 0.5 m by 0.5 m, raised 1.5 m above the conducting ground plane. The Radiated Electric Field Strength has been measured in a Semi Anechoic Chamber with absorbent materials lined on a ground plane. Test antenna was aimed at the EUT for receiving the maximum signal and always kept within the illumination area of the 3 dB beamwidth of the antenna.

The height of the measuring antenna varied between 1 m and 4 m and EUT was rotated a full revolution in order to obtain the maximum value of the electric field strength.

The measurements were performed for both vertical and horizontal antenna polarization with the Test Receiver, or the Spectrum Analyzer.

The measurements were made with the following detector function of the test receiver and the Spectrum analyzer (in linear mode).

The test was made with the detector (RBW/VBW) in the following table.

When using Spectrum analyzer, the test was made with adjusting span to zero by using peak hold.

Test Antennas are used as below;

Frequency	30 MHz to 200 MHz	200 MHz to 1 GHz	Above 1 GHz
Antenna Type	Biconical	Logperiodic	Horn

In any 100 kHz bandwidth outside the restricted band in which the spread spectrum intentional radiator is operating, the radio frequency power that is produced by the intentional radiator confirmed 20 dB below that in the 100 kHz bandwidth within the band that contains the highest level of the desired power, based on a radiated measurement.

20 dBc was applied to the frequency over the limit of FCC 15.209 / Table 4 of RSS-Gen 8.9(ISED) and outside the restricted band of FCC15.205 / Table 6 of RSS-Gen 8.10 (ISED).

Frequency	Below 1 GHz	Above 1 GHz		20 dBc
Instrument Used	Test Receiver	Spectrum Analyzer		Spectrum Analyzer
Detector	QP	PK	AV	PK
IF Bandwidth	BW 120 kHz	RBW: 1 MHz VBW: 3 MHz	11.12.2.5.1 RBW: 1 MHz VBW: 3 MHz Detector: Power Averaging (RMS) Trace: 100 traces 11.12.2.5.2 The duty cycle was less than 98% for detected noise, a duty factor was added to the 11.12.2.5.1 results.	RBW: 100 kHz VBW: 300 kHz

Figure 2: Test Setup

Below 1 GHz

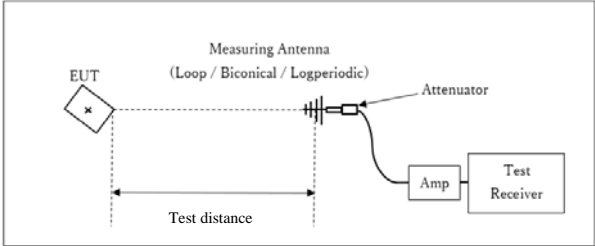

× : Center of turn table

Test Distance: 3 m

1 GHz to 10 GHz

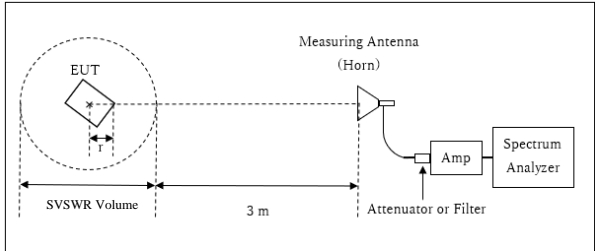

r : Radius of an outer periphery of EUT
 × : Center of turn table

Distance Factor: $20 \times \log(3.95 \text{ m} / 3.0 \text{ m}) = 2.39 \text{ dB}$
 * Test Distance: $(3 + \text{SVSWR Volume} / 2) - r = 3.95 \text{ m}$

SVSWR Volume : 2.0 m
 (SVSWR Volume has been calibrated based on CISPR 16-1-4.)
 r = 0.05 m

10 GHz to 26.5 GHz

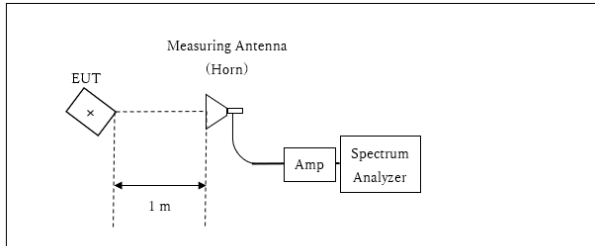

× : Center of turn table

Distance Factor: $20 \times \log(1.0 \text{ m} / 3.0 \text{ m}) = -9.5 \text{ dB}$
 *Test Distance: 1 m

The carrier level and noise levels were confirmed at each position of X, Y and Z axes of EUT to see the position of maximum noise, and the test was made at the position that has the maximum noise.

The test results and limit are rounded off to one decimal place, so some differences might be observed.

Measurement Range : 30 MHz to 26.5 GHz
 Test Data : APPENDIX
 Test Result : Pass

SECTION 6: Antenna Terminal Conducted Tests

Test Procedure

The tests were made with below setting connected to the antenna port.

Test	Span	RBW	VBW	Sweep time	Detector	Trace	Instrument Used
6dB Bandwidth	3 MHz	100 kHz	300 kHz	Auto	Peak	Max Hold	Spectrum Analyzer
99% Occupied Bandwidth *1)	Enough width to display emission skirts	1 to 5 % of OBW	Three times of RBW	Auto	Peak	Max Hold	Spectrum Analyzer
Maximum Peak Output Power	-	-	-	Auto	Peak/Average *2)	-	Power Meter (Sensor: 50 MHz BW)
Peak Power Density	1.5 times the 6dB Bandwidth	3 kHz	10 kHz	Auto	Peak	Max Hold	Spectrum Analyzer *3)
Conducted Spurious Emission *4) *5)	9 kHz to 150 kHz	200 Hz	620 Hz	Auto	Peak	Max Hold	Spectrum Analyzer
	150 kHz to 30 MHz	10 kHz	30 kHz				

*1) Peak hold was applied as Worst-case measurement.

*2) Reference data

*3) Section 11.10.2 Method PKPSD (peak PSD) of "ANSI C63.10-2013".

*4) In the frequency range below 30MHz, RBW was narrowed to separate the noise contents.

Then, wide-band noise near the limit was checked separately, however the noise was not detected as shown in the chart.

(9 kHz - 150 kHz: RBW = 200 Hz, 150 kHz - 30 MHz: RBW = 10 kHz)

*5) The limits in CFR 47, Part 15, Subpart C, paragraph 15.209(a), are identical to those in RSS-Gen section 8.9, Table 6, since the measurements are performed in terms of magnetic field strength and converted to electric field strength levels (as reported in the table) using the free space impedance of 377 Ohms. For example, the measurement at frequency 9 kHz resulted in a level of 45.5 dBuV/m, which is equivalent to $45.5 - 51.5 = -6.0$ dBuA/m, which has the same margin, 3 dB, to the corresponding RSS-Gen Table 6 limit as it has to 15.209(a) limit.

The test results and limit are rounded off to two decimals place, so some differences might be observed. The equipment and cables were not used for factor 0 dB of the data sheets.

Test Data : APPENDIX
Test Result : Pass

APPENDIX 1: Test Data

99 % Occupied Bandwidth and 6 dB Bandwidth

Test place Ise EMC Lab. No.4 Measurement Room
Date September 27, 2023
Temperature / Humidity 23 deg. C / 61 % RH
Engineer Tomoya Sone
Mode Tx Antenna 2

Frequency [MHz]	99% Occupied Bandwidth [kHz]	6dB Bandwidth [MHz]	Limit for 6dB Bandwidth [MHz]
2402	1035.0	0.710	> 0.5000
2441	1044.2	0.716	> 0.5000
2480	1034.8	0.698	> 0.5000

99 % Occupied Bandwidth and 6 dB Bandwidth

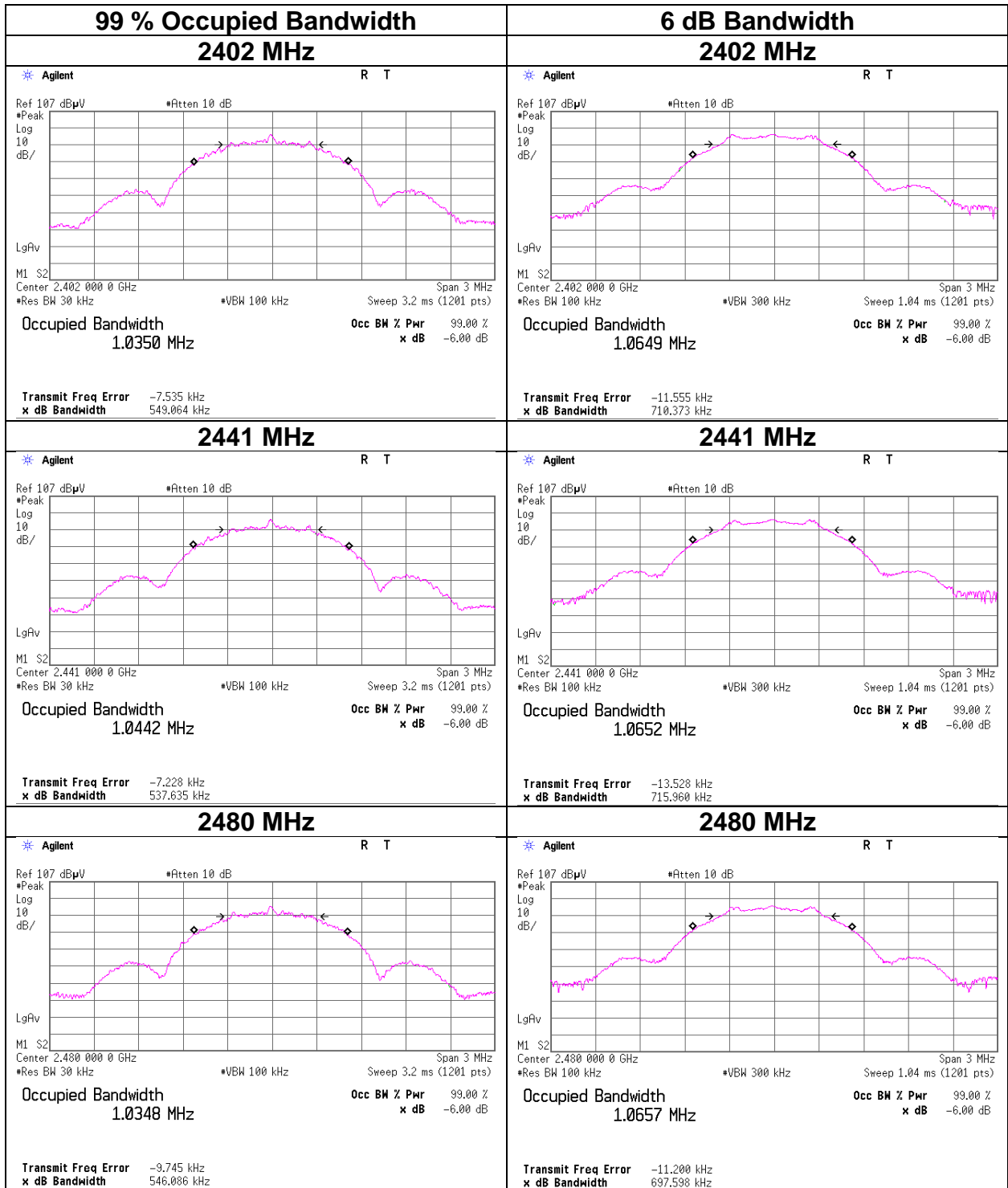

Maximum Peak Output Power

Test place Ise EMC Lab. No.4 Measurement Room
Date September 27, 2023
Temperature / Humidity 23 deg. C / 61 % RH
Engineer Tomoya Sone
Mode Tx

Antenna 1				Conducted Power					e.i.r.p. for RSS-247					
Freq. [MHz]	Reading [dBm]	Cable Loss [dB]	Atten. Loss [dB]	Result		Limit		Margin [dB]	Antenna Gain [dBi]	Result		Limit		Margin [dB]
				[dBm]	[mW]	[dBm]	[mW]			[dBm]	[mW]	[dBm]	[mW]	
2402	-3.55	1.42	9.74	7.61	5.77	30.00	1000	22.39	2.79	10.40	10.96	36.02	4000	25.62
2441	-3.71	1.44	9.75	7.48	5.60	30.00	1000	22.52	2.79	10.27	10.64	36.02	4000	25.75
2480	-3.98	1.46	9.75	7.23	5.28	30.00	1000	22.77	2.79	10.02	10.05	36.02	4000	26.00

Antenna 2				Conducted Power					e.i.r.p. for RSS-247					
Freq. [MHz]	Reading [dBm]	Cable Loss [dB]	Atten. Loss [dB]	Result		Limit		Margin [dB]	Antenna Gain [dBi]	Result		Limit		Margin [dB]
				[dBm]	[mW]	[dBm]	[mW]			[dBm]	[mW]	[dBm]	[mW]	
2402	-3.42	1.46	9.74	7.78	6.00	30.00	1000	22.22	-0.06	7.72	5.92	36.02	4000	28.30
2441	-3.60	1.48	9.75	7.63	5.79	30.00	1000	22.37	-0.06	7.57	5.71	36.02	4000	28.45
2480	-4.02	1.50	9.75	7.23	5.28	30.00	1000	22.77	-0.06	7.17	5.21	36.02	4000	28.85

Sample Calculation:

Result = Reading + Cable Loss + Attenuator Loss

e.i.r.p. Result = Conducted Power Result + Antenna Gain

*The equipment and cables were not used for factor 0 dB of the data sheets.

Average Output Power (Reference data for RF Exposure)

Test place	Ise EMC Lab. No.4 Measurement Room
Date	September 27, 2023
Temperature / Humidity	23 deg. C / 61 % RH
Engineer	Tomoya Sone
Mode	Tx

Antenna 1

Freq. [MHz]	Reading [dBm]	Cable Loss [dB]	Atten. Loss [dB]	Result (Time average)		Duty factor [dB]	Result (Burst power average)	
				[dBm]	[mW]		[dBm]	[mW]
2402	-7.21	1.42	9.74	3.95	2.48	3.51	7.46	5.57
2441	-7.38	1.44	9.75	3.81	2.40	3.51	7.32	5.40
2480	-7.67	1.46	9.75	3.54	2.26	3.51	7.05	5.07

Antenna 2

Freq. [MHz]	Reading [dBm]	Cable Loss [dB]	Atten. Loss [dB]	Result (Time average)		Duty factor [dB]	Result (Burst power average)	
				[dBm]	[mW]		[dBm]	[mW]
2402	-7.08	1.46	9.74	4.12	2.58	3.51	7.63	5.79
2441	-7.25	1.48	9.75	3.98	2.50	3.51	7.49	5.61
2480	-7.70	1.50	9.75	3.55	2.26	3.51	7.06	5.08

Sample Calculation:

Result (Time average) = Reading + Cable Loss + Attenuator Loss

Result (Burst power average) = Time average + Duty factor

*The equipment and cables were not used for factor 0 dB of the data sheets.

Burst rate confirmation

Test place Ise EMC Lab. No.4 Semi Anechoic Chamber
 Date September 27, 2023
 Temperature / Humidity 20 deg. C / 42 % RH
 Engineer Nachi Konegawa
 Mode Tx

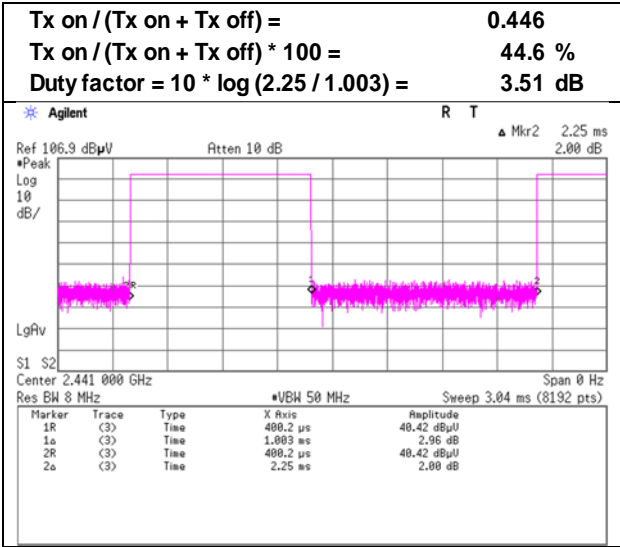

* Since the burst rate is not different between the channels, the data has been obtained on the representative channel.

Radiated Spurious Emission

Test place	Ise EMC Lab.			
Semi Anechoic Chamber	No.4	No.4	No.4	No.4
Date	September 27, 2023	September 28, 2023	September 29, 2023	October 1, 2023
Temperature / Humidity	20 deg. C / 42 % RH	20 deg. C / 44 % RH	22 deg. C / 55 % RH	23 deg. C / 54 % RH
Engineer	Nachi Konegawa	Nachi Konegawa	Yuta Moriya	Sayaka Hara
	(1 GHz to 10 GHz)	(10 GHz to 18 GHz)	(Above 18 GHz)	(Below 1 GHz)
Mode	Tx 2402 MHz Antenna 1			

Polarity	Frequency	Reading (QP / PK)	Reading (AV)	Ant. Factor	Loss	Gain	Duty Factor	Result (QP / PK)	Result (AV)	Limit (QP / PK)	Limit (AV)	Margin (QP / PK)	Margin (AV)	Remark
[Hori/Vert]	[MHz]	[dBuV]	[dBuV]	[dB/m]	[dB]	[dB]	[dB]	[dBuV/m]	[dBuV/m]	[dBuV/m]	[dBuV/m]	[dB]	[dB]	
Hori.	150.1	31.2	-	15.0	8.4	32.0	-	22.6	-	43.5	-	21.0	-	
Hori.	297.3	31.2	-	13.7	9.7	32.0	-	22.6	-	46.0	-	23.4	-	
Hori.	320.9	33.9	-	14.5	9.8	32.0	-	26.1	-	46.0	-	19.9	-	
Hori.	453.0	31.3	-	16.7	10.5	32.2	-	26.3	-	46.0	-	19.7	-	
Hori.	553.8	28.6	-	18.0	11.1	32.2	-	25.5	-	46.0	-	20.6	-	
Hori.	753.4	27.1	-	20.3	11.8	32.0	-	27.2	-	46.0	-	18.8	-	
Hori.	2390.0	52.8	37.1	27.8	5.4	32.0	3.5	54.0	41.7	73.9	53.9	19.9	12.2	*1)
Hori.	4804.0	43.0	33.8	31.3	7.5	31.2	3.5	50.6	44.9	73.9	53.9	23.3	9.0	
Hori.	7206.0	42.5	34.1	36.4	8.7	32.4	-	55.3	46.8	73.9	53.9	18.6	7.1	Floor noise
Hori.	9608.0	42.9	32.5	38.0	9.1	32.5	-	57.5	47.2	73.9	53.9	16.4	6.7	Floor noise
Hori.	12010.0	47.3	38.0	39.1	-2.0	32.8	3.5	51.7	45.9	73.9	53.9	22.2	8.0	
Hori.	16814.0	42.2	34.9	40.1	-0.6	32.5	-	49.2	42.0	73.9	53.9	24.7	11.9	Floor noise
Vert.	45.3	33.9	-	12.9	7.3	32.1	-	22.0	-	40.0	-	18.0	-	
Vert.	124.8	39.4	-	13.4	8.1	32.0	-	28.9	-	43.5	-	14.7	-	
Vert.	296.2	34.6	-	13.7	9.7	32.0	-	26.0	-	46.0	-	20.0	-	
Vert.	322.1	36.6	-	14.5	9.8	32.0	-	28.9	-	46.0	-	17.1	-	
Vert.	452.1	39.9	-	16.7	10.5	32.2	-	34.9	-	46.0	-	11.1	-	
Vert.	754.2	29.7	-	20.3	11.8	32.0	-	29.8	-	46.0	-	16.2	-	
Vert.	2390.0	51.4	36.3	27.8	5.4	32.0	3.5	52.5	41.0	73.9	53.9	21.4	12.9	*1)
Vert.	4804.0	43.0	33.8	31.3	7.5	31.2	3.5	50.6	44.9	73.9	53.9	23.3	9.0	
Vert.	7206.0	42.5	34.1	36.4	8.7	32.4	-	55.3	46.8	73.9	53.9	18.6	7.1	Floor noise
Vert.	9608.0	42.9	32.5	38.0	9.1	32.5	-	57.5	47.2	73.9	53.9	16.4	6.7	Floor noise
Vert.	12010.0	44.5	35.5	39.1	-2.0	32.8	3.5	48.9	43.4	73.9	53.9	25.0	10.5	
Vert.	16814.0	42.2	34.9	40.1	-0.6	32.5	-	49.2	42.0	73.9	53.9	24.7	11.9	Floor noise

Result (QP / PK) = Reading + Ant Factor + Loss (Cable+Attenuator+Filter+Distance factor(above 1 GHz)) - Gain(Amplifier)
 Result (AV) = Reading + Ant Factor + Loss (Cable+Attenuator+Filter+Distance factor(above 1 GHz)) - Gain(Amplifier) + Duty factor
 *Other frequency noises omitted in this report were not seen or had enough margin (more than 20 dB).
 *QP detector was used up to 1GHz
 *1) Not Out of Band emission(Leakage Power)

20dBc Data Sheet

Polarity	Frequency	Reading (PK)	Ant. Factor	Loss	Gain	Result	Limit	Margin	Remark
[Hori/Vert]	[MHz]	[dBuV]	[dB/m]	[dB]	[dB]	[dBuV/m]	[dBuV/m]	[dB]	
Hori.	2402.0	100.5	27.8	5.4	32.0	101.6	-	-	Carrier
Hori.	2400.0	54.0	27.8	5.4	32.0	55.1	81.6	26.5	
Hori.	14412.0	55.4	40.7	-1.1	32.3	62.7	81.6	18.9	
Vert.	2402.0	99.4	27.8	5.4	32.0	100.6	-	-	Carrier
Vert.	2400.0	52.8	27.8	5.4	32.0	53.9	80.6	26.6	
Vert.	14412.0	55.2	40.7	-1.1	32.3	62.5	80.6	18.1	

Result = Reading + Ant Factor + Loss (Cable+Attenuator+Filter+Distance factor(above 1 GHz)) - Gain(Amplifier)
 Distance factor: 1 GHz - 10 GHz 20log (3.95 m / 3.0 m) = 2.39 dB
 10 GHz - 26.5 GHz 20log (1.0 m / 3.0 m) = -9.5 dB

**Radiated Spurious Emission
 (Reference Plot for band-edge)**

Test place	Ise EMC Lab.
Semi Anechoic Chamber	No.4
Date	September 27, 2023
Temperature / Humidity	20 deg. C / 42 % RH
Engineer	Nachi Konegawa
	(1 GHz to 10 GHz)
Mode	Tx 2402 MHz Antenna 1

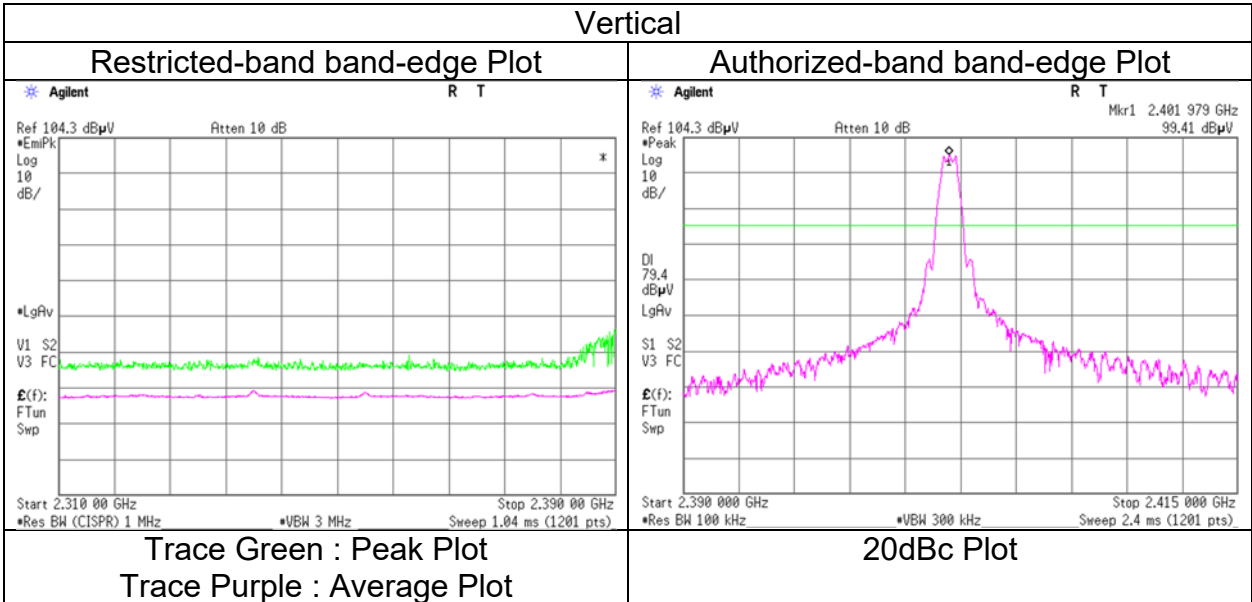
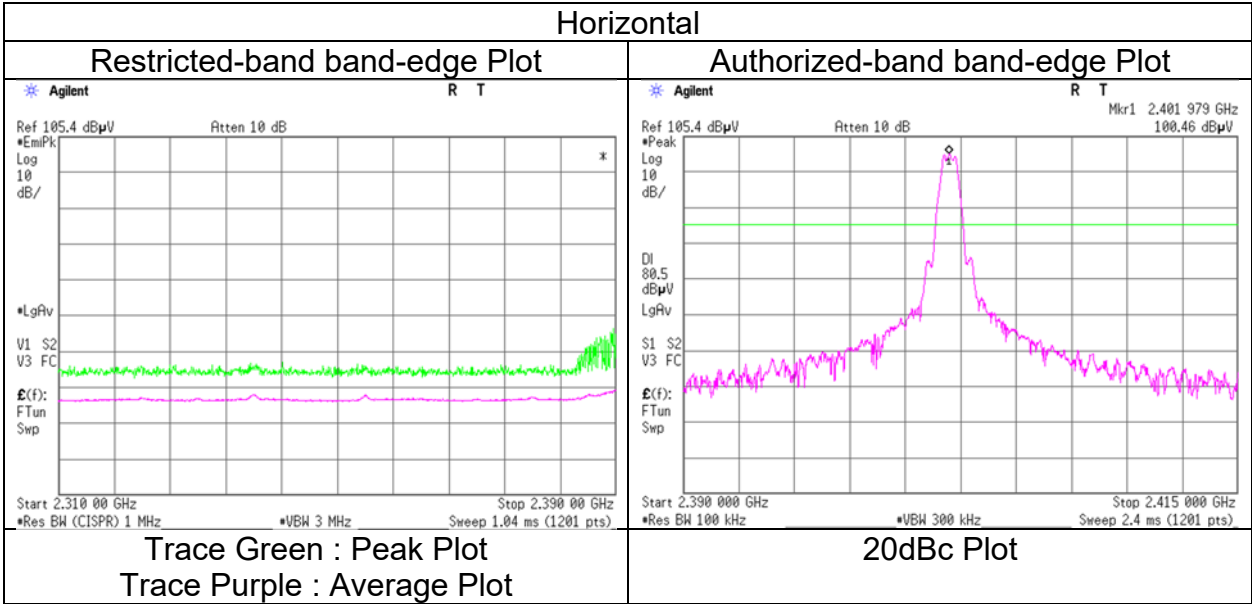

* The measurement was conducted for a sufficiently long enough time to detect any possible spurious emissions.
 Final result of restricted band edge and authorized band edge were shown in tabular data.

Radiated Spurious Emission

Test place	Ise EMC Lab.		
Semi Anechoic Chamber	No.4	No.4	No.4
Date	September 27, 2023	September 28, 2023	September 29, 2023
Temperature / Humidity	20 deg. C / 42 % RH	20 deg. C / 44 % RH	22 deg. C / 55 % RH
Engineer	Nachi Konegawa (1 GHz to 10 GHz)	Nachi Konegawa (10 GHz to 18 GHz)	Yuta Moriya (Above 18 GHz)
Mode	Tx 2441 MHz Antenna 1		

Polarity	Frequency	Reading (QP / PK)	Reading (AV)	Ant. Factor	Loss	Gain	Duty Factor	Result (QP / PK)	Result (AV)	Limit (QP / PK)	Limit (AV)	Margin (QP / PK)	Margin (AV)	Remark
[Hori/Vert]	[MHz]	[dBuV]	[dBuV]	[dB/m]	[dB]	[dB]	[dB]	[dBuV/m]	[dBuV/m]	[dBuV/m]	[dBuV/m]	[dB]	[dB]	
Hori.	4882.0	44.2	35.4	31.4	7.5	31.1	3.5	51.9	46.7	73.9	53.9	22.0	7.2	
Hori.	7323.0	42.8	33.8	36.6	8.7	32.4	-	55.6	46.7	73.9	53.9	18.3	7.2	Floor noise
Hori.	9764.0	42.4	31.4	38.4	9.2	32.6	-	57.4	46.4	73.9	53.9	16.5	7.5	Floor noise
Hori.	12205.0	45.4	36.4	39.0	-1.9	32.7	3.5	49.8	44.3	73.9	53.9	24.1	9.6	
Hori.	17087.0	42.7	35.0	40.8	-0.5	32.5	-	50.6	42.8	73.9	53.9	23.3	11.1	Floor noise
Vert.	4882.0	43.9	34.6	31.4	7.5	31.1	3.5	51.6	45.8	73.9	53.9	22.3	8.1	
Vert.	7323.0	42.8	33.8	36.6	8.7	32.4	-	55.6	46.7	73.9	53.9	18.3	7.2	Floor noise
Vert.	9764.0	42.4	31.4	38.4	9.2	32.6	-	57.4	46.4	73.9	53.9	16.5	7.5	Floor noise
Vert.	12205.0	43.4	35.2	39.0	-1.9	32.7	3.5	47.8	43.1	73.9	53.9	26.1	10.8	
Vert.	17087.0	42.7	35.0	40.8	-0.5	32.5	-	50.6	42.8	73.9	53.9	23.3	11.1	Floor noise

Result (QP / PK) = Reading + Ant Factor + Loss (Cable+Attenuator+Filter+Distance factor(above 1 GHz)) - Gain(Amplifier)
 Result (AV) = Reading + Ant Factor + Loss (Cable+Attenuator+Filter+Distance factor(above 1 GHz)) - Gain(Amplifier) + Duty factor
 *Other frequency noises omitted in this report were not seen or had enough margin (more than 20 dB).
 *QP detector was used up to 1GHz.

20dBc Data Sheet

Polarity	Frequency	Reading (PK)	Ant. Factor	Loss	Gain	Result	Limit	Margin	Remark
[Hori/Vert]	[MHz]	[dBuV]	[dB/m]	[dB]	[dB]	[dBuV/m]	[dBuV/m]	[dB]	
Hori.	2441.0	99.3	27.8	5.4	32.0	100.5	-	-	Carrier
Hori.	14646.0	55.0	40.4	-1.0	32.3	62.1	80.5	18.4	
Vert.	2441.0	98.8	27.8	5.4	32.0	100.0	-	-	Carrier
Vert.	14646.0	54.2	40.4	-1.0	32.3	61.3	80.0	18.7	

Result = Reading + Ant Factor + Loss (Cable+Attenuator+Filter+Distance factor(above 1 GHz)) - Gain(Amplifier)
 Distance factor:
 1 GHz - 10 GHz 20log (3.95 m / 3.0 m) = 2.39 dB
 10 GHz - 26.5 GHz 20log (1.0 m / 3.0 m) = -9.5 dB

Radiated Spurious Emission

Test place	Ise EMC Lab.		
Semi Anechoic Chamber	No.4	No.4	No.4
Date	September 27, 2023	September 28, 2023	September 29, 2023
Temperature / Humidity	20 deg. C / 42 % RH	20 deg. C / 44 % RH	22 deg. C / 55 % RH
Engineer	Nachi Konegawa (1 GHz to 10 GHz)	Nachi Konegawa (10 GHz to 18 GHz)	Yuta Moriya (Above 18 GHz)
Mode	Tx 2480 MHz Antenna 1		

Polarity	Frequency	Reading (QP / PK)	Reading (AV)	Ant. Factor	Loss	Gain	Duty Factor	Result (QP / PK)	Result (AV)	Limit (QP / PK)	Limit (AV)	Margin (QP / PK)	Margin (AV)	Remark
[Hori/Vert]	[MHz]	[dBuV]	[dBuV]	[dB/m]	[dB]	[dB]	[dB]	[dBuV/m]	[dBuV/m]	[dBuV/m]	[dBuV/m]	[dB]	[dB]	
Hori.	2483.5	63.9	47.6	27.7	5.4	32.0	3.5	65.1	52.3	73.9	53.9	8.8	1.6	*1)
Hori.	4960.0	44.4	35.2	31.6	7.5	31.1	3.5	52.3	46.6	73.9	53.9	21.6	7.3	
Hori.	7440.0	42.2	33.6	36.8	8.7	32.5	-	55.2	46.6	73.9	53.9	18.7	7.3	Floor noise
Hori.	9920.0	41.6	31.5	38.6	9.2	32.7	-	56.7	46.7	73.9	53.9	17.2	7.2	Floor noise
Hori.	12400.0	43.7	35.2	38.7	-1.9	32.6	3.5	47.9	43.0	73.9	53.9	26.0	11.0	
Hori.	17360.0	43.0	34.8	42.8	-0.4	32.4	-	53.0	44.8	73.9	53.9	20.9	9.1	Floor noise
Vert.	2483.5	63.0	46.3	27.7	5.4	32.0	3.5	64.2	51.0	73.9	53.9	9.7	2.9	*1)
Vert.	4960.0	43.8	35.0	31.6	7.5	31.1	3.5	51.7	46.5	73.9	53.9	22.2	7.4	
Vert.	7440.0	42.2	33.6	36.8	8.7	32.5	-	55.2	46.6	73.9	53.9	18.7	7.3	Floor noise
Vert.	9920.0	41.6	31.5	38.6	9.2	32.7	-	56.7	46.7	73.9	53.9	17.2	7.2	Floor noise
Vert.	12400.0	43.3	34.5	38.7	-1.9	32.6	3.5	47.5	42.3	73.9	53.9	26.4	11.7	
Vert.	17360.0	43.0	34.8	42.8	-0.4	32.4	-	53.0	44.8	73.9	53.9	20.9	9.1	Floor noise

Result (QP / PK) = Reading + Ant Factor + Loss (Cable+Attenuator+Filter+Distance factor(above 1 GHz)) - Gain(Amplifier)
 Result (AV) = Reading + Ant Factor + Loss (Cable+Attenuator+Filter+Distance factor(above 1 GHz)) - Gain(Amplifier) + Duty factor
 *Other frequency noises omitted in this report were not seen or had enough margin (more than 20 dB).
 *QP detector was used up to 1GHz.
 *1) Not Out of Band emission(Leakage Power)

20dBc Data Sheet

Polarity	Frequency	Reading (PK)	Ant Factor	Loss	Gain	Result	Limit	Margin	Remark
[Hori/Vert]	[MHz]	[dBuV]	[dB/m]	[dB]	[dB]	[dBuV/m]	[dBuV/m]	[dB]	
Hori.	2480.0	98.6	27.7	5.4	32.0	99.8	-	-	Carrier
Hori.	14880.0	52.1	39.6	-0.9	32.3	58.5	79.8	21.3	
Vert.	2480.0	96.5	27.7	5.4	32.0	97.6	-	-	Carrier
Vert.	14880.0	49.7	39.6	-0.9	32.3	56.2	77.6	21.5	

Result = Reading + Ant Factor + Loss (Cable+Attenuator+Filter+Distance factor(above 1 GHz)) - Gain(Amplifier)
 Distance factor:
 1 GHz - 10 GHz 20log (3.95 m / 3.0 m) = 2.39 dB
 10 GHz - 26.5 GHz 20log (1.0 m / 3.0 m) = -9.5 dB

**Radiated Spurious Emission
(Reference Plot for band-edge)**

Test place
Semi Anechoic Chamber
Date
Temperature / Humidity
Engineer

Mode

Ise EMC Lab.
No.4
September 27, 2023
20 deg. C / 42 % RH
Nachi Konegawa
(1 GHz to 10 GHz)
Tx 2480 MHz Antenna 1

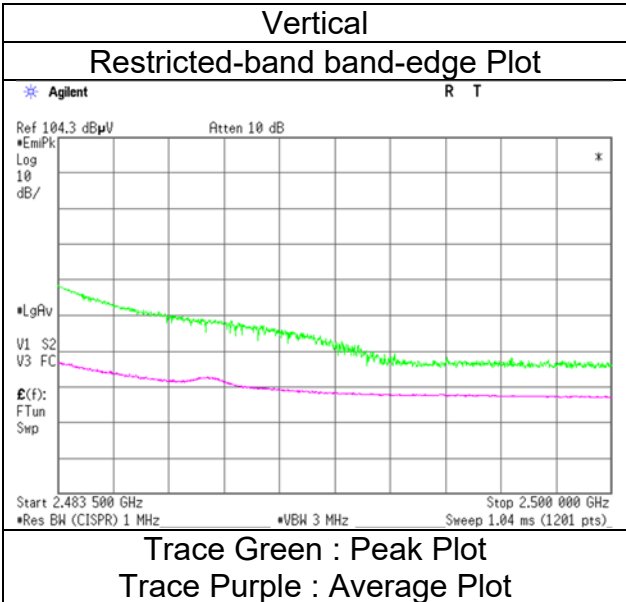
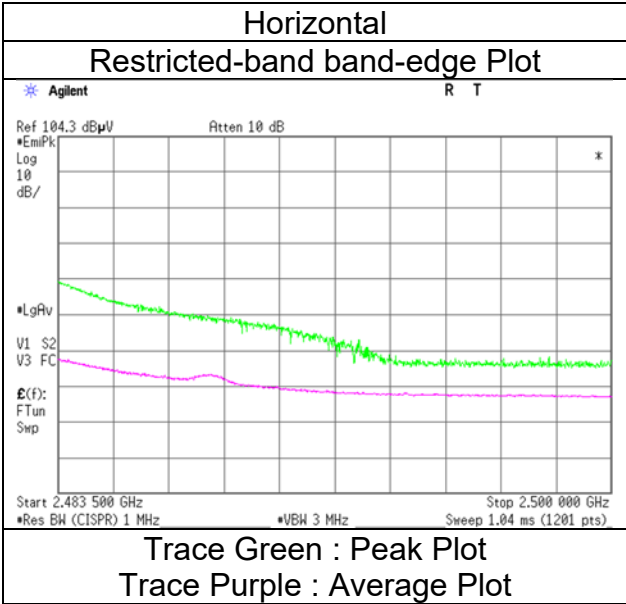

* The measurement was conducted for a sufficiently long enough time to detect any possible spurious emissions.
Final result of restricted band edge was shown in tabular data.

Radiated Spurious Emission

Test place	Ise EMC Lab.			
Semi Anechoic Chamber	No.4	No.4	No.4	No.4
Date	September 27, 2023	September 28, 2023	September 29, 2023	October 1, 2023
Temperature / Humidity	20 deg. C / 42 % RH	20 deg. C / 44 % RH	22 deg. C / 55 % RH	23 deg. C / 54 % RH
Engineer	Nachi Konegawa	Nachi Konegawa	Yuta Moriya	Sayaka Hara
	(1 GHz to 10 GHz)	(10 GHz to 18 GHz)	(Above 18 GHz)	(Below 1 GHz)
Mode	Tx 2402 MHz Antenna 2			

Polarity	Frequency	Reading (QP / PK)	Reading (AV)	Ant. Factor	Loss	Gain	Duty Factor	Result (QP / PK)	Result (AV)	Limit (QP / PK)	Limit (AV)	Margin (QP / PK)	Margin (AV)	Remark
[Hori/Vert]	[MHz]	[dBuV]	[dBuV]	[dB/m]	[dB]	[dB]	[dB]	[dBuV/m]	[dBuV/m]	[dBuV/m]	[dBuV/m]	[dB]	[dB]	
Hori.	151.0	31.0	-	15.1	8.4	32.0	-	22.4	-	43.5	-	21.1	-	
Hori.	297.3	31.0	-	13.7	9.7	32.0	-	22.4	-	46.0	-	23.6	-	
Hori.	320.9	33.8	-	14.5	9.8	32.0	-	26.0	-	46.0	-	20.0	-	
Hori.	453.0	31.2	-	16.7	10.5	32.2	-	26.2	-	46.0	-	19.8	-	
Hori.	553.8	28.7	-	18.0	11.1	32.2	-	25.6	-	46.0	-	20.5	-	
Hori.	753.8	28.2	-	20.3	11.8	32.0	-	28.3	-	46.0	-	17.7	-	
Hori.	2390.0	53.8	37.6	27.8	5.4	32.0	3.5	54.9	42.3	73.9	53.9	19.0	11.6	*1)
Hori.	4804.0	46.4	37.8	31.3	7.5	31.2	3.5	54.0	48.9	73.9	53.9	19.9	5.0	
Hori.	7206.0	42.5	34.1	36.4	8.7	32.4	-	55.3	46.8	73.9	53.9	18.6	7.1	Floor noise
Hori.	9608.0	42.9	32.5	38.0	9.1	32.5	-	57.5	47.2	73.9	53.9	16.4	6.7	Floor noise
Hori.	12010.0	44.9	35.0	39.1	-2.0	32.8	3.5	49.3	42.8	73.9	53.9	24.7	11.1	
Hori.	16814.0	42.2	34.9	40.1	-0.6	32.5	-	49.2	42.0	73.9	53.9	24.7	11.9	Floor noise
Vert.	45.4	33.6	-	12.9	7.3	32.1	-	21.6	-	40.0	-	18.4	-	
Vert.	124.4	40.4	-	13.3	8.1	32.0	-	29.8	-	43.5	-	13.7	-	
Vert.	296.5	34.7	-	13.7	9.7	32.0	-	26.1	-	46.0	-	19.9	-	
Vert.	322.2	36.3	-	14.5	9.8	32.0	-	28.6	-	46.0	-	17.4	-	
Vert.	452.1	39.8	-	16.7	10.5	32.2	-	34.8	-	46.0	-	11.2	-	
Vert.	754.1	29.7	-	20.3	11.8	32.0	-	29.8	-	46.0	-	16.2	-	
Vert.	2390.0	52.7	36.7	27.8	5.4	32.0	3.5	53.9	41.4	73.9	53.9	20.1	12.5	*1)
Vert.	4804.0	46.7	39.1	31.3	7.5	31.2	3.5	54.4	50.3	73.9	53.9	19.5	3.6	
Vert.	7206.0	42.5	34.1	36.4	8.7	32.4	-	55.3	46.8	73.9	53.9	18.6	7.1	Floor noise
Vert.	9608.0	42.9	32.5	38.0	9.1	32.5	-	57.5	47.2	73.9	53.9	16.4	6.7	Floor noise
Vert.	12010.0	46.1	35.9	39.1	-2.0	32.8	3.5	50.4	43.7	73.9	53.9	23.5	10.2	
Vert.	16814.0	42.2	34.9	40.1	-0.6	32.5	-	49.2	42.0	73.9	53.9	24.7	11.9	Floor noise

Result (QP / PK) = Reading + Ant Factor + Loss (Cable+Attenuator+Filter+Distance factor(above 1 GHz)) - Gain(Amplifier)
 Result (AV) = Reading + Ant Factor + Loss (Cable+Attenuator+Filter+Distance factor(above 1 GHz)) - Gain(Amplifier) + Duty factor
 *Other frequency noises omitted in this report were not seen or had enough margin (more than 20 dB).
 *QP detector was used up to 1GHz
 *1) Not Out of Band emission(Leakage Power)

20dBc Data Sheet

Polarity	Frequency	Reading (PK)	Ant. Factor	Loss	Gain	Result	Limit	Margin	Remark
[Hori/Vert]	[MHz]	[dBuV]	[dB/m]	[dB]	[dB]	[dBuV/m]	[dBuV/m]	[dB]	
Hori.	2402.0	104.5	27.8	5.4	32.0	105.7	-	-	Carrier
Hori.	2400.0	57.4	27.8	5.4	32.0	58.6	85.7	27.1	
Hori.	14412.0	51.6	40.7	-1.1	32.3	58.9	85.7	26.8	
Vert.	2402.0	103.5	27.8	5.4	32.0	104.7	-	-	Carrier
Vert.	2400.0	56.3	27.8	5.4	32.0	57.5	84.7	27.2	
Vert.	14412.0	49.0	40.7	-1.1	32.3	56.3	84.7	28.4	

Result = Reading + Ant Factor + Loss (Cable+Attenuator+Filter+Distance factor(above 1 GHz)) - Gain(Amplifier)
 Distance factor: 1 GHz - 10 GHz 20log (3.95 m / 3.0 m) = 2.39 dB
 10 GHz - 26.5 GHz 20log (1.0 m / 3.0 m) = -9.5 dB

**Radiated Spurious Emission
 (Reference Plot for band-edge)**

Test place	Ise EMC Lab.
Semi Anechoic Chamber	No.4
Date	September 27, 2023
Temperature / Humidity	20 deg. C / 42 % RH
Engineer	Nachi Konegawa
	(1 GHz to 10 GHz)
Mode	Tx 2402 MHz Antenna 2

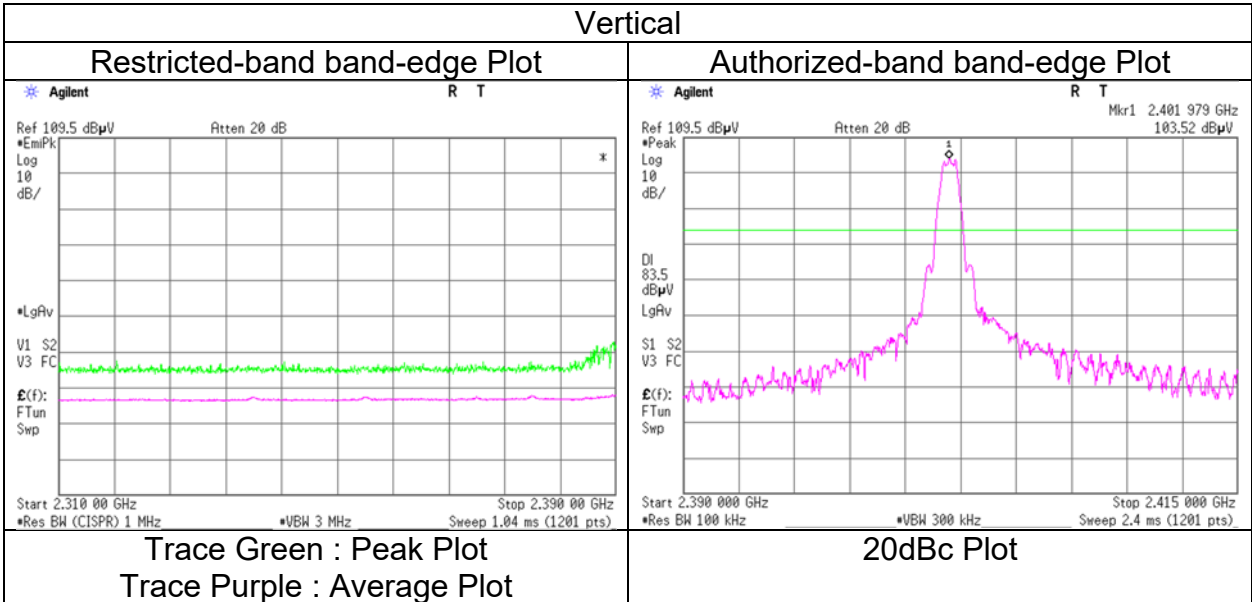
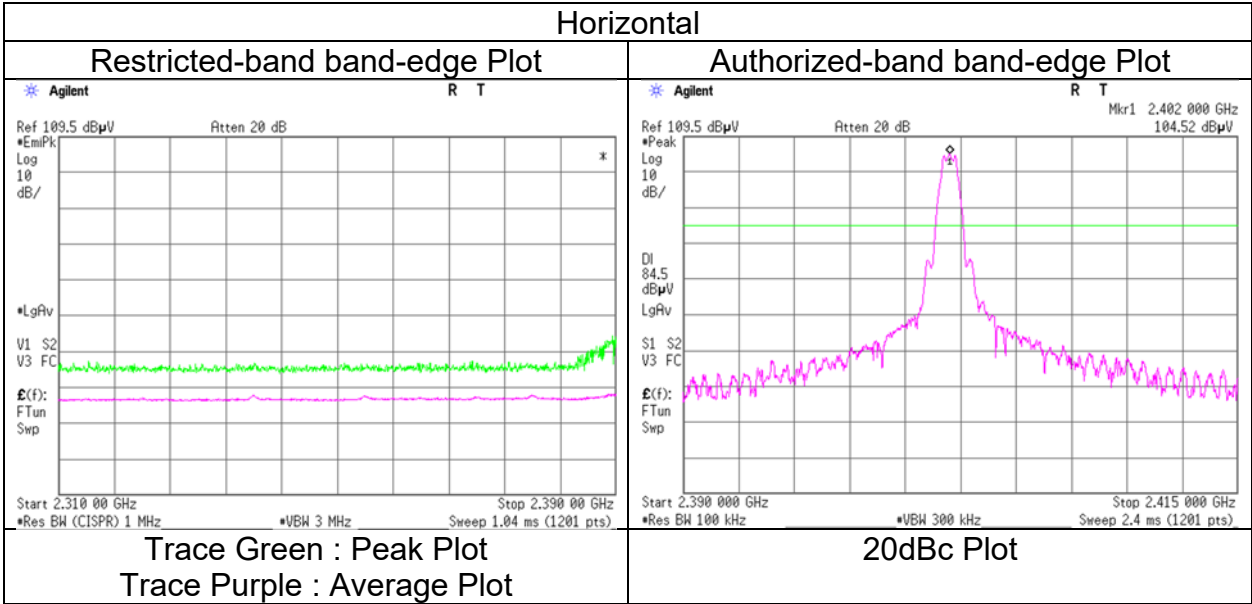

* The measurement was conducted for a sufficiently long enough time to detect any possible spurious emissions.
 Final result of restricted band edge and authorized band edge were shown in tabular data.

Radiated Spurious Emission

Test place	Ise EMC Lab.		
Semi Anechoic Chamber	No.4	No.4	No.4
Date	September 27, 2023	September 28, 2023	September 29, 2023
Temperature / Humidity	20 deg. C / 42 % RH	20 deg. C / 44 % RH	22 deg. C / 55 % RH
Engineer	Nachi Konegawa (1 GHz to 10 GHz)	Nachi Konegawa (10 GHz to 18 GHz)	Yuta Moriya (Above 18 GHz)
Mode	Tx 2441 MHz Antenna 2		

Polarity	Frequency	Reading (QP / PK)	Reading (AV)	Ant. Factor	Loss	Gain	Duty Factor	Result (QP / PK)	Result (AV)	Limit (QP / PK)	Limit (AV)	Margin (QP / PK)	Margin (AV)	Remark
[Hori/Vert]	[MHz]	[dBuV]	[dBuV]	[dB/m]	[dB]	[dB]	[dB]	[dBuV/m]	[dBuV/m]	[dBuV/m]	[dBuV/m]	[dB]	[dB]	
Hori.	4882.0	45.1	37.3	31.4	7.5	31.1	3.5	52.9	48.6	73.9	53.9	21.0	5.3	
Hori.	7323.0	42.8	33.8	36.6	8.7	32.4	-	55.6	46.7	73.9	53.9	18.3	7.2	Floor noise
Hori.	9764.0	42.4	31.4	38.4	9.2	32.6	-	57.4	46.4	73.9	53.9	16.5	7.5	Floor noise
Hori.	12205.0	44.2	34.8	39.0	-1.9	32.7	3.5	48.6	42.7	73.9	53.9	25.3	11.2	
Hori.	17087.0	42.7	35.0	40.8	-0.5	32.5	-	50.6	42.8	73.9	53.9	23.3	11.1	Floor noise
Vert.	4882.0	46.9	38.0	31.4	7.5	31.1	3.5	54.7	49.2	73.9	53.9	19.2	4.7	
Vert.	7323.0	42.8	33.8	36.6	8.7	32.4	-	55.6	46.7	73.9	53.9	18.3	7.2	Floor noise
Vert.	9764.0	42.4	31.4	38.4	9.2	32.6	-	57.4	46.4	73.9	53.9	16.5	7.5	Floor noise
Vert.	12205.0	44.6	35.1	39.0	-1.9	32.7	3.5	49.0	43.0	73.9	53.9	24.9	10.9	
Vert.	17087.0	42.7	35.0	40.8	-0.5	32.5	-	50.6	42.8	73.9	53.9	23.3	11.1	Floor noise

Result (QP / PK) = Reading + Ant Factor + Loss (Cable+Attenuator+Filter+Distance factor(above 1 GHz)) - Gain(Amplifier)
 Result (AV) = Reading + Ant Factor + Loss (Cable+Attenuator+Filter+Distance factor(above 1 GHz)) - Gain(Amplifier) + Duty factor
 *Other frequency noises omitted in this report were not seen or had enough margin (more than 20 dB).
 *QP detector was used up to 1GHz.

20dBc Data Sheet

Polarity	Frequency	Reading (PK)	Ant Factor	Loss	Gain	Result	Limit	Margin	Remark
[Hori/Vert]	[MHz]	[dBuV]	[dB/m]	[dB]	[dB]	[dBuV/m]	[dBuV/m]	[dB]	
Hori.	2441.0	104.5	27.8	5.4	32.0	105.7	-	-	Carrier
Hori.	14646.0	51.8	40.4	-1.0	32.3	58.9	85.7	26.8	
Vert.	2441.0	103.7	27.8	5.4	32.0	104.8	-	-	Carrier
Vert.	14646.0	49.3	40.4	-1.0	32.3	56.4	84.8	28.5	

Result = Reading + Ant Factor + Loss (Cable+Attenuator+Filter+Distance factor(above 1 GHz)) - Gain(Amplifier)
 Distance factor:
 1 GHz - 10 GHz 20log (3.95 m / 3.0 m) = 2.39 dB
 10 GHz - 26.5 GHz 20log (1.0 m / 3.0 m) = -9.5 dB

Radiated Spurious Emission

Test place	Ise EMC Lab.		
Semi Anechoic Chamber	No.4	No.4	No.4
Date	September 27, 2023	September 28, 2023	September 29, 2023
Temperature / Humidity	20 deg. C / 42 % RH	20 deg. C / 44 % RH	22 deg. C / 55 % RH
Engineer	Nachi Konegawa (1 GHz to 10 GHz)	Nachi Konegawa (10 GHz to 18 GHz)	Yuta Moriya (Above 18 GHz)
Mode	Tx 2480 MHz Antenna 2		

Polarity	Frequency	Reading (QP / PK)	Reading (AV)	Ant. Factor	Loss	Gain	Duty Factor	Result (QP / PK)	Result (AV)	Limit (QP / PK)	Limit (AV)	Margin (QP / PK)	Margin (AV)	Remark
[Hori/Vert]	[MHz]	[dBuV]	[dBuV]	[dB/m]	[dB]	[dB]	[dB]	[dBuV/m]	[dBuV/m]	[dBuV/m]	[dBuV/m]	[dB]	[dB]	
Hori.	2483.5	67.4	47.6	27.7	5.4	32.0	3.5	68.6	52.3	73.9	53.9	5.3	1.6	*1)
Hori.	4960.0	45.4	36.6	31.6	7.5	31.1	3.5	53.3	48.1	73.9	53.9	20.6	5.8	
Hori.	7440.0	42.2	33.6	36.8	8.7	32.5	-	55.2	46.6	73.9	53.9	18.7	7.3	Floor noise
Hori.	9920.0	41.6	31.5	38.6	9.2	32.7	-	56.7	46.7	73.9	53.9	17.2	7.2	Floor noise
Hori.	12400.0	43.6	34.2	38.7	-1.9	32.6	3.5	47.9	42.0	73.9	53.9	26.1	11.9	
Hori.	17360.0	43.0	34.8	42.8	-0.4	32.4	-	53.0	44.8	73.9	53.9	20.9	9.1	Floor noise
Vert.	2483.5	65.5	46.9	27.7	5.4	32.0	3.5	66.7	51.6	73.9	53.9	7.2	2.3	*1)
Vert.	4960.0	44.9	36.6	31.6	7.5	31.1	3.5	52.9	48.1	73.9	53.9	21.0	5.8	
Vert.	7440.0	42.2	33.6	36.8	8.7	32.5	-	55.2	46.6	73.9	53.9	18.7	7.3	Floor noise
Vert.	9920.0	41.6	31.5	38.6	9.2	32.7	-	56.7	46.7	73.9	53.9	17.2	7.2	Floor noise
Vert.	12400.0	43.4	34.4	38.7	-1.9	32.6	3.5	47.7	42.1	73.9	53.9	26.3	11.8	
Vert.	17360.0	43.0	34.8	42.8	-0.4	32.4	-	53.0	44.8	73.9	53.9	20.9	9.1	Floor noise

Result (QP / PK) = Reading + Ant Factor + Loss (Cable+Attenuator+Filter+Distance factor(above 1 GHz)) - Gain(Amplifier)
 Result (AV) = Reading + Ant Factor + Loss (Cable+Attenuator+Filter+Distance factor(above 1 GHz)) - Gain(Amplifier) + Duty factor
 *Other frequency noises omitted in this report were not seen or had enough margin (more than 20 dB).
 *QP detector was used up to 1GHz.
 *1) Not Out of Band emission(Leakage Power)

20dBc Data Sheet

Polarity	Frequency	Reading (PK)	Ant. Factor	Loss	Gain	Result	Limit	Margin	Remark
[Hori/Vert]	[MHz]	[dBuV]	[dB/m]	[dB]	[dB]	[dBuV/m]	[dBuV/m]	[dB]	
Hori.	2480.0	104.4	27.7	5.4	32.0	105.6	-	-	Carrier
Hori.	14880.0	48.7	39.6	-0.9	32.3	55.1	85.6	30.5	
Vert.	2480.0	104.4	27.7	5.4	32.0	105.5	-	-	Carrier
Vert.	14880.0	45.7	39.6	-0.9	32.3	52.1	85.5	33.4	

Result = Reading + Ant Factor + Loss (Cable+Attenuator+Filter+Distance factor(above 1 GHz)) - Gain(Amplifier)
 Distance factor:
 1 GHz - 10 GHz 20log (3.95 m / 3.0 m) = 2.39 dB
 10 GHz - 26.5 GHz 20log (1.0 m / 3.0 m) = -9.5 dB

**Radiated Spurious Emission
 (Reference Plot for band-edge)**

Test place
 Semi Anechoic Chamber
 Date
 Temperature / Humidity
 Engineer
 Mode

Ise EMC Lab.
 No.4
 September 27, 2023
 20 deg. C / 42 % RH
 Nachi Konegawa
 (1 GHz to 10 GHz)
 Tx 2480 MHz Antenna 2

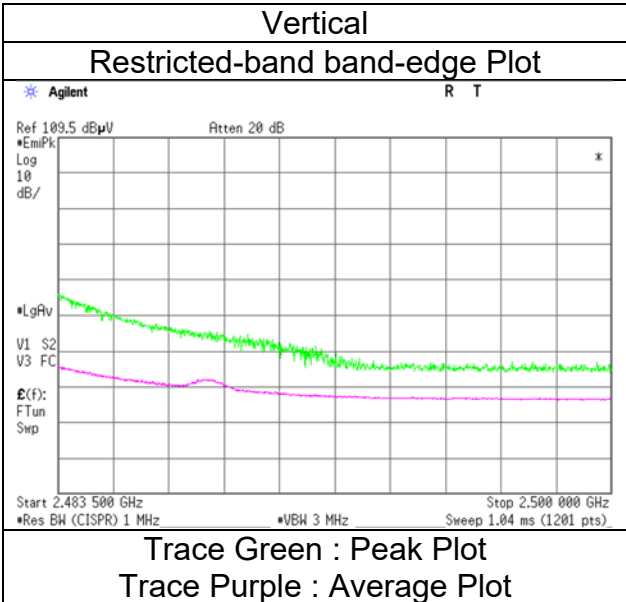
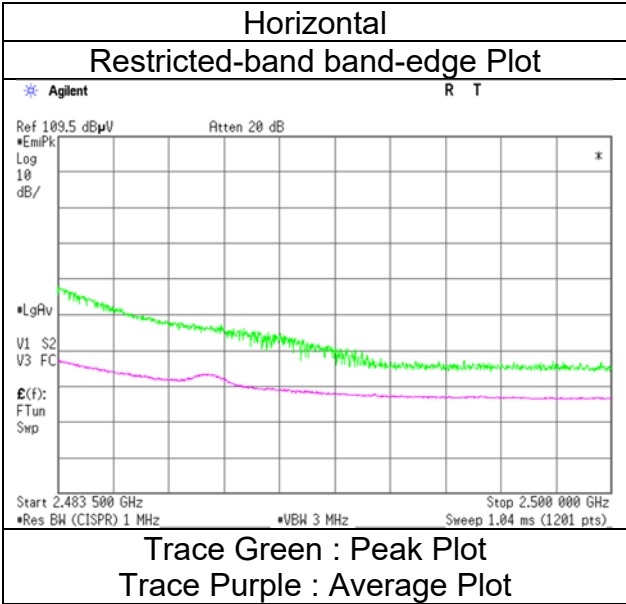

* The measurement was conducted for a sufficiently long enough time to detect any possible spurious emissions.
 Final result of restricted band edge was shown in tabular data.

Radiated Spurious Emission
(Plot data, Worst case mode for Maximum Peak Output Power)

Test place	Ise EMC Lab.			
Semi Anechoic Chamber	No.4	No.4	No.4	No.4
Date	September 27, 2023	September 28, 2023	September 29, 2023	October 1, 2023
Temperature / Humidity	20 deg. C / 42 % RH	20 deg. C / 44 % RH	22 deg. C / 55 % RH	23 deg. C / 54 % RH
Engineer	Nachi Konegawa	Nachi Konegawa	Yuta Moriya	Sayaka Hara
	(1 GHz to 10 GHz)	(10 GHz to 18 GHz)	(Above 18 GHz)	(Below 1 GHz)
Mode	Tx 2402 MHz Antenna 1			

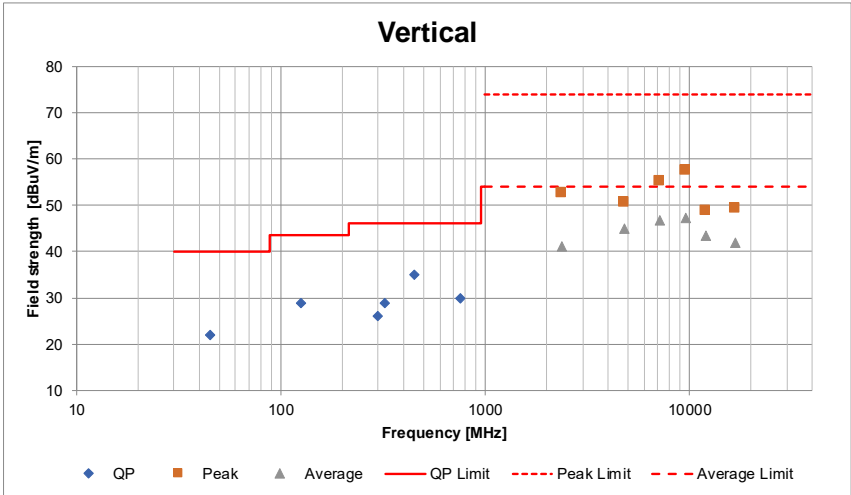
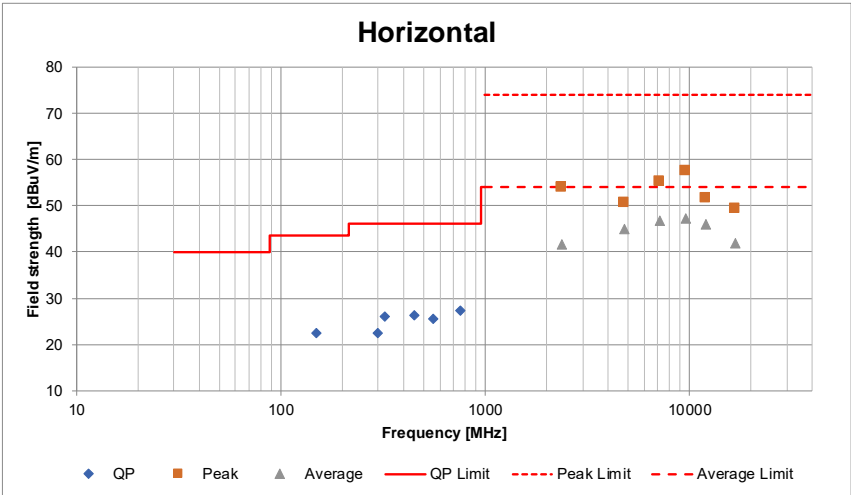

*These plots data contain sufficient number to show the trend of characteristic features for EUT.

Radiated Spurious Emission
(Plot data, Worst case mode for Maximum Peak Output Power)

Test place	Ise EMC Lab.			
Semi Anechoic Chamber	No.4	No.4	No.4	No.4
Date	September 27, 2023	September 28, 2023	September 29, 2023	October 1, 2023
Temperature / Humidity	20 deg. C / 42 % RH	20 deg. C / 44 % RH	22 deg. C / 55 % RH	23 deg. C / 54 % RH
Engineer	Nachi Konegawa	Nachi Konegawa	Yuta Moriya	Sayaka Hara
Mode	(1 GHz to 10 GHz)	(10 GHz to 18 GHz)	(Above 18 GHz)	(Below 1 GHz)
	Tx 2402 MHz Antenna 2			

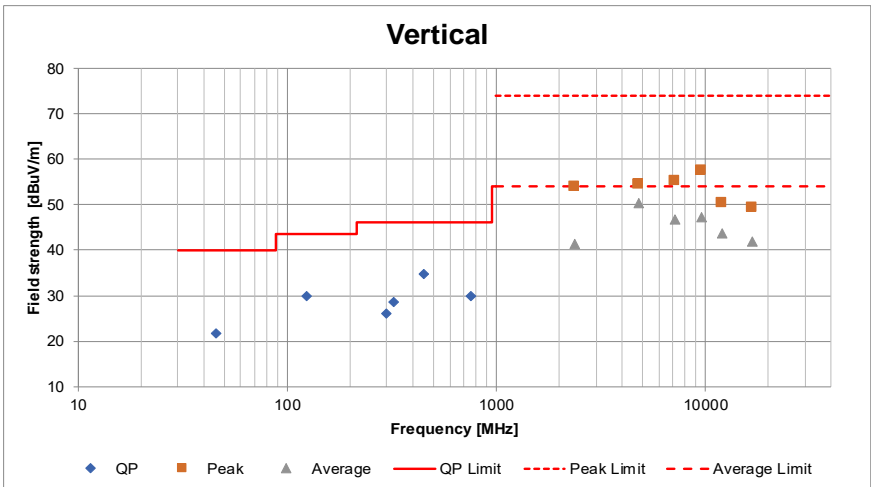
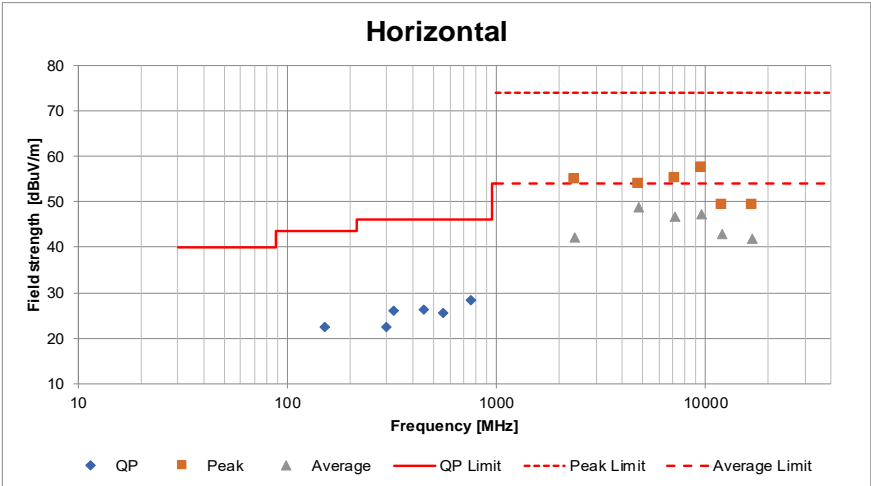

*These plots data contain sufficient number to show the trend of characteristic features for EUT.

Conducted Spurious Emission

Test place Ise EMC Lab. No.8 Measurement Room
 Date October 3, 2023
 Temperature / Humidity 23 deg. C / 42 % RH
 Engineer Nachi Konegawa
 Mode Tx 2402 MHz Antenna 1

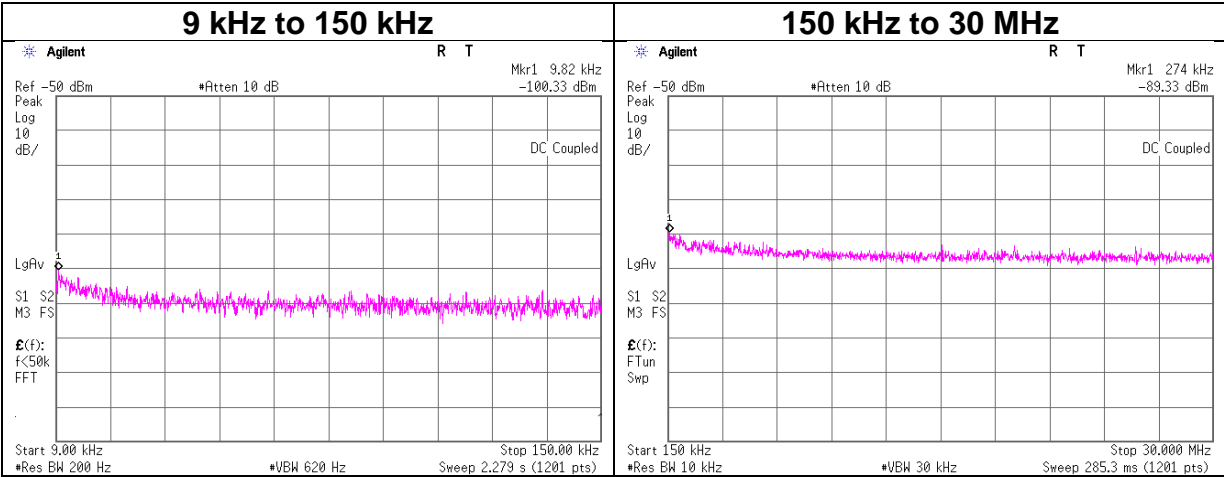

Frequency [kHz]	Reading [dBm]	Cable Loss [dB]	Attenuator Loss [dB]	Antenna Gain [dBi]	N (Number of Output)	EIRP [dBm]	Distance [m]	Ground bounce [dB]	E (field strength) [dBuV/m]	Limit [dBuV/m]	Margin [dB]	Remark
9.82	-100.33	0.01	9.84	2.8	1	-87.7	300	6.0	-26.4	47.7	74.1	
274.00	-89.34	0.02	9.84	2.8	1	-76.7	300	6.0	-15.4	18.8	34.2	

$E [dBuV/m] = EIRP [dBm] - 20 \log (Distance [m]) + Ground\ bounce [dB] + 104.8 [dBuV/m]$
 $EIRP [dBm] = Reading [dBm] + Cable\ loss [dB] + Attenuator\ Loss [dB] + Antenna\ gain [dBi] + 10 * \log (N)$
 N: Number of output

Conducted Spurious Emission

Test place Ise EMC Lab. No.4 Measurement Room
 Date October 13, 2023
 Temperature / Humidity 24 deg. C / 47 % RH
 Engineer Tomoya Sone
 Mode Tx 2402 MHz Antenna 2

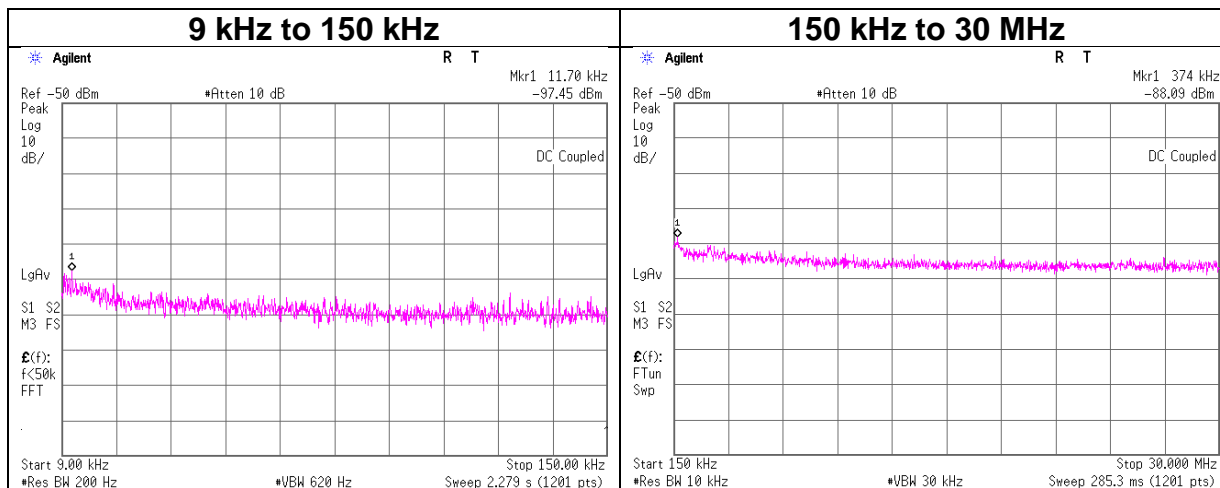

Frequency [kHz]	Reading [dBm]	Cable Loss [dB]	Attenuator Loss [dB]	Antenna Gain* [dBi]	N (Number of Output)	EIRP [dBm]	Distance [m]	Ground bounce [dB]	E (field strength) [dBuV/m]	Limit [dBuV/m]	Margin [dB]	Remark
11.70	-97.45	0.01	9.84	2.0	1	-85.6	300	6.0	-24.3	46.2	70.5	
374.00	-88.09	0.03	9.84	2.0	1	-76.2	300	6.0	-15.0	16.1	31.1	

$E [dBuV/m] = EIRP [dBm] - 20 \log (Distance [m]) + Ground\ bounce [dB] + 104.8 [dBuV/m]$

$EIRP [dBm] = Reading [dBm] + Cable\ loss [dB] + Attenuator\ Loss [dB] + Antenna\ gain [dBi] + 10 * \log (N)$

N: Number of output

*2.0 dBi was applied to the test result based on ANSI C63.10 since antenna gain was less than 2.0 dBi.

Power Density

Test place Ise EMC Lab. No.4 Measurement Room
Date September 27, 2023
Temperature / Humidity 23 deg. C / 61 % RH
Engineer Tomoya Sone
Mode Tx Antenna 2

Freq. [MHz]	Reading [dBm / 3 kHz]	Cable Loss [dB]	Atten. Loss [dB]	Result [dBm / 3 kHz]	Limit [dBm / 3 kHz]	Margin [dB]
2402	-16.56	1.46	9.74	-5.36	8.00	13.36
2441	-16.32	1.48	9.75	-5.09	8.00	13.09
2480	-16.75	1.50	9.75	-5.50	8.00	13.50

Sample Calculation:

Result = Reading + Cable Loss + Attenuator Loss

*The equipment and cables were not used for factor 0 dB of the data sheets.

Power Density

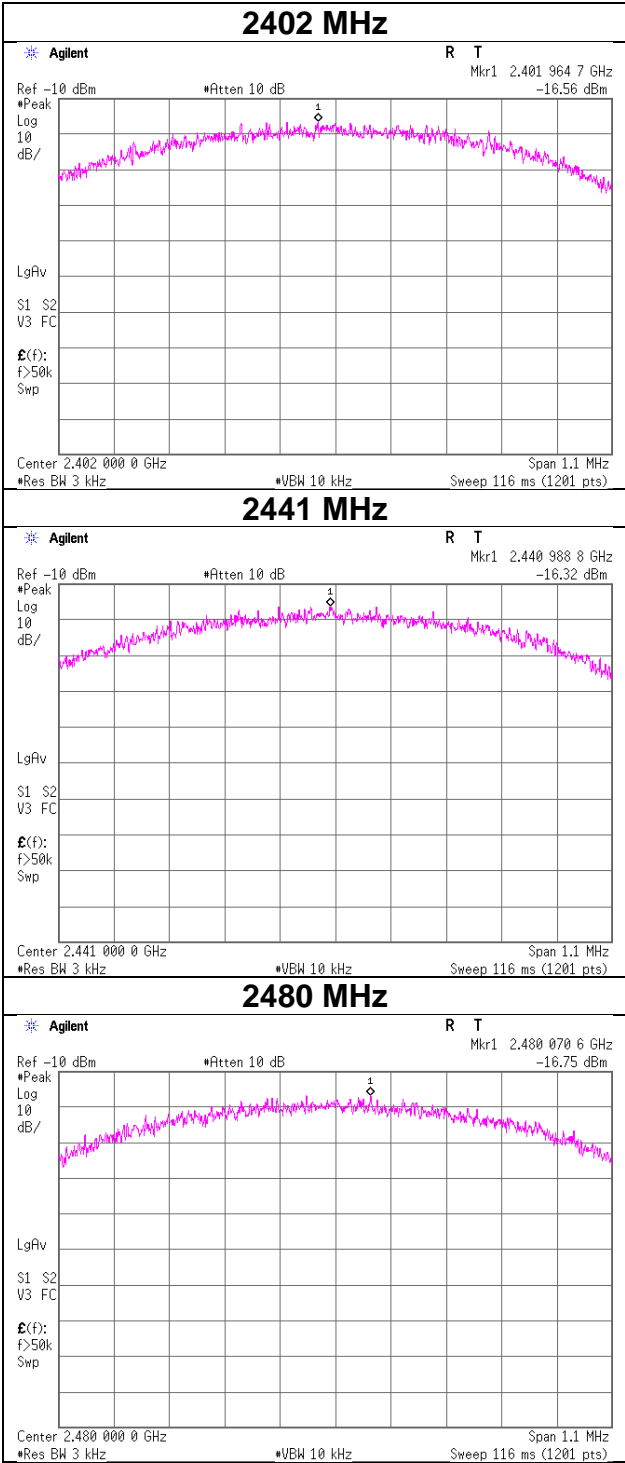

APPENDIX 2: Test Instruments

Test Equipment

Test Item	Local ID	LIMS ID	Description	Manufacturer	Model	Serial	Last Calibration Date	Cal Int
AT	MAT-10	141156	Attenuator(10dB)	Weinschel Corp	2	BL1173	11/10/2022	12
AT	MAT-89	141419	Attenuator	Weinschel Associates	WA56-10	56100305	05/18/2023	12
AT	MAT-91	141420	Attenuator	Weinschel Associates	WA56-10	56100307	05/18/2023	12
AT	MCC-238	184491	Microwave Cable	Murata Manufacturing Company, Ltd.	MXHS83QE3000	-	09/12/2023	12
AT	MCC-239	184492	Microwave Cable	Murata Manufacturing Company, Ltd.	MXHS83QE3000	-	09/12/2023	12
AT	MCC-240	195231	Microwave Cable	Huber+Suhner	SF102D/11PC24/ 11PC24/1000mm	537062/126E	02/15/2023	12
AT	MMM-10	141545	DIGITAL HiTESTER	HIOKI E.E. CORPORATION	3805	51201148	01/18/2023	12
AT	MOS-42	192303	Thermo-Hygrometer	CUSTOM. Inc	CTH-201	0014	12/17/2022	12
AT	MPM-12	141809	Power Meter	Anritsu Corporation	ML2495A	825002	05/26/2023	12
AT	MPSE-17	141830	Power sensor	Anritsu Corporation	MA2411B	738285	05/26/2023	12
AT	MSA-16	141903	Spectrum Analyzer	Keysight Technologies Inc	E4440A	MY46186390	01/16/2023	12
RE	COTS-MEMI-02	178648	EMI measurement program	TSJ (Techno Science Japan)	TEPTO-DV	-	-	-
RE	MAEC-04	142011	AC4_Semi Anechoic Chamber(NSA)	TDK	Semi Anechoic Chamber 3m	DA-10005	05/22/2022	24
RE	MAEC-04-SVSWR	142017	AC4_Semi Anechoic Chamber(SVSWR)	TDK	Semi Anechoic Chamber 3m	DA-10005	04/14/2023	24
RE	MAT-34	141331	Attenuator(6dB)	TME	UFA-01	-	02/01/2023	12
RE	MBA-05	141425	Biconical Antenna	Schwarzbeck Mess-Elektronik OHG	VHA9103+BBA9106	VHA 91031302	08/10/2023	12
RE	MCC-265	234602	Microwave Cable	Huber+Suhner	SF126E/11PC35/ 11PC35/1000M, 5000M	537063/126E / 537074/126E	03/16/2023	12
RE	MCC-50	141397	Coaxial Cable	UL Japan	-	-	11/18/2022	12
RE	MHA-17	141506	Horn Antenna 15-40GHz	Schwarzbeck Mess-Elektronik OHG	BBHA9170	BBHA9170307	08/09/2023	12
RE	MHA-21	141508	Horn Antenna 1-18GHz	Schwarzbeck Mess-Elektronik OHG	BBHA9120D	557	05/17/2023	12
RE	MHF-25	141232	High Pass Filter 3.5-18.0GHz	UL Japan	HPF SELECTOR	001	09/04/2023	12
RE	MJM-29	142230	Measure, Tape, Steel	KOMELON	KMC-36	-	-	-
RE	MLA-21	141265	Logperiodic Antenna (200-1000MHz)	Schwarzbeck Mess-Elektronik OHG	VUSLP9111B	9111B-190	07/11/2023	12
RE	MMM-10	141545	DIGITAL HiTESTER	HIOKI E.E. CORPORATION	3805	51201148	01/18/2023	12
RE	MOS-15	141562	Thermo-Hygrometer	CUSTOM. Inc	CTH-201	0010	01/13/2023	12
RE	MPA-12	141581	MicroWave System Amplifier	Keysight Technologies Inc	83017A	00650	10/05/2022	12
RE	MPA-14	141583	Pre Amplifier	SONOMA INSTRUMENT	310	260833	04/05/2023	12
RE	MSA-03	141884	Spectrum Analyzer	Keysight Technologies Inc	E4448A	MY44020357	03/13/2023	12
RE	MTR-10	141951	EMI Test Receiver	Rohde & Schwarz	ESR26	101408	04/10/2023	12

*Hyphens for Last Calibration Date and Cal Int (month) are instruments that Calibration is not required (e.g. software), or instruments checked in advance before use.

The expiration date of the calibration is the end of the expired month.

As for some calibrations performed after the tested dates, those test equipment have been controlled by means of an unbroken chains of calibrations.

All equipment is calibrated with valid calibrations. Each measurement data is traceable to the national or international standards.

Test item:

AT: Antenna Terminal Conducted test

RE: Radiated Emission