

TIMCO ENGINEERING INC.

849 NW State Road 45

Newberry, Florida 32669

<http://www.timcoengr.com>

888.472.2424 F 352.472.2030 email: sid@timcoengr.com



Test Report

Product Name: LICENSED BROADCAST TRANSMITTER

FCC ID: JFZT1000C

Applicant:

**AUDIO TECHNICA CORPORATION
2206 NARUSE MACHIDA
TOKYO 194
JAPAN**

Date Receipt: FEBRUARY 3, 2004

Date Tested: FEBRUARY 25, 2004

APPLICANT: AUDIO TECHNICA CORPORATION

FCC ID: JFZT1000C

REPORT #: A\AudioTechnica_JFZ\69UT4\69UT4TestReport.doc

COVER SHEET

TIMCO ENGINEERING INC.

849 NW State Road 45
Newberry, Florida 32669
<http://www.timcoengr.com>
888.472.2424 F 352.472.2030 email: sid@timcoengr.com

APPLICANT: AUDIO TECHNICA CORPORATION

FCC ID: JFZT1000C

TABLE OF CONTENTS LIST

TEST REPORT CONTAINING:

| | |
|-----------------|--|
| PAGE 1..... | GENERAL INFORMATION & TECHNICAL DESCRIPTION |
| PAGE 2..... | TECHNICAL DESCRIPTION & RF OUTPUT POWER |
| PAGE 3..... | MODULATION CHARACERTISTICS AUDIO FREQUENCY RESPONSE GRAPH |
| PAGE 4..... | AUDIO INPUT VERSUS MODULATION GRAPH |
| PAGE 5..... | OCCUPIED BANDWIDTH |
| PAGE 6-7..... | OCCUPIED BANDWIDTH PLOTS |
| PAGE 8-10..... | RADIATED EMISSIONS TEST DATA |
| PAGE 11..... | METHOD OF MEASURING RADIATED SPURIOUS EMISSIONS |
| PAGE 12..... | FREQUENCY STABILITY TEST DATA |
| PAGE 13-14..... | EQUIPMENT LIST |

EXHIBITS CONTAINING:

CONFIDENTIALITY LETTER
BLOCK DIAGRAM
SCHEMATICS
PARTS LIST
USERS MANUAL
LABEL SAMPLE
LABEL LOCATION
EXTERNAL PHOTOGRAPHS
INTERNAL PHOTOGRAPHS
ALIGNMENT PROCEDURE
OPERATIONAL DESCRIPTION
TEST SET UP PHOTOGRAPHS

APPLICANT: AUDIO TECHNICA CORPORATION
FCC ID: JFZT1000C
REPORT #: T:\A\AudioTechnica_JFZ\122UT4\122UT4TestReport.doc

TIMCO ENGINEERING INC.

849 NW State Road 45
Newberry, Florida 32669
<http://www.timcoengr.com>
888.472.2424 F 352.472.2030 email: sid@timcoengr.com

GENERAL INFORMATION REQUIRED FOR TYPE ACCEPTANCE

- 2.1033(c)(1)(2) AUDIO TECHNICA CORPORATION will manufacture the T1000C in quantity, for use under FCC RULES PART 74.801, LOW POWER AUXILIARY STATIONS.

AUDIO TECHNICA CORPORATION
2206 NARUSE, MACHIDA
TOKYO, 194
JAPAN

2.1033(c) TECHNICAL DESCRIPTION

- (3) Instruction book. The instruction manual is included as in the exhibits.
- (4) Type of Emission: 130K0F3E
- Bn = 2M + 2DK
M = 20000
D = 45kHz(Peak Deviation)
K = 1
Bn = 2(20k) + 2(45k)(1) = 130k
- 74.861 (e)(5) ALLOWED AUTHORIZED BANDWIDTH = 200kHz.
- (6) Frequency Range: Part 74: 541.5-566.375 MHz
- (7) Power Range and Controls: UNIT has no controls.
- (8) Maximum Output Power Rating: .020 Watts into 50 ohms resistive load.
- (9) DC Voltages and Current into Final Amplifier:
- FINAL AMPLIFIER ONLY
3.0 V BATTERY
Vce = 3.0 Volts
Ice = 13 mA.
- (10) Tune-up procedure. The tune-up procedure is given in the exhibits.
- (11) Complete Circuit Diagrams: The circuit diagram and block diagram are included in the exhibits.

TIMCO ENGINEERING INC.

849 NW State Road 45
Newberry, Florida 32669
<http://www.timcoengr.com>
888.472.2424 F 352.472.2030 email: sid@timcoengr.com

- 2.1033(c)(12) Photo or Drawing of Label and sketch of location:
See the exhibits.
- 2.1033(c)(13) Photos of Equipment:
See the exhibits.
- (14) Description of all circuitry and devices provided for determining and stabilizing frequency.
- Description of any circuits or devices employed for suppression of spurious radiation, for limiting modulation, and for limiting power.
- This circuitry is described on page 5.
- Limiting Modulation:
The transmitter audio circuitry is contained in IC101, IC102 and IC103.
- Limiting Power:
There is no provision for limiting power.
- (15) Digital modulation. This unit does not use digital modulation.
- 2.1033(c)(16) The data required by 2.1046 through 2.1057 is submitted below.
- 2.1046 **RF power output**
- RF power measured is:
OUTPUT POWER: .020 WATTS

R.F. POWER OUTPUT TEST PROCEDURE

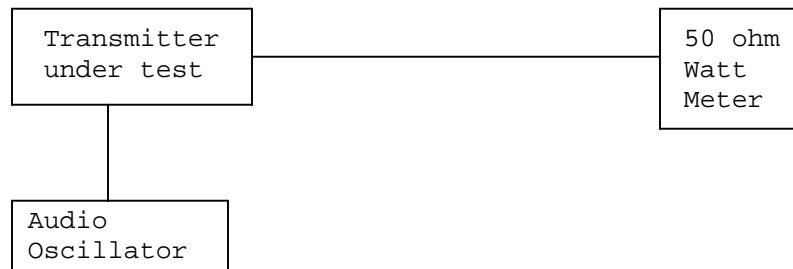

TIMCO ENGINEERING INC.

849 NW State Road 45
Newberry, Florida 32669
<http://www.timcoengr.com>
888.472.2424 F 352.472.2030 email: sid@timcoengr.com

2.1047(a)(b) **Modulation characteristics:**

AUDIO FREQUENCY RESPONSE

The audio frequency response was measured in accordance with TIA/EIA Specification 603. The audio frequency response curve is shown below.

Audio Frequency Response Plot

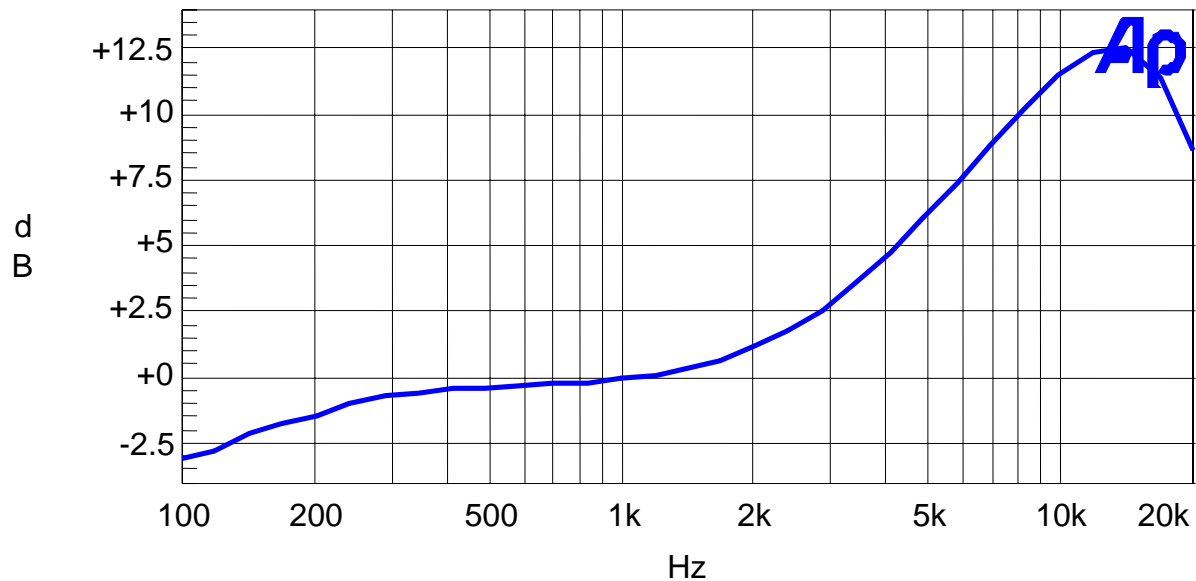

AUDIO LOW PASS FILTER

The audio low pass filter is not required in this unit.

APPLICANT: AUDIO TECHNICA CORPORATION

FCC ID: JFZT1000C

REPORT #: T:\A\AudioTechnica_JFZ\122UT4\122UT4TestReport.doc

TIMCO ENGINEERING INC.

849 NW State Road 45
Newberry, Florida 32669
<http://www.timcoengr.com>
888.472.2424 F 352.472.2030 email: sid@timcoengr.com

2.1047(b)
74.249 (d)

Audio input versus modulation

A plot of the audio input versus deviation is shown below.

Modulation Limiting Plots:
15KHz (Cyan), 2.5KHz (Green), 1.0KHz (Blue), and 300Hz

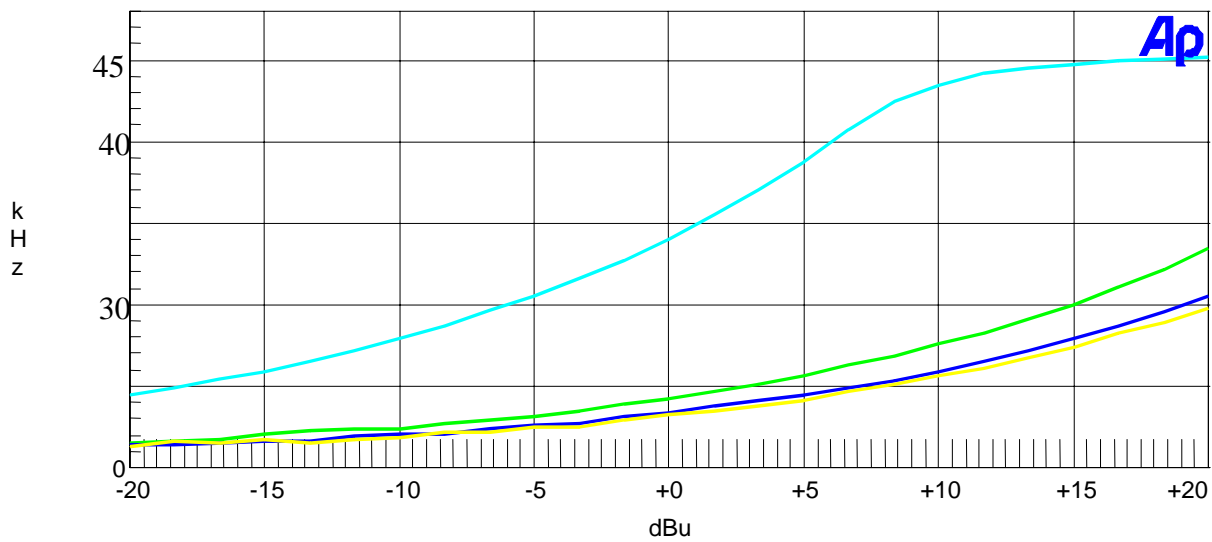

APPLICANT: AUDIO TECHNICA CORPORATION

FCC ID: JFZT1000C

REPORT #: T:\A\AudioTechnica_JFZ\122UT4\122UT4TestReport.doc

TIMCO ENGINEERING INC.

849 NW State Road 45
Newberry, Florida 32669
<http://www.timcoengr.com>
888.472.2424 F 352.472.2030 email: sid@timcoengr.com

2.1049(c)

Occupied Bandwidth:

Data in the plots show that all sidebands between 50 & 100% for the authorized bandwidth are attenuated by at least 25dB. From 100 to 250% of the authorized bandwidth they are attenuated by at least 35dB and beyond 250% $43 \log(P_o)$ dB. The plot shows the transmitter modulated with 15000 Hz (the highest modulation frequency), adjusted for 50% modulation plus 16 dB. The spectrum analyzer was set with the unmodulated carrier at the top of the screen. The test procedure diagram and occupied bandwidth plots follow.

Wireless Microphone transmitter:

Test procedure diagram

OCCUPIED BANDWIDTH MEASUREMENT

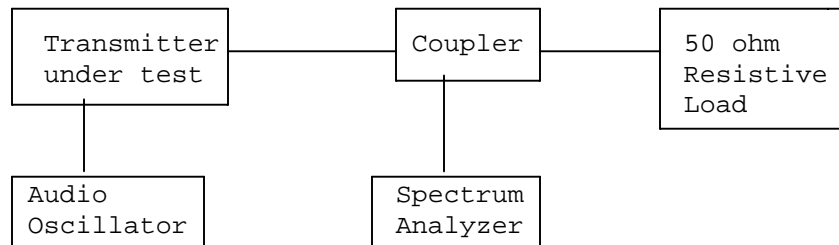

REQUIREMENT: PART 74: 200kHz EMISSION BANDWIDTH.

APPLICANT: AUDIO TECHNICA CORPORATION

FCC ID: JFZT1000C

REPORT #: T:\A\AudioTechnica_JFZ\122UT4\122UT4TestReport.doc

Page 5 of 14

TIMCO ENGINEERING INC.

849 NW State Road 45
 Newberry, Florida 32669
<http://www.timcoengr.com>
 888.472.2424 F 352.472.2030 email: sid@timcoengr.com

OCCUPIED BANDWIDTH

NOTES:

AUDIO TECHNICA CORPORATION - FCC ID: JFZT1000C
 OCCUPIED BANDWIDTH PLOT

FCC 74.535 Mask A

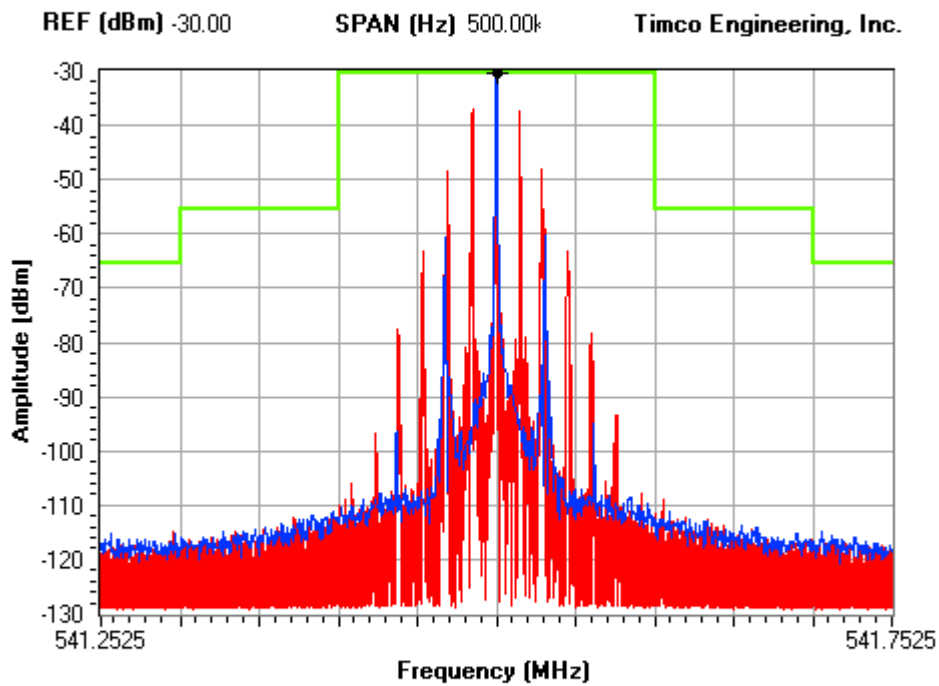

| | | | | | | | | |
|------------------------------|------------|-----------------|------|--------|---------|-------------------------------------|-------------------------------------|-------------------------------------|
| RBW | VBW | ST (sec) | Peak | 541.50 | -30.40 | <input checked="" type="checkbox"/> | <input checked="" type="checkbox"/> | <input checked="" type="checkbox"/> |
| 300 Hz | 100 kHz | 10 | MKR2 | 541.45 | -107.90 | <input checked="" type="checkbox"/> | <input type="checkbox"/> | <input type="checkbox"/> |
| Center Frequency (Hz) | 541.503M | | MKR3 | 541.25 | -118.20 | <input type="checkbox"/> | <input type="checkbox"/> | <input type="checkbox"/> |
| Marker Delta (Hz) | 0.00 | | HWMK | 23.076 | 6.27 | <input type="checkbox"/> | <input type="checkbox"/> | <input type="checkbox"/> |

TIMCO ENGINEERING INC.

849 NW State Road 45
Newberry, Florida 32669
<http://www.timcoengr.com>
888.472.2424 F 352.472.2030 email: sid@timcoengr.com

OCCUPIED BANDWIDTH

NOTES:

AUDIO TECHNICA CORPORATION - FCC ID: JFZT1000C
OCCUPIED BANDWIDTH PLOT

FCC 74.535 Mask A

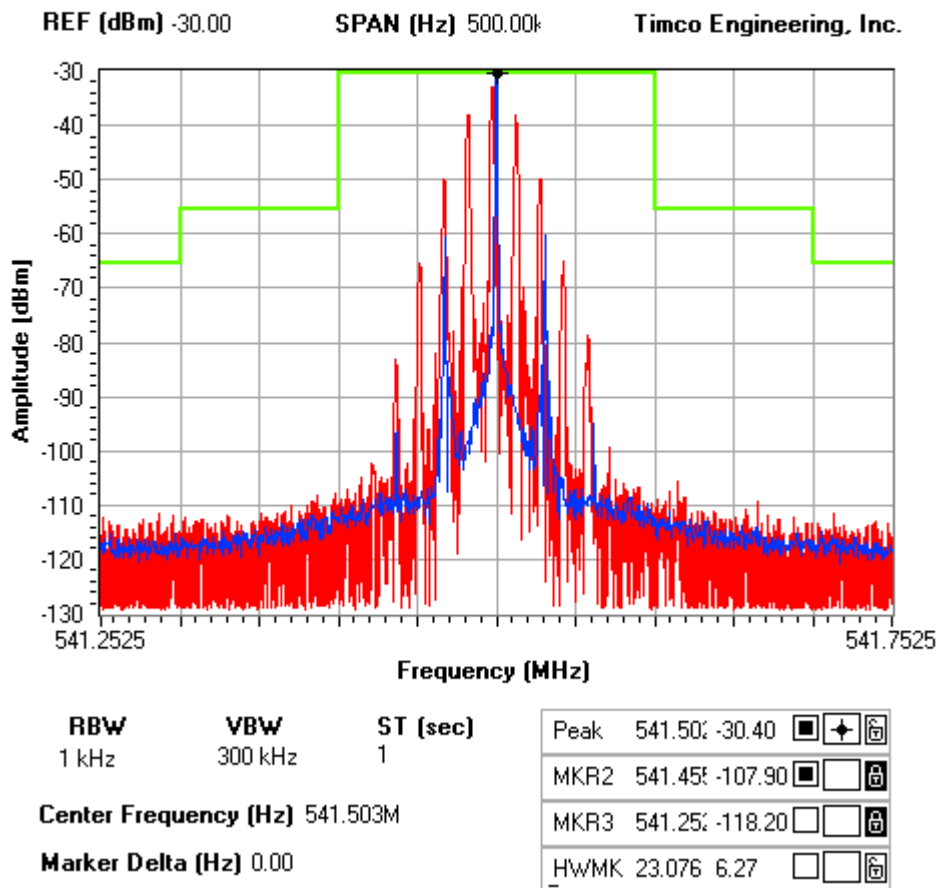

TIMCO ENGINEERING INC.

849 NW State Road 45
Newberry, Florida 32669
<http://www.timcoengr.com>
888.472.2424 F 352.472.2030 email: sid@timcoengr.com

2.1051 Spurious emissions at antenna terminals (conducted):
Not Applicable no antenna connector.

2.1053(a)(b) **Field strength of spurious emissions:**

NAME OF TEST: RADIATED SPURIOUS EMISSIONS (541.50 MHz)

REQUIREMENTS: Emissions must be $43 + 10\log(P_o)$ dB below the mean power output of the transmitter.

$$43 + 10 \log(0.020) = 26.01 \text{ dB}$$

TEST DATA:

| Emission Frequency MHz | Ant. Polarity | Corrected EUT Signal Reading | Coax Loss (dB) | Substitution Antenna (dBd) | dB Below Carrier (dBc) |
|------------------------|---------------|------------------------------|----------------|----------------------------|------------------------|
| 541.50 | V | 13.30 | 0 | 0 | 0 |
| 1083.00 | V | -52.60 | 1.02 | 3.28 | 63.63 |
| 1624.50 | H | -56.80 | 1.12 | 5.05 | 66.18 |
| 3249.00 | V | -46.00 | 1.37 | 7.35 | 53.33 |
| 3790.50 | H | -52.40 | 1.43 | 7.61 | 59.52 |
| 4332.00 | V | -45.40 | 1.48 | 8.05 | 52.13 |
| 4873.50 | V | -51.00 | 1.57 | 7.80 | 58.07 |
| 5415.00 | V | -53.20 | 1.68 | 8.23 | 59.95 |

APPLICANT: AUDIO TECHNICA CORPORATION

FCC ID: JFZT1000C

REPORT #: T:\A\AudioTechnica_JFZ\122UT4\122UT4TestReport.doc

TIMCO ENGINEERING INC.

849 NW State Road 45
Newberry, Florida 32669
<http://www.timcoengr.com>
888.472.2424 F 352.472.2030 email: sid@timcoengr.com

2.1053(a)(b) **Field strength of spurious emissions:**

NAME OF TEST: RADIATED SPURIOUS EMISSIONS (553.875 MHz)

REQUIREMENTS: Emissions must be $43 + 10\log(P_o)$ dB below the mean power output of the transmitter.

$$43 + 10 \log(0.020) = 26.01 \text{ dB}$$

TEST DATA:

| Emission Frequency MHz | Ant. Polarity | Corrected EUT Signal Reading | Coax Loss (dB) | Substitution Antenna (dBd) | dB Below Carrier (dBc) |
|------------------------|---------------|------------------------------|----------------|----------------------------|------------------------|
| 553.88 | V | 13.90 | 0 | 0 | 0 |
| 1107.75 | V | -53.20 | 1.02 | 3.38 | 64.74 |
| 1661.63 | H | -49.20 | 1.14 | 5.08 | 59.16 |
| 3877.13 | V | -47.80 | 1.44 | 7.63 | 55.51 |
| 4431.00 | H | -51.20 | 1.49 | 8.17 | 58.43 |
| 4984.88 | H | -53.90 | 1.60 | 7.67 | 61.73 |

APPLICANT: AUDIO TECHNICA CORPORATION

FCC ID: JFZT1000C

REPORT #: T:\A\AudioTechnica_JFZ\122UT4\122UT4TestReport.doc

TIMCO ENGINEERING INC.

849 NW State Road 45
Newberry, Florida 32669
<http://www.timcoengr.com>
888.472.2424 F 352.472.2030 email: sid@timcoengr.com

2.1053(a)(b) **Field strength of spurious emissions:**

NAME OF TEST: RADIATED SPURIOUS EMISSIONS (566.375 MHz)

REQUIREMENTS: Emissions must be $43 + 10\log(P_o)$ dB below the mean power output of the transmitter.

$$43 + 10 \log(0.020) = 26.01 \text{ dB}$$

TEST DATA:

| Emission Frequency MHz | Ant. Polarity | Corrected EUT Signal Reading | Coax Loss (dB) | Substitution Antenna (dBd) | dB Below Carrier (dBc) |
|------------------------|---------------|------------------------------|----------------|----------------------------|------------------------|
| 566.38 | V | 13.00 | 0 | 0 | 0 |
| 1132.75 | V | -56.20 | 1.03 | 3.48 | 66.75 |
| 1699.13 | H | -46.10 | 1.14 | 5.11 | 55.13 |
| 2265.50 | V | -50.00 | 1.25 | 6.09 | 58.16 |
| 2831.88 | H | -50.50 | 1.33 | 7.02 | 57.82 |
| 3398.25 | V | -47.70 | 1.39 | 7.47 | 54.62 |
| 3964.63 | V | -40.80 | 1.45 | 7.64 | 47.60 |
| 4531.00 | V | -42.40 | 1.51 | 8.21 | 48.69 |
| 5097.38 | V | -53.60 | 1.62 | 7.79 | 60.43 |
| 5663.75 | V | -55.20 | 1.77 | 8.58 | 61.39 |

APPLICANT: AUDIO TECHNICA CORPORATION

FCC ID: JFZT1000C

REPORT #: T:\A\AudioTechnica_JFZ\122UT4\122UT4TestReport.doc

TIMCO ENGINEERING INC.

849 NW State Road 45

Newberry, Florida 32669

<http://www.timcoengr.com>

888.472.2424 F 352.472.2030 email: sid@timcoengr.com

Method of Measuring Radiated Spurious Emissions

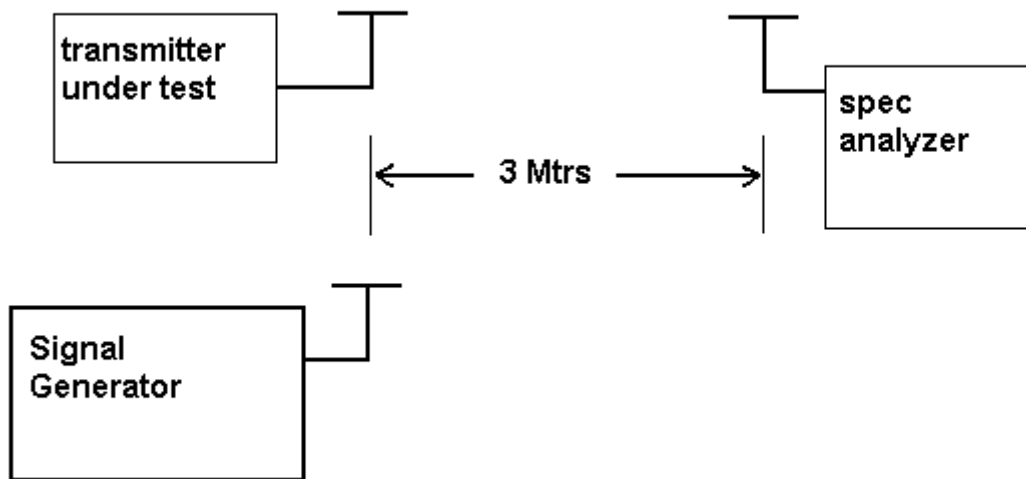

METHOD OF MEASUREMENT: The procedure used was TIA/EIA STANDARD 603. The spectrum was scanned from 30 to at least the tenth harmonic of the fundamental using a HP model 8566B spectrum analyzer and an appropriate antenna. Measurements were made at the open field test site of TIMCO ENGINEERING INC. located at 849 NW SR 45 Newberry, Florida 32669.

APPLICANT: AUDIO TECHNICA CORPORATION

FCC ID: JFZT1000C

REPORT #: T:\A\AudioTechnica_JFZ\122UT4\122UT4TestReport.doc

Page 11 of 14

TIMCO ENGINEERING INC.

849 NW State Road 45
Newberry, Florida 32669
<http://www.timcoengr.com>
888.472.2424 F 352.472.2030 email: sid@timcoengr.com

2.1055 Frequency stability:
74.861(e)(4)

Temperature and voltage tests were performed to verify that the frequency remains within the .0050%, (50 ppm)(74.861 e.4) specification limit.

The test was conducted as follows: The transmitter was placed in the temperature chamber at 25 degrees C and allowed to stabilize for one hour. The transmitter was keyed ON for one minute during which four frequency readings were recorded at 15-second intervals. The worse case number was taken for temperature plotting. The assigned channel frequency was considered to be the reference frequency. The temperature was then reduced to -30 degrees C after which the transmitter was again allowed to stabilize for one hour. The transmitter was keyed ON for one minute, and again frequency readings were noted at 15-second intervals. The worst-case number was recorded for temperature plotting. This procedure was repeated in 10-degree increments up to + 50 degrees C.

MEASUREMENT DATA:

Assigned Frequency (Ref. Frequency): 541.500 043

| <u>TEMPERATURE °C</u> | <u>FREQUENCY MHz</u> | <u>PPM</u> |
|-----------------------|----------------------|------------|
| -30 | 541.495 979 | - 7.51 |
| -20 | 541.498 829 | - 2.24 |
| -10 | 541.501 132 | + 2.01 |
| 0 | 541.502 081 | + 3.76 |
| 10 | 541.501 438 | + 2.58 |
| 20 | 541.500 325 | + 0.52 |
| 30 | 541.499 066 | - 1.80 |
| 40 | 541.498 439 | - 2.96 |
| 50 | 541.498 124 | - 3.54 |

| | <u>VOLTS</u> | <u>Batt. Data</u> | <u>Batt. PPM</u> |
|------|--------------|-------------------|------------------|
| -15% | 2.55 | 541.499 881 | - 0.30 |

RESULTS OF MEASUREMENTS: The test results indicate that the EUT meets the requirements.

APPLICANT: AUDIO TECHNICA CORPORATION

FCC ID: JFZT1000C

REPORT #: T:\A\AudioTechnica_JFZ\122UT4\122UT4TestReport.doc

Page 12 of 14

TIMCO ENGINEERING INC.

849 NW State Road 45
Newberry, Florida 32669
<http://www.timcoengr.com>
888.472.2424 F 352.472.2030 email: sid@timcoengr.com

EMC Equipment List

| Device | Manufacturer | Model | Serial Number | Cal/Char Date | Due Date |
|---------------------------------|-----------------|------------|--------------------------|-------------------|----------|
| 3/10-Meter OATS | TEI | N/A | N/A | Listed 3/26/01 | 3/26/04 |
| 3-Meter OATS | TEI | N/A | N/A | Listed 1/13/03 | 1/13/06 |
| AC Voltmeter | HP | 400FL | 2213A14499 | CAL 10/9/01 | 10/9/03 |
| Blue Tower Quasi-Peak Adapter | HP | 85650A | 2811A01279 | CAL 4/15/03 | 4/15/05 |
| Blue Tower RF Preselector | HP | 85685A | 2926A00983 | CAL 4/15/03 | 4/15/05 |
| Blue Tower Spectrum Analyzer | HP | 8568B | 2928A04729 2848A18049 | CAL 4/15/03 | 4/15/05 |
| Coaxial Cable #64 | Semflex Inc. | 60637 | Timco #64 | CHAR 1/24/02 | 1/24/04 |
| Dipole Antenna Kit | Electro-Metrics | TDA-30/1-4 | 152 | CAL 3/21/01 | 3/21/04 |
| Dipole Antenna Kit | Electro-Metrics | TDA-30/1-4 | 153 | CAL 9/26/02 | 9/26/05 |
| Frequency Counter | HP | 5385A | 2730A03025 | CAL 3/7/03 | 3/7/05 |
| Hygro-Thermometer | Extech | 445703 | 0602 | CAL 10/4/02 | 10/4/04 |
| Log-Periodic Antenna | Electro-Metrics | LPA-25 | 1122 | CAL 10/2/01 | 10/2/03 |
| Measuring Tape-7.5M | Kraftixx | 7.5M | | CHAR 2/1/02 | 2/1/04 |
| Modulation Analyzer | HP | 8901A | 3435A06868 | CAL 9/5/01 | 9/5/03 |
| Multimeter | Fluke | FLUKE-77-3 | 79510405 | CHAR 9/26/01 | 9/26/03 |
| Silver Tower Preamplifier | HP | 8449B | 3008A01075 | CHAR 1/28/02 | 1/28/04 |
| Silver Tower Quasi-Peak Adapter | HP | 85650A | 3303A01844 | CAL 10/14/02 | 10/14/04 |

APPLICANT: AUDIO TECHNICA CORPORATION

FCC ID: JFZT1000C

REPORT #: T:\A\AudioTechnica_JFZ\122UT4\122UT4TestReport.doc

Page 13 of 14

TIMCO ENGINEERING INC.

849 NW State Road 45
Newberry, Florida 32669
<http://www.timcoengr.com>
888.472.2424 F 352.472.2030 email: sid@timcoengr.com

| | | | | | |
|--|-----------------------|------------------|--------------------------|---------|----------|
| Silver Tower RF Preselector | HP | 85685A | 2620A00294 | CAL | 10/14/04 |
| Silver Tower Spectrum Analyzer System One | HP | 8566B Opt 462 | 3552A22064 3638A08608 | CAL | 10/14/04 |
| Tan Tower Preamplifier | Audio Precision | System One | SYS1-45868 | CHAR | 4/25/04 |
| Tan Tower Quasi-Peak Adapter | HP | 8449B- H02 | 3008A00372 | CAL | 9/23/05 |
| Tan Tower RF Preselector | HP | 85650A | 3303A01690 | CAL | 9/23/05 |
| Tan Tower Spectrum Analyzer | HP | 85685A | 3221A01400 | CAL | 9/23/05 |
| Temperature Chamber | Tenney Engineering | 8566B Opt 462 | 3138A07786 3144A20661 | CAL | 9/23/05 |
| | | TTRC | 11717-7 | CHAR | 1/22/04 |
| | | | | 1/22/02 | |

APPLICANT: AUDIO TECHNICA CORPORATION

FCC ID: JFZT1000C

REPORT #: T:\A\AudioTechnica_JFZ\122UT4\122UT4TestReport.doc

Page 14 of 14