



Project No.: TM-2312000427P  
Report No.: TMTN2312001595NR

FCC ID: JFZLP70XBT



Page: 1 / 99  
Rev.: 00

## FCC 47 CFR PART 15 SUBPART C AND ANSI C63.10: 2013

### TEST REPORT

For

### AUTOMATIC WIRELESS TURNTABLE

Model: AT-LP70XBT

Brand: audio-technica

Issued for

**Audio-Technica Corporation**

**2-46-1 Nishi-naruse, Machida, Tokyo 194-8666, JAPAN**

Issued by

**Compliance Certification Services Inc.**

**Tainan Lab.**

**No. 168, Ln. 523, Sec. 3, Zhongzheng Rd.,  
Rende Dist., Tainan City, 717017, Taiwan**

**Issued Date: February 19, 2024**

---

**Note:** This report shall not be reproduced except in full, without the written approval of Compliance Certification Services Inc. Ltd. This document may be altered or revised by Compliance Certification Services Inc. personnel only, and shall be noted in the revision section of the document

Unless otherwise stated the results shown in this test report refer only to the sample(s) tested and such sample(s) are retained for 90 days only.  
除非另有說明，此報告結果僅對測試之樣品負責，同時此樣品僅保留 90 天。本報告未經本公司書面許可，不可部份複製。

This document is issued by the Company subject to its General Conditions of Service printed overleaf, available on request or accessible at <http://www.sgs.com.tw/Terms-and-Conditions> and, for electronic format documents, subject to Terms and Conditions for Electronic Documents at <http://www.sgs.com.tw/Terms-and-Conditions>. Attention is drawn to the limitation of liability, indemnification and jurisdiction issues defined therein. Any holder of this document is advised that information contained hereon reflects the Company's findings at the time of its intervention only and within the limits of client's instruction, if any. The Company's sole responsibility is to its Client and this document does not exonerate parties to a transaction from exercising all their rights and obligations under the transaction documents. This document cannot be reproduced, except in full, without prior written approval of the Company. Any unauthorized alteration, forgery or falsification of the content or appearance of this document is unlawful and offenders may be prosecuted to the fullest extent of the law.

### REVISION HISTORY

Rev.	Issue Date	Revisions	Effect Page	Revised By
00	February 19, 2024	Initial Issue	All Page	Gina Lin

## TABLE OF CONTENTS

<b>1. TEST REPORT CERTIFICATION .....</b>	<b>4</b>
<b>2. TEST RESULT SUMMARY .....</b>	<b>5</b>
<b>3. EUT DESCRIPTION .....</b>	<b>6</b>
3.1 DESCRIPTION OF EUT & POWER .....	6
<b>4. DESCRIPTION OF TEST MODES .....</b>	<b>7</b>
<b>5. TEST METHODOLOGY .....</b>	<b>8</b>
<b>6. FACILITIES AND ACCREDITATIONS.....</b>	<b>8</b>
6.1 FACILITIES .....	8
6.2 EQUIPMENT .....	8
6.3 LABORATORY ACCREDITATIONS LISTINGS.....	8
6.4 TABLE OF ACCREDITATIONS AND LISTINGS .....	9
6.5 MEASUREMENT EQUIPMENT USED .....	10
<b>7. CALIBRATION AND UNCERTAINTY.....</b>	<b>11</b>
7.1 MEASURING INSTRUMENT CALIBRATION .....	11
7.2 MEASUREMENT UNCERTAINTY .....	11
<b>8. SETUP OF EQUIPMENT UNDER TEST.....</b>	<b>12</b>
8.1 SETUP CONFIGURATION OF EUT .....	12
8.2 SUPPORT EQUIPMENT.....	13
8.3 EUT OPERATING CONDITION.....	14
<b>9. APPLICABLE LIMITS AND TEST RESULTS.....</b>	<b>16</b>
9.1 6DB BANDWIDTH.....	16
9.2 MAXIMUM PEAK OUTPUT POWER .....	22
9.3 DUTY CYCLE.....	34
9.4 POWER SPECTRAL DENSITY .....	40
9.5 CONDUCTED SPURIOUS EMISSION .....	46
9.6 RADIATED EMISSIONS .....	57
9.7 POWERLINE CONDUCTED EMISSIONS .....	80
<b>10. ANTENNA REQUIREMENT .....</b>	<b>84</b>
10.1 STANDARD APPLICABLE.....	84
10.2 ANTENNA CONNECTED CONSTRUCTION.....	84
<b>APPENDIX I SETUP PHOTOS .....</b>	<b>85</b>
<b>APPENDIX II PHOTOGRPHS OF EUT .....</b>	<b>90</b>

## 1. TEST REPORT CERTIFICATION

**Applicant** : **Audio-Technica Corporation**  
2-46-1 Nishi-naruse, Machida, Tokyo 194-8666, JAPAN

**Manufacturer** : **Audio-Technica Corporation**  
2-46-1 Nishi-naruse, Machida, Tokyo 194-8666, JAPAN

**Equipment Under Test** : AUTOMATIC WIRELESS TURNTABLE

**Model Number** : AT-LP70XBT

**Brand Name** : audio-technica

**Date of Test** : December 27, 2023 ~ January 10, 2024

APPLICABLE STANDARD	
STANDARD	TEST RESULT
FCC Part 15 Subpart C AND ANSI C63.10: 2013	No non-compliance noted

Statements of Conformity
Determining compliance shall be based on the results of the compliance measurement, not taking into account measurement instrumentation uncertainty.

Approved by:



---

**John Chen**  
Supervisor

Report No.: TMTN2312001595NR

## 2. TEST RESULT SUMMARY

FCC Standard Section	Report Section	Test Item	Result
15.247(a)	9.1	6dB BANDWIDTH	Pass
15.247(b)	9.2	MAXIMUM PEAK OUTPUT POWER	Pass
-	9.3	DUTY CYCLE	-
15.247(e)	9.4	POWER SPECTRAL DENSITY	Pass
15.247(d)	9.5	CONDUCTED SPURIOUS EMISSION	Pass
15.209(a)	9.6	RADIATED EMISSIONS	Pass
15.207(a)	9.7	POWERLINE CONDUCTED EMISSIONS	Pass
15.203	10	ANTENNA REQUIREMENT	Pass

### 3. EUT DESCRIPTION

#### 3.1 DESCRIPTION OF EUT & POWER

<b>Product Name</b>	AUTOMATIC WIRELESS TURNTABLE
<b>Model Number</b>	AT-LP70XBT
<b>Brand Name</b>	audio-technica
<b>Received Date</b>	December 25, 2023
<b>Reported Date</b>	January 24, 2024
<b>Operating Frequency Range</b>	GFSK(5.2) Mode: 2402MHz~2480MHz
<b>Transmit Power</b>	GFSK(4.0) Mode: -3.89dBm (0.41mW) GFSK(5.2) Mode: -3.84dBm (0.41mW)
<b>Channel Spacing</b>	GFSK(5.2) Mode: 2 MHz
<b>Channel Number</b>	GFSK(5.2) Mode: 40 Channels
<b>Transmit Data Rate</b>	GFSK(4.0) Mode: 1 Mbps GFSK(5.2) Mode: 2 Mbps
<b>Type of Modulation</b>	GFSK
<b>Antenna Type</b>	Manufacturer: Sunitec Type: Layout Antenna Model: AT-LP70XBT Gain: 3.33 dBi
<b>Power Source</b>	AC 100-240V
<b>Firmware Version</b>	V1.0
<b>Software Version</b>	V1.0

#### Power Adapter :

Manufacturer	Model No.	Power Input	Power Output
SHENZHEN FUJIA APPLIANCE CO.,LTD	FJ-SW1261200500DN	100-240V~ 50/60Hz 0.4A Max	12Vdc 0.5A 6.0W

#### REMARK:

1. The sample selected for test was engineering sample that approximated to production product and was provided by manufacturer.
2. This submittal(s) (test report) is intended for FCC ID: **JFZLP70XBT** filing to comply with Section 15.207, 15.209 and 15.247 of the FCC Part 15, Subpart C Rules.
3. For more details, please refer to the user manual.

## 4. DESCRIPTION OF TEST MODES

The EUT is a AUTOMATIC WIRELESS TURNTABLE.

The RF Chip is manufactured by Sunitec Enterprise Co., LTD.

The antenna peak gain 3.33 dBi (highest gain) were chosen for full testing.

### GFSK(5.2) mode

The EUT had been tested under operating condition.

There are three channels have been tested as following:

Channel	Frequency (MHz)
Low	2402
Middle	2442
High	2480

GFSK(5.2) mode: 1Mbps long data rates (worst case) were chosen for full testing.

## 5. TEST METHODOLOGY

The tests documented in this report were performed in accordance with ANSI C63.10 and FCC CFR 47 15.207, 15.209 and 15.247 and KdB 558074.

## 6. FACILITIES AND ACCREDITATIONS

### 6.1 FACILITIES

All measurement facilities used to collect the measurement data are located at

- No.8, Jiucengling, Xinhua Dist., Tainan City 712, Taiwan (R.O.C.)
- No. 168, Ln. 523, Sec. 3, Zhongzheng Rd., Rende Dist., Tainan City 717, Taiwan

The sites are constructed in conformance with the requirements of ANSI C63.7:1992, ANSI C63.10: 2013 and CISPR Publication 22.

### 6.2 EQUIPMENT

Radiated emissions are measured with one or more of the following types of linearly polarized antennas: tuned dipole, biconical, log periodic, bi-log, and/or ridged waveguide, horn. Spectrum analyzers with preselectors and quasi-peak detectors are used to perform radiated measurements.

Conducted emissions are measured with Line Impedance Stabilization Networks and EMI Test Receivers.

Calibrated wideband preamplifiers, coaxial cables, and coaxial attenuators are also used for making measurements.

All receiving equipment conforms to CISPR Publication 16-1, "Radio Interference Measuring Apparatus and Measurement Methods."

### 6.3 LABORATORY ACCREDITATIONS LISTINGS

The test facilities used to perform radiated and conducted emissions tests are accredited by Taiwan Accreditation Foundation for the specific scope of accreditation under Lab Code: 1109 to perform Electromagnetic Interference tests according to FCC PART 15 AND CISPR 22 requirements. No part of this report may be used to claim or imply product endorsement by TAF or any agency of the Government. In addition, the test facilities are listed with Federal Communications Commission (registration no: TW1109).



## 6.4 TABLE OF ACCREDITATIONS AND LISTINGS

Our laboratories are accredited and approved by the following accreditation body according to ISO/IEC 17025.

<b>Taiwan</b>	TAF
---------------	-----

The measuring facility of laboratories has been authorized or registered by the following approval agencies.

<b>Canada</b>	Industry Canada (ISED#: 2324H)
<b>Germany</b>	TUV NORD
<b>Taiwan</b>	BSMI
<b>USA</b>	FCC

## 6.5 MEASUREMENT EQUIPMENT USED

### For §9.7

Chamber 1166 Room (Radiation Test)					
Name of Equipment	Manufacturer	Model	Serial Number	Calibration Date	Calibration Due
Active Loop Antenna	ETS-LINDREN	6502	8905-2356	09/04/2023	09/03/2024
Attenuator	MCL	BW-S15W5	0535	01/19/2023	01/18/2024
Bilog Antenna with 6dB Attenuator	SUNOL SCIENCES & EMCI	JB1 & N-6-06	A021306 & AT-N0682	10/03/2023	10/02/2024
Cable	EMCI	EM102-KMKM	CB1166-01	06/17/2023	06/16/2024
Double Ridged Guide Horn Antenna	ETS-LINDGREN	3116	00078900	03/25/2023	03/24/2024
EMI Test Receiver	R&S	ESCI	101203	10/16/2023	10/15/2024
EXA Spectrum Analyzer	KEYSIGHT	N9010A	MY54430216	07/25/2023	07/24/2024
Double Ridged Guide Horn Antenna	SCHWARZBECK	BBHA 9120D	9120D-788(98006)	04/18/2023	04/17/2024
Notch Filter	MICRO-TRONICS	BRM50702-01	018	01/19/2023	01/18/2024
Pre-Amplifier	EMCI	EMC012645	980098	01/19/2023	01/18/2024
Pre-Amplifier	Com-Power	PAM-840A	461378	06/07/2023	06/06/2024
Software	Excel(ccs-o6-2020 v1.1) , e3(v6.101222)				

### For §9.1~9.6

Chamber 1166 Room (Conducted Test)					
Name of Equipment	Manufacturer	Model	Serial Number	Calibration Date	Calibration Due
EXA Spectrum Analyzer	KEYSIGHT	N9010A	MY54430216	07/25/2023	07/24/2024
SMA Cable+10dB Attenuator	CCS	SMA+10dB ATT	SMA/10dB	01/19/2023	01/18/2024
Software	Excel(ccs-o6-2020 v1.1)				

### For §9.8

Conducted Emission room #1					
Name of Equipment	Manufacturer	Model	Serial Number	Calibration Date	Calibration Due
BNC Coaxial Cable	CCS	BNC50	11	01/19/2023	01/18/2024
EMI Test Receiver	R&S	ESCS 30	100348	12/05/2023	12/04/2024
LISN	R&S	ENV216	101495	07/12/2023	07/11/2024
LISN	SCHWARZBECK	NNLK8130	8130124	01/18/2023	01/17/2024
Pulse Limiter	SCHWARZBECK	VTSD 9561-F	797	01/19/2023	01/18/2024
Test S/W	e3(v6.101222)				

## 7. CALIBRATION AND UNCERTAINTY

### 7.1 MEASURING INSTRUMENT CALIBRATION

The measuring equipment utilized to perform the tests documented in this report has been calibrated in accordance with the manufacturer's recommendations, and is traceable to recognized national standards.

### 7.2 MEASUREMENT UNCERTAINTY

Where relevant, the following measurement uncertainty levels have been estimated for tests performed on the apparatus:

PARAMETER	UNCERTAINTY
Radiated Emission, 9kHz~30MHz Test Site : CB1166	±2.7dB
Radiated Emission, 30 MHz ~1GHz Test Site : CB1166	±3.76dB
Radiated Emission, 1GHz ~18GHz Test Site : CB1166	±4.43dB
Radiated Emission, 18GH~26.5GHz Test Site : CB1166	±4.79dB
Radiated Emission, 26.5GH~40GHz Test Site : CB1166	±4.72dB
Power Line Conducted Emission, 9kHz~30MHz	±1.83dB
Band Width	0.025%
Peak Output Power MU	±1.9dB
Band Edge MU	±0.264dBuV
Channel Separation MU	±361.69Hz
Duty Cycle MU	±0.2%
Frequency Stability MU	±0.493Hz
Temperature	±0.5
Humidity	±3%

This measurement uncertainty is confidence of approximately 95%, k=2

## 8. SETUP OF EQUIPMENT UNDER TEST

### 8.1 SETUP CONFIGURATION OF EUT

#### EMI

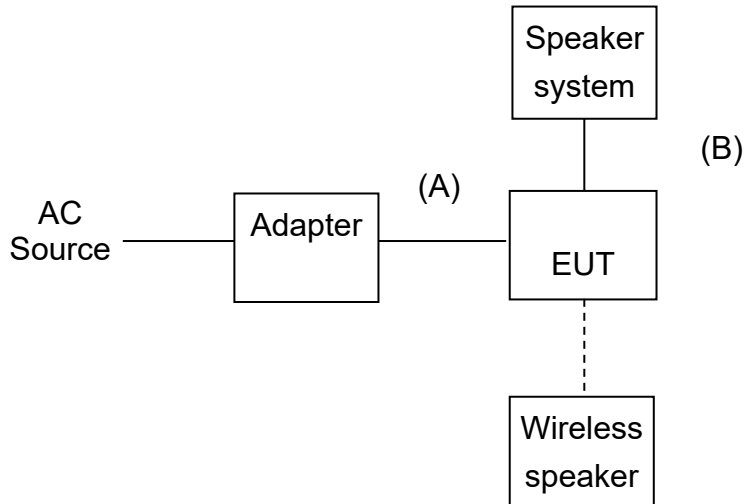

#### RF

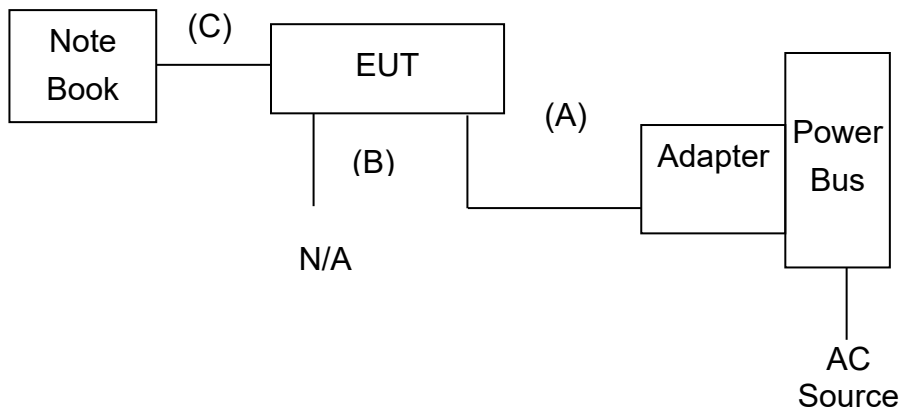

## 8.2 SUPPORT EQUIPMENT

### For EMI test

No.	Product	Manufacturer	Model No.	Certify No.	Signal cable
1	Speaker System	infotec	SP-102	DOC	N/A
2	Wireless Speaker	PHILIPS	TAS1505	DOC	N/A

No.	Signal cable description	
A	DC Power Cable	Unshielded, 1.5m 1 pcs. with 1 core.
B	Audio Cable	Shielded, 1.0m 1 pcs.

### For RF test

No.	Product	Manufacturer	Model No.	Certify No.	Power cable
1	Note Book	Acer	Z5WE1	N/A	Unshielded, 1.8m with 1 core.

No.	Signal cable description	
A	DC Power	Unshielded, 1.5m 1 pcs. with 1 core.
B	Audio	Shielded, 1.0m 1 pcs.
C	Micro USB	Shielded, 2.0m 1 pcs. with 1 core.

### Note:

- 1) All the equipment/cables were placed in the worst-case configuration to maximize the emission during the test.
- 2) Grounding was established in accordance with the manufacturer's requirements and conditions for the intended use.
- 3) shd. = shielded; unshd. = unshielded

Report No.: TMTN2312001595NR

## 8.3 EUT OPERATING CONDITION

### RF Setup

1. Set up all computers like the setup diagram.
2. The “Blue Test 3 V3.3.9.1137” software was used for testing
3. Choose Transport “DEBUG” and Device “USB DBG(100)”

### BT1.0 、 3.0

#### TX Mode:

PACKET TX

Channel 1~5: 0,39,78

GFSK(DH1):

Packet Type:DH1 > Packet Length 27

Power(0-9) : 6

GFSK(DH3):

Packet Type:DH3 > Packet Length 183

Power(0-9) : 6

GFSK(DH5):

Packet Type:DH5 > Packet Length 339

Power(0-9) : 6

8-DPSK(3DH1):

Packet Type:3DH1 > Packet Length 83

Power(0-9) : 6

8-DPSK(3DH3):

Packet Type:3DH3 > Packet Length 552

Power(0-9) : 6

8-DPSK(3DH5):

Packet Type:3DH5 > Packet Length 1021

Power(0-9) : 6

#### RX Mode:

PACKET RX

**BT4.0 、 5.0**

**TX Mode:**

BLE TEST TX

Channel > 0,20,39 (0-39)

Length > 37

Bit pattern > Pseudo-rdm 9

PHY > 1M (2M)

**RX Mode:**

BLE TEST RX

Channel > 0 (0-39)

PHY > 1M (2M)

4. All of the function are under run.
5. Start test.

## 9. APPLICABLE LIMITS AND TEST RESULTS

### 9.1 6dB BANDWIDTH

#### LIMIT

§ 15.207(a) (2) For direct sequence systems, the minimum 6dB bandwidth shall be at least 500kHz

#### TEST SETUP

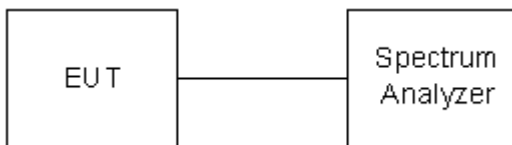

#### TEST PROCEDURE

- a) Set RBW = 100 kHz.
- b) Set the video bandwidth (VBW)  $\geq 3 \times$  RBW.
- c) Detector = Peak.
- d) Trace mode = max hold.
- e) Sweep = auto couple.
- f) Allow the trace to stabilize.
- g) Measure the maximum width of the emission that is constrained by the frequencies associated with the two outermost amplitude points (upper and lower frequencies) that are attenuated by 6 dB relative to the maximum level measured in the fundamental emission.



**TEST RESULTS**

No non-compliance noted.

<b>Model Name</b>	AT-LP70XBT	<b>Test By</b>	Peter Chu
<b>Temp &amp; Humidity</b>	22.5°C, 45%	<b>Test Date</b>	2023/12/27

**GFSK(4.0) mode**

Channel	Channel Frequency (MHz)	6dB Bandwidth (kHz)	Minimum Limit (kHz)	Pass / Fail
Low	2402	721.00	500	PASS
Middle	2442	723.00	500	PASS
High	2480	719.00	500	PASS

**NOTE :**

1. At final test to get the worst-case emission at 1Mbps long.
2. The cable assembly insertion loss of 11.4dB was entered as an offset in the spectrum analyzer to allow for direct reading of power.

**GFSK(5.2) mode**

Channel	Channel Frequency (MHz)	6dB Bandwidth (kHz)	Minimum Limit (kHz)	Pass / Fail
Low	2402	1290.00	500	PASS
Middle	2442	1240.00	500	PASS
High	2480	1240.00	500	PASS

**NOTE :**

1. At final test to get the worst-case emission at 2Mbps long.
2. The cable assembly insertion loss of 11.4dB was entered as an offset in the spectrum analyzer to allow for direct reading of power.

**6dB BANDWIDTH ( GFSK(4.0) MODE)**

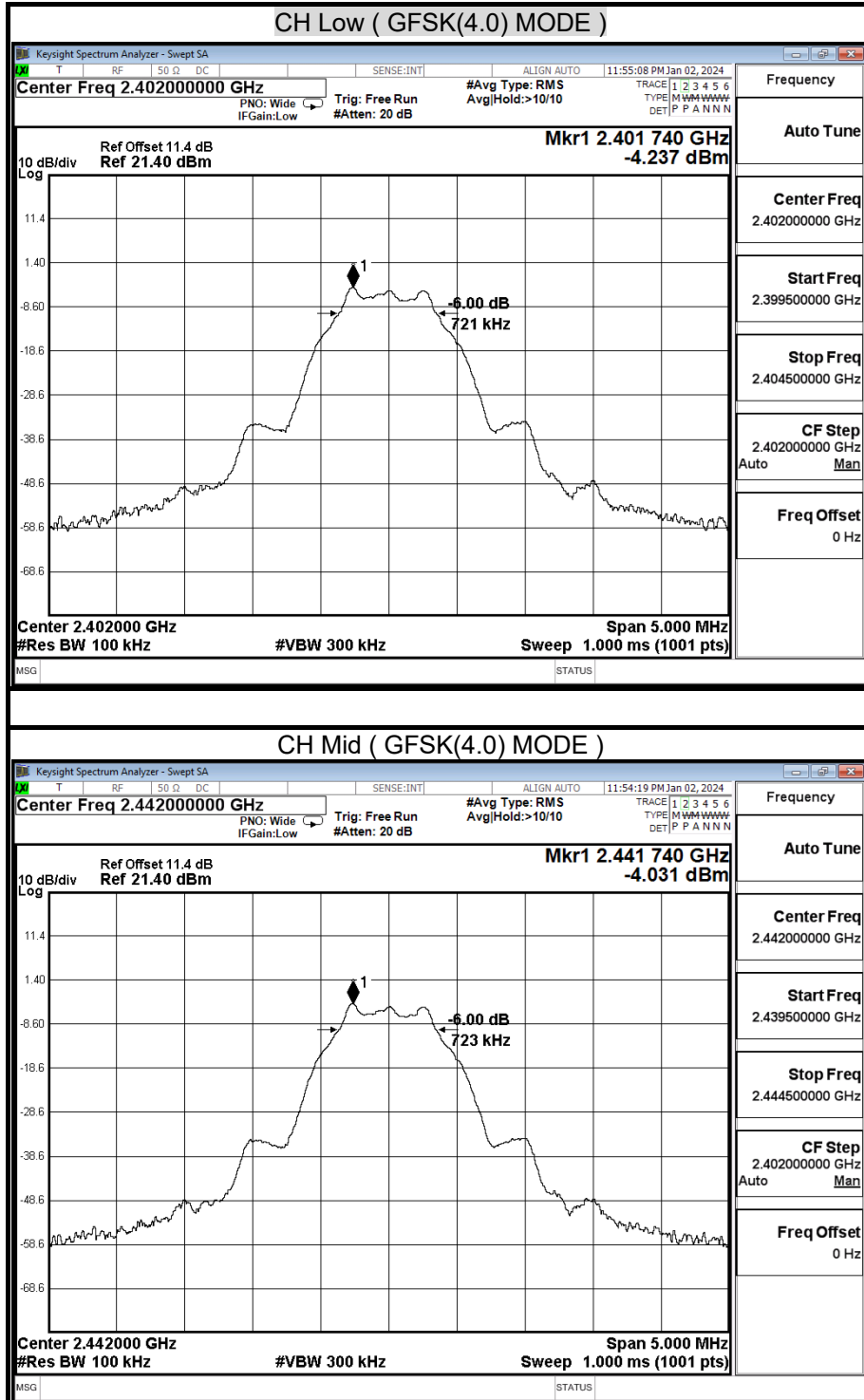

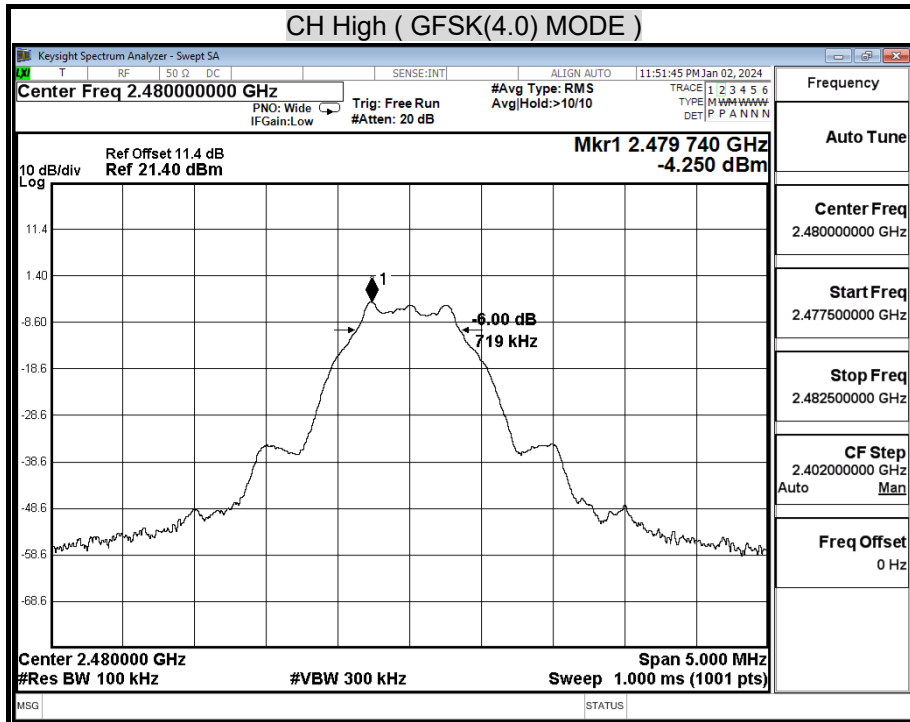

## 6dB BANDWIDTH ( GFSK(5.2) MODE)

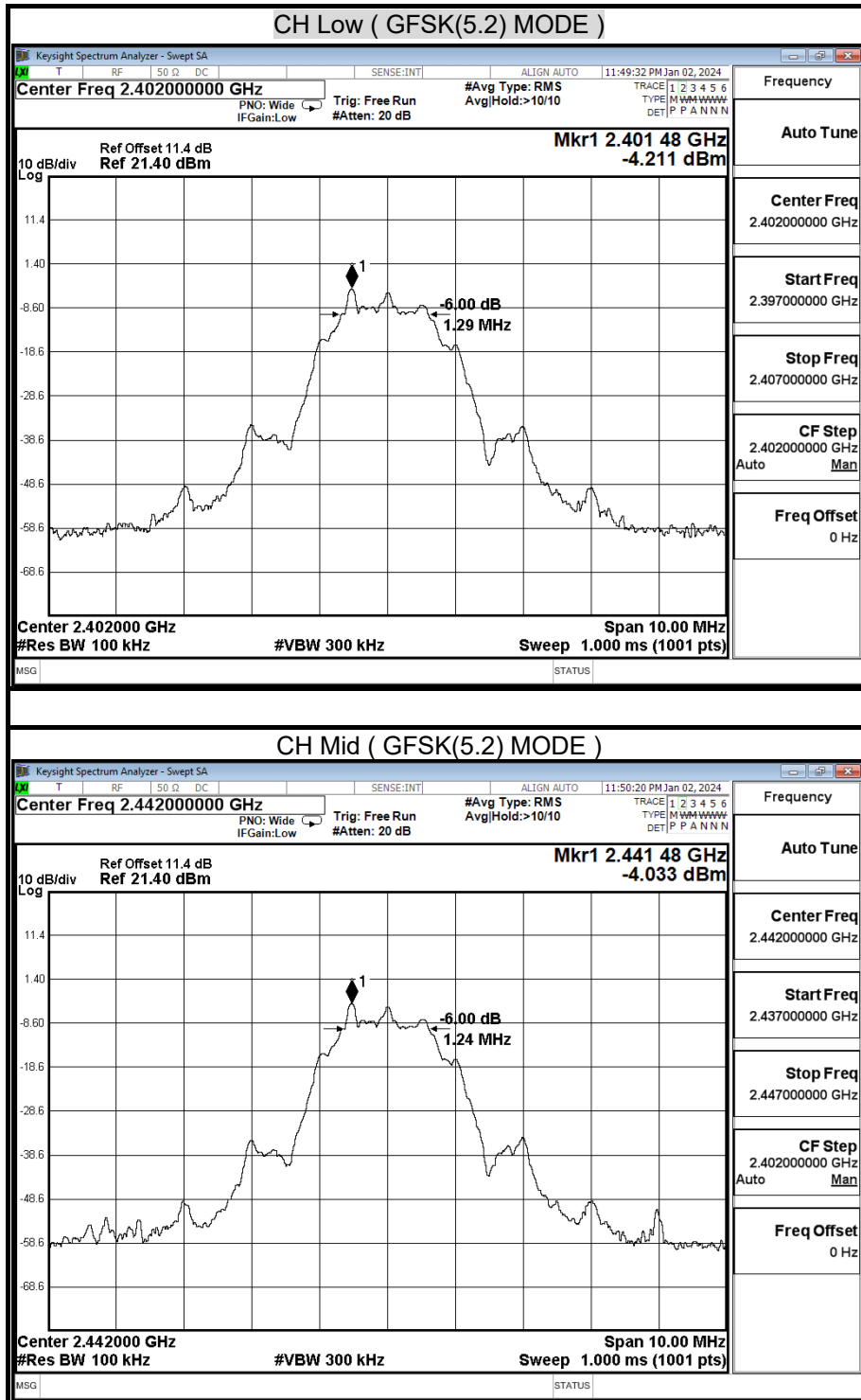

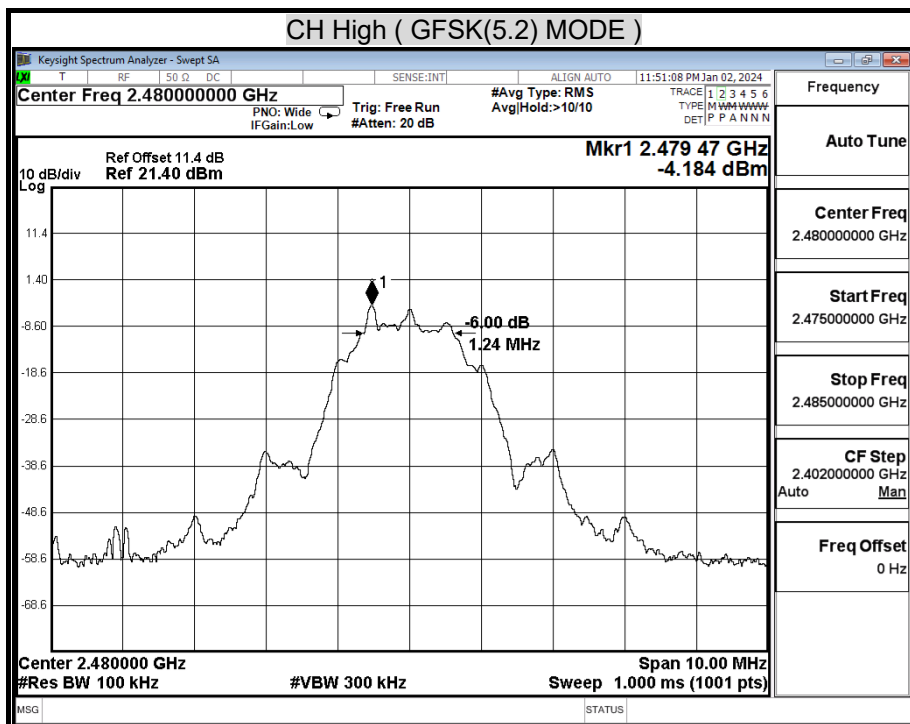

## 9.2 MAXIMUM PEAK OUTPUT POWER

### LIMIT

§ 15.247(b) The maximum peak output power of the intentional radiator shall not exceed the following :

§ 15.247(b) (3) For systems using digital modulation in the 902-928 MHz, 2400-2483.5 MHz, and 5725-5850 MHz bands : 1 watt.

§ 15.247(b) (4) Except as shown in paragraphs (c) of this section , if transmitting antennas of directional gain greater than 6 dBi are used the peak output power from the intentional radiator shall be reduced below the stated values in paragraphs (b)(1) or (b)(2), and (b)(3) of this section , as appropriate, by the amount in dB that the directional gain of the antenna exceeds 6 dBi.

### TEST SETUP

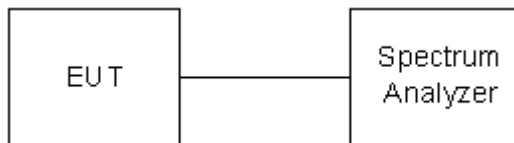

## **TEST PROCEDURE**

The tests were performed in accordance with KDB 558074 9.1.1

### **9.2.1 Measurement Procedure PK2:**

Peak Power set:

1. Set the RBW =  $\geq$  DTS bandwidth.
2. Set the VBW  $\geq$  [3  $\times$  RBW].
3. Set the span  $\geq$  [1.5  $\times$  DTS bandwidth].
4. Detector = peak.
5. Sweep time = auto couple.
6. Trace mode = max hold.
7. Allow trace to fully stabilize.
8. Use the instrument's band/channel power measurement function with the band limits set equal to the DTS bandwidth edges (for some instruments, this may require a manual override to select the peak detector). If the instrument does not have a band power function, then sum the spectrum levels (in linear power units) at intervals equal to the RBW extending across the DTS channel bandwidth.

### **Average Power**

Connect the EUT to power meter, set the center frequency of the power meter to the channel center frequency.

Average power set:

1. Measure the duty cycle D of the transmitter output signal
2. Set span to at least 1.5 times the OBW.
3. Set the RBW =  $\geq$  DTS bandwidth
4. Set VBW  $\geq$  [3  $\times$  RBW].
5. Number of points in sweep  $\geq$  [2  $\times$  span / RBW]. (This gives bin-to-bin spacing  $\leq$  RBW / 2, so that narrowband signals are not lost between frequency bins.)
6. Manually set sweep time  $\geq$  [10  $\times$  (number of points in sweep)  $\times$  (total ON/OFF period of the transmitted signal)].
7. Set detector = RMS (power averaging).
8. Perform a single sweep.
9. Compute power by integrating the spectrum across the OBW of the signal using the instrument's band power measurement function with band limits set equal to the OBW band edges. If the instrument does not have a band power function, then sum the spectrum levels (in power units) at intervals equal to the RBW extending across the entire OBW.
10. Add [10 log (1 / D)], where D is the duty cycle, to the measured power to compute the average power during the actual transmission times.

**TEST RESULTS**

No non-compliance noted.

<b>Model Name</b>	AT-LP70XBT	<b>Test By</b>	Peter Chu
<b>Temp &amp; Humidity</b>	22.5°C, 45%	<b>Test Date</b>	2023/12/27

**GFSK(4.0) mode**

Channel	Channel Frequency (MHz)	Peak Power (dBm)	Peak Power Limit (dBm)	Pass / Fail
Low	2402	-4.08	30.00	PASS
Middle	2442	-3.89	30.00	PASS
High	2480	-4.05	30.00	PASS

**NOTE :** 1. At final test to get the worst-case emission at 1Mbps long.  
2. The cable assembly insertion loss of 11.4dB was entered as an offset in the spectrum analyzer to allow for direct reading of power.

**GFSK(5.2) mode**

Channel	Channel Frequency (MHz)	Peak Power (dBm)	Peak Power Limit (dBm)	Pass / Fail
Low	2402	-4.00	30.00	PASS
Middle	2442	-3.84	30.00	PASS
High	2480	-4.00	30.00	PASS

**NOTE :** 1. At final test to get the worst-case emission at 2Mbps long.  
2. The cable assembly insertion loss of 11.4dB was entered as an offset in the spectrum analyzer to allow for direct reading of power.



### Average Power Data

<b>Model Name</b>	AT-LP70XBT	<b>Test By</b>	Peter Chu
<b>Temp &amp; Humidity</b>	22.5°C, 45%	<b>Test Date</b>	2023/12/27

#### GFSK(4.0) mode

Channel	Channel Frequency (MHz)	Measure Power (dBm)	10 log (1 / D)	Average Power (dBm)
Low	2402	-6.49	1.938	-4.55
Middle	2442	-6.28	1.938	-4.34
High	2480	-6.44	1.938	-4.50

#### GFSK(5.2) mode

Channel	Channel Frequency (MHz)	Measure Power (dBm)	10 log (1 / D)	Average Power (dBm)
Low	2402	-9.33	4.737	-4.60
Middle	2442	-9.15	4.737	-4.42
High	2480	-9.29	4.737	-4.55

**MAXIMUM PEAK OUTPUT POWER ( GFSK(4.0) MODE )**

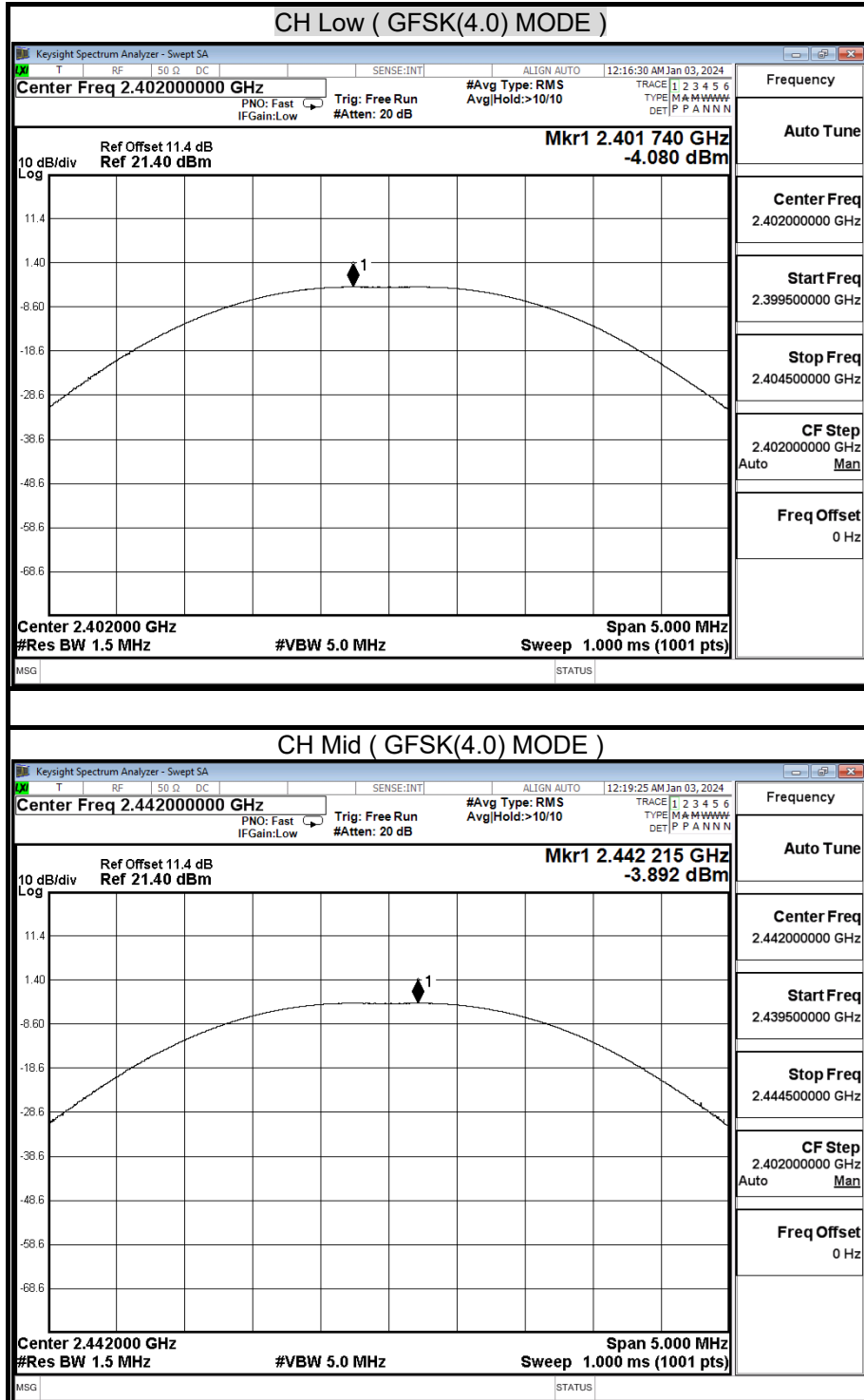

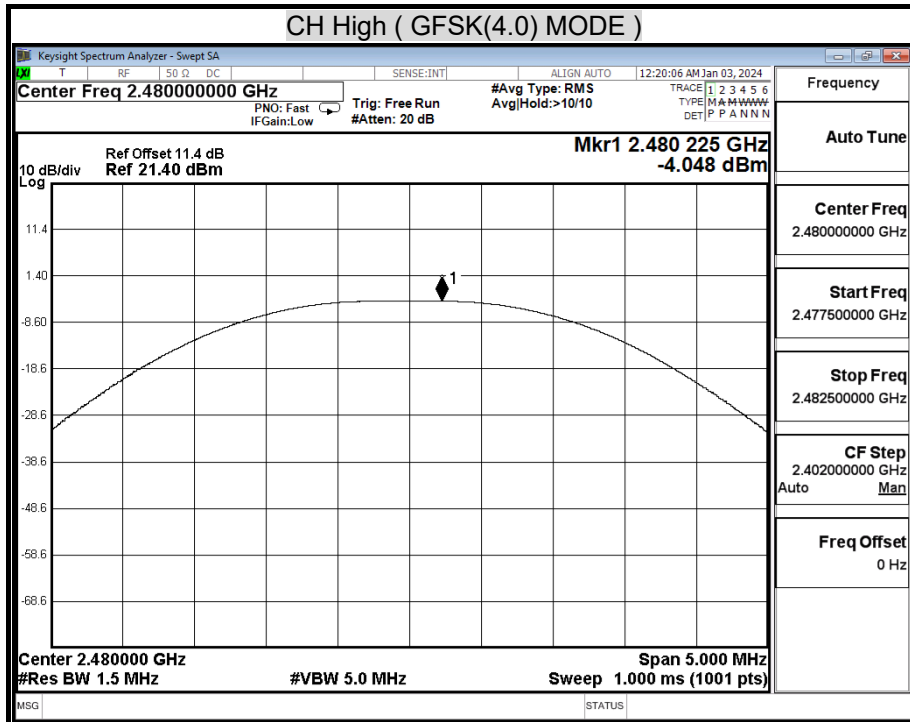

**MAXIMUM PEAK OUTPUT POWER ( GFSK(5.2) MODE)**

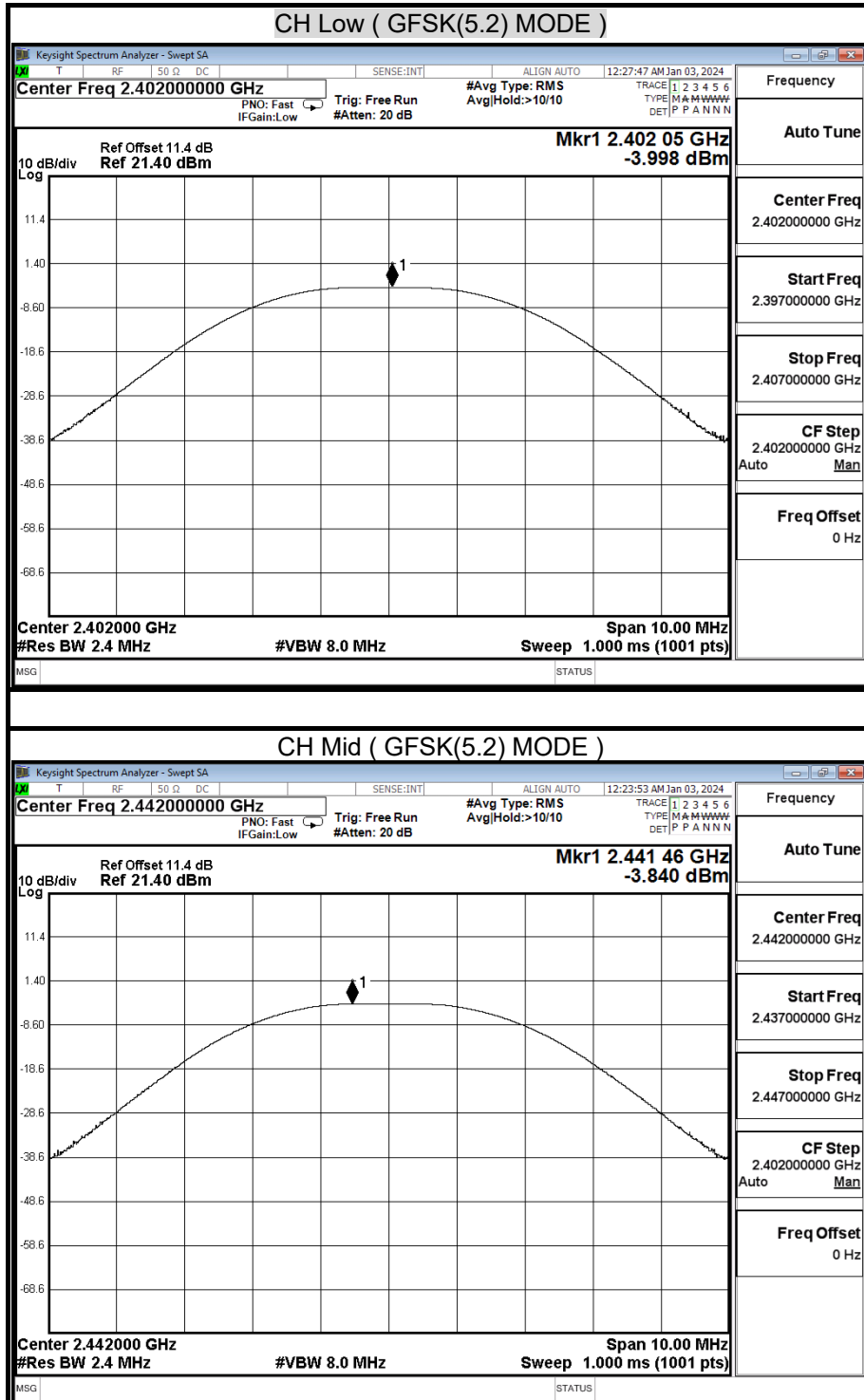

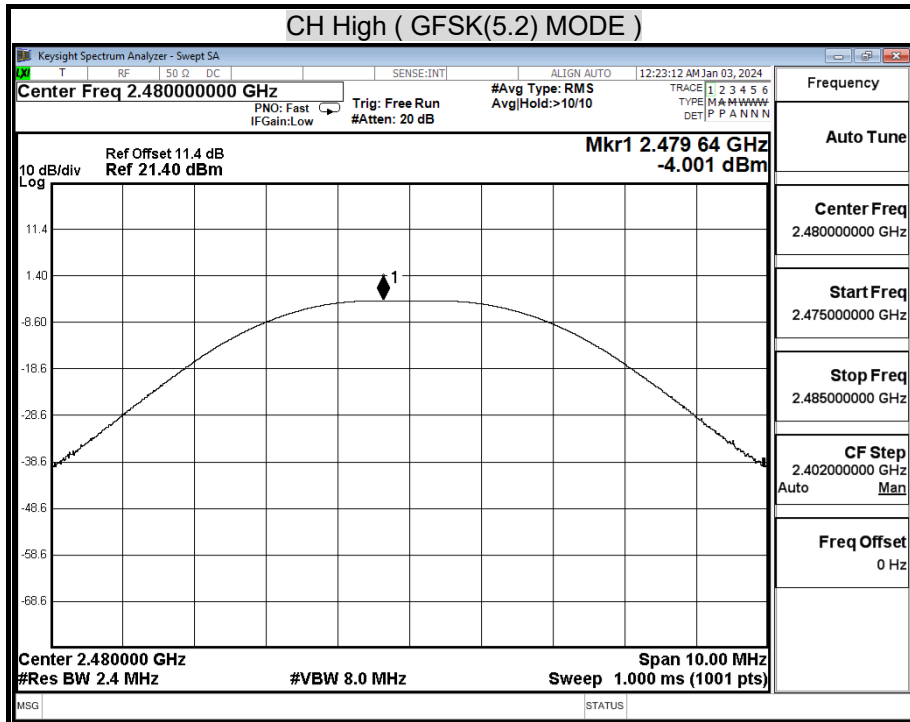

**MAXIMUM Average OUTPUT POWER ( GFSK(4.0) MODE)**

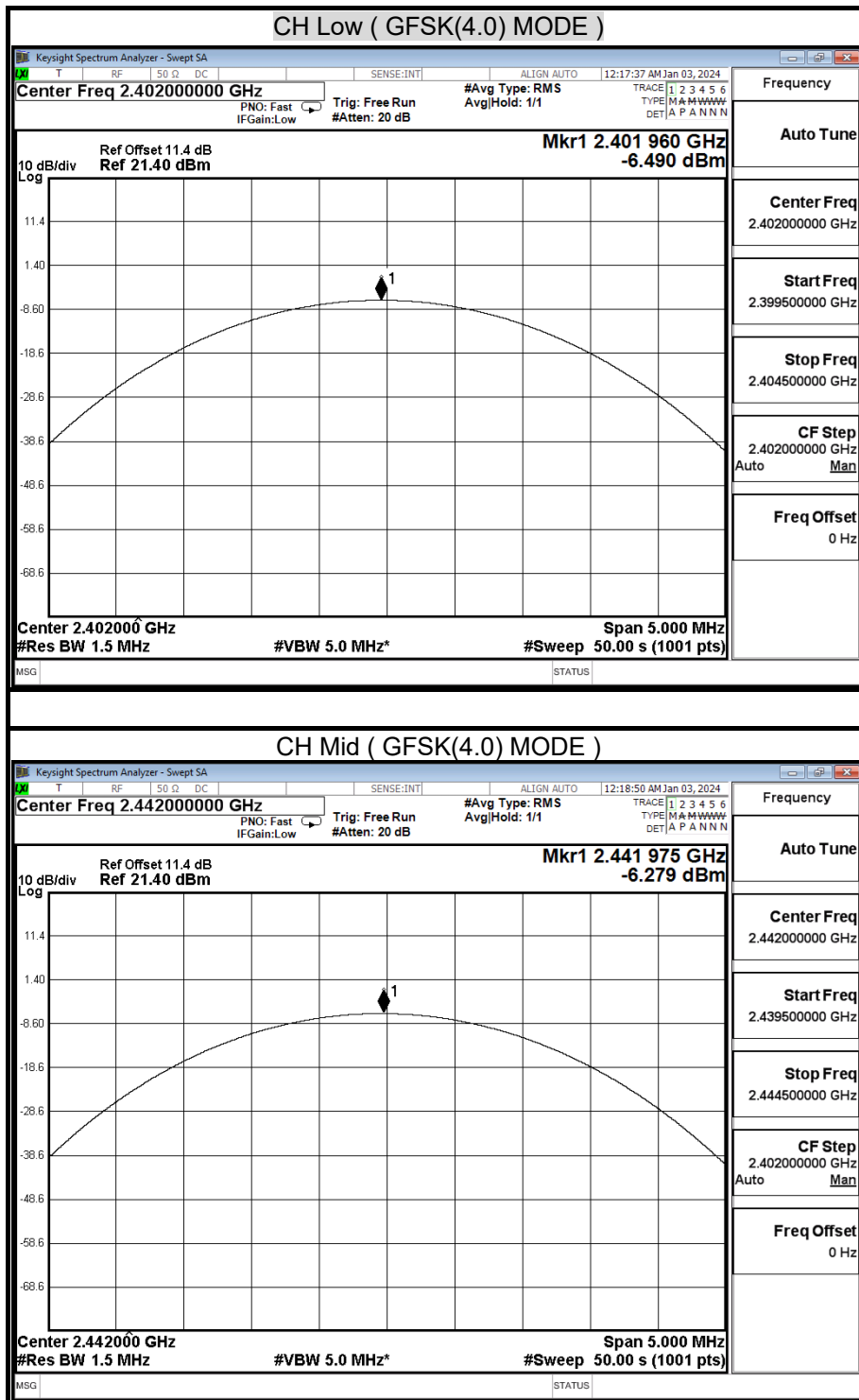

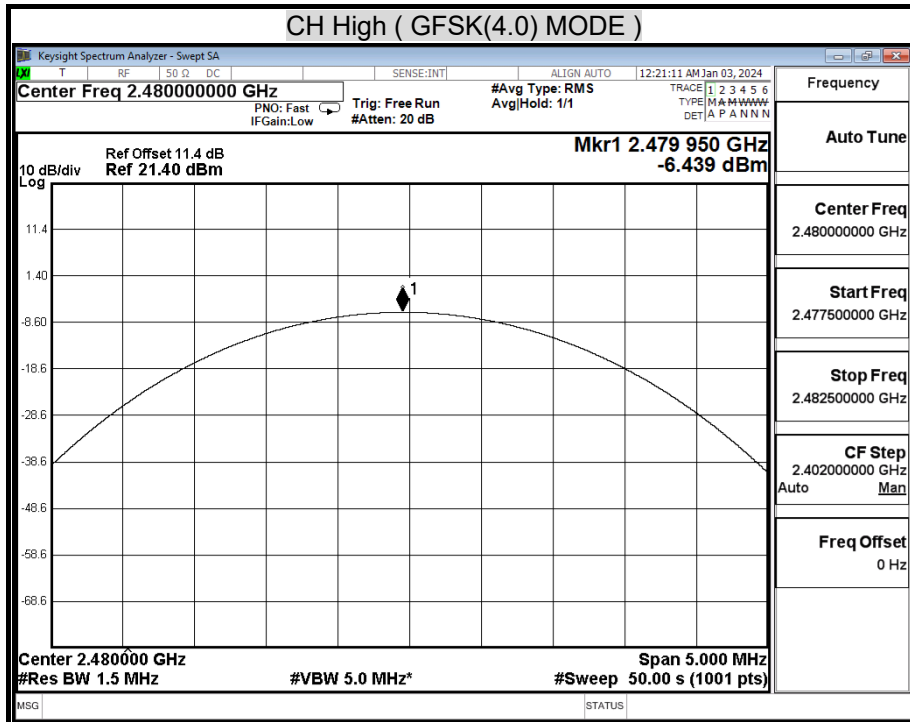

**MAXIMUM Average OUTPUT POWER ( GFSK(5.2) MODE )**

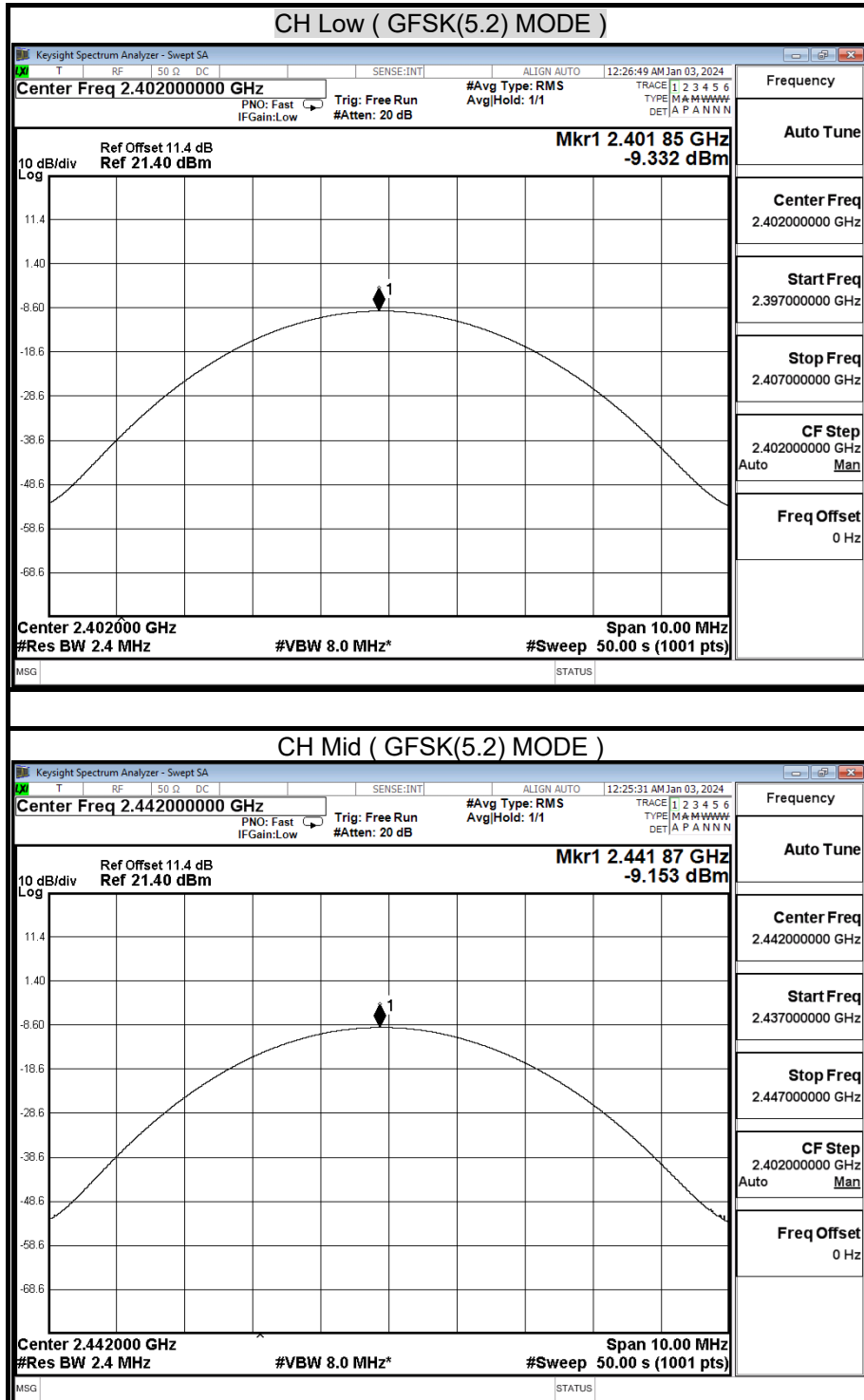



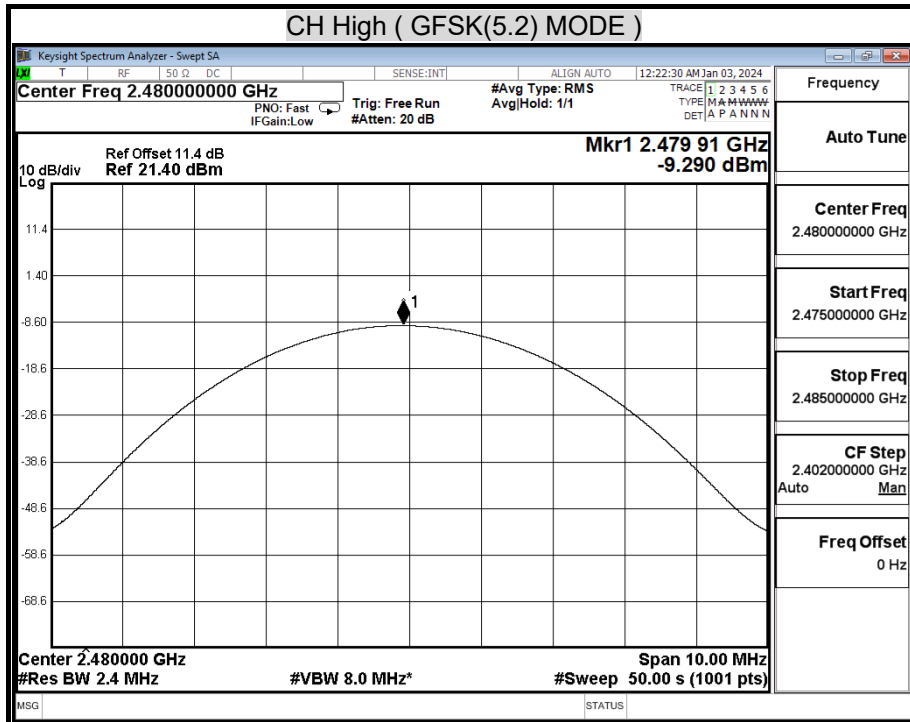

## 9.3 DUTY CYCLE

### LIMIT

Nil (No dedicated limit specified in the Rules)

### TEST SETUP

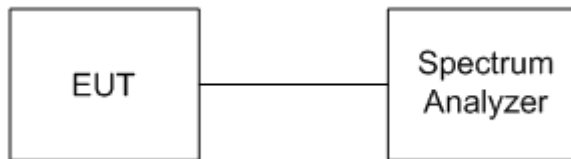

### TEST PROCEDURE

1. Place the EUT on the table and set it in transmitting mode.
2. Remove the antenna from the EUT and then connect a low loss RF cable from the antenna port to the spectrum analyzer.
3. The zero-span mode on a spectrum analyzer or EMI receiver if the response time and spacing between bins on the sweep are sufficient to permit accurate measurements of the on and off times of the transmitted signal. Set the center frequency of the instrument to the center frequency of the transmission. Set  $RBW \geq OBW$  if possible; otherwise, set RBW to the largest available value. Set  $VBW \geq RBW$ . Set detector = peak or average. The zero-span measurement method shall not be used unless both RBW and VBW are  $> 50/T$  and the number of sweep points across duration T exceeds 100. (For example, if VBW and/or RBW are limited to 3 MHz, then the zero-span method of measuring duty cycle shall not be used if  $T \leq 16.7$  microseconds.)

**TEST RESULTS**

No non-compliance noted.

<b>Model Name</b>	AT-LP70XBT	<b>Test By</b>	Peter Chu
<b>Temp &amp; Humidity</b>	22.5°C, 45%	<b>Test Date</b>	2023/12/27

**GFSK(4.0) Mode**

	us	Times	Ton(us)	Total Ton time(ms)
Ton1	400	1	400	
Ton2		0	0	
Ton3			0	0.4
Tp				0.625

Ton	0.4
Tp(Ton+Toff)	0.625
Duty Cycle	0.64
Duty Factor	1.94

**GFSK(5.2) Mode**

	us	Times	Ton(us)	Total Ton time(ms)
Ton1	210	1	210	
Ton2		0	0	
Ton3			0	0.21
Tp				0.625

Ton	0.21
Tp(Ton+Toff)	0.625
Duty Cycle	0.336
Duty Factor	4.74

## TEST PLOT

### Duty Cycle

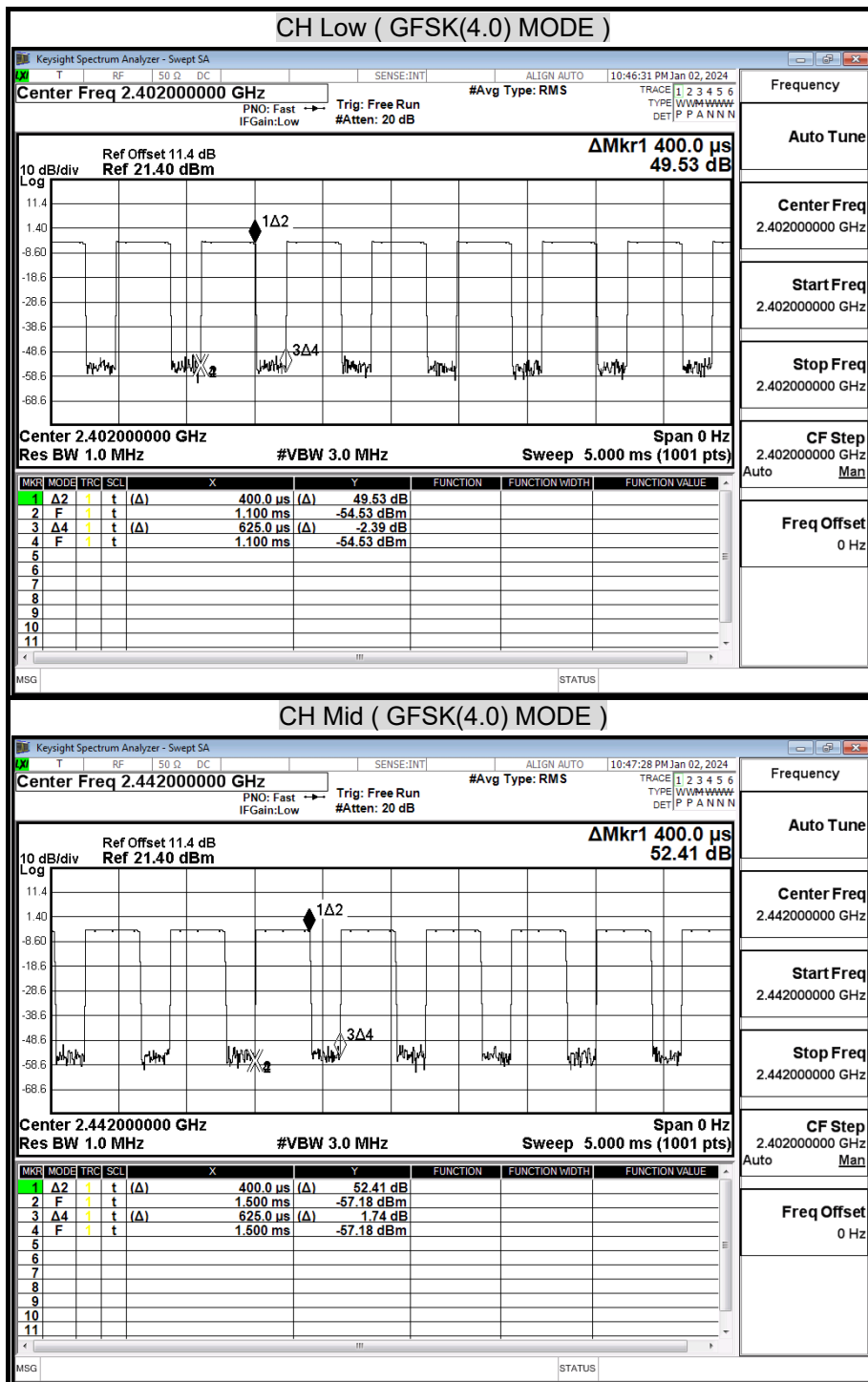

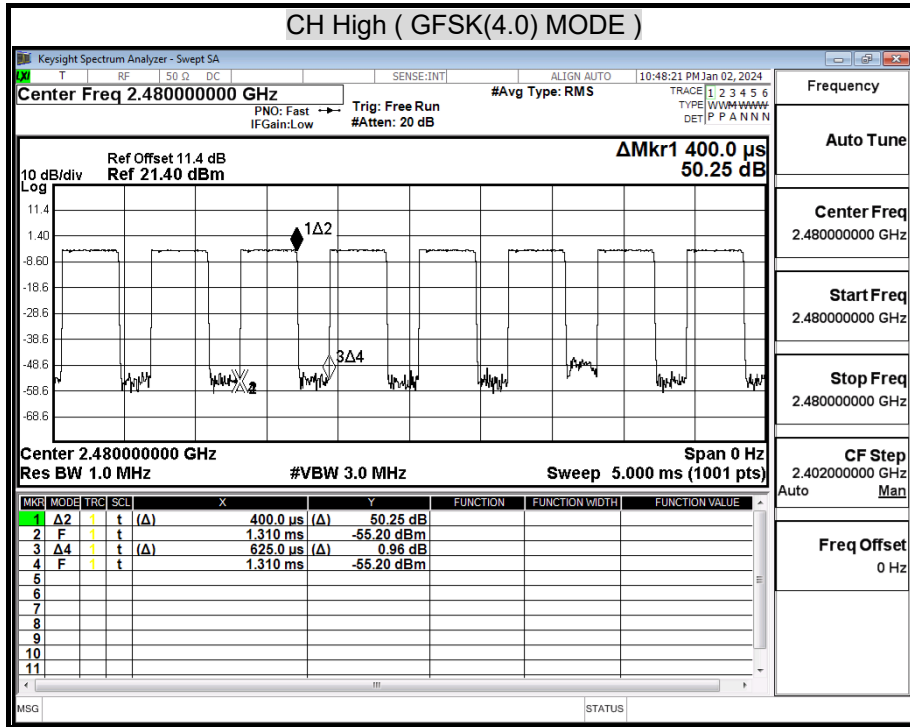

Report No.: TMTN2312001595NR

## Duty Cycle

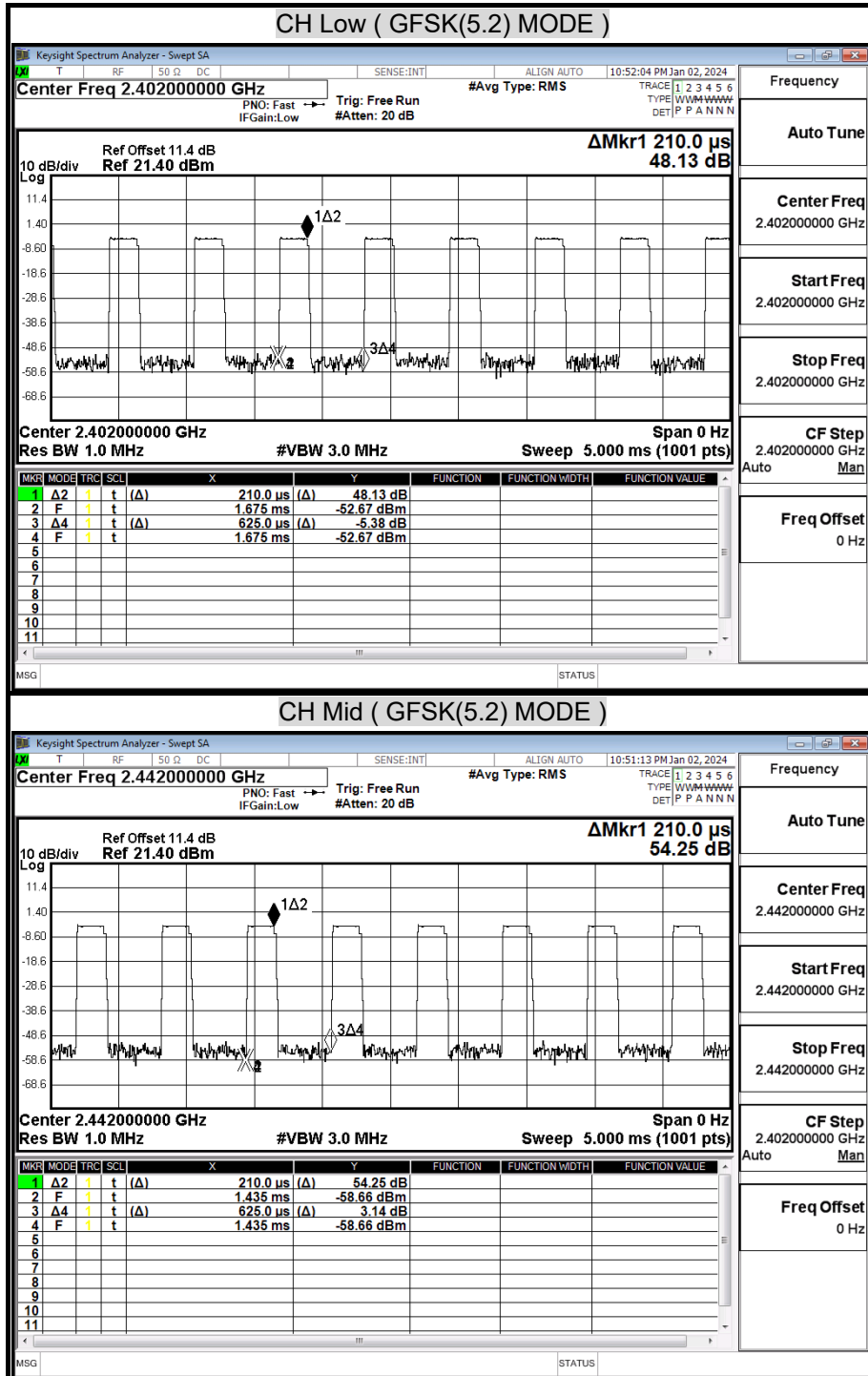

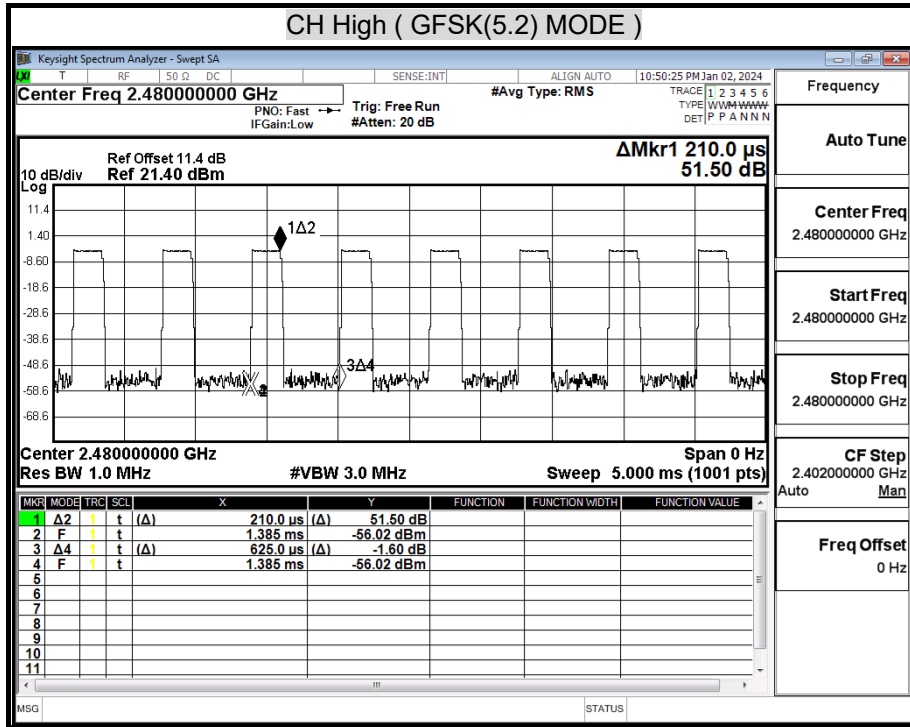

## 9.4 POWER SPECTRAL DENSITY

### LIMIT

§ 15.247(e) For digitally modulated systems, the power spectral density conducted from the intentional radiator to the antenna shall not greater than 8 dBm in any 3 kHz band during any time interval of continuous transmission.

### TEST SETUP

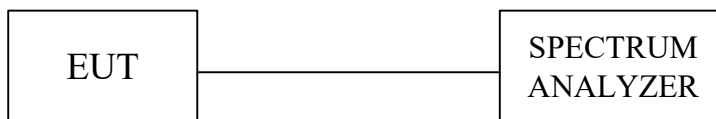

### TEST PROCEDURE

The tests were performed in accordance with 558074 D01 15.247 Meas Guidance v05

#### 10.2 Method PKPSD (peak PSD):

1. Set analyzer center frequency to DTS channel center frequency.
2. Set the span to 1.5 times the DTS bandwidth.
3. Set the RBW to:  $3 \text{ kHz} \leq \text{RBW} \leq 100 \text{ kHz}$ .
4. Set the VBW  $\geq 3 \times \text{RBW}$ .
5. Detector = peak.
6. Sweep time = auto couple.
7. Trace mode = max hold.
8. Allow trace to fully stabilize.
9. Use the peak marker function to determine the maximum amplitude level within the RBW.
10. If measured value exceeds limit, reduce RBW (no less than 3 kHz) and repeat.



Report No.: TMTN2312001595NR

**TEST RESULTS**

No non-compliance noted.

<b>Model Name</b>	AT-LP70XBT	<b>Test By</b>	Peter Chu
<b>Temp &amp; Humidity</b>	22.5°C, 45%	<b>Test Date</b>	2023/12/27

**GFSK(4.0) mode**

Channel	Frequency (MHz)	PPSD/3kHz (dBm)	Limit (dBm)	Margin (dB)	Result
Low	2402	-19.93	8.00	-27.93	PASS
Middle	2442	-19.99	8.00	-27.99	PASS
High	2480	-20.29	8.00	-28.29	PASS

**NOTE :** 1. At final test to get the worst-case emission at 1Mbps long.  
2. The cable assembly insertion loss of 11.4dB was entered as an offset in the spectrum analyzer to allow for direct reading of power.

**GFSK(5.2) mode**

Channel	Frequency (MHz)	PPSD/3kHz (dBm)	Limit (dBm)	Margin (dB)	Result
Low	2402	-23.59	8.00	-31.59	PASS
Middle	2442	-23.61	8.00	-31.61	PASS
High	2480	-23.94	8.00	-31.94	PASS

**NOTE :** 1. At final test to get the worst-case emission at 2Mbps long.  
2. The cable assembly insertion loss of 11.4dB was entered as an offset in the spectrum analyzer to allow for direct reading of power.

## POWER SPECTRAL DENSITY ( GFSK(4.0) MODE)

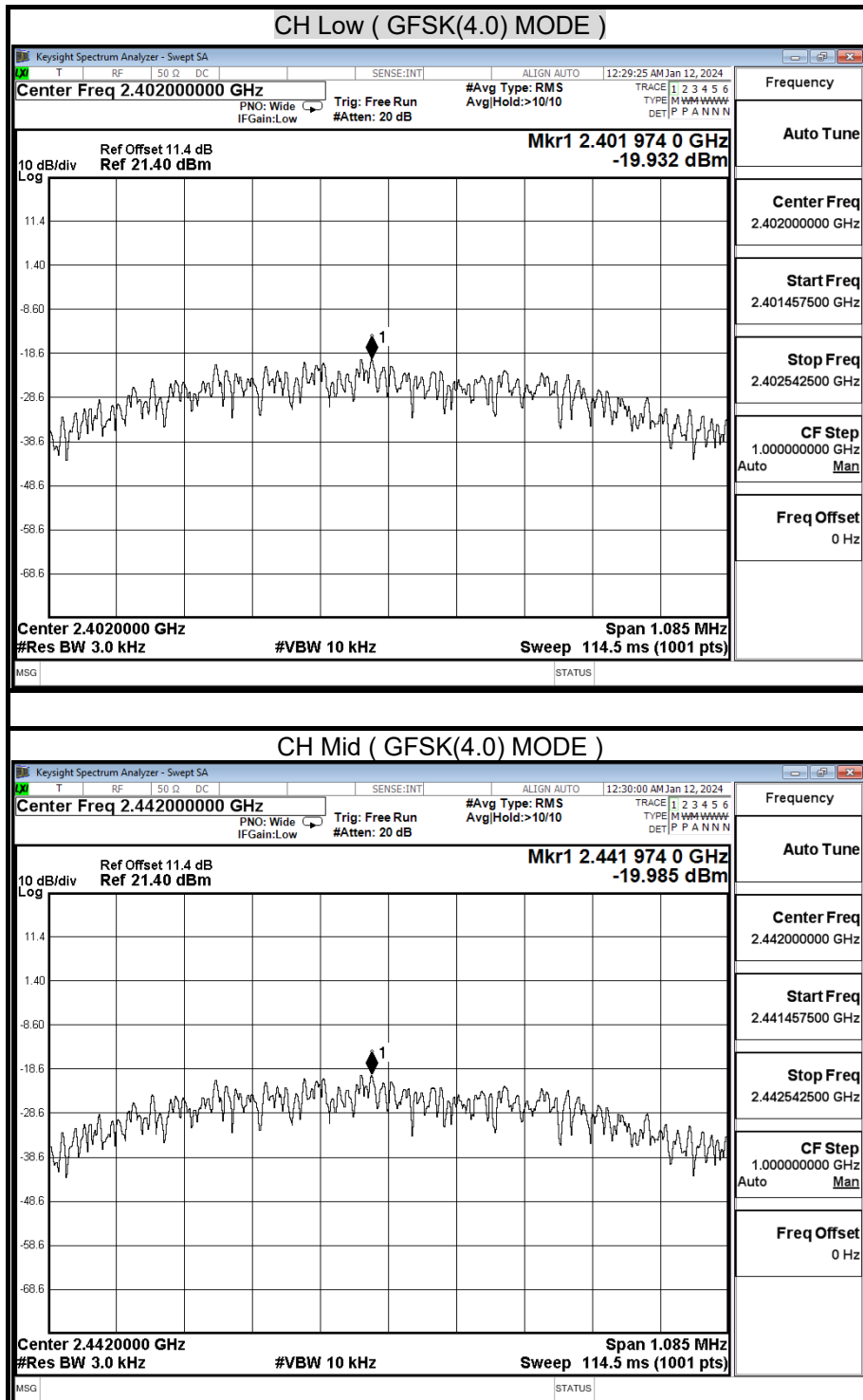

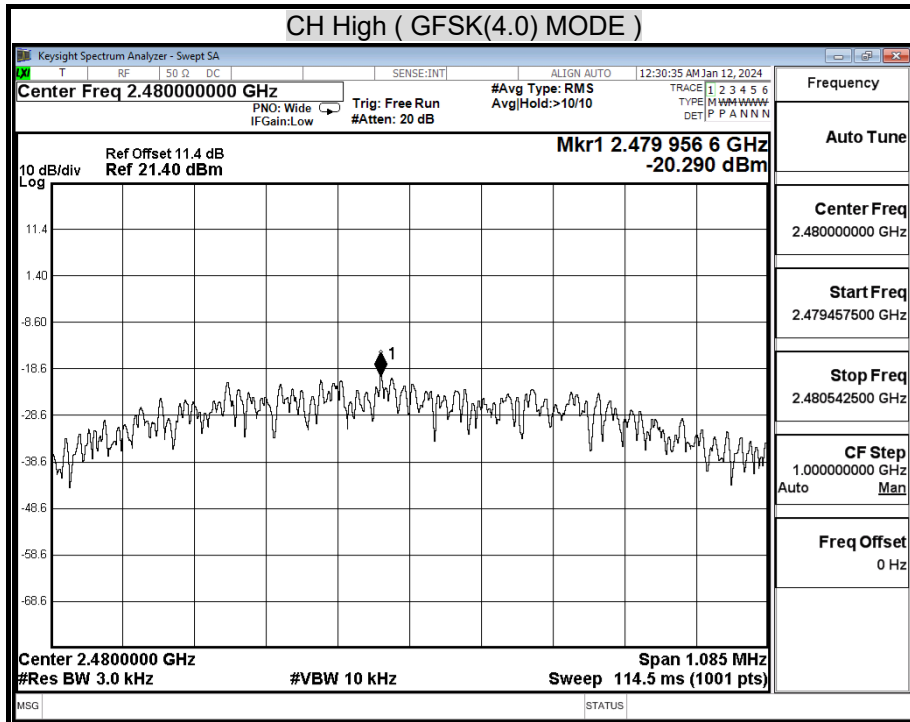

## POWER SPECTRAL DENSITY ( GFSK(5.2) MODE)

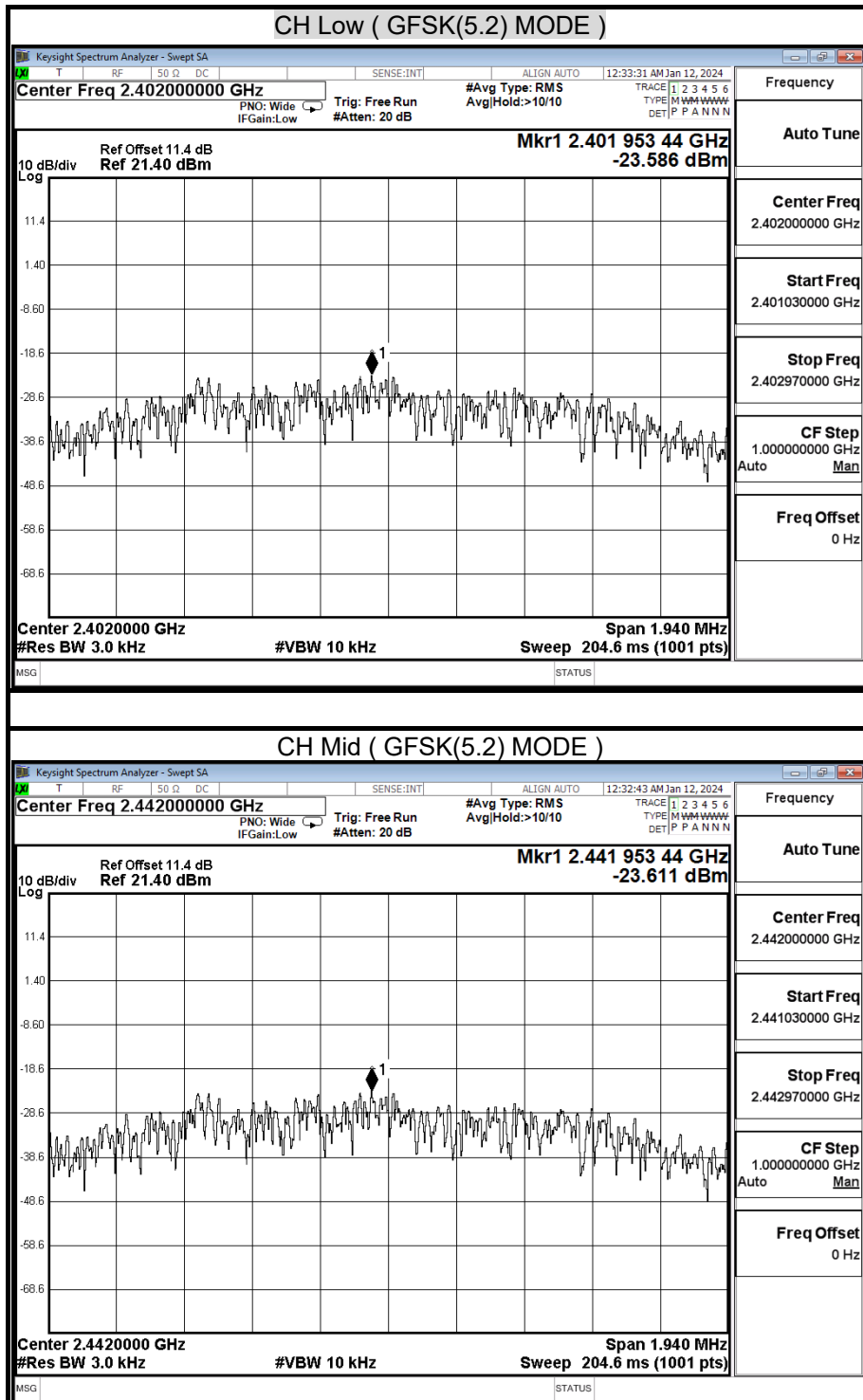

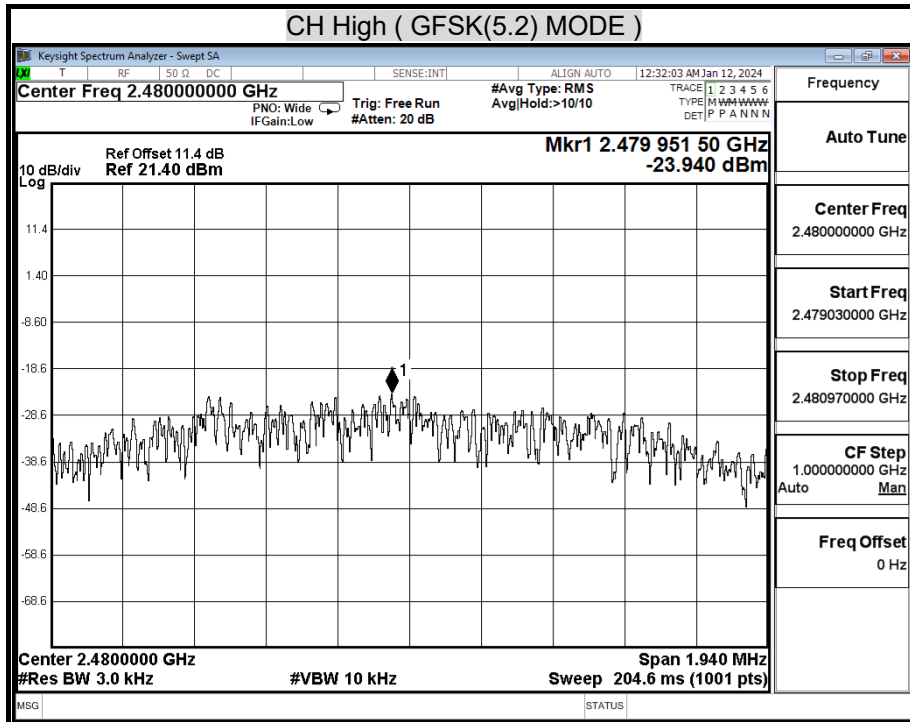

## 9.5 CONDUCTED SPURIOUS EMISSION

### LIMITS

§ 15.247(d) In any 100 kHz bandwidth outside the frequency band in which the spread spectrum intentional radiator is operating, the radio frequency power that is produced by the intentional radiator shall be at least 20 dB below that in the 100 kHz bandwidth within the and that contains the highest level of the desired power, based on either an RF conducted or a radiated measurement. Attenuation below the general limits specified in § 15.209(a) is not required. In addition, radiated emissions which fall in the restricted bands, as defined in § 15.205(a), must also comply with the radiated emission limits specified in § 15.209(a) (see § 15.205(c)).

### TEST SETUP

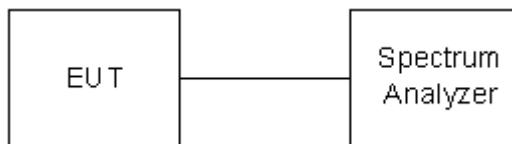

### TEST PROCEDURE

The transmitter output is connected to a spectrum analyzer. The resolution bandwidth is set to 100kHz , the video bandwidth is set to 300kHz.

The spectrum from 30 MHz to 26.5 GHz is investigated with the transmitter set to the lowest, middle, and highest channels in the 2.4 GHz band.

### TEST RESULTS

No non-compliance noted.

**TEST DATA**

<b>Model Name</b>	AT-LP70XBT	<b>Test By</b>	Peter Chu
<b>Temp &amp; Humidity</b>	22.5°C, 45%	<b>Test Date</b>	2023/12/27

**OUT-OF-BAND SPURIOUS EMISSIONS-CONDUCTED MEASUREMENT**

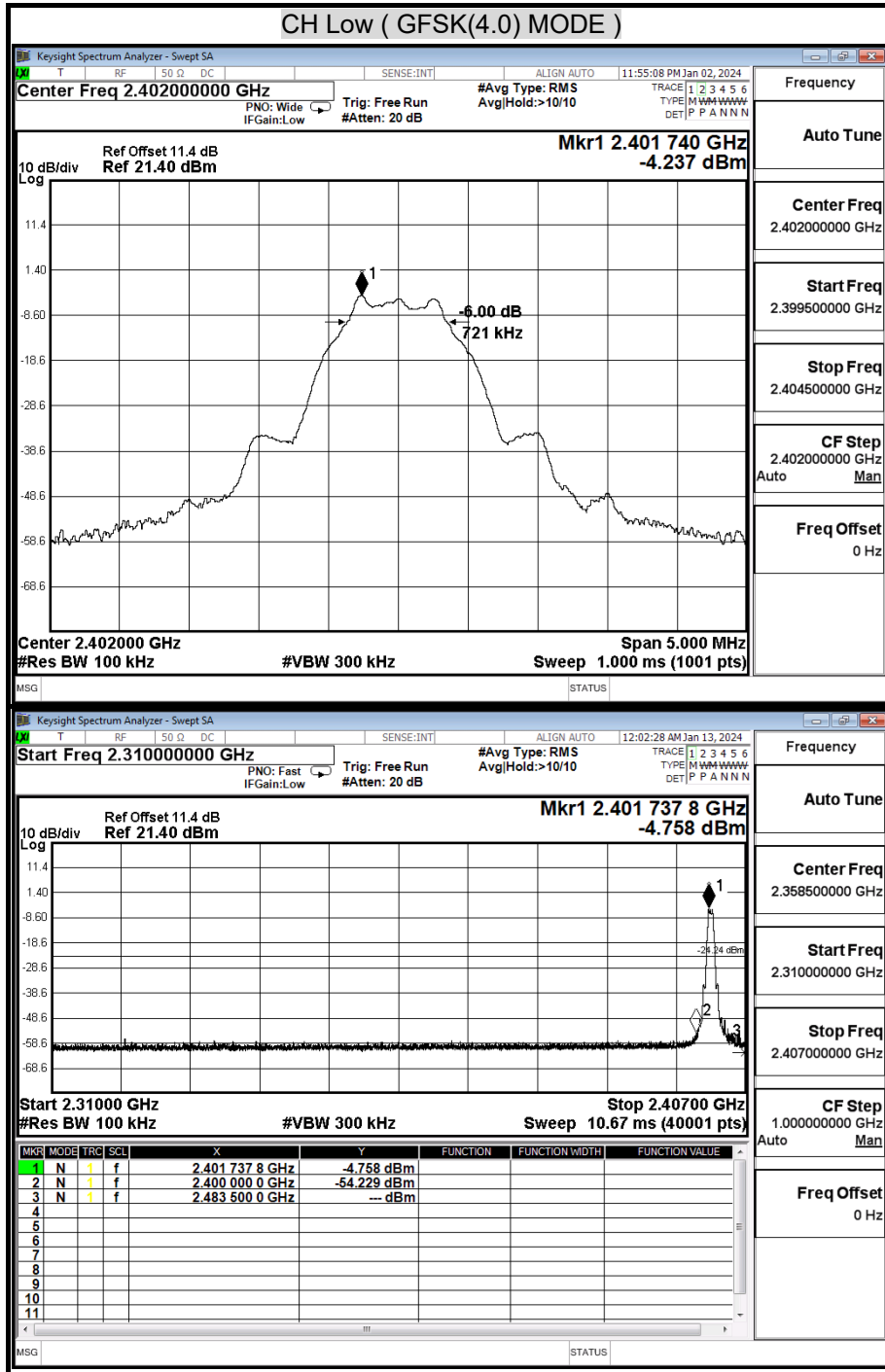

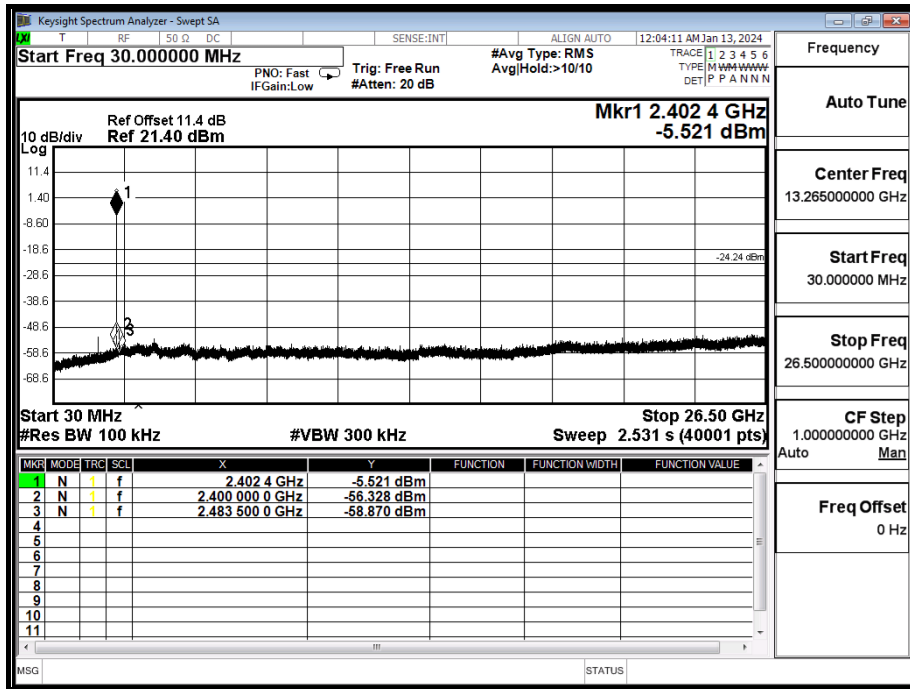



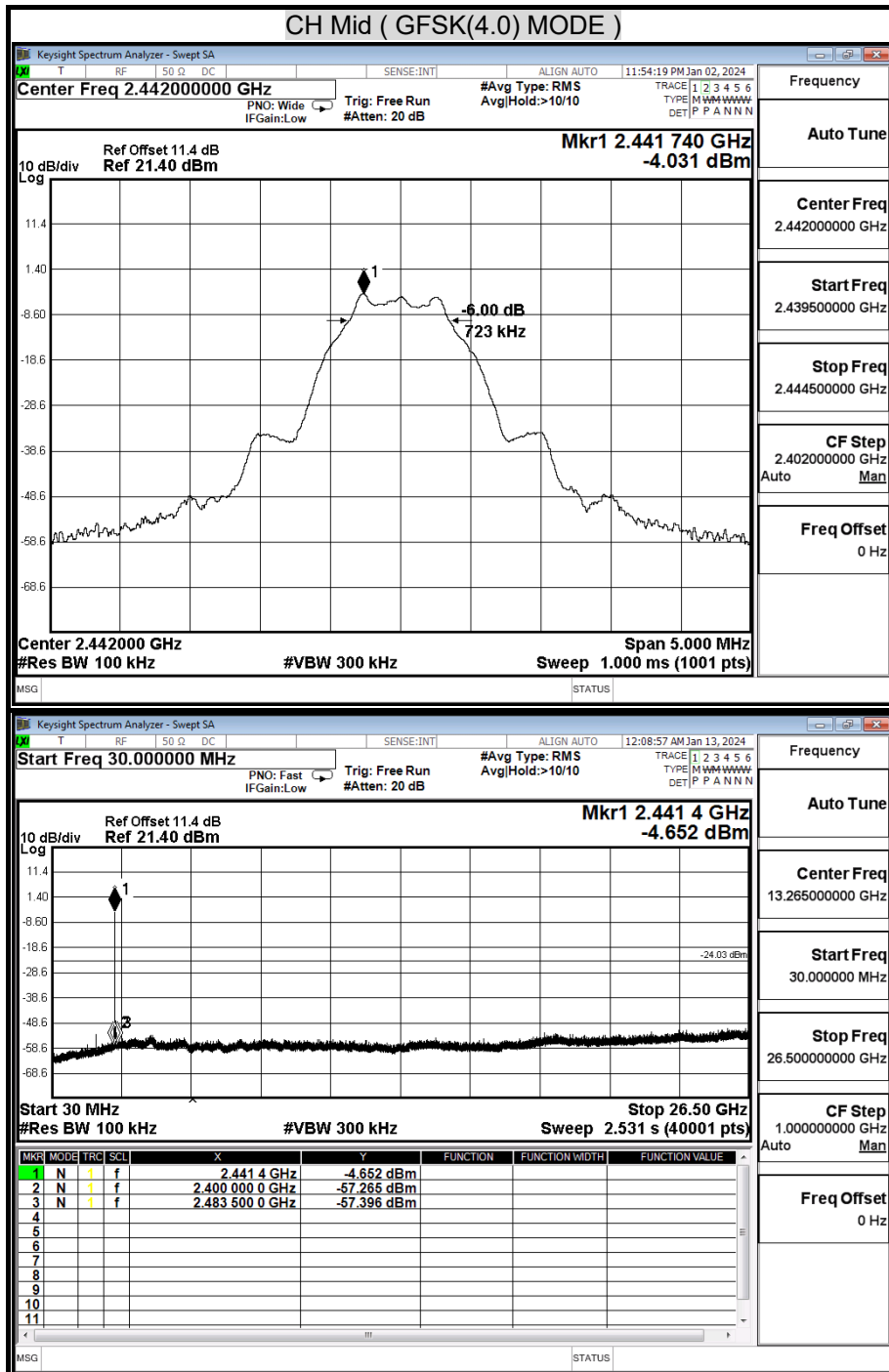

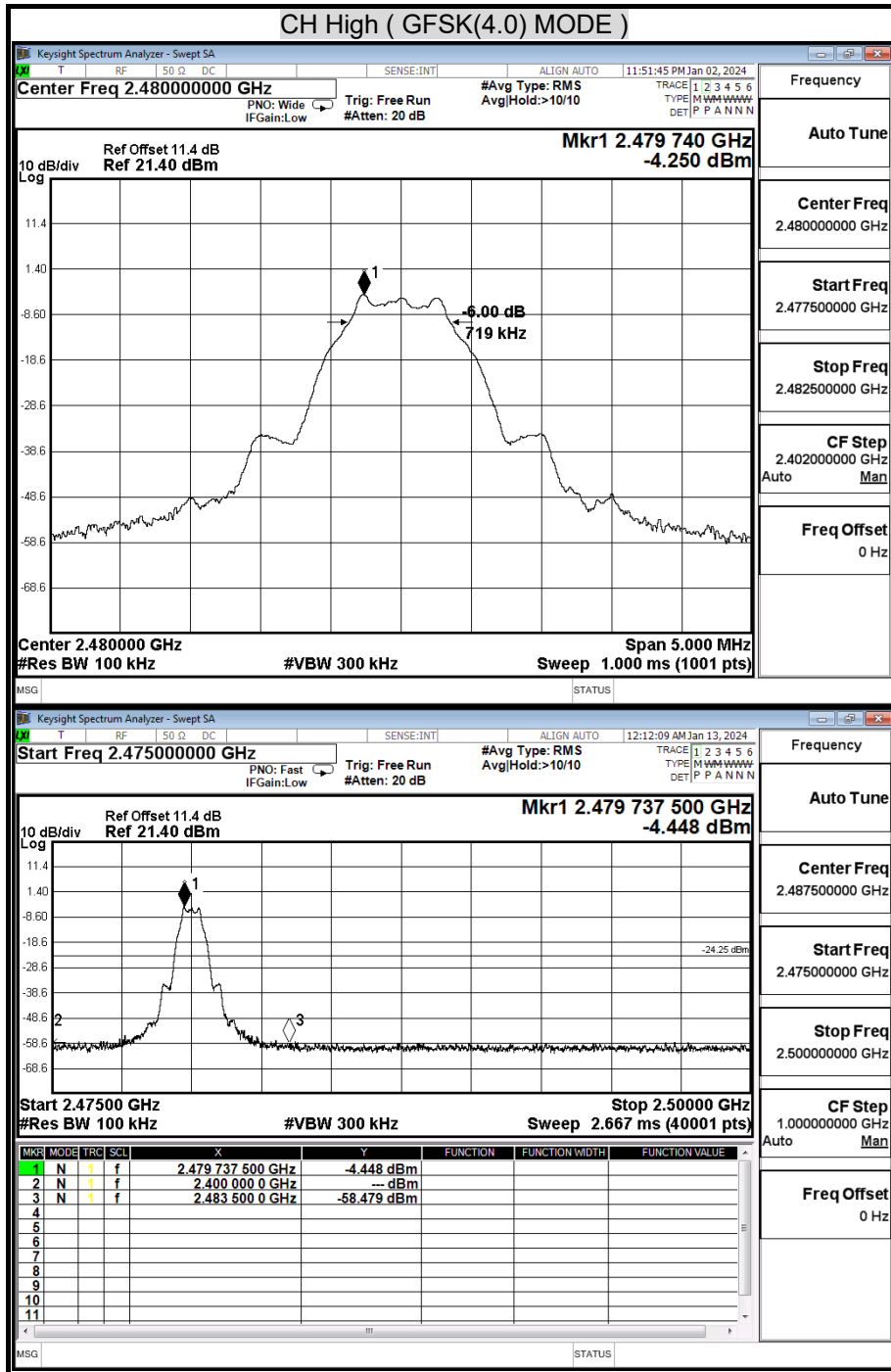

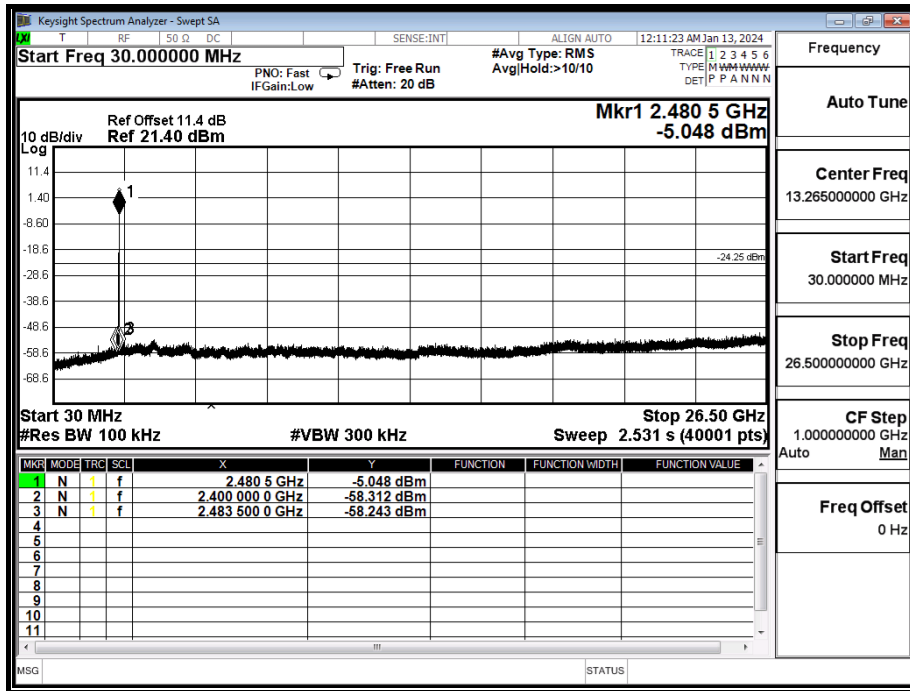

<b>Model Name</b>	AT-LP70XBT	<b>Test By</b>	Peter Chu
<b>Temp &amp; Humidity</b>	22.5°C, 45%	<b>Test Date</b>	2023/12/27

## OUT-OF-BAND SPURIOUS EMISSIONS-CONDUCTED MEASUREMENT

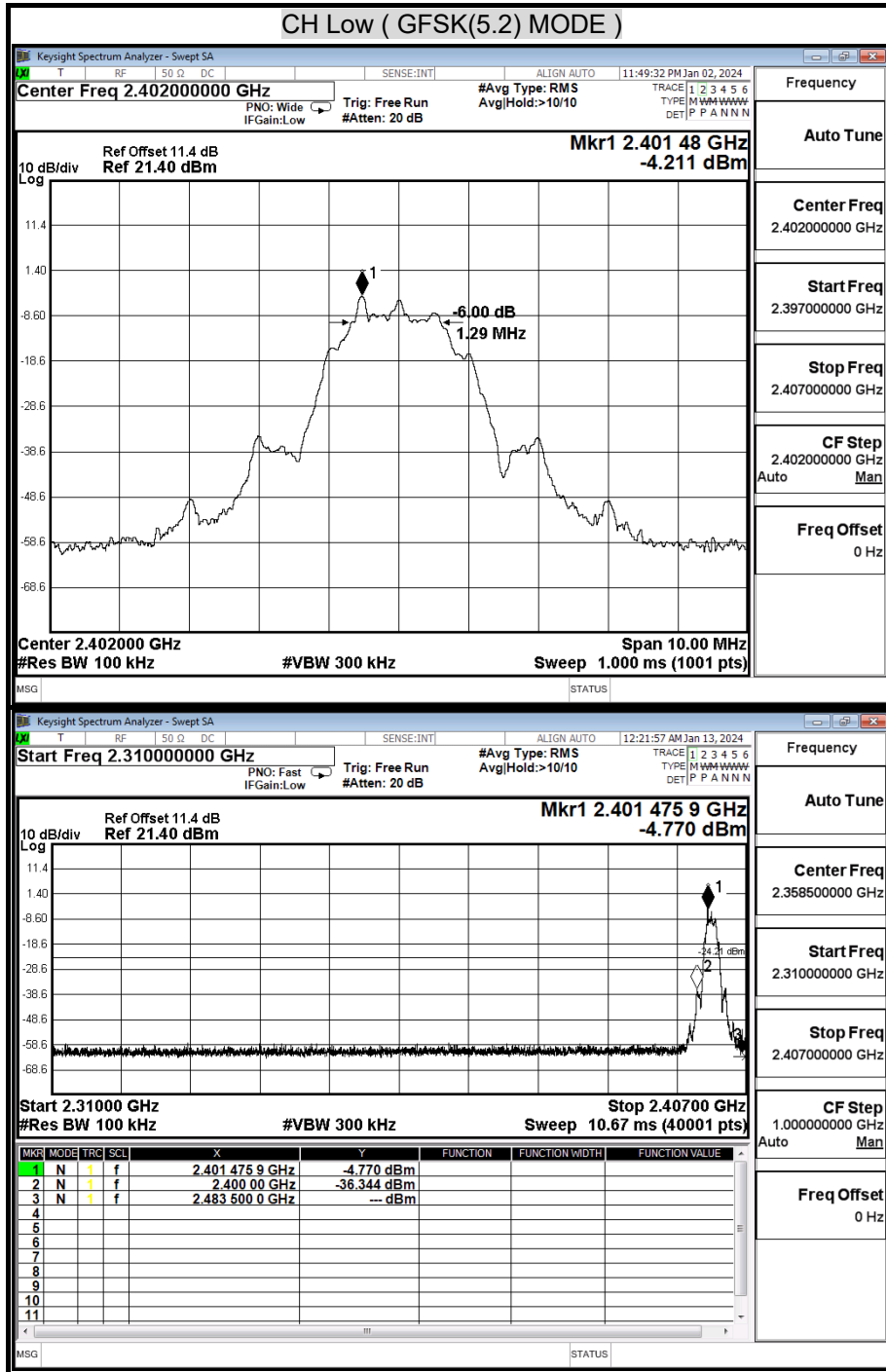

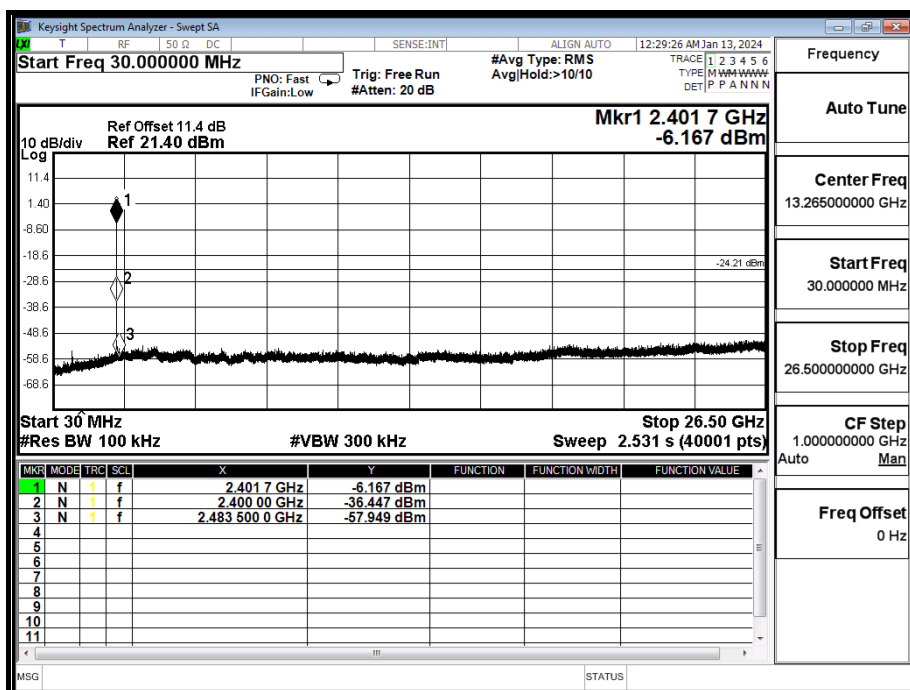

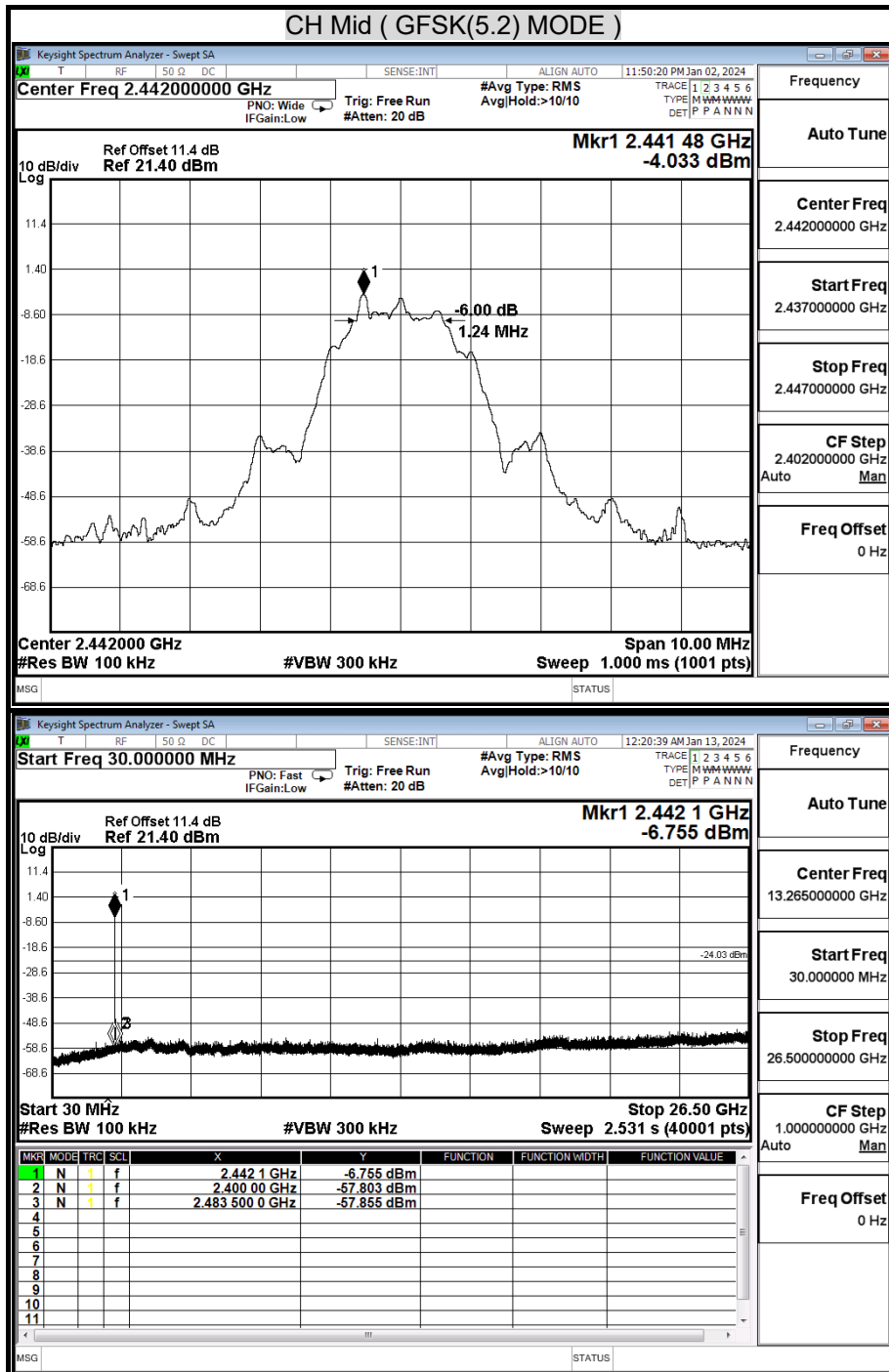

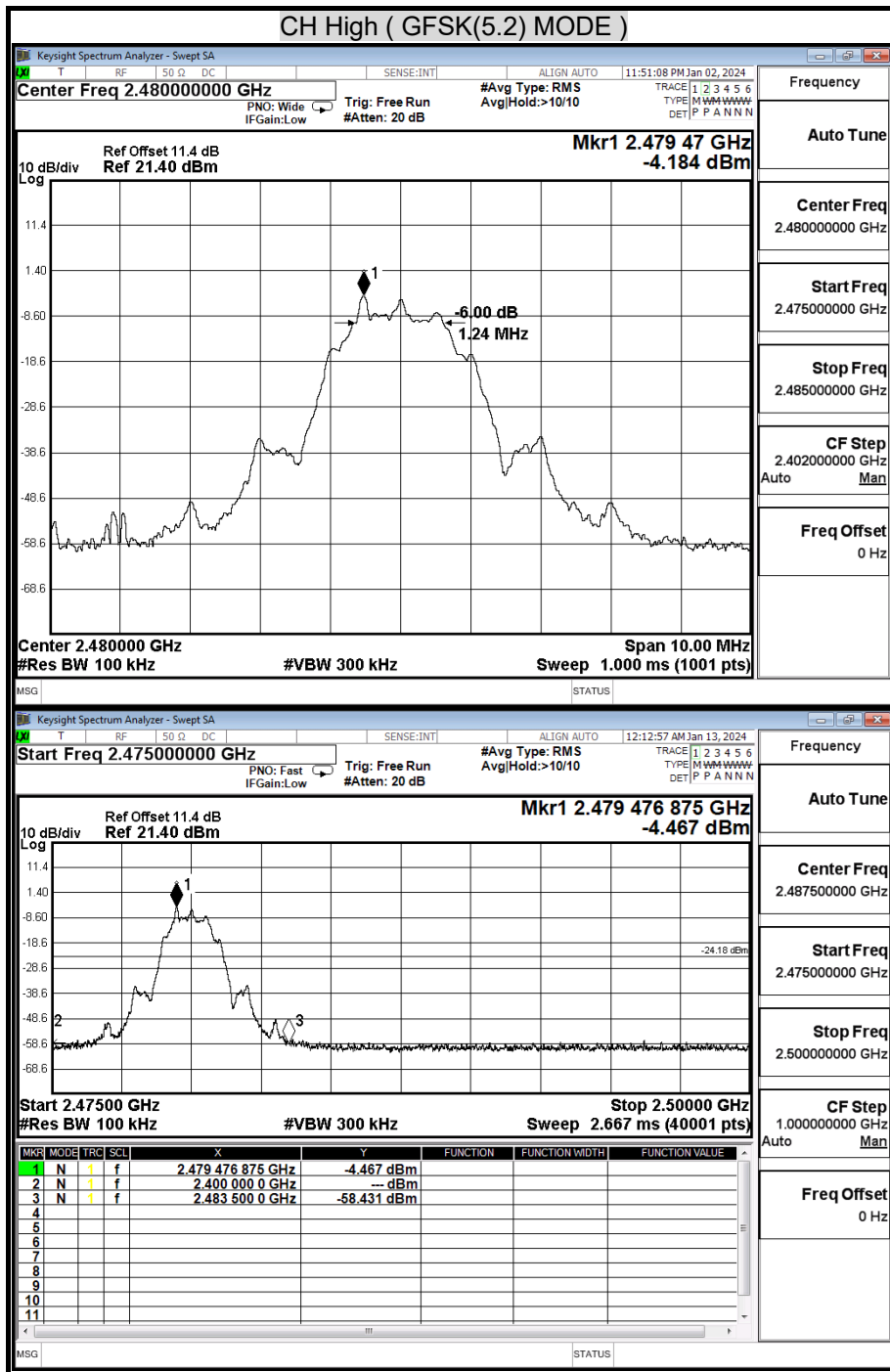

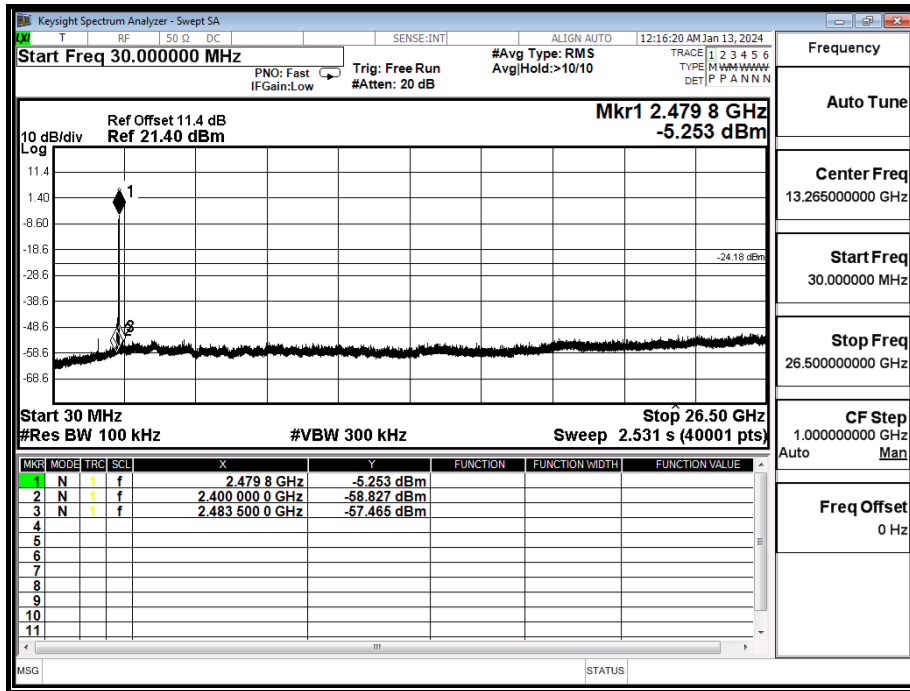



## 9.6 RADIATED EMISSIONS

### 9.6.1 TRANSMITTER RADIATED SUPURIOUS EMISSIONS

#### LIMITS

§ 15.205 (a) Except as shown in paragraph (d) of this section, only spurious emissions are permitted in any of the frequency bands listed below:

MHz	MHz	MHz	GHz
0.090 - 0.110	16.42 - 16.423	399.9 - 410	4.5 - 5.15
10.495 - 0.505	16.69475 - 16.69525	608 - 614	5.35 - 5.46
2.1735 - 2.1905	16.80425 - 16.80475	960 - 1240	7.25 - 7.75
4.125 - 4.128	25.5 - 25.67	1300 - 1427	8.025 - 8.5
4.17725 - 4.17775	37.5 - 38.25	1435 - 1626.5	9.0 - 9.2
4.20725 - 4.20775	73 - 74.6	1645.5 - 1646.5	9.3 - 9.5
6.215 - 6.218	74.8 - 75.2	1660 - 1710	10.6 - 12.7
6.26775 - 6.26825	108 - 121.94	1718.8 - 1722.2	13.25 - 13.4
6.31175 - 6.31225	123 - 138	2200 - 2300	14.47 - 14.5
8.291 - 8.294	149.9 - 150.05	2310 - 2390	15.35 - 16.2
8.362 - 8.366	156.52475 - 156.52525	2483.5 - 2500	17.7 - 21.4
8.37625 - 8.38675	156.7 - 156.9	2655 - 2900	22.01 - 23.12
8.41425 - 8.41475	162.0125 - 167.17	3260 - 3267	23.6 - 24.0
12.29 - 12.293	167.72 - 173.2	3332 - 3339	31.2 - 31.8
12.51975 - 12.52025	240 - 285	3345.8 - 3338	36.43 - 36.5
12.57675 - 12.57725	322 - 335.4	3600 - 4400	( <sup>2</sup> )
13.36 - 13.41			

<sup>1</sup> Until February 1, 1999, this restricted band shall be 0.490-0.510 MHz.

<sup>2</sup> Above 38.6

§ 15.205 (b) Except as provided in paragraphs (d) and (e), the field strength of emissions appearing within these frequency bands shall not exceed the limits shown in Section 15.209. At frequencies equal to or less than 1000 MHz, compliance with the limits in Section 15.209 shall be demonstrated using measurement instrumentation employing a CISPR quasi-peak detector. Above 1000 MHz, compliance with the emission limits in Section 15.209 shall be demonstrated based on the average value of the measured emissions. The provisions in Section 15.35 apply to these measurements.

**Report No.:** TMTN2312001595NR

§ 15.209 (a) Except as provided elsewhere in this Subpart, the emissions from an intentional radiator shall not exceed the field strength levels specified in the following table :

<b>Frequency (MHz)</b>	<b>Field Strength (microvolts/meter)</b>	<b>Measurement Distance (meters)</b>
30 - 88	100 **	3
88 - 216	150 **	3
216 - 960	200 **	3
Above 960	500	3

\*\* Except as provided in paragraph (g), fundamental emissions from intentional radiators operating under this Section shall not be located in the frequency bands 54-72 MHz, 76-88 MHz, 174-216 MHz or 470-806 MHz, However, operation within these frequency bands is permitted under other sections of this Part, e-g, Sections 15.231 and 15.241.

§ 15.209 (b) In the emission table above, the tighter limit applies at the band edges.

## TEST SETUP

The diagram below shows the test setup that is utilized to make the measurements for emission from below 1GHz.

### 9kHz ~ 30MHz

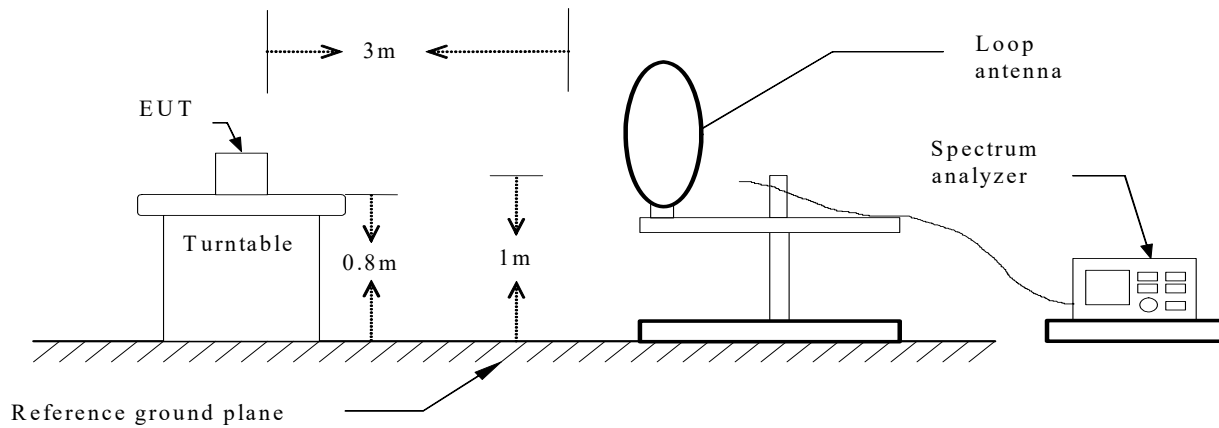

### 30MHz ~ 1GHz

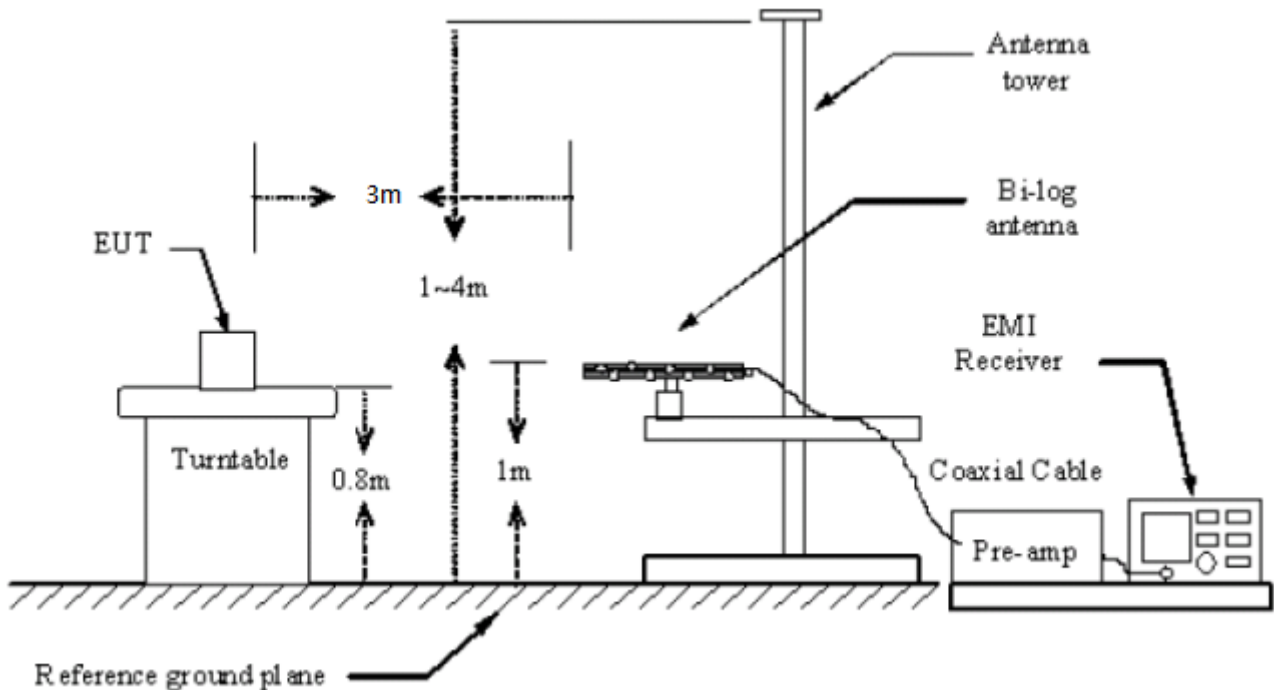

Report No.: TMTN2312001595NR

The diagram below shows the test setup that is utilized to make the measurements for emission above 1GHz.

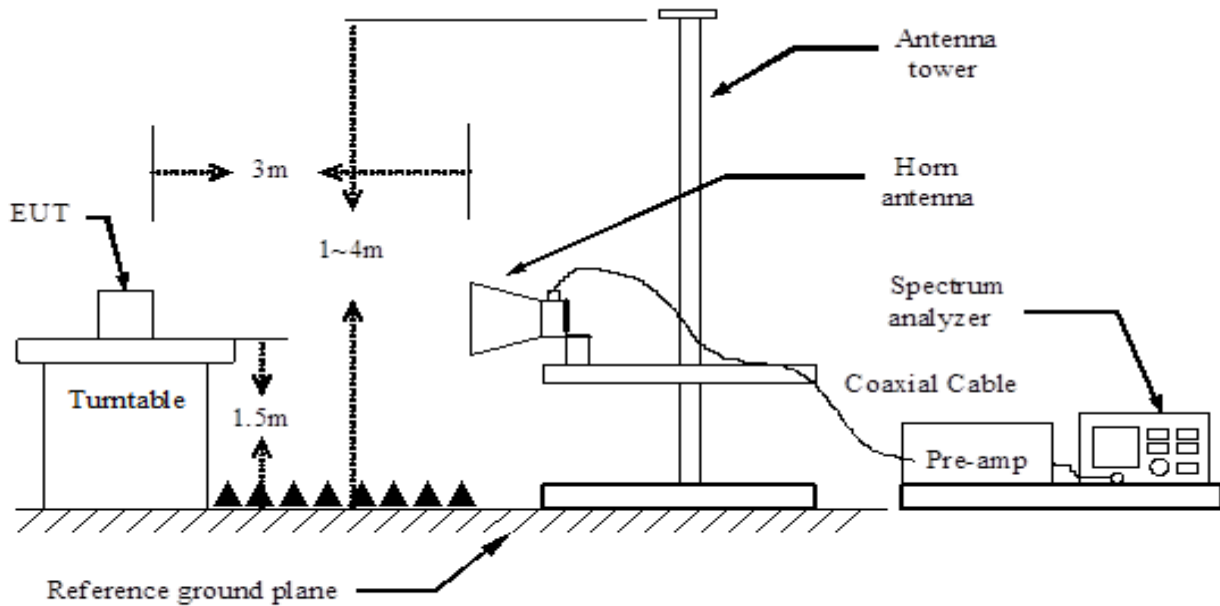

## TEST PROCEDURE

- The EUT was placed on the top of a rotating table 0.8/1.5 meters above the ground at a 3 meter chamber test site. The table was rotated 360 degrees to determine the position of the highest radiation.
- While measuring the radiated emission below 1GHz, the EUT was set 3 meters away from the interference-receiving antenna, which was mounted on the top of a variable-height antenna tower. While measuring the radiated emission above 1GHz, the EUT was set 3 meters away from the interference-receiving antenna
- The antenna is a broadband antenna, and its height is varied from one meter to four meters above the ground to determine the maximum value of the field strength. Both horizontal and vertical polarization of the antenna are set to make the measurement.
- For each suspected emission, the EUT was arranged to its worst case and then the antenna was tuned to heights from 1 meter to 4 meters and the table was turned from 0 degrees to 360 degrees to find the maximum reading.
- The spectrum analyzer was set to Peak Detect Function and Specified Bandwidth with Maximum Hold Mode.
- If the emission level of the EUT in peak mode was 10 dB lower than the limit specified, then testing could be stopped and the peak values of the EUT would be reported. Otherwise the emissions that did not have 10 dB margin would be re-tested one by one using peak, quasi-peak or average method as specified and then reported in a data sheet.
- The tests were performed in accordance with 558074 D01 15.247 Meas Guidance v05

**NOTE:**

1. The resolution bandwidth of test receiver is 200Hz for Quasi-peak detection (QP) at frequency 9~150(kHz).
2. The resolution bandwidth of test receiver is 9kHz for Quasi-peak detection (QP) at frequency 0.15~30(MHz).
3. The resolution bandwidth of test receiver is 120kHz for Quasi-peak detection (QP) at frequency 30~1000(MHz).
4. The resolution bandwidth and video bandwidth of test receiver/spectrum analyzer is 1 MHz for Peak detection and frequency above 1GHz.
5. The resolution bandwidth of test receiver/spectrum analyzer is 1 MHz and the video bandwidth  $\leq 1/T$  for Average detection (AV) at frequency above 1GHz.

**TEST RESULTS**

No non-compliance noted

Report No.: TMTN2312001595NR

## 9.6.2 WORST-CASE RADIATED EMISSION BELOW 1 GHz

### 9kHz~150kHz

No emission found between lowest internal used/generated frequency to 30MHz.

### 30MHz ~ 1GHz

Test Voltage: AC 120V, 60Hz

Product Name	AUTOMATIC WIRELESS TURNTABLE	Test Date	2023/12/28
Model Name	AT-LP70XBT	Test By	Peter Chu
Test Mode	TX	Temp & Humidity	22.3°C, 49%

Vertical

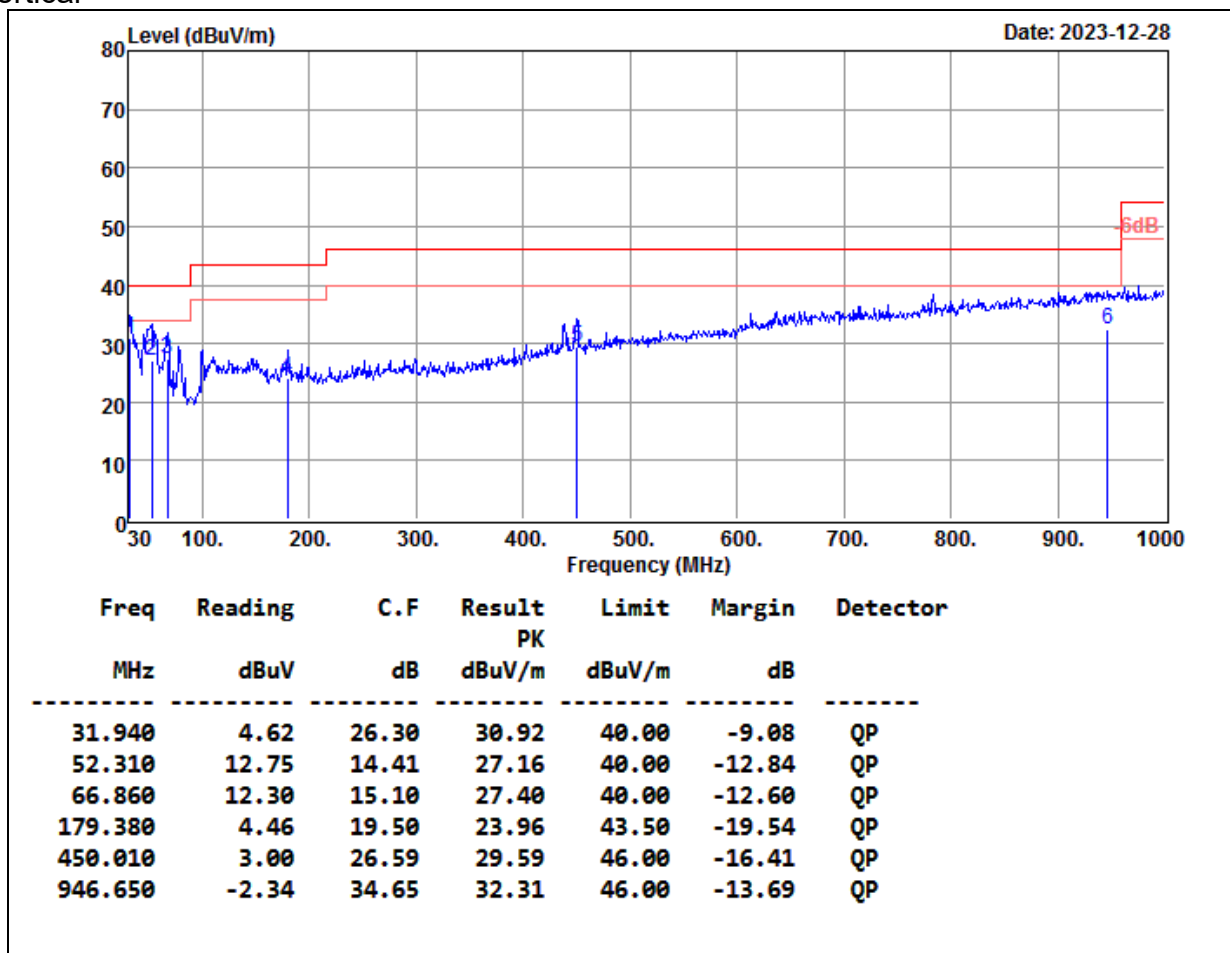

#### REMARK:

1. Test receiver setting QP(Qusai Peak): RBW=120kHz
2. C.F=Antenna Factor+Cable Loss
3. The result basic equation calculation is as follow: Result = Reading + C.F, Margin = Result-Limit
4. The other emission levels were 10dB below the limit
5. The test distance is 3m.

<b>Product Name</b>	AUTOMATIC WIRELESS TURNTABLE	<b>Test Date</b>	2023/12/28
<b>Model Name</b>	AT-LP70XBT	<b>Test By</b>	Peter Chu
<b>Test Mode</b>	TX	<b>Temp &amp; Humidity</b>	22.3°C, 49%

Horizontal

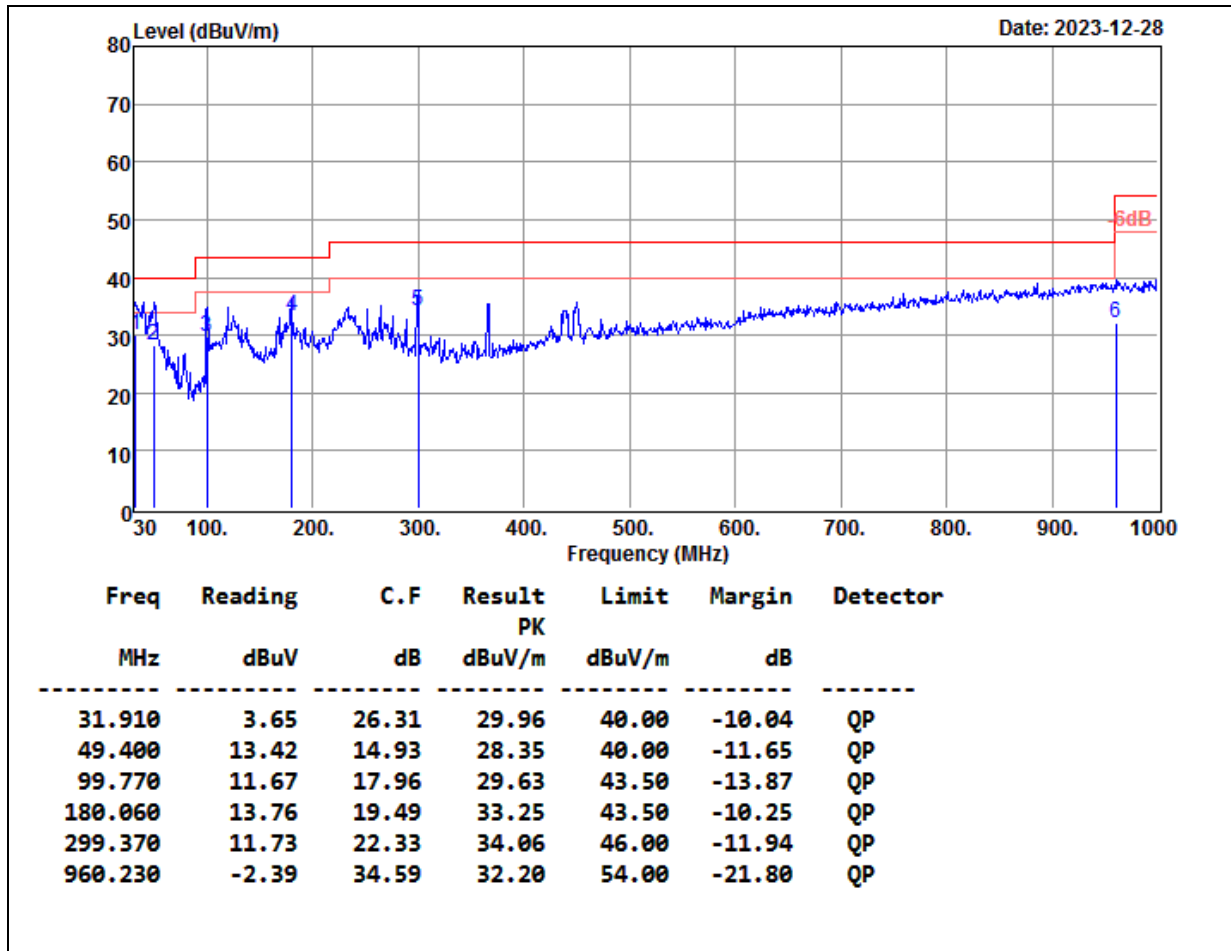

**REMARK:**

1. Test receiver setting QP(Qusai Peak): RBW=120kHz
2. C.F=Antenna Factor+Cable Loss
3. The result basic equation calculation is as follow: Result = Reading + C.F, Margin = Result-Limit
4. The other emission levels were 10dB below the limit
5. The test distance is 3m.

Report No.: TMTN2312001595NR

## 9.6.3 TRANSMITTER RADIATED EMISSION ABOVE 1 GHz

<b>Product Name</b>	AUTOMATIC WIRELESS TURNTABLE	<b>Test Date</b>	2023/12/27
<b>Model</b>	AT-LP70XBT	<b>Test By</b>	Peter Chu
<b>Test Mode</b>	GFSK(4.0) TX (CH Low)	<b>TEMP&amp; Humidity</b>	21.8°C, 47%

Vertical

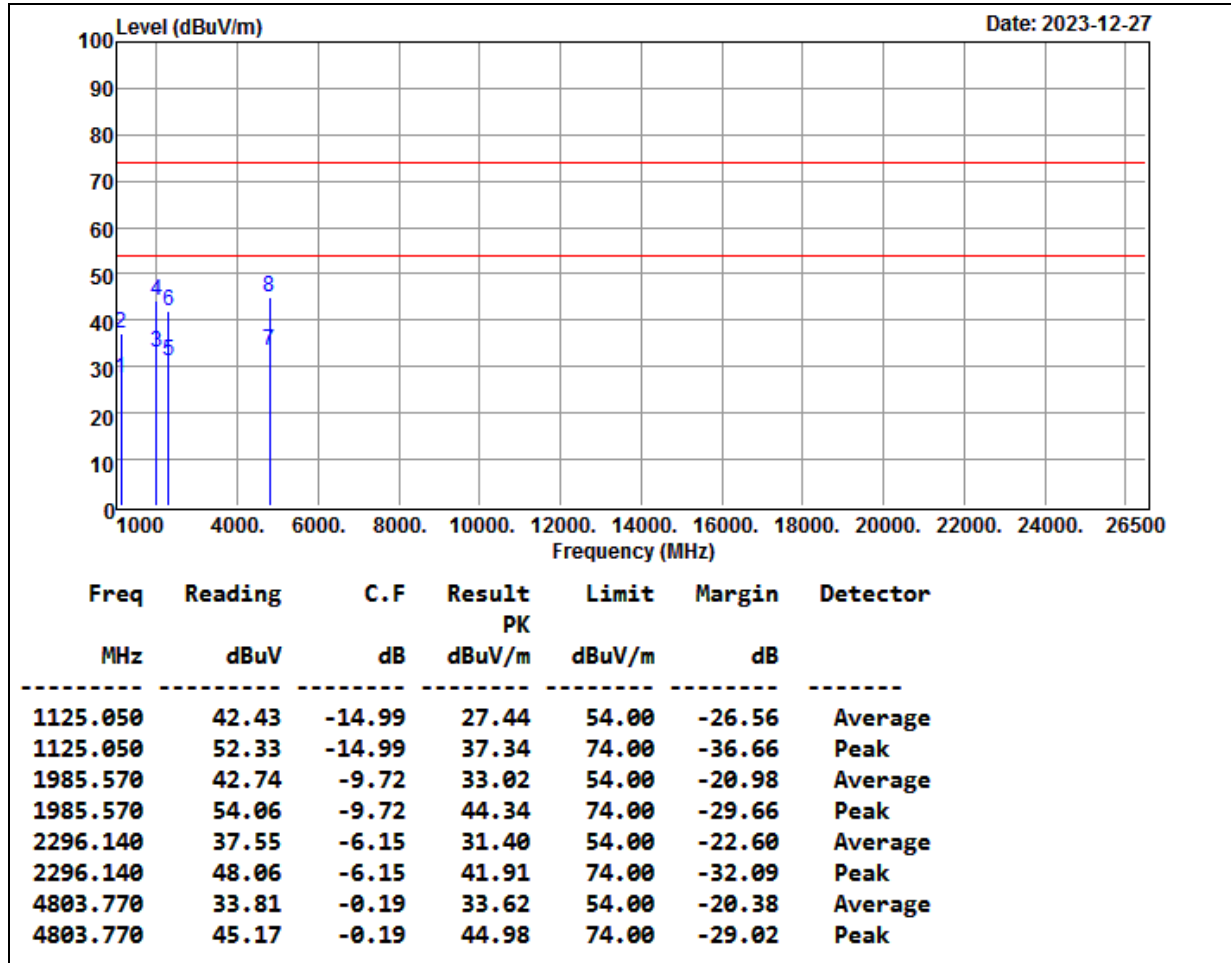

### REMARK:

1. Spectrum analyzer setting Peak: RBW=1MHz, VBW=3MHz, Average: RBW=1MHz, VBW ≥ 1/T
2. C.F=Antenna Factor+Cable Loss-Preamplifier gain+2.4GHz~2.5GHz Filter Insertion Loss
3. The result basic equation calculation is as follow: Result = Reading + C.F, Margin = Result-Limit
4. The other emission levels were 10dB below the limit
5. The test distance is 3m.



Report No.: TMTN2312001595NR

<b>Product Name</b>	AUTOMATIC WIRELESS TURNTABLE	<b>Test Date</b>	2023/12/27
<b>Model</b>	AT-LP70XBT	<b>Test By</b>	Peter Chu
<b>Test Mode</b>	GFSK(4.0) TX (CH Low)	<b>TEMP&amp; Humidity</b>	21.8°C, 47%

Horizontal

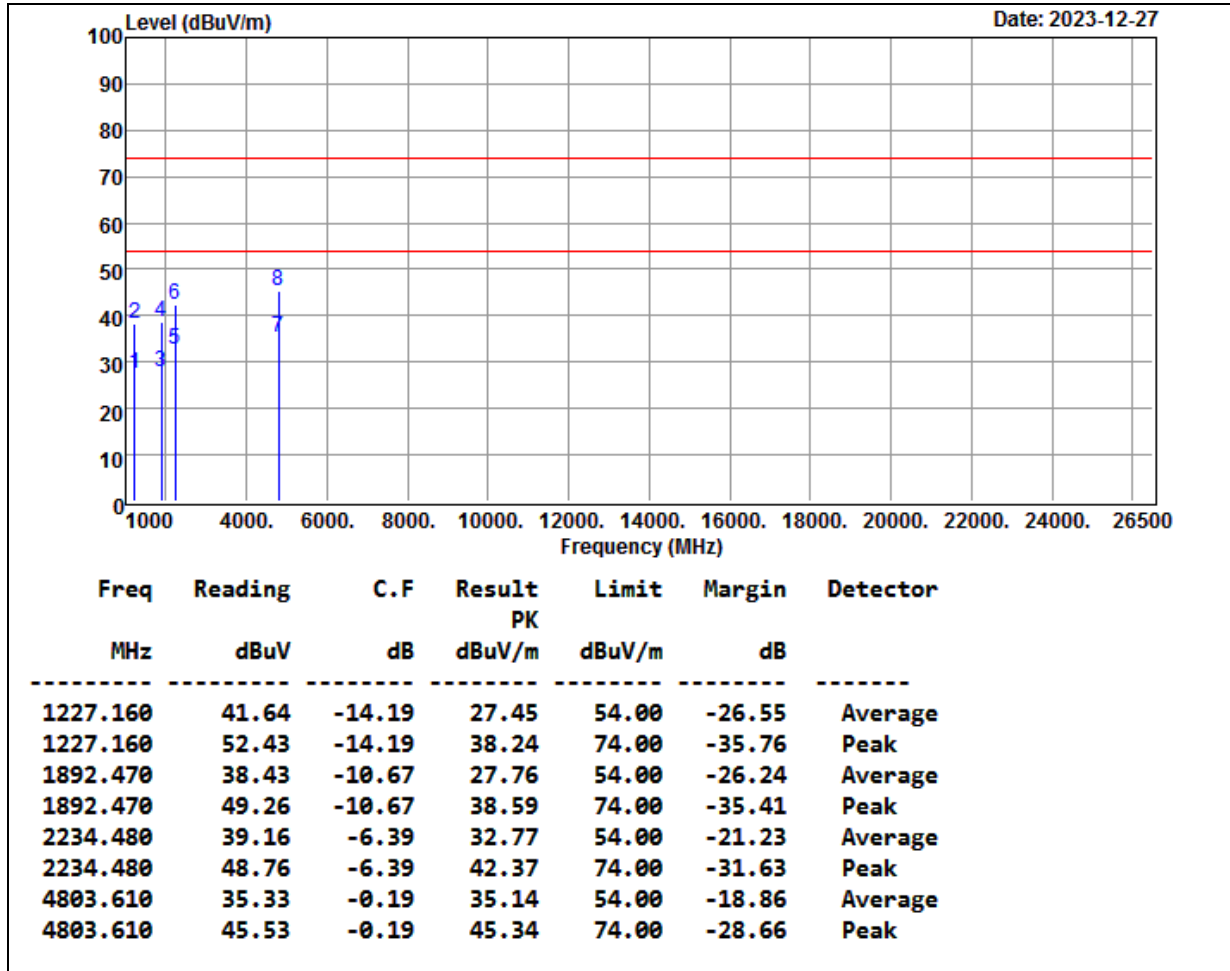

**REMARK:**

1. Spectrum analyzer setting Peak: RBW=1MHz, VBW=3MHz, Average: RBW=1MHz, VBW ≥ 1/T
2. C.F=Antenna Factor+Cable Loss-Preamplifier gain+2.4GHz~2.5GHz Filter Insertion Loss
3. The result basic equation calculation is as follow: Result = Reading + C.F, Margin = Result-Limit
4. The other emission levels were 10dB below the limit
5. The test distance is 3m.

<b>Product Name</b>	AUTOMATIC WIRELESS TURNTABLE	<b>Test Date</b>	2023/12/27
<b>Model</b>	AT-LP70XBT	<b>Test By</b>	Peter Chu
<b>Test Mode</b>	GFSK(4.0) TX (CH Middle)	<b>TEMP&amp; Humidity</b>	21.8°C, 47%

Vertical

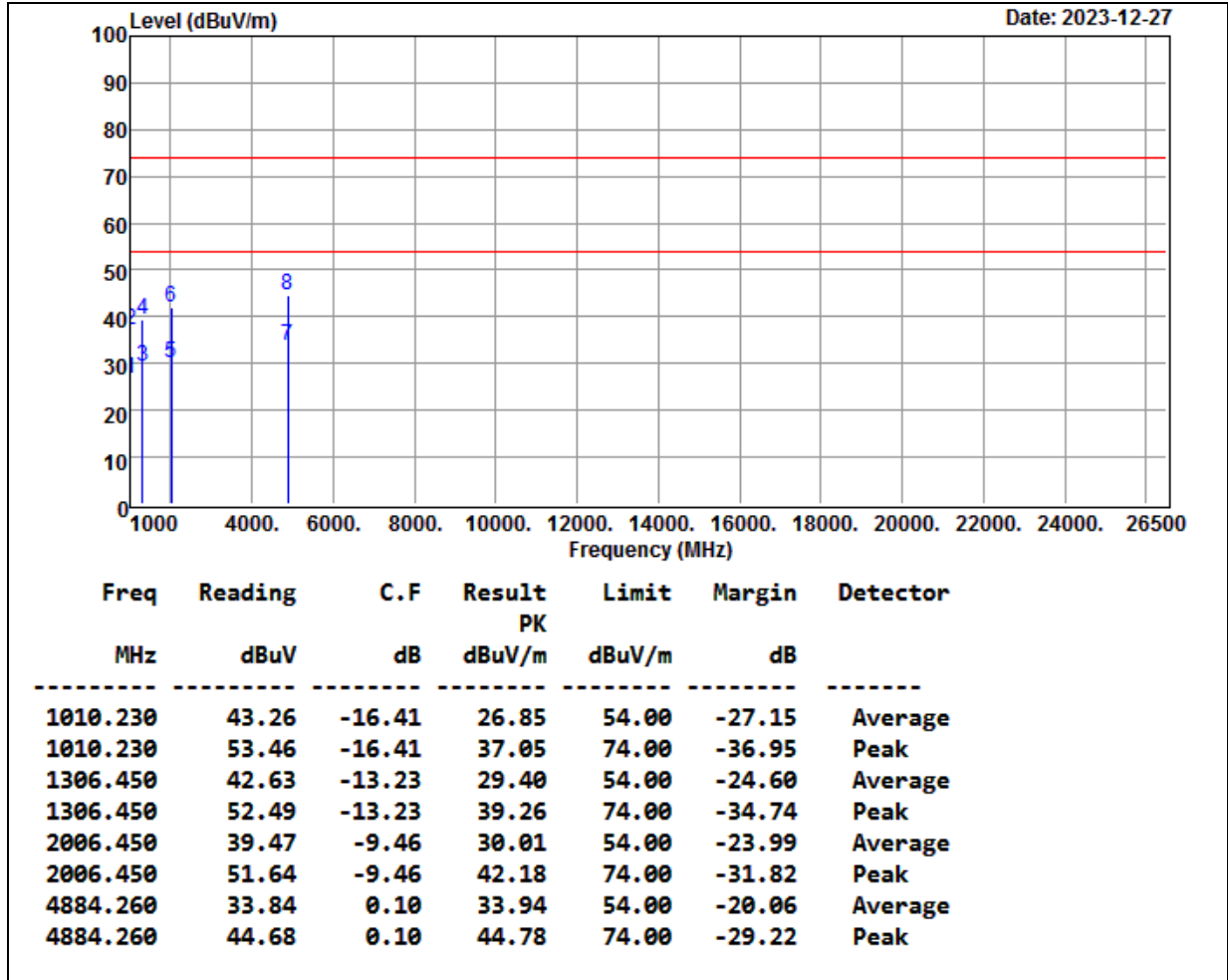

**REMARK:**

- 1.Spectrum analyzer setting Peak: RBW=1MHz, VBW=3MHz,Average: RBW=1MHz, VBW ≥ 1/T
- 2.C.F=Antenna Factor+Cable Loss-Preamplifier gain+2.4GHz~2.5GHz Filter Insertion Loss
- 3.The result basic equation calculation is as follow:Result = Reading + C.F, Margin = Result-Limit
- 4.The other emission levels were 10dB below the limit
- 5.The test distance is 3m.

<b>Product Name</b>	AUTOMATIC WIRELESS TURNTABLE	<b>Test Date</b>	2023/12/27
<b>Model</b>	AT-LP70XBT	<b>Test By</b>	Peter Chu
<b>Test Mode</b>	GFSK(4.0) TX (CH Middle)	<b>TEMP&amp; Humidity</b>	21.8°C, 47%

Horizontal

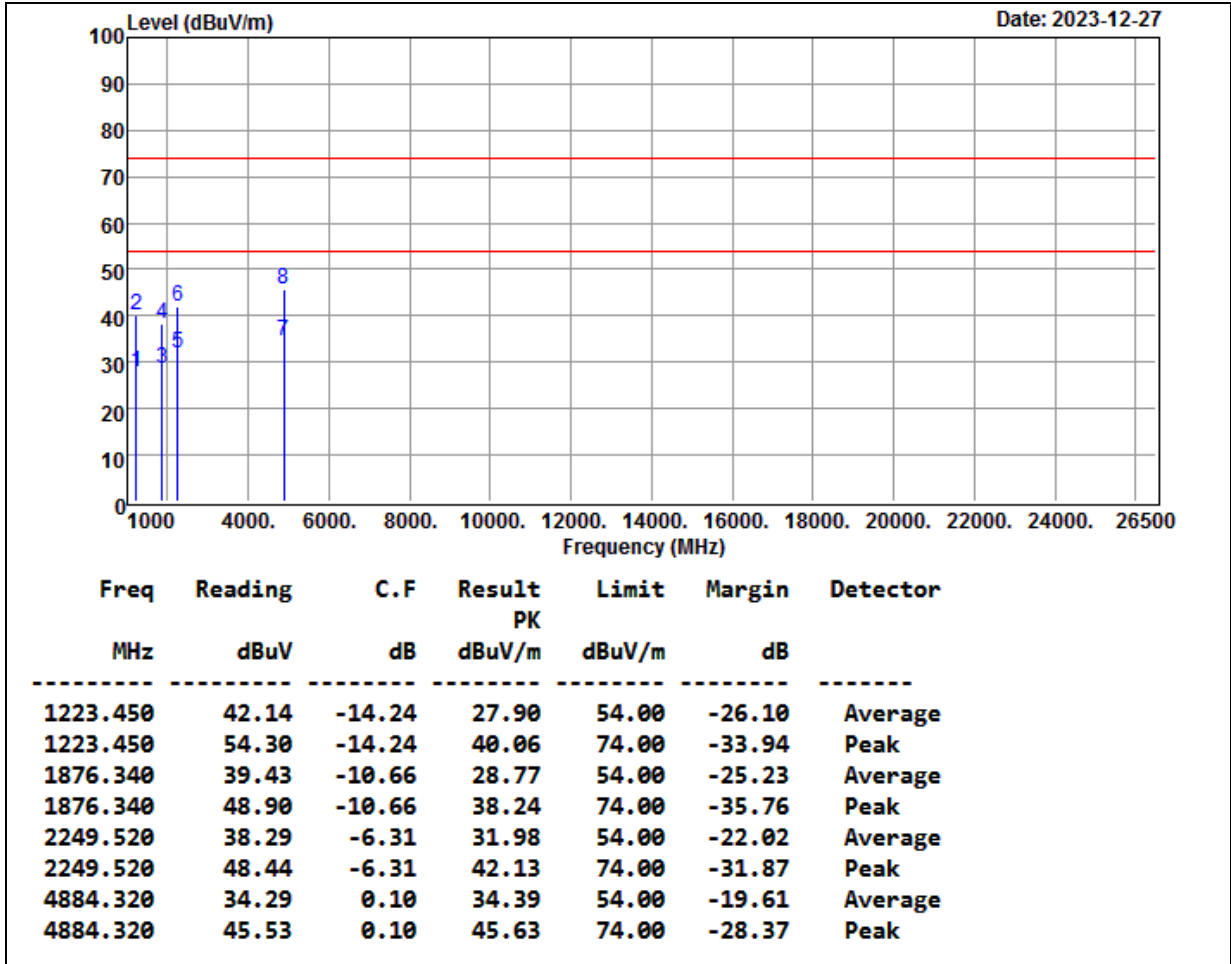

**REMARK:**

- 1.Spectrum analyzer setting Peak: RBW=1MHz, VBW=3MHz,Average: RBW=1MHz, VBW ≥ 1/T
- 2.C.F=Antenna Factor+Cable Loss-Preamplifier gain+2.4GHz~2.5GHz Filter Insertion Loss
- 3.The result basic equation calculation is as follow:Result = Reading + C.F, Margin = Result-Limit
- 4.The other emission levels were 10dB below the limit
- 5.The test distance is 3m.

<b>Product Name</b>	AUTOMATIC WIRELESS TURNTABLE	<b>Test Date</b>	2023/12/27
<b>Model</b>	AT-LP70XBT	<b>Test By</b>	Peter Chu
<b>Test Mode</b>	GFSK(4.0) TX (CH High)	<b>TEMP&amp; Humidity</b>	21.8°C, 47%

Vertical

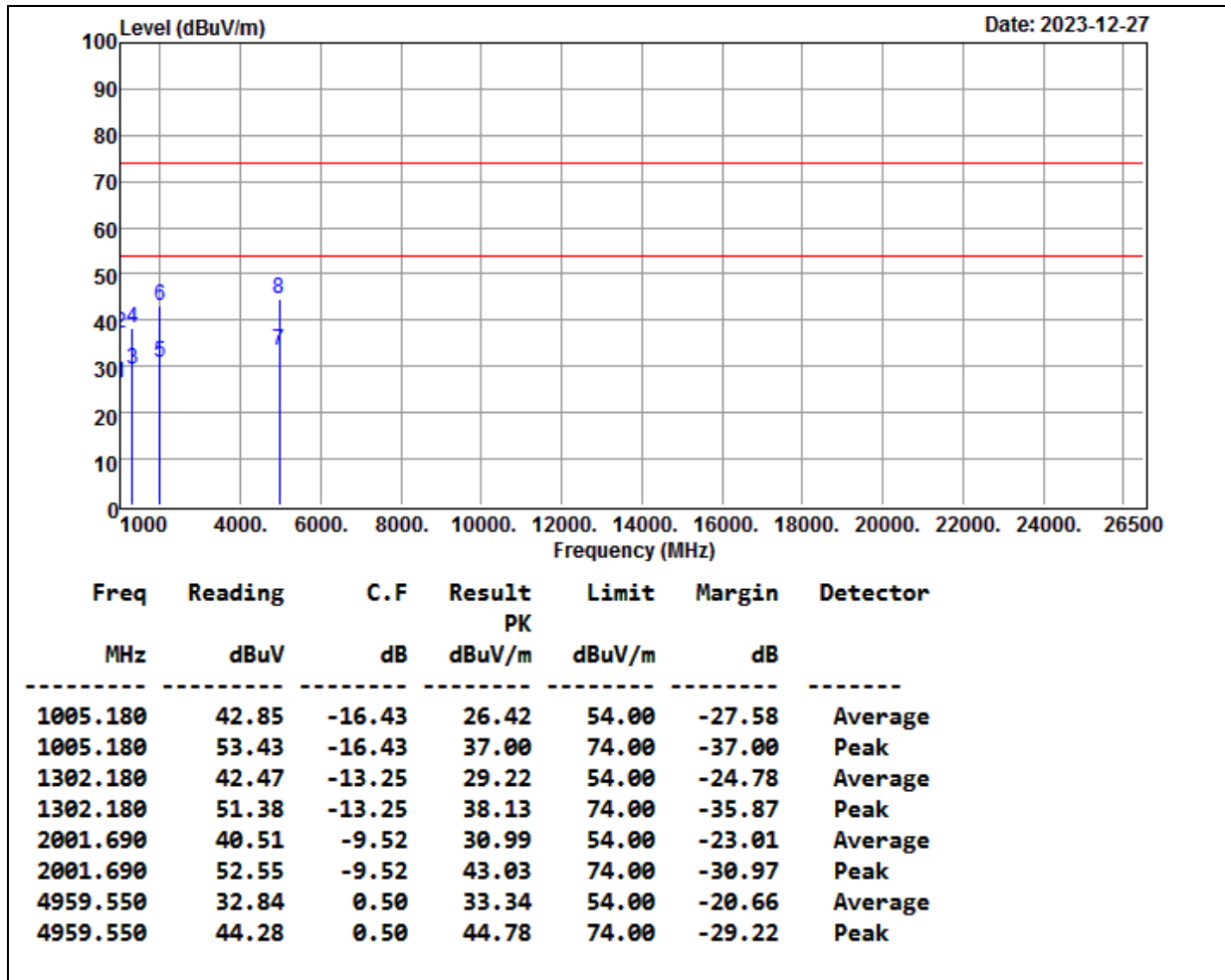

**REMARK:**

- 1.Spectrum analyzer setting Peak: RBW=1MHz, VBW=3MHz,Average: RBW=1MHz, VBW ≥ 1/T
- 2.C.F=Antenna Factor+Cable Loss-Preamplifier gain+2.4GHz~2.5GHz Filter Insertion Loss
- 3.The result basic equation calculation is as follow:Result = Reading + C.F, Margin = Result-Limit
- 4.The other emission levels were 10dB below the limit
- 5.The test distance is 3m.

Report No.: TMTN2312001595NR

<b>Product Name</b>	AUTOMATIC WIRELESS TURNTABLE	<b>Test Date</b>	2023/12/27
<b>Model</b>	AT-LP70XBT	<b>Test By</b>	Peter Chu
<b>Test Mode</b>	GFSK(4.0) TX (CH High)	<b>TEMP&amp; Humidity</b>	21.8°C, 47%

Horizontal

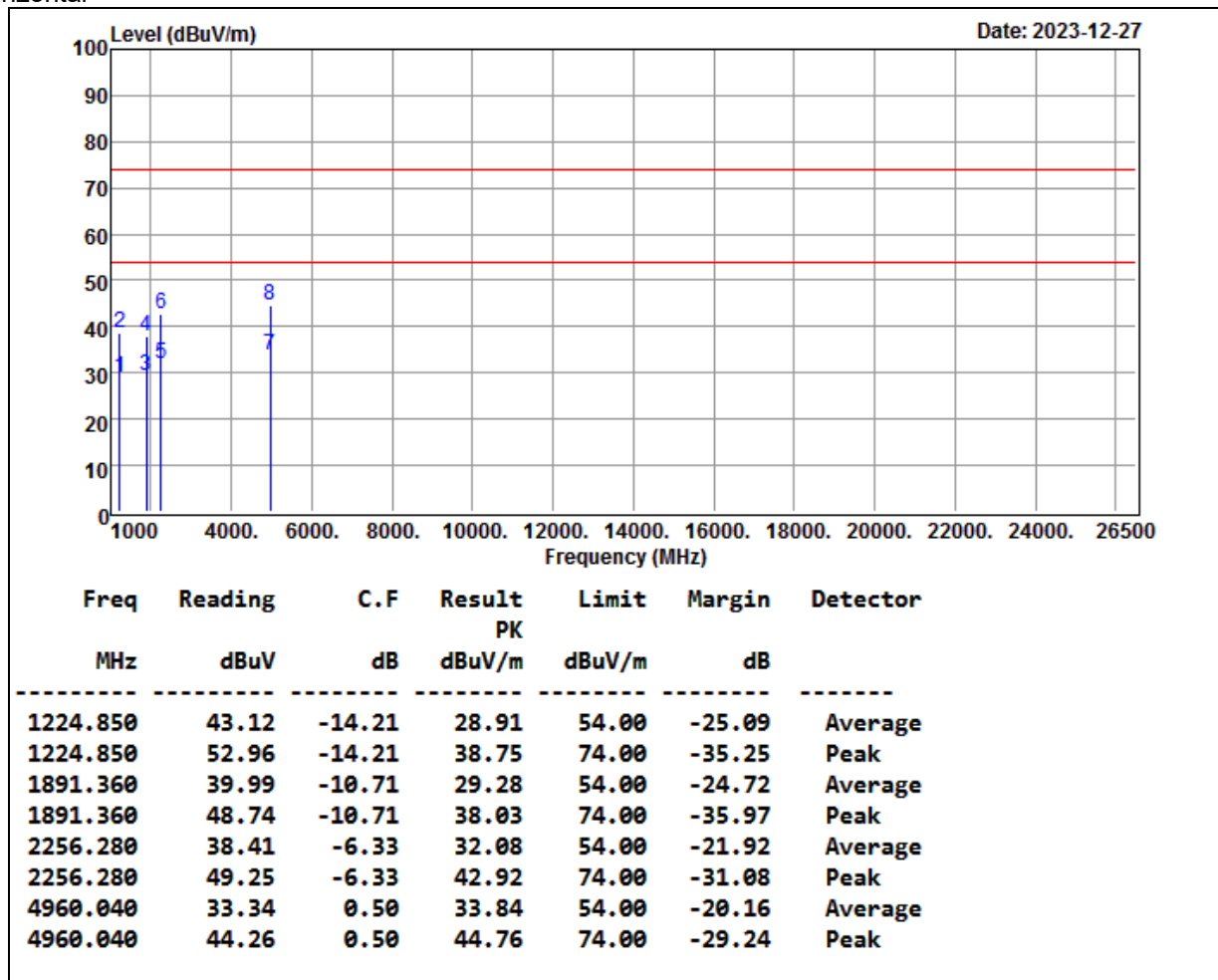

**REMARK:**

- 1.Spectrum analyzer setting Peak: RBW=1MHz, VBW=3MHz,Average: RBW=1MHz, VBW ≥ 1/T
- 2.C.F=Antenna Factor+Cable Loss-Preamplifier gain+2.4GHz~2.5GHz Filter Insertion Loss
- 3.The result basic equation calculation is as follow:Result = Reading + C.F, Margin = Result-Limit
- 4.The other emission levels were 10dB below the limit
- 5.The test distance is 3m.

<b>Product Name</b>	AUTOMATIC WIRELESS TURNTABLE	<b>Test Date</b>	2023/12/27
<b>Model</b>	AT-LP70XBT	<b>Test By</b>	Peter Chu
<b>Test Mode</b>	GFSK(5.2) TX (CH Low)	<b>TEMP&amp; Humidity</b>	21.8°C, 47%

Vertical

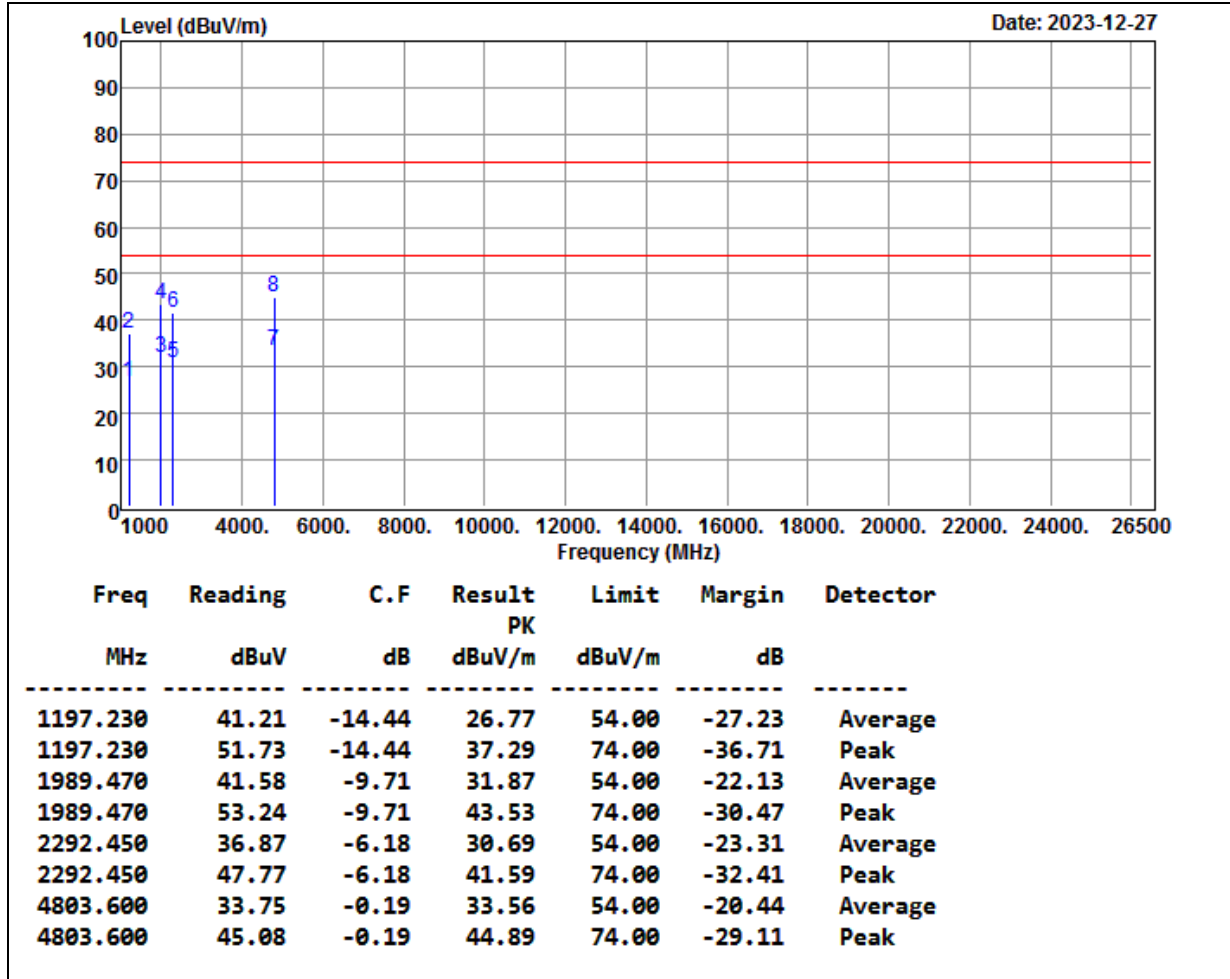

**REMARK:**

- 1.Spectrum analyzer setting Peak: RBW=1MHz, VBW=3MHz,Average: RBW=1MHz, VBW ≥ 1/T
- 2.C.F=Antenna Factor+Cable Loss-Preamplifier gain+2.4GHz~2.5GHz Filter Insertion Loss
- 3.The result basic equation calculation is as follow:Result = Reading + C.F, Margin = Result-Limit
- 4.The other emission levels were 10dB below the limit
- 5.The test distance is 3m.

<b>Product Name</b>	AUTOMATIC WIRELESS TURNTABLE	<b>Test Date</b>	2023/12/27
<b>Model</b>	AT-LP70XBT	<b>Test By</b>	Peter Chu
<b>Test Mode</b>	GFSK(5.2) TX (CH Low)	<b>TEMP&amp; Humidity</b>	21.8°C, 47%

Horizontal

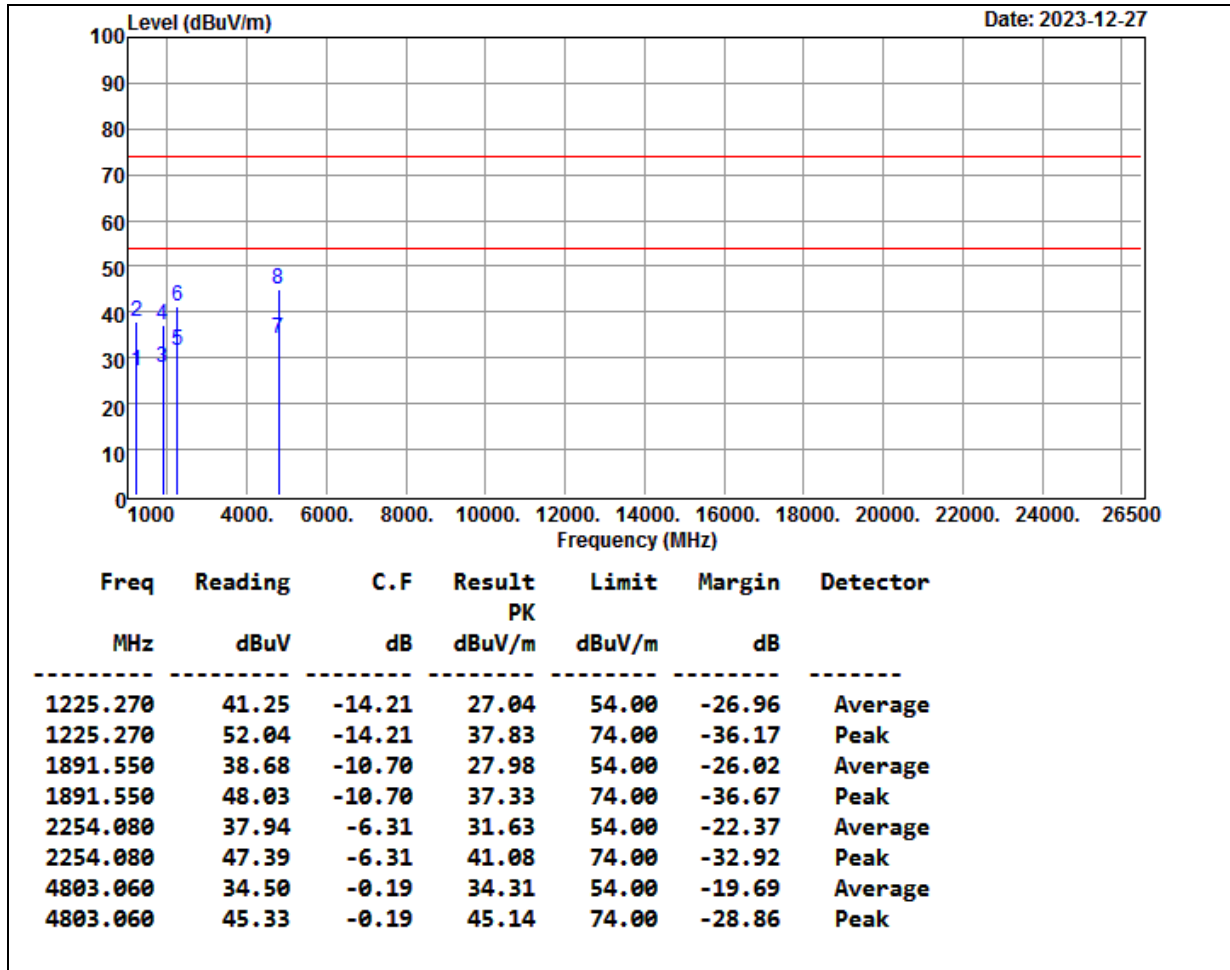

**REMARK:**

- 1.Spectrum analyzer setting Peak: RBW=1MHz, VBW=3MHz,Average: RBW=1MHz, VBW ≥ 1/T
- 2.C.F=Antenna Factor+Cable Loss-Preamplifier gain+2.4GHz~2.5GHz Filter Insertion Loss
- 3.The result basic equation calculation is as follow:Result = Reading + C.F, Margin = Result-Limit
- 4.The other emission levels were 10dB below the limit
- 5.The test distance is 3m.

<b>Product Name</b>	AUTOMATIC WIRELESS TURNTABLE	<b>Test Date</b>	2023/12/27
<b>Model</b>	AT-LP70XBT	<b>Test By</b>	Peter Chu
<b>Test Mode</b>	GFSK(5.2) TX (CH Middle)	<b>TEMP&amp; Humidity</b>	21.8°C, 47%

Vertical

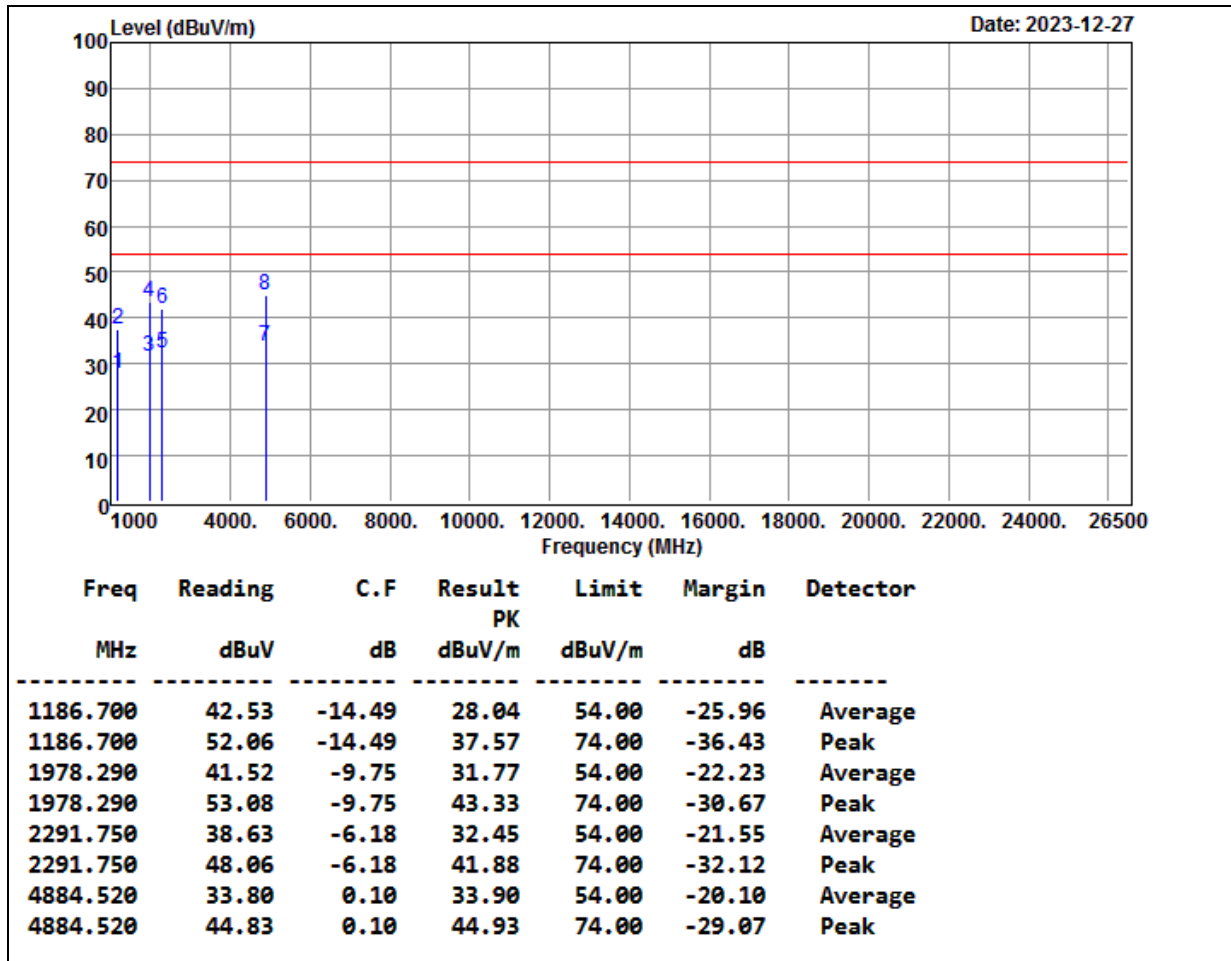

**REMARK:**

1. Spectrum analyzer setting Peak: RBW=1MHz, VBW=3MHz, Average: RBW=1MHz, VBW ≥ 1/T
2. C.F=Antenna Factor+Cable Loss-Preamplifier gain+2.4GHz~2.5GHz Filter Insertion Loss
3. The result basic equation calculation is as follow: Result = Reading + C.F, Margin = Result-Limit
4. The other emission levels were 10dB below the limit
5. The test distance is 3m.



<b>Product Name</b>	AUTOMATIC WIRELESS TURNTABLE	<b>Test Date</b>	2023/12/27
<b>Model</b>	AT-LP70XBT	<b>Test By</b>	Peter Chu
<b>Test Mode</b>	GFSK(5.2) TX (CH Middle)	<b>TEMP&amp; Humidity</b>	21.8°C, 47%

Horizontal

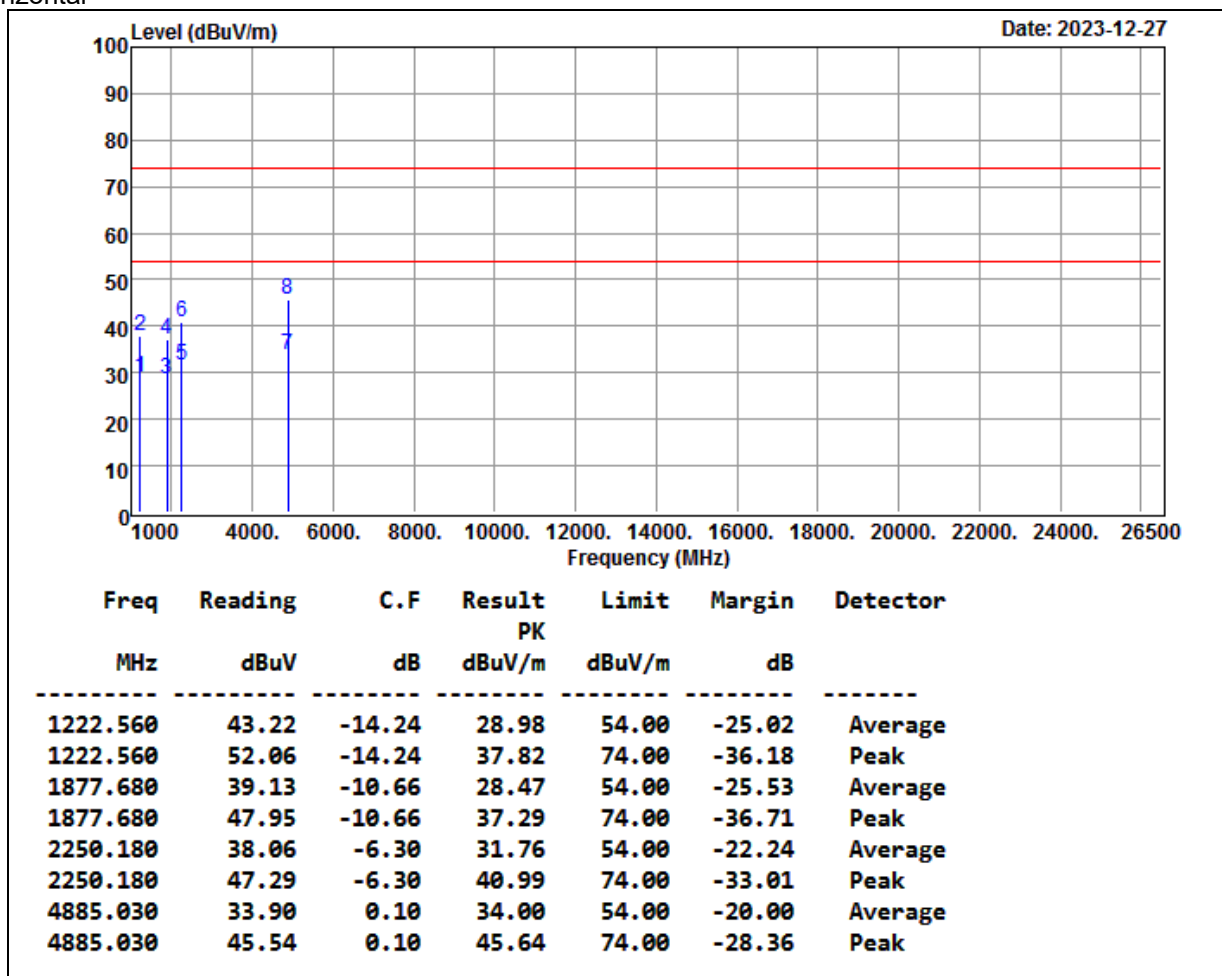

**REMARK:**

- 1.Spectrum analyzer setting Peak: RBW=1MHz, VBW=3MHz,Average: RBW=1MHz, VBW ≥ 1/T
- 2.C.F=Antenna Factor+Cable Loss-Preamplifier gain+2.4GHz~2.5GHz Filter Insertion Loss
- 3.The result basic equation calculation is as follow:Result = Reading + C.F, Margin = Result-Limit
- 4.The other emission levels were 10dB below the limit
- 5.The test distance is 3m.

<b>Product Name</b>	AUTOMATIC WIRELESS TURNTABLE	<b>Test Date</b>	2023/12/27
<b>Model</b>	AT-LP70XBT	<b>Test By</b>	Peter Chu
<b>Test Mode</b>	GFSK(5.2) TX (CH High)	<b>TEMP&amp; Humidity</b>	21.8°C, 47%

Vertical

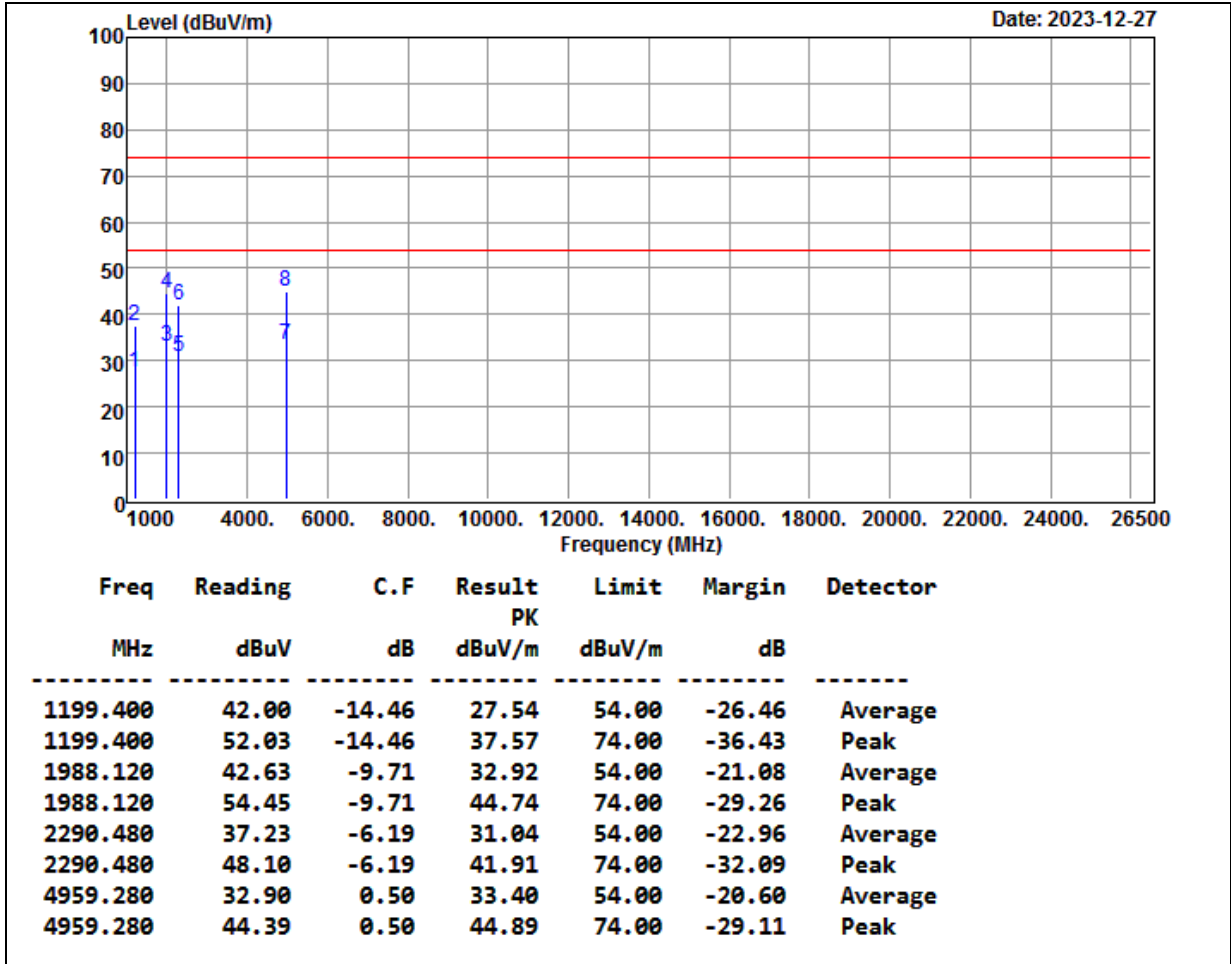

**REMARK:**

- 1.Spectrum analyzer setting Peak: RBW=1MHz, VBW=3MHz,Average: RBW=1MHz, VBW ≥ 1/T
- 2.C.F=Antenna Factor+Cable Loss-Preamplifier gain+2.4GHz~2.5GHz Filter Insertion Loss
- 3.The result basic equation calculation is as follow:Result = Reading + C.F, Margin = Result-Limit
- 4.The other emission levels were 10dB below the limit
- 5.The test distance is 3m.

Report No.: TMTN2312001595NR

<b>Product Name</b>	AUTOMATIC WIRELESS TURNTABLE	<b>Test Date</b>	2023/12/27
<b>Model</b>	AT-LP70XBT	<b>Test By</b>	Peter Chu
<b>Test Mode</b>	GFSK(5.2) TX (CH High)	<b>TEMP&amp; Humidity</b>	21.8°C, 47%

Horizontal

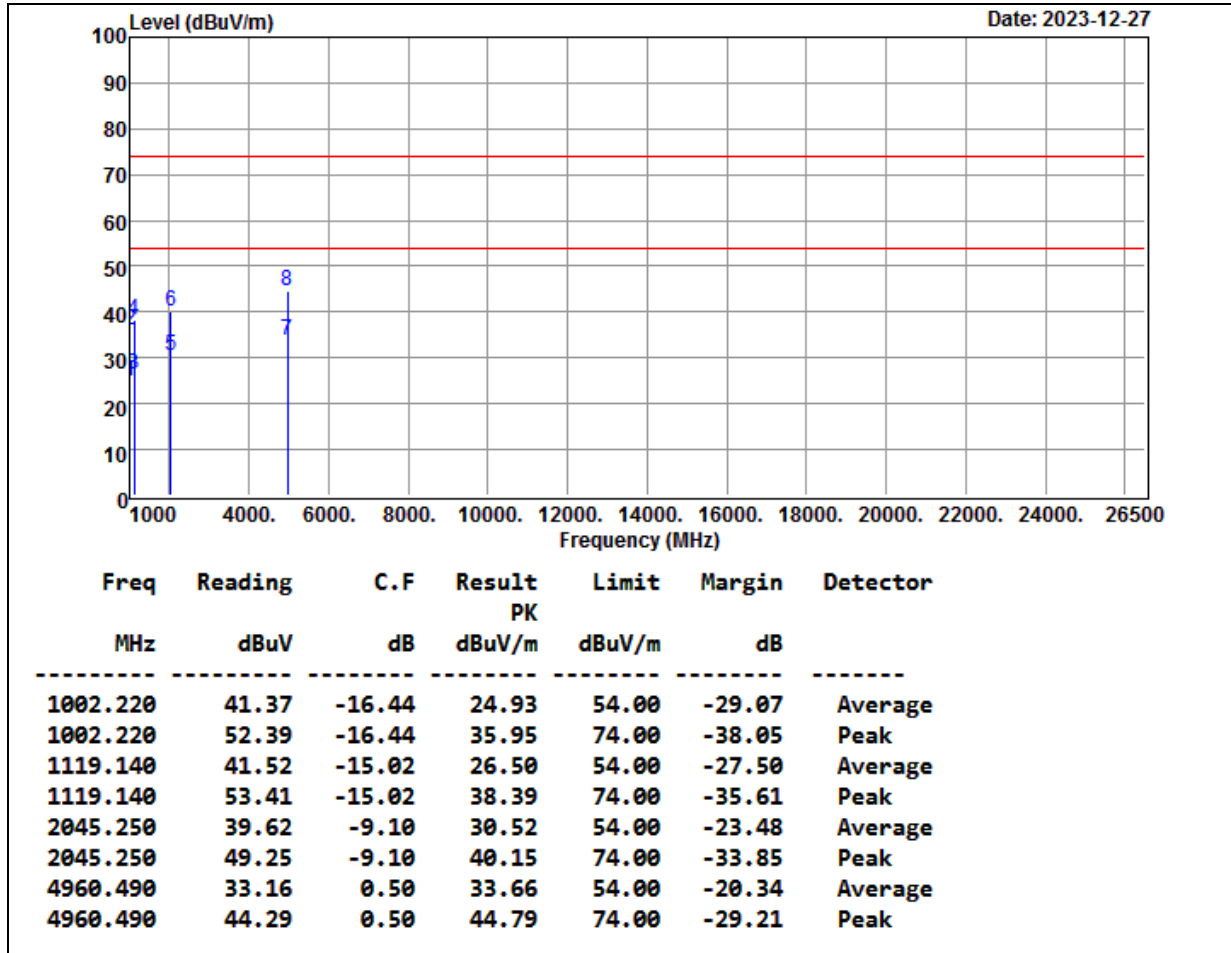

**REMARK:**

1. Spectrum analyzer setting Peak: RBW=1MHz, VBW=3MHz, Average: RBW=1MHz, VBW ≥ 1/T
2. C.F=Antenna Factor+Cable Loss-Preamplifier gain+2.4GHz~2.5GHz Filter Insertion Loss
3. The result basic equation calculation is as follow: Result = Reading + C.F, Margin = Result-Limit
4. The other emission levels were 10dB below the limit
5. The test distance is 3m.

Report No.: TMTN2312001595NR

## 9.6.4 RESTRICTED BAND EDGES

<b>Product Name</b>	AUTOMATIC WIRELESS TURNTABLE	<b>Test Date</b>	2023/12/27
<b>Model</b>	AT-LP70XBT	<b>Test By</b>	Peter Chu
<b>Test Mode</b>	CH Low TX / BLE 1M	<b>TEMP&amp; Humidity</b>	21.8°C, 47%

Horizontal

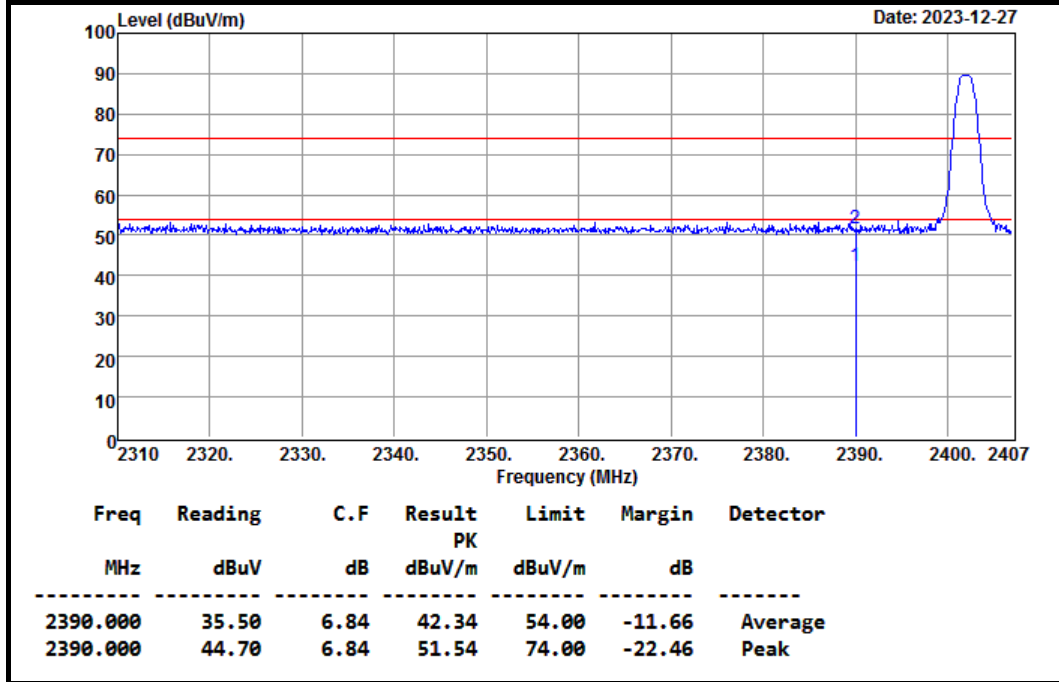

Vertical

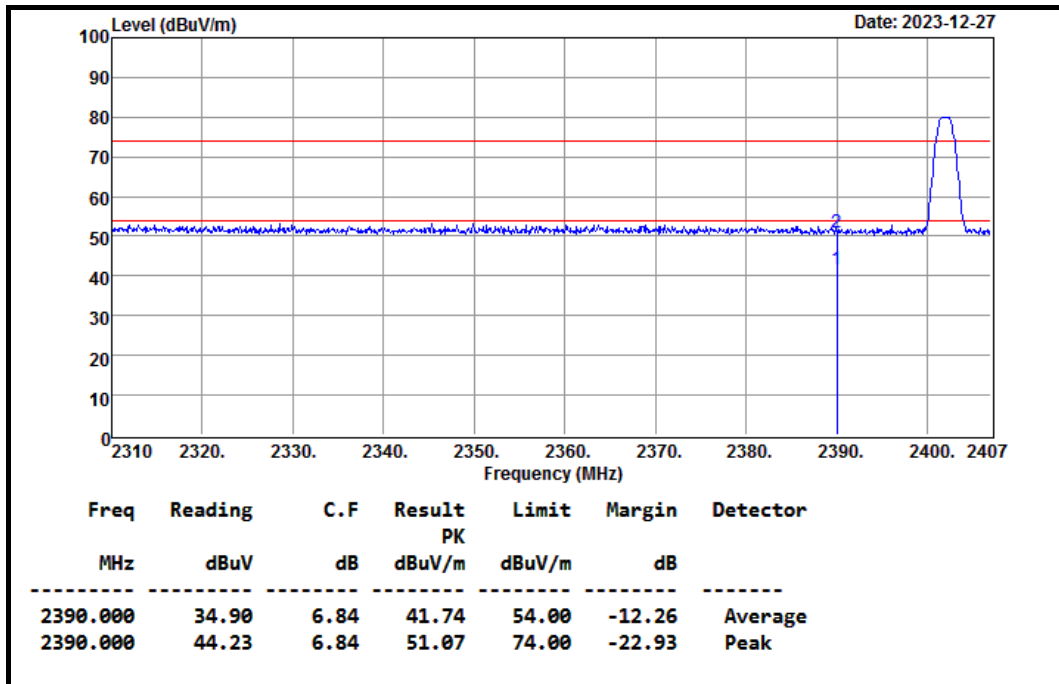

<b>Product Name</b>	AUTOMATIC WIRELESS TURNTABLE	<b>Test Date</b>	2023/12/27
<b>Model</b>	AT-LP70XBT	<b>Test By</b>	Peter Chu
<b>Test Mode</b>	CH High TX / BLE 1M	<b>TEMP&amp; Humidity</b>	21.8°C, 47%

Horizontal

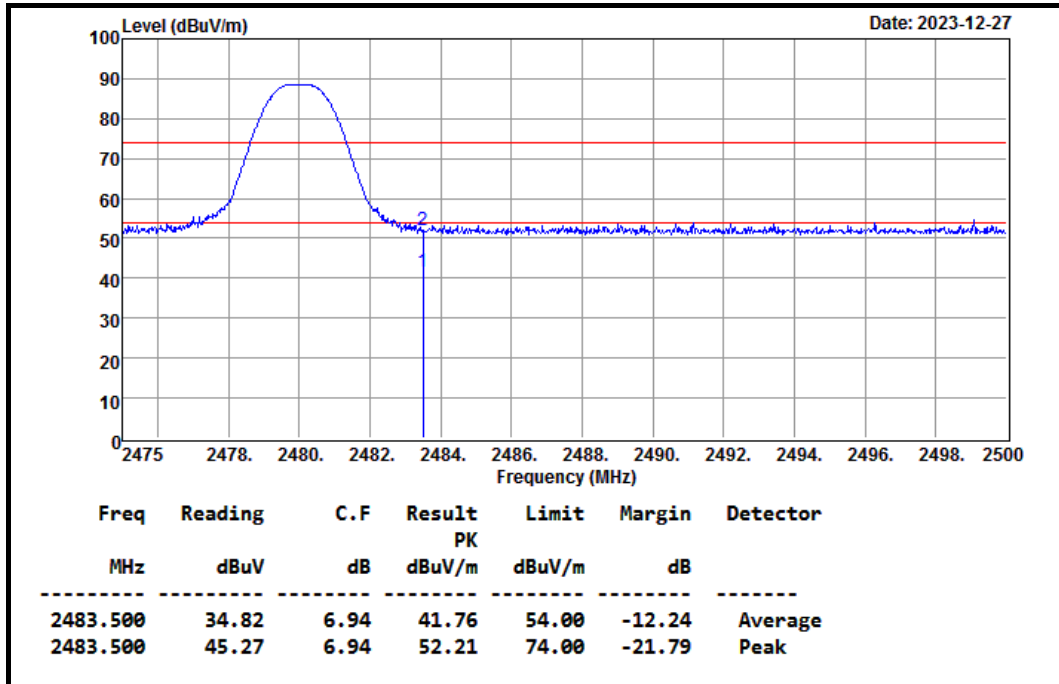

Vertical

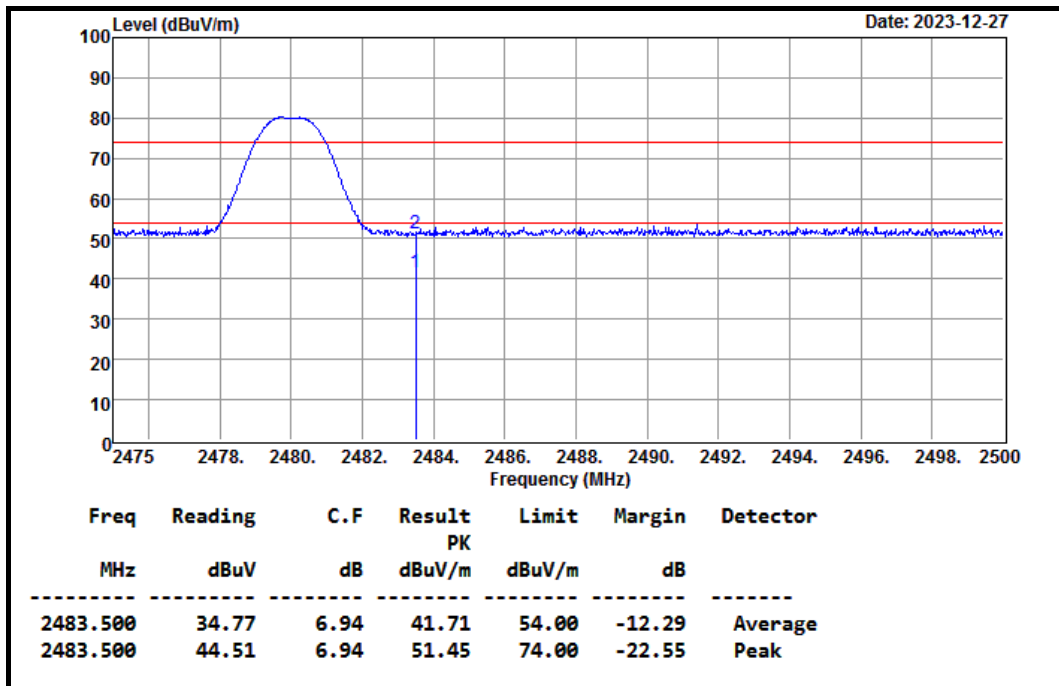

<b>Product Name</b>	AUTOMATIC WIRELESS TURNTABLE	<b>Test Date</b>	2023/12/27
<b>Model</b>	AT-LP70XBT	<b>Test By</b>	Peter Chu
<b>Test Mode</b>	CH Low TX / BLE 2M	<b>TEMP&amp; Humidity</b>	21.8°C, 47%

Horizontal

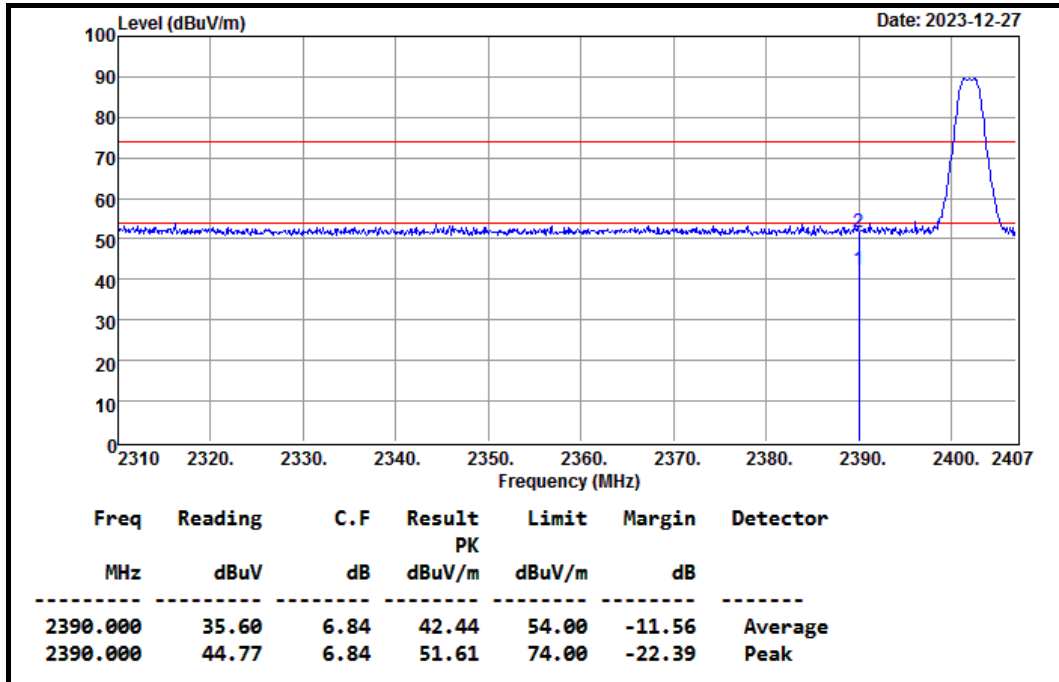

Vertical

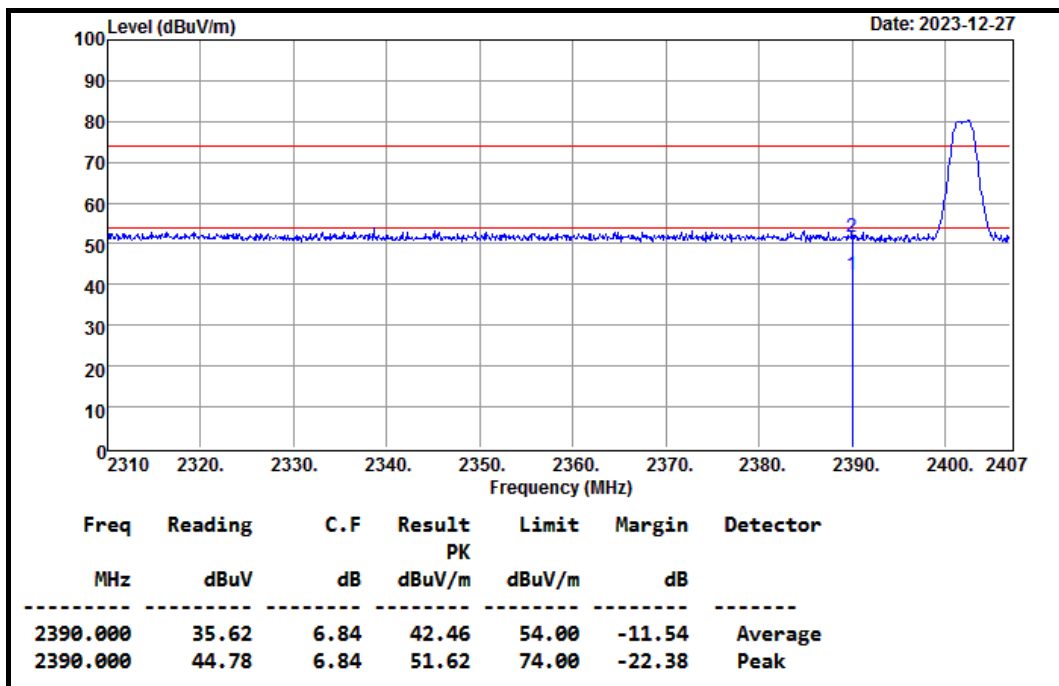

<b>Product Name</b>	AUTOMATIC WIRELESS TURNTABLE	<b>Test Date</b>	2023/12/27
<b>Model</b>	AT-LP70XBT	<b>Test By</b>	Peter Chu
<b>Test Mode</b>	CH High TX / BLE 2M	<b>TEMP&amp; Humidity</b>	21.8°C, 47%

Horizontal

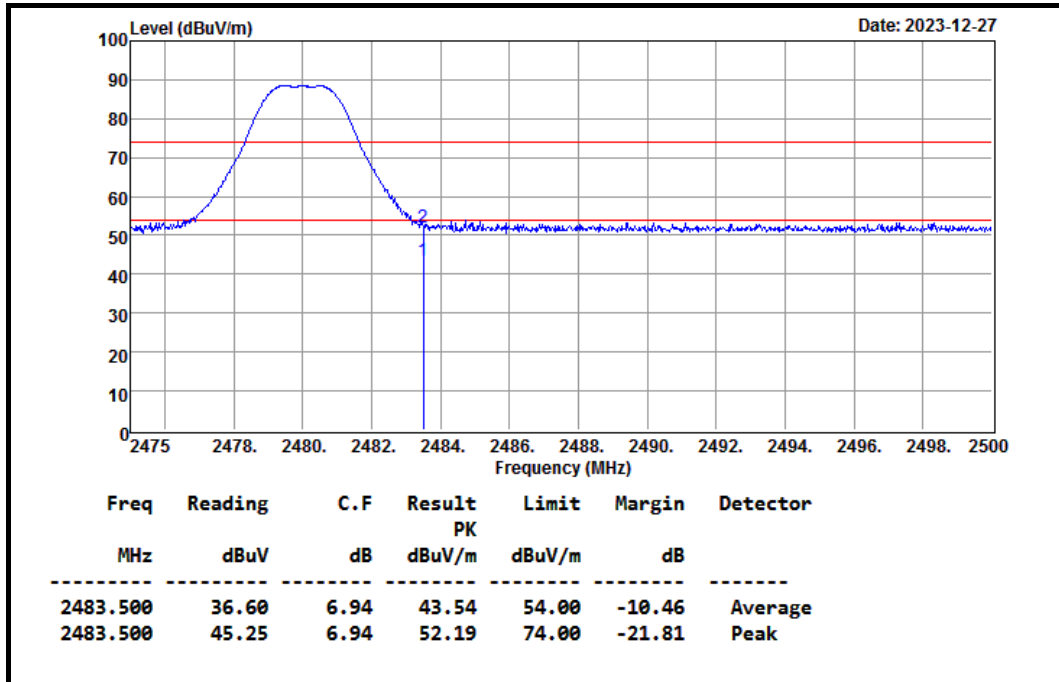

Vertical

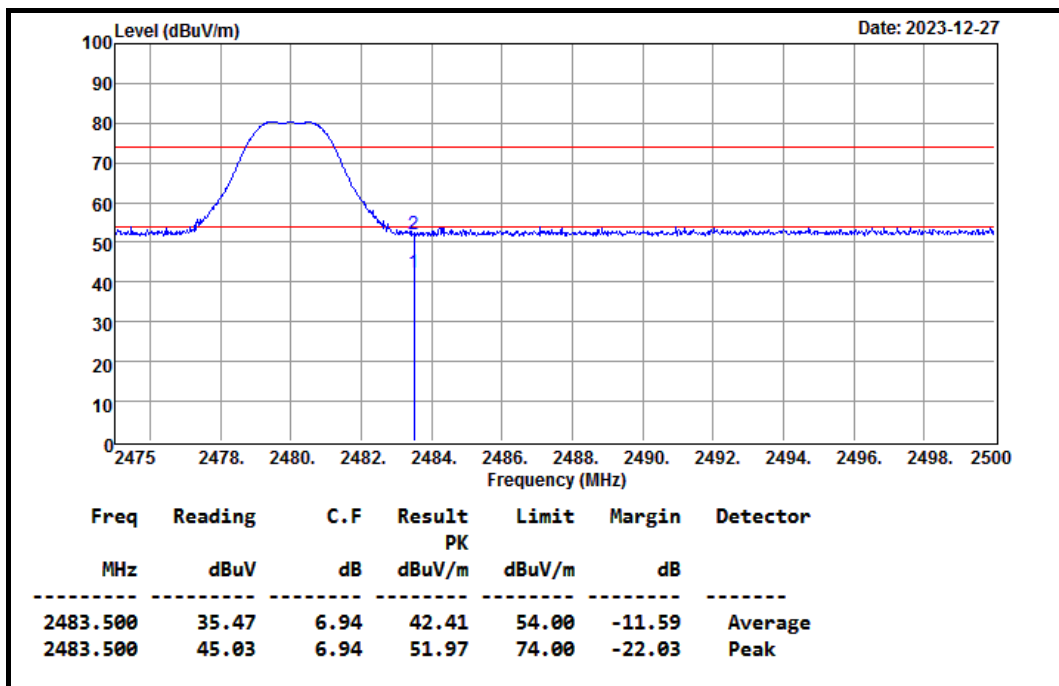

## 9.7 POWERLINE CONDUCTED EMISSIONS

### LIMITS

§ 15.207 (a) Except as shown in paragraph (b) and (c) this section, for an intentional radiator that is designed to be connected to the public utility (AC) power line, the radio frequency voltage that is conducted back onto the AC power line on any frequency or frequencies within the band 150 kHz to 30 MHz shall not exceed the limits in the following table, as measured using a 50  $\mu$ H/50 ohms line impedance stabilization network (LISN). Compliance with the provisions of this paragraph shall be based on the measurement of the radio frequency voltage between each power line and ground at the power terminal.

The lower limit applies at the boundary between the frequency ranges.

Frequency of Emission (MHz)	Conducted limit (dB $\mu$ v)	
	Quasi-peak	Average
0.15 - 0.5	66 to 56	56 to 46
0.5 - 5	56	46
5 - 30	60	50



Report No.: TMTN2312001595NR

## TEST SETUP

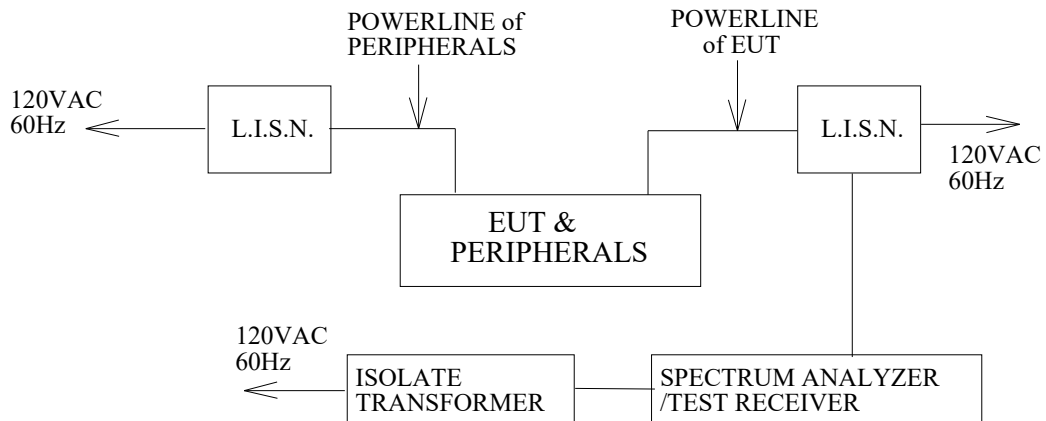

## TEST PROCEDURE

The EUT is placed on a non-conducting table 40 cm from the vertical ground plane and 80cm above the horizontal ground plane. The EUT IS CONFIGURED IN ACCORDANCE WITH ANSI C63.10.

The resolution bandwidth is set to 9 kHz for both quasi-peak detection and average detection measurements.

Line conducted data is recorded for both NEUTRAL and LINE.

## TEST RESULTS

No non-compliance noted.

### Test Voltage: AC 120V, 60Hz

Model No.	AT-LP70XBT	Test Mode	Normal Operation
Environmental Conditions	26.5°C, 44% RH	Resolution Bandwidth	9 kHz
Tested by	Jeremy Zhong		

### LINE

(The chart below shows the highest readings taken from the final data.)

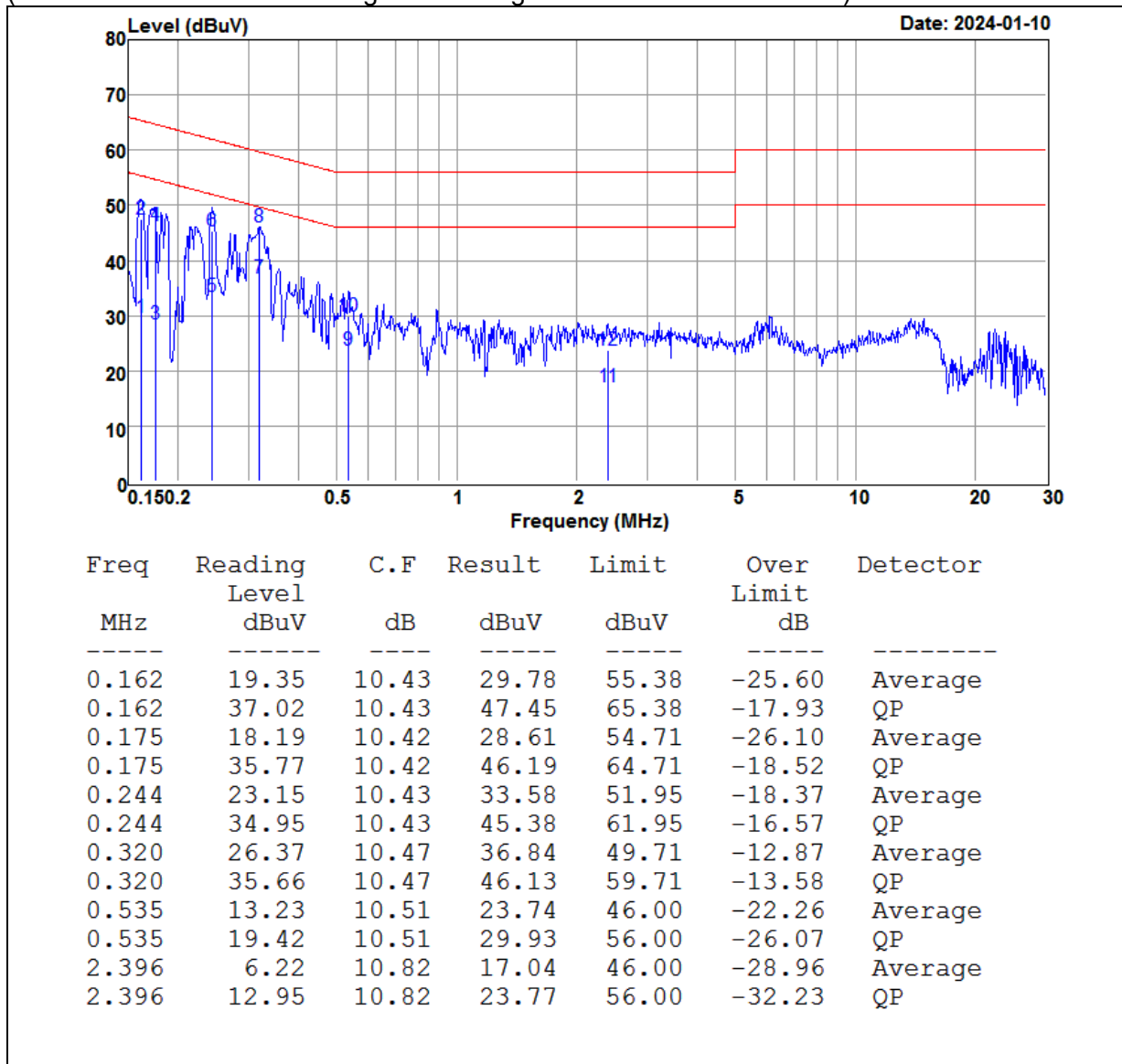

Report No.: TMTN2312001595NR

Model No.	AT-LP70XBT	Test Mode	Normal Operation
Environmental Conditions	26.5°C, 44% RH	Resolution Bandwidth	9 kHz
Tested by	Jeremy Zhong		

## NEUTRAL

(The chart below shows the highest readings taken from the final data.)

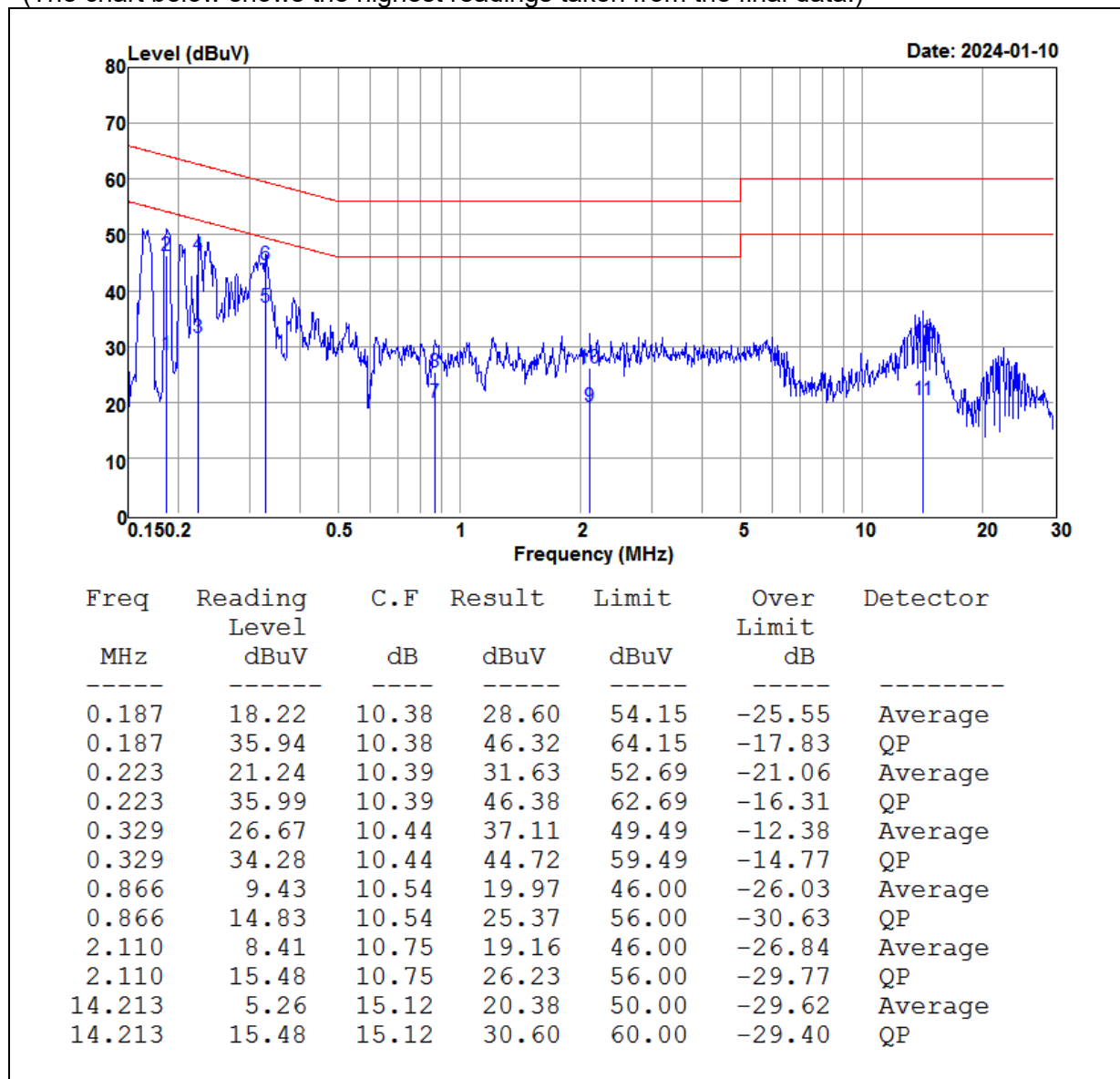

## 10. ANTENNA REQUIREMENT

### 10.1 STANDARD APPLICABLE

For intentional device, according to FCC 47 CFR Section 15.203, an intentional radiator shall be designed to ensure that no antenna other than that furnished by the responsible party shall be used with the device.

And according to FCC 47 CFR Section 15.247 (b), if transmitting antennas of directional gain greater than 6dBi are used, the power shall be reduced by the amount in dB that the directional gain of the antenna exceeds 6dBi.

### 10.2 ANTENNA CONNECTED CONSTRUCTION

Manufacturer: Sunitec  
Type: Layout Antenna  
Model: AT-LP70XBT  
Gain: 3.33 dBi

**=== END of Report ===**