

8.4 NUMBER OF HOPPING FREQUENCY USED

LIMIT

§15.247(a)(1)(iii) For frequency hopping systems in the 2400-2483.5 MHz band shall use at least 15 channels.

TEST SETUP

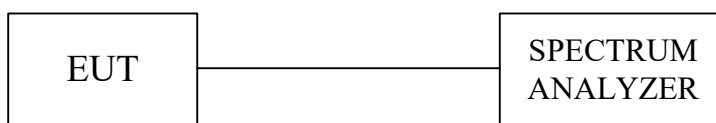

TEST PROCEDURE

- 1 Check the calibration of the measuring instrument (spectrum analyzer) using either an internal calibrator or a known signal from an external generator.
- 2 Position the EUT as shown in test setup without connection to measurement instrument. Turn on the EUT and connect its antenna terminal to measurement instrument via a low loss cable. Then set it to any one measured frequency within its operating range and make sure the instrument is operated in its linear range.
- 3 Set the spectrum analyzer on MaxHold Mode, and then keep the EUT in hopping mode. Record all the signals from each channel until each one has been recorded.
- 4 Set the spectrum analyzer on View mode and then plot the result on spectrum analyzer screen.
- 5 Repeat above procedures until all frequencies measured were complete.

TEST RESULTS

| | | | |
|----------------------------|-------------|------------------|------------|
| Model Name | AT-LP70XBT | Test By | Peter Chu |
| Temp & Humidity | 22.5°C, 45% | Test Date | 2023/12/27 |

Modulation Type: GFSK / DH5

| Result(No.of CH) | Limit(No.of CH) | Result |
|------------------|-----------------|--------|
| 79 | >15 | PASS |

Modulation Type: 8-DPSK / 3-DH5

| Result(No.of CH) | Limit(No.of CH) | Result |
|------------------|-----------------|--------|
| 79 | >15 | PASS |

Report No.: TMTN2312001596NR

NUMBER OF HOPPING FREQUENCY USED

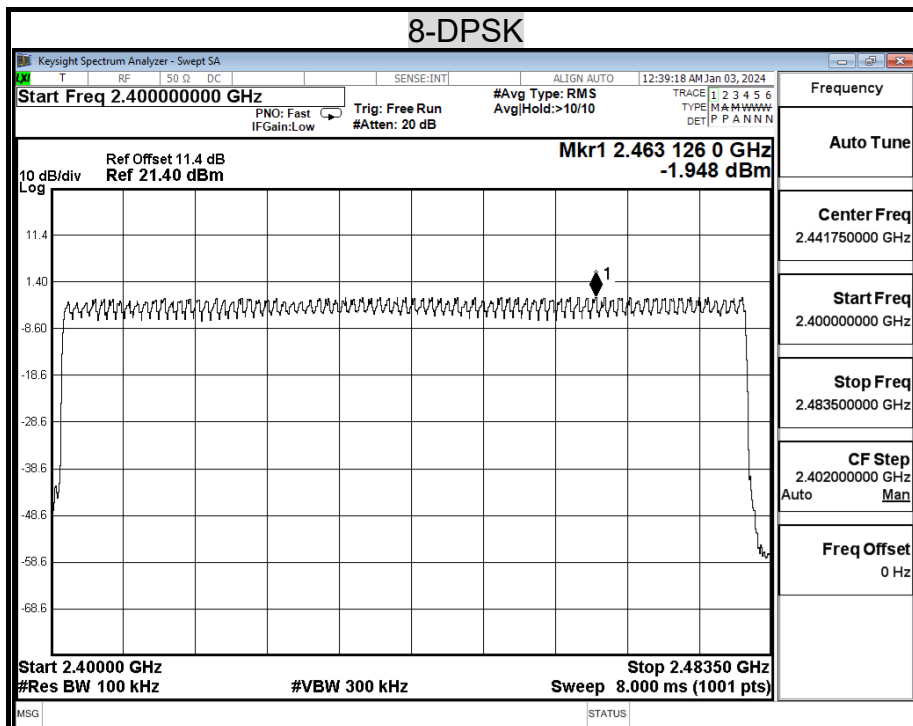
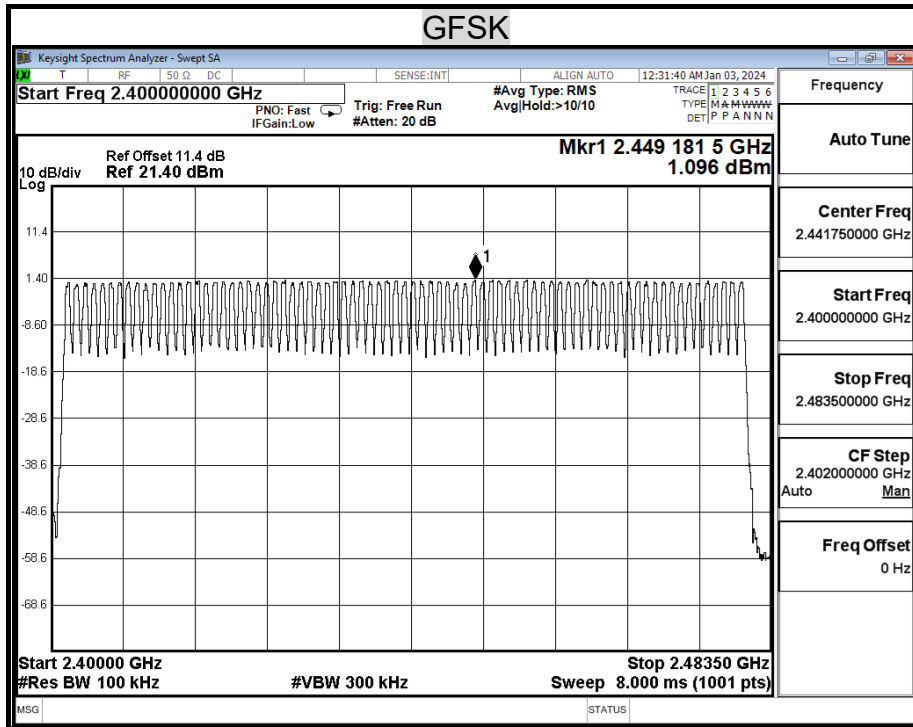

8.5 DWELL TIME ON EACH CHANNEL

LIMIT

§15.247(a)(1)(iii) For frequency hopping system operating in the 2400-2483.5MHz band, the average time of occupancy on any frequency shall not be greater than 0.4 second within a 31.6 second period.

TEST SETUP

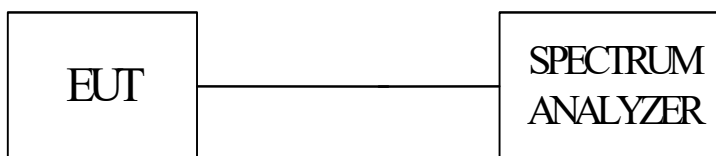

TEST PROCEDURE

1. Check the calibration of the measuring instrument using either an internal calibrator or a known signal from an external generator.
2. Position the EUT as shown in test setup without connection to measurement instrument. Turn on the EUT and connect its antenna terminal to measurement instrument via a low loss cable. Then set it to any one measured frequency within its operating range and make sure the instrument is operated in its linear range.
3. Adjust the center frequency of spectrum analyzer on any frequency be measured and set spectrum analyzer to zero span mode. And then, set RBW and VBW of spectrum analyzer to proper value.
4. Measure the time duration of one transmission on the measured frequency. And then plot the result with time difference of this time duration.
5. Repeat above procedures until all frequencies measured were complete.
6. The Bluetooth Headset has 3 type of payload, DH1, DH3, DH5. The hopping rate is 1600 per second. The longer the payload is, the slower the hopping rate is.

Report No.: TMTN2312001596NR

TEST RESULTS

Time of occupancy on the TX channel in 31.6sec = time domain slot length × hop rate ÷ number of hop per channel × 31.6

Refer to the attached graph.

The hopping rates of Bluetooth devices change with different types of payload. The longer the payload is, the slower the hopping rate. The hopping rate scenario is defined in Bluetooth core specification.

| | | | |
|----------------------------|-------------|------------------|------------|
| Model Name | AT-LP70XBT | Test By | Peter Chu |
| Temp & Humidity | 22.5°C, 45% | Test Date | 2023/12/27 |

Modulation Type: GFSK / DH5

| Transmitting Frequency | Packet type | Dwell time (ms) | Time of occupancy on the TX channel in 31.6sec (ms) | Limit for Time of occupancy on the TX channel in 31.6sec (ms) | Result |
|------------------------|-------------|-----------------|---|---|--------|
| 2441MHz | DH1 | 0.400 | 128.00 | 400 | PASS |
| 2441MHz | DH3 | 1.665 | 266.40 | 400 | PASS |
| 2441MHz | DH5 | 2.900 | 309.33 | 400 | PASS |
| 2441MHz | AFH | 2.900 | 154.67 | 400 | PASS |

DH1 Dwell time= $0.400 \text{ ms} \times (1600 \div 2) \div 79 \times 31.6 = 128.00 \text{ (ms)}$
 DH3 Dwell time= $1.665 \text{ ms} \times (1600 \div 4) \div 79 \times 31.6 = 266.40 \text{ (ms)}$
 DH5 Dwell time= $2.900 \text{ ms} \times (1600 \div 6) \div 79 \times 31.6 = 309.33 \text{ (ms)}$
 AFH Dwell time= $2.900 \text{ ms} \times (800 \div 6) \div 20 \times 8 = 154.67 \text{ (ms)}$

Modulation Type: 8-DPSK / 3-DH5

| Transmitting Frequency | Packet type | Dwell time (ms) | Time of occupancy on the TX channel in 31.6sec (ms) | Limit for Time of occupancy on the TX channel in 31.6sec (ms) | Result |
|------------------------|-------------|-----------------|---|---|--------|
| 2441MHz | 3DH1 | 0.400 | 128.00 | 400 | PASS |
| 2441MHz | 3DH3 | 1.665 | 266.40 | 400 | PASS |
| 2441MHz | 3DH5 | 2.900 | 309.33 | 400 | PASS |
| 2441MHz | AFH | 2.900 | 154.67 | 400 | PASS |

3DH1 Dwell time= $0.400 \text{ ms} \times (1600 \div 2) \div 79 \times 31.6 = 128.00 \text{ (ms)}$
 3DH3 Dwell time= $1.665 \text{ ms} \times (1600 \div 4) \div 79 \times 31.6 = 266.40 \text{ (ms)}$
 3DH5 Dwell time= $2.900 \text{ ms} \times (1600 \div 6) \div 79 \times 31.6 = 309.33 \text{ (ms)}$
 AFH Dwell time= $2.900 \text{ ms} \times (800 \div 6) \div 20 \times 8 = 154.67 \text{ (ms)}$

Report No.: TMTN2312001596NR

DWELL TIME ON EACH PAYLOAD

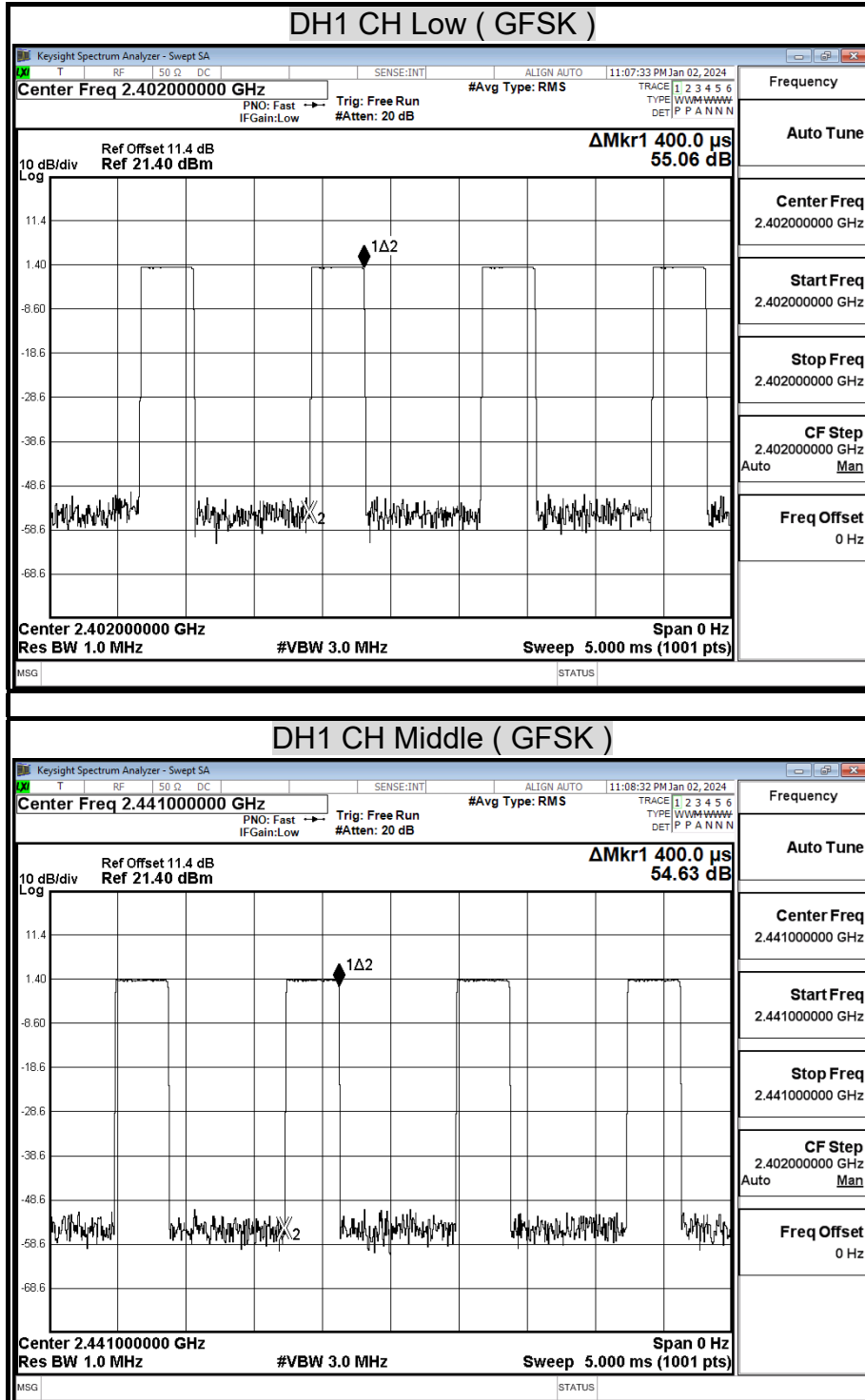

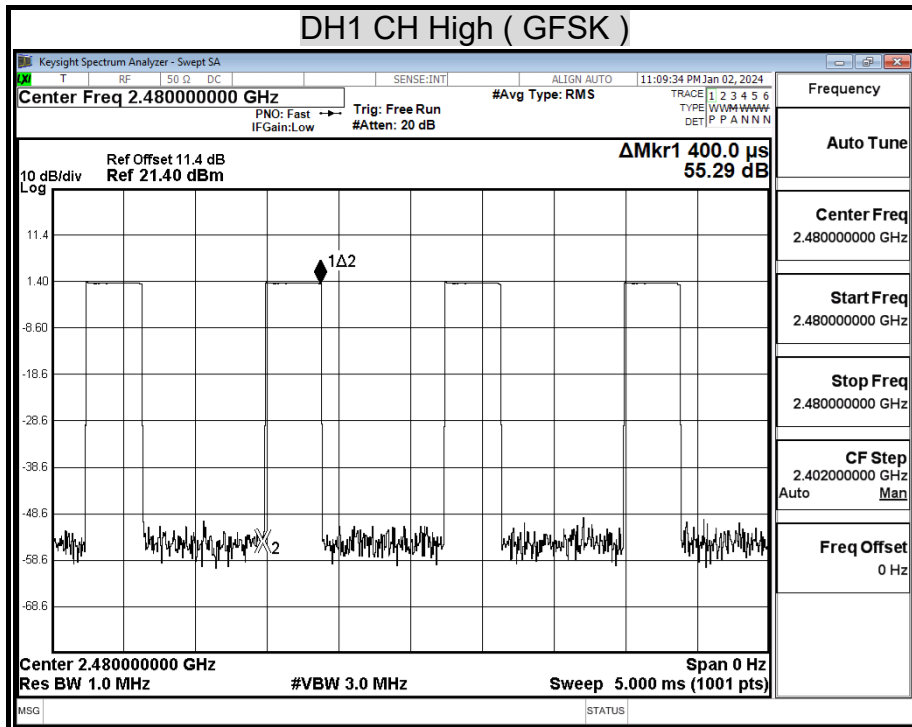

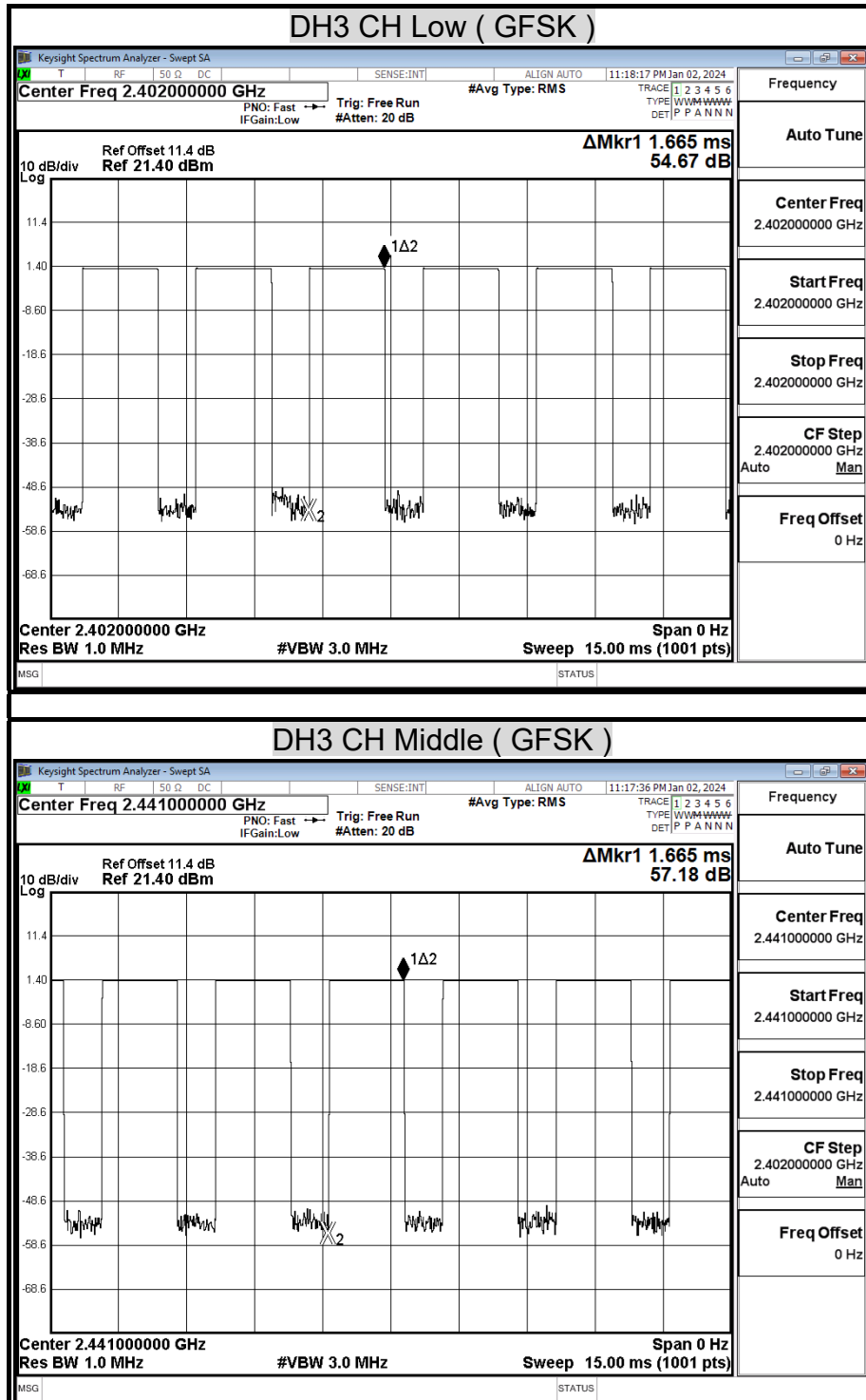

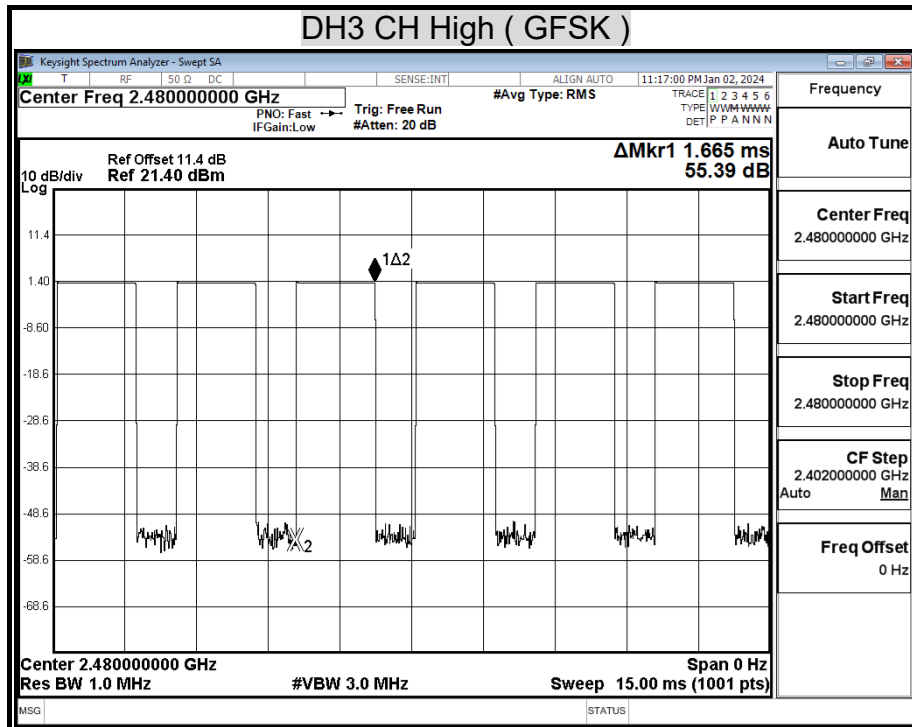

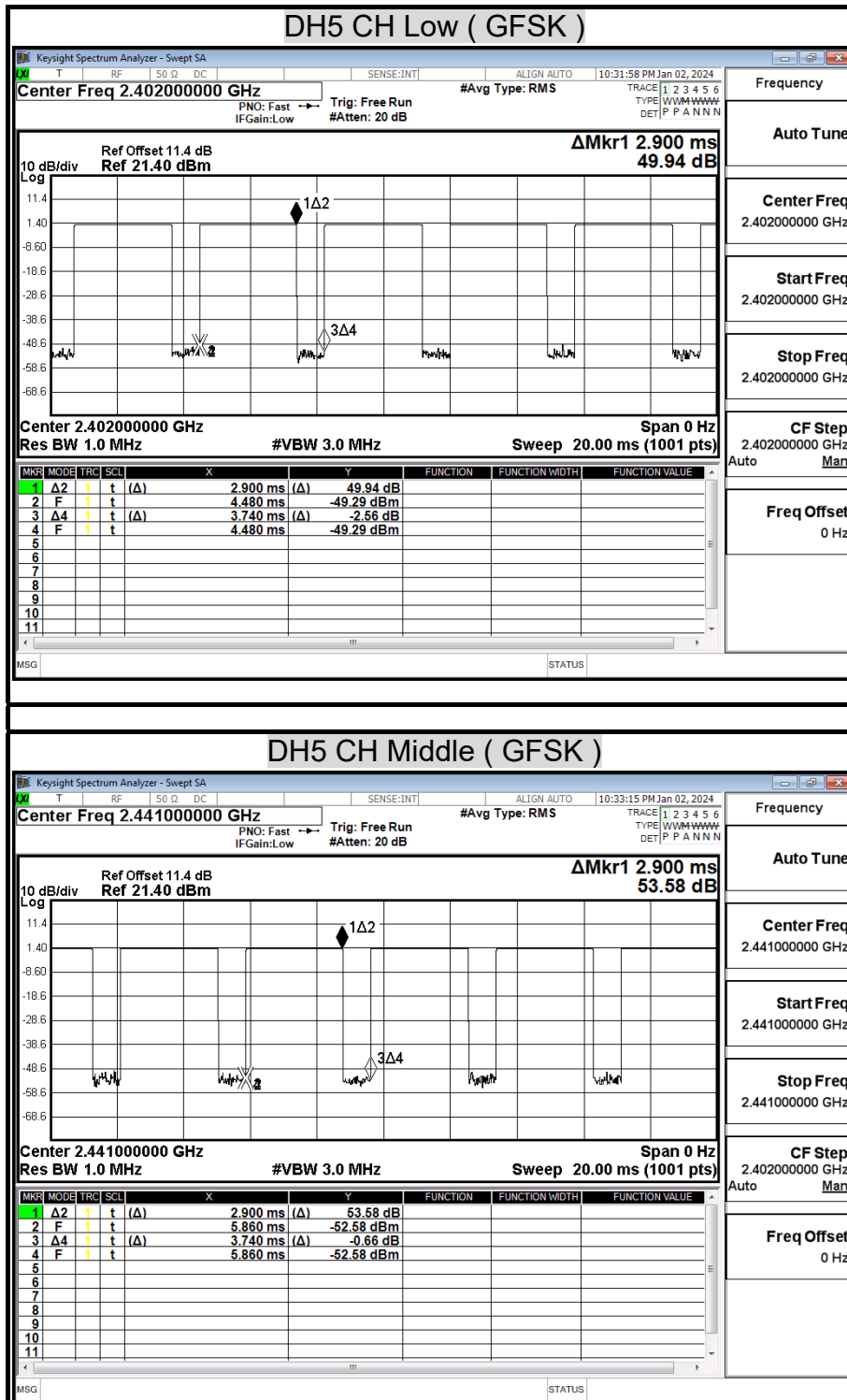

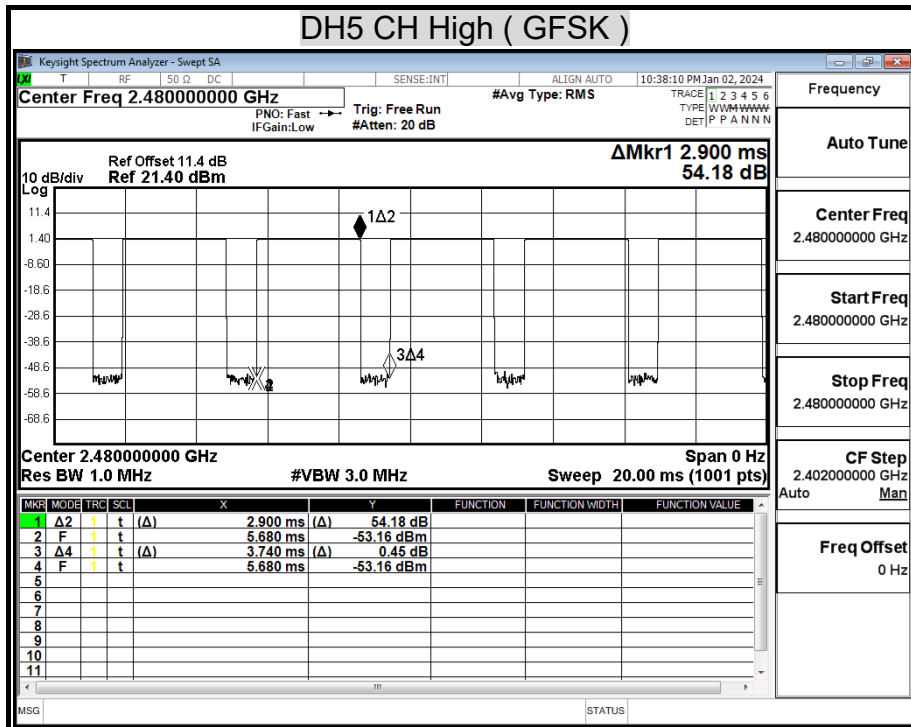

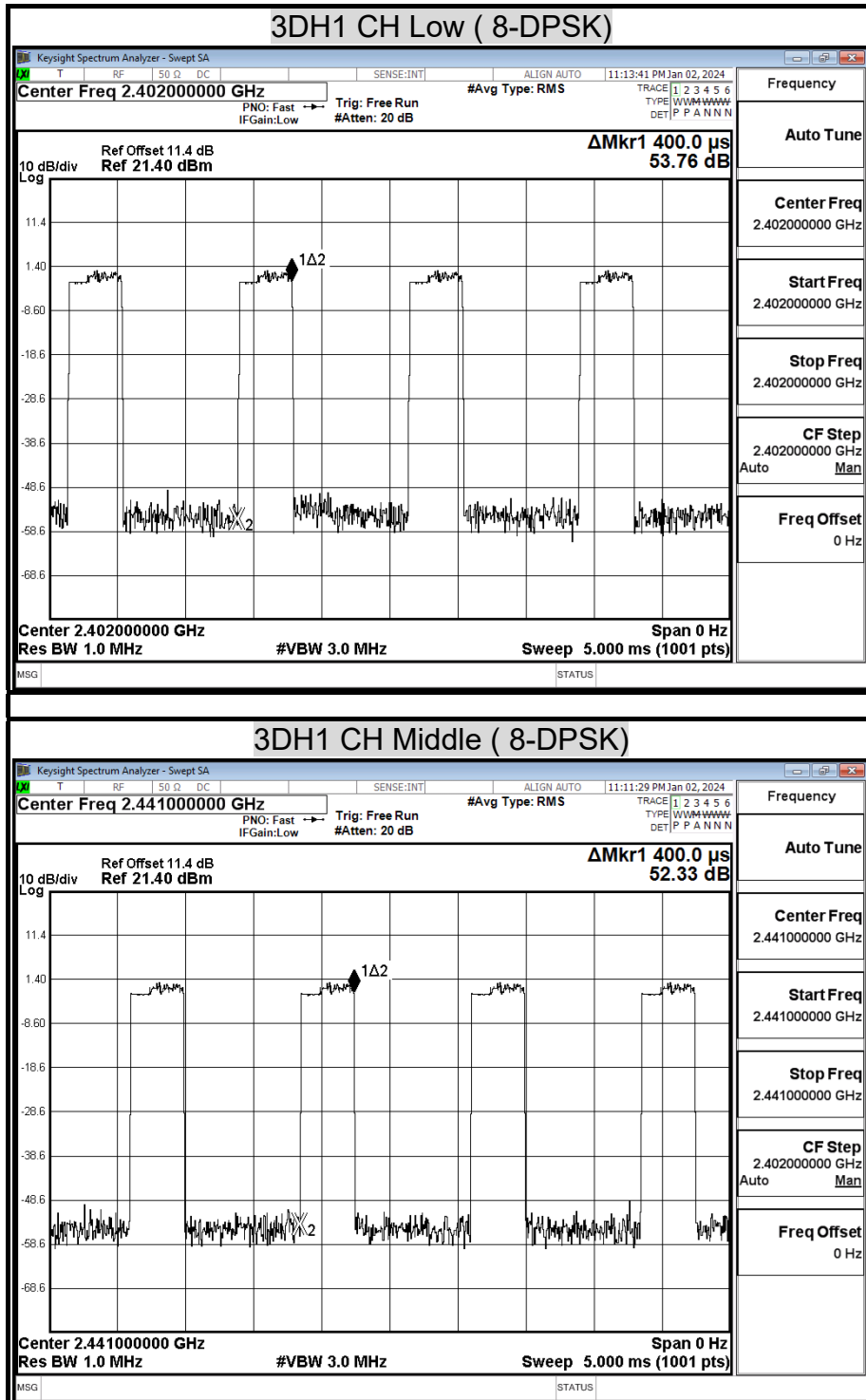

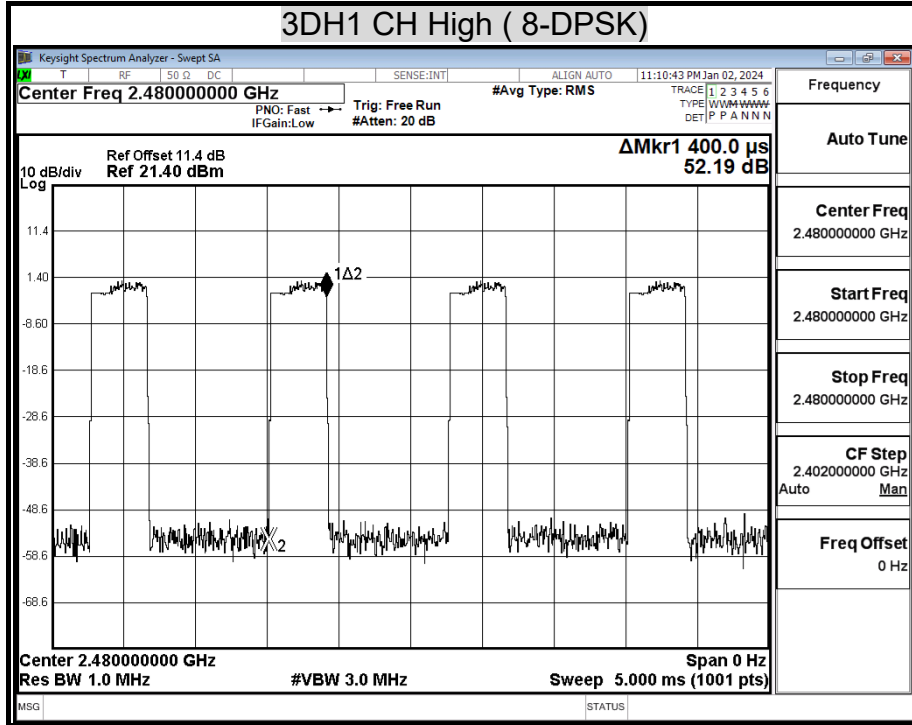

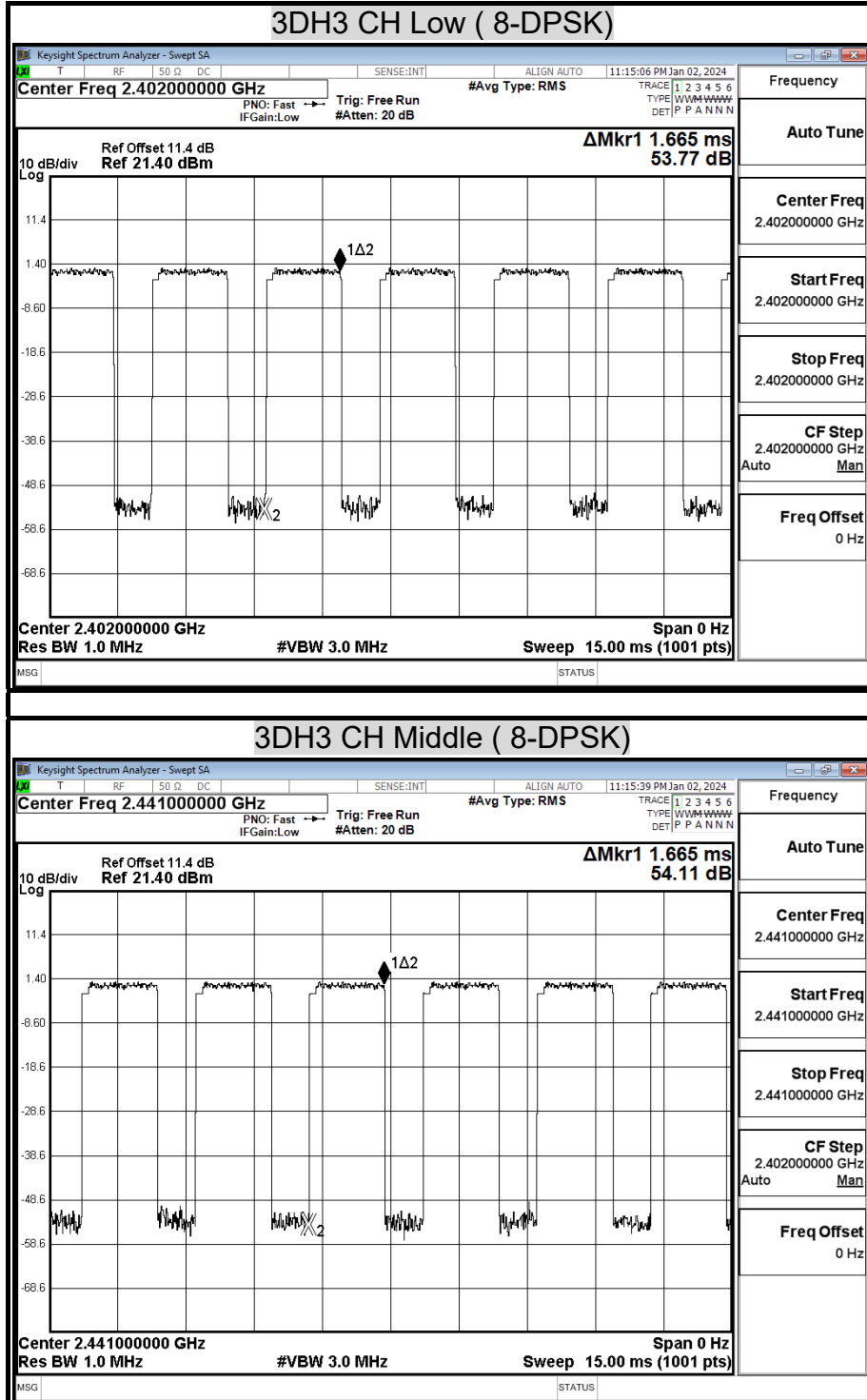

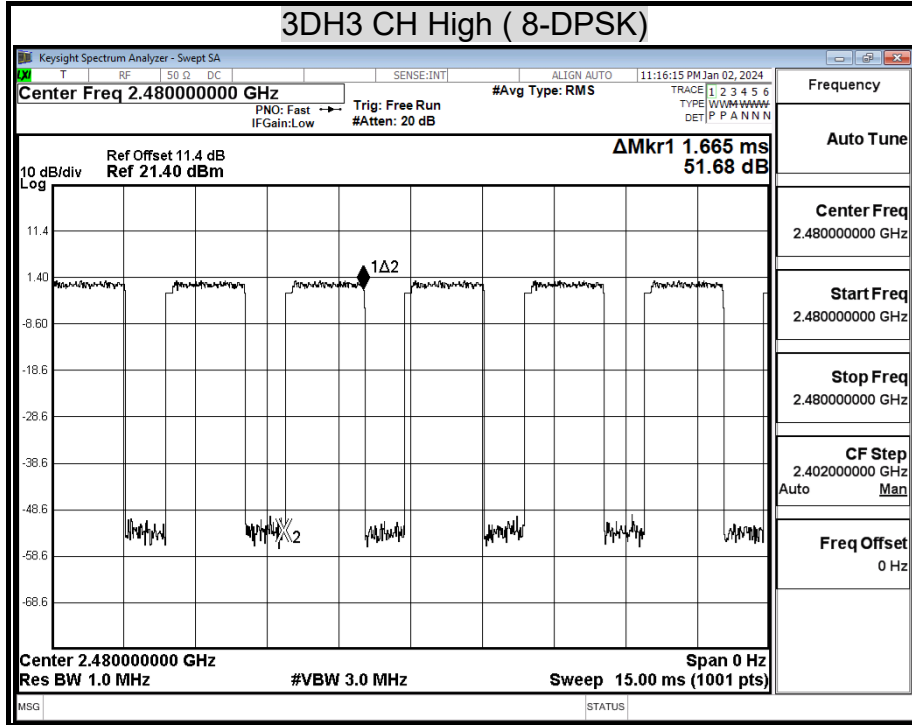

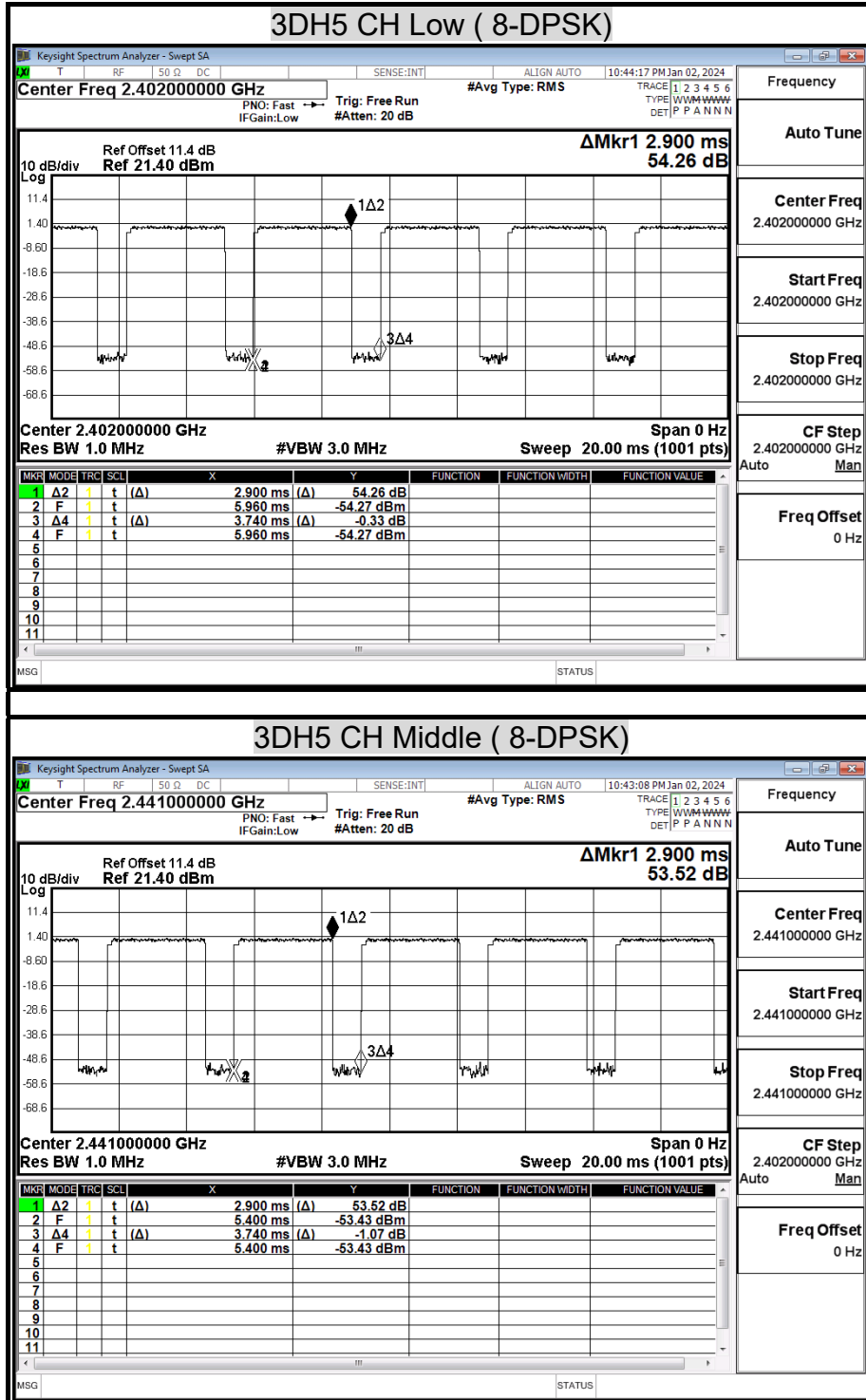

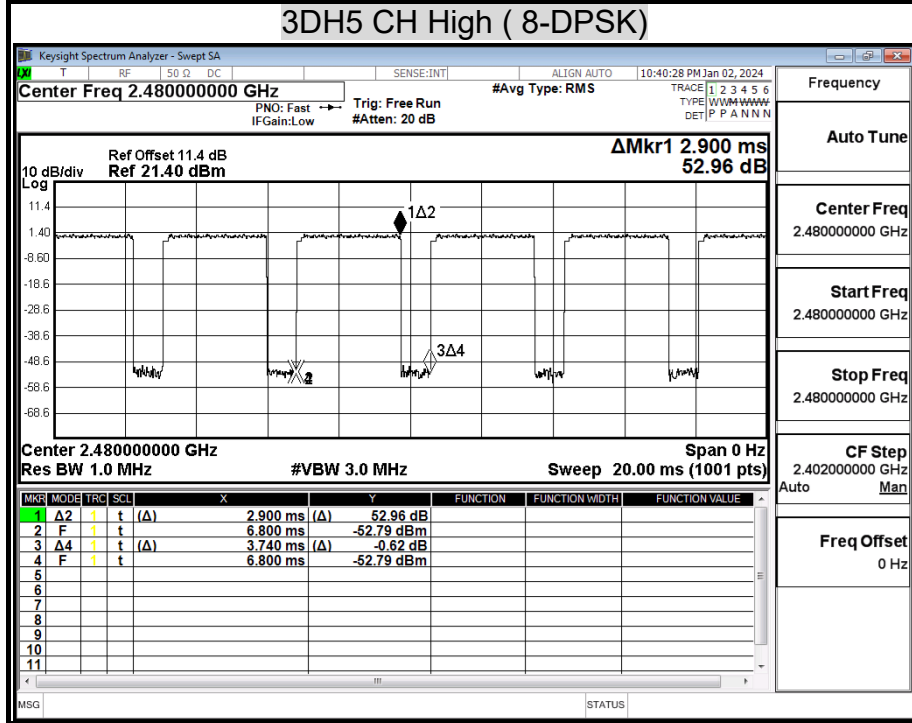

8.6 DUTY CYCLE

LIMIT

Nil (No dedicated limit specified in the Rules)

TEST SETUP

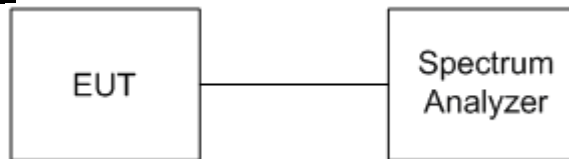

TEST PROCEDURE

1. Place the EUT on the table and set it in transmitting mode.
2. Remove the antenna from the EUT and then connect a low loss RF cable from the antenna port to the spectrum analyzer.
3. The zero-span mode on a spectrum analyzer or EMI receiver if the response time and spacing between bins on the sweep are sufficient to permit accurate measurements of the on and off times of the transmitted signal. Set the center frequency of the instrument to the center frequency of the transmission. Set $RBW \geq OBW$ if possible; otherwise, set RBW to the largest available value. Set $VBW \geq RBW$. Set detector = peak or average. The zero-span measurement method shall not be used unless both RBW and VBW are $> 50/T$ and the number of sweep points across duration T exceeds 100. (For example, if VBW and/or RBW are limited to 3 MHz, then the zero-span method of measuring duty cycle shall not be used if $T \leq 16.7$ microseconds.)

TEST RESULTS

No non-compliance noted.

TEST DATA

| | | | |
|----------------------------|-------------|------------------|------------|
| Model Name | AT-LP70XBT | Test By | Peter Chu |
| Temp & Humidity | 22.5°C, 45% | Test Date | 2023/12/27 |

Modulation Type: GFSK / DH5

| | us | Times | Ton(us) | Total Ton time(ms) |
|------|------|-------|---------|--------------------|
| Ton1 | 2900 | 1 | 2900 | |
| Ton2 | | 0 | 0 | |
| Ton3 | | | 0 | 2.9 |
| TP | | | | 3.74 |

| | |
|--------------|------|
| Ton | 2.90 |
| TP(Ton+Toff) | 3.74 |
| Duty Cycle | 0.78 |
| Duty Factor | 1.10 |

Modulation Type: 8-DPSK / 3-DH5

| | us | Times | Ton(us) | Total Ton time(ms) |
|------|------|-------|---------|--------------------|
| Ton1 | 2900 | 1 | 2900 | |
| Ton2 | | 0 | 0 | |
| Ton3 | | | 0 | 2.9 |
| TP | | | | 3.74 |

| | |
|--------------|------|
| Ton | 2.90 |
| TP(Ton+Toff) | 3.74 |
| Duty Cycle | 0.78 |
| Duty Factor | 1.10 |

TEST PLOT

Duty Cycle

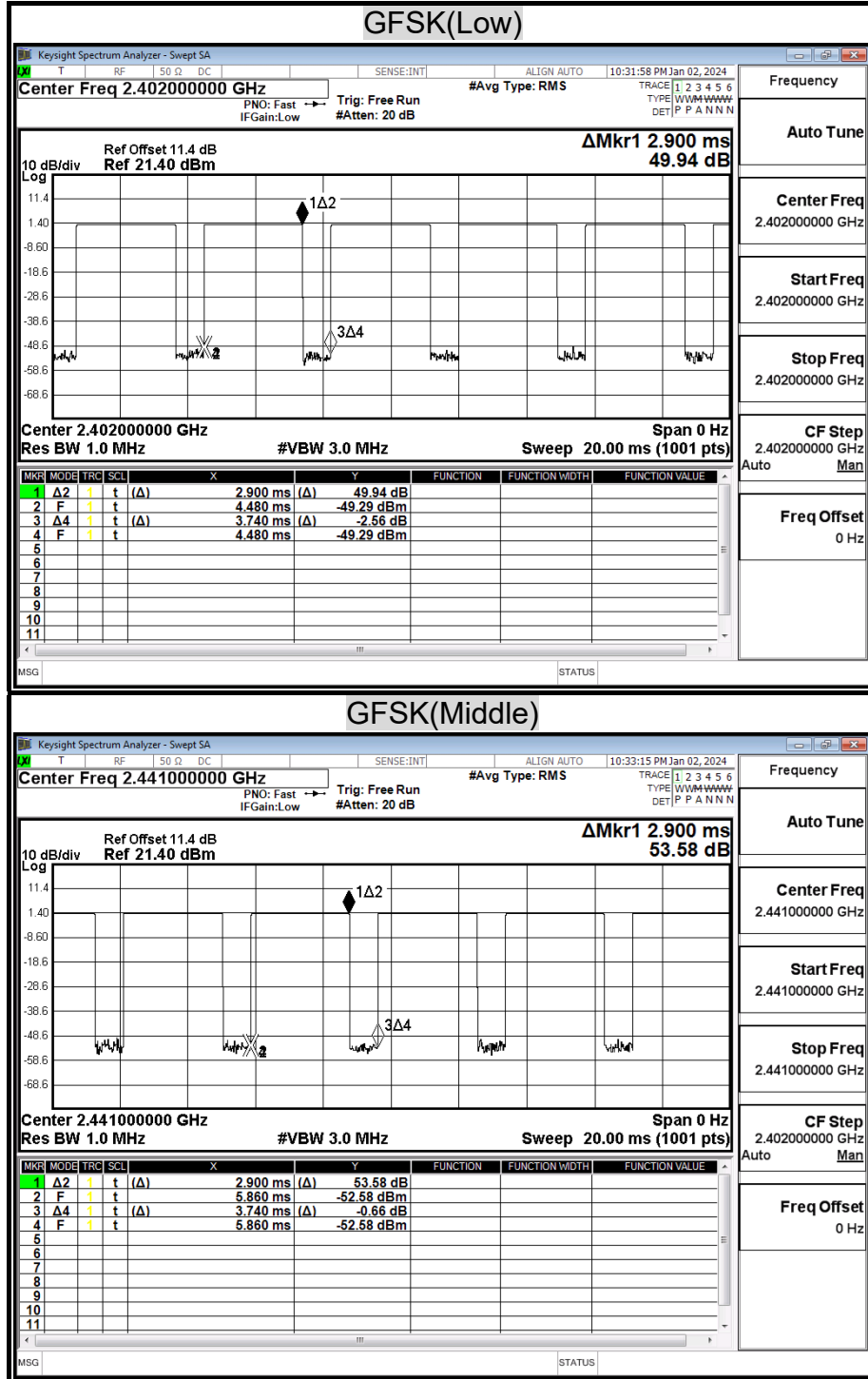

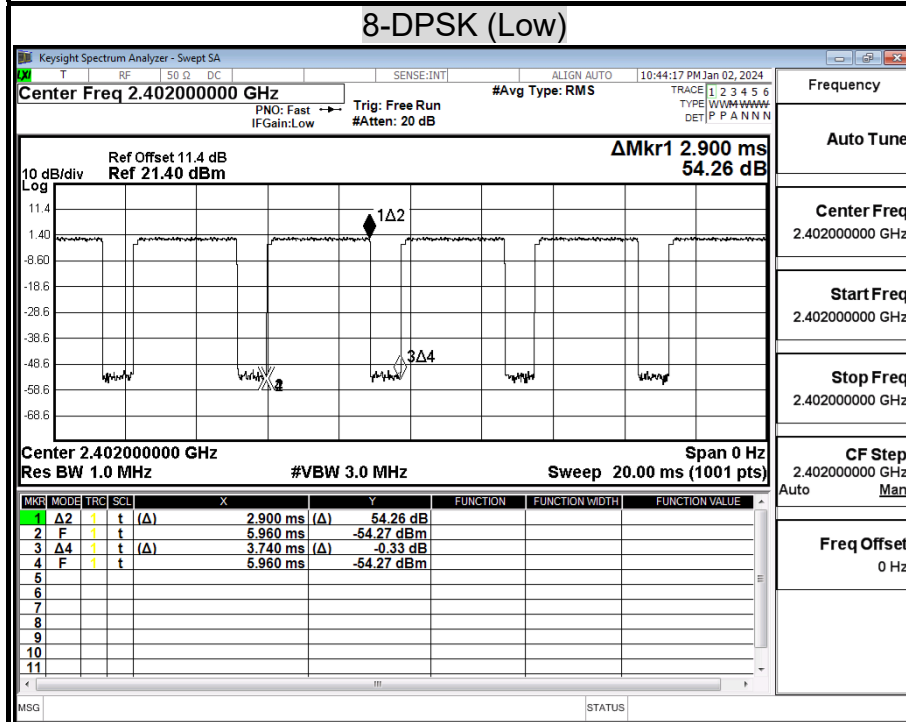
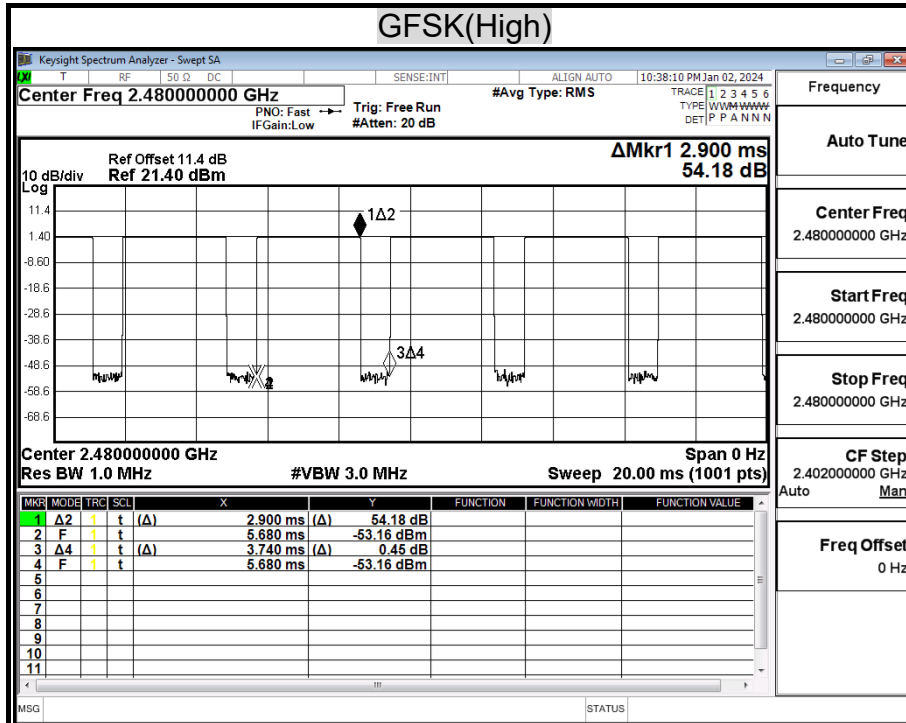

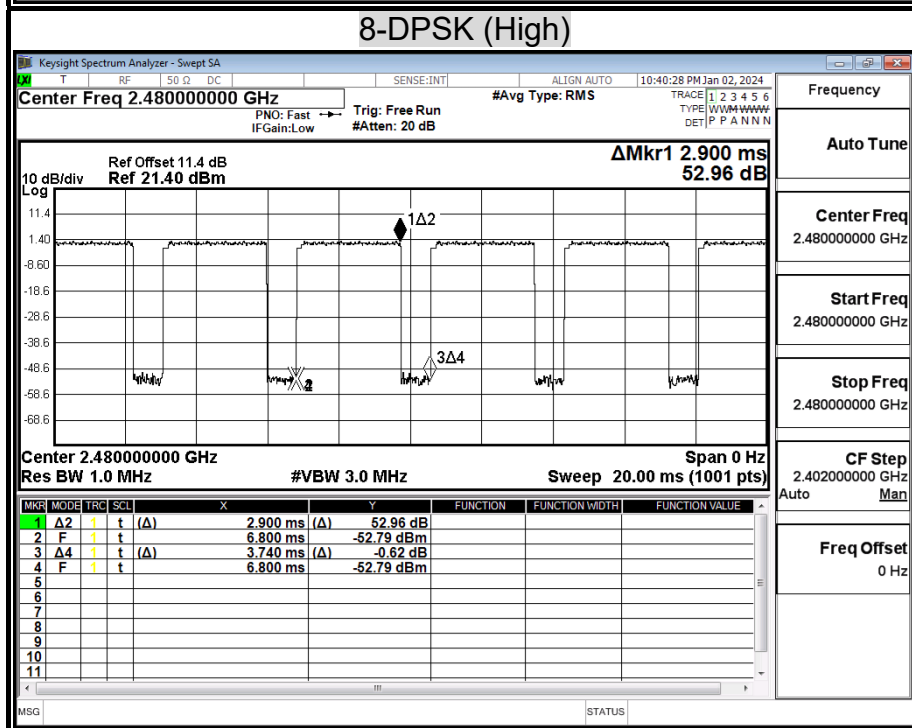
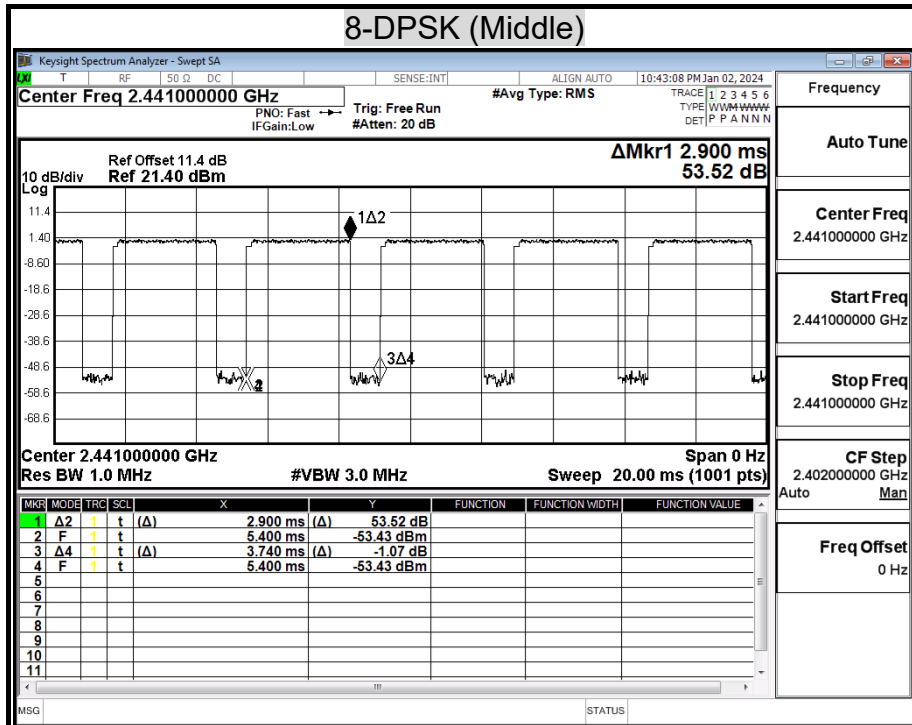

8.7 CONDUCTED SPURIOUS EMISSION

LIMITS

§ 15.247(d) In any 100 kHz bandwidth outside the frequency band in which the spread spectrum intentional radiator is operating, the radio frequency power that is produced by the intentional radiator shall be at least 20 dB below that in the 100 kHz bandwidth within the band and that contains the highest level of the desired power, based on either an RF conducted or a radiated measurement. Attenuation below the general limits specified in § 15.209(a) is not required. In addition, radiated emissions which fall in the restricted bands, as defined in § 15.205(a), must also comply with the radiated emission limits specified in § 15.209(a) (see § 15.205(c)).

TEST SETUP



TEST PROCEDURE

The transmitter output is connected to a spectrum analyzer. The resolution bandwidth is set to 100 kHz. The video bandwidth is set to 300 kHz.

The spectrum from 30 MHz to 26.5 GHz is investigated with the transmitter set to the lowest, middle, and highest channels in the 2.4 GHz band.

Report No.: TMTN2312001596NR

TEST RESULTS

| | | | |
|----------------------------|-------------|------------------|------------|
| Model Name | AT-LP70XBT | Test By | Peter Chu |
| Temp & Humidity | 22.5°C, 45% | Test Date | 2023/12/27 |

OUT-OF-BAND SPURIOUS EMISSIONS-CONDUCTED MEASUREMENT

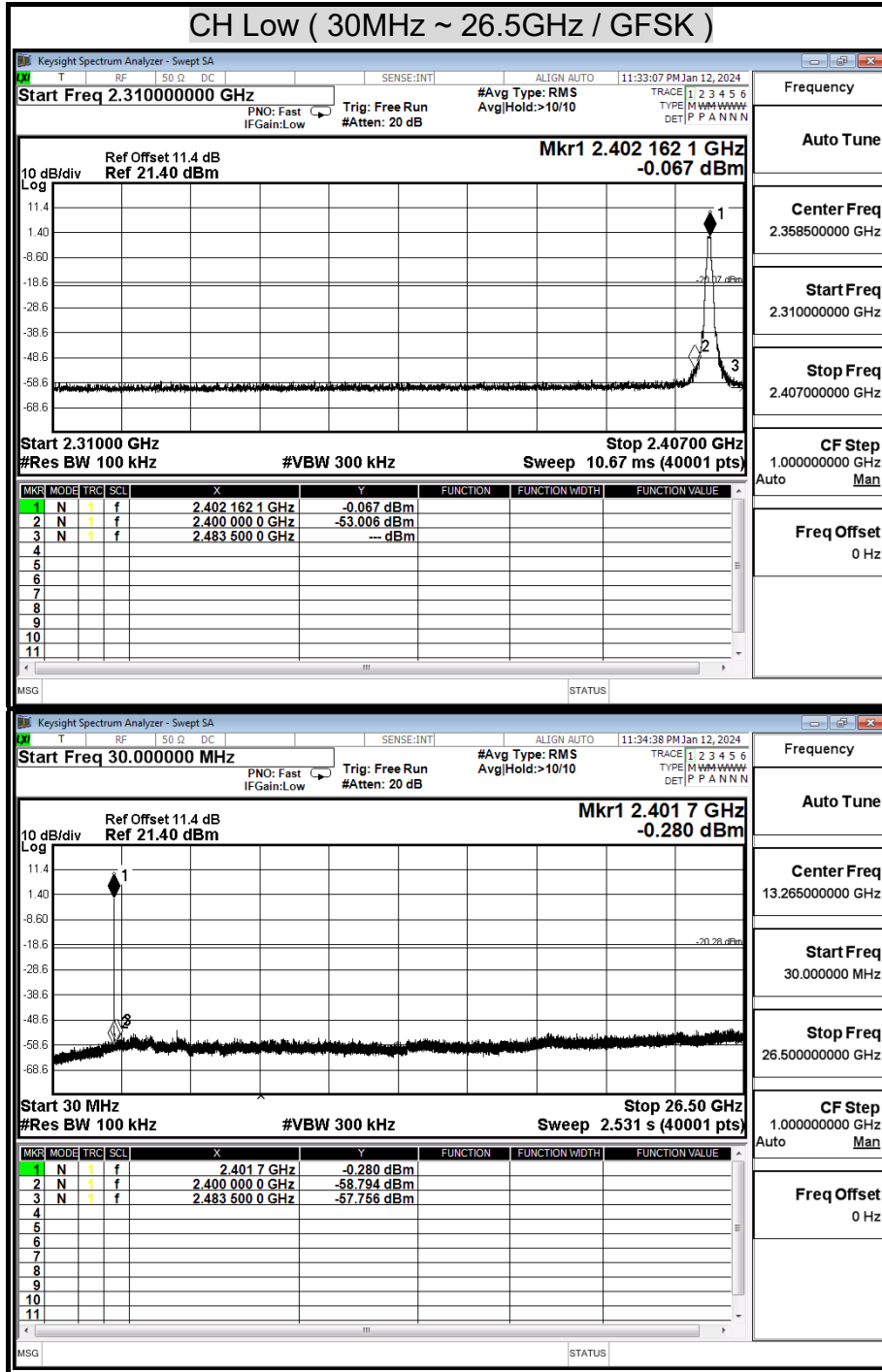

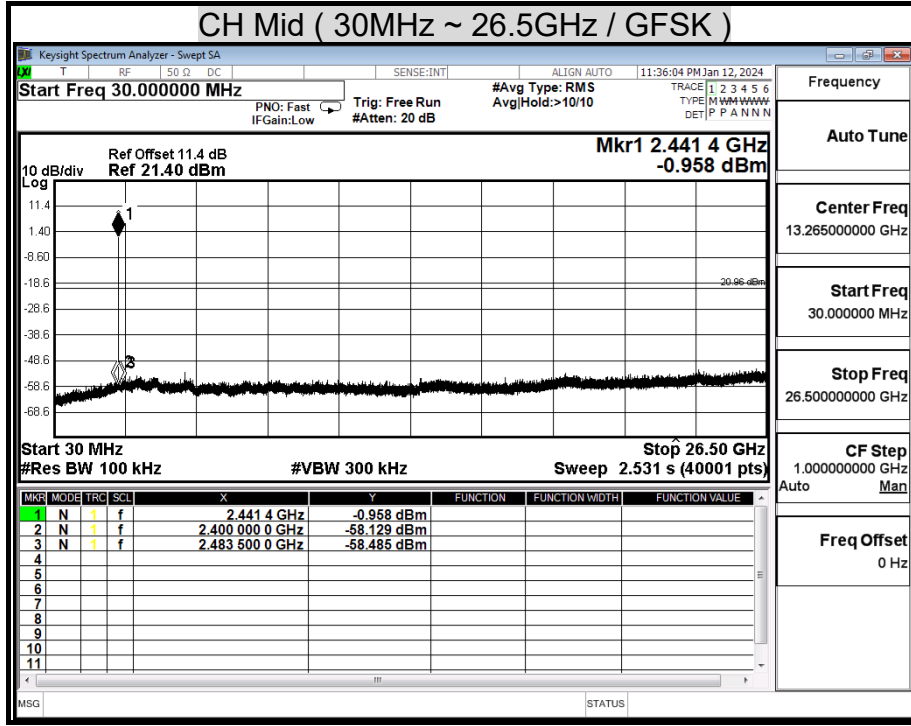

Report No.: TMTN2312001596NR

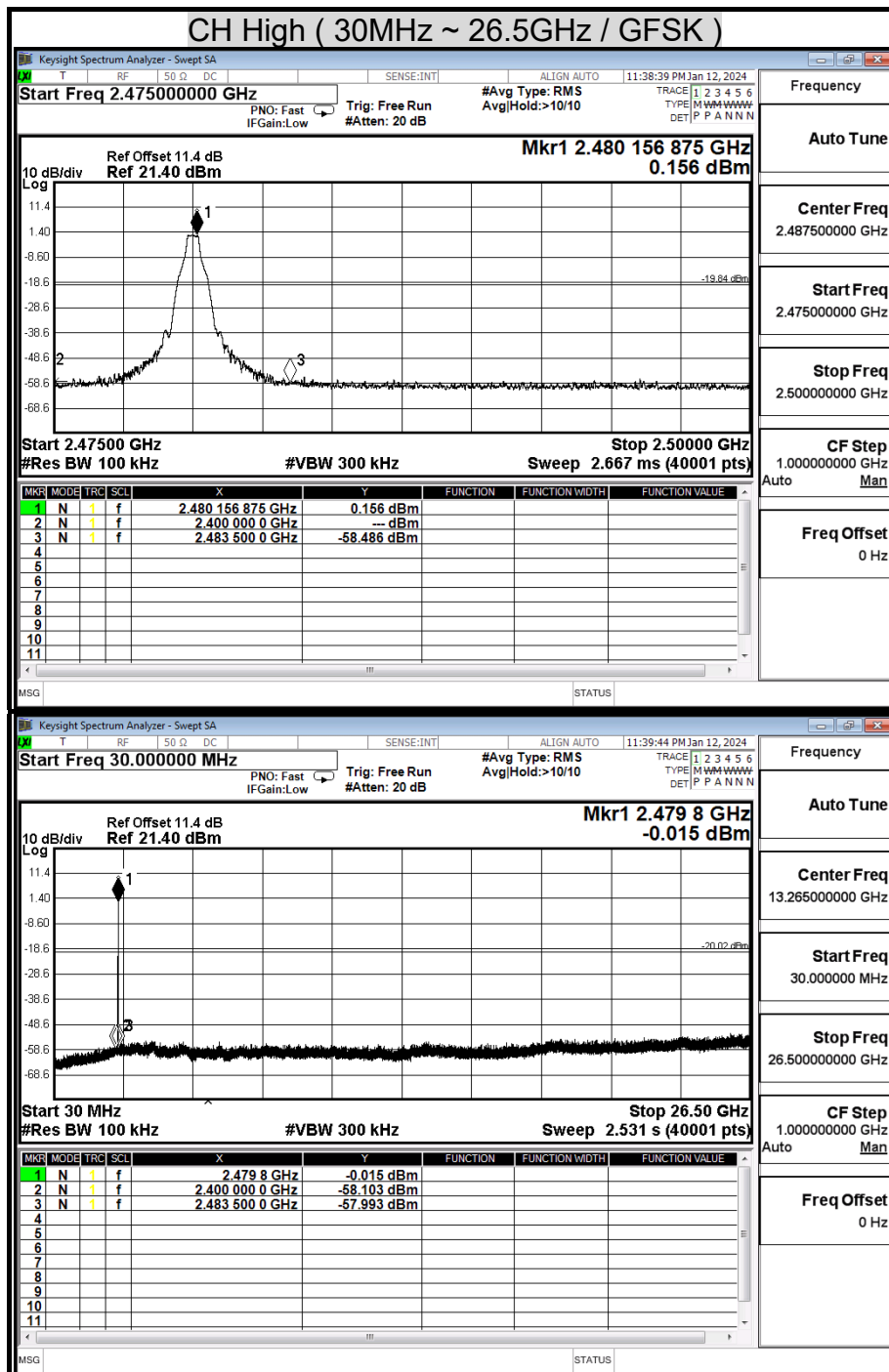

Report No.: TMTN2312001596NR

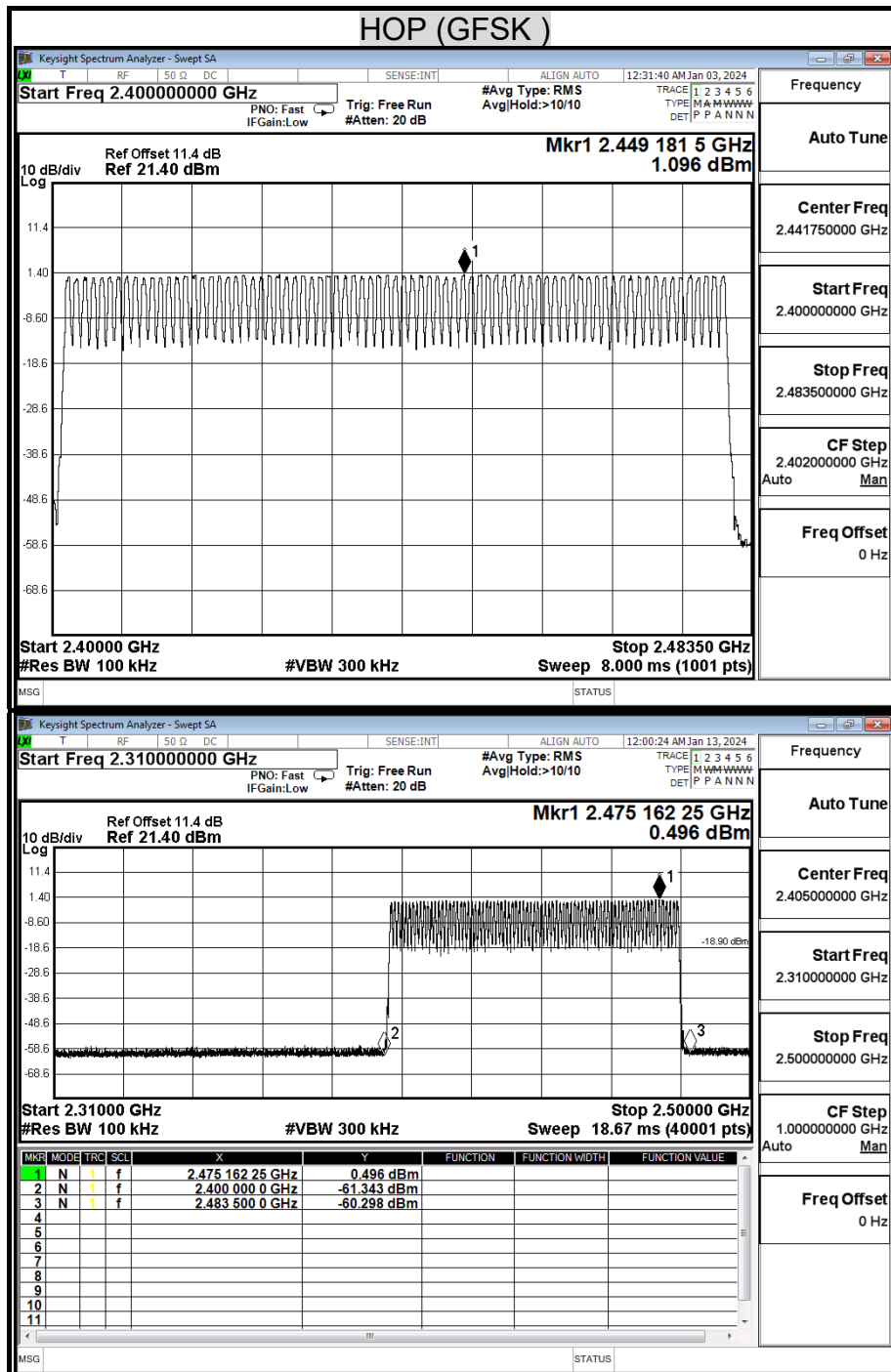

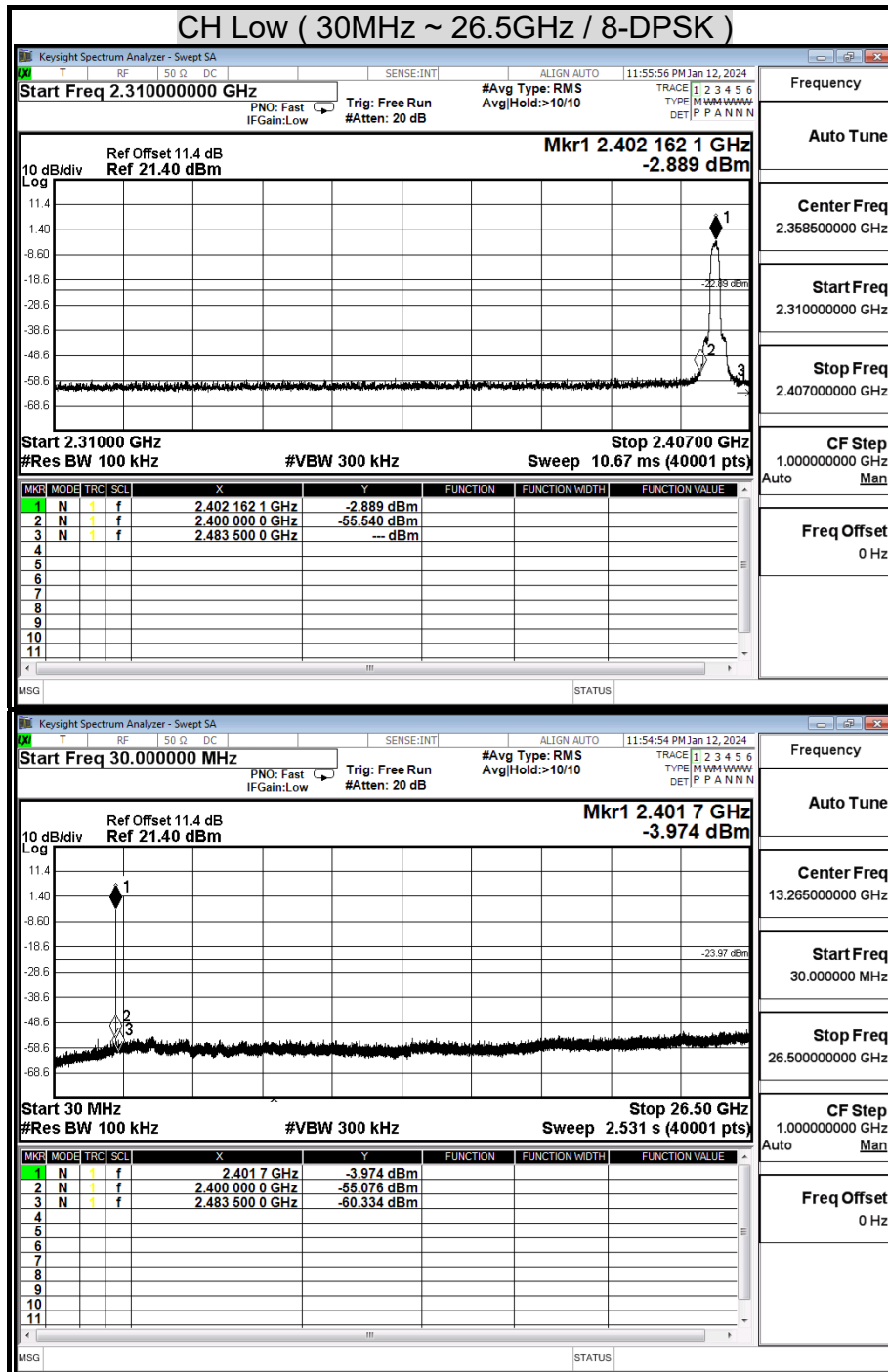

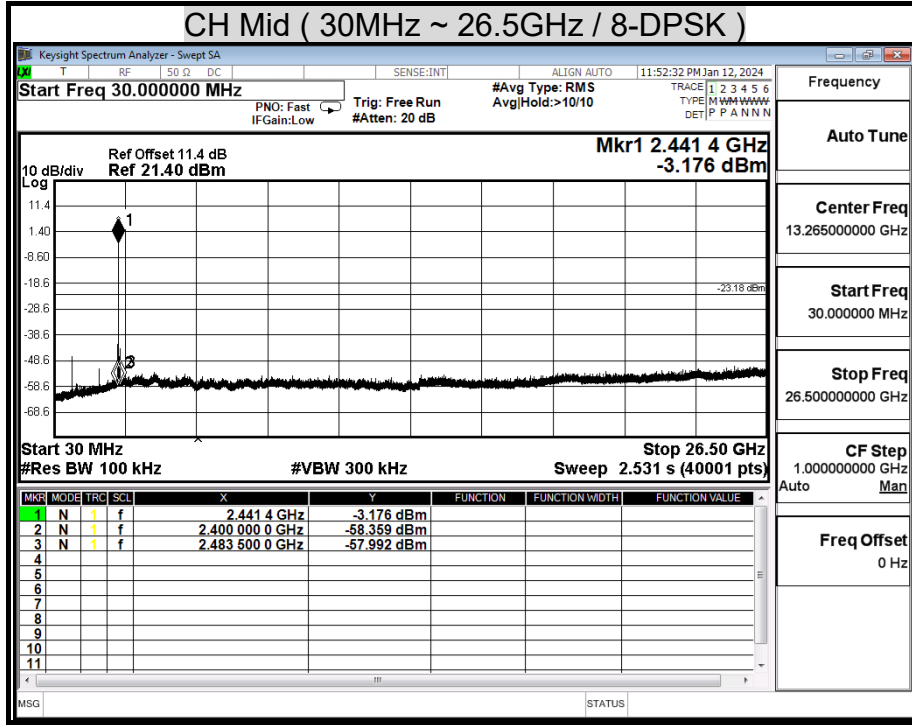

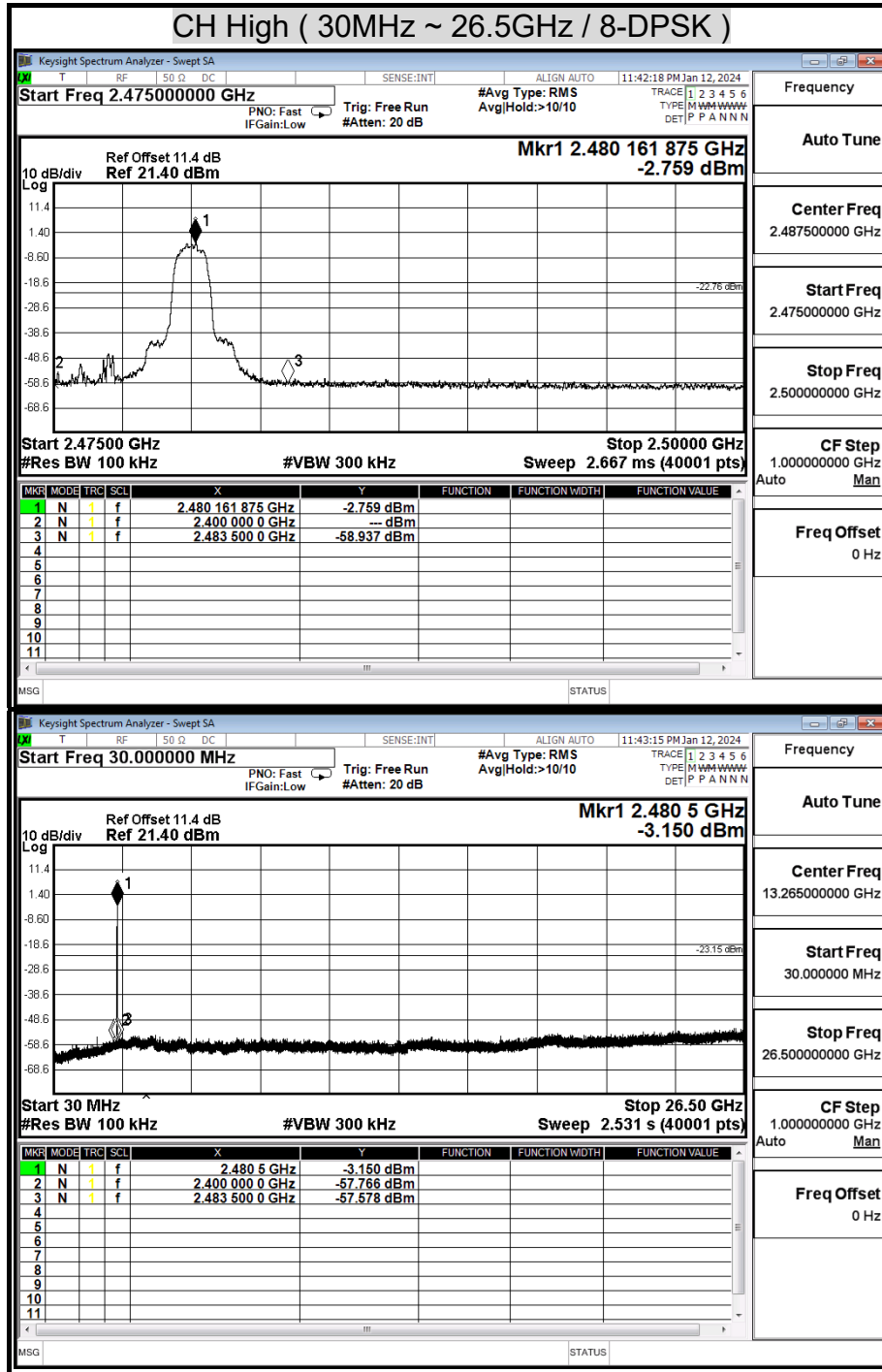

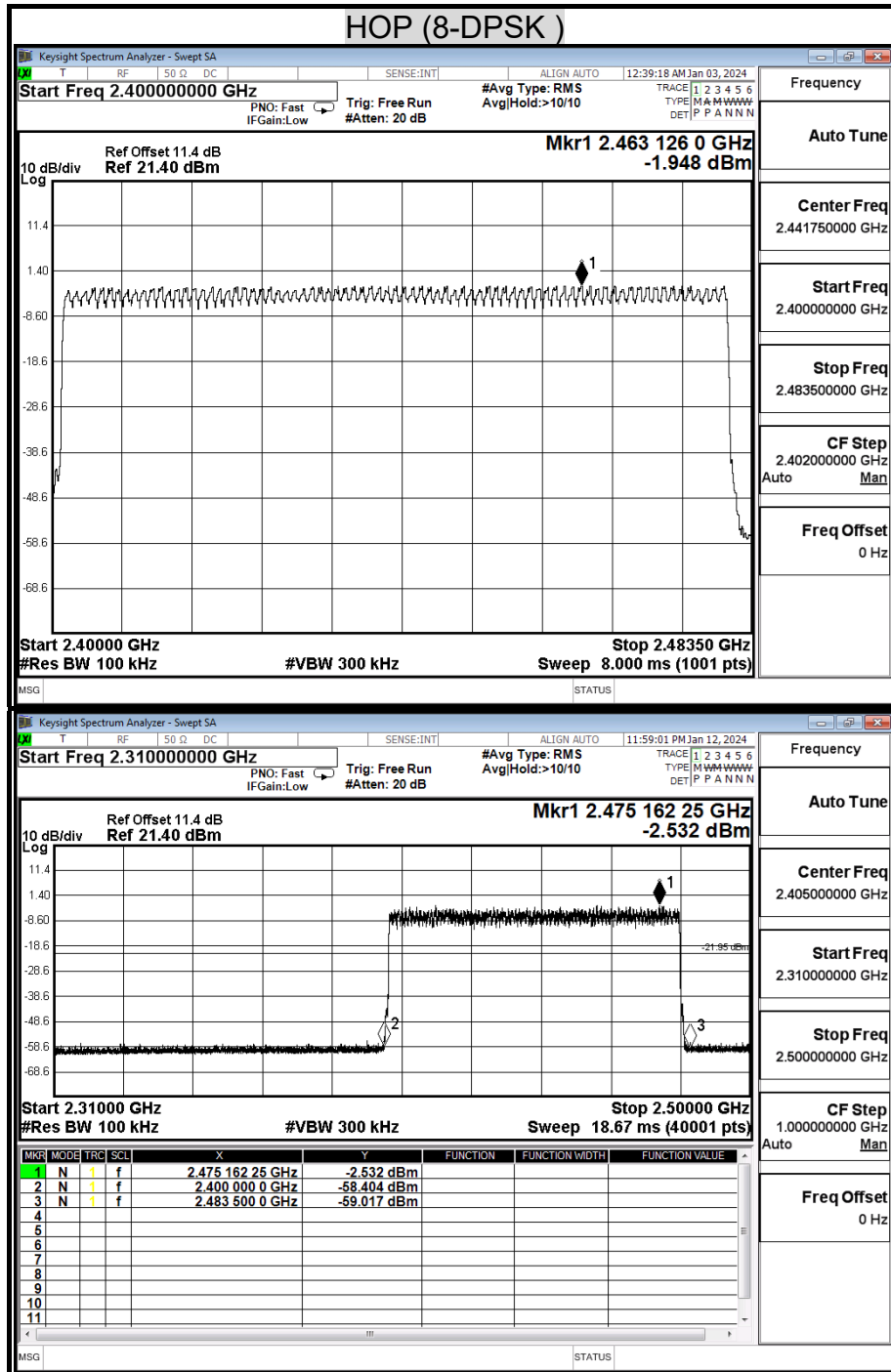

Report No.: TMTN2312001596NR

OUT-OF-BAND SPURIOUS EMISSIONS-CONDUCTED MEASUREMENT

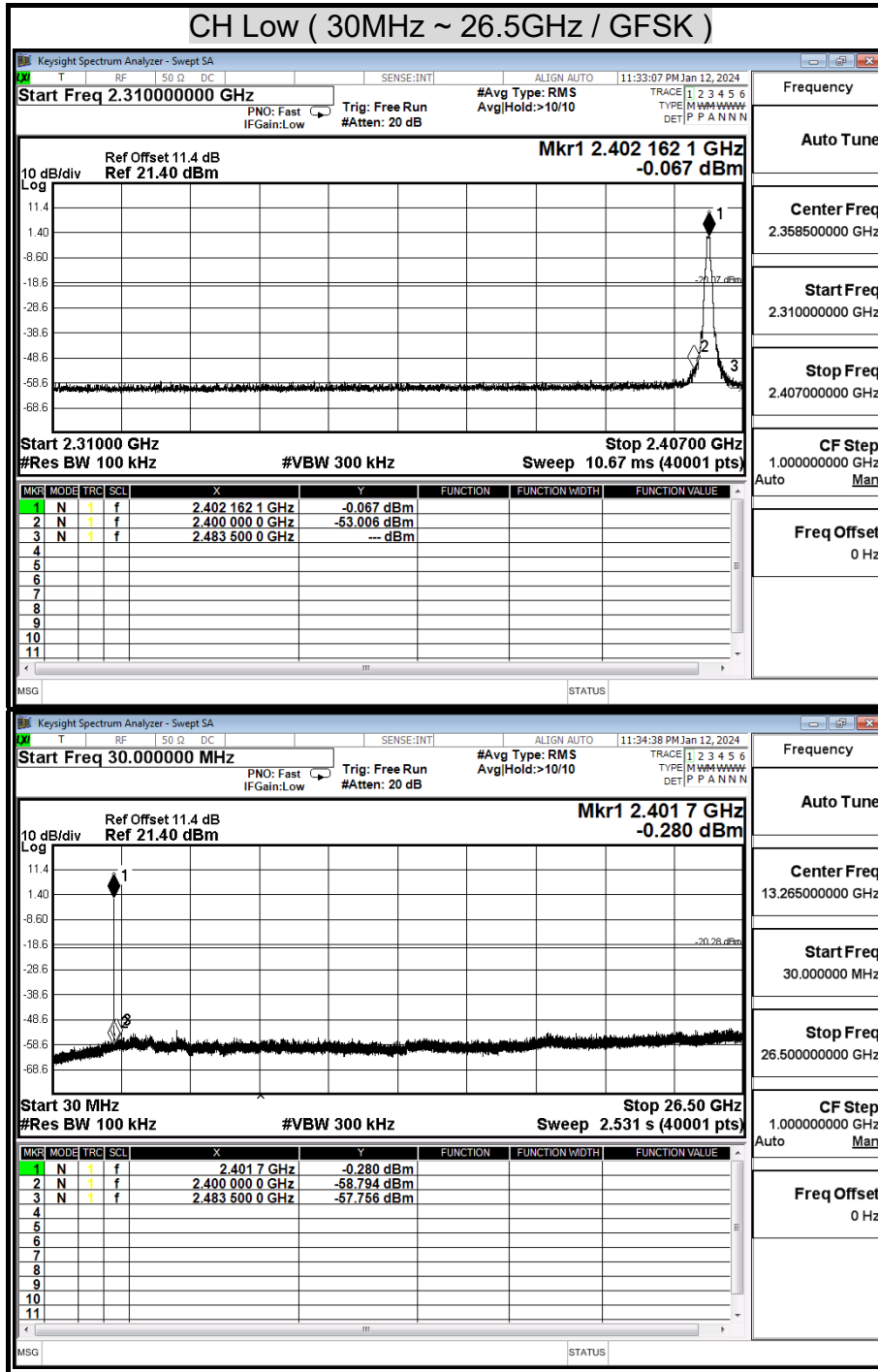

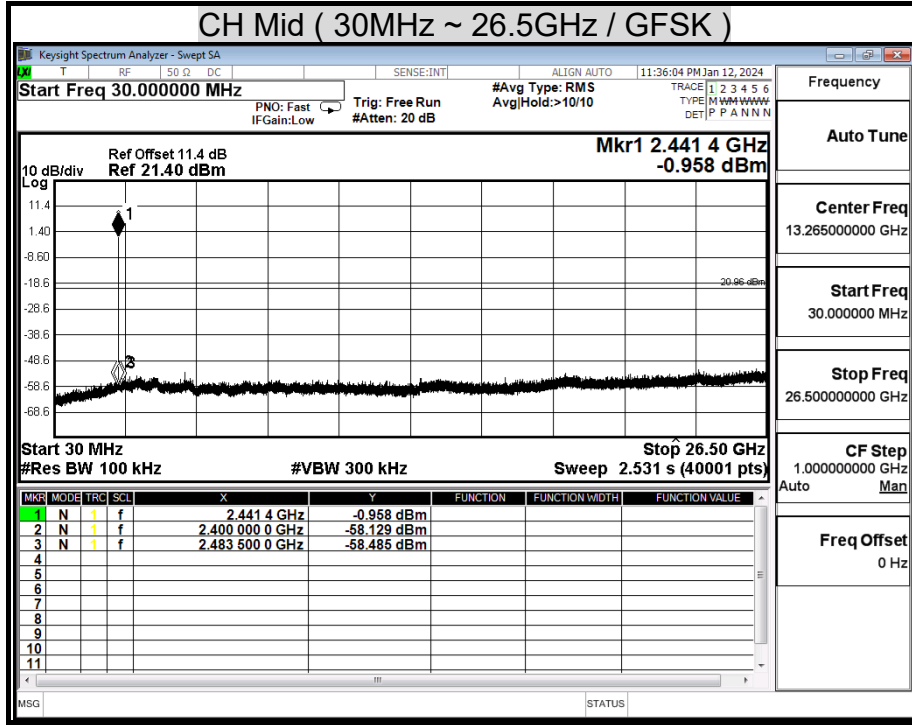

Report No.: TMTN2312001596NR

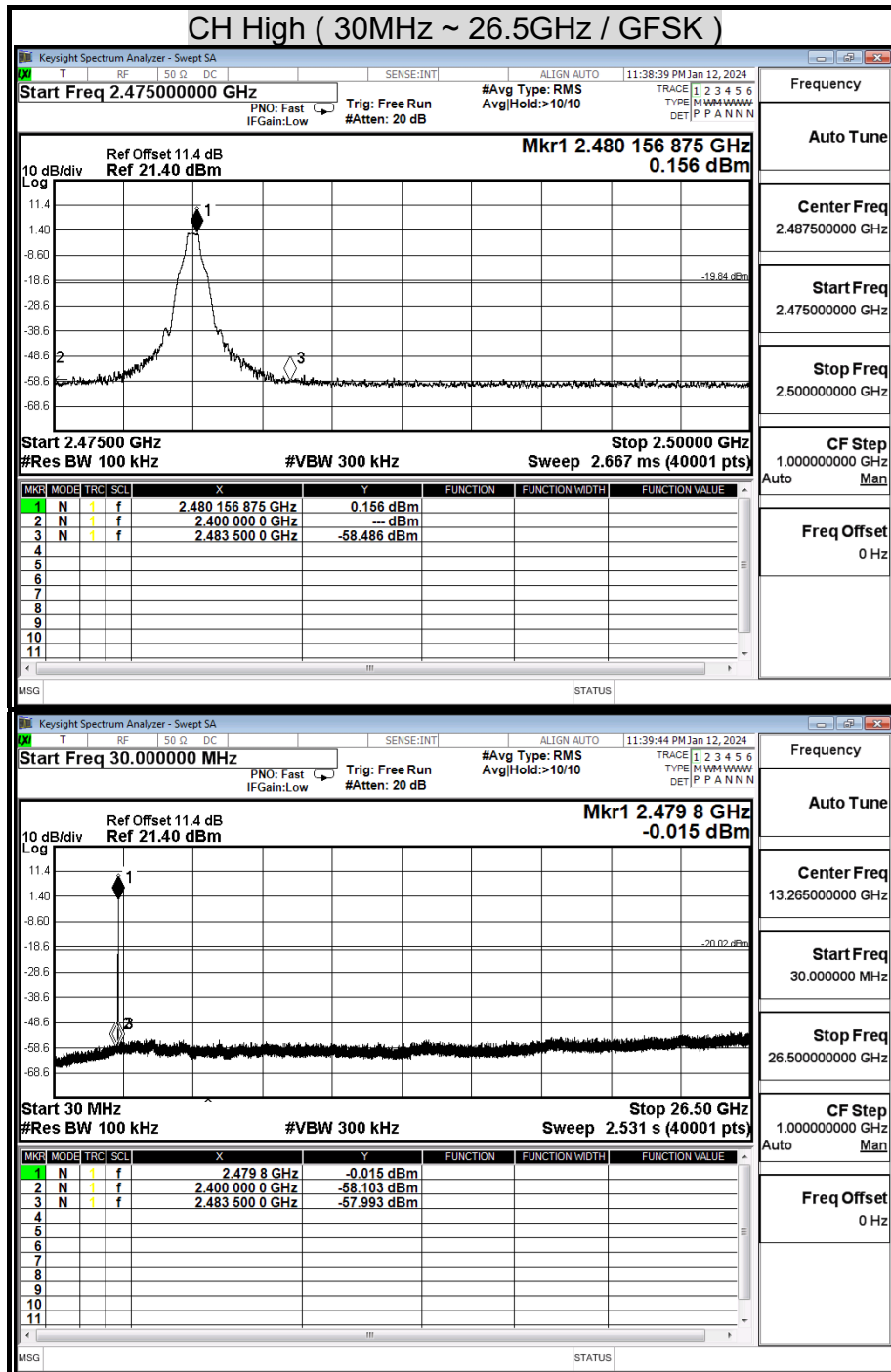

Report No.: TMTN2312001596NR

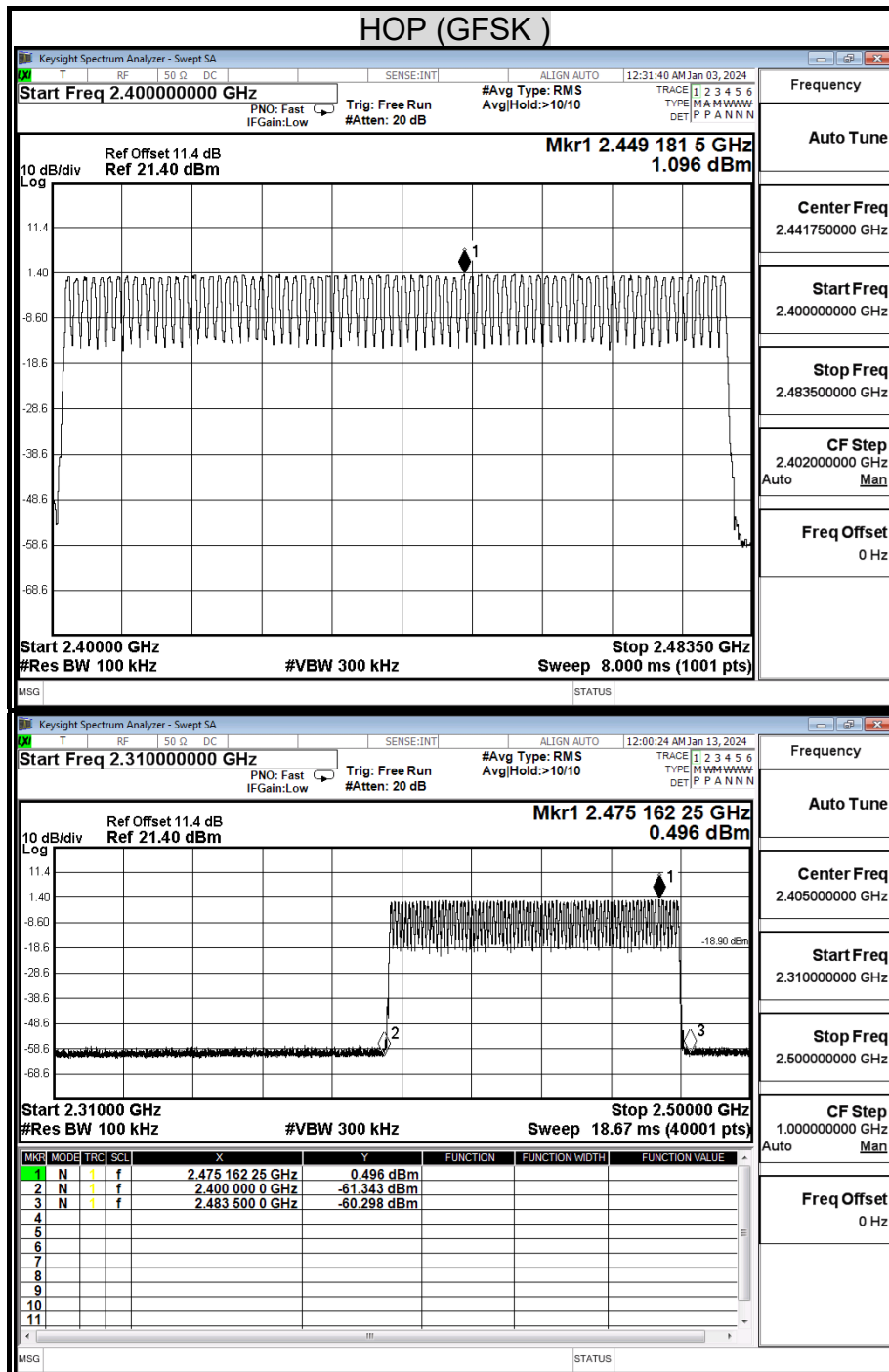

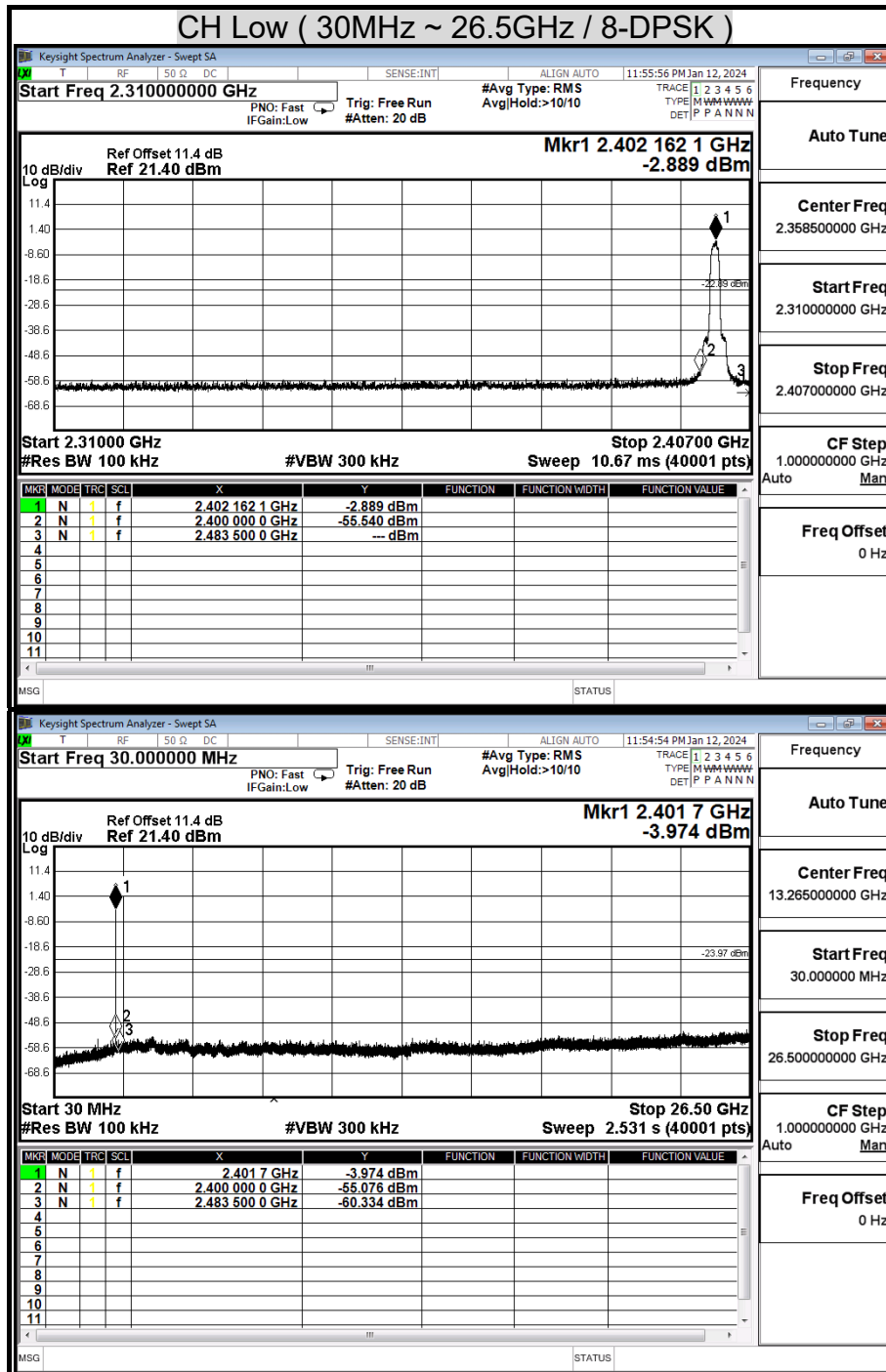

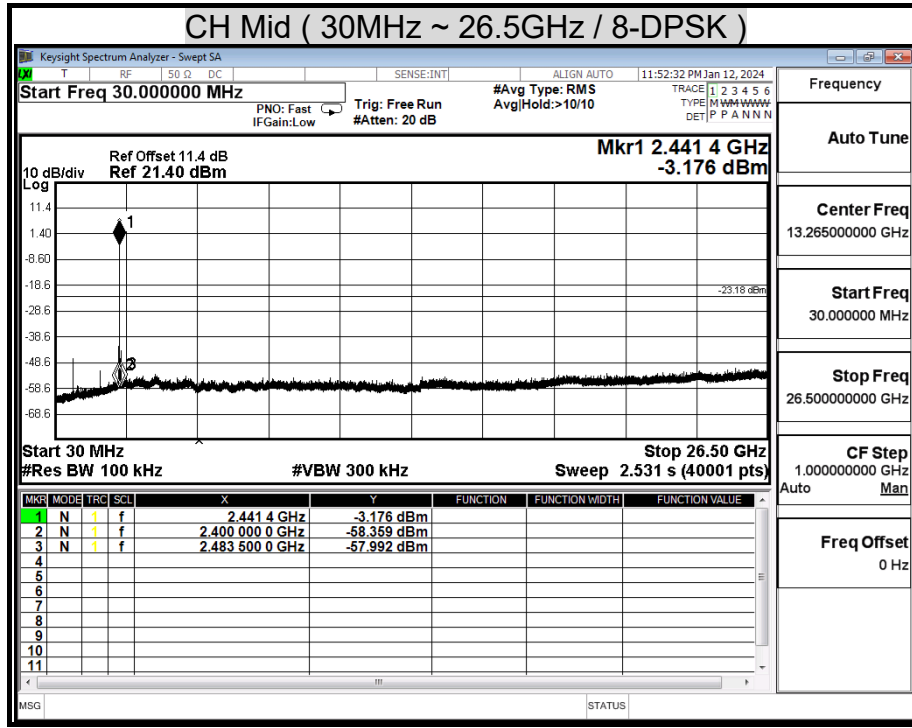

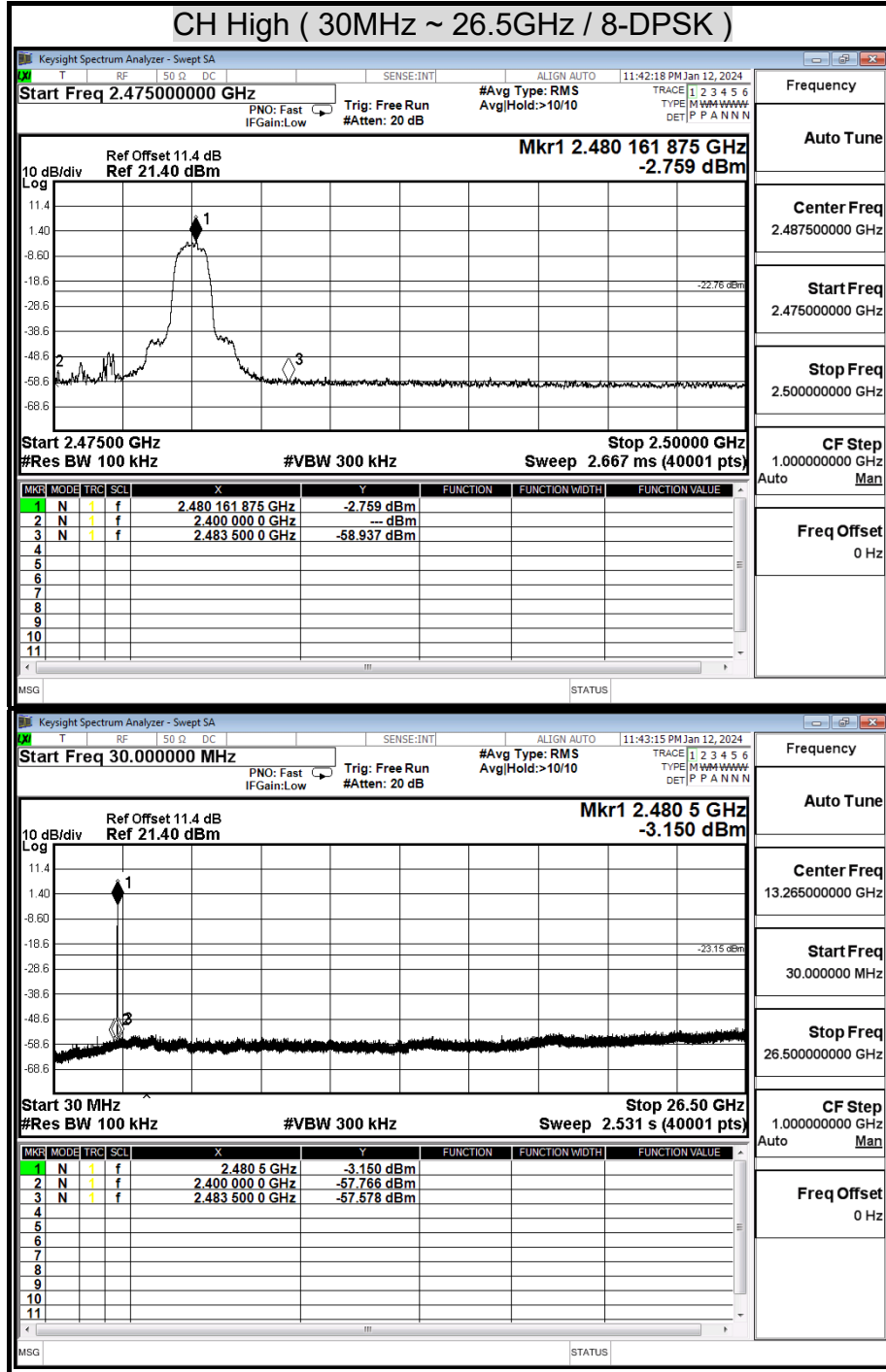

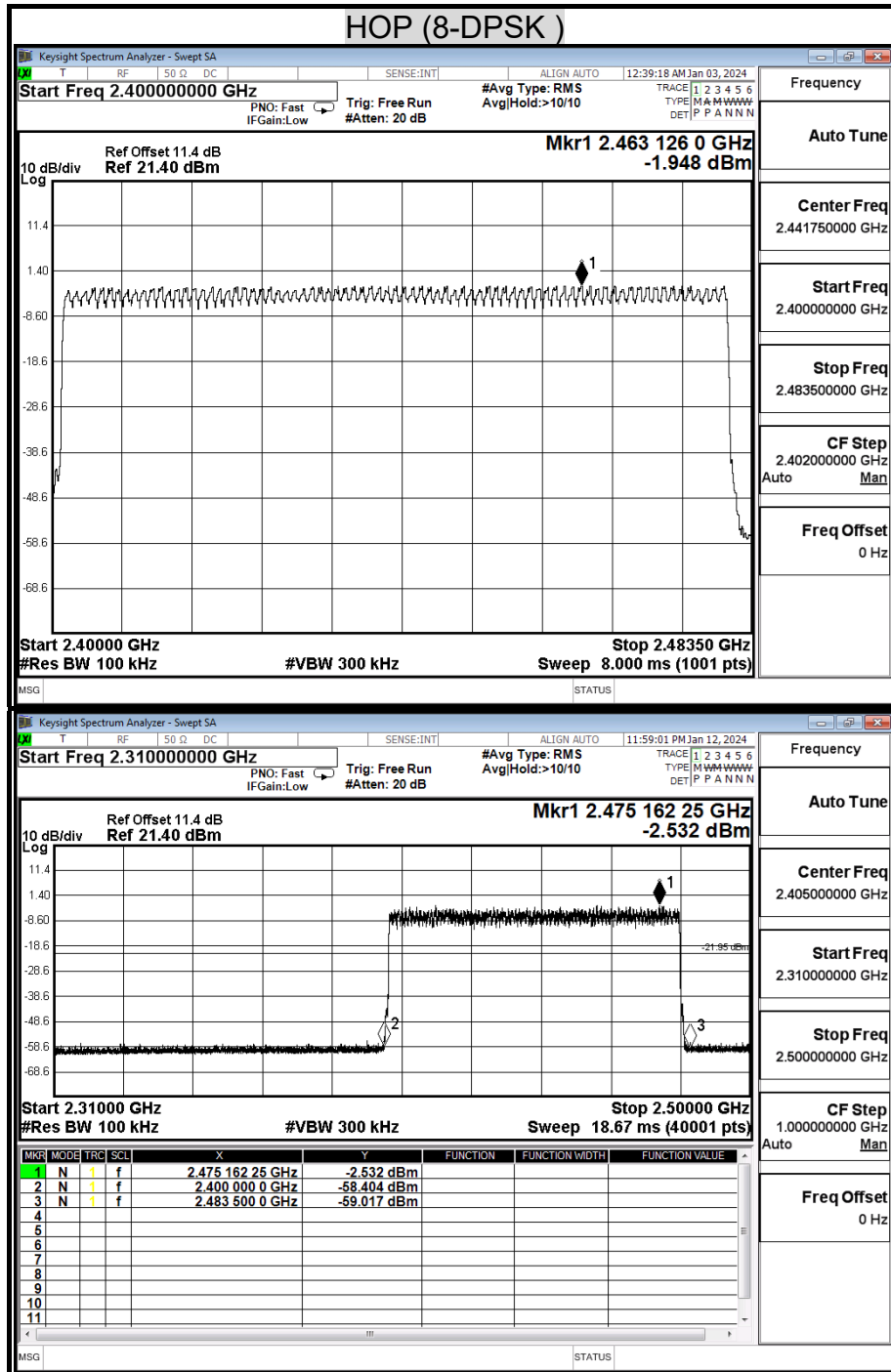

8.8 RADIATED EMISSIONS

8.8.1 TRANSMITTER RADIATED SUPURIOUS EMSSIONS

LIMITS

§ 15.205 (a) Except as shown in paragraph (d) of this section, only spurious emissions are permitted in any of the frequency bands listed below:

| MHz | MHz | MHz | GHz |
|----------------------------|--------------------------|-----------------|------------------|
| 0.090 - 0.110 | 16.42 - 16.423 | 399.9 - 410 | 4.5 - 5.15 |
| ¹ 0.495 - 0.505 | 16.69475 - 16.69525 | 608 - 614 | 5.35 - 5.46 |
| 2.1735 - 2.1905 | 16.80425 - 16.80475 | 960 - 1240 | 7.25 - 7.75 |
| 4.125 - 4.128 | 25.5 - 25.67 | 1300 - 1427 | 8.025 - 8.5 |
| 4.17725 - 4.17775 | 37.5 - 38.25 | 1435 - 1626.5 | 9.0 - 9.2 |
| 4.20725 - 4.20775 | 73 - 74.6 | 1645.5 - 1646.5 | 9.3 - 9.5 |
| 6.215 - 6.218 | 74.8 - 75.2 | 1660 - 1710 | 10.6 - 12.7 |
| 6.26775 - 6.26825 | 108 - 121.94 | 1718.8 - 1722.2 | 13.25 - 13.4 |
| 6.31175 - 6.31225 | 123 - 138 | 2200 - 2300 | 14.47 - 14.5 |
| 8.291 - 8.294 | 149.9 - 150.05 | 2310 - 2390 | 15.35 - 16.2 |
| 8.362 - 8.366 | 156.52475 - 156.52525 | 2483.5 - 2500 | 17.7 - 21.4 |
| 8.37625 - 8.38675 | 156.7 - 156.9 | 2655 - 2900 | 22.01 - 23.12 |
| 8.41425 - 8.41475 | 162.0125 - 167.17 | 3260 - 3267 | 23.6 - 24.0 |
| 12.29 - 12.293 | 167.72 - 173.2 | 3332 - 3339 | 31.2 - 31.8 |
| 12.51975 - 12.52025 | 240 - 285 | 3345.8 - 3338 | 36.43 - 36.5 |
| 12.57675 - 12.57725 | 322 - 335.4 | 3600 - 4400 | (²) |
| 13.36 - 13.41 | | | |

¹ Until February 1, 1999, this restricted band shall be 0.490-0.510 MHz.

² Above 38.6

§ 15.205 (b) Except as provided in paragraphs (d) and (e), the field strength of emissions appearing within these frequency bands shall not exceed the limits shown in Section 15.209. At frequencies equal to or less than 1000 MHz, compliance with the limits in Section 15.209 shall be demonstrated using measurement instrumentation employing a CISPR quasi-peak detector. Above 1000 MHz, compliance with the emission limits in Section 15.209 shall be demonstrated based on the average value of the measured emissions. The provisions in Section 15.35 apply to these measurements.

Report No.: TMTN2312001596NR

§ 15.209 (a) Except as provided elsewhere in this Subpart, the emissions from an intentional radiator shall not exceed the field strength levels specified in the following table :

| Frequency (MHz) | Field Strength (microvolts/meter) | Measurement Distance (meters) |
|-----------------|-----------------------------------|-------------------------------|
| 30 - 88 | 100 ** | 3 |
| 88 - 216 | 150 ** | 3 |
| 216 - 960 | 200 ** | 3 |
| Above 960 | 500 | 3 |

** Except as provided in paragraph (g), fundamental emissions from intentional radiators operating under this Section shall not be located in the frequency bands 54-72 MHz, 76-88 MHz, 174-216 MHz or 470-806 MHz, However, operation within these frequency bands is permitted under other sections of this Part, e-g, Sections 15.231 and 15.241.

§ 15.209 (b) In the emission table above, the tighter limit applies at the band edges.

TEST SETUP

The diagram below shows the test setup that is utilized to make the measurements for emission from below 1GHz.

9kHz ~ 30MHz

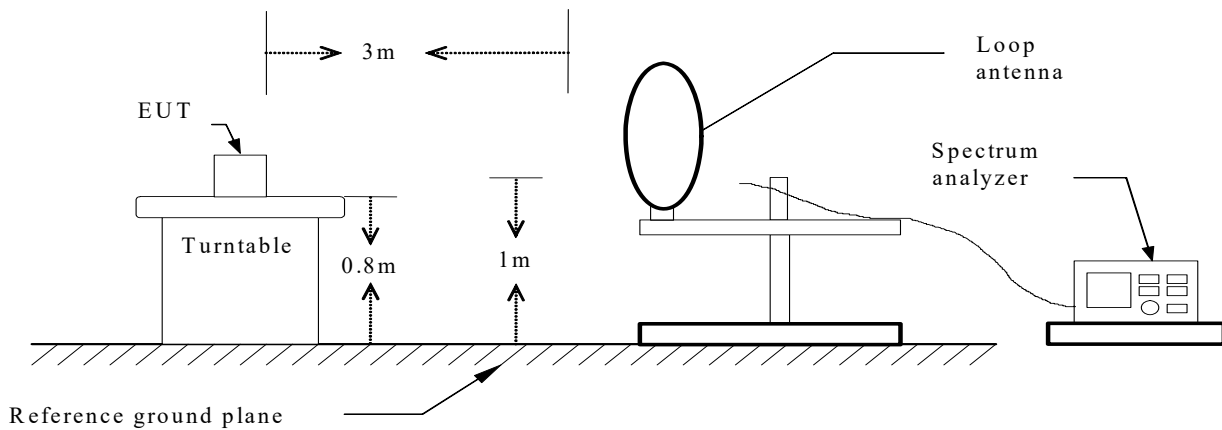

30MHz ~ 1GHz

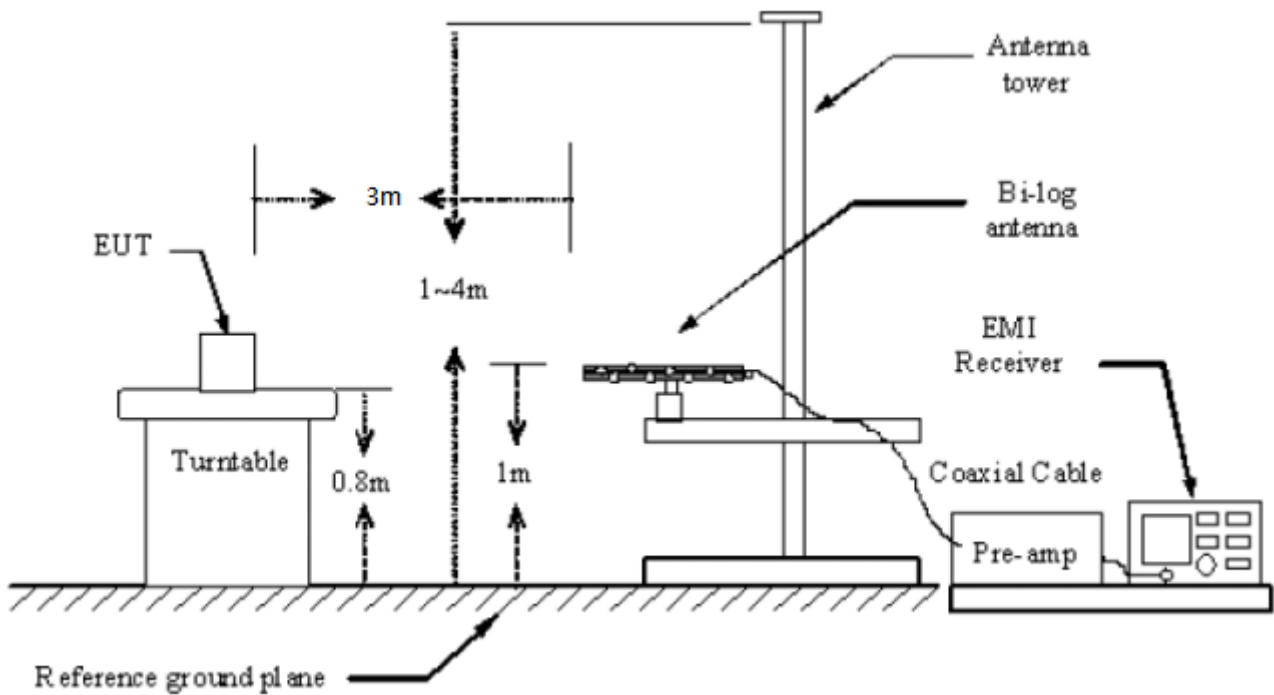

Report No.: TMTN2312001596NR

The diagram below shows the test setup that is utilized to make the measurements for emission above 1GHz.

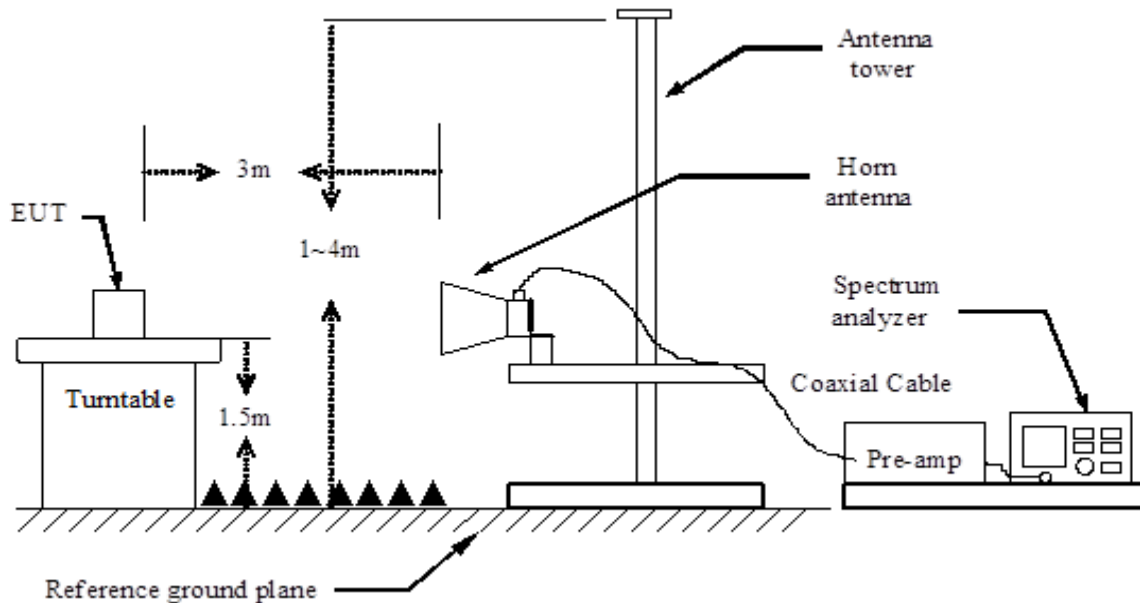

TEST PROCEDURE

- a. The EUT was placed on the top of a rotating table 0.8/1.5 meters above the ground at a 3 meter chamber test site. The table was rotated 360 degrees to determine the position of the highest radiation.
- b. While measuring the radiated emission below 1GHz, the EUT was set 3 meters away from the interference-receiving antenna, which was mounted on the top of a variable-height antenna tower. While measuring the radiated emission above 1GHz, the EUT was set 3 meters away from the interference-receiving antenna
- c. The antenna is a broadband antenna, and its height is varied from one meter to four meters above the ground to determine the maximum value of the field strength. Both horizontal and vertical polarization of the antenna are set to make the measurement.
- d. For each suspected emission, the EUT was arranged to its worst case and then the antenna was tuned to heights from 1 meter to 4 meters and the table was turned from 0 degrees to 360 degrees to find the maximum reading.
- e. The spectrum analyzer was set to Peak Detect Function and Specified Bandwidth with Maximum Hold Mode.
- f. If the emission level of the EUT in peak mode was 10 dB lower than the limit specified, then testing could be stopped and the peak values of the EUT would be reported. Otherwise the emissions that did not have 10 dB margin would be re-tested one by one using peak, quasi-peak or average method as specified and then reported in a data sheet.
- g. The tests were performed in accordance with 558074 D01 15.247 Meas Guidance v05Note :

NOTE:

1. The resolution bandwidth of test receiver is 200Hz for Quasi-peak detection (QP) at frequency 9~150(kHz).
2. The resolution bandwidth of test receiver is 9kHz for Quasi-peak detection (QP) at frequency 0.15~30(MHz).

Report No.: TMTN2312001596NR

3. The resolution bandwidth of test receiver is 120kHz for Quasi-peak detection (QP) at frequency 30~1000(MHz).
4. The resolution bandwidth and video bandwidth of test receiver/spectrum analyzer is 1 MHz for Peak detection and frequency above 1GHz.
5. The resolution bandwidth of test receiver/spectrum analyzer is 1 MHz and the video bandwidth $\leq 1/T$ for Average detection (AV) at frequency above 1GHz.

TEST RESULTS

No non-compliance noted

Report No.: TMTN2312001596NR

8.8.2 WORST-CASE RADIATED EMISSION BELOW 1 GHz

BELOW 1 GHz (9kHz ~ 30MHz)

No emission found between lowest internal used/generated frequency to 30MHz.

BELOW 1 GHz (30MHz ~ 1GHz)

Test Voltage: AC 120V, 60Hz

| | | | |
|---------------------|------------------------------|----------------------------|-------------|
| Product Name | AUTOMATIC WIRELESS TURNTABLE | Test Date | 2023/12/28 |
| Model Name | AT-LP70XBT | Test By | Peter Chu |
| Test Mode | TX | Temp & Humidity | 22.3°C, 49% |

Vertical

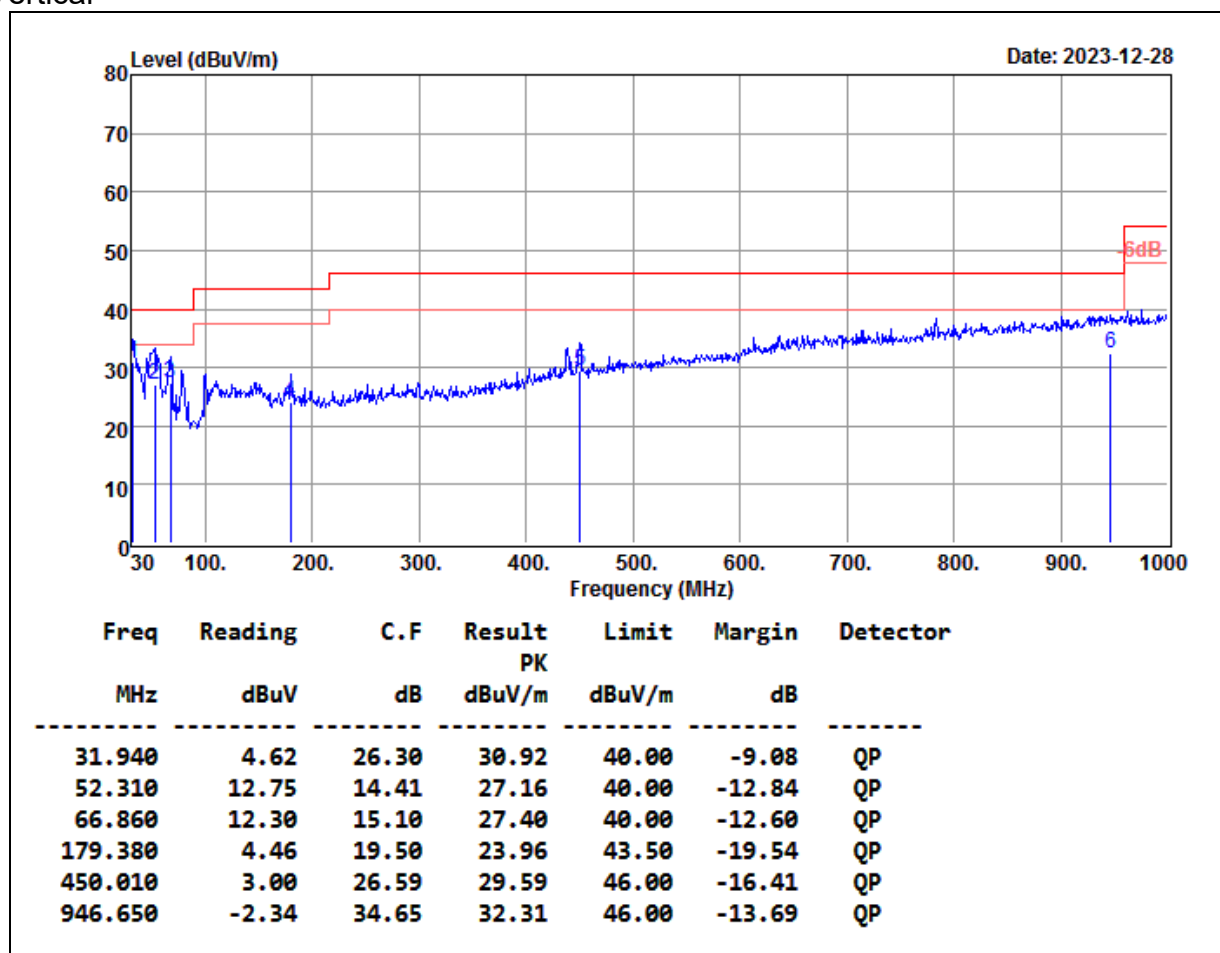

REMARK:

1. Test receiver setting QP(Qusai Peak): RBW=120kHz
2. C.F=Antenna Factor+Cable Loss
3. The result basic equation calculation is as follow: Result = Reading + C.F, Margin = Result-Limit
4. The other emission levels were 10dB below the limit
5. The test distance is 3m.

Report No.: TMTN2312001596NR

| | | | |
|---------------------|------------------------------|----------------------------|-------------|
| Product Name | AUTOMATIC WIRELESS TURNTABLE | Test Date | 2023/12/28 |
| Model Name | AT-LP70XBT | Test By | Peter Chu |
| Test Mode | TX | Temp & Humidity | 22.3°C, 49% |

Horizontal

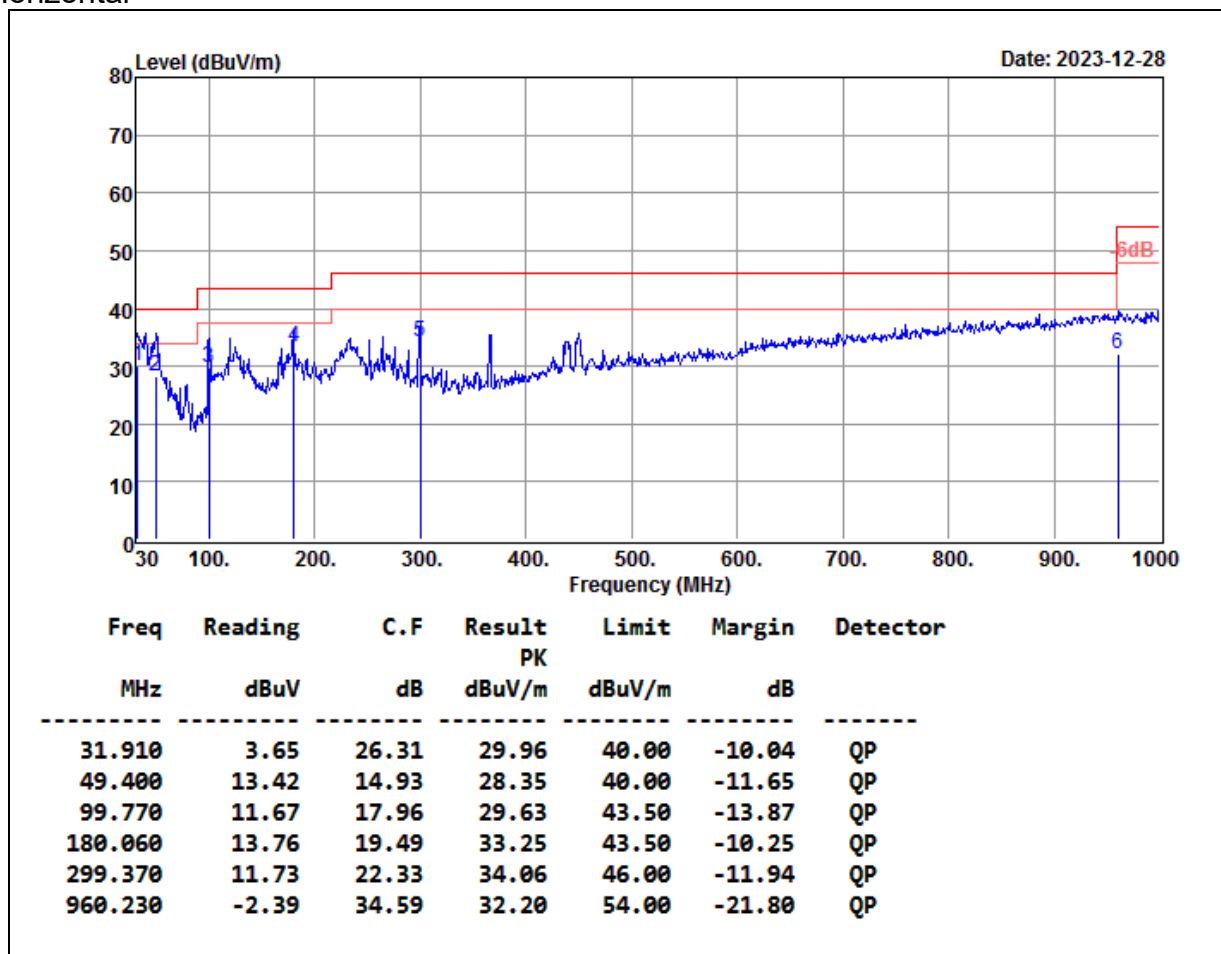

REMARK:

1. Test receiver setting QP(Qusai Peak): RBW=120kHz
2. C.F=Antenna Factor+Cable Loss
3. The result basic equation calculation is as follow: Result = Reading + C.F, Margin = Result-Limit
4. The other emission levels were 10dB below the limit
5. The test distance is 3m.

8.8.3 TRANSMITTER RADIATED EMISSION ABOVE 1 GHz

| | | | |
|---------------------|------------------------------|---------------------------|-------------|
| Product Name | AUTOMATIC WIRELESS TURNTABLE | Test Date | 2023/12/27 |
| Model | AT-LP70XBT | Test By | Peter Chu |
| Test Mode | CH Low TX / GFSK | TEMP& Humidity | 21.8°C, 47% |

Vertical

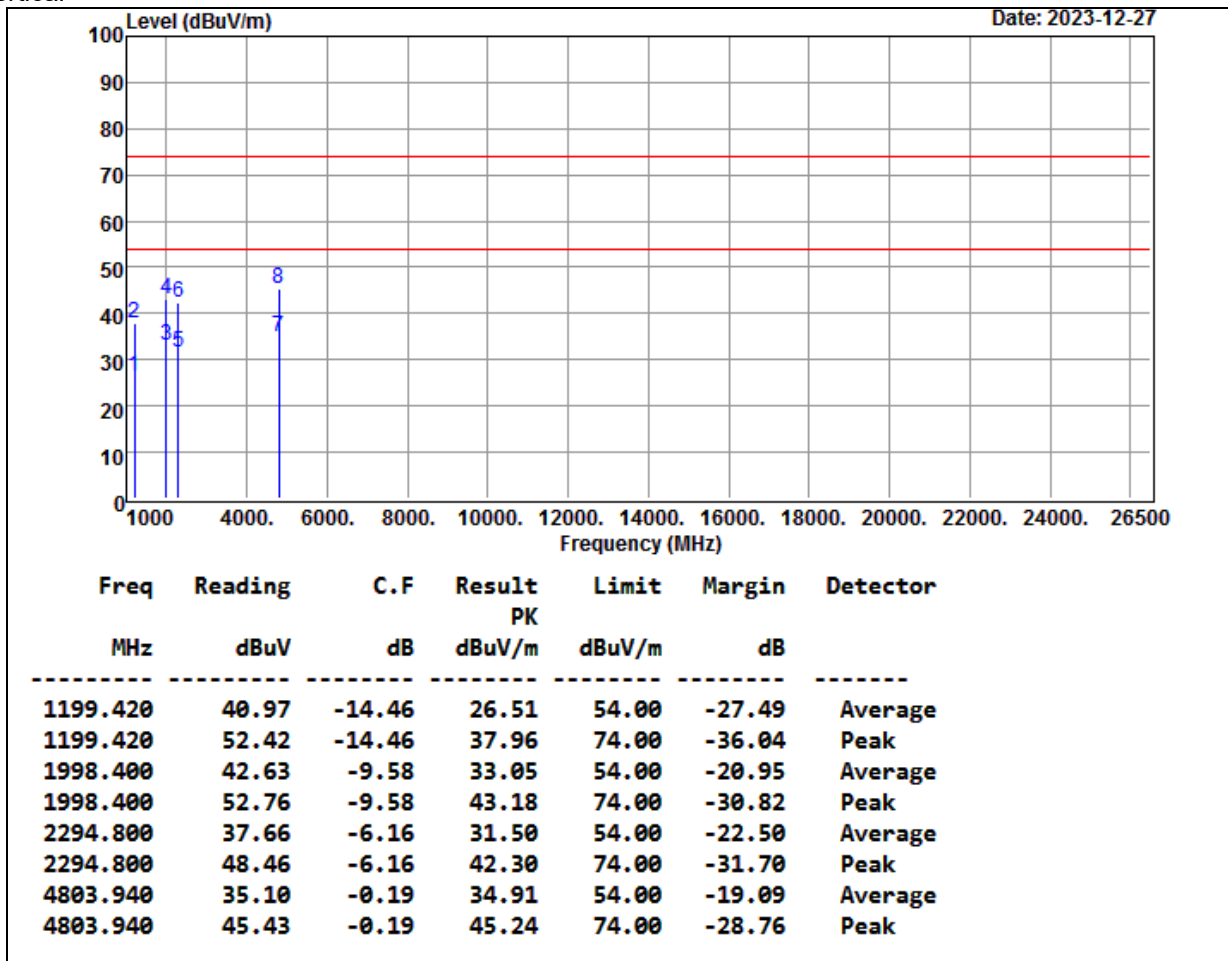

REMARK:

1. Spectrum analyzer setting Peak: RBW=1MHz, VBW=3MHz, Average: RBW=1MHz, VBW ≥ 1/T
2. C.F=Antenna Factor+Cable Loss-Preamplifier gain+2.4GHz~2.5GHz Filter Insertion Loss
3. The result basic equation calculation is as follow: Result = Reading + C.F, Margin = Result-Limit
4. The other emission levels were 10dB below the limit
5. The test distance is 3m.

Report No.: TMTN2312001596NR

| | | | |
|---------------------|------------------------------|---------------------------|-------------|
| Product Name | AUTOMATIC WIRELESS TURNTABLE | Test Date | 2023/12/27 |
| Model | AT-LP70XBT | Test By | Peter Chu |
| Test Mode | CH Low TX / GFSK | TEMP& Humidity | 21.8°C, 47% |

Horizontal

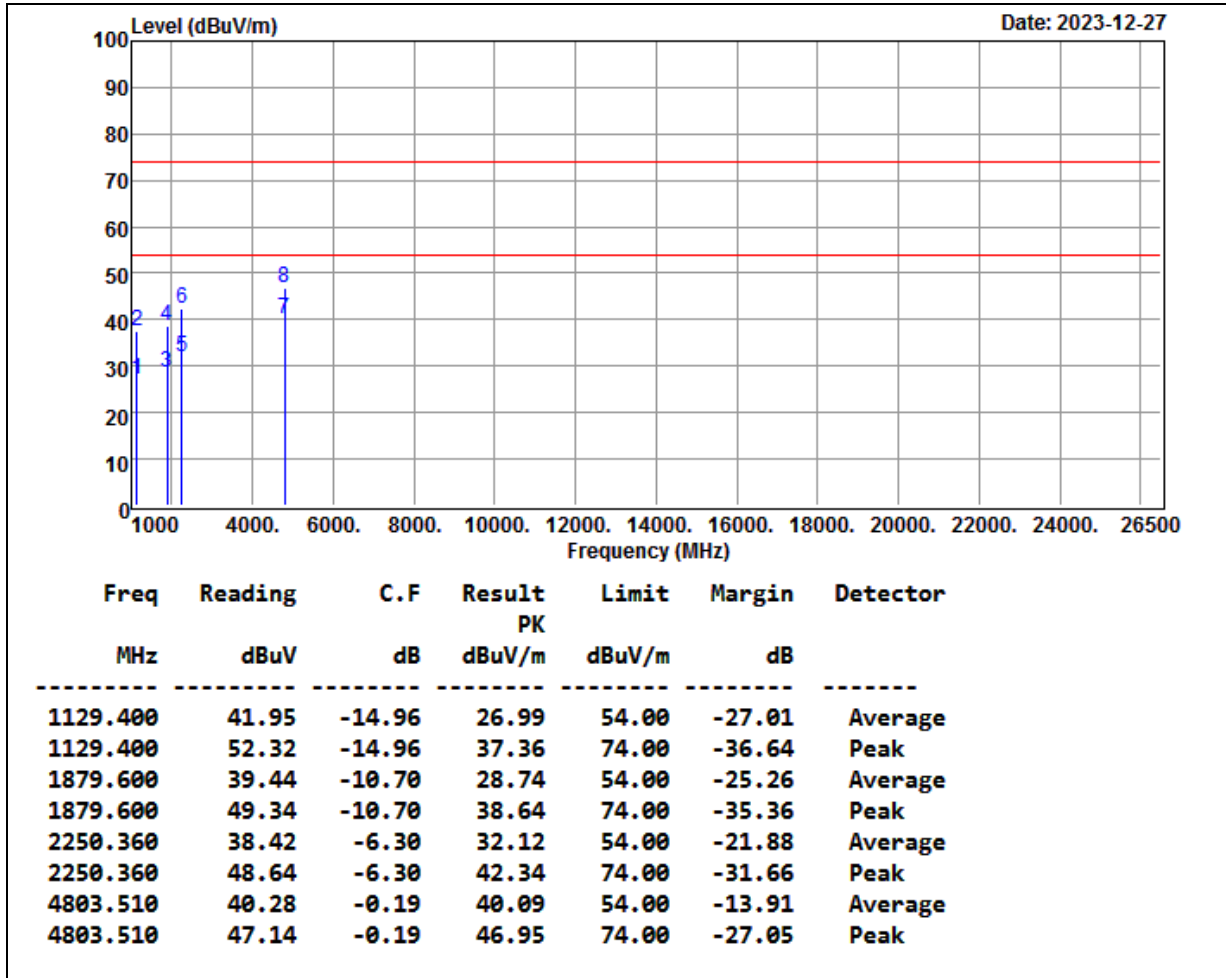

REMARK:

1. Spectrum analyzer setting Peak: RBW=1MHz, VBW=3MHz, Average: RBW=1MHz, VBW ≥ 1/T
2. C.F=Antenna Factor+Cable Loss-Preamplifier gain+2.4GHz~2.5GHz Filter Insertion Loss
3. The result basic equation calculation is as follow: Result = Reading + C.F, Margin = Result-Limit
4. The other emission levels were 10dB below the limit
5. The test distance is 3m.

Report No.: TMTN2312001596NR

| | | | |
|---------------------|------------------------------|---------------------------|-------------|
| Product Name | AUTOMATIC WIRELESS TURNTABLE | Test Date | 2023/12/27 |
| Model | AT-LP70XBT | Test By | Peter Chu |
| Test Mode | CH Mid TX / GFSK | TEMP& Humidity | 21.8°C, 47% |

Vertical

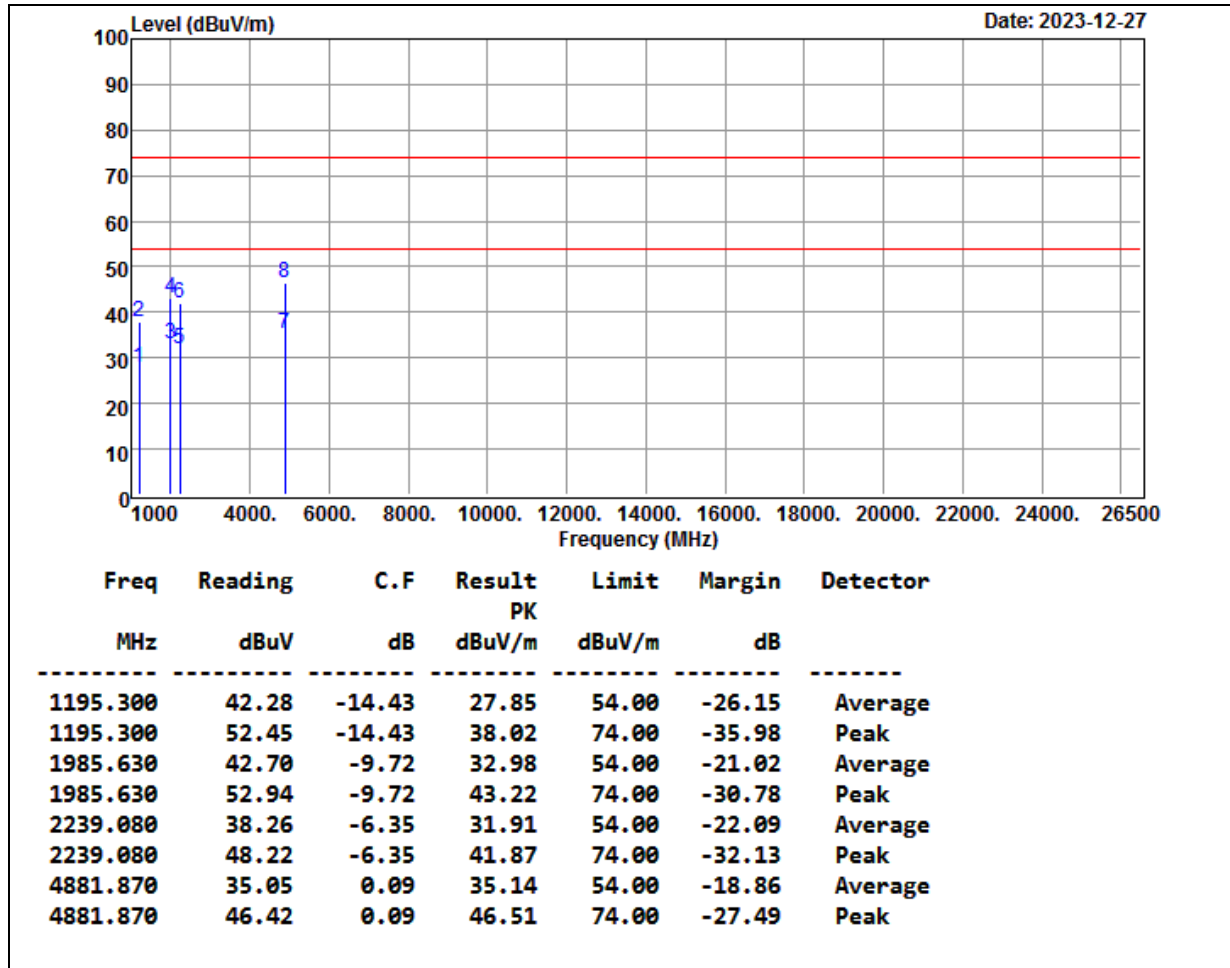

REMARK:

1. Spectrum analyzer setting Peak: RBW=1MHz, VBW=3MHz, Average: RBW=1MHz, VBW ≥ 1/T
2. C.F=Antenna Factor+Cable Loss-Preamplifier gain+2.4GHz~2.5GHz Filter Insertion Loss
3. The result basic equation calculation is as follow: Result = Reading + C.F, Margin = Result-Limit
4. The other emission levels were 10dB below the limit
5. The test distance is 3m.

Report No.: TMTN2312001596NR

| | | | |
|---------------------|------------------------------|---------------------------|-------------|
| Product Name | AUTOMATIC WIRELESS TURNTABLE | Test Date | 2023/12/27 |
| Model | AT-LP70XBT | Test By | Peter Chu |
| Test Mode | CH Mid TX / GFSK | TEMP& Humidity | 21.8°C, 47% |

Horizontal

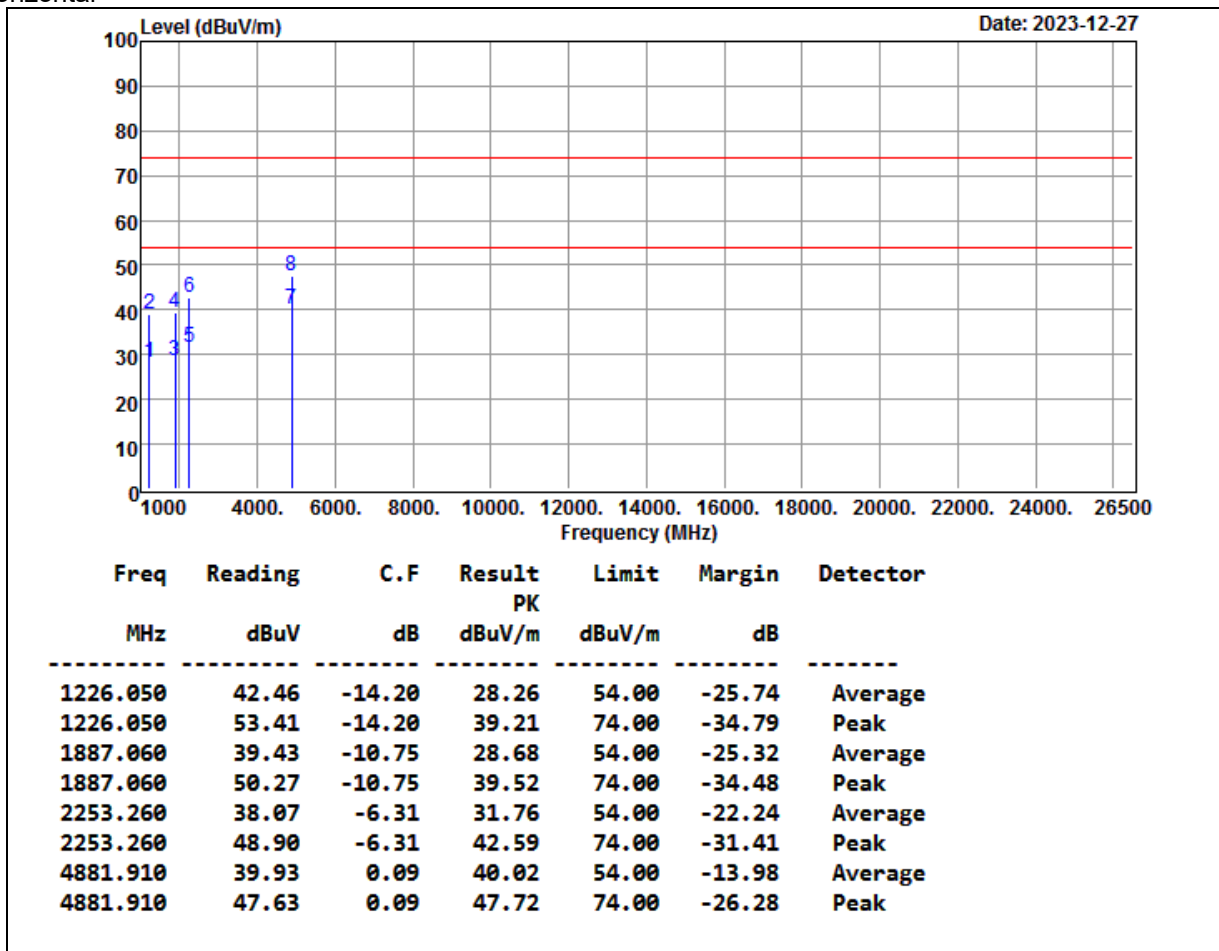

REMARK:

- 1.Spectrum analyzer setting Peak: RBW=1MHz, VBW=3MHz,Average: RBW=1MHz, VBW ≥ 1/T
- 2.C.F=Antenna Factor+Cable Loss-Preamplifier gain+2.4GHz~2.5GHz Filter Insertion Loss
- 3.The result basic equation calculation is as follow:Result = Reading + C.F, Margin = Result-Limit
- 4.The other emission levels were 10dB below the limit
- 5.The test distance is 3m.

| | | | |
|---------------------|------------------------------|---------------------------|-------------|
| Product Name | AUTOMATIC WIRELESS TURNTABLE | Test Date | 2023/12/27 |
| Model | AT-LP70XBT | Test By | Peter Chu |
| Test Mode | CH High TX / GFSK | TEMP& Humidity | 21.8°C, 47% |

Vertical

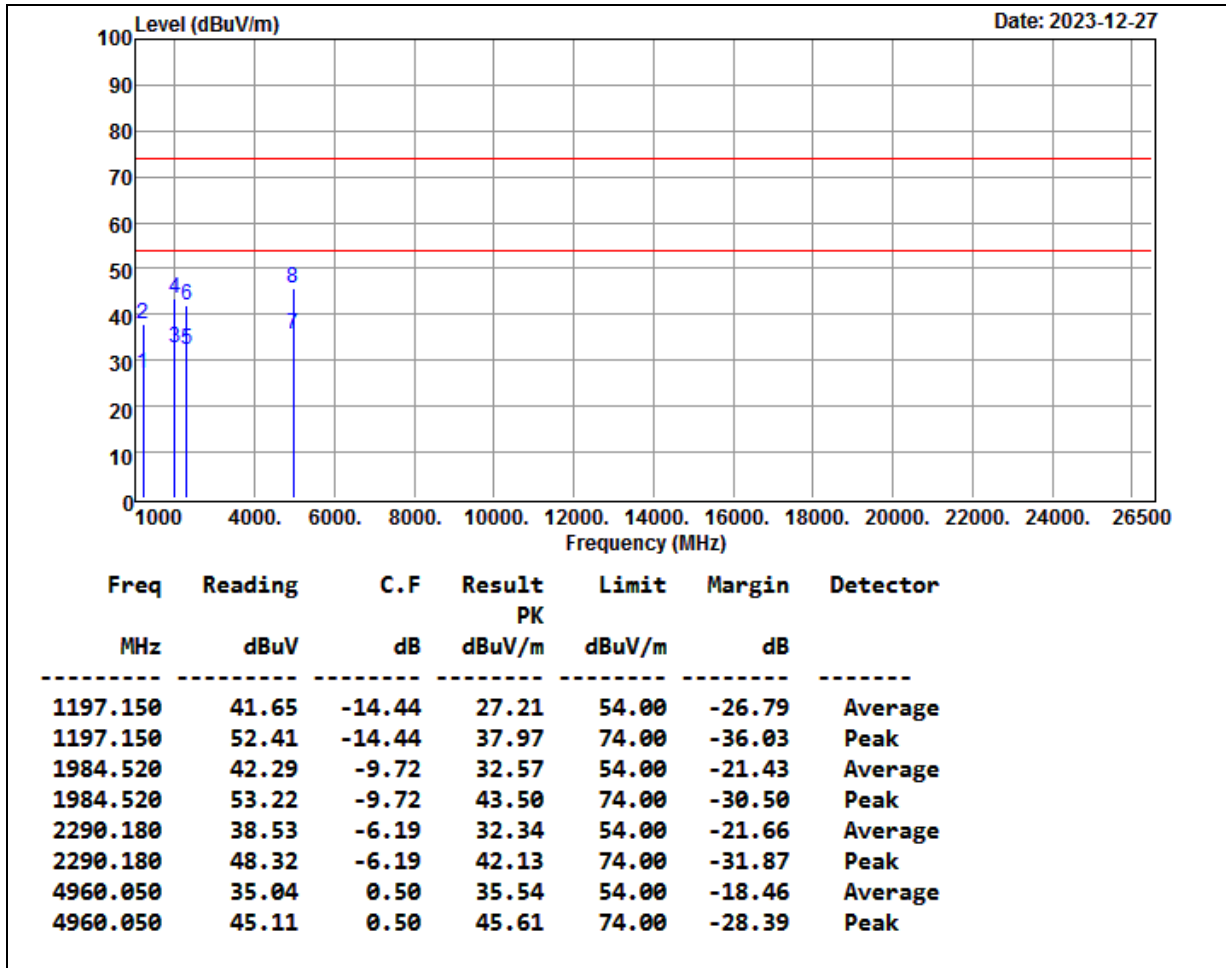

REMARK:

1. Spectrum analyzer setting Peak: RBW=1MHz, VBW=3MHz, Average: RBW=1MHz, VBW ≥ 1/T
2. C.F=Antenna Factor+Cable Loss-Preamplifier gain+2.4GHz~2.5GHz Filter Insertion Loss
3. The result basic equation calculation is as follow: Result = Reading + C.F, Margin = Result-Limit
4. The other emission levels were 10dB below the limit
5. The test distance is 3m.

Report No.: TMTN2312001596NR

| | | | |
|---------------------|------------------------------|---------------------------|-------------|
| Product Name | AUTOMATIC WIRELESS TURNTABLE | Test Date | 2023/12/27 |
| Model | AT-LP70XBT | Test By | Peter Chu |
| Test Mode | CH High TX / GFSK | TEMP& Humidity | 21.8°C, 47% |

Horizontal

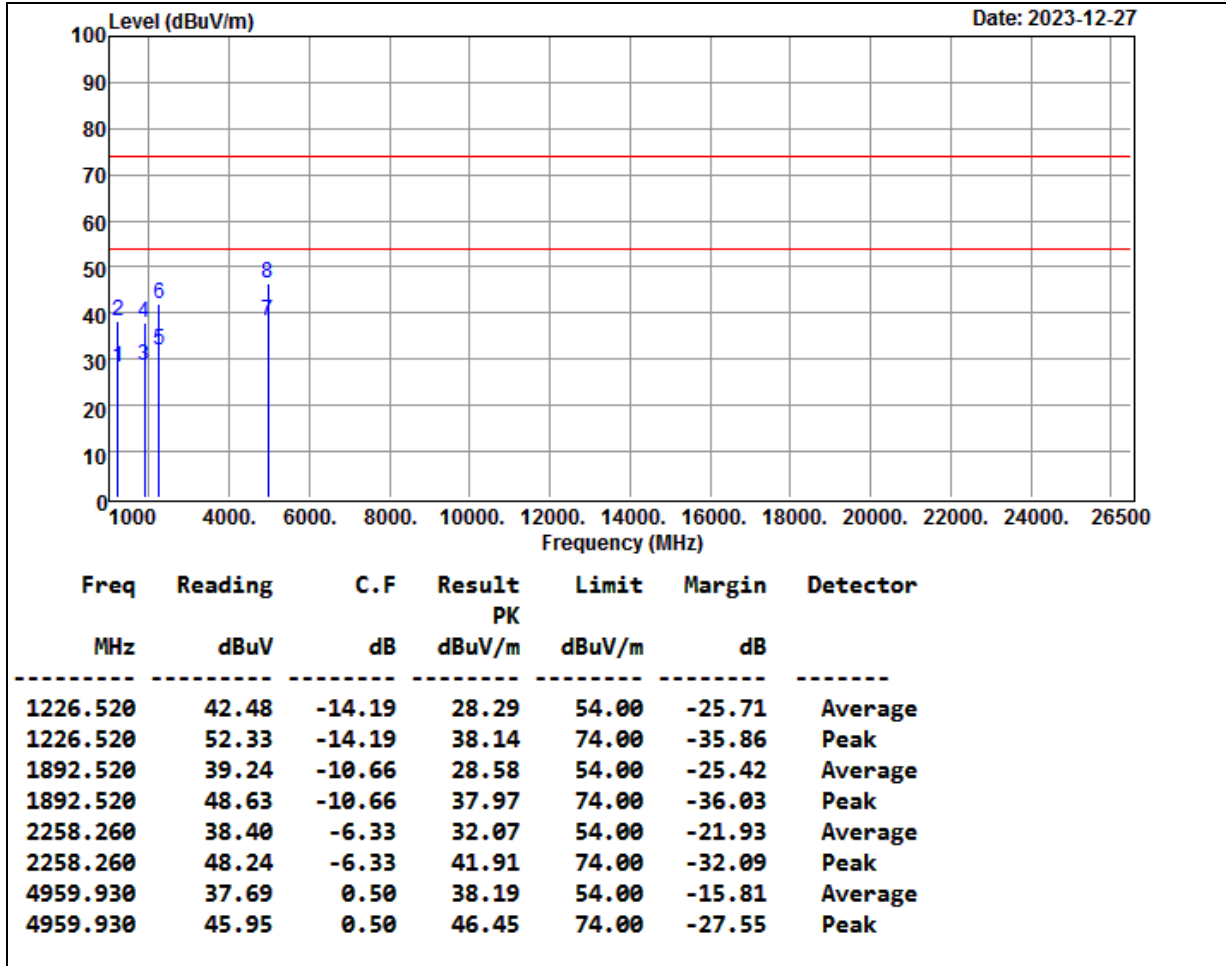

REMARK:

1. Spectrum analyzer setting Peak: RBW=1MHz, VBW=3MHz, Average: RBW=1MHz, VBW ≥ 1/T
2. C.F=Antenna Factor+Cable Loss-Preamplifier gain+2.4GHz~2.5GHz Filter Insertion Loss
3. The result basic equation calculation is as follow: Result = Reading + C.F, Margin = Result-Limit
4. The other emission levels were 10dB below the limit
5. The test distance is 3m.

Report No.: TMTN2312001596NR

| | | | |
|---------------------|------------------------------|---------------------------|-------------|
| Product Name | AUTOMATIC WIRELESS TURNTABLE | Test Date | 2023/12/27 |
| Model | AT-LP70XBT | Test By | Peter Chu |
| Test Mode | CH Low TX / 8-DPSK | TEMP& Humidity | 21.8°C, 47% |

Vertical

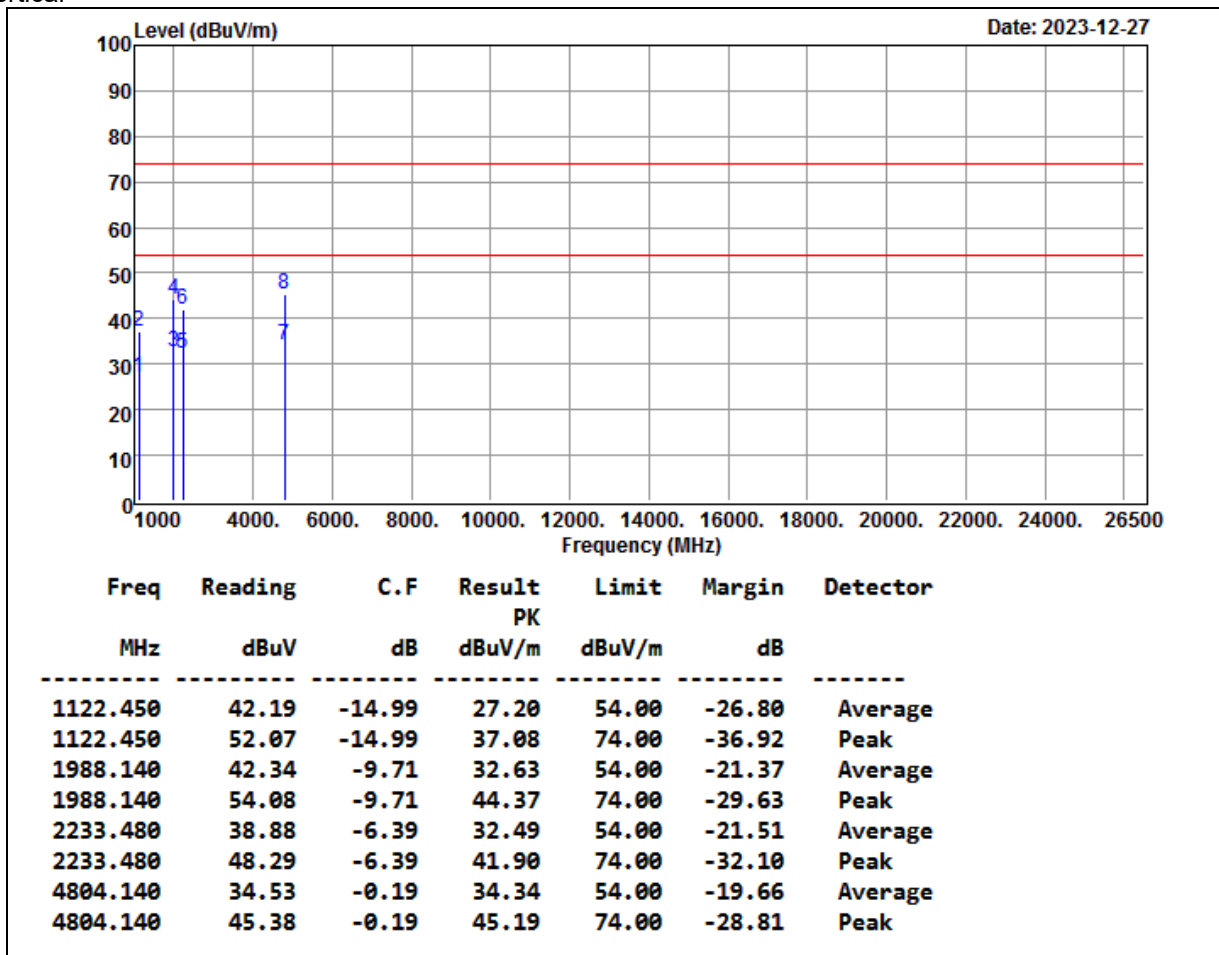

REMARK:

1. Spectrum analyzer setting Peak: RBW=1MHz, VBW=3MHz, Average: RBW=1MHz, VBW ≥ 1/T
2. C.F=Antenna Factor+Cable Loss-Preamplifier gain+2.4GHz~2.5GHz Filter Insertion Loss
3. The result basic equation calculation is as follow: Result = Reading + C.F, Margin = Result-Limit
4. The other emission levels were 10dB below the limit
5. The test distance is 3m.

Report No.: TMTN2312001596NR

| | | | |
|---------------------|------------------------------|---------------------------|-------------|
| Product Name | AUTOMATIC WIRELESS TURNTABLE | Test Date | 2023/12/27 |
| Model | AT-LP70XBT | Test By | Peter Chu |
| Test Mode | CH Low TX / 8-DPSK | TEMP& Humidity | 21.8°C, 47% |

Horizontal

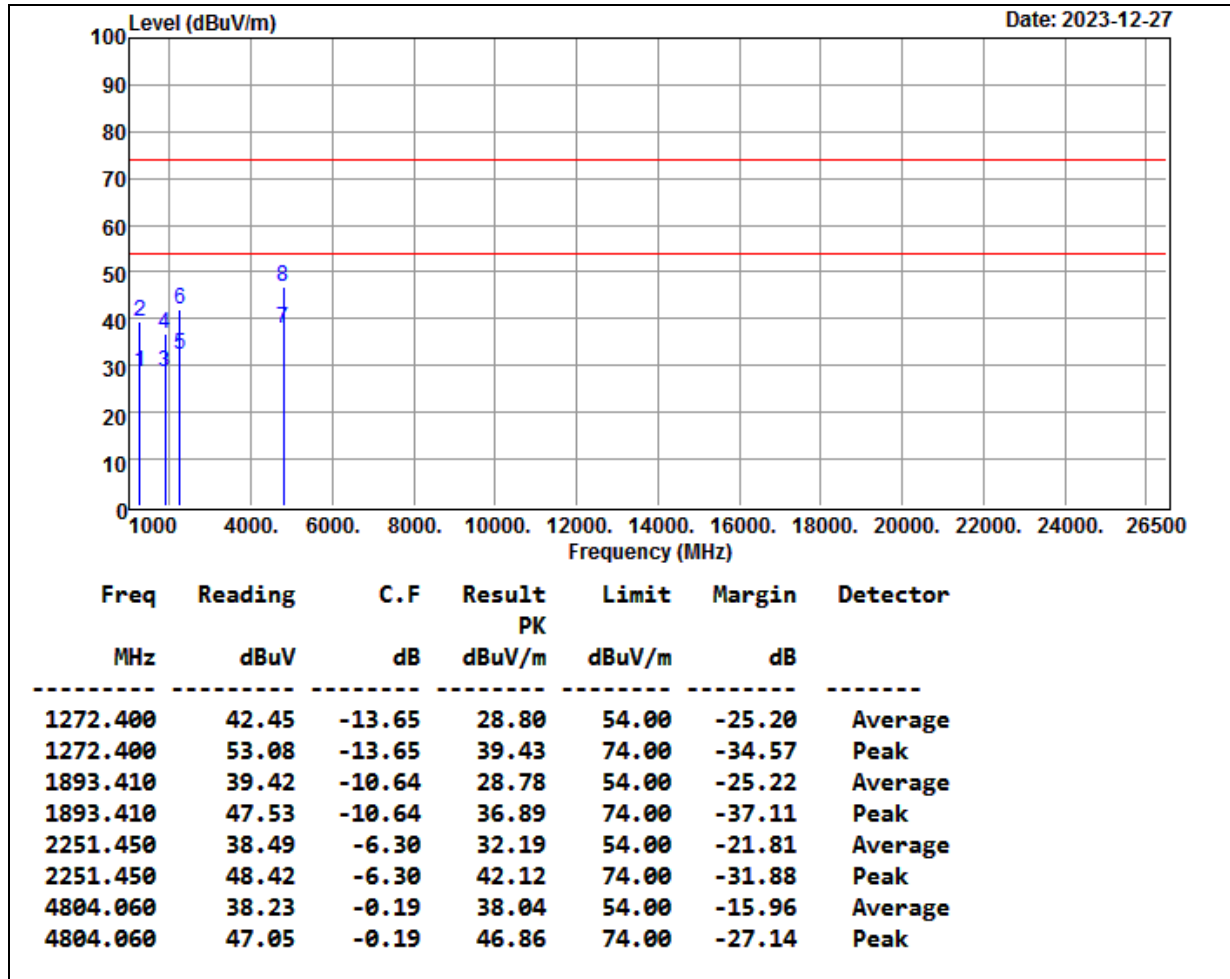

REMARK:

1. Spectrum analyzer setting Peak: RBW=1MHz, VBW=3MHz, Average: RBW=1MHz, VBW ≥ 1/T
2. C.F=Antenna Factor+Cable Loss-Preamplifier gain+2.4GHz~2.5GHz Filter Insertion Loss
3. The result basic equation calculation is as follow: Result = Reading + C.F, Margin = Result-Limit
4. The other emission levels were 10dB below the limit
5. The test distance is 3m.

Report No.: TMTN2312001596NR

| | | | |
|---------------------|------------------------------|---------------------------|-------------|
| Product Name | AUTOMATIC WIRELESS TURNTABLE | Test Date | 2023/12/27 |
| Model | AT-LP70XBT | Test By | Peter Chu |
| Test Mode | CH Mid TX / 8-DPSK | TEMP& Humidity | 21.8°C, 47% |

Vertical

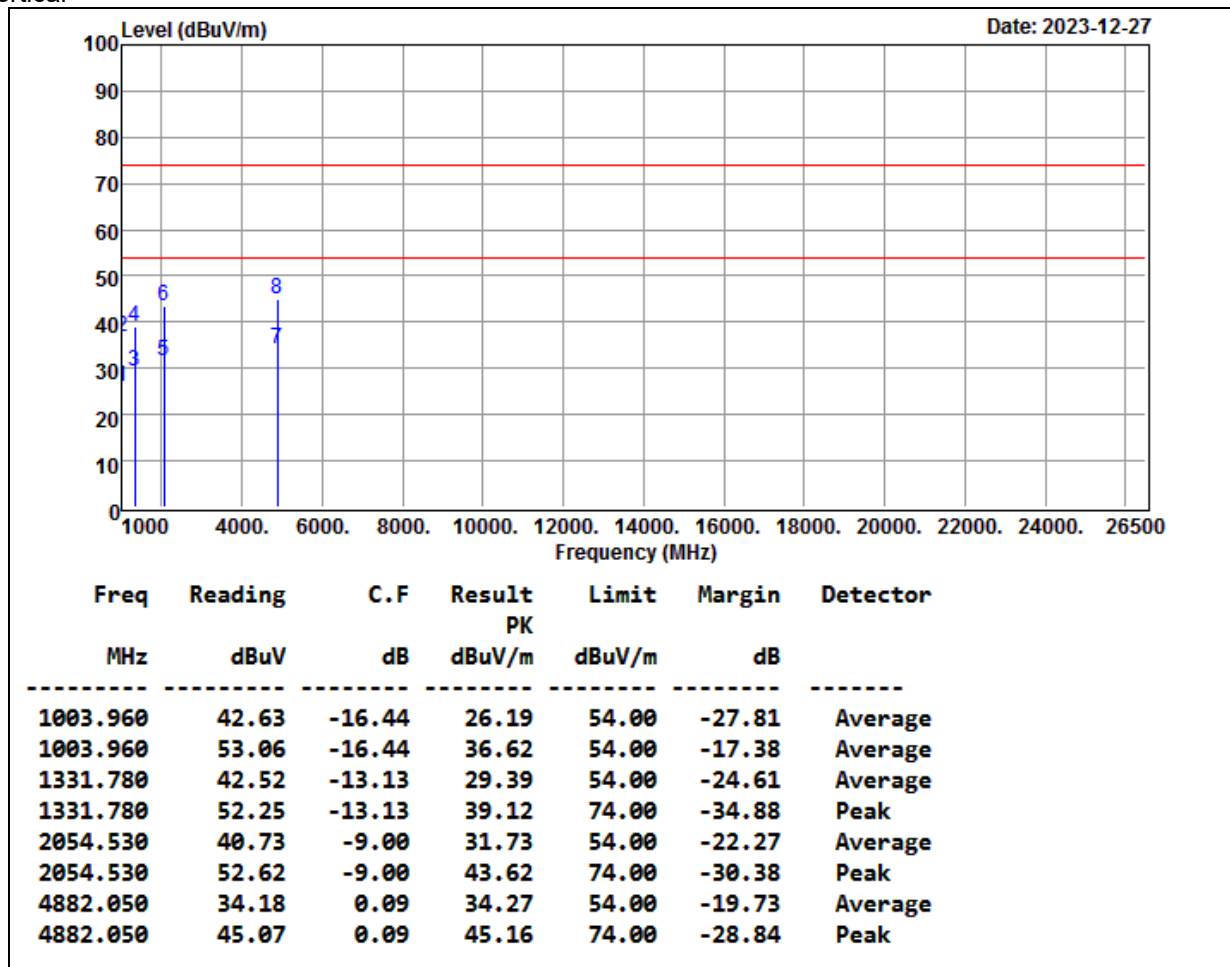

REMARK:

1. Spectrum analyzer setting Peak: RBW=1MHz, VBW=3MHz, Average: RBW=1MHz, VBW ≥ 1/T
2. C.F=Antenna Factor+Cable Loss-Preamplifier gain+2.4GHz~2.5GHz Filter Insertion Loss
3. The result basic equation calculation is as follow: Result = Reading + C.F, Margin = Result-Limit
4. The other emission levels were 10dB below the limit
5. The test distance is 3m.

Report No.: TMTN2312001596NR

| | | | |
|---------------------|------------------------------|---------------------------|-------------|
| Product Name | AUTOMATIC WIRELESS TURNTABLE | Test Date | 2023/12/27 |
| Model | AT-LP70XBT | Test By | Peter Chu |
| Test Mode | CH Mid TX / 8-DPSK | TEMP& Humidity | 21.8°C, 47% |

Horizontal

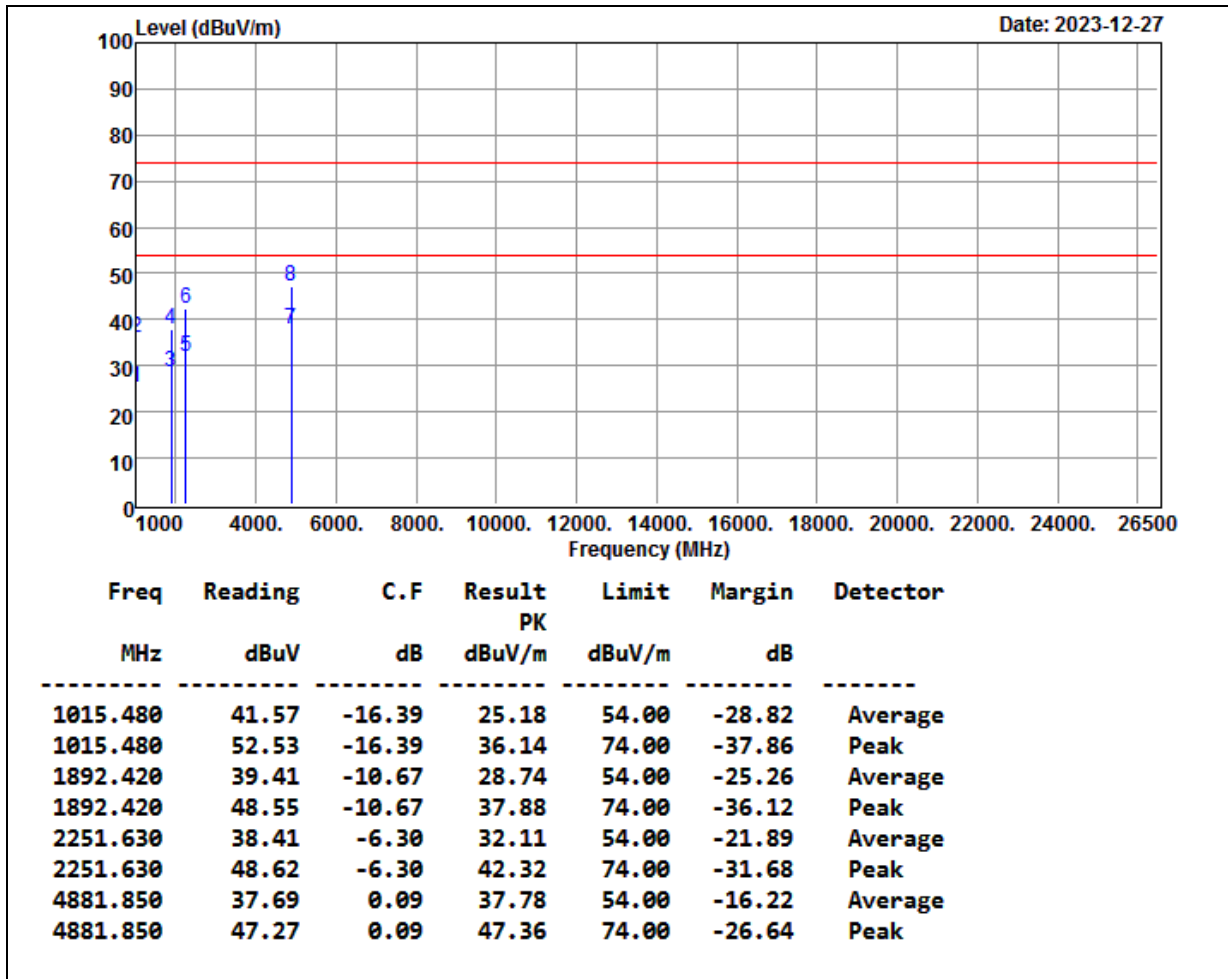

REMARK:

1. Spectrum analyzer setting Peak: RBW=1MHz, VBW=3MHz, Average: RBW=1MHz, VBW ≥ 1/T
2. C.F=Antenna Factor+Cable Loss-Preamplifier gain+2.4GHz~2.5GHz Filter Insertion Loss
3. The result basic equation calculation is as follow: Result = Reading + C.F, Margin = Result-Limit
4. The other emission levels were 10dB below the limit
5. The test distance is 3m.

Report No.: TMTN2312001596NR

| | | | |
|---------------------|------------------------------|---------------------------|-------------|
| Product Name | AUTOMATIC WIRELESS TURNTABLE | Test Date | 2023/12/27 |
| Model | AT-LP70XBT | Test By | Peter Chu |
| Test Mode | CH High TX / 8-DPSK | TEMP& Humidity | 21.8°C, 47% |

Vertical

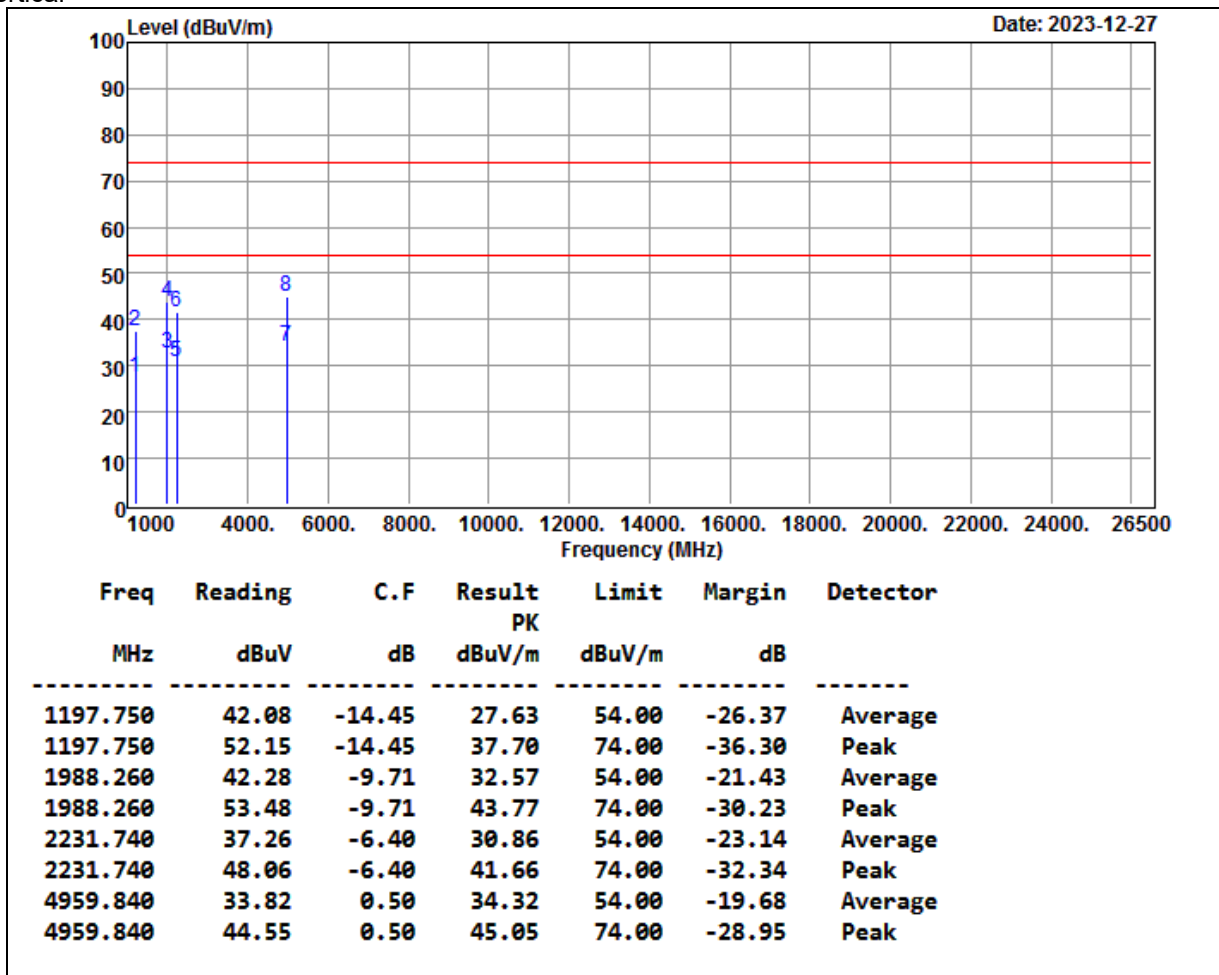

REMARK:

1. Spectrum analyzer setting Peak: RBW=1MHz, VBW=3MHz, Average: RBW=1MHz, VBW ≥ 1/T
2. C.F=Antenna Factor+Cable Loss-Preamplifier gain+2.4GHz~2.5GHz Filter Insertion Loss
3. The result basic equation calculation is as follow: Result = Reading + C.F, Margin = Result-Limit
4. The other emission levels were 10dB below the limit
5. The test distance is 3m.

Report No.: TMTN2312001596NR

| | | | |
|---------------------|------------------------------|---------------------------|-------------|
| Product Name | AUTOMATIC WIRELESS TURNTABLE | Test Date | 2023/12/27 |
| Model | AT-LP70XBT | Test By | Peter Chu |
| Test Mode | CH High TX / 8-DPSK | TEMP& Humidity | 21.8°C, 47% |

Horizontal

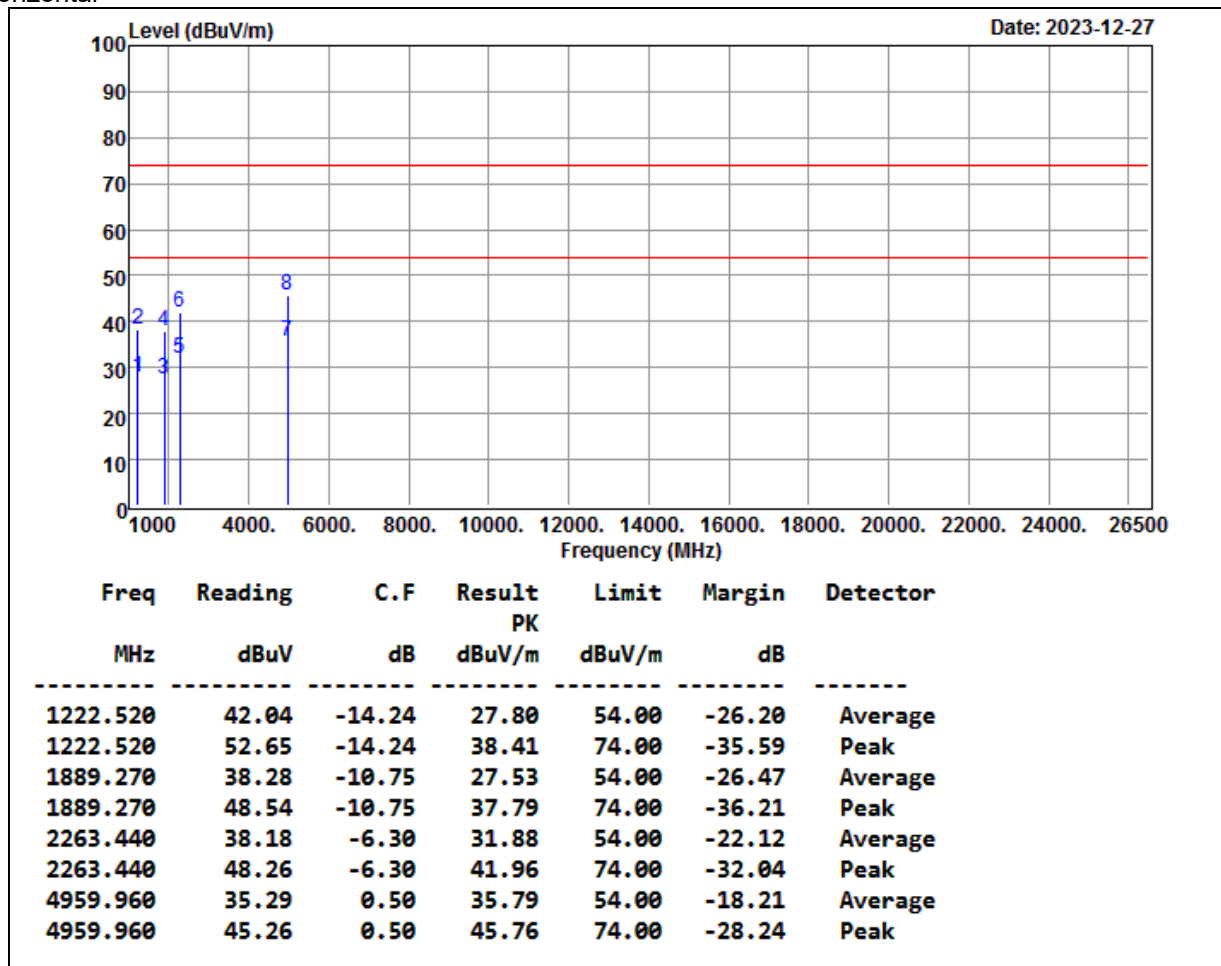

REMARK:

1. Spectrum analyzer setting Peak: RBW=1MHz, VBW=3MHz, Average: RBW=1MHz, VBW ≥ 1/T
2. C.F=Antenna Factor+Cable Loss-Preamplifier gain+2.4GHz~2.5GHz Filter Insertion Loss
3. The result basic equation calculation is as follow: Result = Reading + C.F, Margin = Result-Limit
4. The other emission levels were 10dB below the limit
5. The test distance is 3m.

Report No.: TMTN2312001596NR

8.8.4 RESTRICTED BAND EDGES

| | | | |
|---------------------|------------------------------|---------------------------|-------------|
| Product Name | AUTOMATIC WIRELESS TURNTABLE | Test Date | 2023/12/27 |
| Model | AT-LP70XBT | Test By | Peter Chu |
| Test Mode | CH Low TX / GFSK | TEMP& Humidity | 21.8°C, 47% |

Horizontal

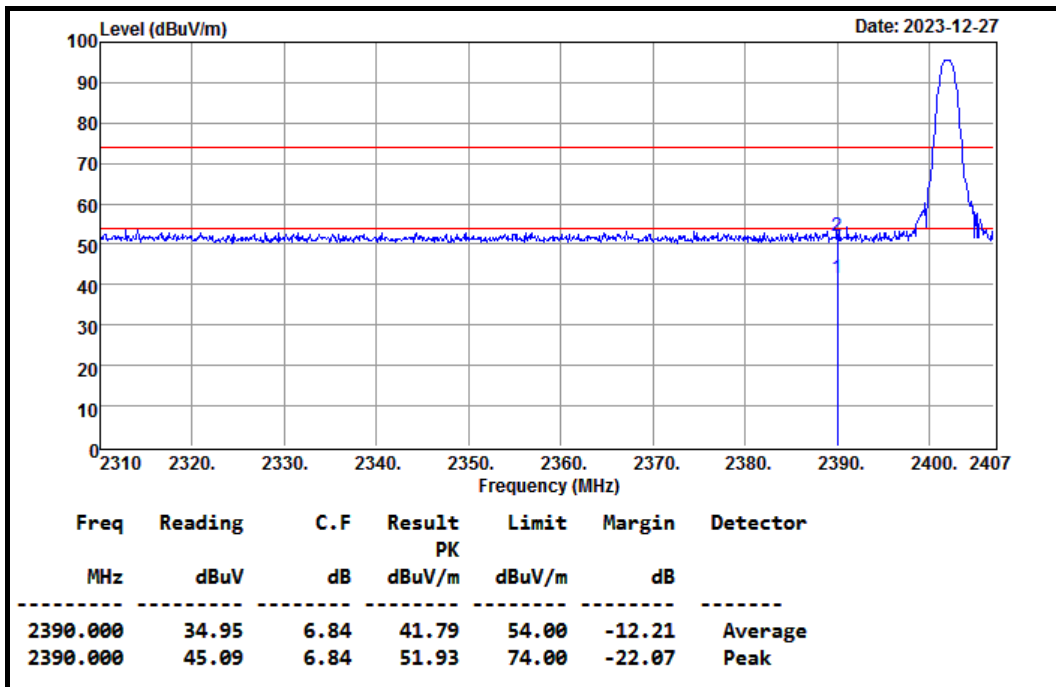

Vertical

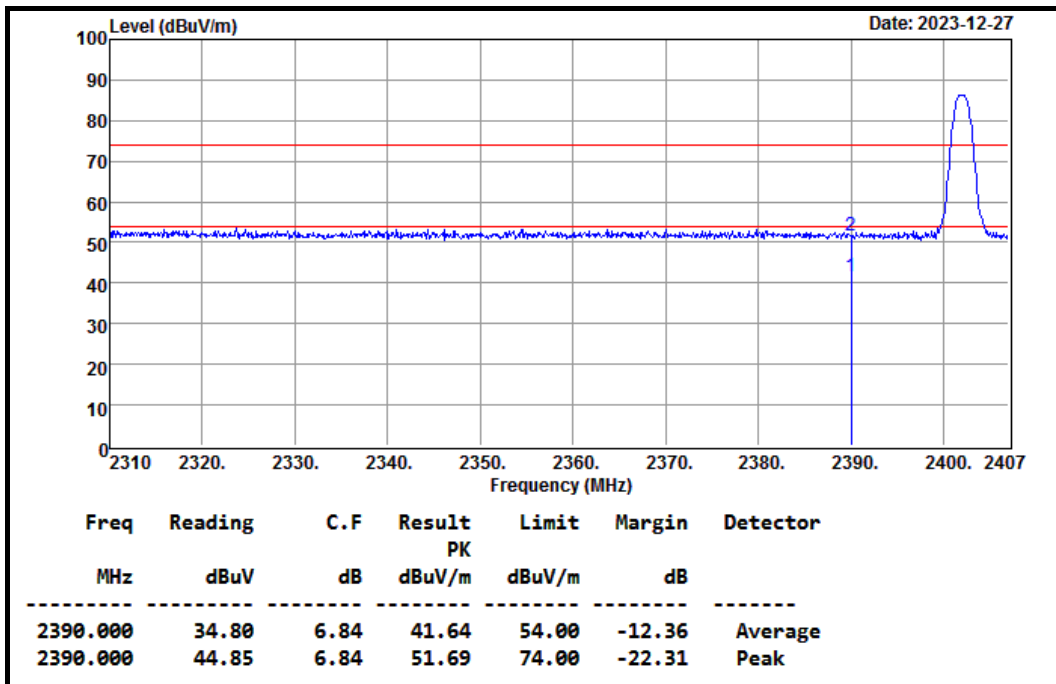

Report No.: TMTN2312001596NR

| | | | |
|---------------------|------------------------------|---------------------------|-------------|
| Product Name | AUTOMATIC WIRELESS TURNTABLE | Test Date | 2023/12/27 |
| Model | AT-LP70XBT | Test By | Peter Chu |
| Test Mode | CH High TX / GFSK | TEMP& Humidity | 21.8°C, 47% |

Horizontal

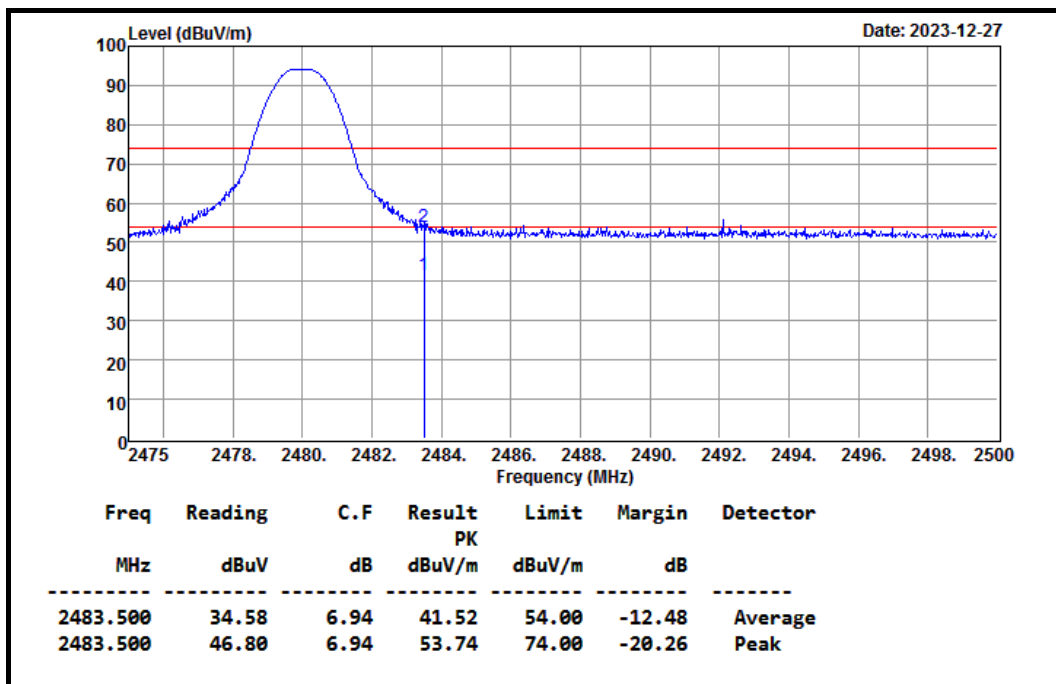

Vertical

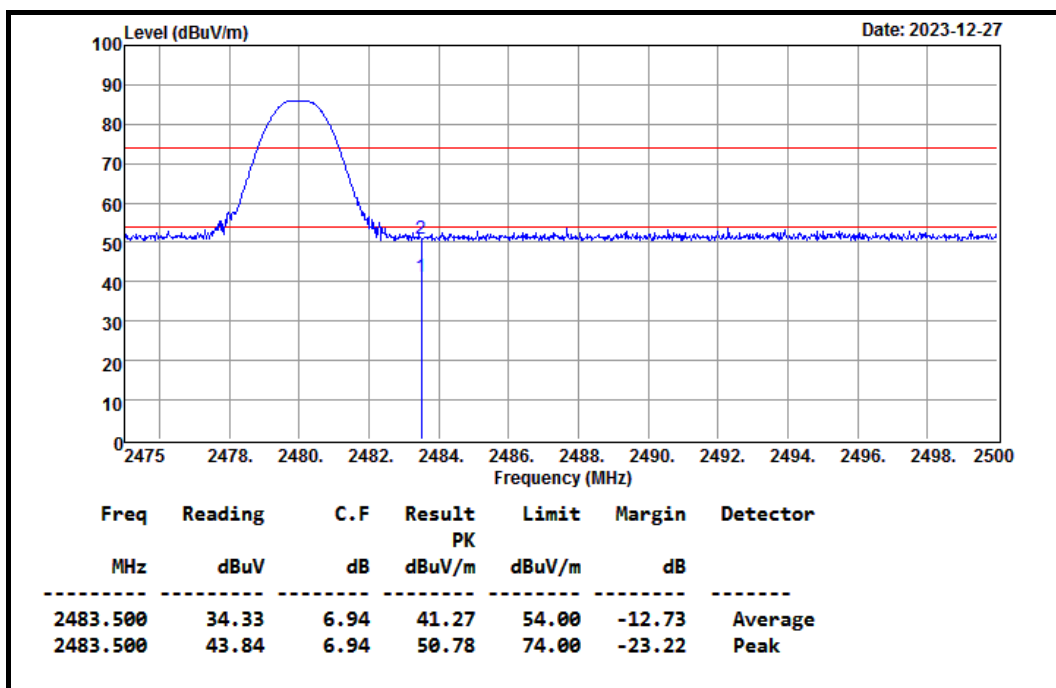

Report No.: TMTN2312001596NR

| | | | |
|---------------------|------------------------------|---------------------------|-------------|
| Product Name | AUTOMATIC WIRELESS TURNTABLE | Test Date | 2023/12/27 |
| Model | AT-LP70XBT | Test By | Peter Chu |
| Test Mode | CH Low TX / 8-DPSK | TEMP& Humidity | 21.8°C, 47% |

Horizontal

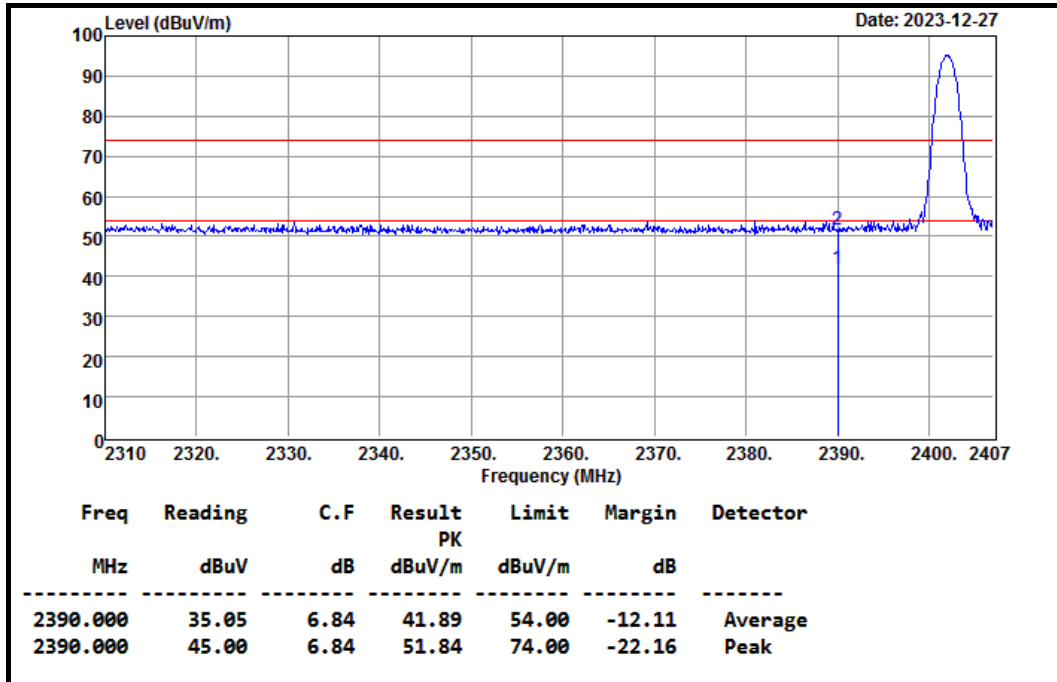

Vertical

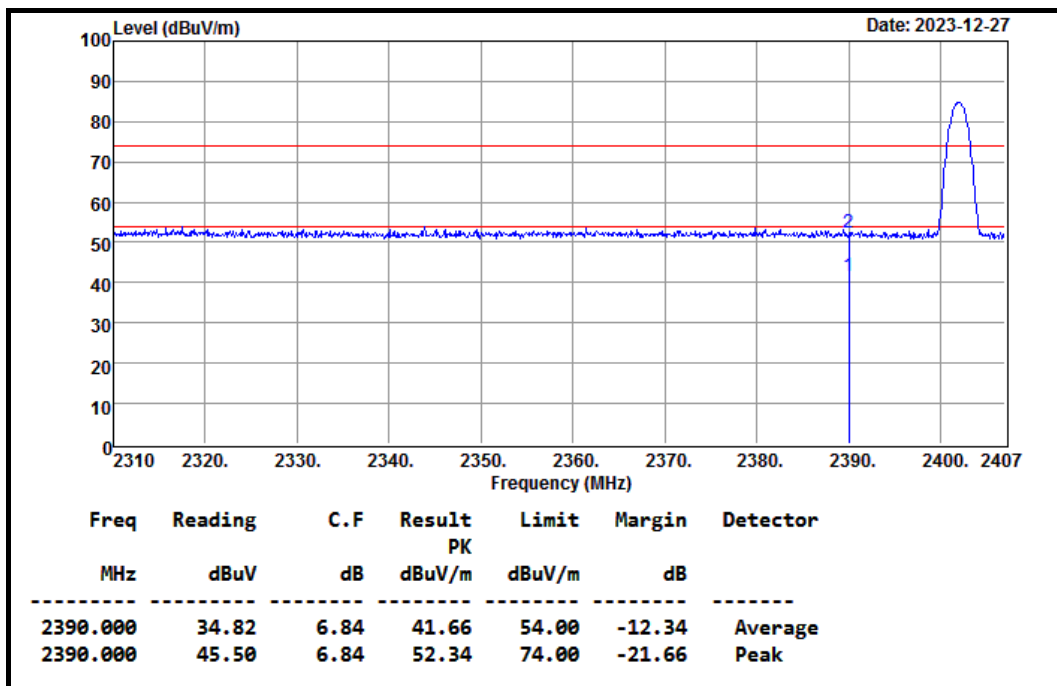

Report No.: TMTN2312001596NR

| | | | |
|---------------------|------------------------------|---------------------------|-------------|
| Product Name | AUTOMATIC WIRELESS TURNTABLE | Test Date | 2023/12/27 |
| Model | AT-LP70XBT | Test By | Peter Chu |
| Test Mode | CH High TX / 8-DPSK | TEMP& Humidity | 21.8°C, 47% |

Horizontal

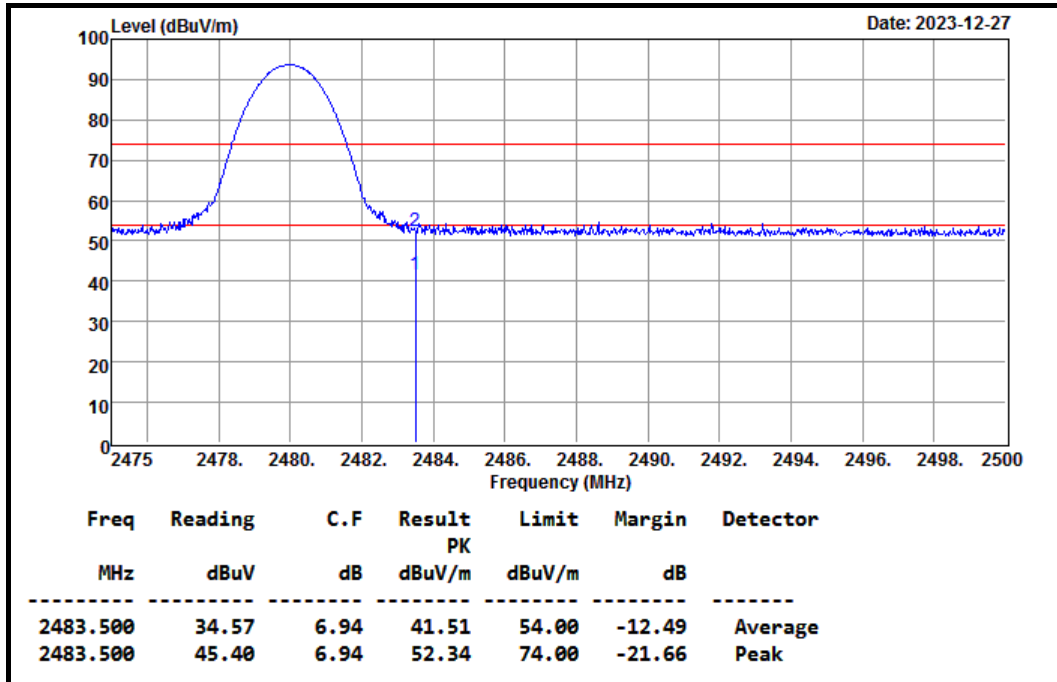

Vertical

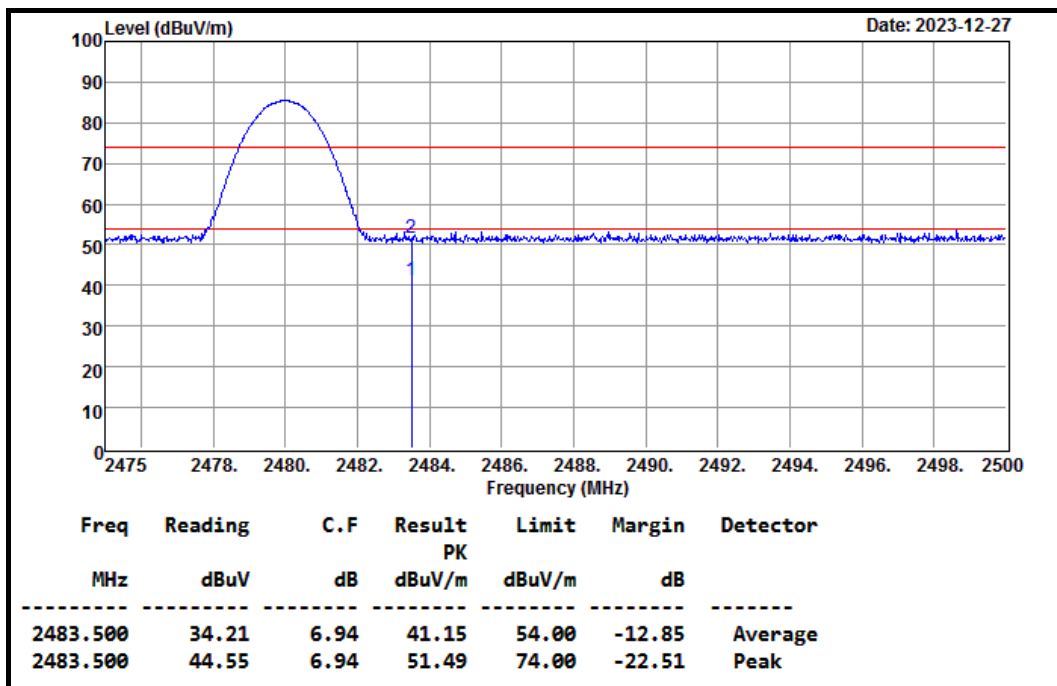

8.9 POWERLINE CONDUCTED EMISSIONS

LIMITS

§ 15.207 (a) Except as shown in paragraph (b) and (c) this section, for an intentional radiator that is designed to be connected to the public utility (AC) power line, the radio frequency voltage that is conducted back onto the AC power line on any frequency or frequencies within the band 150 kHz to 30 MHz shall not exceed the limits in the following table, as measured using a 50 μ H/50 ohms line impedance stabilization network (LISN). Compliance with the provisions of this paragraph shall be based on the measurement of the radio frequency voltage between each power line and ground at the power terminal.

The lower limit applies at the boundary between the frequency ranges.

| Frequency of Emission (MHz) | Conducted limit (dB μ v) | |
|-----------------------------|------------------------------|----------|
| | Quasi-peak | Average |
| 0.15 - 0.5 | 66 to 56 | 56 to 46 |
| 0.5 - 5 | 56 | 46 |
| 5 - 30 | 60 | 50 |

Report No.: TMTN2312001596NR

TEST SETUP

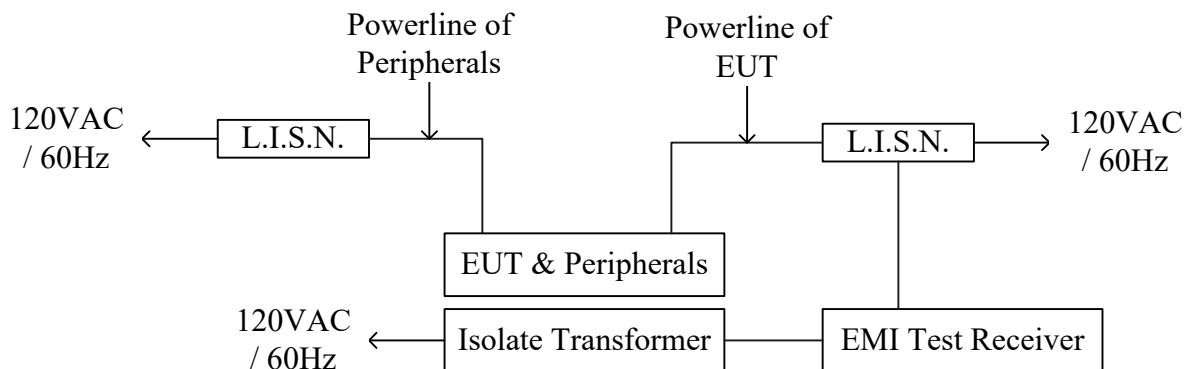
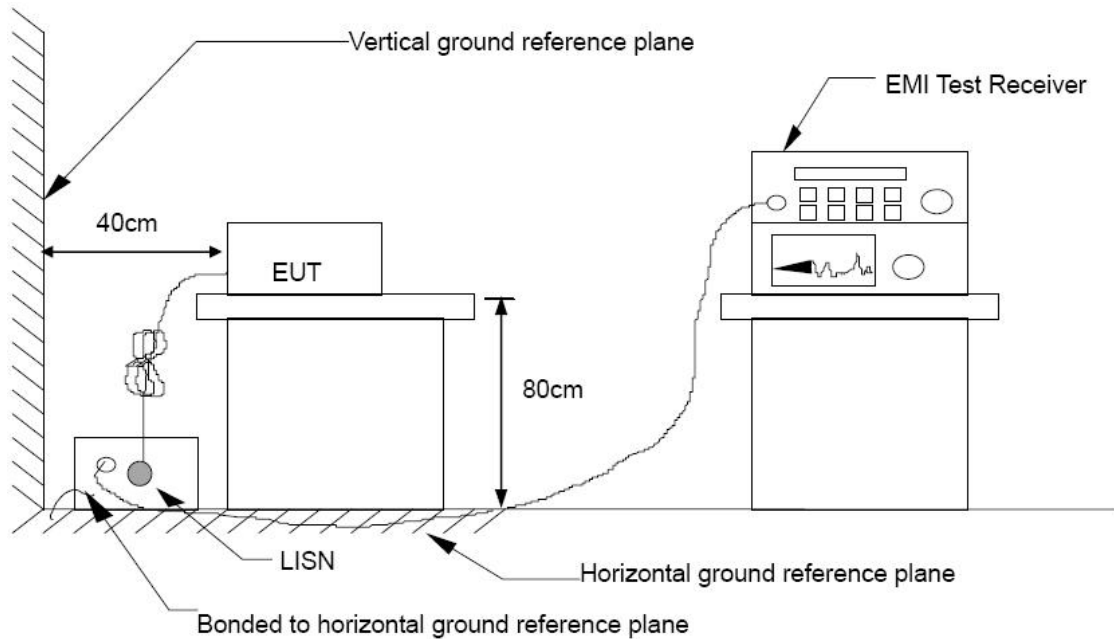

TEST PROCEDURE

The EUT is placed on a non-conducting table 40 cm from the vertical ground plane and 80cm above the horizontal ground plane. The EUT IS CONFIGURED IN ACCORDANCE WITH ANSI C63.10 : 2013.

The resolution bandwidth is set to 9 kHz for both quasi-peak detection and average detection measurements.

Line conducted data is recorded for both NEUTRAL and LINE.

Report No.: TMTN2312001596NR

TEST RESULTS

Test Voltage: AC 120V, 60Hz

| | | | |
|--------------------------|----------------|----------------------|------------------|
| Model No. | AT-LP70XBT | Test Mode | Normal Operation |
| Environmental Conditions | 26.5°C, 44% RH | Resolution Bandwidth | 9 kHz |
| Tested by | Jeremy Zhong | | |

LINE

(The chart below shows the highest readings taken from the final data.)

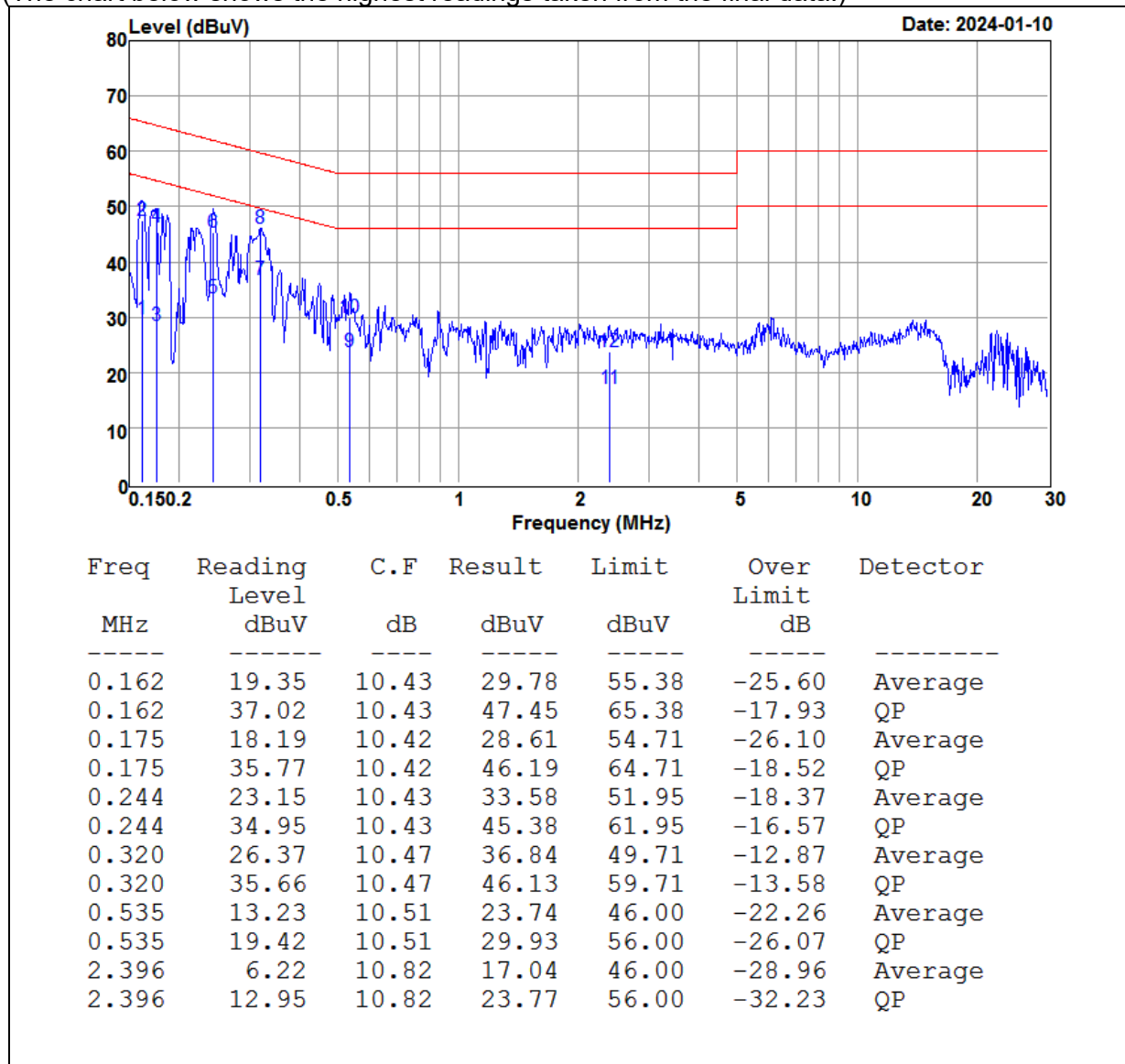

Report No.: TMTN2312001596NR

| | | | |
|--------------------------|----------------|----------------------|------------------|
| Model No. | AT-LP70XBT | Test Mode | Normal Operation |
| Environmental Conditions | 26.5°C, 44% RH | Resolution Bandwidth | 9 kHz |
| Tested by | Jeremy Zhong | | |

NEUTRAL

(The chart below shows the highest readings taken from the final data.)

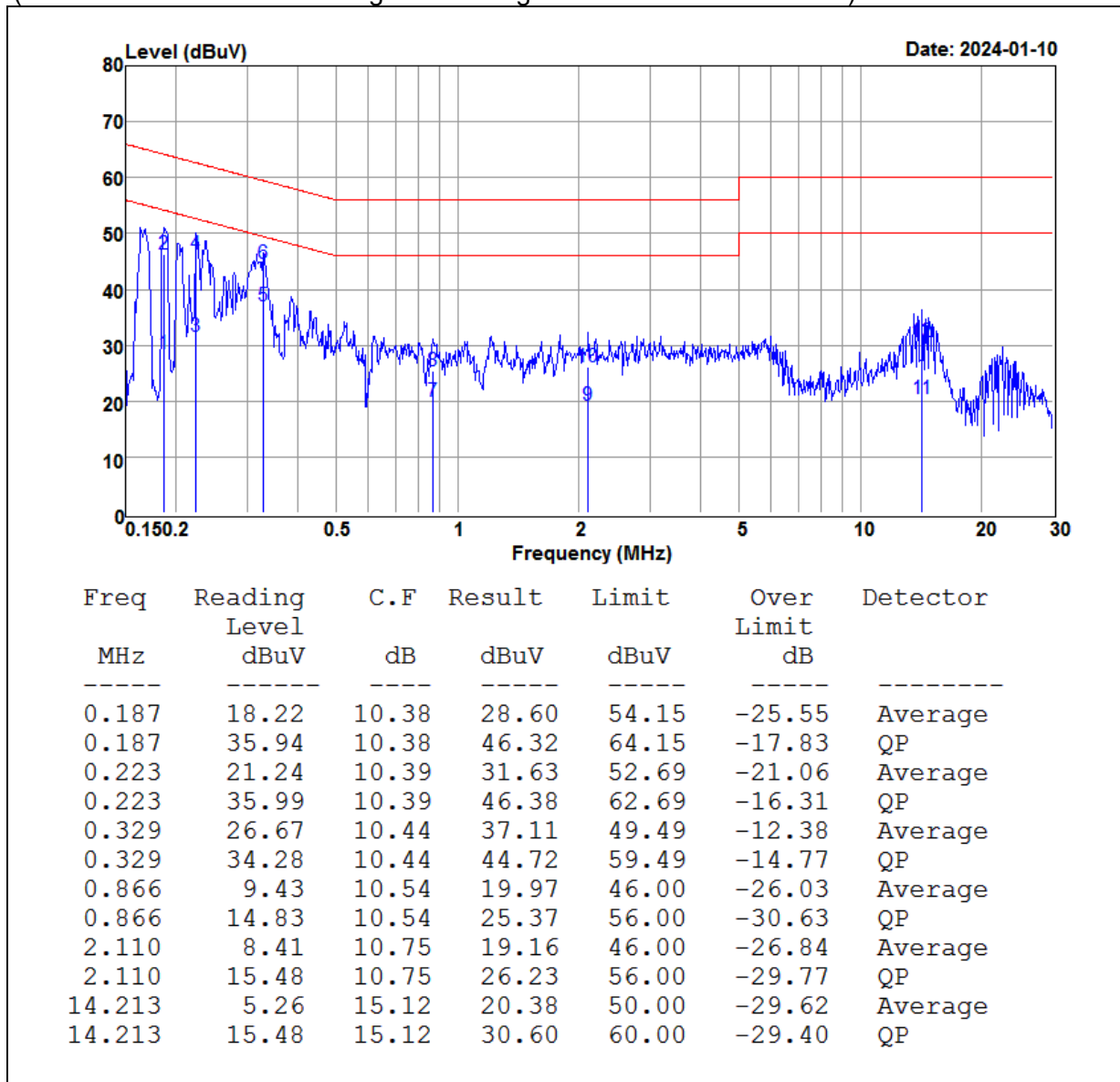

=== END of Report ===