



Project No.: TM-2312000427P
Report No.: TMTN2312001596NR

FCC ID: JFZLP70XBT

Page: 1 / 121
Rev.: 00

FCC 47 CFR PART 15 SUBPART C AND ANSI C63.10: 2013 TEST REPORT

For

AUTOMATIC WIRELESS TURNTABLE

Model: AT-LP70XBT

Data Applies To: N/A

Brand Name: audio-technica

Issued for

Audio-Technica Corporation
2-46-1 Nishi-naruse, Machida, Tokyo 194-8666, JAPAN

Issued By

Compliance Certification Services Inc.
Tainan Lab.
No. 168, Ln. 523, Sec. 3, Zhongzheng Rd.,
Rende Dist., Tainan City, 717017, Taiwan
Issued Date: February 19, 2024

Note: *This report shall not be reproduced except in full, without the written approval of Compliance Certification Services Inc. This document may be altered or revised by Compliance Certification Services Inc. personnel only, and shall be noted in the revision section of the document. The client should not use it to claim product endorsement by TAF or any government agencies. The test results in the report only apply to the tested sample.*

Unless otherwise stated the results shown in this test report refer only to the sample(s) tested and such sample(s) are retained for 90 days only.
除非另有說明，此報告結果僅對測試之樣品負責，同時此樣品僅保留90天。本報告未經本公司書面許可，不可部份複製。

This document is issued by the Company subject to its General Conditions of Service printed overleaf, available on request or accessible at <http://www.sgs.com.tw/Terms-and-Conditions> and, for electronic format documents, subject to Terms and Conditions for Electronic Documents at <http://www.sgs.com.tw/Terms-and-Conditions>. Attention is drawn to the limitation of liability, indemnification and jurisdiction issues defined therein. Any holder of this document is advised that information contained hereon reflects the Company's findings at the time of its intervention only and within the limits of client's instruction, if any. The Company's sole responsibility is to its Client and this document does not exonerate parties to a transaction from exercising all their rights and obligations under the transaction documents. This document cannot be reproduced, except in full, without prior written approval of the Company. Any unauthorized alteration, forgery or falsification of the content or appearance of this document is unlawful and offenders may be prosecuted to the fullest extent of the law.

REVISION HISTORY

Rev.	Issue Date	Revisions	Effect Page	Revised By
00	February 19, 2024	Initial Issue	All Page	Gina Lin

TABLE OF CONTENTS

TITLE	PAGE NO.
1. TEST REPORT CERTIFICATION	4
2. TEST RESULT SUMMARY.....	5
3. EUT DESCRIPTION	6
3.1 DESCRIPTION OF EUT & POWER.....	6
4. DESCRIPTION OF TEST MODES	7
5. TEST METHODOLOGY	9
6. FACILITIES AND ACCREDITATIONS.....	10
6.1 FACILITIES	10
6.2 EQUIPMENT	10
6.3 LABORATORY ACCREDITATIONS LISTINGS.....	10
6.4 TABLE OF ACCREDITATIONS AND LISTINGS	11
6.5 MEASUREMENT EQUIPMENT USED	12
6.6 MEASURING INSTRUMENT CALIBRATION	13
6.7 MEASUREMENT UNCERTAINTY	13
7. SETUP OF EQUIPMENT UNDER TEST.....	14
7.1 SETUP CONFIGURATION OF EUT	14
7.2 SUPPORT EQUIPMENT	14
8. APPLICABLE LIMITS AND TEST RESULTS.....	18
8.1 20DB BANDWIDTH FOR HOPPING.....	18
8.2 MAXIMUM PEAK OUTPUT POWER	24
8.3 HOPPING CHANNEL SEPARATION.....	36
8.4 NUMBER OF HOPPING FREQUENCY USED	41
8.5 DWELL TIME ON EACH CHANNEL	44
8.6 DUTY CYCLE.....	58
8.7 CONDUCTED SPURIOUS EMISSION	63
8.8 RADIATED EMISSIONS	80
8.8.1 TRANSMITTER RADIATED SUPURIOUS EMSSIONS	80
8.8.2 WORST-CASE RADIATED EMISSION BELOW 1 GHZ.....	85
8.8.3 TRANSMITTER RADIATED EMISSION ABOVE 1 GHZ	87
8.8.4 RESTRICTED BAND EDGES	99
8.9 POWERLINE CONDUCTED EMISSIONS	103
APPENDIX I PHOTOGRPHS OF TEST SETUP	107
APPENDIX II PHOTOGRPHS OF EUT	112

1. TEST REPORT CERTIFICATION

Applicant	: Audio-Technica Corporation 2-46-1 Nishi-naruse, Machida, Tokyo 194-8666, JAPAN
Manufacturer	: Audio-Technica Corporation 2-46-1 Nishi-naruse, Machida, Tokyo 194-8666, JAPAN
Equipment Under Test	: AUTOMATIC WIRELESS TURNTABLE
Model Number	: AT-LP70XBT
Data Applies To	: N/A
Brand Name	: audio-technica
Date of Test	: December 27, 2023 ~ January 10, 2024

APPLICABLE STANDARD	
STANDARD	TEST RESULT
FCC Part 15 Subpart C AND ANSI C63.10: 2013	PASS
Statements of Conformity	
Determining compliance shall be based on the results of the compliance measurement, not taking into account measurement instrumentation uncertainty.	

We hereby certify that:

The above equipment was tested by Compliance Certification Services Inc. The test data, data evaluation, test procedures, and equipment configurations shown in this report were made in accordance with the procedures given in **ANSI C63.10: 2013** and the energy emitted by the sample EUT tested as described in this report is in compliance with the requirements of FCC Rules Part 15.207, 15.209, 15.247.

The test results of this report relate only to the tested sample EUT identified in this report.

Approved by:



John Chen
Supervisor

2. TEST RESULT SUMMARY

FCC Standard Section	Report Section	Test Item	Result
15.203	3	ANTENNA REQUIREMENT	Pass
15.247(a)(1)	8.1	20dB BANDWIDTH	Pass
15.247(b)(1)	8.2	MAXIMUM PEAK OUTPUT POWER	Pass
15.247(a)(1)	8.3	HOPPING CHANNEL SEPARATION	Pass
15.247(a)(1)(iii)	8.4	NUMBER OF HOPPING FREQUENCY USED	Pass
15.247(a)(1)(iii)	8.5	DWELL TIME	Pass
-	8.6	DUTY CYCLE	-
15.247(d)	8.7	CONDUCTED SPURIOUS EMISSION	Pass
15.247(d)	8.8	RADIATED EMISSIONS	Pass
15.207(a)	8.9	POWERLINE CONDUCTED EMISSIONS	Pass

3. EUT DESCRIPTION

3.1 DESCRIPTION OF EUT & POWER

Product	AUTOMATIC WIRELESS TURNTABLE
Model Number	AT-LP70XBT
Data Applies To	N/A
Brand Name	audio-technica
Received Date	December 25, 2023
Reported Date	January 24, 2024
Frequency Range	2402MHz ~ 2480MHz
Transmit Peak Power	GFSK : 1.122dBm / 1.29mW 8DPSK: 1.002dBm / 1.26mW
Channel Spacing	1MHz
Transmit Data Rate	GFSK Mode : 1 Mbps 4/πDQPSK Mode : 2Mbps 8DPSK Mode : 3Mbps
Modulation Type	GFSK、π/4DQPSK、8DPSK
Number of Channels	79 Channels
EUT Power Supply	AC 100-240V
Antenna Type	Manufacturer: Sunitec Type: Layout Antenna Model: AT-LP70XBT Gain: 3.33 dBi
Firmware Version	V1.0
Software Version	V1.0

Power Adapter :

Manufacturer	Model No.	Power Input	Power Output
SHENZHEN FUJIA APPLIANCE CO.,LTD	FJ-SW1261200500DN	100-240V~ 50/60Hz 0.4A Max	12Vdc 0.5A 6.0W

Remark:

1. The sample selected for test was production product and was provided by manufacturer.
2. This submittal(s) (test report) is intended for **FCC ID: JFZLP70XBT** filing to comply with Section 15.207, 15.209 and 15.247 of the FCC Part 15, Subpart C Rules.
3. For more details, please refer to the User's manual of the EUT.

4. DESCRIPTION OF TEST MODES

The EUT had been tested under operating condition.

There are three channels have been tested as following :

Channel	Frequency (MHz)
Low	2402
Middle	2441
High	2480

Radiated Emission Test (Below 1 GHz):

- Pre-Scan has been conducted to determine the worst-case mode from all possible combinations between available modulations, data rates and antenna ports (if EUT with antenna diversity architecture).
- Following channel(s) was (were) selected for the final test as listed below.

Normal Operation

Radiated Emission Test (Above 1 GHz):

- Pre-Scan has been conducted to determine the worst-case mode from all possible combinations between available modulations, data rates and antenna ports (if EUT with antenna diversity architecture).
- Following channel(s) was (were) selected for the final test as listed below.

Tested Channel	Modulation Technology	Modulation Type	Packet Type
Low, Mid, High	FHSS	GFSK	DH5
Low, Mid, High	FHSS	8-DPSK	3-DH5

Bandedge Measurement :

- Pre-Scan has been conducted to determine the worst-case mode from all possible combinations between available modulations, data rates and antenna ports (if EUT with antenna diversity architecture).
- Following channel(s) was (were) selected for the final test as listed below.

Tested Channel	Modulation Technology	Modulation Type	Packet Type
Low, High	FHSS	GFSK	DH5
Low, High	FHSS	8-DPSK	3-DH5

Antenna Port Conducted Measurement :

- Pre-Scan has been conducted to determine the worst-case mode from all possible combinations between available modulations, data rates and antenna ports (if EUT with antenna diversity architecture).
- Following channel(s) was (were) selected for the final test as listed below.

Tested Channel	Modulation Technology	Modulation Type	Packet Type
Low, Mid, High	FHSS	GFSK	DH5
Low, Mid, High	FHSS	8-DPSK	3-DH5

5. TEST METHODOLOGY

The tests documented in this report were performed in accordance with ANSI C63.10 : 2013 and FCC CFR 47 15.207, 15.209 and 15.247.

6. FACILITIES AND ACCREDITATIONS

6.1 FACILITIES

All measurement facilities used to collect the measurement data are located at

- No.8, Jiucengling, Xinhua Dist., Tainan City 712, Taiwan (R.O.C.)
- No. 168, Ln. 523, Sec. 3, Zhongzheng Rd., Rende Dist., Tainan City 717, Taiwan

The sites are constructed in conformance with the requirements of ANSI C63.7, ANSI C63.10 and CISPR Publication 22.

6.2 EQUIPMENT

Radiated emissions are measured with one or more of the following types of linearly polarized antennas: tuned dipole, bi-conical, log periodic, bi-log, and/or ridged waveguide, horn. Spectrum analyzers with pre-selectors and quasi-peak detectors are used to perform radiated measurements.

Conducted emissions are measured with Line Impedance Stabilization Networks and EMI Test Receivers.

Calibrated wideband preamplifiers, coaxial cables, and coaxial attenuators are also used for making measurements.

All receiving equipment conforms to CISPR Publication 16-1, "Radio Interference Measuring Apparatus and Measurement Methods."

6.3 LABORATORY ACCREDITATIONS LISTINGS

The test facilities used to perform radiated and conducted emissions tests are accredited by Taiwan Accreditation Foundation for the specific scope of accreditation under Lab Code: 1109 to perform Electromagnetic Interference tests according to FCC PART 15 AND CISPR 22 requirements. No part of this report may be used to claim or imply product endorsement by TAF or any agency of the Government. In addition, the test facilities are listed with Federal Communications Commission (registration no: TW1109).

6.4 TABLE OF ACCREDITATIONS AND LISTINGS

Our laboratories are accredited and approved by the following approval agencies according to ISO/IEC 17025.

Taiwan	TAF
---------------	-----

The measuring facility of laboratories has been authorized or registered by the following approval agencies.

Canada	Industry Canada (ISED#: 2324H)
Germany	TUV NORD
Taiwan	BSMI
USA	FCC

Report No.: TMTN2312001596NR

6.5 MEASUREMENT EQUIPMENT USED

For §8.8.2~8.8.3

Chamber 1166 Room (Radiation Test)					
Name of Equipment	Manufacturer	Model	Serial Number	Calibration Date	Calibration Due
Active Loop Antenna	ETS-LINDREN	6502	8905-2356	09/04/2023	09/03/2024
Attenuator	MCL	BW-S15W5	0535	01/19/2023	01/18/2024
Bilog Antenna with 6dB Attenuator	SUNOL SCIENCES & EMCI	JB1 & N-6-06	A021306 & AT-N0682	10/03/2023	10/02/2024
Cable	EMCI	EM102-KMKM	CB1166-01	06/17/2023	06/16/2024
Double Ridged Guide Horn Antenna	ETS-LINDGREN	3116	00078900	03/25/2023	03/24/2024
EMI Test Receiver	R&S	ESCI	101203	10/16/2023	10/15/2024
EXA Spectrum Analyzer	KEYSIGHT	N9010A	MY54430216	07/25/2023	07/24/2024
Double Ridged Guide Horn Antenna	SCHWARZBECK	BBHA 9120D	9120D-788(98006)	04/18/2023	04/17/2024
Notch Filter	MICRO-TRONICS	BRM50702-01	018	01/19/2023	01/18/2024
Pre-Amplifier	EMCI	EMC012645	980098	01/19/2023	01/18/2024
Pre-Amplifier	Com-Power	PAM-840A	461378	06/07/2023	06/06/2024
Software	Excel(ccs-o6-2020 v1.1) , e3(v6.101222)				

For §8.1~8.7 8.8.4

Chamber 1166 Room (Conducted Test)					
Name of Equipment	Manufacturer	Model	Serial Number	Calibration Date	Calibration Due
EXA Spectrum Analyzer	KEYSIGHT	N9010A	MY54430216	07/25/2023	07/24/2024
SMA Cable+10dB Attenuator	CCS	SMA+10dB ATT	SMA/10dB	01/19/2023	01/18/2024
Software	Excel(ccs-o6-2020 v1.1)				

For §8.9

Conducted Emission room #1					
Name of Equipment	Manufacturer	Model	Serial Number	Calibration Date	Calibration Due
BNC Coaxial Cable	CCS	BNC50	11	01/19/2023	01/18/2024
EMI Test Receiver	R&S	ESCS 30	100348	12/05/2023	12/04/2024
LISN	R&S	ENV216	101495	07/12/2023	07/11/2024
LISN	SCHWARZBECK	NNLK8130	8130124	01/18/2023	01/17/2024
Pulse Limiter	SCHWARZBECK	VTSD 9561-F	797	01/19/2023	01/18/2024
Test S/W	e3(v6.101222)				

Report No.: TMTN2312001596NR

6.6 MEASURING INSTRUMENT CALIBRATION

The measuring equipment utilized to perform the tests documented in this report has been calibrated in accordance with the manufacturer's recommendations, and is traceable to recognized national standards.

6.7 MEASUREMENT UNCERTAINTY

Where relevant, the following measurement uncertainty levels have been estimated for tests performed on the apparatus:

PARAMETER	UNCERTAINTY
Radiated Emission, 9kHz~30MHz Test Site : CB1166	±2.7dB
Radiated Emission, 30 MHz ~1GHz Test Site : CB1166	±3.76dB
Radiated Emission, 1GHz ~18GHz Test Site : CB1166	±4.43dB
Radiated Emission, 18GH~26.5GHz Test Site : CB1166	±4.79dB
Radiated Emission, 26.5GH~40GHz Test Site : CB1166	±4.72dB
Power Line Conducted Emission, 9kHz~30MHz	±1.83dB
Band Width	0.025%
Peak Output Power MU	±1.9dB
Band Edge MU	±0.264dBuV
Channel Separation MU	±361.69Hz
Duty Cycle MU	±0.2%
Frequency Stability MU	±0.493Hz
Temperature	±0.5
Humidity	±3%

This measurement uncertainty is confidence of approximately 95%, k=2

7. SETUP OF EQUIPMENT UNDER TEST

7.1 SETUP CONFIGURATION OF EUT

EMI

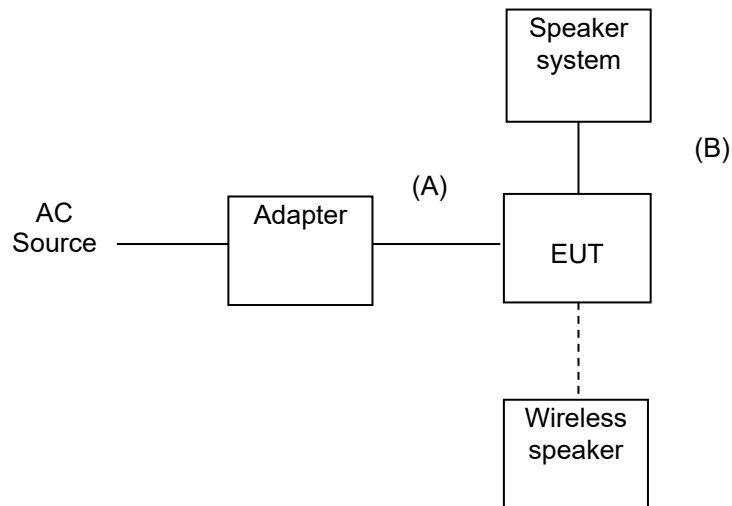

RF

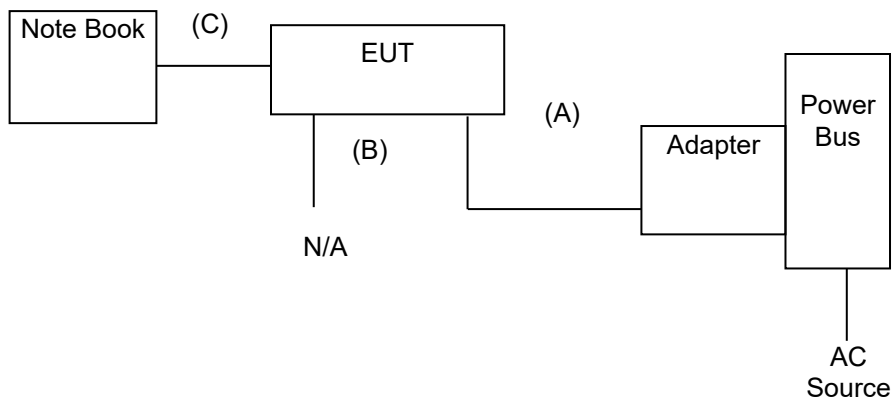

7.2 SUPPORT EQUIPMENT

For EMI test

No.	Product	Manufacturer	Model No.	Certify No.	Signal cable
1	Speaker System	infotec	SP-102	DOC	N/A
2	Wireless Speaker	PHILIPS	TAS1505	DOC	N/A

No.	Signal cable description	
A	DC Power Cable	Unshielded, 1.5m 1 pcs. with 1 core.
B	Audio Cable	Shielded, 1.0m 1 pcs.

For RF test

No.	Product	Manufacturer	Model No.	Certify No.	Power cable
1	Note Book	Acer	Z5WE1	N/A	Unshielded, 1.8m with 1 core.

No.	Signal cable description	
A	DC Power	Unshielded, 1.5m 1 pcs. with 1 core.
B	Audio	Shielded, 1.0m 1 pcs.
C	Micro USB	Shielded, 2.0m 1 pcs. with 1 core.

Note:

- 1) All the equipment/cables were placed in the worst-case configuration to maximize the emission during the test.
- 2) Grounding was established in accordance with the manufacturer's requirements and conditions for the intended use.
- 3) shd. = shielded; unshd. = unshielded

EUT OPERATING CONDITION

RF Setup

1. Set up all computers like the setup diagram.
2. The “Blue Test 3 V3.3.9.1137” software was used for testing
3. Choose Transport “DEBUG” and Device “USB DBG(100)”

BT1.0 、 3.0

TX Mode:

PACKET TX

Channel 1~5: 0,39,78

GFSK(DH1):

Packet Type:DH1 > Packet Length 27

Power(0-9) : 6

GFSK(DH3):

Packet Type:DH3 > Packet Length 183

Power(0-9) : 6

GFSK(DH5):

Packet Type:DH5 > Packet Length 339

Power(0-9) : 6

8-DPSK(3DH1):

Packet Type:3DH1 > Packet Length 83

Power(0-9) : 6

8-DPSK(3DH3):

Packet Type:3DH3 > Packet Length 552

Power(0-9) : 6

8-DPSK(3DH5):

Packet Type:3DH5 > Packet Length 1021

Power(0-9) : 6

RX Mode:

PACKET RX

BT4.0 、 5.0

TX Mode:

BLE TEST TX

Channel > 0,20,39 (0-39)

Length > 37

Bit pattern > Pseudo-rdm 9

PHY > 1M (2M)

RX Mode:

BLE TEST RX

Channel > 0 (0-39)

PHY > 1M (2M)

4. All of the function are under run.
5. Start test.

8. APPLICABLE LIMITS AND TEST RESULTS

8.1 20dB BANDWIDTH FOR HOPPING

LIMIT

None; for reporting purposes only.

TEST SETUP

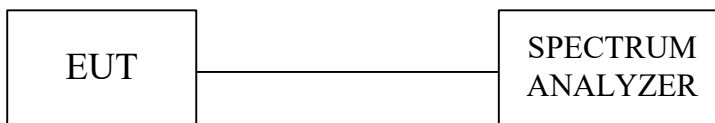

TEST PROCEDURE

- a) Set RBW = 100 kHz.
- b) Set the video bandwidth (VBW) $\geq 3 \times$ RBW.
- c) Detector = Peak.
- d) Trace mode = max hold.
- e) Sweep = auto couple.
- f) Allow the trace to stabilize.
- g) Measure the maximum width of the emission that is constrained by the frequencies associated with the two outermost amplitude points (upper and lower frequencies) that are attenuated by 20 dB relative to the maximum level measured in the fundamental emission.

TEST RESULTS

Model Name	AT-LP70XBT	Test By	Peter Chu
Temp & Humidity	22.5°C, 45%	Test Date	2023/12/27

Modulation Type: GFSK / DH5

Channel	Channel Frequency (MHz)	20dB Bandwidth (kHz)	Two-third of 20dB Bandwidth (MHz)
Low	2402	1121.00	0.75
Middle	2441	1120.00	0.75
High	2480	1119.00	0.75

Modulation Type: 8-DPSK / 3-DH5

Channel	Channel Frequency (MHz)	20dB Bandwidth (kHz)	Two-third of 20dB Bandwidth (MHz)
Low	2402	1399.00	0.93
Middle	2441	1396.00	0.93
High	2480	1396.00	0.93

20dB BANDWIDTH

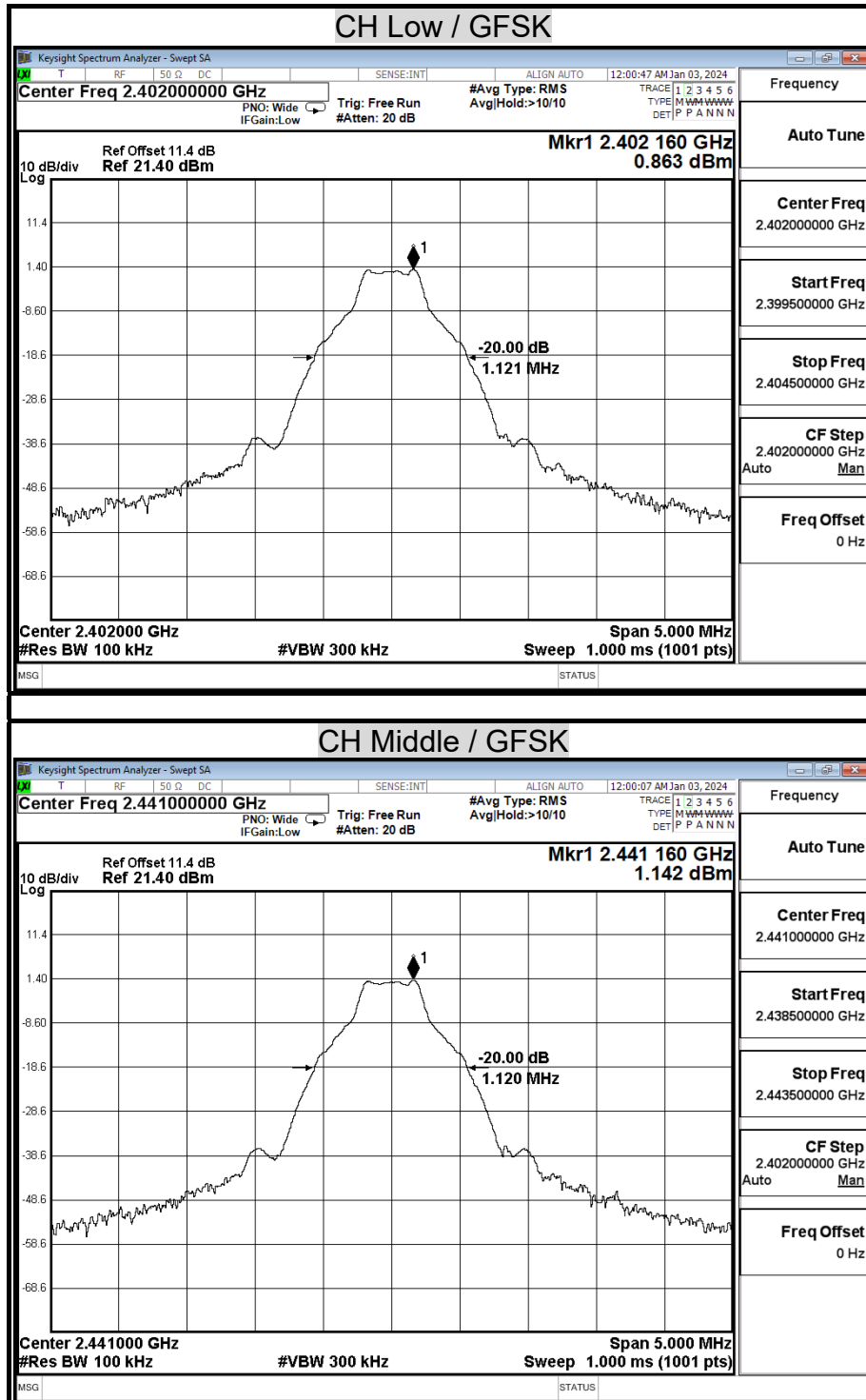

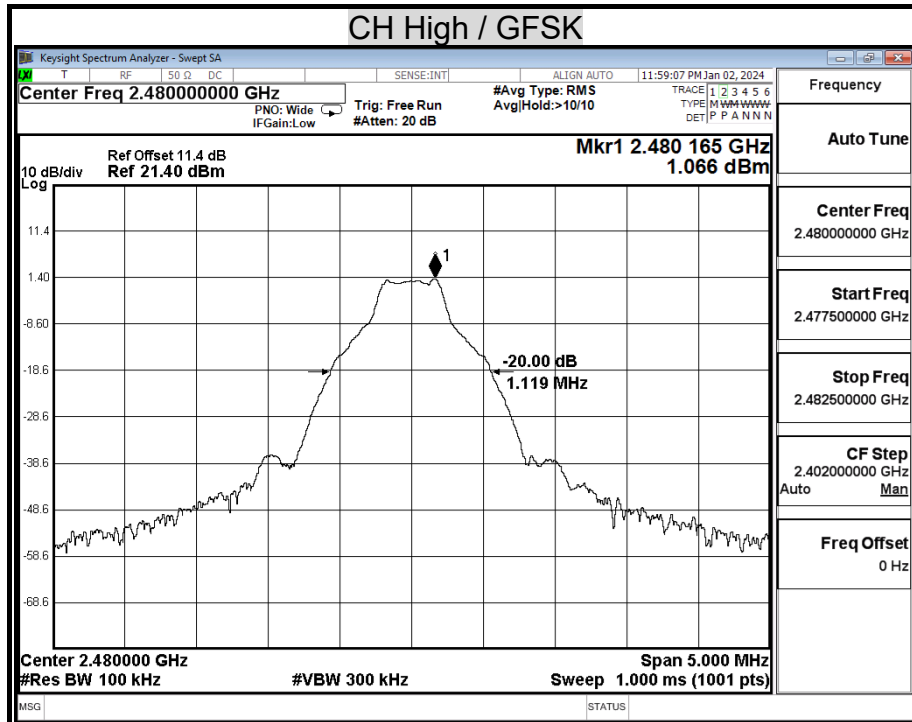

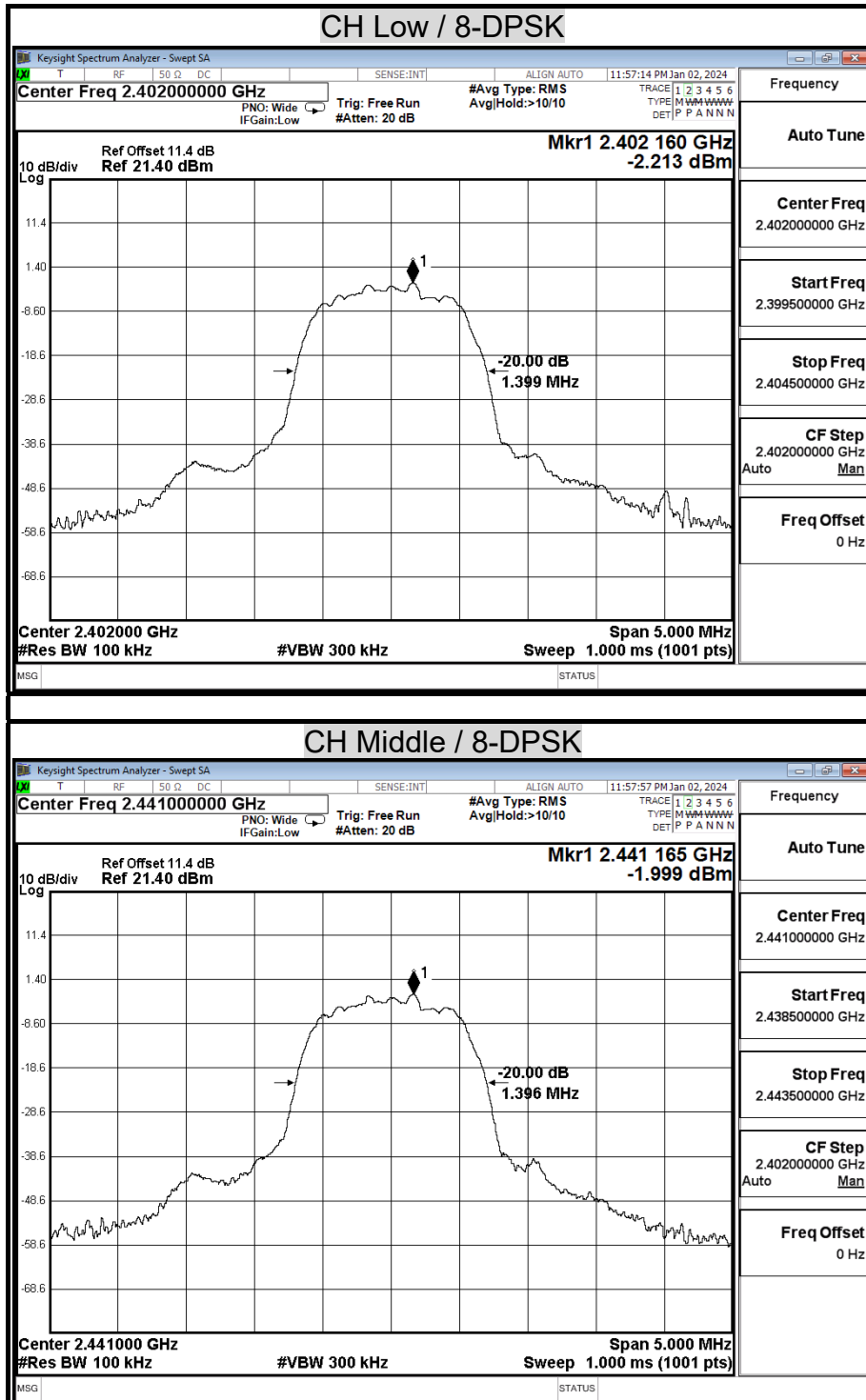

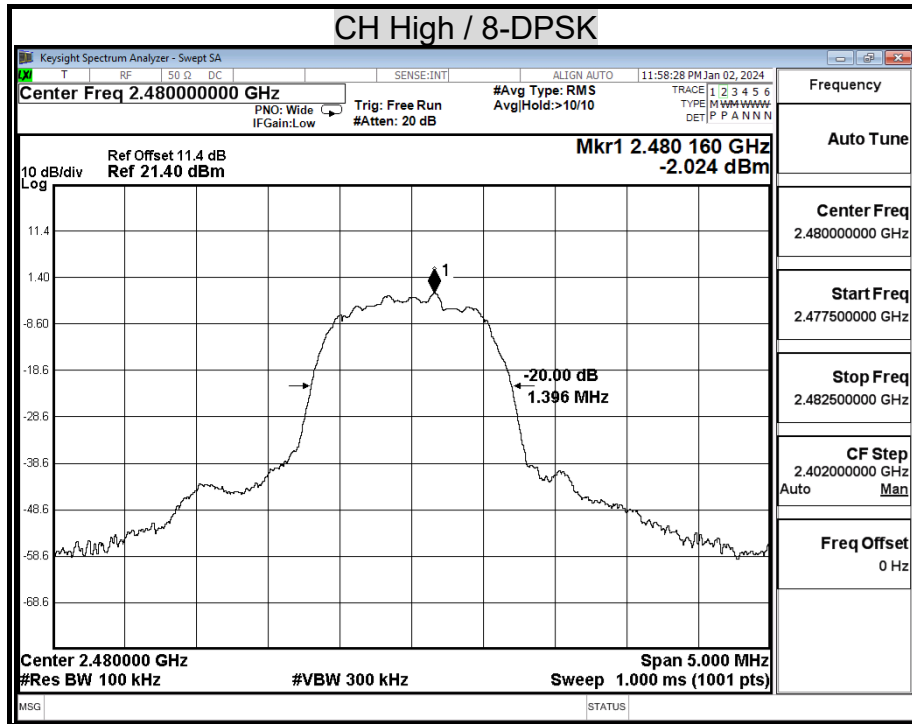

8.2 MAXIMUM PEAK OUTPUT POWER

LIMIT

§15.247(b)(1) For frequency hopping systems operating in the 2400-2483.5 MHz band employing at least 75 non-overlapping hopping channels, and all frequency hopping systems in the 5725-5850 MHz band: 1 watt. For all other frequency hopping systems in the 2400-2483.5 MHz band: 0.125 watts.

Test Configuration



TEST PROCEDURE

The RF power output was measured with a Spectrum Analyzer connected to the RF Antenna connector (conducted measurement) while EUT was operating in transmit mode at the appropriate center frequency.

Peak Power set:

1. Set the RBW = \geq DTS bandwidth.
2. Set the VBW \geq [3 \times RBW].
3. Set the span \geq [1.5 \times DTS bandwidth].
4. Detector = peak.
5. Sweep time = auto couple.
6. Trace mode = max hold.
7. Allow trace to fully stabilize.
8. Use the instrument's band/channel power measurement function with the band limits set equal to the DTS bandwidth edges (for some instruments, this may require a manual override to select the peak detector). If the instrument does not have a band power function, then sum the spectrum levels (in linear power units) at intervals equal to the RBW extending across the DTS channel bandwidth.

Average power set:

1. Measure the duty cycle D of the transmitter output signal
2. Set span to at least 1.5 times the OBW.
3. Set the RBW = \geq DTS bandwidth
4. Set VBW $\geq [3 \times \text{RBW}]$.
5. Number of points in sweep $\geq [2 \times \text{span} / \text{RBW}]$. (This gives bin-to-bin spacing $\leq \text{RBW} / 2$, so that narrowband signals are not lost between frequency bins.)
6. Manually set sweep time $\geq [10 \times (\text{number of points in sweep}) \times (\text{total ON/OFF period of the transmitted signal})]$.
7. Set detector = RMS (power averaging).
8. Perform a single sweep.
9. Compute power by integrating the spectrum across the OBW of the signal using the instrument's band power measurement function with band limits set equal to the OBW band edges. If the instrument does not have a band power function, then sum the spectrum levels (in power units) at intervals equal to the RBW extending across the entire OBW.
10. Add $[10 \log (1 / D)]$, where D is the duty cycle, to the measured power to compute the average power during the actual transmission times.

TEST RESULTS

Model Name	AT-LP70XBT	Test By	Peter Chu
Temp & Humidity	22.5°C, 45%	Test Date	2023/12/27

Modulation Type: GFSK / DH5

Channel	Channel Frequency (MHz)	Peak Power Output (dBm)	Peak Power Output (mW)	Limit (mW)	Result
Low	2402	0.88	1.22	125	PASS
Mid	2441	1.12	1.29		PASS
High	2480	1.04	1.27		PASS

Modulation Type: 8-DPSK / 3-DH5

Channel	Channel Frequency (MHz)	Peak Power Output (dBm)	Peak Power Output (mW)	Limit (mW)	Result
Low	2402	0.74	1.19	125	PASS
Mid	2441	1.00	1.26		PASS
High	2480	0.97	1.25		PASS

Average Power Data

Modulation Type: GFSK / DH5

Channel	Channel Frequency (MHz)	Measure Power (dBm)	10 log (1 / D)	Average Power (dBm)
Low	2402	-0.54	1.10	0.57
Middle	2441	-0.25	1.10	0.85
High	2480	-0.34	1.10	0.77

Modulation Type: 8-DPSK / 3-DH5

Channel	Channel Frequency (MHz)	Measure Power (dBm)	10 log (1 / D)	Average Power (dBm)
Low	2402	-3.79	1.10	-2.68
Middle	2441	-3.51	1.10	-2.40
High	2480	-3.59	1.10	-2.48

MAXIMUM PEAK OUTPUT POWER

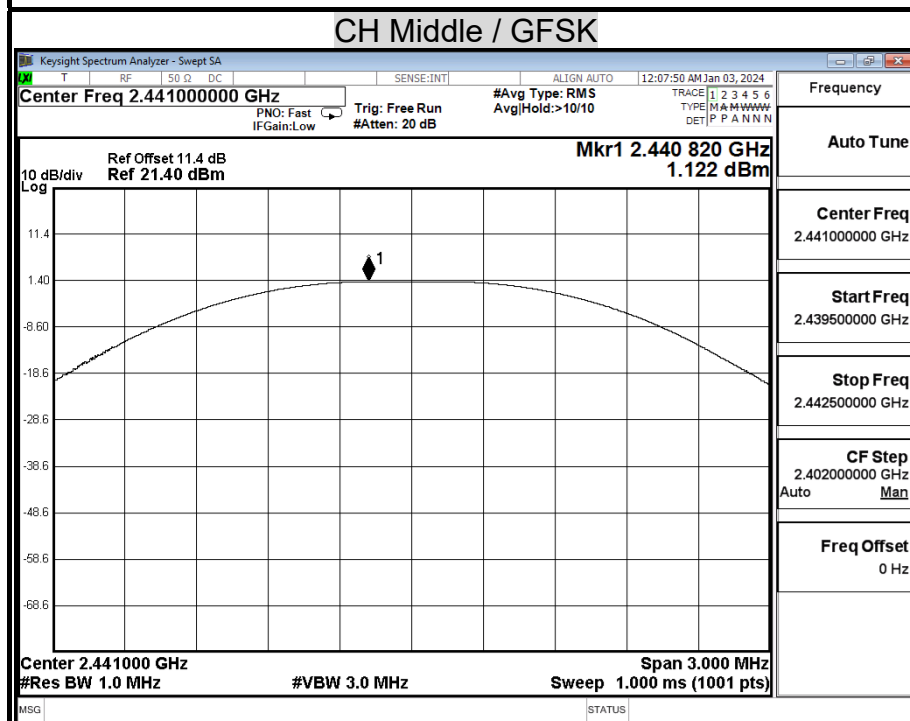
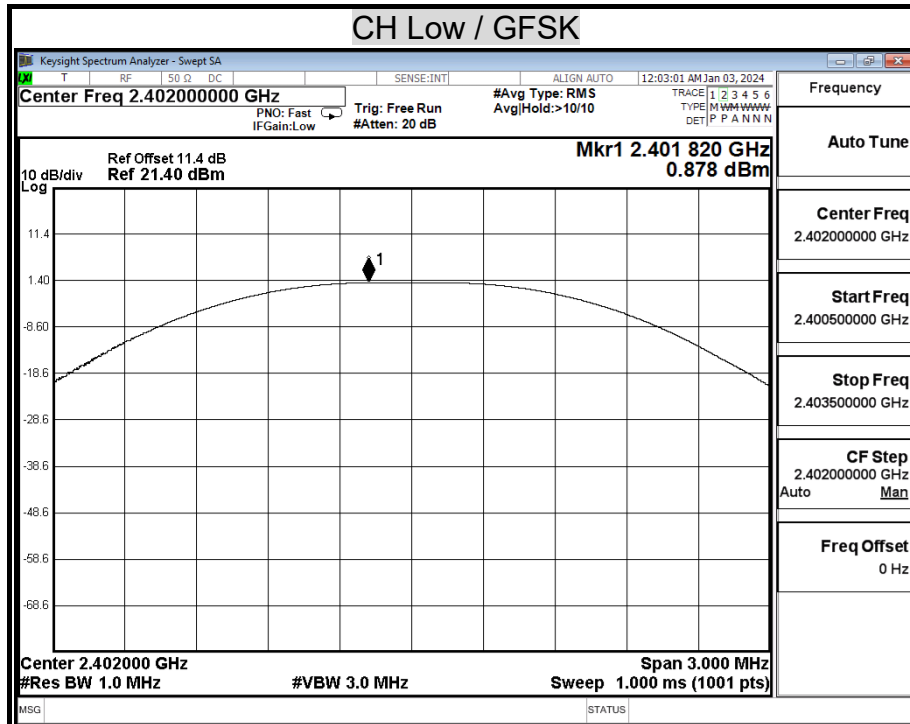

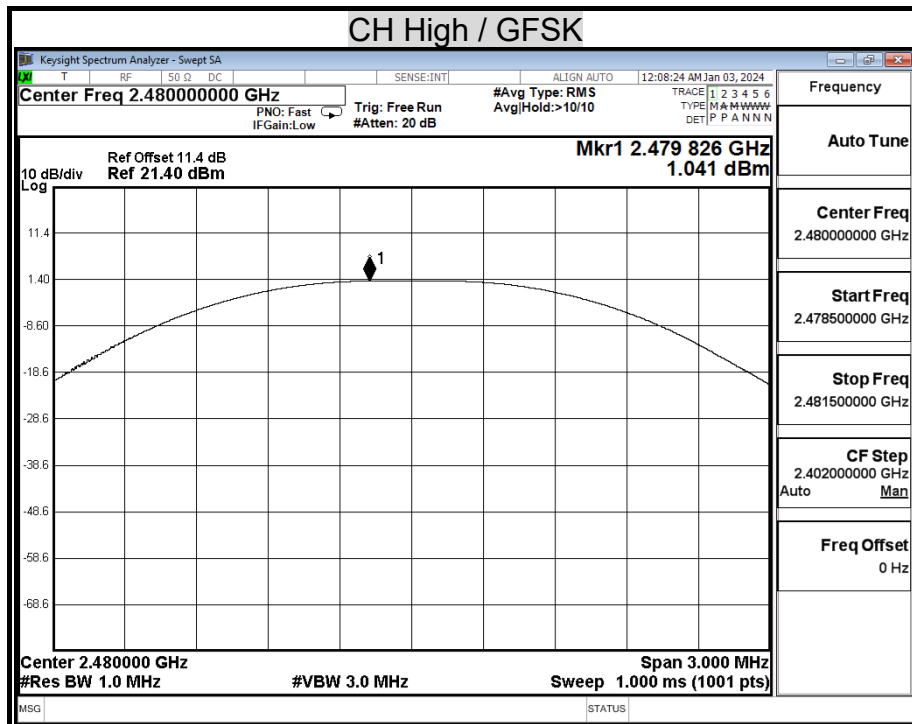

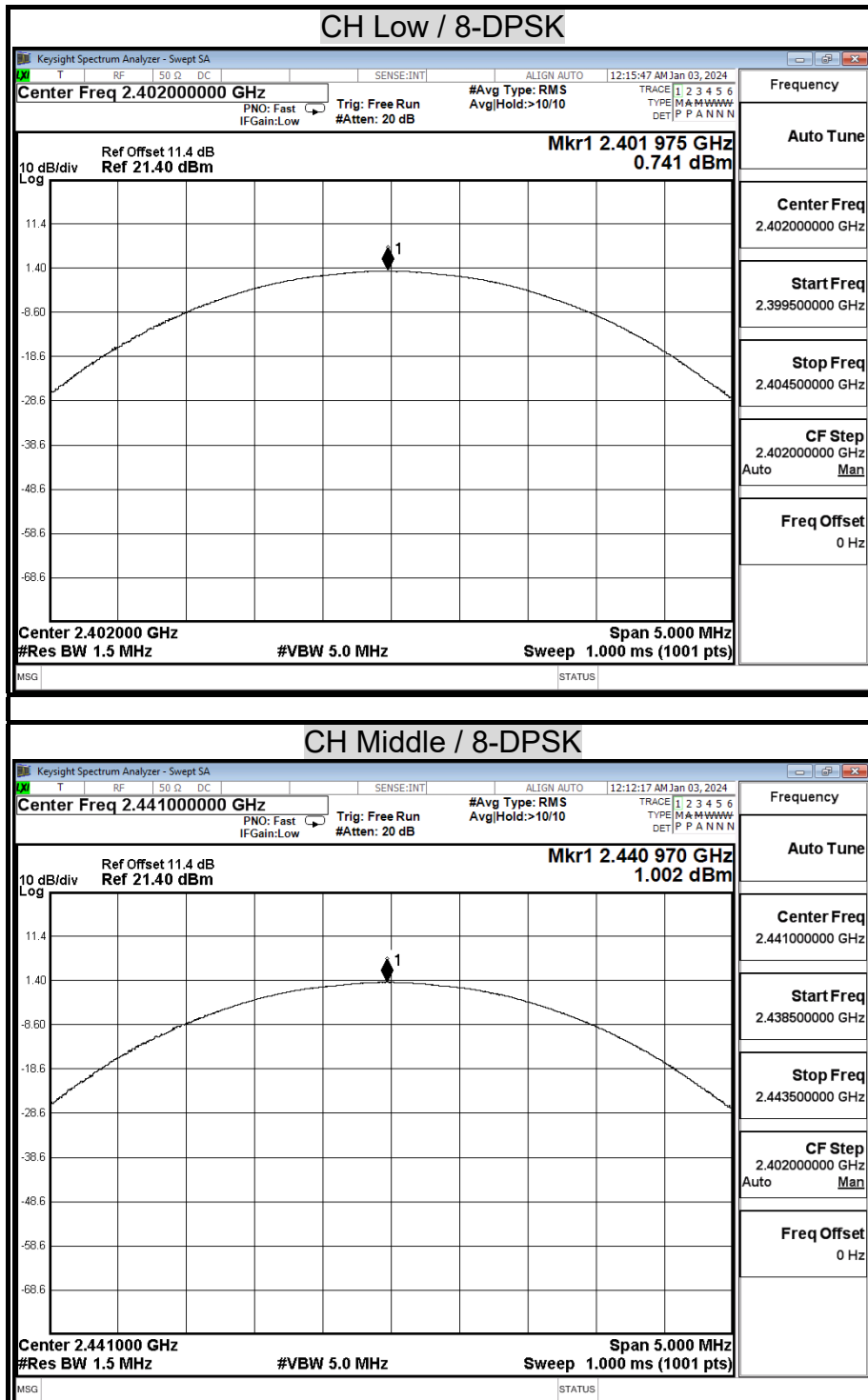

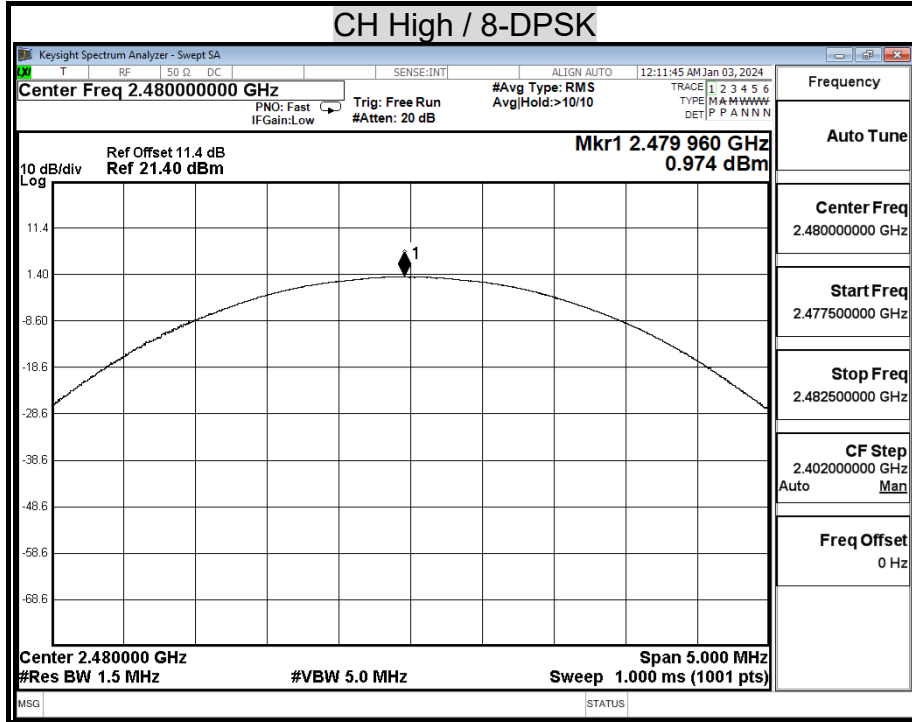

AVERAGE POWER

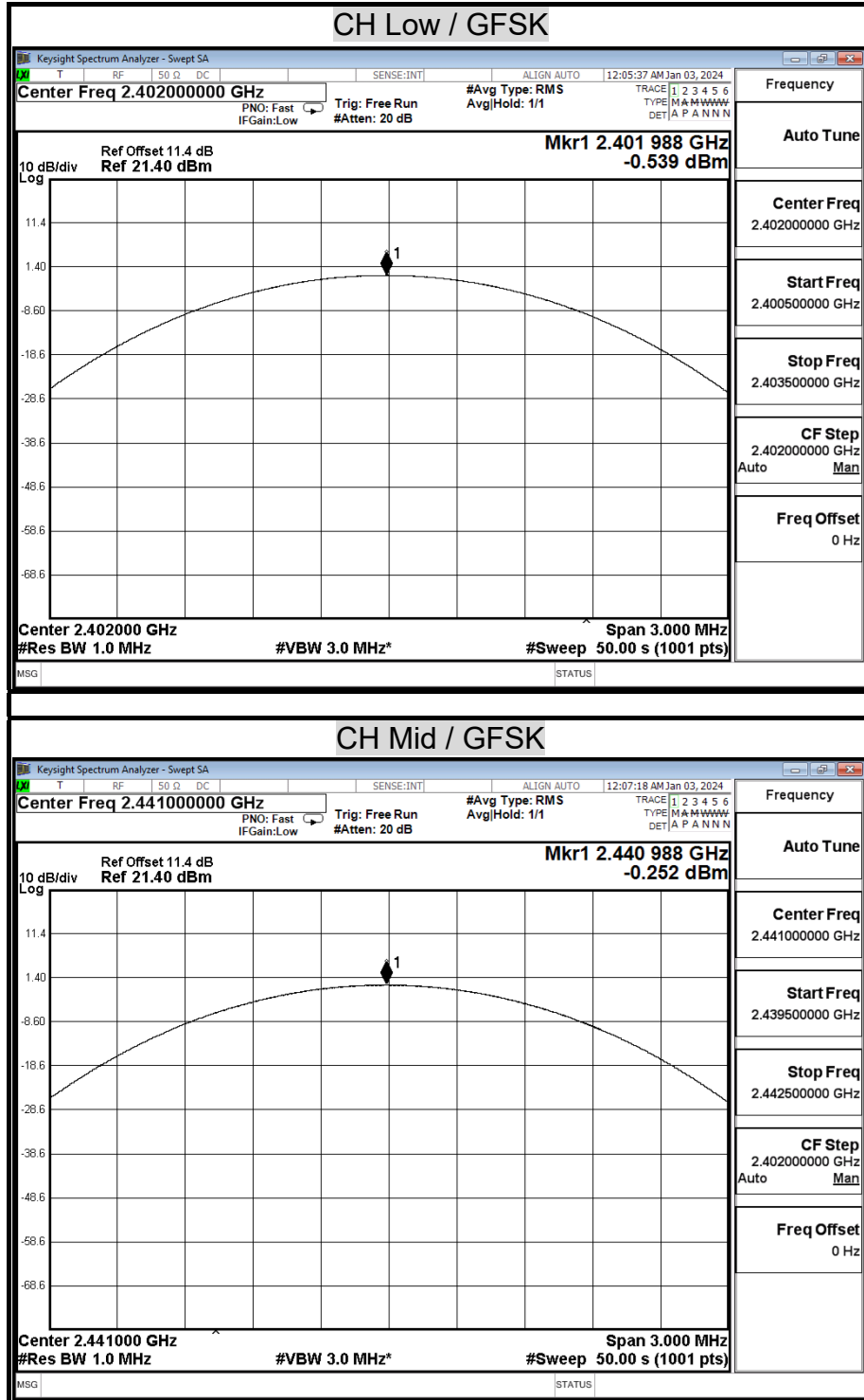

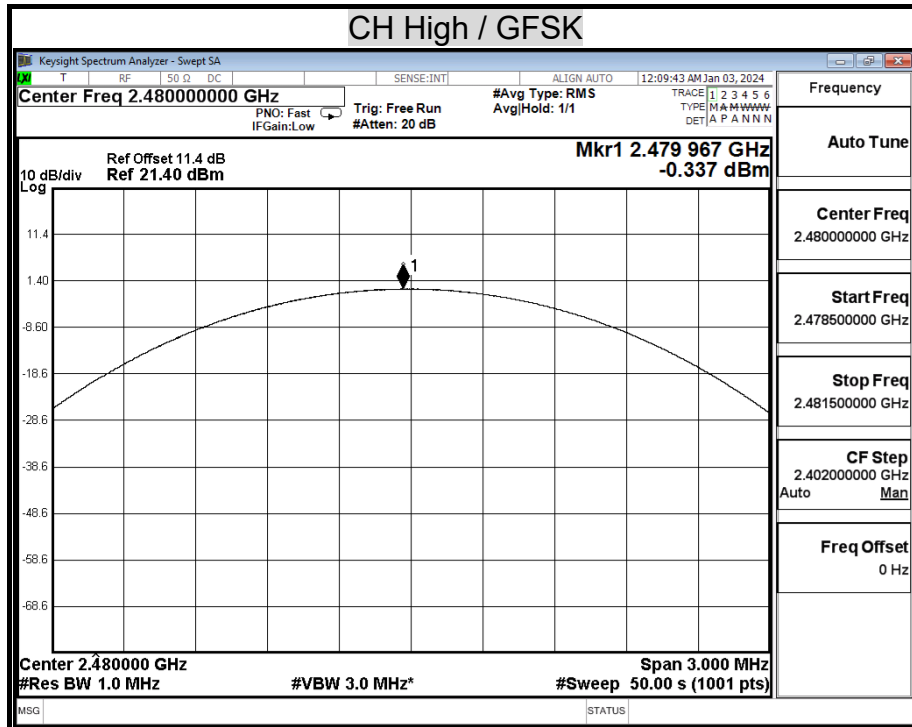

Report No.: TMTN2312001596NR

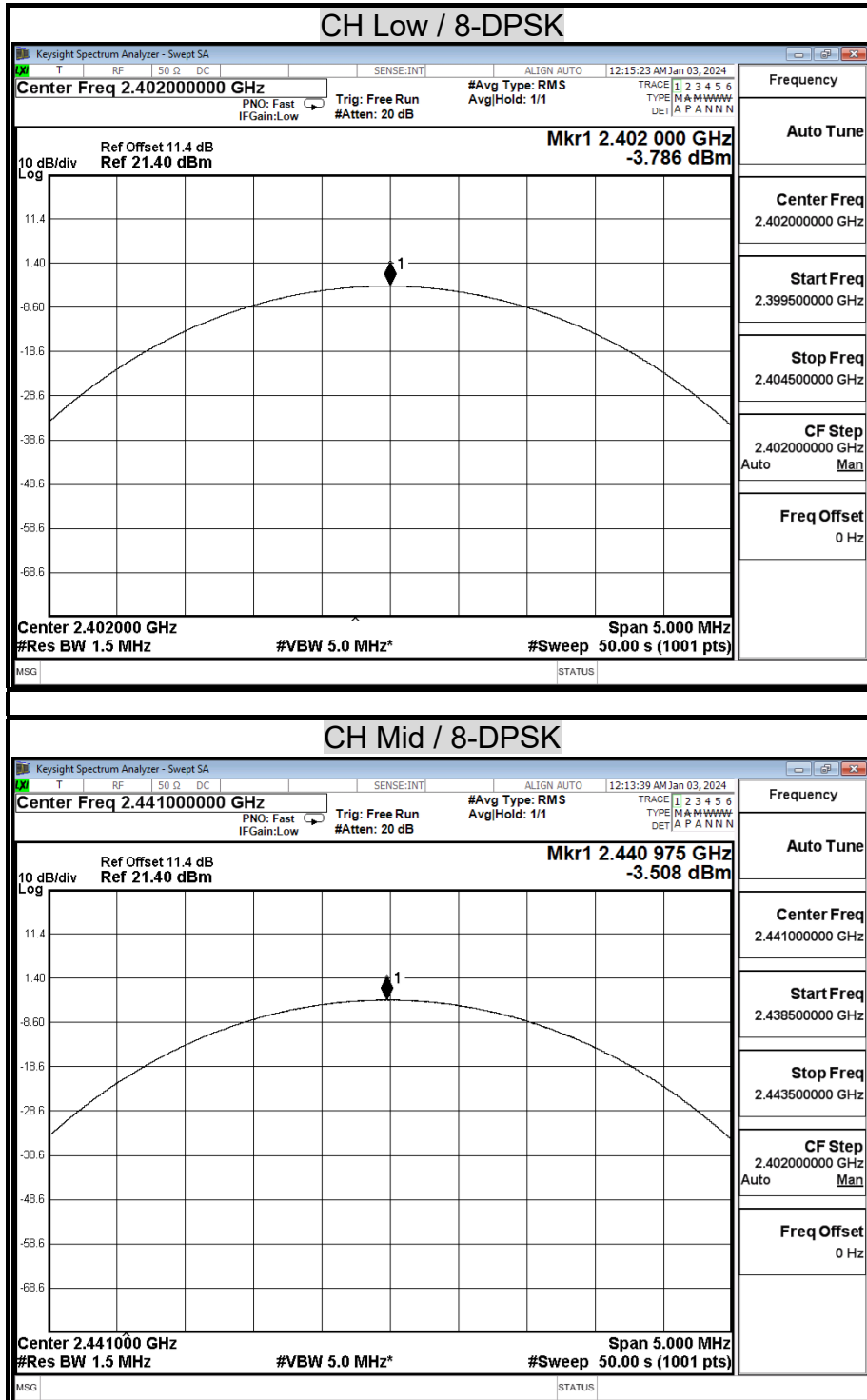

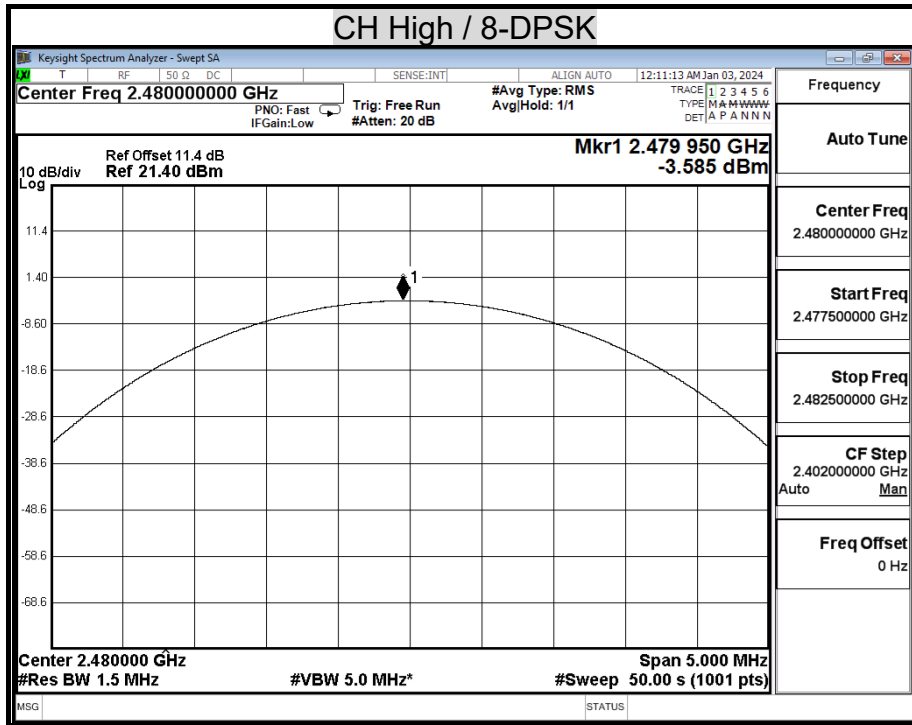

8.3 HOPPING CHANNEL SEPARATION

LIMIT

§15.247(a)(1) Frequency hopping systems shall have hopping channel carrier frequencies separated by a minimum of 25 kHz or the 20 dB bandwidth of the hopping channel, whichever is greater. Alternatively, frequency hopping systems operating in the 2400-2483.5 MHz band may have hopping channel carrier frequencies that are separated by 25 kHz or two-thirds of the 20 dB bandwidth of the hopping channel, whichever is greater, provided the systems operate with an output power no greater than 125 mW. The system shall hop to channel frequencies that are selected at the system hopping rate from a pseudo randomly ordered list of hopping frequencies. Each frequency must be used equally on the average by each transmitter. The system receivers shall have input bandwidths that match the hopping channel bandwidths of their corresponding transmitters and shall shift frequencies in synchronization with the transmitted signals.

TEST SETUP

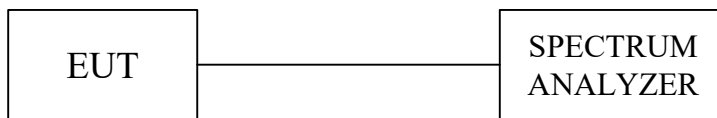

TEST PROCEDURE

1. Check the calibration of the measuring instrument using either an internal calibrator or a known signal from an external generator.
2. Position the EUT as shown in test setup without connection to measurement instrument. Turn on the EUT and connect it to measurement instrument. Then set it to any one convenient frequency within its operating range.
3. By using the MaxHold function record the separation of adjacent channels.
4. Measure the frequency difference of these two adjacent channels by spectrum analyzer MARK function. And then plot the result on spectrum analyzer screen.
5. Repeat above procedures until all frequencies measured were complete.

Report No.: TMTN2312001596NR

TEST RESULTS

Refer to section 8.1, 20dB bandwidth measurement, the measured channel separation should be greater than two-third of 20dB bandwidth or Minimum bandwidth.

Model Name	AT-LP70XBT	Test By	Peter Chu
Temp & Humidity	22.5°C, 45%	Test Date	2023/12/27

Modulation Type: GFSK / DH5

Channel	Adjacent Hopping Channel Separation (MHz)	Two -third of 20dB bandwidth (MHz)	Minimum Bandwidth (kHz)	Result
2402MHz	1.00	0.75	25	PASS
2441MHz	1.00	0.75	25	PASS
2480MHz	1.00	0.75	25	PASS

Modulation Type: 8-DPSK / 3-DH5

Channel	Adjacent Hopping Channel Separation (MHz)	Two -third of 20dB bandwidth (MHz)	Minimum Bandwidth (kHz)	Result
2402MHz	1.00	0.93	25	PASS
2441MHz	1.00	0.93	25	PASS
2480MHz	1.00	0.93	25	PASS

Report No.: TMTN2312001596NR

HOPPING CHANNEL SEPARATION

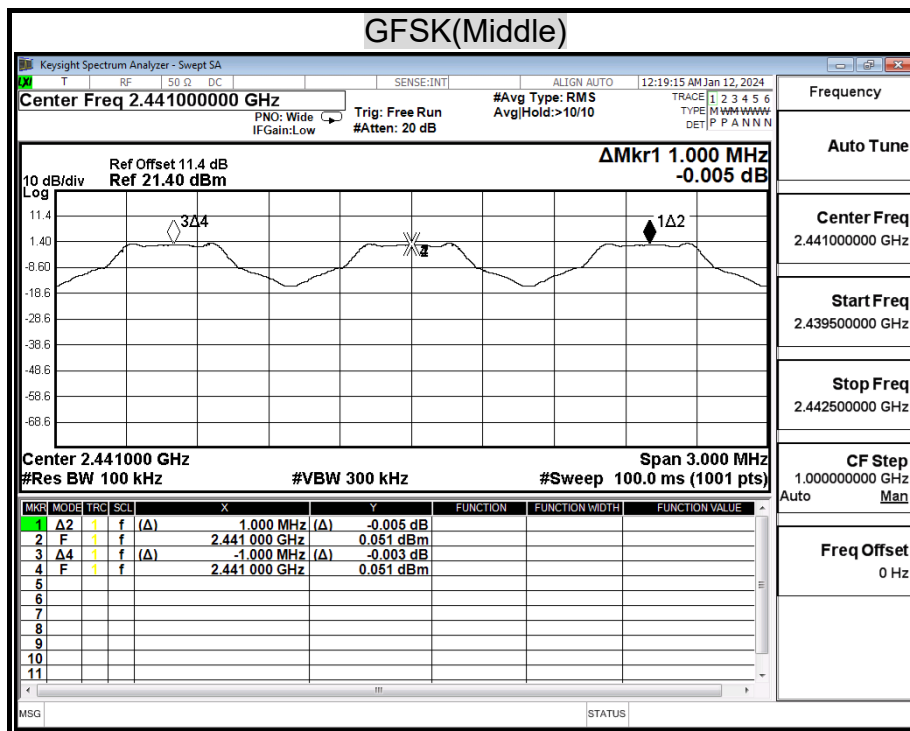
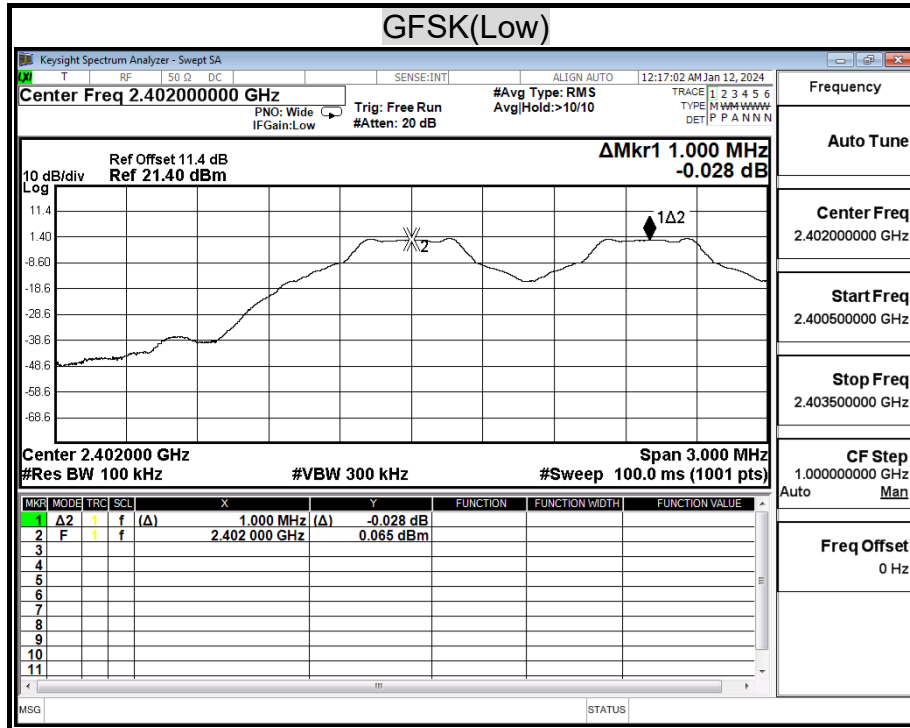

Report No.: TMTN2312001596NR

