



Project No.: TM-2202000149P
Report No.: TMTN2202000174NR

FCC ID: JFZLP3XBTA

Page: 1 / 112
Rev.: 00

FCC 47 CFR PART 15 SUBPART C AND ANSI C63.10: 2013 TEST REPORT

For

AUTOMATIC WIRELESS TURNTABLE

Model: AT-LP3XBT

Data Applies To: N/A

Brand Name: audio-technica

Issued for

Audio-Technica Corporation
2-46-1 Nishi-naruse, Machida, Tokyo 194-8666, JAPAN

Issued By

Compliance Certification Services Inc.

Tainan Lab.

**No.8, Jiucengling, Xinhua Dist.,
Tainan City, Taiwan**

Issued Date: April 25, 2022

Note: *This report shall not be reproduced except in full, without the written approval of Compliance Certification Services Inc. This document may be altered or revised by Compliance Certification Services Inc. personnel only, and shall be noted in the revision section of the document. The client should not use it to claim product endorsement by TAF or any government agencies. The test results in the report only apply to the tested sample.*

Unless otherwise stated the results shown in this test report refer only to the sample(s) tested and such sample(s) are retained for 90 days only.

除非另有說明，此報告結果僅對測試之樣品負責，同時此樣品僅保留90天。本報告未經本公司書面許可，不可部份複製。

This document is issued by the Company subject to its General Conditions of Service printed overleaf, available on request or accessible at <http://www.sgs.com.tw/Terms-and-Conditions> and, for electronic format documents, subject to Terms and Conditions for Electronic Documents at <http://www.sgs.com.tw/Terms-and-Conditions>. Attention is drawn to the limitation of liability, indemnification and jurisdiction issues defined therein. Any holder of this document is advised that information contained hereon reflects the Company's findings at the time of its intervention only and within the limits of client's instruction, if any. The Company's sole responsibility is to its Client and this document does not exonerate parties to a transaction from exercising all their rights and obligations under the transaction documents. This document cannot be reproduced, except in full, without prior written approval of the Company. Any unauthorized alteration, forgery or falsification of the content or appearance of this document is unlawful and offenders may be prosecuted to the fullest extent of the law.

REVISION HISTORY

Rev.	Issue Date	Revisions	Effect Page	Revised By
00	April 25, 2022	Initial Issue	ALL	Gina Lin

TABLE OF CONTENTS

TITLE	PAGE NO.
1. TEST REPORT CERTIFICATION	4
2. TEST RESULT SUMMARY.....	5
3. EUT DESCRIPTION	6
3.1 DESCRIPTION OF EUT & POWER.....	6
4. DESCRIPTION OF TEST MODES	7
5. TEST METHODOLOGY	9
6. FACILITIES AND ACCREDITATIONS.....	10
6.1 FACILITIES	10
6.2 EQUIPMENT	10
6.3 LABORATORY ACCREDITATIONS LISTINGS.....	10
6.4 TABLE OF ACCREDITATIONS AND LISTINGS	11
6.5 MEASUREMENT EQUIPMENT USED	12
6.6 MEASURING INSTRUMENT CALIBRATION	13
6.7 MEASUREMENT UNCERTAINTY	13
7. SETUP OF EQUIPMENT UNDER TEST.....	14
7.1 SETUP CONFIGURATION OF EUT	14
7.2 SUPPORT EQUIPMENT.....	14
8. APPLICABLE LIMITS AND TEST RESULTS.....	18
8.1 20DB BANDWIDTH FOR HOPPING.....	18
8.2 MAXIMUM PEAK OUTPUT POWER	24
8.3 HOPPING CHANNEL SEPARATION.....	36
8.4 NUMBER OF HOPPING FREQUENCY USED	41
8.5 DWELL TIME ON EACH CHANNEL	44
8.6 DUTY CYCLE.....	58
8.7 CONDUCTED SPURIOUS EMISSION	63
8.8 RADIATED EMISSIONS	72
8.8.1 TRANSMITTER RADIATED SUPURIOUS EMSSIONS	72
8.8.2 WORST-CASE RADIATED EMISSION BELOW 1 GHZ.....	76
8.8.3 TRANSMITTER RADIATED EMISSION ABOVE 1 GHZ	79
8.8.4 RESTRICTED BAND EDGES	85
8.9 POWERLINE CONDUCTED EMISSIONS	95
APPENDIX I PHOTOGRPHS OF TEST SETUP	99
APPENDIX II PHOTOGRPHS OF EUT	104

1. TEST REPORT CERTIFICATION

Applicant	: Audio-Technica Corporation 2-46-1 Nishi-naruse, Machida, Tokyo 194-8666, JAPAN
Manufacturer	: Audio-Technica Corporation 2-46-1 Nishi-naruse, Machida, Tokyo 194-8666, JAPAN
Equipment Under Test	: AUTOMATIC WIRELESS TURNTABLE
Model Number	: AT-LP3XBT
Data Applies To	: N/A
Brand Name	: audio-technica
Date of Test	: February 17, 2022 ~ March 24, 2022

APPLICABLE STANDARD	
STANDARD	TEST RESULT
FCC Part 15 Subpart C AND ANSI C63.10: 2013	PASS
Statements of Conformity	
Determining compliance shall be based on the results of the compliance measurement, not taking into account measurement instrumentation uncertainty.	

We hereby certify that:

The above equipment was tested by Compliance Certification Services Inc. The test data, data evaluation, test procedures, and equipment configurations shown in this report were made in accordance with the procedures given in **ANSI C63.10: 2013** and the energy emitted by the sample EUT tested as described in this report is in compliance with the requirements of FCC Rules Part 15.207, 15.209, 15.247.

The test results of this report relate only to the tested sample EUT identified in this report.

Approved by:



John Chen
Supervisor

Report No.: TMTN2202000174NR

2. TEST RESULT SUMMARY

FCC Standard Section	Report Section	Test Item	Result
15.203	3	ANTENNA REQUIREMENT	Pass
15.247(a)(1)	8.1	20dB BANDWIDTH	Pass
15.247(b)(1)	8.2	MAXIMUM PEAK OUTPUT POWER	Pass
15.247(a)(1)	8.3	HOPPING CHANNEL SEPARATION	Pass
15.247(a)(1)(iii)	8.4	NUMBER OF HOPPING FREQUENCY USED	Pass
15.247(a)(1)(iii)	8.5	DWELL TIME	Pass
-	8.6	DUTY CYCLE	-
15.247(d)	8.7	CONDUCTED SPURIOUS EMISSION	Pass
15.247(d)	8.8	RADIATED EMISSIONS	Pass
15.207(a)	8.9	POWERLINE CONDUCTED EMISSIONS	Pass

3. EUT DESCRIPTION

3.1 DESCRIPTION OF EUT & POWER

Product	AUTOMATIC WIRELESS TURNTABLE
Model Number	AT-LP3XBT
Data Applies To	N/A
Brand Name	audio-technica
Identify Number	TMTN2202000174NR
Received Date	February 16, 2022
Reported Date	April 12, 2022
Frequency Range	2402MHz ~ 2480MHz
Transmit Peak Power	GFSK : 1.486dBm / 1.408mW 8DPSK: 1.263dBm / 1.338mW
Channel Spacing	1MHz
Transmit Data Rate	GFSK Mode : 1 Mbps 4/πDQPSK Mode : 2Mbps 8DPSK Mode : 3Mbps
Modulation Type	GFSK、π/4DQPSK、8DPSK
Number of Channels	79 Channels
EUT Power Supply	DC 12V (Powered by adapter)
Antenna Type	Manufacturer: Sunitec Type: Inverted-F Model: AT-LP3XBT Gain: 2.9 dBi
Firmware Version	V1.0
Software Version	V1.0

Power Adapter :

Manufacturer	Model No.	Power Input	Power Output
SHENZHEN FUJIA APPLIANCE CO.,LTD	FJ-SW1261200500DN	100-240V~ 50/60Hz 0.4A Max	12Vdc 0.5A 6.0W

Remark:

1. The sample selected for test was production product and was provided by manufacturer.
2. This submittal(s) (test report) is intended for **FCC ID: JFZLP3XBTA** filing to comply with Section 15.207, 15.209 and 15.247 of the FCC Part 15, Subpart C Rules.
3. For more details, please refer to the User's manual of the EUT.

4. DESCRIPTION OF TEST MODES

The EUT had been tested under operating condition.

There are three channels have been tested as following :

Channel	Frequency (MHz)
Low	2402
Middle	2441
High	2480

Radiated Emission Test (Below 1 GHz):

- Pre-Scan has been conducted to determine the worst-case mode from all possible combinations between available modulations, data rates and antenna ports (if EUT with antenna diversity architecture).
- Following channel(s) was (were) selected for the final test as listed below.

Normal Operation

Radiated Emission Test (Above 1 GHz):

- Pre-Scan has been conducted to determine the worst-case mode from all possible combinations between available modulations, data rates and antenna ports (if EUT with antenna diversity architecture).
- Following channel(s) was (were) selected for the final test as listed below.

Tested Channel	Modulation Technology	Modulation Type	Packet Type
Low, Mid, High	FHSS	GFSK	DH5
Low, Mid, High	FHSS	8-DPSK	3-DH5

Bandedge Measurement :

- Pre-Scan has been conducted to determine the worst-case mode from all possible combinations between available modulations, data rates and antenna ports (if EUT with antenna diversity architecture).
- Following channel(s) was (were) selected for the final test as listed below.

Tested Channel	Modulation Technology	Modulation Type	Packet Type
Low, High	FHSS	GFSK	DH5
Low, High	FHSS	8-DPSK	3-DH5

Antenna Port Conducted Measurement :

- Pre-Scan has been conducted to determine the worst-case mode from all possible combinations between available modulations, data rates and antenna ports (if EUT with antenna diversity architecture).
- Following channel(s) was (were) selected for the final test as listed below.

Tested Channel	Modulation Technology	Modulation Type	Packet Type
Low, Mid, High	FHSS	GFSK	DH5
Low, Mid, High	FHSS	8-DPSK	3-DH5



Report No.: TMTN2202000174NR

Page: 9 / 112
Rev.: 00

5. TEST METHODOLOGY

The tests documented in this report were performed in accordance with ANSI C63.10 : 2013 and FCC CFR 47 15.207, 15.209 and 15.247.

6. FACILITIES AND ACCREDITATIONS

6.1 FACILITIES

All measurement facilities used to collect the measurement data are located at

No.8, Jiucengling, Xinhua Dist., Tainan City 712, Taiwan (R.O.C.)

The sites are constructed in conformance with the requirements of ANSI C63.7, ANSI C63.10 and CISPR Publication 22.

6.2 EQUIPMENT

Radiated emissions are measured with one or more of the following types of linearly polarized antennas: tuned dipole, bi-conical, log periodic, bi-log, and/or ridged waveguide, horn. Spectrum analyzers with pre-selectors and quasi-peak detectors are used to perform radiated measurements.

Conducted emissions are measured with Line Impedance Stabilization Networks and EMI Test Receivers.

Calibrated wideband preamplifiers, coaxial cables, and coaxial attenuators are also used for making measurements.

All receiving equipment conforms to CISPR Publication 16-1, "Radio Interference Measuring Apparatus and Measurement Methods."

6.3 LABORATORY ACCREDITATIONS LISTINGS

The test facilities used to perform radiated and conducted emissions tests are accredited by Taiwan Accreditation Foundation for the specific scope of accreditation under Lab Code: 1109 to perform Electromagnetic Interference tests according to FCC PART 15 AND CISPR 22 requirements. No part of this report may be used to claim or imply product endorsement by TAF or any agency of the Government. In addition, the test facilities are listed with Federal Communications Commission (registration no: TW1109).

Report No.: TMTN2202000174NR

6.4 TABLE OF ACCREDITATIONS AND LISTINGS

Our laboratories are accredited and approved by the following approval agencies according to ISO/IEC 17025.

Taiwan	TAF
---------------	-----

The measuring facility of laboratories has been authorized or registered by the following approval agencies.

Canada	Industry Canada (ISED#: 2324H)
Germany	TUV NORD
Taiwan	BSMI
USA	FCC

Report No.: TMTN2202000174NR

6.5 MEASUREMENT EQUIPMENT USED

For §8.8.2~8.8.3

Chamber 966 Room (Radiation Test)					
Name of Equipment	Manufacturer	Model	Serial Number	Calibration Date	Calibration Due
Active Loop Antenna	ETS-LINDREN	6502	8905-2356	09/06/2021	09/05/2023
Attenuator	MCL	BW-S15W5	0535	01/28/2022	01/27/2023
Band Reject Filter	MICRO-TRONICS	HPM13525	006	01/28/2022	01/27/2023
Band Reject Filter	MICRO-TRONICS	HP50107-01	001	01/28/2022	01/27/2023
Bilog Antenna With 6dB Attenuator	SUNOL SCIENCES & EMCI	JB1 & N-6-06	A070506-1 & AT-N0681	10/07/2021	10/06/2022
Cable	Suhner	SUCOFLEX104PE A	20520/4PEA&O6	01/28/2022	01/27/2023
Double Ridged Guide Horn Antenna	ETS-LINDGREN	3116	00078900	03/30/2021	03/29/2022
EMI Test Receiver	R&S	ESCI 7	100856	07/01/2021	06/30/2022
EXA Spectrum Analyzer	KEYSIGHT	N9010A	MY54430216	07/22/2021	07/21/2022
Horn Antenna	Com-Power	AH-118	071032	05/04/2021	05/03/2022
Notch Filter	MICRO-TRONICS	BRM50702-01	018	01/28/2022	01/27/2023
Pre-Amplifier	EMCI	EMC012645	980098	01/28/2022	01/27/2023
Pre-Amplifier	HP	8447F	2443A01683	01/18/2022	01/17/2023
Pre-Amplifier	Com-Power	PAM-840A	461378	07/05/2021	07/04/2022
Type N coaxial cable	Suhner	CHA9513	6	01/18/2022	01/17/2023
Software	Excel(ccs-o6-2020 v1.1) , e3(v6.101222)				

For §8.1~8.7 8.8.4

Chamber 966 Room (Conducted Test)					
Name of Equipment	Manufacturer	Model	Serial Number	Calibration Date	Calibration Due
EXA Spectrum Analyzer	KEYSIGHT	N9010A	MY54430216	07/22/2021	07/21/2022
Power Meter	Anritsu	ML2487A	6K00003888	05/18/2021	05/17/2022
Power Sensor	Anritsu	MA2491A	033265	05/18/2021	05/17/2022
SMA Cable+10dB Attenuator	CCS	SMA+10dB ATT	SMA/10dB	01/28/2022	01/27/2023
Software	Excel(ccs-o6-2020 v1.1)				

For §8.9

Conducted Emission room #1					
Name of Equipment	Manufacturer	Model	Serial Number	Calibration Date	Calibration Due
BNC Coaxial Cable	CCS	BNC50	11	01/20/2022	01/19/2023
EMI Test Receiver	R&S	ESCS 30	100348	02/25/2021	02/24/2022
LISN	FCC	FCC-LISN-50-32-2	08009	06/29/2021	06/28/2022
LISN	SCHWARZBECK	NNLK8130	8130124	01/14/2022	01/13/2023
Pulse Limiter	R&S	ESH3-Z2	100116	01/20/2022	01/19/2023
Test S/W	e3(6.101222)				

Report No.: TMTN2202000174NR

6.6 MEASURING INSTRUMENT CALIBRATION

The measuring equipment utilized to perform the tests documented in this report has been calibrated in accordance with the manufacturer's recommendations, and is traceable to recognized national standards.

6.7 MEASUREMENT UNCERTAINTY

Where relevant, the following measurement uncertainty levels have been estimated for tests performed on the apparatus:

PARAMETER	UNCERTAINTY
Radiated Emission, 30 to 200 MHz Test Site : OATS-6	$\pm 3.3456\text{dB}$
Radiated Emission, 200 to 1000 MHz Test Site : OATS-6	$\pm 2.6828\text{dB}$
Radiated Emission, 1 to 8 GHz	$\pm 2.6485\text{dB}$
Radiated Emission, 8 to 18 GHz	$\pm 2.6852\text{dB}$
Radiated Emission, 18 to 26.5 GHz	$\pm 2.6485\text{dB}$
Radiated Emission, 26 to 40 GHz	$\pm 3.0295\text{dB}$
Power Line Conducted Emission	$\pm 1.91\text{dB}$
Band Width	136.49kHz
Peak Output Power MU	$\pm 1.904\text{dB}$
Band Edge MU	$\pm 0.302\text{dBuV}$
Channel Separation MU	361.69Hz
Duty Cycle MU	0.064ms
Frequency Stability MU	0.223kHz

This measurement uncertainty is confidence of approximately 95%, k=2

Report No.: TMTN2202000174NR

7. SETUP OF EQUIPMENT UNDER TEST

7.1 SETUP CONFIGURATION OF EUT

EMI

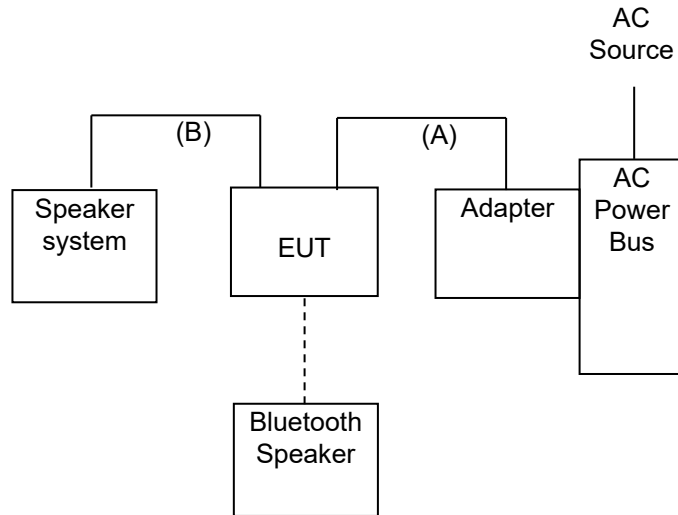

RF

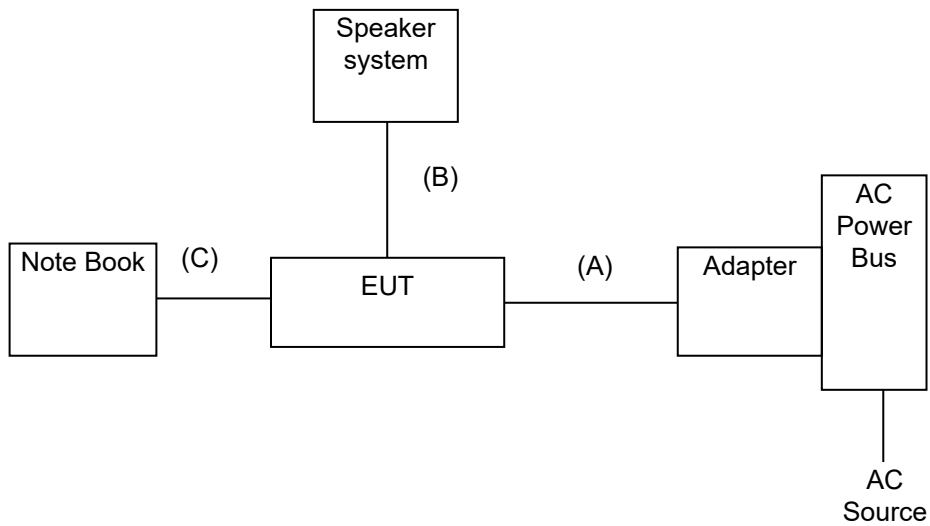

7.2 SUPPORT EQUIPMENT

For EMI test

No.	Product	Manufacturer	Model No.	Certify No.	Signal cable
1	Speaker System	T.C.SATR	TCS2285	DOC	N/A
2	Bluetooth Speaker	PHILIPS	S1505	N/A	N/A

No.	Signal cable description	
A	DC Cable	Unshielded, 1.6m 1 pcs. with 1 core
B	Audio	Shielded, 1.0m 1 pcs.

For RF test

No.	Product	Manufacturer	Model No.	Certify No.	Power cable
1	Speaker System	T.C.SATR	TCS2285	DOC	Unshielded, 1.5m
2	Note Book	Acer	Z5WE1	N/A	Unshielded, 1.8m

No.	Signal cable description	
A	DC Power	Unshielded, 1.5m 1 pcs. with 1 core.
B	Audio	Shielded, 2.2m 1 pcs.
C	USB	Shielded, 1.5m 1 pcs.

Note:

- 1) All the equipment/cables were placed in the worst-case configuration to maximize the emission during the test.
- 2) Grounding was established in accordance with the manufacturer's requirements and conditions for the intended use.
- 3) shd. = shielded; unshd. = unshielded

EUT OPERATING CONDITION**RF Setup**

1. Set up all computers like the setup diagram.
2. The "Blue Test 3 V3.3.9.1137" software was used for testing
3. Choose Transport "DEBUG" and Device "USB DBG(100)"

BT1.0、 3.0**TX Mode:**

PACKET TX

Channel 1~5: 0,39,78

GFSK(DH1):

Packet Type:DH1 > Packet Length 27

Power(0-9) : 6

GFSK(DH3):

Packet Type:DH3 > Packet Length 183

Power(0-9) : 6

GFSK(DH5):

Packet Type:DH5 > Packet Length 339

Power(0-9) : 6

8-DPSK(3DH1):

Packet Type:3DH1 > Packet Length 83

Power(0-9) : 6

8-DPSK(3DH3):

Packet Type:3DH3 > Packet Length 552

Power(0-9) : 6

8-DPSK(3DH5):

Packet Type:3DH5 > Packet Length 1021

Power(0-9) : 6

RX Mode:

PACKET TX

BT4.0、 5.0**TX Mode:**

BLE TEST TX

Channel : 0,20,39 (0-39)

Length : 37

Bit pattern : Pseudo-rdm 9

PHY : 1M (2M)

Report No.: TMTN2202000174NR

RX Mode:

BLE TEST RX

Channel : 0 (0-39)

PHY : 1M (2M)

4. All of the function are under run.
5. Start test.

8. APPLICABLE LIMITS AND TEST RESULTS

8.1 20dB BANDWIDTH FOR HOPPING

LIMIT

None; for reporting purposes only.

TEST SETUP

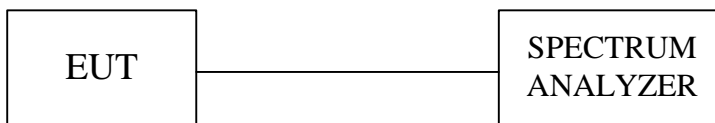

TEST PROCEDURE

- a) Set RBW = 100 kHz.
- b) Set the video bandwidth (VBW) $\geq 3 \times$ RBW.
- c) Detector = Peak.
- d) Trace mode = max hold.
- e) Sweep = auto couple.
- f) Allow the trace to stabilize.
- g) Measure the maximum width of the emission that is constrained by the frequencies associated with the two outermost amplitude points (upper and lower frequencies) that are attenuated by 20 dB relative to the maximum level measured in the fundamental emission.

TEST RESULTS

Model Name	AT-LP3XBT	Test By	Peter Chu
Temp & Humidity	25.5°C, 54%	Test Date	3/24/2022

Modulation Type: GFSK / DH5

Channel	Channel Frequency (MHz)	20dB Bandwidth (kHz)	Two-third of 20dB Bandwidth (MHz)	Pass / Fail
Low	2402	1119.00	0.75	PASS
Middle	2441	1119.00	0.75	PASS
High	2480	1121.00	0.75	PASS

Modulation Type: 8-DPSK / 3-DH5

Channel	Channel Frequency (MHz)	20dB Bandwidth (kHz)	Two-third of 20dB Bandwidth (MHz)	Pass / Fail
Low	2402	1395.00	0.93	PASS
Middle	2441	1397.00	0.93	PASS
High	2480	1399.00	0.93	PASS

20dB BANDWIDTH

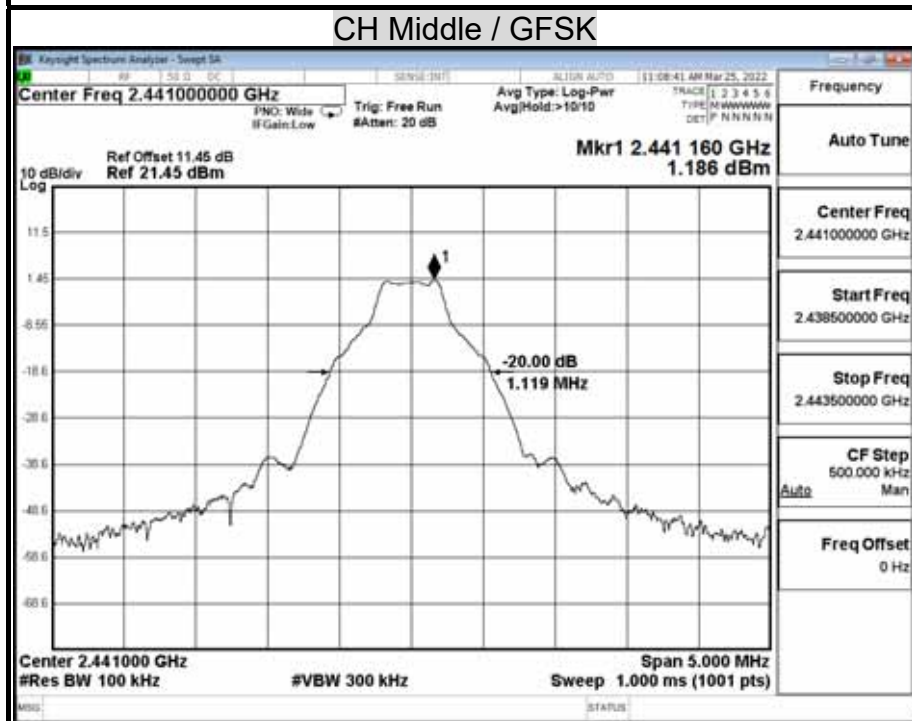
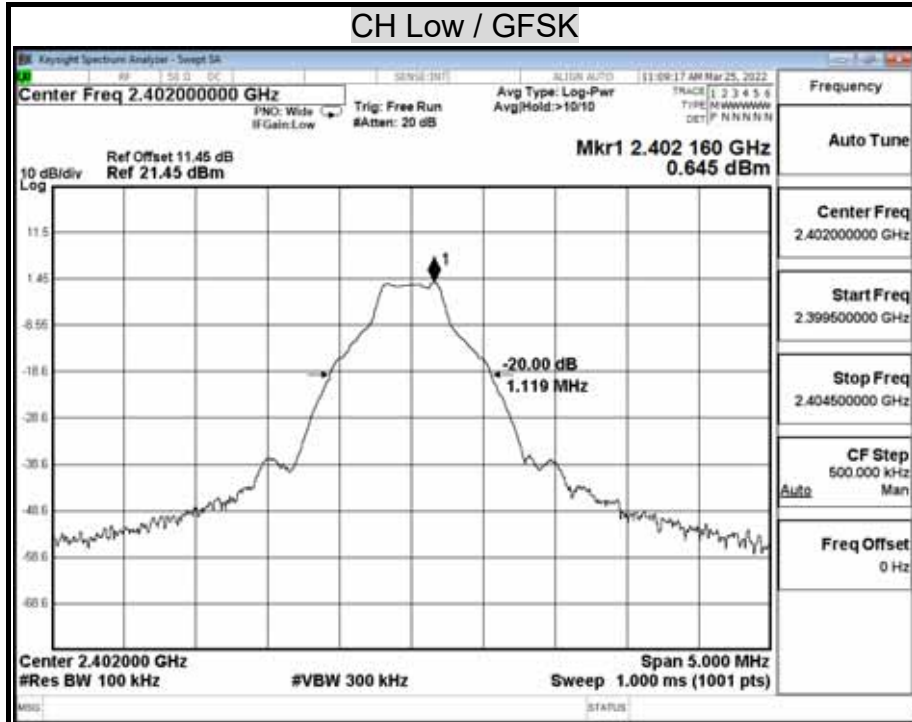

Report No.: TMTN2202000174NR

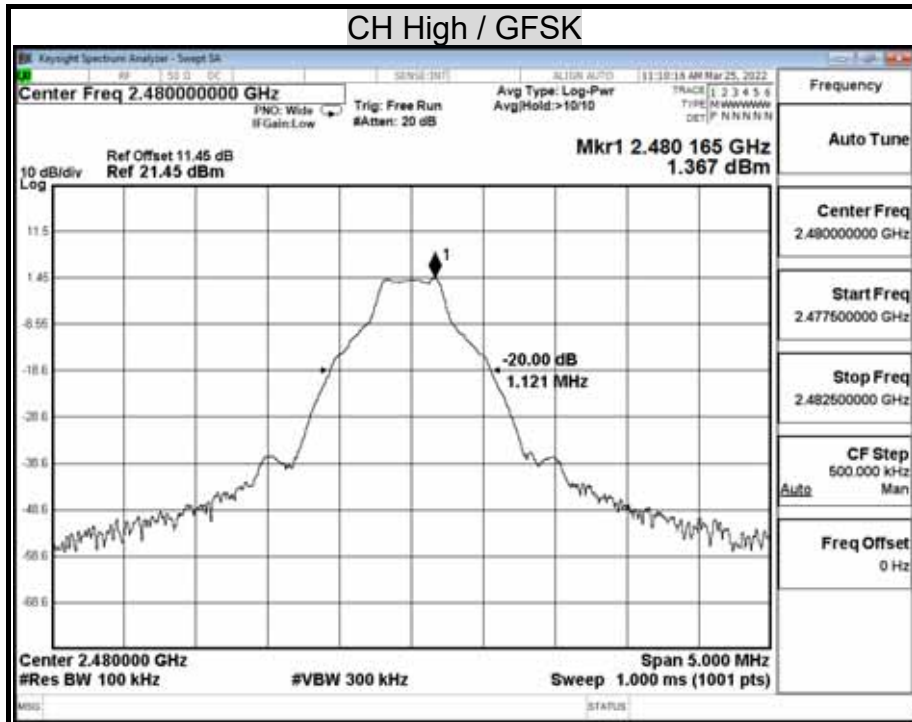

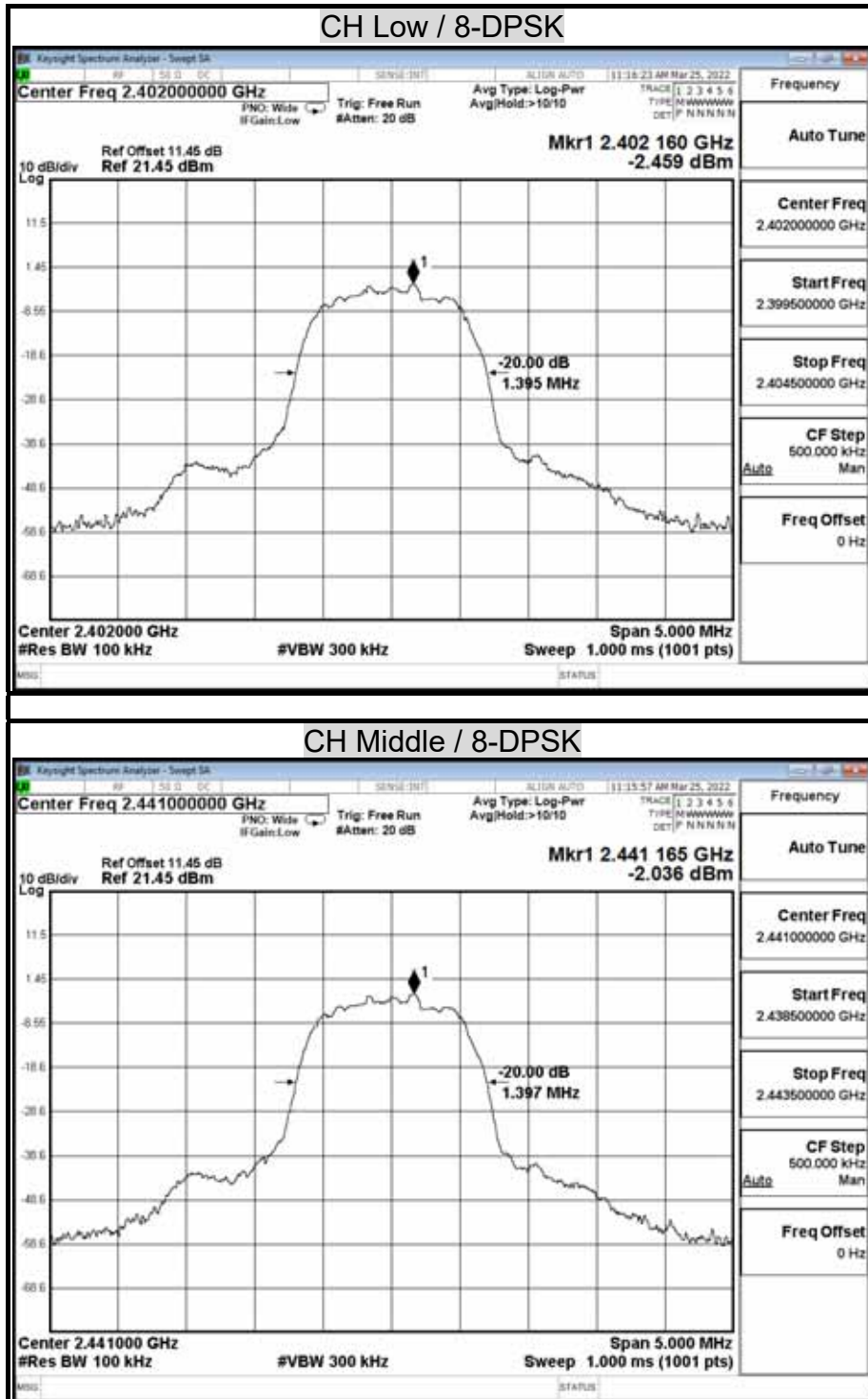

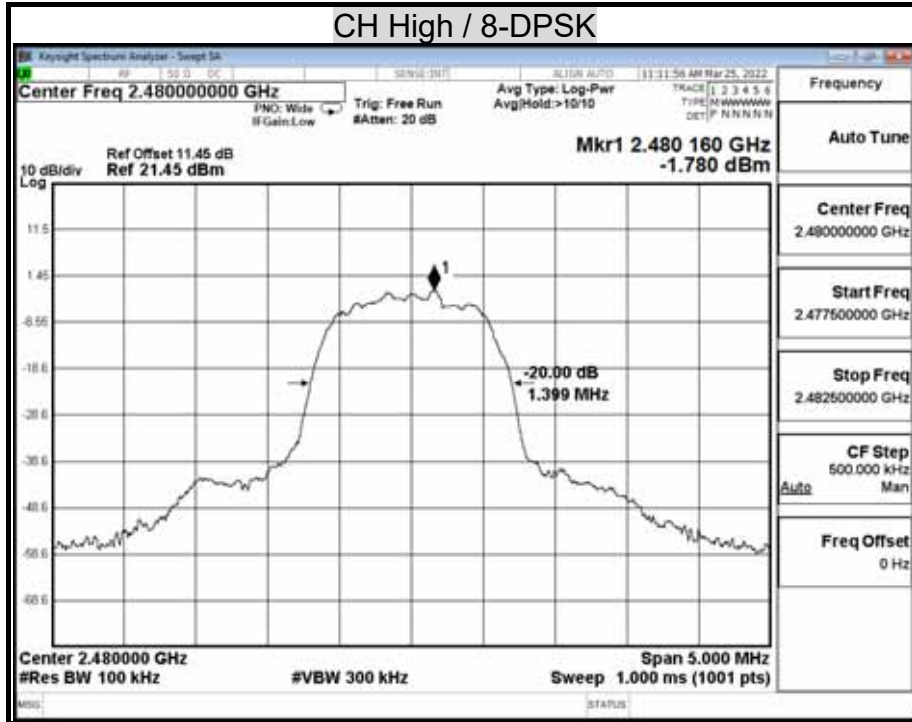

8.2 MAXIMUM PEAK OUTPUT POWER

LIMIT

§15.247(b)(1) For frequency hopping systems operating in the 2400-2483.5 MHz band employing at least 75 non-overlapping hopping channels, and all frequency hopping systems in the 5725-5850 MHz band: 1 watt. For all other frequency hopping systems in the 2400-2483.5 MHz band: 0.125 watts.

Test Configuration

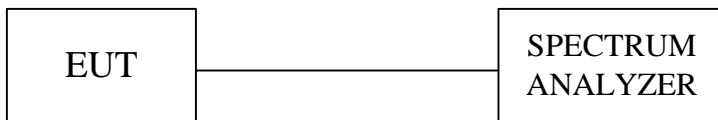

TEST PROCEDURE

The RF power output was measured with a Spectrum Analyzer connected to the RF Antenna connector (conducted measurement) while EUT was operating in transmit mode at the appropriate center frequency.

Peak Power set:

1. Set the RBW = \geq DTS bandwidth.
2. Set the VBW \geq [3 \times RBW].
3. Set the span \geq [1.5 \times DTS bandwidth].
4. Detector = peak.
5. Sweep time = auto couple.
6. Trace mode = max hold.
7. Allow trace to fully stabilize.
8. Use the instrument's band/channel power measurement function with the band limits set equal to the DTS bandwidth edges (for some instruments, this may require a manual override to select the peak detector). If the instrument does not have a band power function, then sum the spectrum levels (in linear power units) at intervals equal to the RBW extending across the DTS channel bandwidth.

Average power set:

1. Measure the duty cycle D of the transmitter output signal
2. Set span to at least 1.5 times the OBW.
3. Set the RBW = \geq DTS bandwidth
4. Set VBW $\geq [3 \times \text{RBW}]$.
5. Number of points in sweep $\geq [2 \times \text{span} / \text{RBW}]$. (This gives bin-to-bin spacing $\leq \text{RBW} / 2$, so that narrowband signals are not lost between frequency bins.)
6. Manually set sweep time $\geq [10 \times (\text{number of points in sweep}) \times (\text{total ON/OFF period of the transmitted signal})]$.
7. Set detector = RMS (power averaging).
8. Perform a single sweep.
9. Compute power by integrating the spectrum across the OBW of the signal using the instrument's band power measurement function with band limits set equal to the OBW band edges. If the instrument does not have a band power function, then sum the spectrum levels (in power units) at intervals equal to the RBW extending across the entire OBW.
10. Add $[10 \log (1 / D)]$, where D is the duty cycle, to the measured power to compute the average power during the actual transmission times.

TEST RESULTS

Model Name	AT-LP3XBT	Test By	Peter Chu
Temp & Humidity	25.5°C, 54%	Test Date	3/24/2022

Modulation Type: GFSK / DH5

Channel	Channel Frequency (MHz)	Peak Power Output (dBm)	Peak Power Output (mW)	Limit (mW)	Result
Low	2402	0.44	1.10662	125	PASS
Mid	2441	0.98	1.25401		PASS
High	2480	1.49	1.40799		PASS

Modulation Type: 8-DPSK / 3-DH5

Channel	Channel Frequency (MHz)	Peak Power Output (dBm)	Peak Power Output (mW)	Limit (mW)	Result
Low	2402	0.31	1.07300	125	PASS
Mid	2441	0.94	1.24079		PASS
High	2480	1.26	1.33752		PASS

Average Power Data

Modulation Type: GFSK / DH5

Channel	Channel Frequency (MHz)	Measure Power (dBm)	10 log (1 / D)	Average Power (dBm)
Low	2402	-0.96	1.11633	0.16
Middle	2441	-0.393	1.11633	0.72
High	2480	0.027	1.11633	1.14

Modulation Type: 8-DPSK / 3-DH5

Channel	Channel Frequency (MHz)	Measure Power (dBm)	10 log (1 / D)	Average Power (dBm)
Low	2402	-4.273	1.11633	-3.16
Middle	2441	-3.707	1.11633	-2.59
High	2480	-3.269	1.11633	-2.15

MAXIMUM PEAK OUTPUT POWER

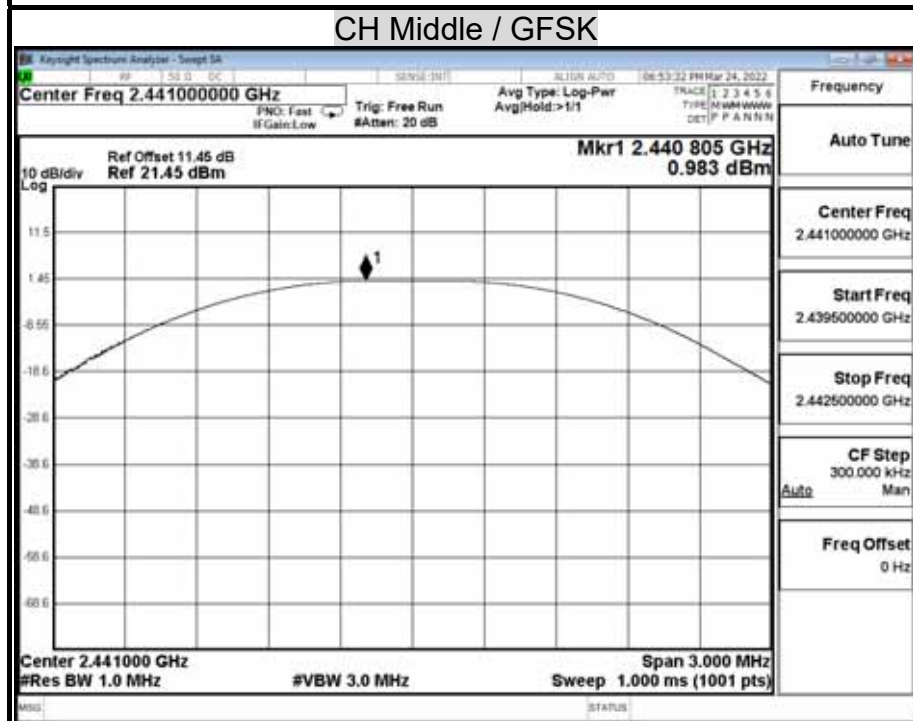
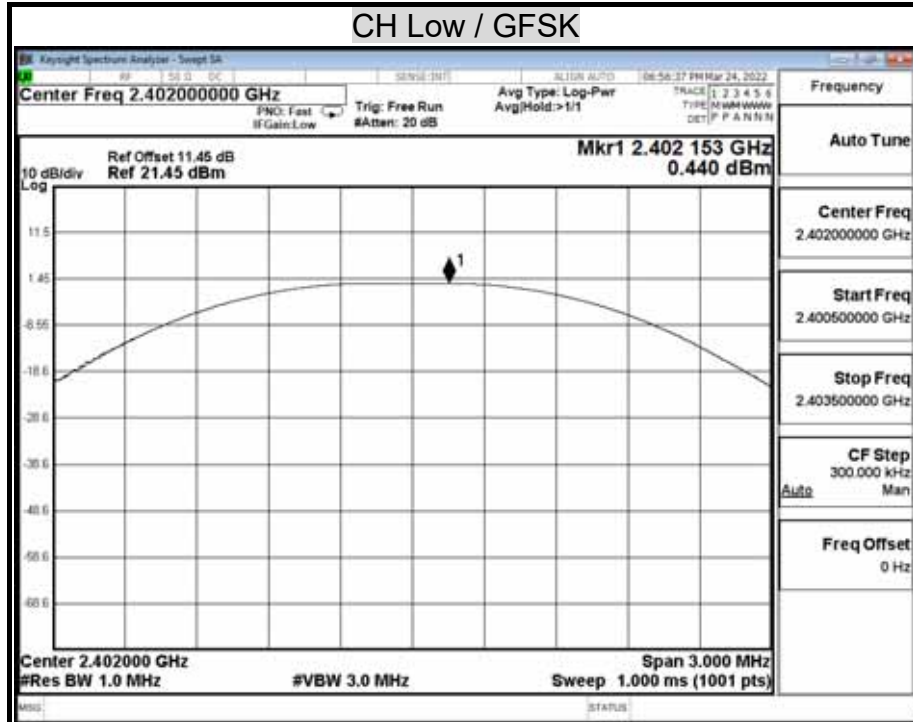

Report No.: TMTN2202000174NR

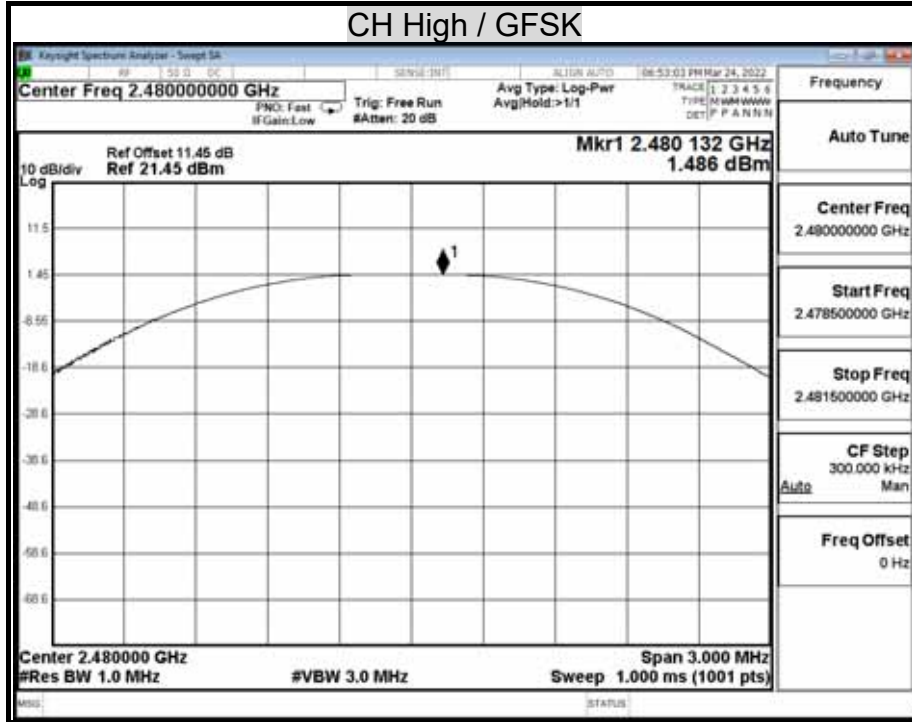

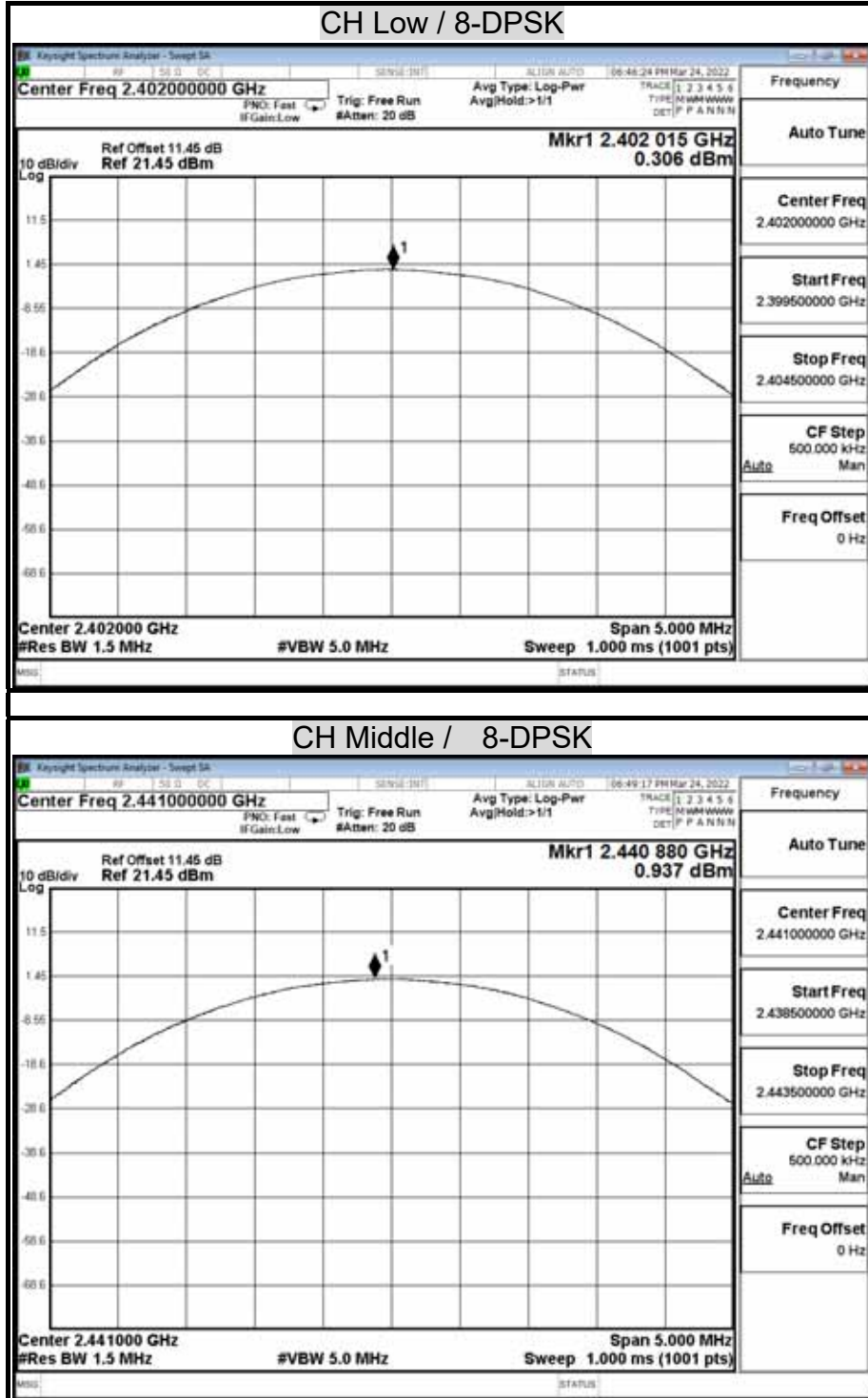

Report No.: TMTN2202000174NR

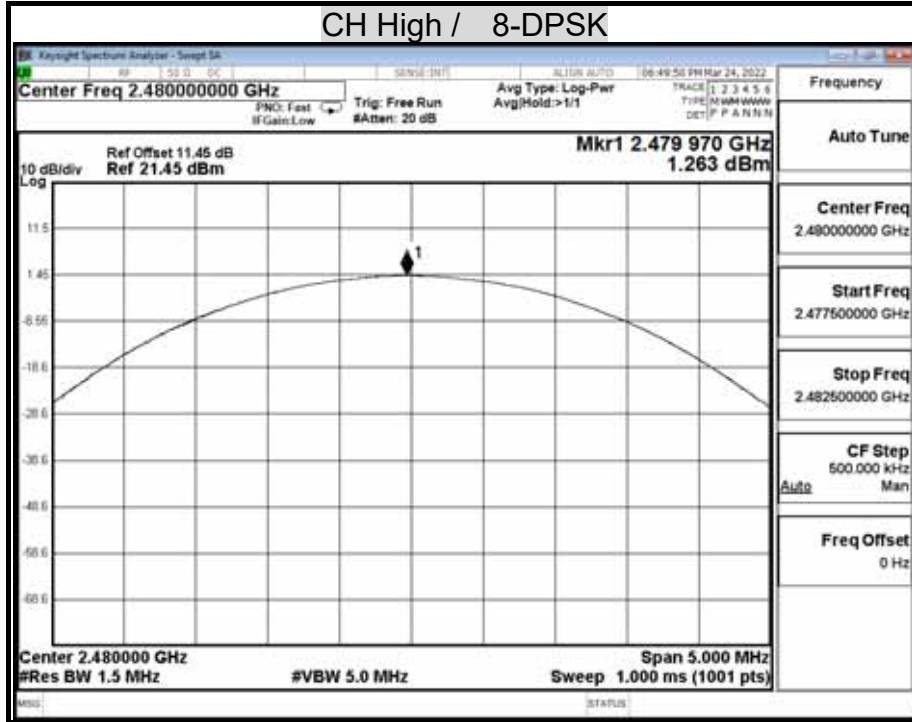

AVERAGE POWER

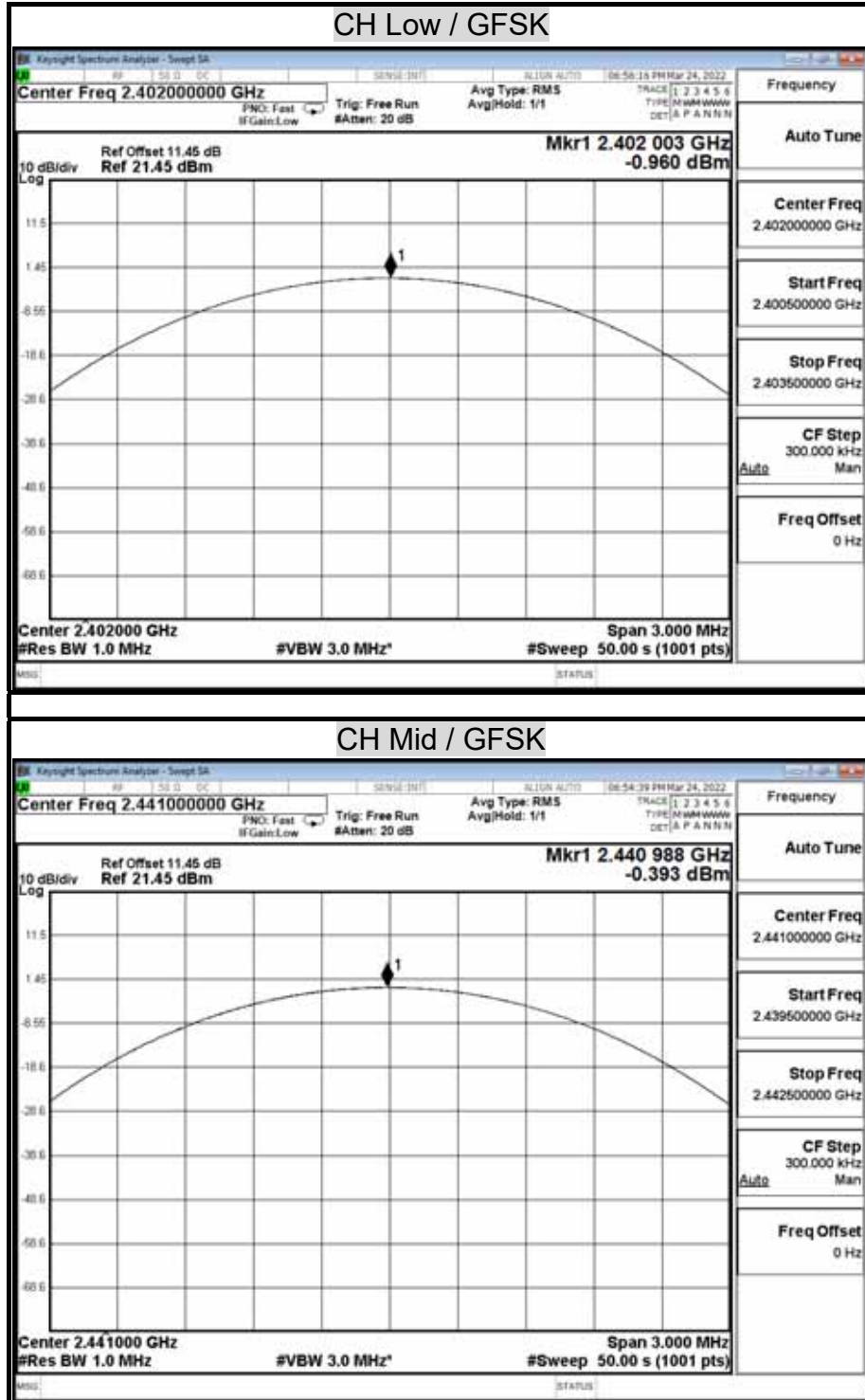

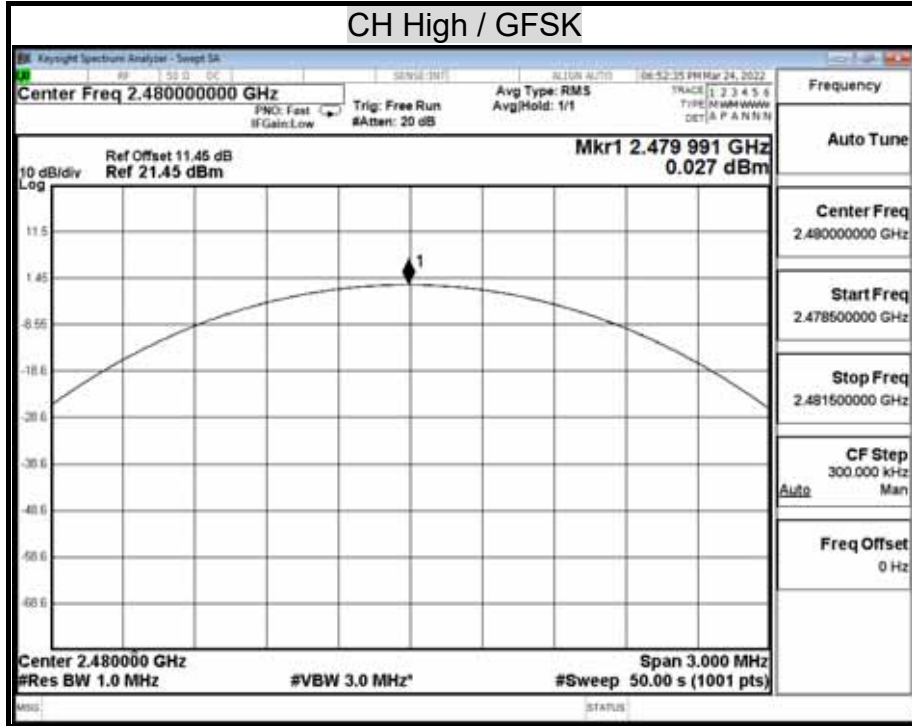

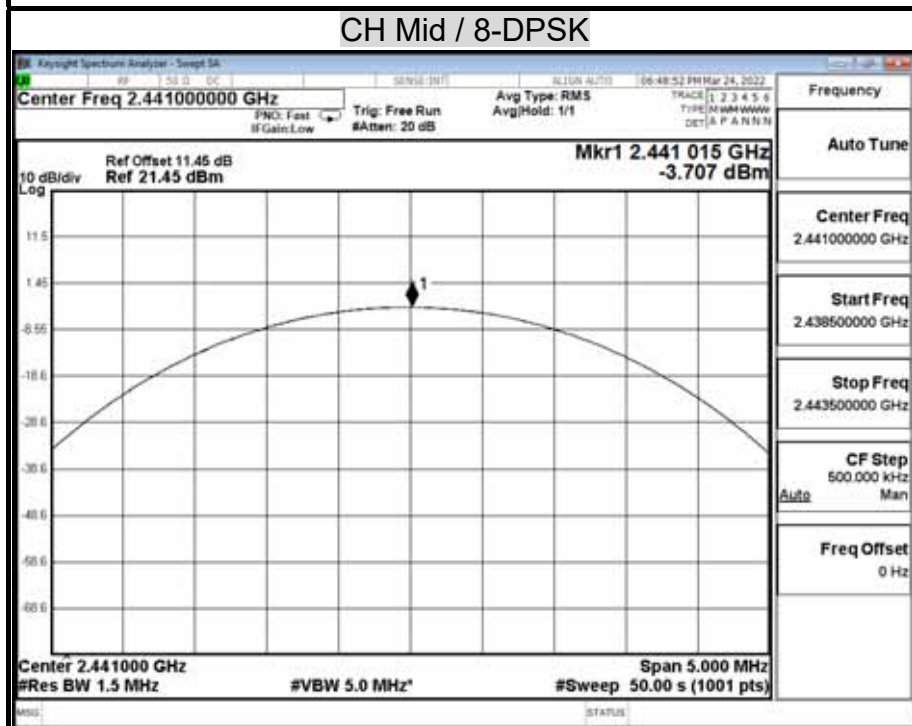
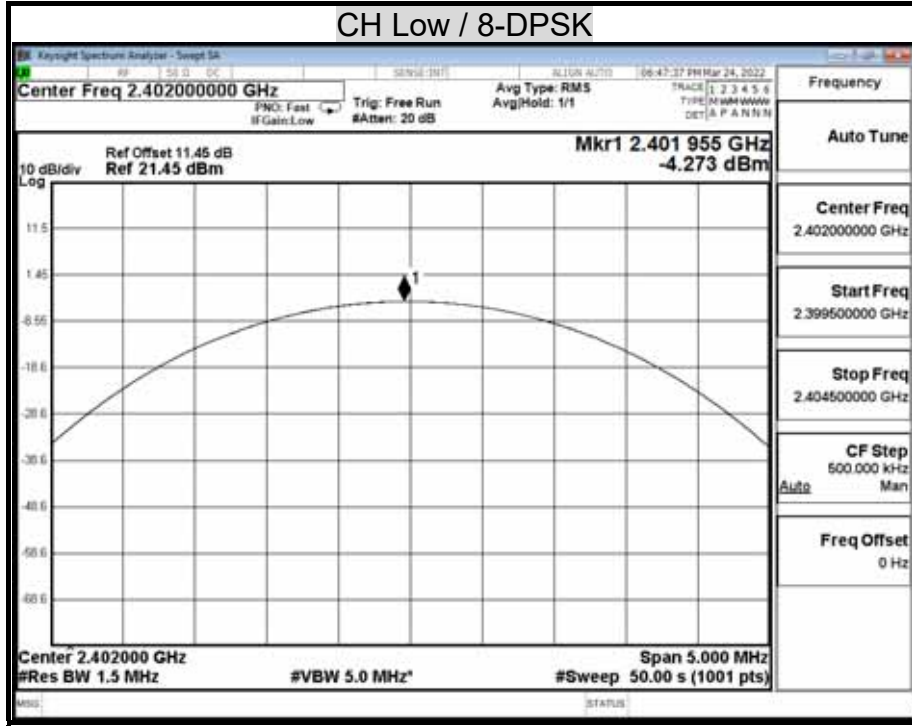

Report No.: TMTN2202000174NR

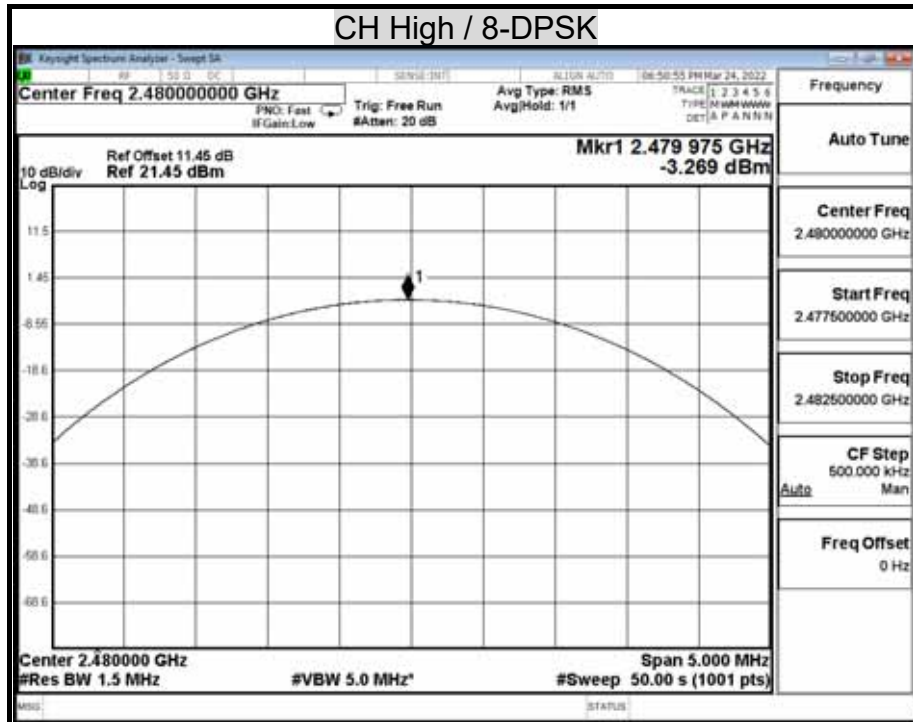

8.3 HOPPING CHANNEL SEPARATION

LIMIT

§15.247(a)(1) Frequency hopping systems shall have hopping channel carrier frequencies separated by a minimum of 25 kHz or the 20 dB bandwidth of the hopping channel, whichever is greater. Alternatively, frequency hopping systems operating in the 2400-2483.5 MHz band may have hopping channel carrier frequencies that are separated by 25 kHz or two-thirds of the 20 dB bandwidth of the hopping channel, whichever is greater, provided the systems operate with an output power no greater than 125 mW. The system shall hop to channel frequencies that are selected at the system hopping rate from a pseudo randomly ordered list of hopping frequencies. Each frequency must be used equally on the average by each transmitter. The system receivers shall have input bandwidths that match the hopping channel bandwidths of their corresponding transmitters and shall shift frequencies in synchronization with the transmitted signals.

TEST SETUP

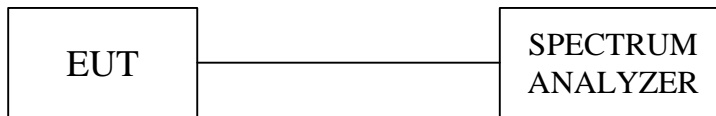

TEST PROCEDURE

1. Check the calibration of the measuring instrument using either an internal calibrator or a known signal from an external generator.
2. Position the EUT as shown in test setup without connection to measurement instrument. Turn on the EUT and connect it to measurement instrument. Then set it to any one convenient frequency within its operating range.
3. By using the MaxHold function record the separation of adjacent channels.
4. Measure the frequency difference of these two adjacent channels by spectrum analyzer MARK function. And then plot the result on spectrum analyzer screen.
5. Repeat above procedures until all frequencies measured were complete.

Report No.: TMTN2202000174NR

TEST RESULTS

Refer to section 8.1, 20dB bandwidth measurement, the measured channel separation should be greater than two-third of 20dB bandwidth or Minimum bandwidth.

Model Name	AT-LP3XBT	Test By	Peter Chu
Temp & Humidity	25.5°C, 54%	Test Date	3/24/2022

Modulation Type: GFSK / DH5

Channel	Adjacent Hopping Channel Separation (MHz)	Two -third of 20dB bandwidth (MHz)	Minimum Bandwidth (kHz)	Result
2402MHz	1.00	0.75	25 kHz	PASS
2441MHz	1.00	0.75	25 kHz	PASS
2480MHz	1.00	0.75	25 kHz	PASS

Modulation Type: 8-DPSK / 3-DH5

Channel	Adjacent Hopping Channel Separation (MHz)	Two -third of 20dB bandwidth (kHz)	Minimum Bandwidth (kHz)	Result
2402MHz	1.00	0.93	25 kHz	PASS
2441MHz	1.00	0.93	25 kHz	PASS
2480MHz	1.00	0.93	25 kHz	PASS

Report No.: TMTN2202000174NR

HOPPING CHANNEL SEPARATION

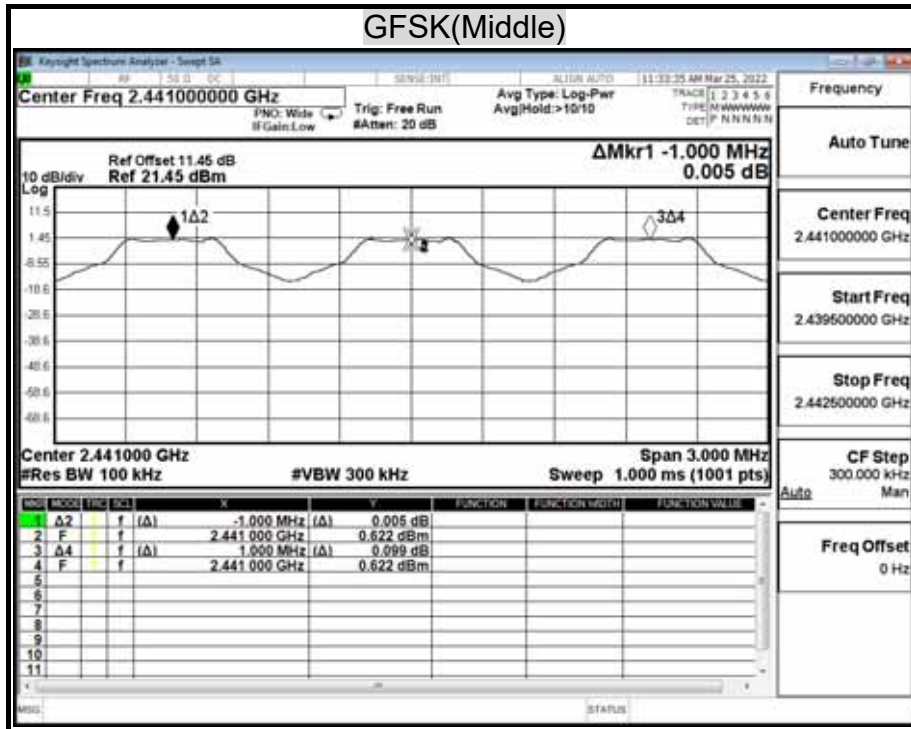
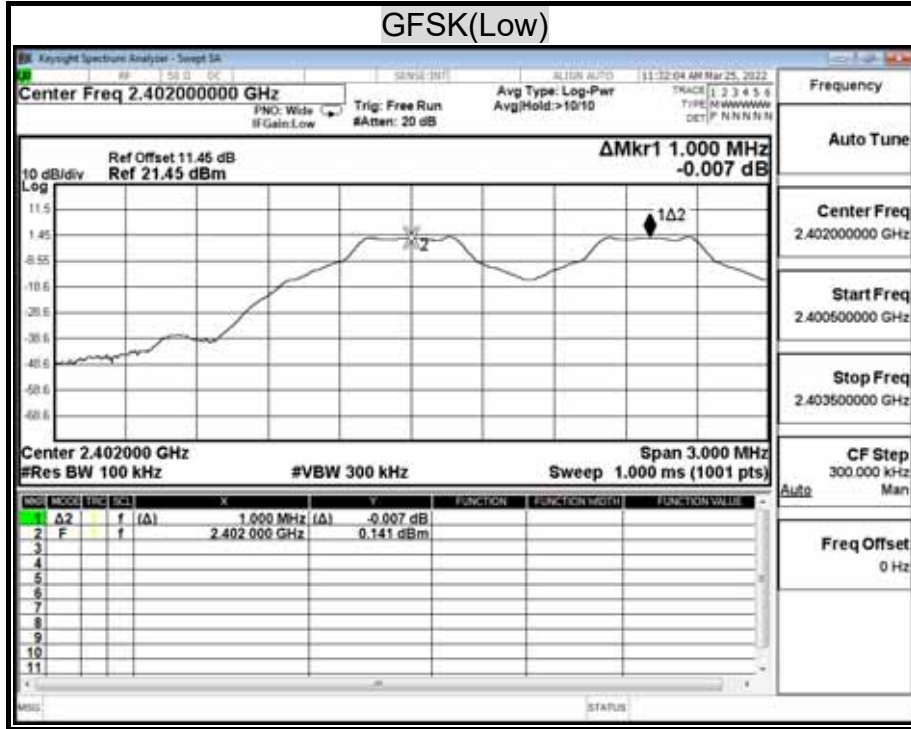

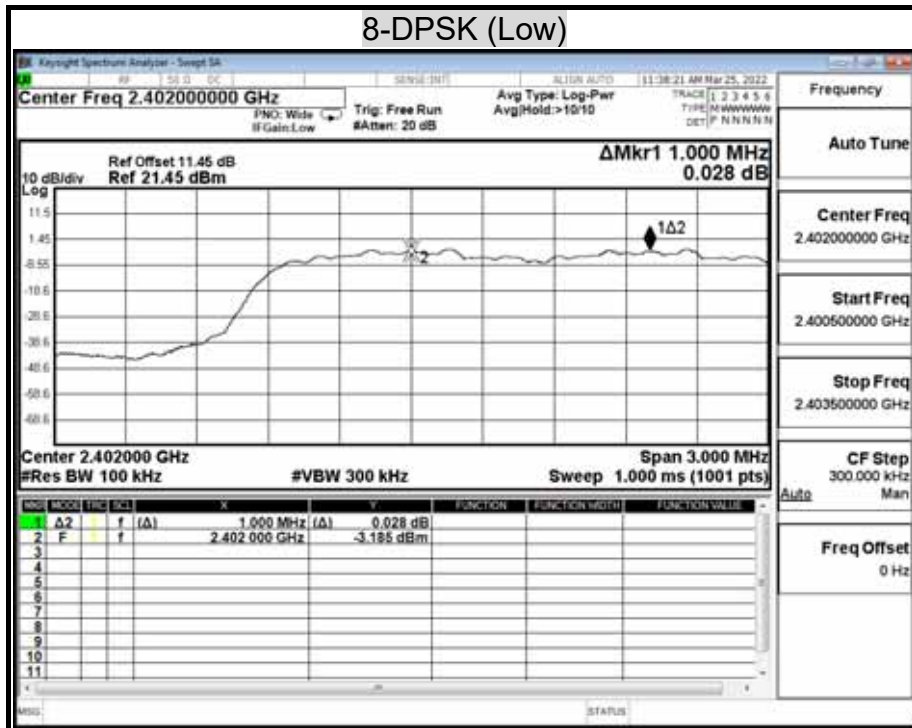
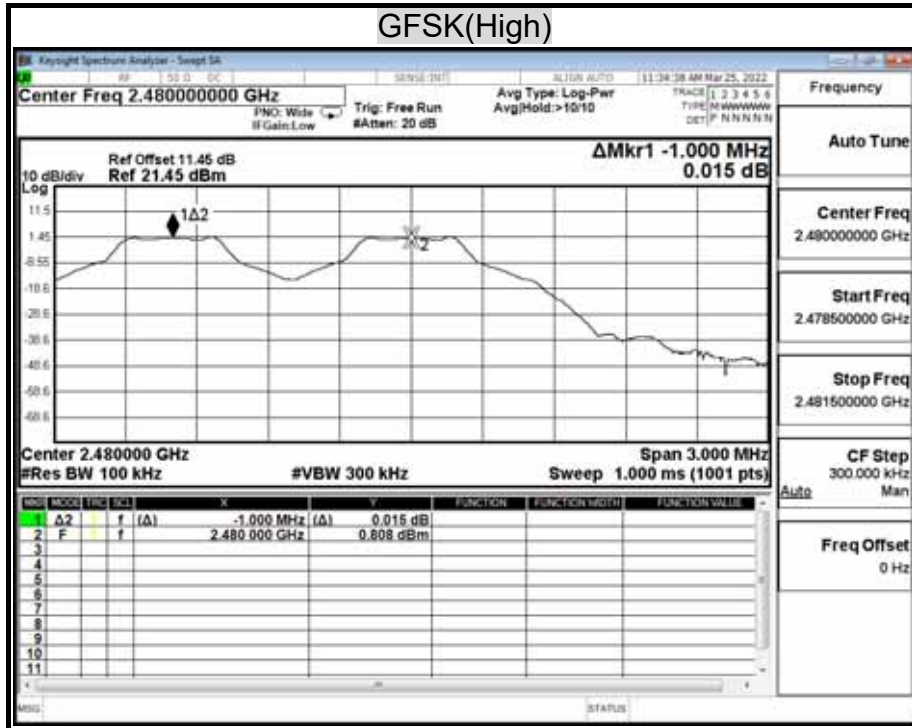

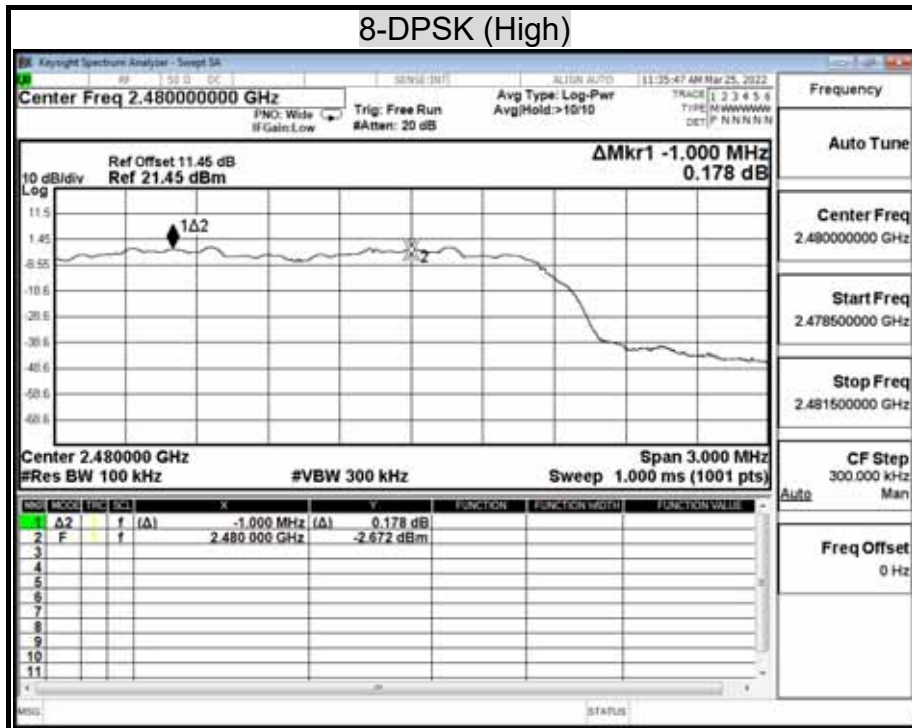
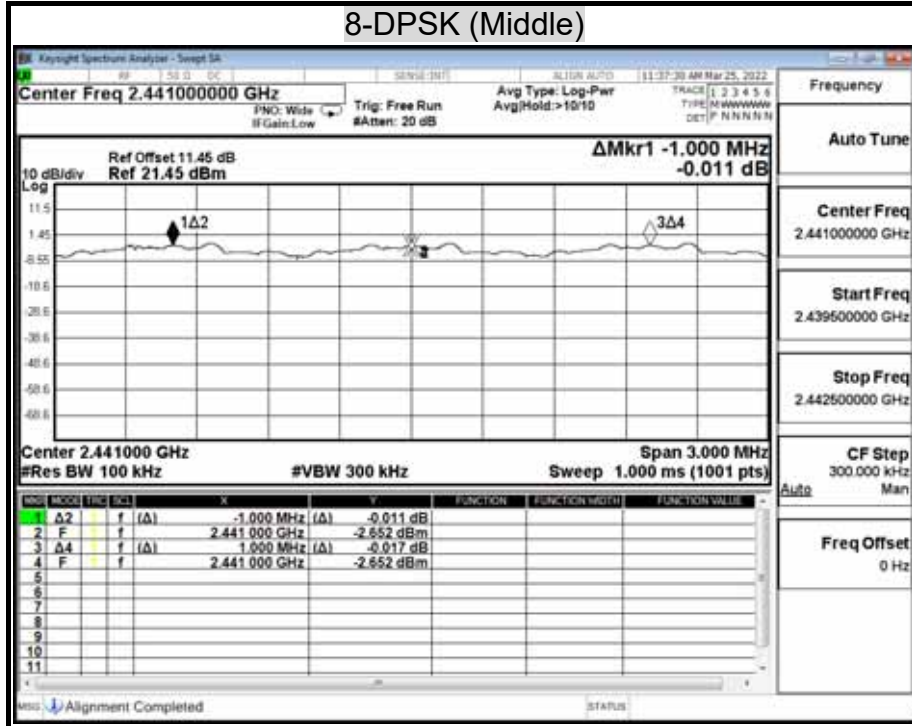

8.4 NUMBER OF HOPPING FREQUENCY USED

LIMIT

§15.247(a)(1)(iii) For frequency hopping systems in the 2400-2483.5 MHz band shall use at least 15 channels.

TEST SETUP

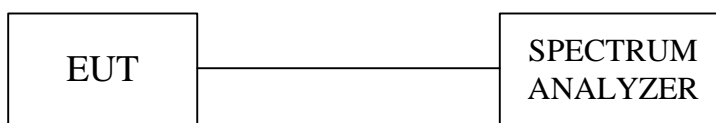

TEST PROCEDURE

- 1 Check the calibration of the measuring instrument (spectrum analyzer) using either an internal calibrator or a known signal from an external generator.
- 2 Position the EUT as shown in test setup without connection to measurement instrument. Turn on the EUT and connect its antenna terminal to measurement instrument via a low loss cable. Then set it to any one measured frequency within its operating range and make sure the instrument is operated in its linear range.
- 3 Set the spectrum analyzer on MaxHold Mode, and then keep the EUT in hopping mode. Record all the signals from each channel until each one has been recorded.
- 4 Set the spectrum analyzer on View mode and then plot the result on spectrum analyzer screen.
- 5 Repeat above procedures until all frequencies measured were complete.

TEST RESULTS

Model Name	AT-LP3XBT	Test By	Peter Chu
Temp & Humidity	25.5°C, 54%	Test Date	3/24/2022

Modulation Type: GFSK / DH5

Result(No.of CH)	Limit(No.of CH)	Result
79	>15	PASS

Modulation Type: 8-DPSK / 3-DH5

Result(No.of CH)	Limit(No.of CH)	Result
79	>15	PASS

NUMBER OF HOPPING FREQUENCY USED

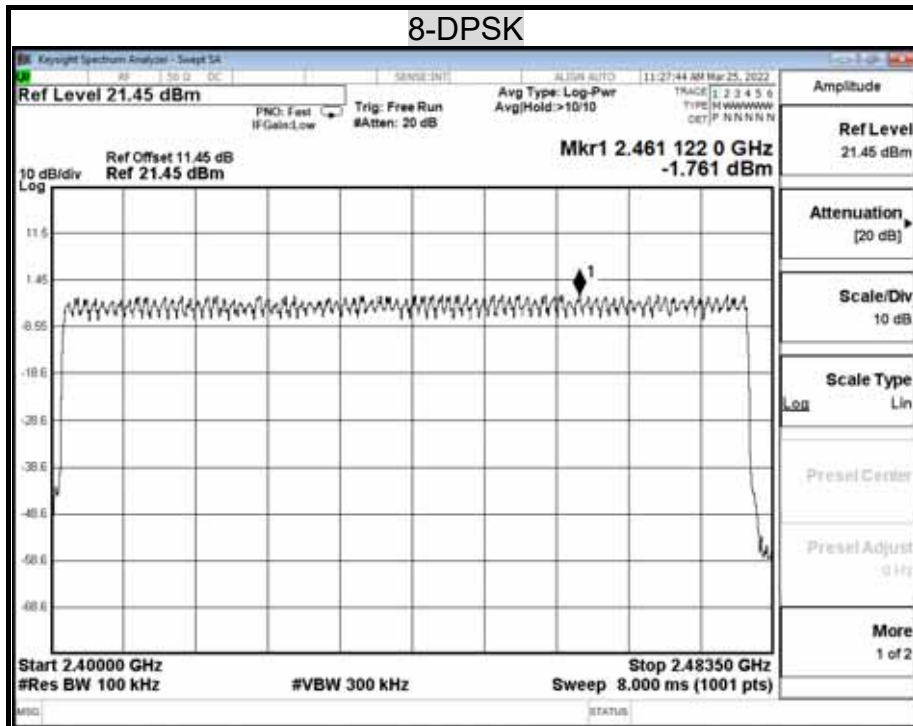
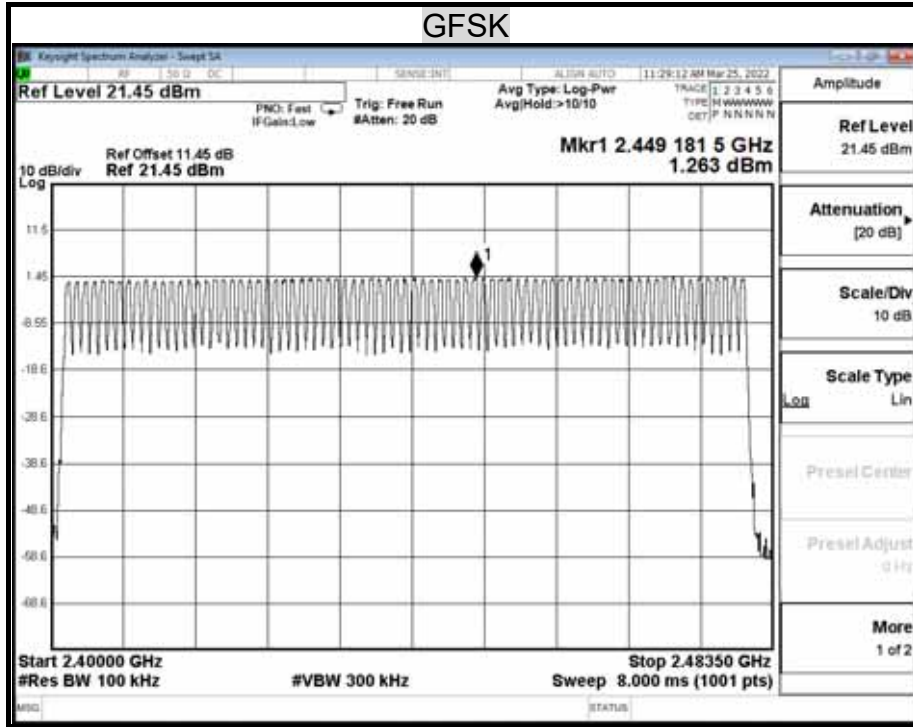

8.5 DWELL TIME ON EACH CHANNEL

LIMIT

§15.247(a)(1)(iii) For frequency hopping system operating in the 2400-2483.5MHz band, the average time of occupancy on any frequency shall not be greater than 0.4 second within a 31.6 second period.

TEST SETUP

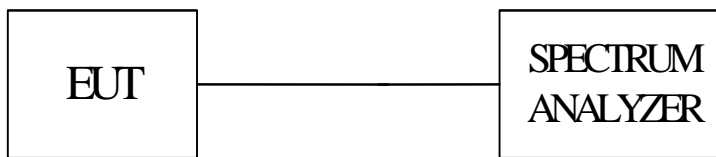

TEST PROCEDURE

1. Check the calibration of the measuring instrument using either an internal calibrator or a known signal from an external generator.
2. Position the EUT as shown in test setup without connection to measurement instrument. Turn on the EUT and connect its antenna terminal to measurement instrument via a low loss cable. Then set it to any one measured frequency within its operating range and make sure the instrument is operated in its linear range.
3. Adjust the center frequency of spectrum analyzer on any frequency be measured and set spectrum analyzer to zero span mode. And then, set RBW and VBW of spectrum analyzer to proper value.
4. Measure the time duration of one transmission on the measured frequency. And then plot the result with time difference of this time duration.
5. Repeat above procedures until all frequencies measured were complete.
6. The Bluetooth Headset has 3 type of payload, DH1, DH3, DH5. The hopping rate is 1600 per second. The longer the payload is, the slower the hopping rate is.

Report No.: TMTN2202000174NR

TEST RESULTS

Time of occupancy on the TX channel in 31.6sec = time domain slot length × hop rate ÷ number of hop per channel × 31.6

Refer to the attached graph.

The hopping rates of Bluetooth devices change with different types of payload. The longer the payload is, the slower the hopping rate. The hopping rate scenario is defined in Bluetooth core specification.

Model Name	AT-LP3XBT	Test By	Peter Chu
Temp & Humidity	25.5°C, 54%	Test Date	3/24/2022

Modulation Type: GFSK / DH5

Transmitting Frequency	Packet type	Dwell time (ms)	Time of occupancy on the TX channel in 31.6sec (ms)	Limit for Time of occupancy on the TX channel in 31.6sec (ms)	Results
2441MHz	DH1	0.400	128.000	400.000	PASS
2441MHz	DH3	1.660	265.600	400.000	PASS
2441MHz	DH5	2.900	309.333	400.000	PASS
2441MHz	AFH	2.900	154.667	400.000	PASS

DH1 Dwell time= 0.400 ms×(1600÷2)÷79×31.6= 128.00 (ms)
 DH3 Dwell time= 1.660 ms×(1600÷4)÷79×31.6= 265.60 (ms)
 DH5 Dwell time= 2.900 ms×(1600÷6)÷79×31.6= 309.33 (ms)
 AFH Dwell time= 2.900 ms×(800÷6)÷20×8= 154.67 (ms)

Modulation Type: 8-DPSK / 3-DH5

Transmitting Frequency	Packet type	Dwell time (ms)	Time of occupancy on the TX channel in 31.6sec (ms)	Limit for Time of occupancy on the TX channel in 31.6sec (ms)	Results
2441MHz	3DH1	0.400	128.000	400.000	PASS
2441MHz	3DH3	1.660	265.600	400.000	PASS
2441MHz	3DH5	2.900	309.333	400.000	PASS
2441MHz	AFH	2.900	154.667	400.000	PASS

3DH1 Dwell time= 0.400 ms×(1600÷2)÷79×31.6= 128.00 (ms)
 3DH3 Dwell time= 1.660 ms×(1600÷4)÷79×31.6= 265.60 (ms)
 3DH5 Dwell time= 2.900 ms×(1600÷6)÷79×31.6= 309.33 (ms)
 AFH Dwell time= 2.900 ms×(800÷6)÷20×8= 154.67 (ms)

DWELL TIME ON EACH PAYLOAD

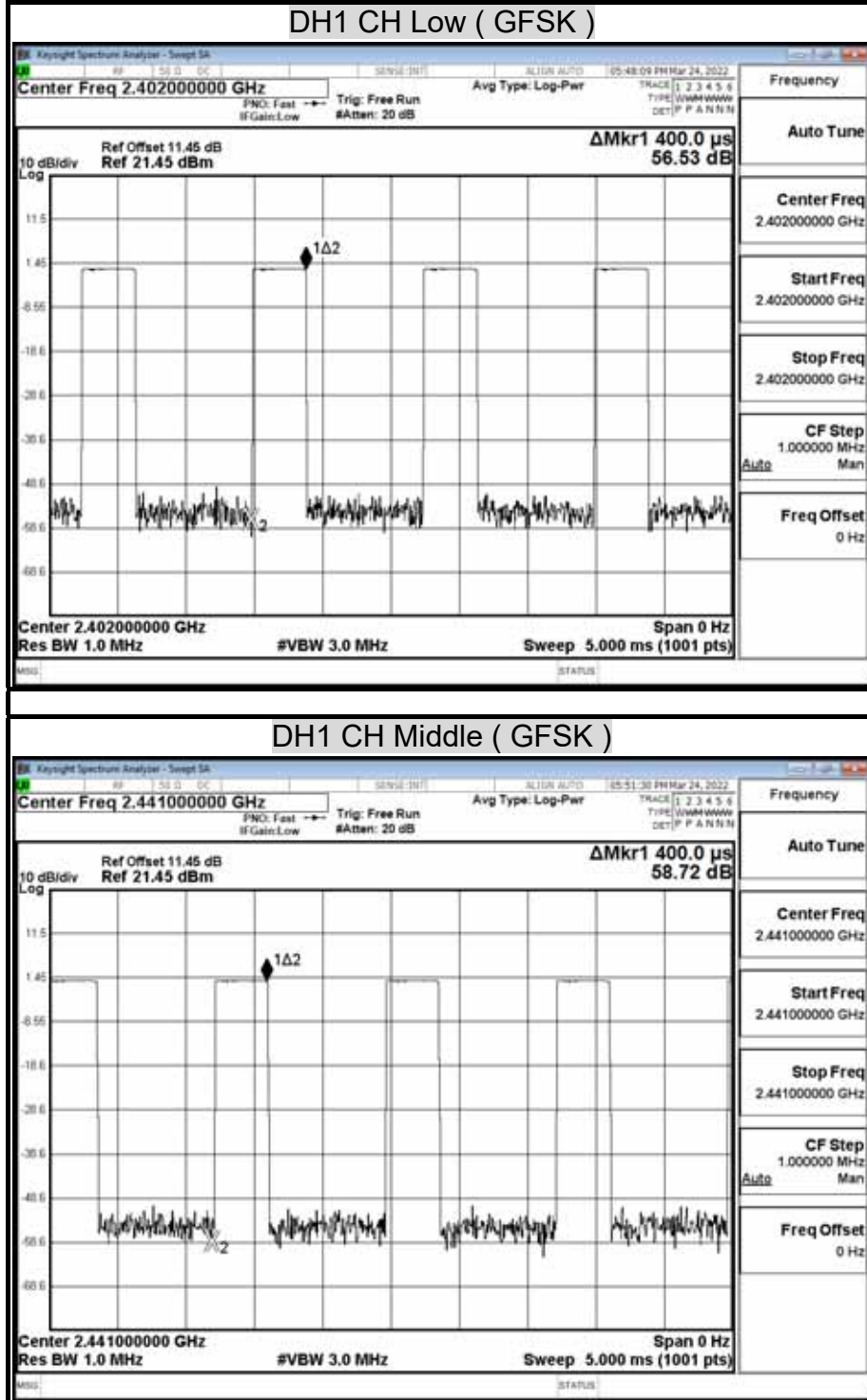

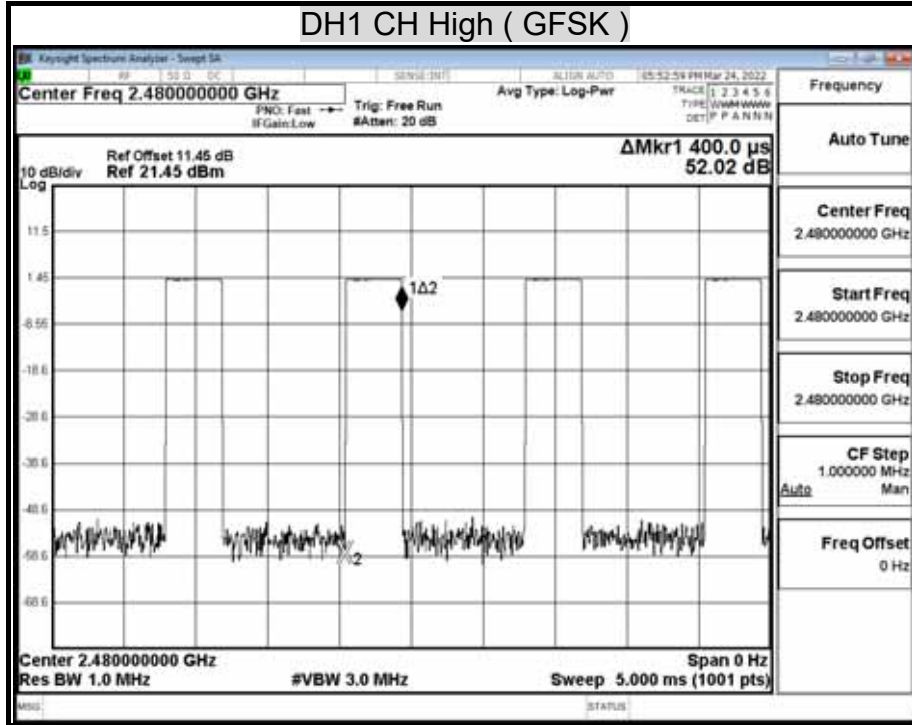

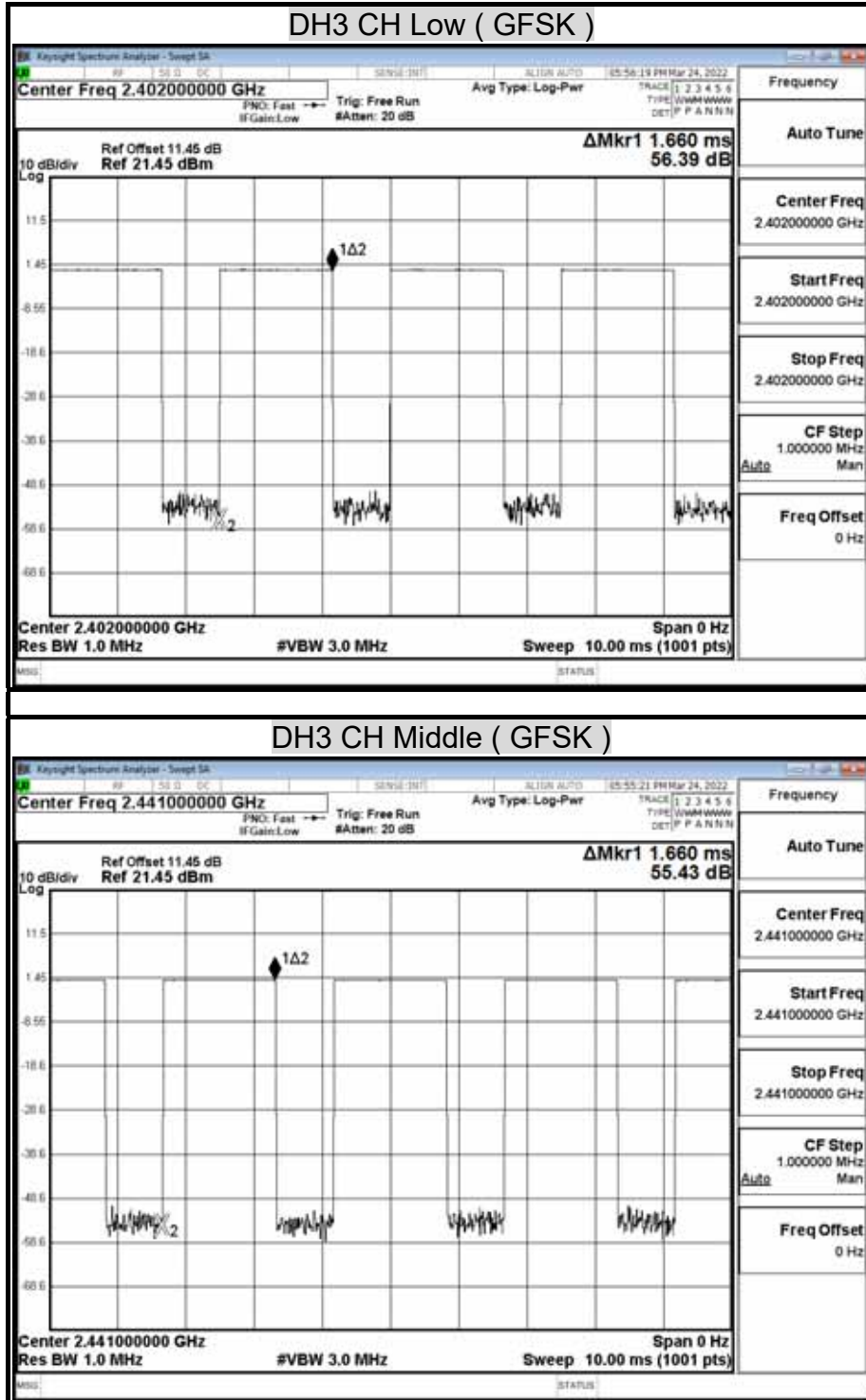

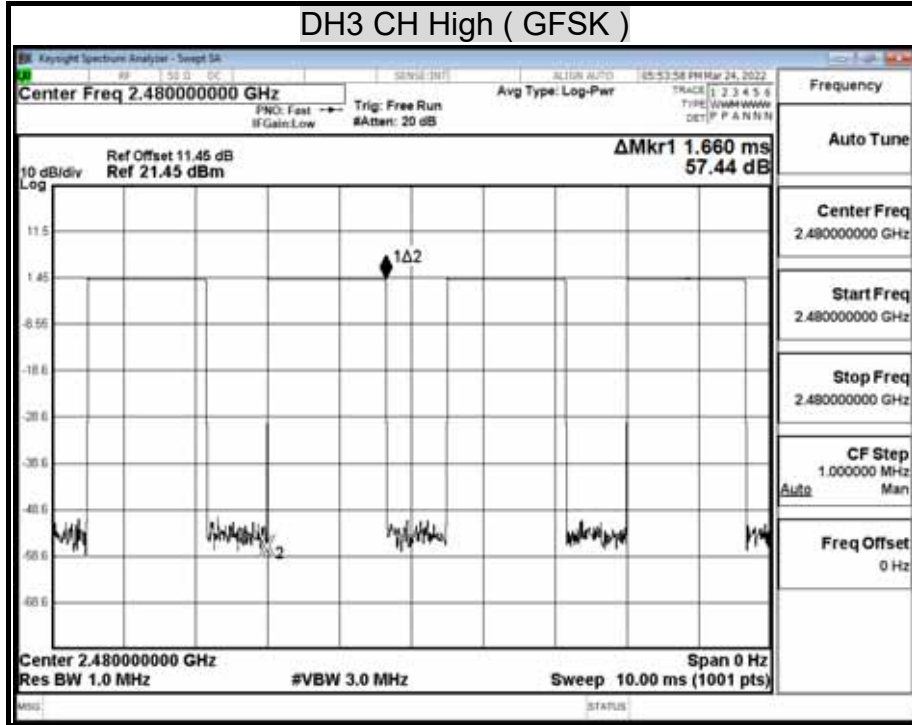

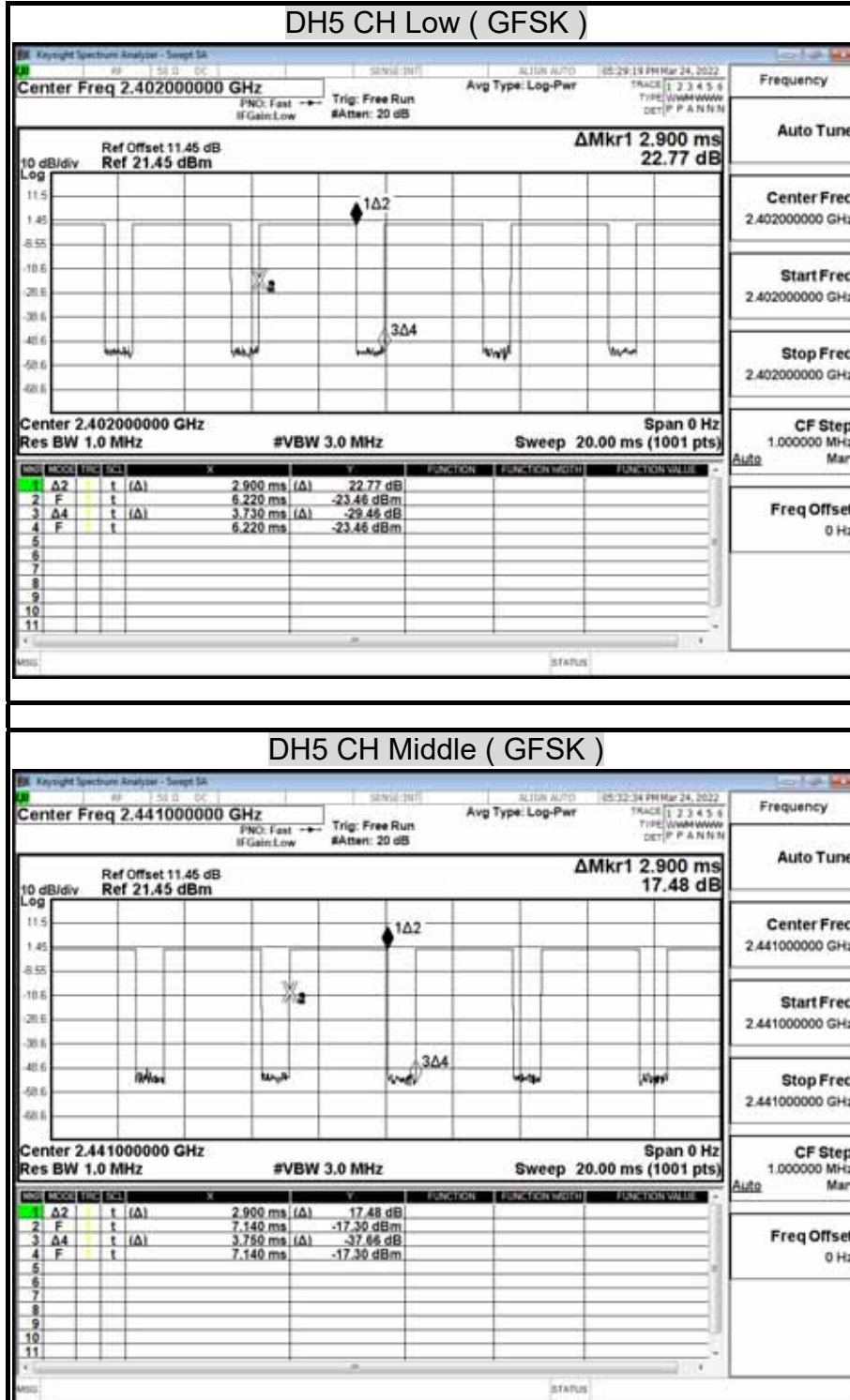

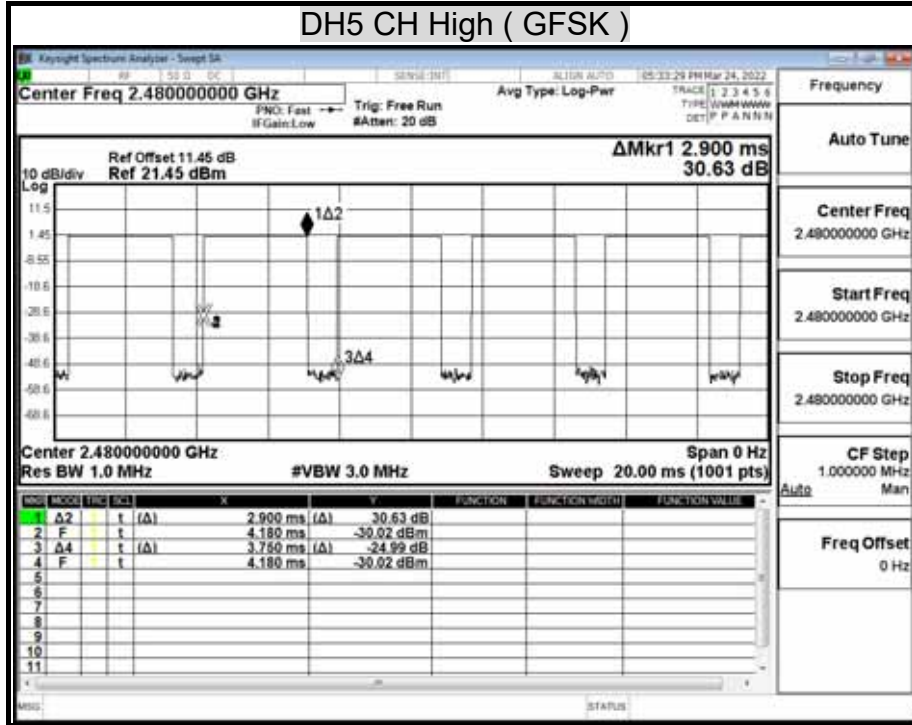

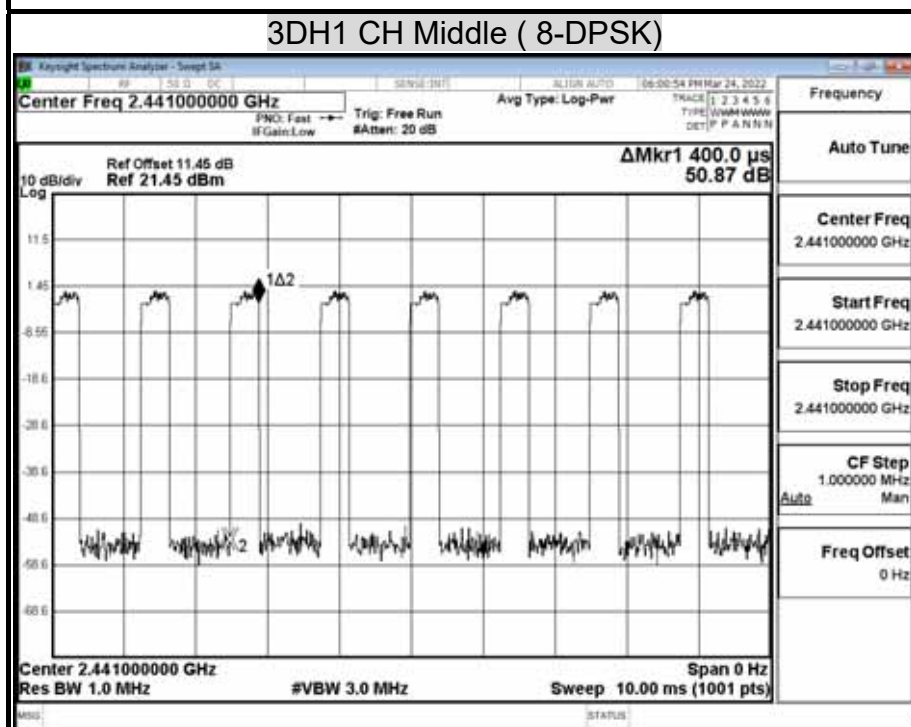
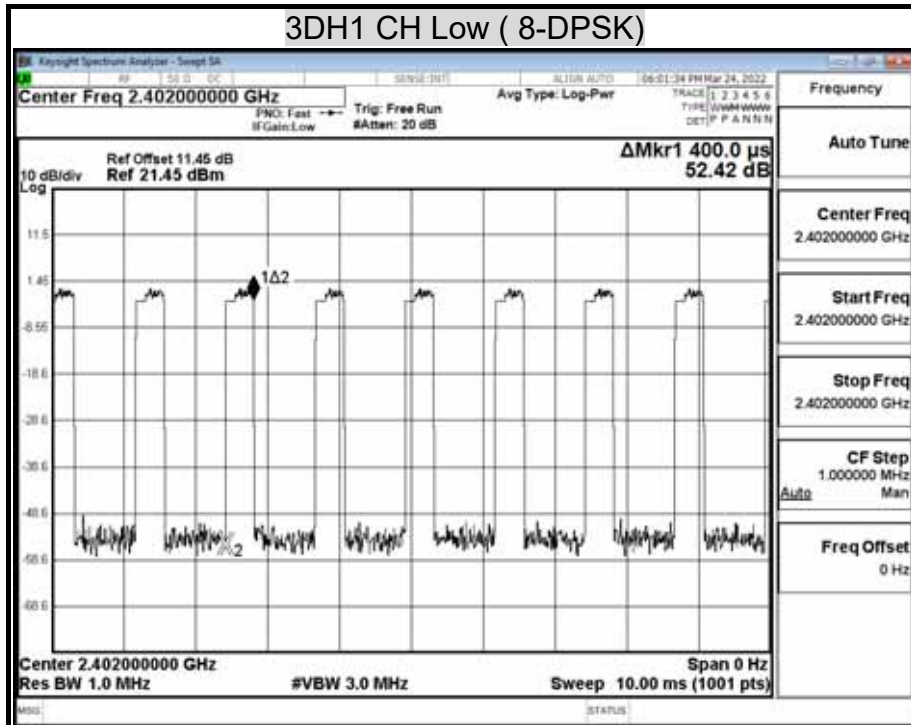

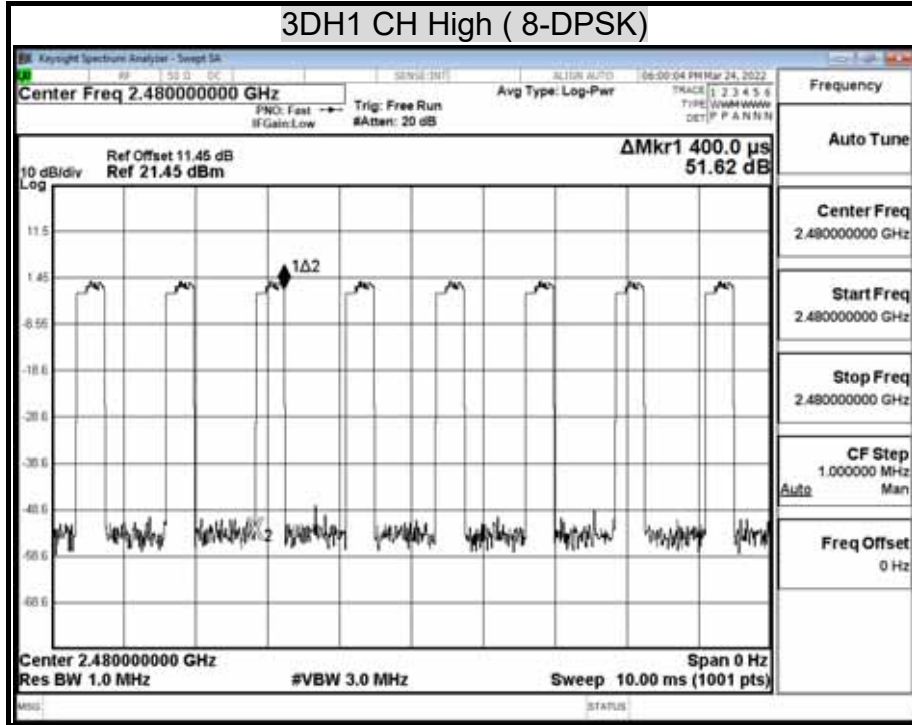

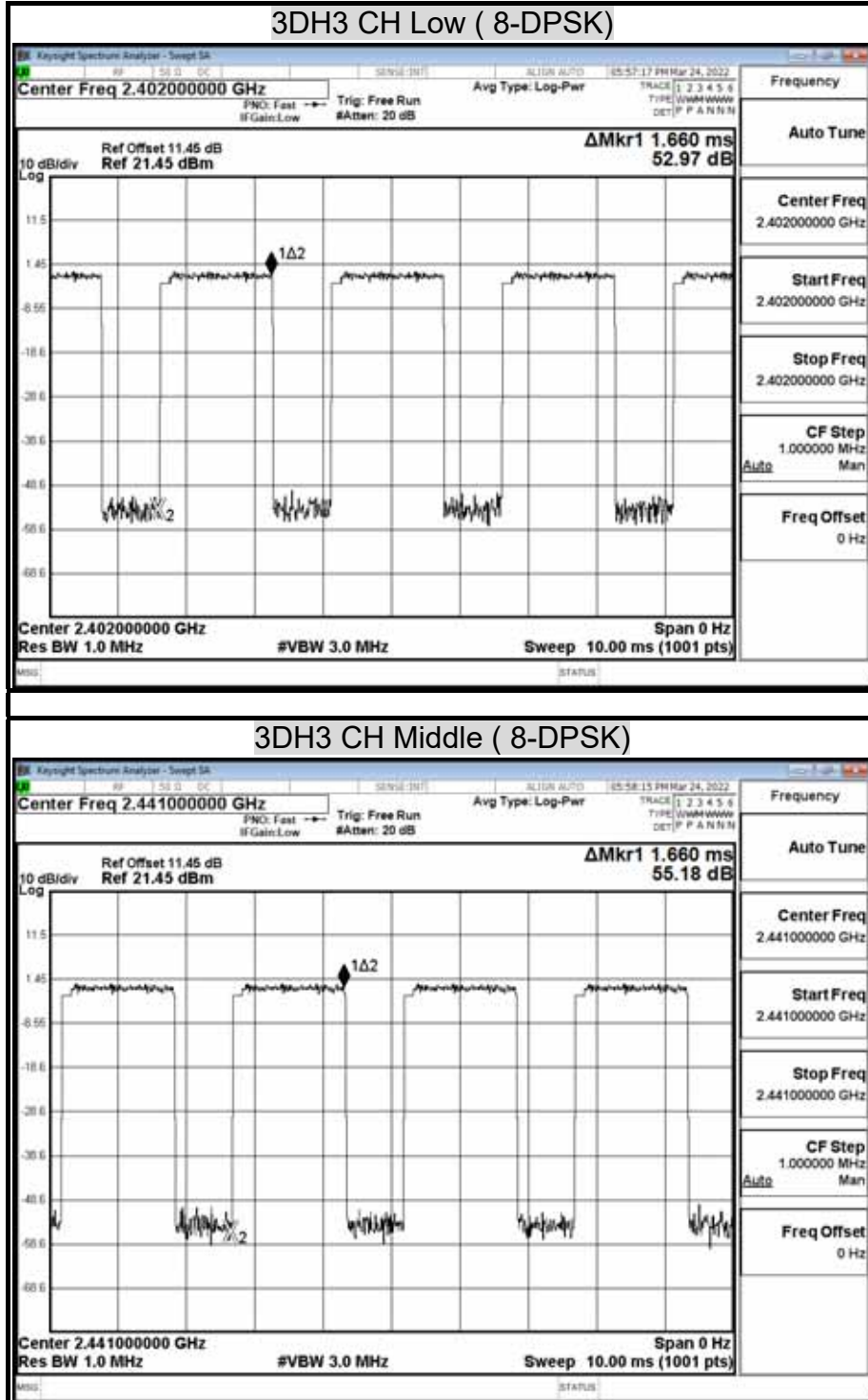

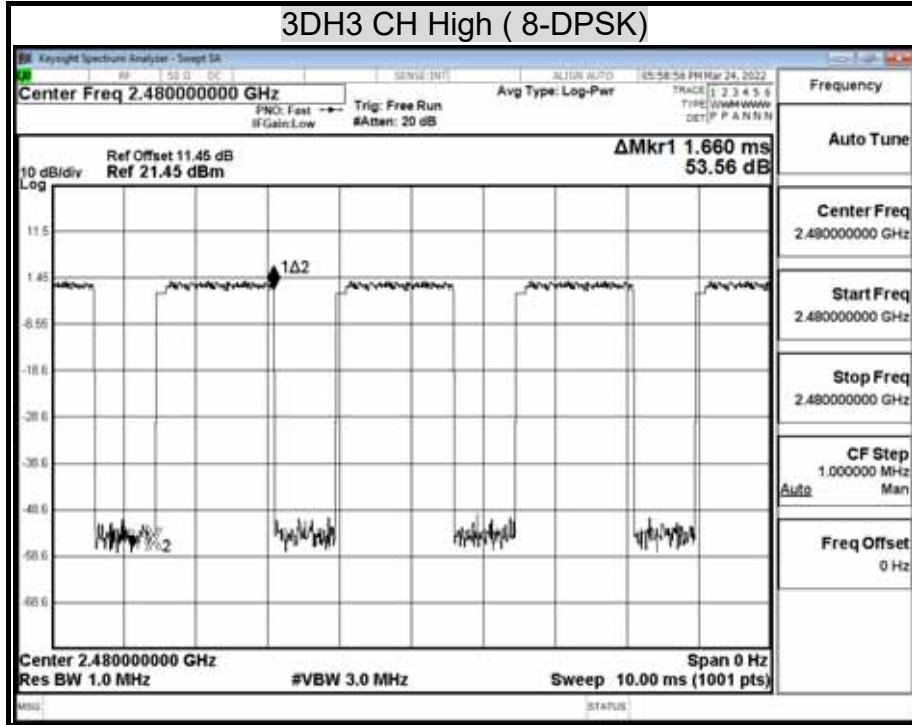

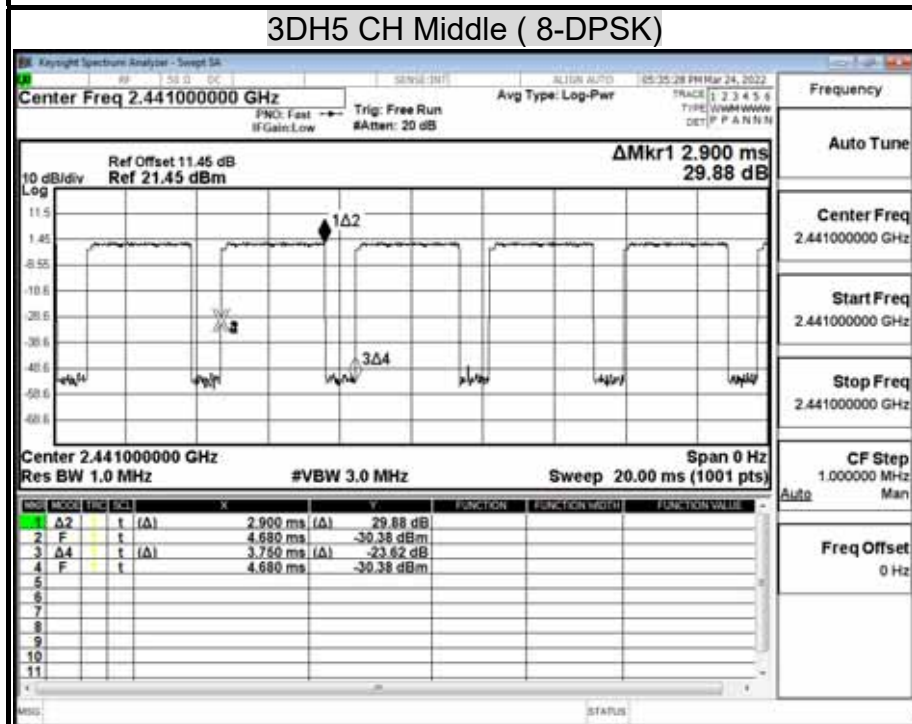
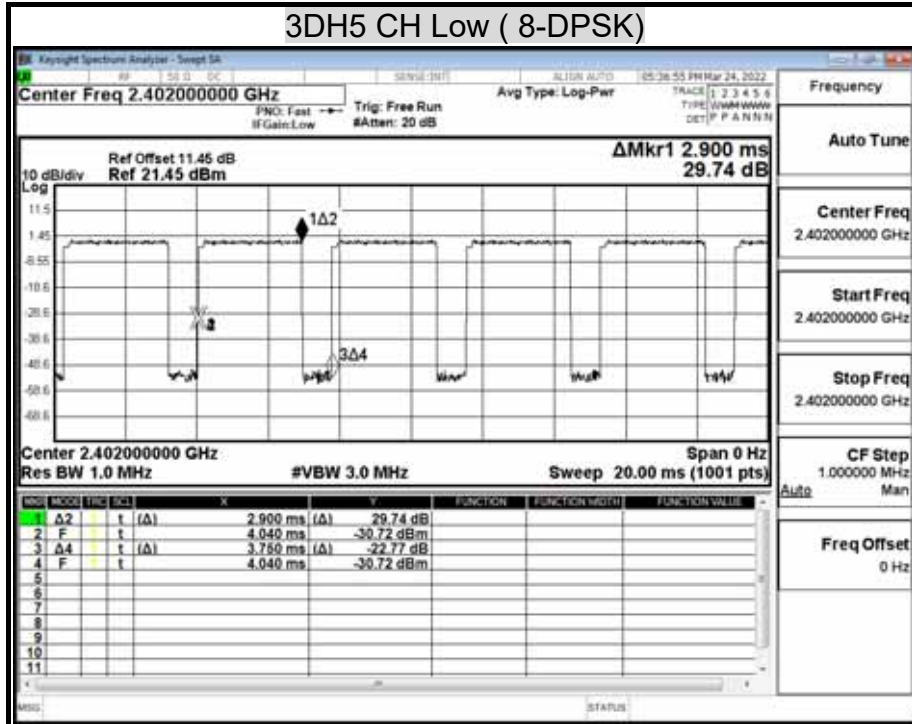

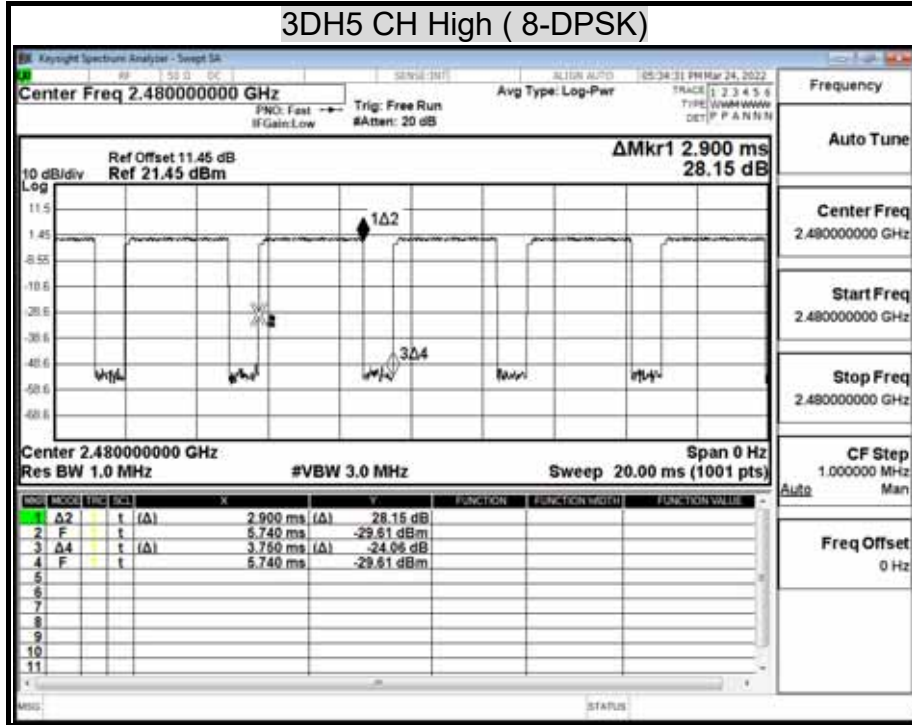

8.6 DUTY CYCLE

LIMIT

Nil (No dedicated limit specified in the Rules)

TEST SETUP

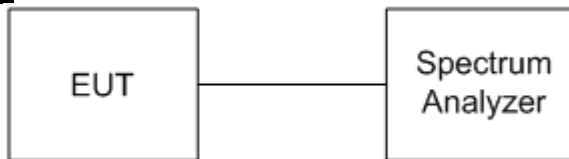

TEST PROCEDURE

1. Place the EUT on the table and set it in transmitting mode.
2. Remove the antenna from the EUT and then connect a low loss RF cable from the antenna port to the spectrum analyzer.
3. The zero-span mode on a spectrum analyzer or EMI receiver if the response time and spacing between bins on the sweep are sufficient to permit accurate measurements of the on and off times of the transmitted signal. Set the center frequency of the instrument to the center frequency of the transmission. Set $RBW \geq OBW$ if possible; otherwise, set RBW to the largest available value. Set $VBW \geq RBW$. Set detector = peak or average. The zero-span measurement method shall not be used unless both RBW and VBW are $> 50/T$ and the number of sweep points across duration T exceeds 100. (For example, if VBW and/or RBW are limited to 3 MHz, then the zero-span method of measuring duty cycle shall not be used if $T \leq 16.7$ microseconds.)

Report No.: TMTN2202000174NR

TEST RESULTS

No non-compliance noted.

TEST DATA

Model Name	AT-LP3XBT	Test By	Peter Chu
Temp & Humidity	25.5°C, 54%	Test Date	3/24/2022

Modulation Type: GFSK / DH5

	us	Times	Ton	Total Ton time(ms)
Ton1	2900.000	1	2900	
Ton2		0	0	
Ton3			0	2.9
TP				3.75

Ton	2.9
TP(Ton+Toff)	3.75
Duty Cycle	0.773
Duty Factor	1.116

Modulation Type: 8-DPSK / 3-DH5

	us	Times	Ton	Total Ton time(ms)
Ton1	2900.000	1	2900	
Ton2		0	0	
Ton3			0	2.9
TP				3.75

Ton	2.9
TP(Ton+Toff)	3.75
Duty Cycle	0.773
Duty Factor	1.116

Report No.: TMTN2202000174NR

TEST PLOT

Duty Cycle

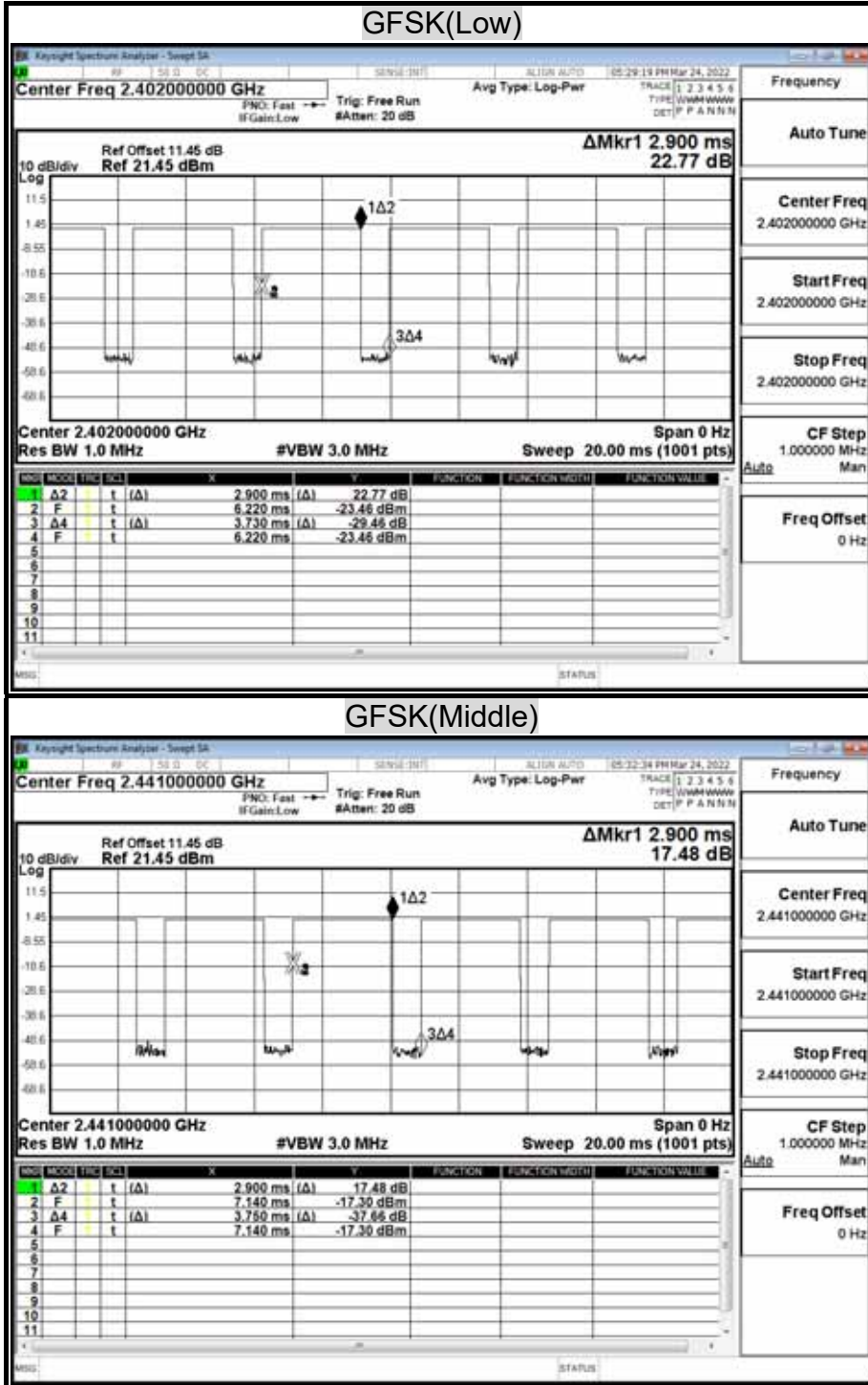

Report No.: TMTN2202000174NR

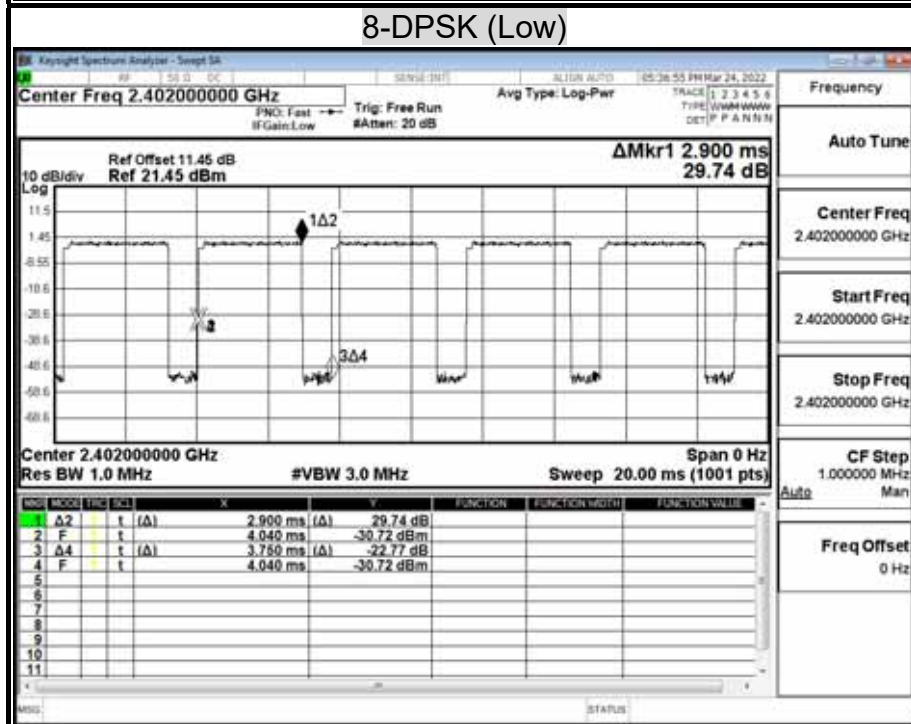
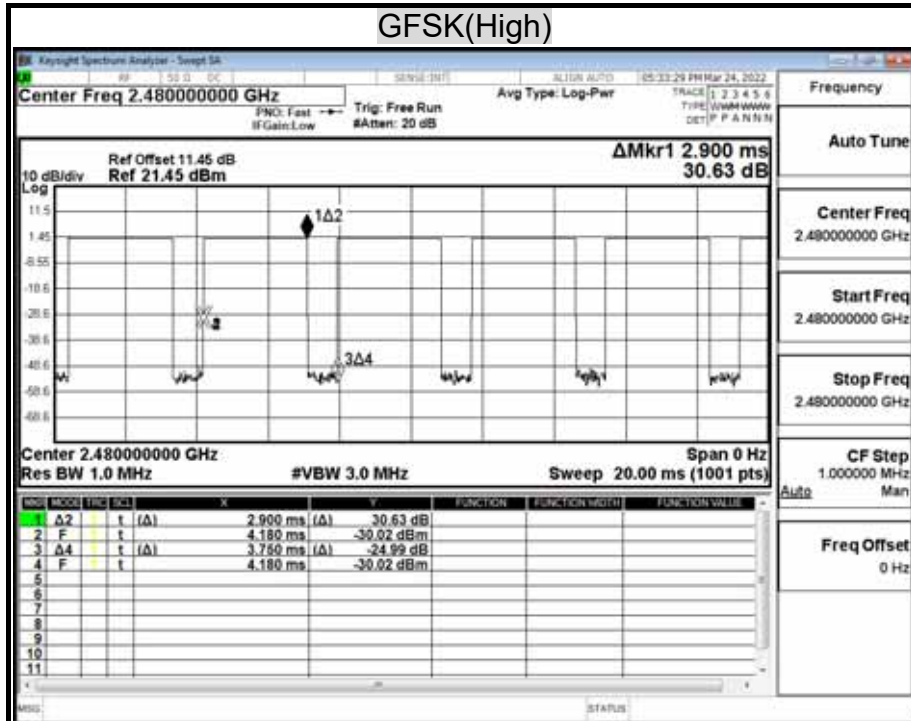

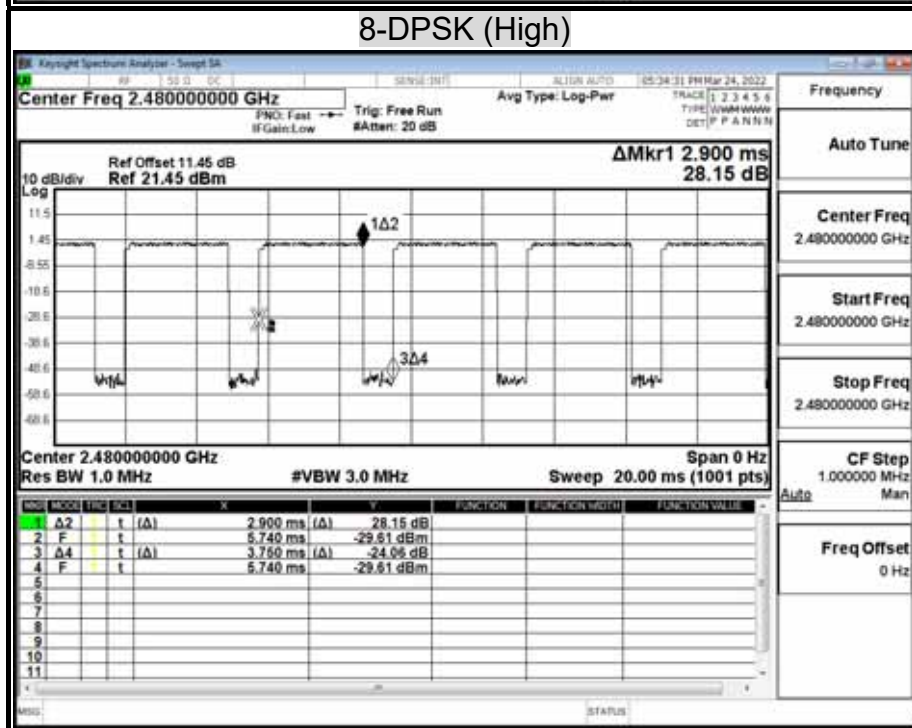
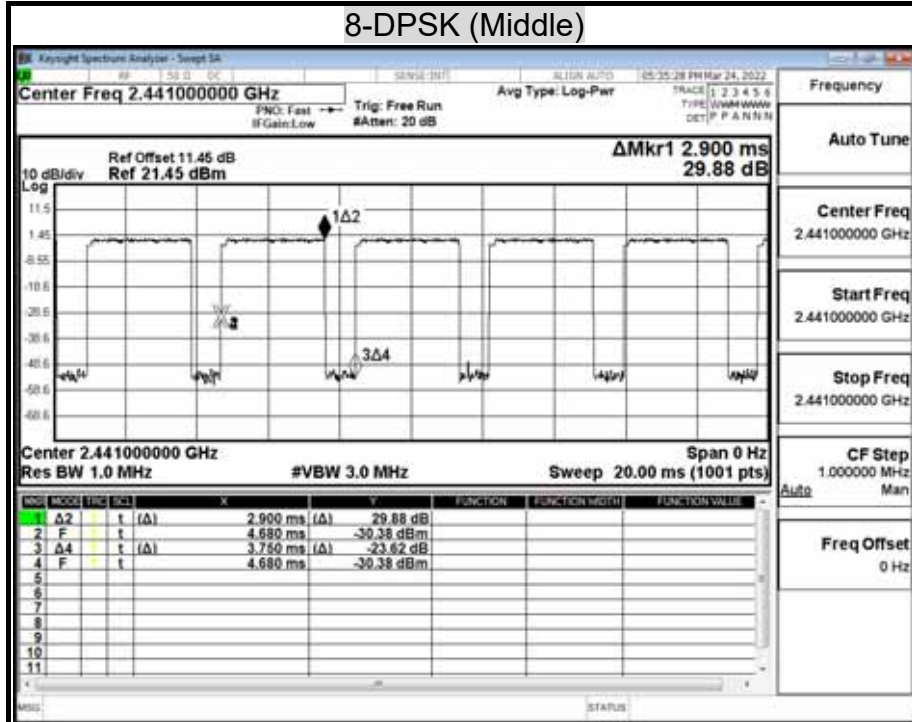

8.7 CONDUCTED SPURIOUS EMISSION

LIMITS

§ 15.247(d) In any 100 kHz bandwidth outside the frequency band in which the spread spectrum intentional radiator is operating, the radio frequency power that is produced by the intentional radiator shall be at least 20 dB below that in the 100 kHz bandwidth within the band and that contains the highest level of the desired power, based on either an RF conducted or a radiated measurement. Attenuation below the general limits specified in § 15.209(a) is not required. In addition, radiated emissions which fall in the restricted bands, as defined in § 15.205(a), must also comply with the radiated emission limits specified in § 15.209(a) (see § 15.205(c)).

TEST SETUP

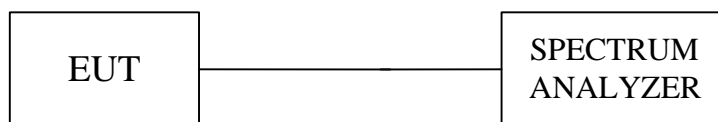

TEST PROCEDURE

The transmitter output is connected to a spectrum analyzer. The resolution bandwidth is set to 100 kHz. The video bandwidth is set to 300 kHz.

The spectrum from 30 MHz to 26.5 GHz is investigated with the transmitter set to the lowest, middle, and highest channels in the 2.4 GHz band.

Report No.: TMTN2202000174NR

TEST RESULTS

Model Name	AT-LP3XBT	Test By	Peter Chu
Temp & Humidity	25.5°C, 54%	Test Date	3/24/2022

OUT-OF-BAND SPURIOUS EMISSIONS-CONDUCTED MEASUREMENT
CH Low (30MHz ~ 26.5GHz / GFSK)

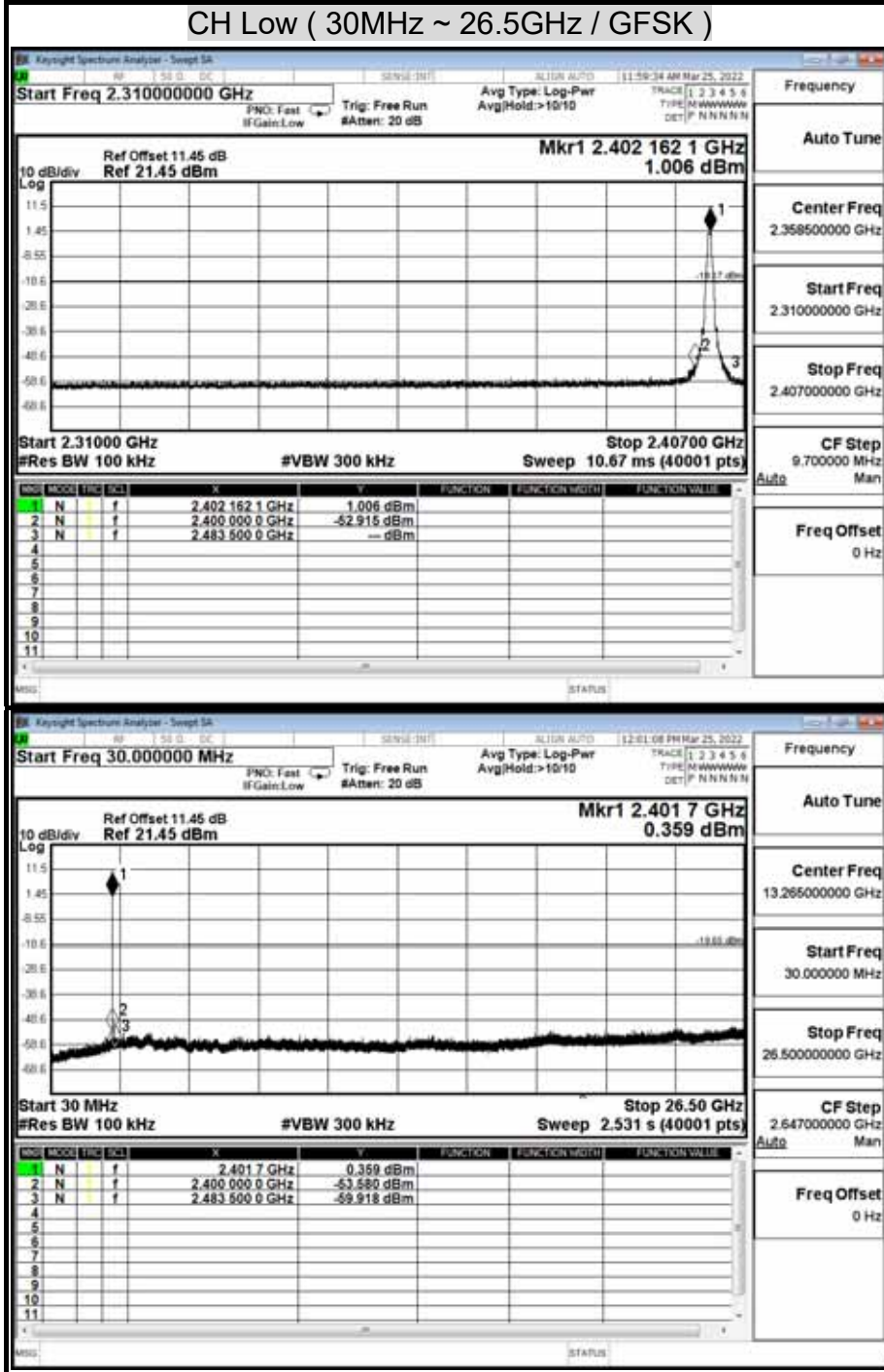

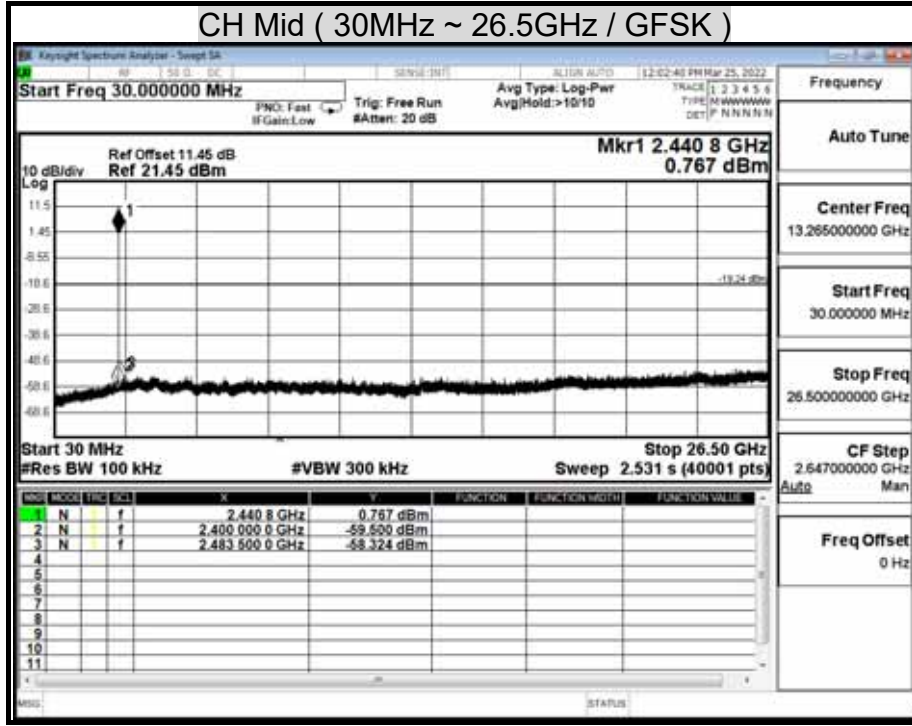

Report No.: TMTN2202000174NR

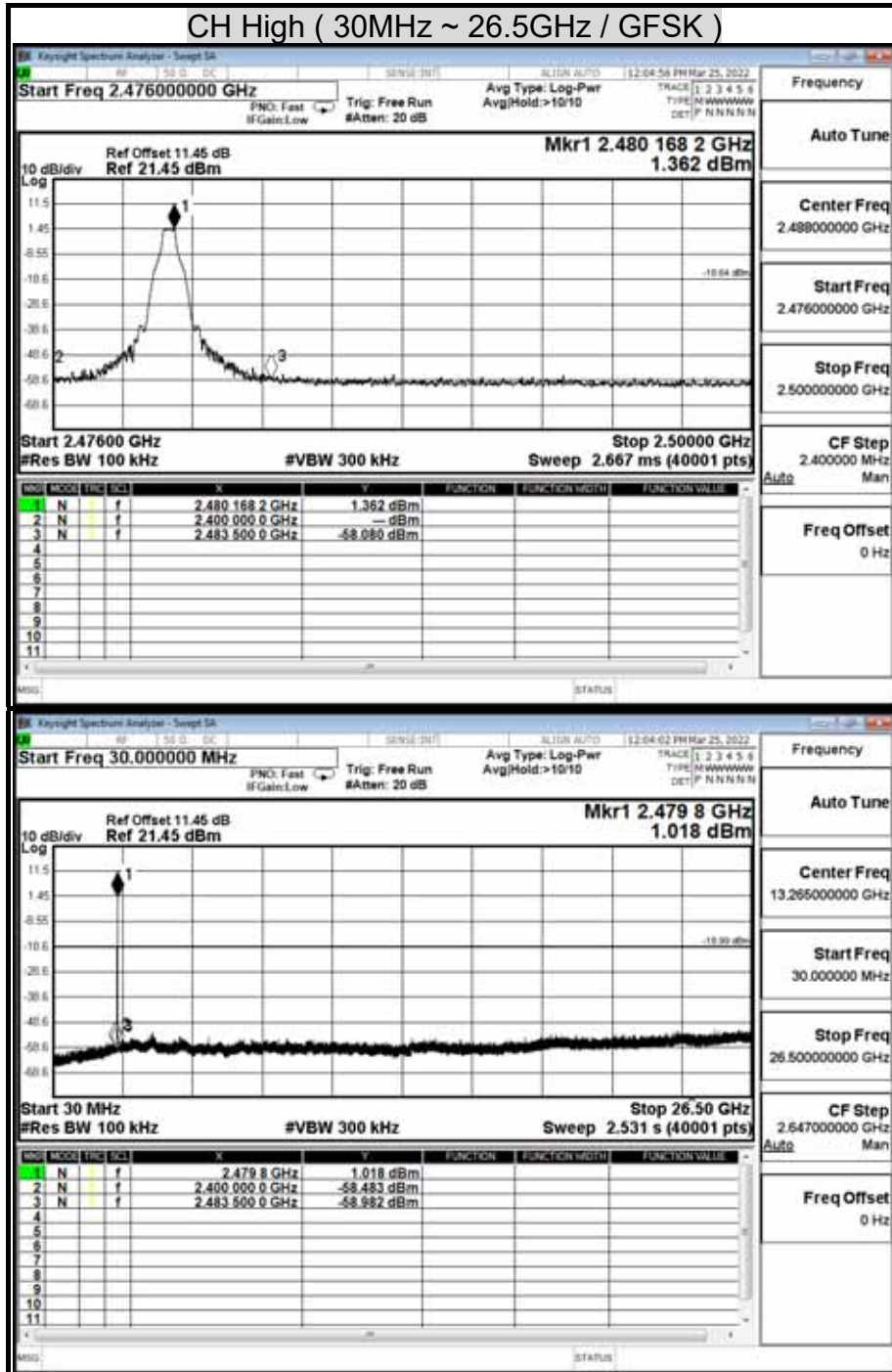

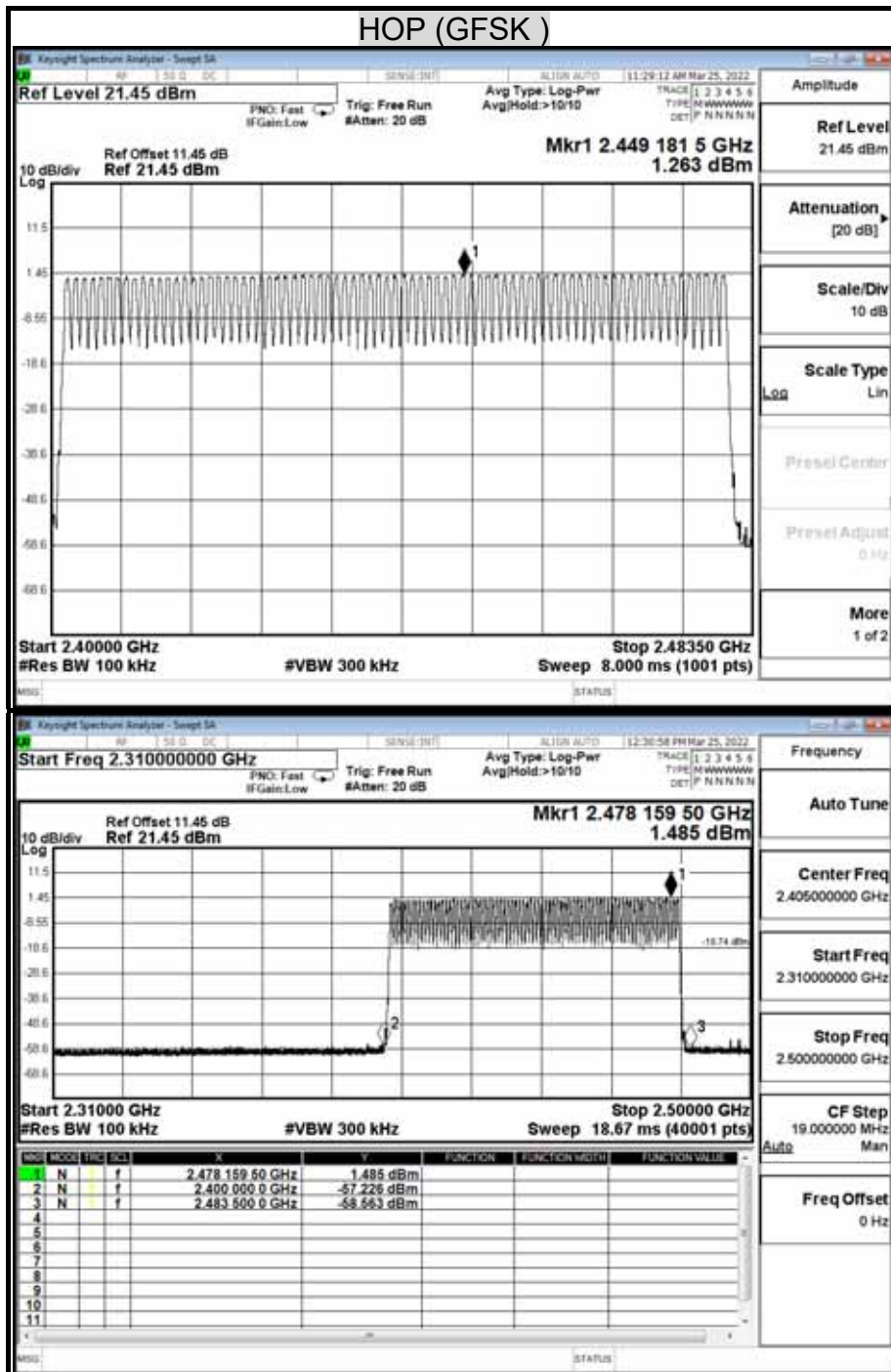

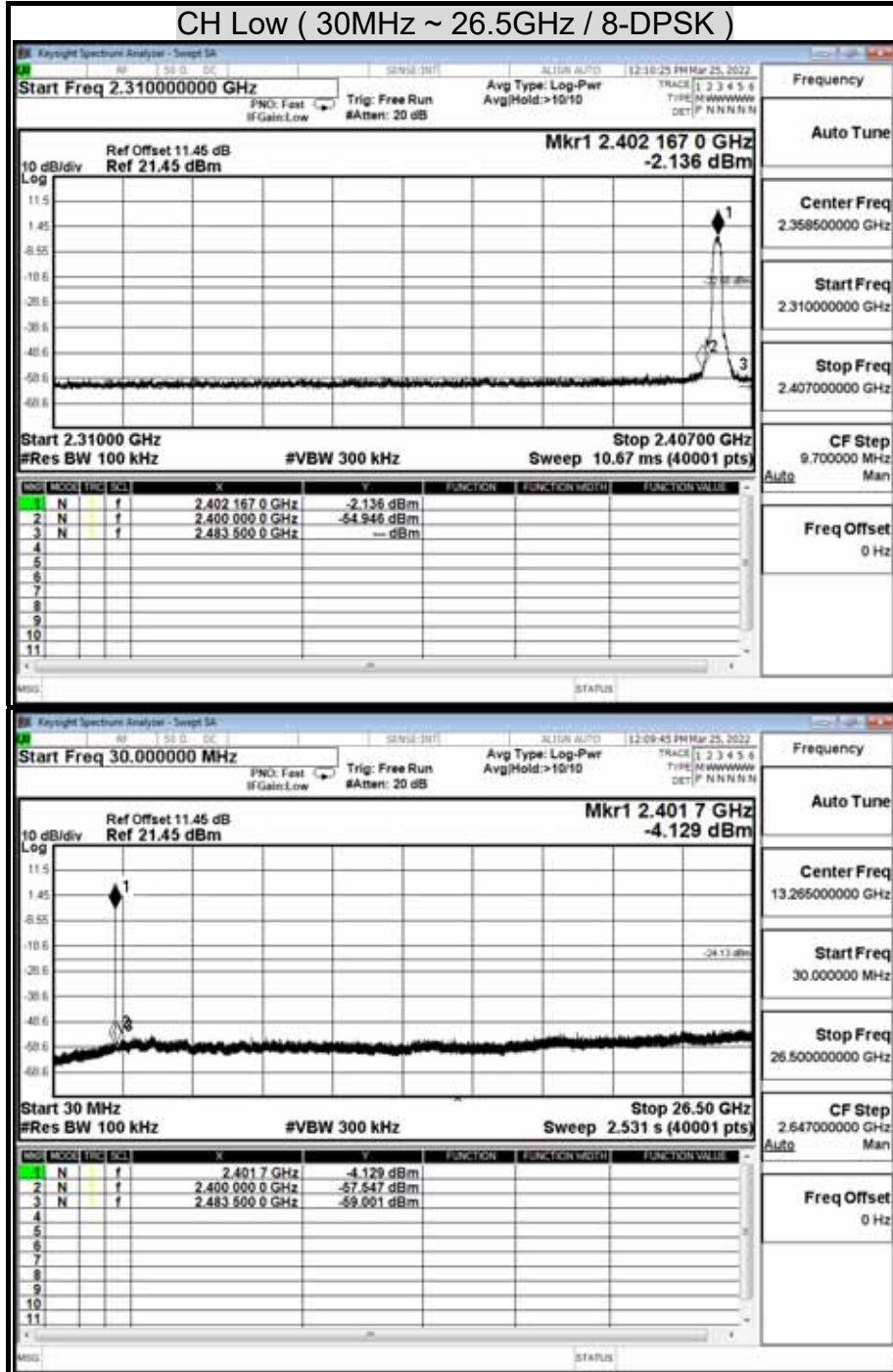

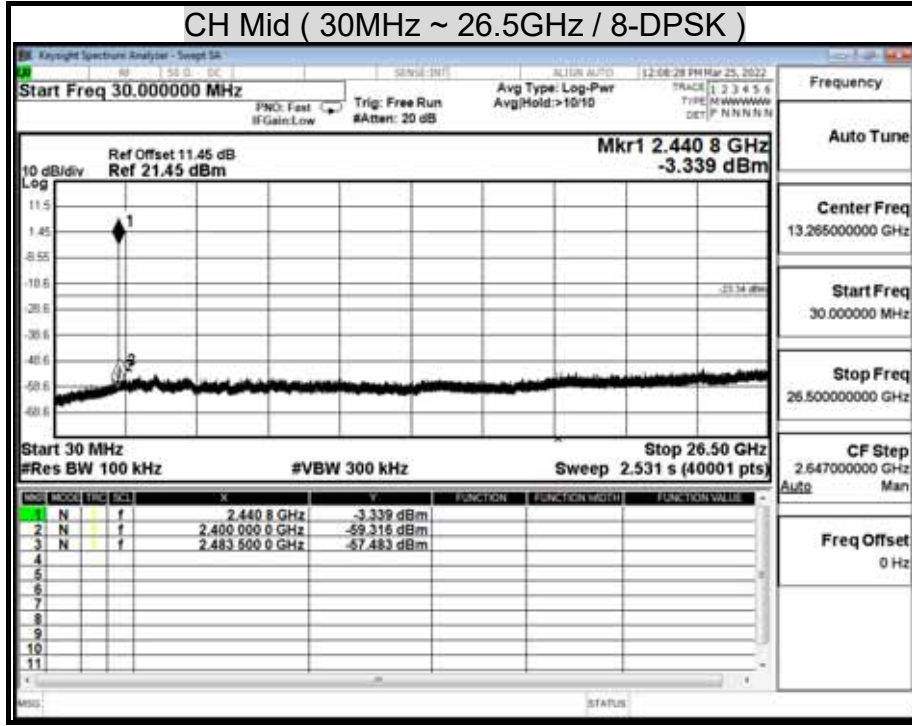

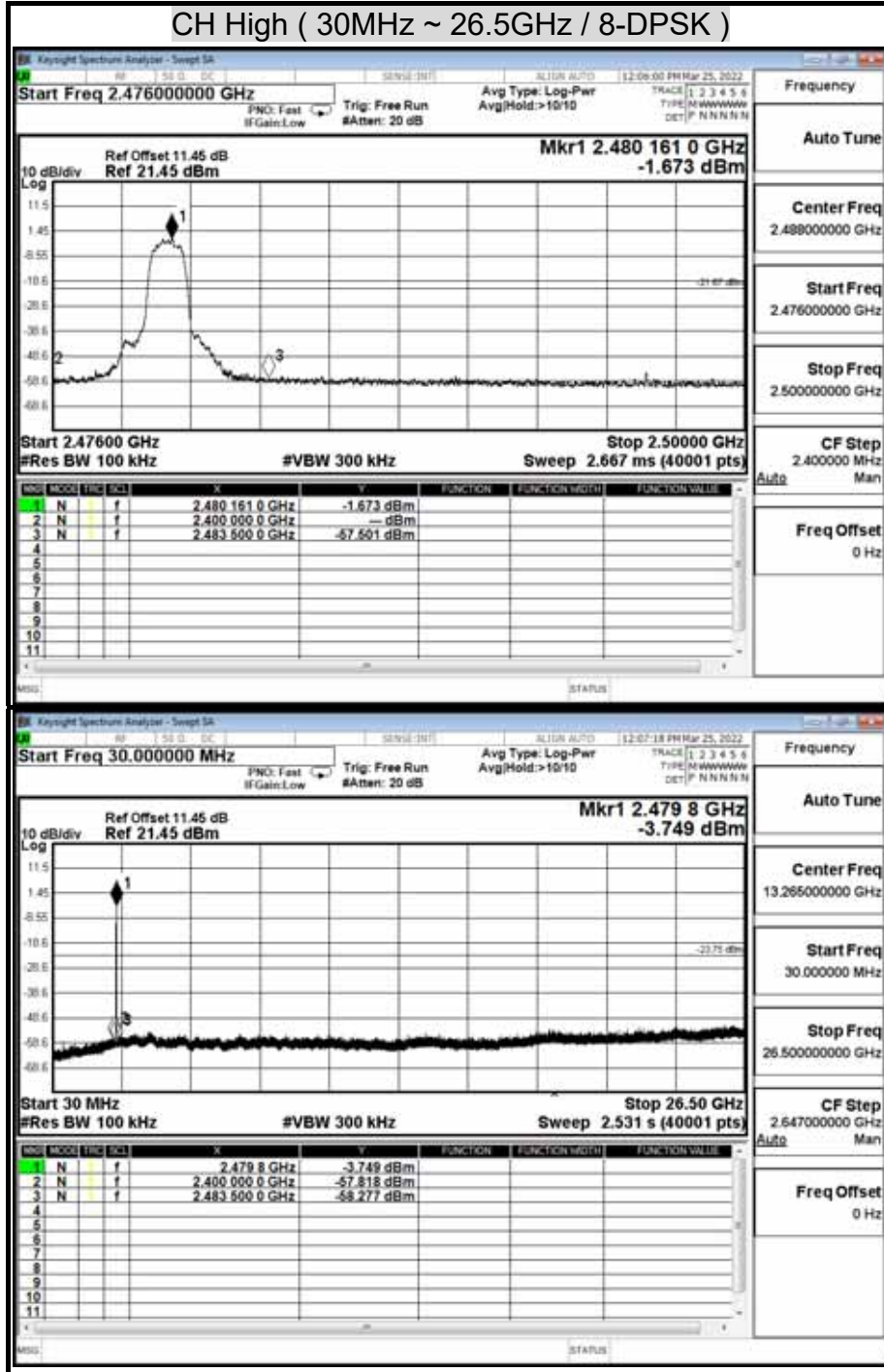

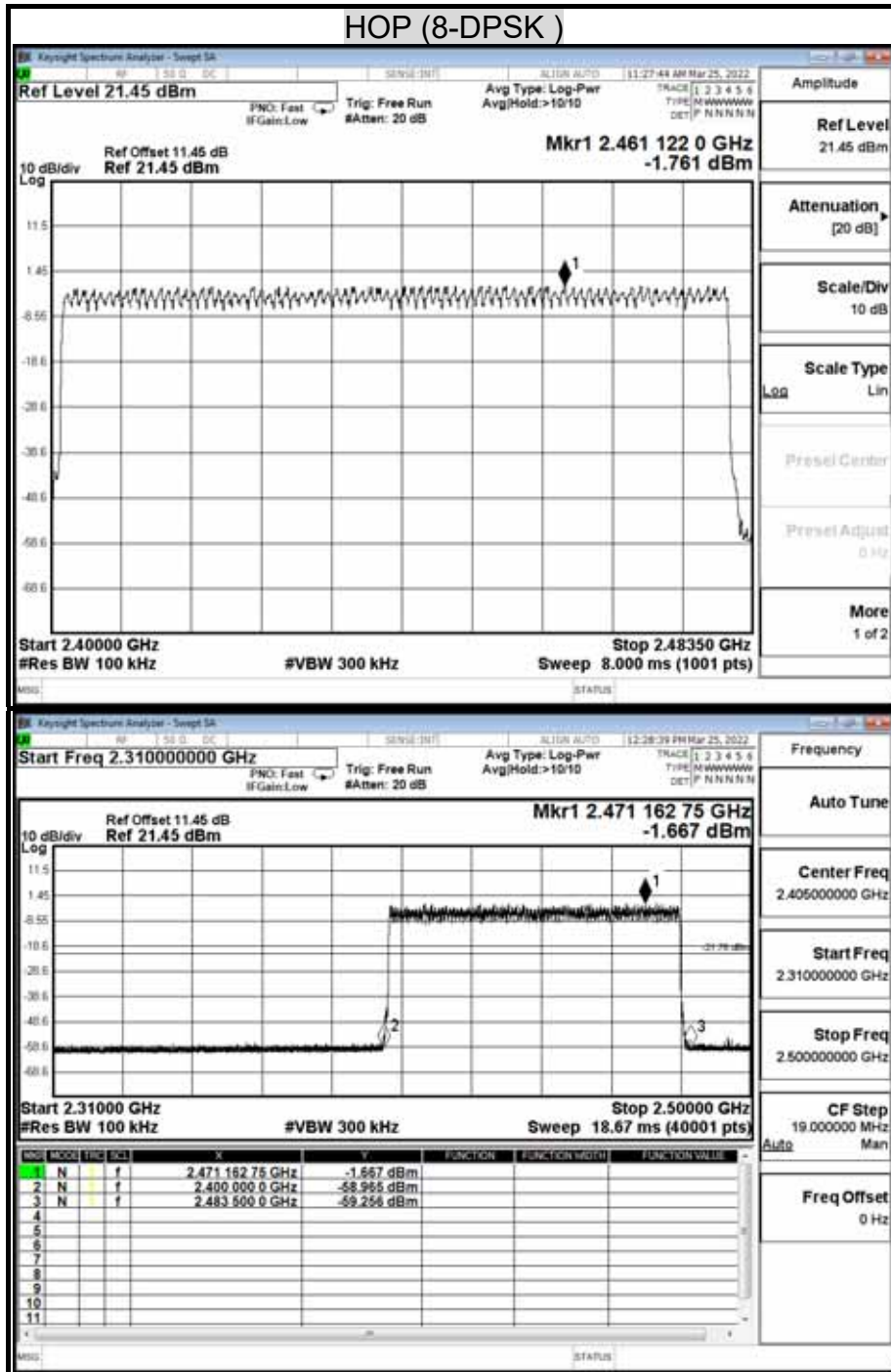

8.8 RADIATED EMISSIONS

8.8.1 TRANSMITTER RADIATED SUPURIOUS EMISSIONS

LIMITS

§ 15.205 (a) Except as shown in paragraph (d) of this section, only spurious emissions are permitted in any of the frequency bands listed below:

MHz	MHz	MHz	GHz
0.090 - 0.110	16.42 - 16.423	399.9 - 410	4.5 - 5.15
10.495 - 0.505	16.69475 - 16.69525	608 - 614	5.35 - 5.46
2.1735 - 2.1905	16.80425 - 16.80475	960 - 1240	7.25 - 7.75
4.125 - 4.128	25.5 - 25.67	1300 - 1427	8.025 - 8.5
4.17725 - 4.17775	37.5 - 38.25	1435 - 1626.5	9.0 - 9.2
4.20725 - 4.20775	73 - 74.6	1645.5 - 1646.5	9.3 - 9.5
6.215 - 6.218	74.8 - 75.2	1660 - 1710	10.6 - 12.7
6.26775 - 6.26825	108 - 121.94	1718.8 - 1722.2	13.25 - 13.4
6.31175 - 6.31225	123 - 138	2200 - 2300	14.47 - 14.5
8.291 - 8.294	149.9 - 150.05	2310 - 2390	15.35 - 16.2
8.362 - 8.366	156.52475 - 156.52525	2483.5 - 2500	17.7 - 21.4
8.37625 - 8.38675	156.7 - 156.9	2655 - 2900	22.01 - 23.12
8.41425 - 8.41475	162.0125 - 167.17	3260 - 3267	23.6 - 24.0
12.29 - 12.293	167.72 - 173.2	3332 - 3339	31.2 - 31.8
12.51975 - 12.52025	240 - 285	3345.8 - 3338	36.43 - 36.5
12.57675 - 12.57725	322 - 335.4	3600 - 4400	(²)
13.36 - 13.41			

¹ Until February 1, 1999, this restricted band shall be 0.490-0.510 MHz.

² Above 38.6

§ 15.205 (b) Except as provided in paragraphs (d) and (e), the field strength of emissions appearing within these frequency bands shall not exceed the limits shown in Section 15.209. At frequencies equal to or less than 1000 MHz, compliance with the limits in Section 15.209 shall be demonstrated using measurement instrumentation employing a CISPR quasi-peak detector. Above 1000 MHz, compliance with the emission limits in Section 15.209 shall be demonstrated based on the average value of the measured emissions. The provisions in Section 15.35 apply to these measurements.

Report No.: TMTN2202000174NR

§ 15.209 (a) Except as provided elsewhere in this Subpart, the emissions from an intentional radiator shall not exceed the field strength levels specified in the following table :

Frequency (MHz)	Field Strength (microvolts/meter)	Measurement Distance (meters)
30 - 88	100 **	3
88 - 216	150 **	3
216 - 960	200 **	3
Above 960	500	3

** Except as provided in paragraph (g), fundamental emissions from intentional radiators operating under this Section shall not be located in the frequency bands 54-72 MHz, 76-88 MHz, 174-216 MHz or 470-806 MHz, However, operation within these frequency bands is permitted under other sections of this Part, e-g, Sections 15.231 and 15.241.

§ 15.209 (b) In the emission table above, the tighter limit applies at the band edges.

TEST SETUP

The diagram below shows the test setup that is utilized to make the measurements for emission from below 1GHz.

9kHz ~ 30MHz

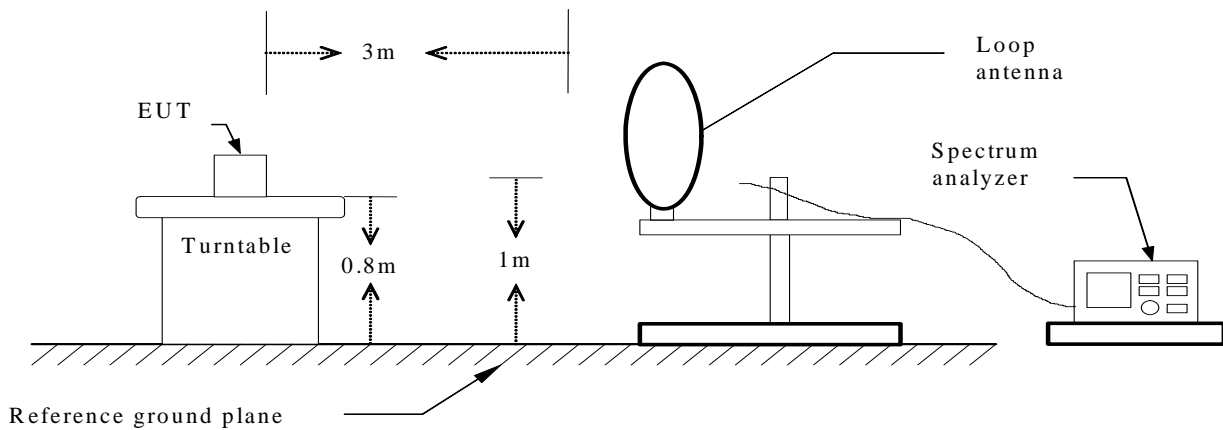

30MHz ~ 1GHz

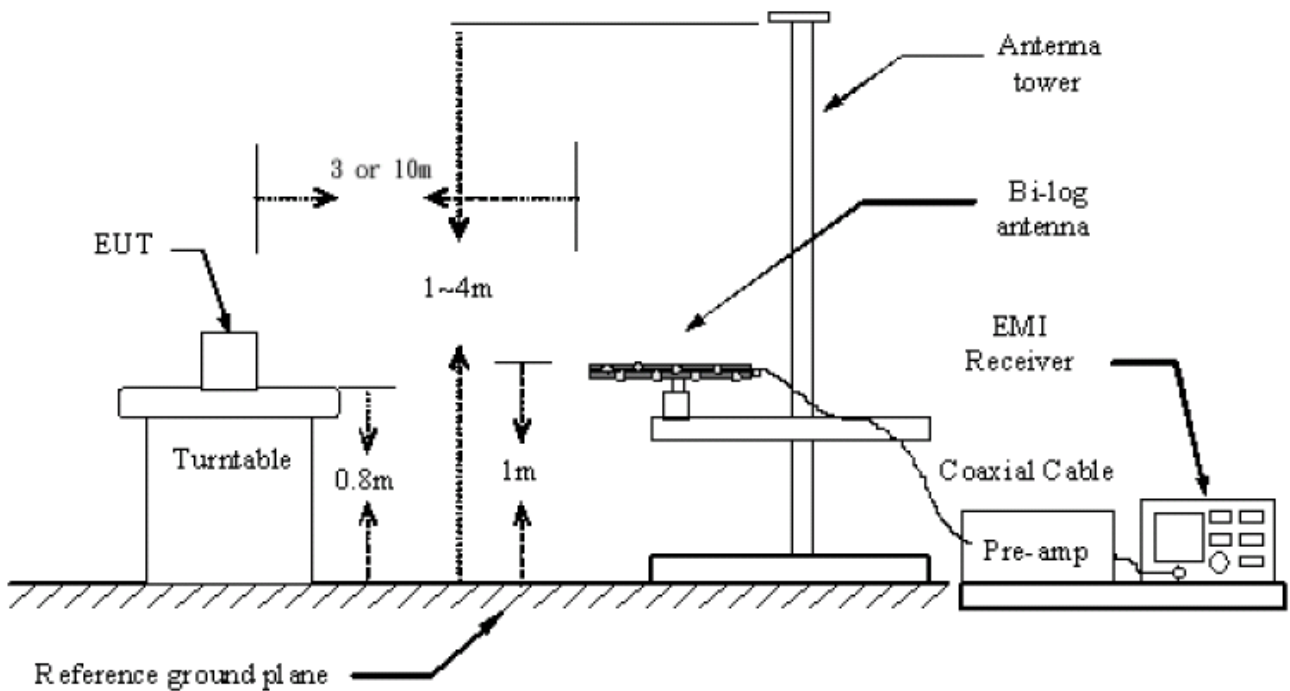

Report No.: TMTN2202000174NR

The diagram below shows the test setup that is utilized to make the measurements for emission above 1GHz.

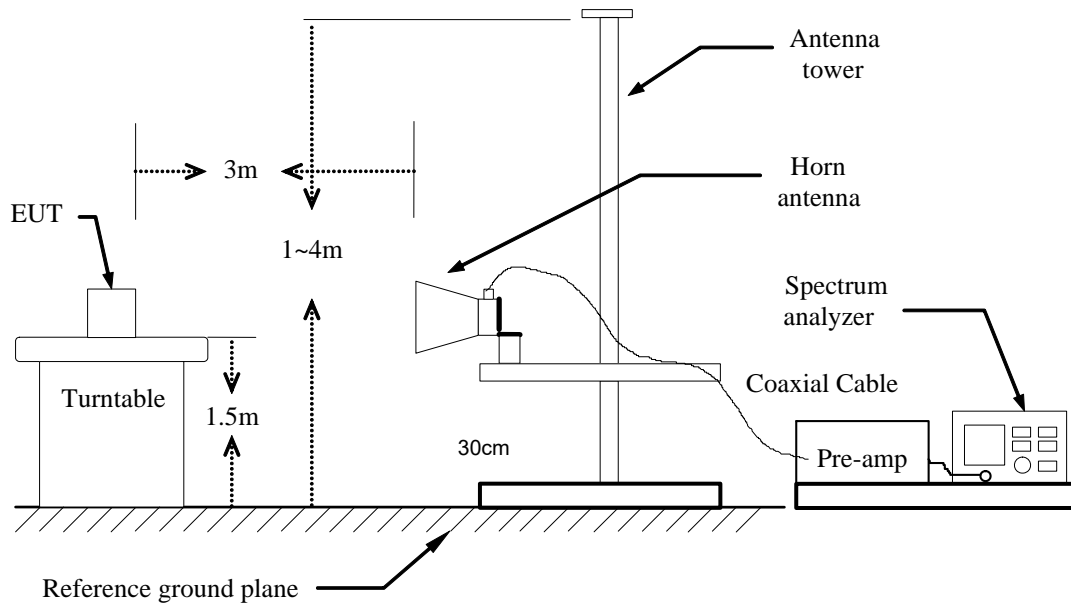

TEST PROCEDURE

- The EUT was placed on the top of a rotating table 0.8/1.5 meters above the ground at a 3 or 10 meter open site/chamber test site. The table was rotated 360 degrees to determine the position of the highest radiation.
- While measuring the radiated emission below 1GHz, the EUT was set 3 or 10 meters away from the interference-receiving antenna, which was mounted on the top of a variable-height antenna tower. While measuring the radiated emission above 1GHz, the EUT was set 3 or 10 meters away from the interference-receiving antenna.
- The antenna is a broadband antenna, and its height is varied from one meter to four meters above the ground to determine the maximum value of the field strength. Both horizontal and vertical polarization of the antenna are set to make the measurement.
- For each suspected emission, the EUT was arranged to its worst case and then the antenna was tuned to heights from 1 meter to 4 meters and the table was turned from 0 degrees to 360 degrees to find the maximum reading.
- The test-receiver system was set to QUASPEAK Detect Function and Specified Bandwidth with Maximum Hold Mode.
- If the emission level of the EUT in peak mode was 10 dB lower than the limit specified, then testing could be stopped and the peak values of the EUT would be reported. Otherwise the emissions that did not have 10 dB margin would be re-tested one by one using peak, quasi-peak or average method as specified and then reported in a data sheet.

Note :

- The resolution bandwidth and video bandwidth of test receiver/spectrum analyzer is 120 kHz for Peak detection (PK) and Quasi-peak detection (QP) at frequency below 1GHz.
- The resolution bandwidth and video bandwidth of test receiver/spectrum analyzer is 1 MHz for Peak detection and frequency above 1GHz.
- The resolution bandwidth of test receiver/spectrum analyzer is 1 MHz and the video bandwidth is 510 Hz for Average detection (AV) at frequency above 1GHz.

8.8.2 WORST-CASE RADIATED EMISSION BELOW 1 GHz

BELOW 1 GHz (9kHz ~ 30MHz)

No emission found between lowest internal used/generated frequency to 30MHz.

Report No.: TMTN2202000174NR
BELOW 1 GHz (30MHz ~ 1GHz)

Test Voltage: AC 120V, 60Hz

Product Name	AUTOMATIC WIRELESS TURNTABLE	Test Date	2022/03/23
Model Name	AT-LP3XBT	Test By	Ted Huang
Test Mode	TX	Temp & Humidity	25.6°C, 59%

Vertical

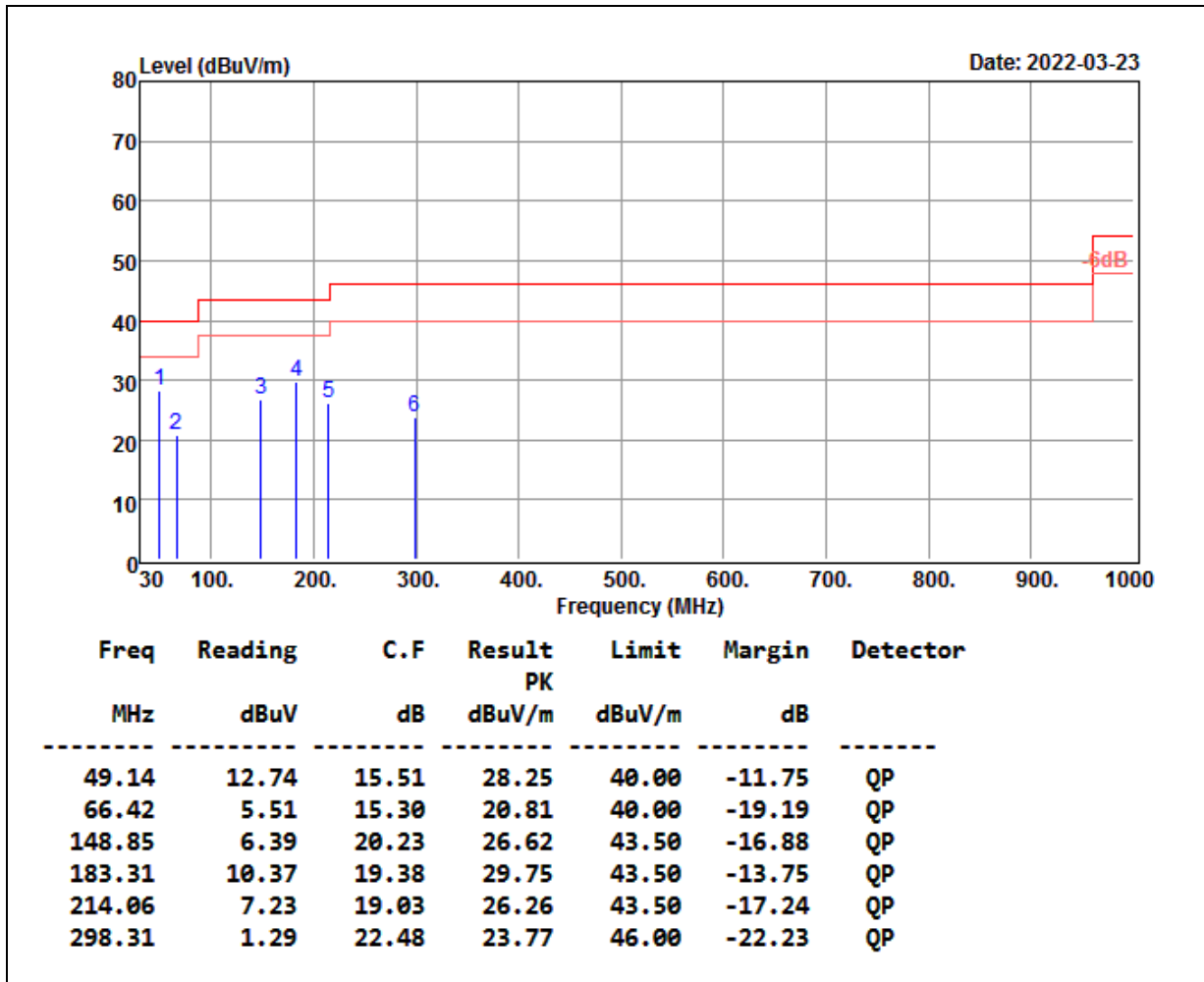

Remark:

1. No emission found between lowest internal used/generated frequency to 30MHz (9kHz~30MHz).
2. Radiated emissions measured were made with an instrument using peak/quasi-peak detector mode.
3. Quasi-peak test would be performed if the peak result were greater than the quasi-peak limit or as required by the applicant.
4. Margin (dB) = Remark result (dBUV/m) – Quasi-peak limit (dBUV/m).

Report No.: TMTN2202000174NR

Product Name	AUTOMATIC WIRELESS TURNTABLE	Test Date	2022/03/23
Model Name	AT-LP3XBT	Test By	Ted Huang
Test Mode	TX	Temp & Humidity	25.6°C, 59%

Horizontal

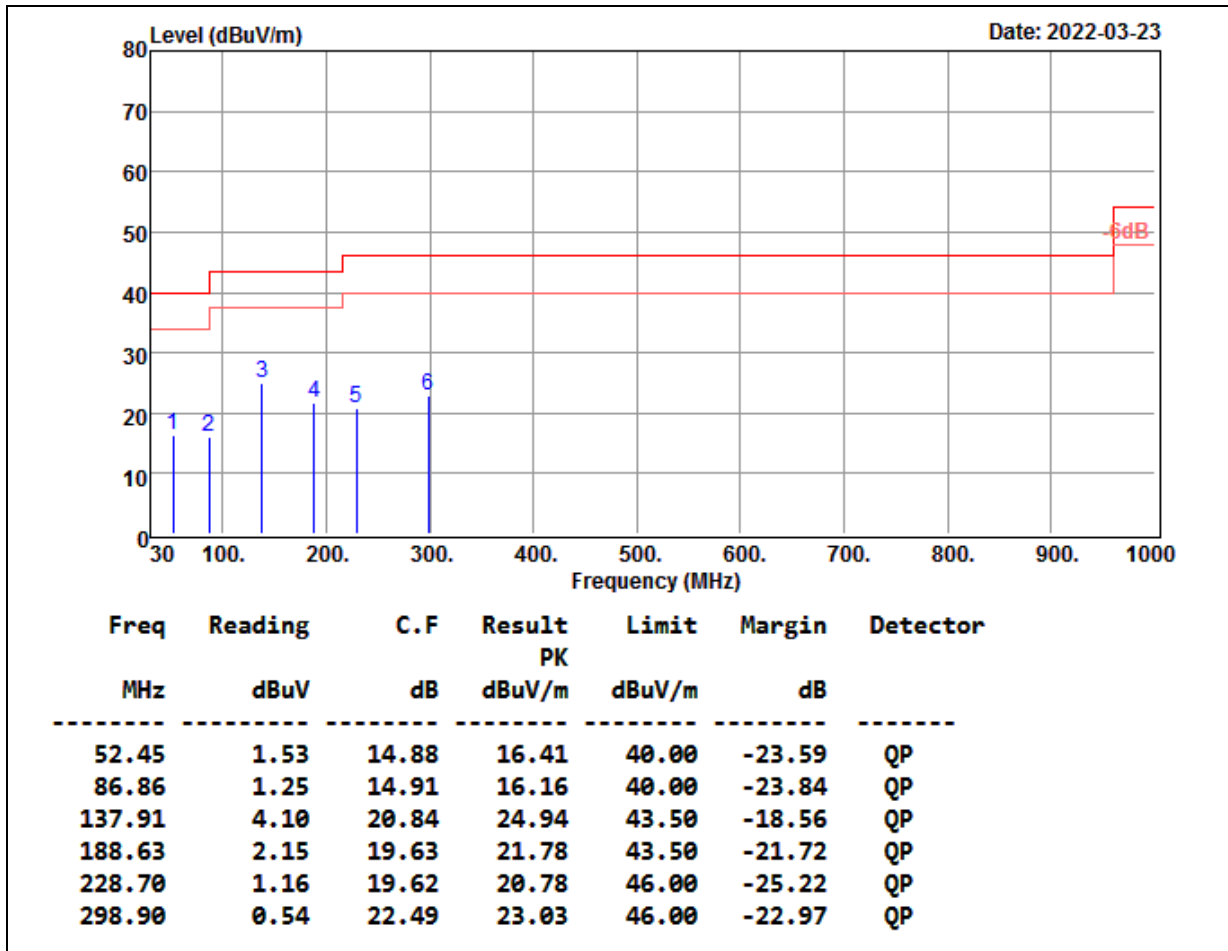

Remark:

1. No emission found between lowest internal used/generated frequency to 30MHz (9kHz~30MHz).
2. Radiated emissions measured were made with an instrument using peak/quasi-peak detector mode.
3. Quasi-peak test would be performed if the peak result were greater than the quasi-peak limit or as required by the applicant.
4. Margin (dB) = Remark result (dBuV/m) – Quasi-peak limit (dBuV/m).

8.8.3 TRANSMITTER RADIATED EMISSION ABOVE 1 GHz

Product Name	AUTOMATIC WIRELESS TURNTABLE	Test Date	3/24/2022
Model Name	AT-LP3XBT	Test By	Peter Chu
Test Mode	CH Low TX / GFSK	Temp & Humidity	25.5°C, 54%

Horizontal

	TX mode / CH Low				Measurement Distance at 3m			Horizontal polarity		
	Freq.	Reading	AF	Cable Loss	Pre-amp	Filter	Level	Limit	Margin	Mark
	(MHz)	(dBμV)	(dB/m)	(dB)	(dB)	(dB)	(dBμV/m)	(dBμV/m)	(dB)	(P/Q/A)
*	1145.62	56.38	25.11	2.58	44.73	0.65	40.00	74.00	-34.00	P
*	1145.62	48.45	25.11	2.58	44.73	0.65	32.07	54.00	-21.93	A
*	1533.65	58.58	26.87	2.78	44.60	0.73	44.36	74.00	-29.64	P
*	1533.65	47.25	26.87	2.78	44.60	0.73	33.03	54.00	-20.97	A
*	4803.76	57.60	33.07	4.38	42.51	0.57	53.12	74.00	-20.88	P
*	4803.76	50.11	33.07	4.38	42.51	0.57	45.63	54.00	-8.37	A

Vertical

	TX mode / CH Low				Measurement Distance at 3m			Vertical polarity		
	Freq.	Reading	AF	Cable Loss	Pre-amp	Filter	Level	Limit	Margin	Mark
	(MHz)	(dBμV)	(dB/m)	(dB)	(dB)	(dB)	(dBμV/m)	(dBμV/m)	(dB)	(P/Q/A)
*	1112.16	63.63	24.97	2.56	44.74	0.65	47.08	74.00	-26.92	P
*	1112.16	53.58	24.97	2.56	44.74	0.65	37.03	54.00	-16.97	A
*	1562.22	59.25	27.10	2.78	44.56	0.77	45.34	74.00	-28.66	P
*	1562.22	53.39	27.10	2.78	44.56	0.77	39.48	54.00	-14.52	A
*	4804.22	56.98	33.07	4.38	42.51	0.57	52.50	74.00	-21.50	P
*	4804.22	48.32	33.07	4.38	42.51	0.57	43.84	54.00	-10.16	A

Remark:

1. AF: Antenna Factor, Cable: Cable Loss, Pre-Amp: Preamplifier gain, Filter: High Pass Filter Insertion Loss (3.5GHz)
2. Spectrum analyzer setting P(Peak): RBW=1MHz, VBW=3MHz, A(Average): RBW=1MHz, VBW 1/T
3. The result basic equation calculation is as follow:
Level = Reading + AF + Cable – Preamp + Filter, Margin = Level-Limit
4. The other emission levels were 10dB below the limit
5. The test distance is 3m.
6. *=Restricted bands of operation

Report No.: TMTN2202000174NR

Product Name	AUTOMATIC WIRELESS TURNTABLE	Test Date	3/24/2022
Model Name	AT-LP3XBT	Test By	Peter Chu
Test Mode	CH Mid TX / GFSK	Temp & Humidity	25.5°C, 54%

Horizontal

	TX mode / CH Mid				Measurement Distance at 3m			Horizontal polarity		
	Freq. (MHz)	Reading (dBμV)	AF (dB/m)	Cable Loss (dB)	Pre-amp (dB)	Filter (dB)	Level (dBμV/m)	Limit (dBμV/m)	Margin (dB)	Mark (P/Q/A)
*	1145.62	56.38	25.11	2.58	44.73	0.65	40.00	74.00	-34.00	P
*	1145.62	48.45	25.11	2.58	44.73	0.65	32.07	54.00	-21.93	A
*	1533.65	58.58	26.87	2.78	44.60	0.73	44.36	74.00	-29.64	P
*	1533.65	47.25	26.87	2.78	44.60	0.73	33.03	54.00	-20.97	A
*	4803.76	57.60	33.07	4.38	42.51	0.57	53.12	74.00	-20.88	P
*	4803.76	50.11	33.07	4.38	42.51	0.57	45.63	54.00	-8.37	A

Vertical

	TX mode / CH Mid				Measurement Distance at 3m			Vertical polarity		
	Freq. (MHz)	Reading (dBμV)	AF (dB/m)	Cable Loss (dB)	Pre-amp (dB)	Filter (dB)	Level (dBμV/m)	Limit (dBμV/m)	Margin (dB)	Mark (P/Q/A)
*	1112.16	63.63	24.97	2.56	44.74	0.65	47.08	74.00	-26.92	P
*	1112.16	53.58	24.97	2.56	44.74	0.65	37.03	54.00	-16.97	A
*	1562.22	59.25	27.10	2.78	44.56	0.77	45.34	74.00	-28.66	P
*	1562.22	53.39	27.10	2.78	44.56	0.77	39.48	54.00	-14.52	A
*	4804.22	56.98	33.07	4.38	42.51	0.57	52.50	74.00	-21.50	P
*	4804.22	48.32	33.07	4.38	42.51	0.57	43.84	54.00	-10.16	A

Remark:

1. AF: Antenna Factor, Cable: Cable Loss, Pre-Amp: Preamplifier gain, Filter: High Pass Filter Insertion Loss (3.5GHz)
2. Spectrum analyzer setting P(Peak): RBW=1MHz, VBW=3MHz, A(Average): RBW=1MHz, VBW 1/T
3. The result basic equation calculation is as follow:
Level = Reading + AF + Cable – Preamp + Filter, Margin = Level-Limit
4. The other emission levels were 10dB below the limit
5. The test distance is 3m.
6. *=Restricted bands of operation

Product Name	AUTOMATIC WIRELESS TURNTABLE	Test Date	3/24/2022
Model Name	AT-LP3XBT	Test By	Peter Chu
Test Mode	CH High TX / GFSK	Temp & Humidity	25.5°C, 54%

Horizontal

	TX mode / CH High				Measurement Distance at 3m				Horizontal polarity	
	Freq. (MHz)	Reading (dBμV)	AF (dB/m)	Cable Loss (dB)	Pre-amp (dB)	Filter (dB)	Level (dBμV/m)	Limit (dBμV/m)	Margin (dB)	Mark (P/Q/A)
*	1145.70	56.35	25.11	2.58	44.73	0.65	39.97	74.00	-34.03	P
*	1145.70	48.66	25.11	2.58	44.73	0.65	32.28	54.00	-21.72	A
*	1533.76	58.75	26.87	2.78	44.60	0.73	44.53	74.00	-29.47	P
*	1533.76	47.32	26.87	2.78	44.60	0.73	33.10	54.00	-20.90	A
*	4881.89	57.87	33.32	4.43	42.50	0.57	53.69	74.00	-20.31	P
*	4881.89	49.20	33.32	4.43	42.50	0.57	45.02	54.00	-8.98	A

Vertical

	TX mode / CH High				Measurement Distance at 3m				Vertical polarity	
	Freq. (MHz)	Reading (dBμV)	AF (dB/m)	Cable Loss (dB)	Pre-amp (dB)	Filter (dB)	Level (dBμV/m)	Limit (dBμV/m)	Margin (dB)	Mark (P/Q/A)
*	1112.23	63.39	24.97	2.56	44.74	0.65	46.84	74.00	-27.16	P
*	1112.23	53.70	24.97	2.56	44.74	0.65	37.15	54.00	-16.85	A
*	1562.45	59.45	27.10	2.78	44.56	0.77	45.54	74.00	-28.46	P
*	1562.45	53.58	27.10	2.78	44.56	0.77	39.67	54.00	-14.33	A
*	4882.09	57.07	33.32	4.43	42.50	0.57	52.89	74.00	-21.11	P
*	4882.09	47.95	33.32	4.43	42.50	0.57	43.77	54.00	-10.23	A

Remark:

1. AF: Antenna Factor, Cable: Cable Loss, Pre-Amp: Preamplifier gain, Filter: High Pass Filter Insertion Loss (3.5GHz)
2. Spectrum analyzer setting P(Peak): RBW=1MHz, VBW=3MHz, A(Average): RBW=1MHz, VBW 1/T
3. The result basic equation calculation is as follow:
Level = Reading + AF + Cable – Preamp + Filter, Margin = Level-Limit
4. The other emission levels were 10dB below the limit
5. The test distance is 3m.
6. *=Restricted bands of operation

Report No.: TMTN2202000174NR

Product Name	AUTOMATIC WIRELESS TURNTABLE	Test Date	3/24/2022
Model Name	AT-LP3XBT	Test By	Peter Chu
Test Mode	CH Low TX / 8-DPSK	Temp & Humidity	25.5°C, 54%

Horizontal

	TX mode / CH Low				Measurement Distance at 3m				Horizontal polarity	
	Freq. (MHz)	Reading (dBμV)	AF (dB/m)	Cable Loss (dB)	Pre-amp (dB)	Filter (dB)	Level (dBμV/m)	Limit (dBμV/m)	Margin (dB)	Mark (P/Q/A)
*	1145.52	56.65	25.11	2.58	44.73	0.65	40.27	74.00	-33.73	P
*	1145.52	48.72	25.11	2.58	44.73	0.65	32.34	54.00	-21.66	A
*	1533.66	58.42	26.87	2.78	44.60	0.73	44.20	74.00	-29.80	P
*	1533.66	47.58	26.87	2.78	44.60	0.73	33.36	54.00	-20.64	A
*	4804.05	57.83	33.07	4.38	42.51	0.57	53.35	74.00	-20.65	P
*	4804.05	48.17	33.07	4.38	42.51	0.57	43.69	54.00	-10.31	A

Vertical

	TX mode / CH Low				Measurement Distance at 3m				Vertical polarity	
	Freq. (MHz)	Reading (dBμV)	AF (dB/m)	Cable Loss (dB)	Pre-amp (dB)	Filter (dB)	Level (dBμV/m)	Limit (dBμV/m)	Margin (dB)	Mark (P/Q/A)
*	1111.95	63.58	24.97	2.56	44.74	0.65	47.03	74.00	-26.97	P
*	1111.95	53.63	24.97	2.56	44.74	0.65	37.08	54.00	-16.92	A
*	1562.25	59.44	27.10	2.78	44.56	0.77	45.53	74.00	-28.47	P
*	1562.25	53.82	27.10	2.78	44.56	0.77	39.91	54.00	-14.09	A
*	4804.24	56.88	33.07	4.38	42.51	0.57	52.40	74.00	-21.60	P
*	4804.24	46.82	33.07	4.38	42.51	0.57	42.34	54.00	-11.66	A

Remark:

1. AF: Antenna Factor, Cable: Cable Loss, Pre-Amp: Preamplifier gain, Filter: High Pass Filter Insertion Loss (3.5GHz)
2. Spectrum analyzer setting P(Peak): RBW=1MHz, VBW=3MHz, A(Average): RBW=1MHz, VBW 1/T
3. The result basic equation calculation is as follow:

$$\text{Level} = \text{Reading} + \text{AF} + \text{Cable} - \text{Preamp} + \text{Filter}, \text{Margin} = \text{Level} - \text{Limit}$$
4. The other emission levels were 10dB below the limit
5. The test distance is 3m.
6. *=Restricted bands of operation

Report No.: TMTN2202000174NR

Product Name	AUTOMATIC WIRELESS TURNTABLE	Test Date	3/24/2022
Model Name	AT-LP3XBT	Test By	Peter Chu
Test Mode	CH Mid TX / 8-DPSK	Temp & Humidity	25.5°C, 54%

Horizontal

	TX mode / CH Mid				Measurement Distance at 3m				Horizontal polarity	
	Freq.	Reading	AF	Cable Loss	Pre-amp	Filter	Level	Limit	Margin	Mark
	(MHz)	(dBμV)	(dB/m)	(dB)	(dB)	(dB)	(dBμV/m)	(dBμV/m)	(dB)	(P/Q/A)
*	1145.64	56.65	25.11	2.58	44.73	0.65	40.27	74.00	-33.73	P
*	1145.64	48.78	25.11	2.58	44.73	0.65	32.40	54.00	-21.60	A
*	1533.72	58.52	26.87	2.78	44.60	0.73	44.30	74.00	-29.70	P
*	1533.72	47.33	26.87	2.78	44.60	0.73	33.11	54.00	-20.89	A
*	4882.15	57.88	33.32	4.43	42.50	0.57	53.70	74.00	-20.30	P
*	4882.15	49.30	33.32	4.43	42.50	0.57	45.12	54.00	-8.88	A

Vertical

	TX mode / CH Mid				Measurement Distance at 3m				Vertical polarity	
	Freq.	Reading	AF	Cable Loss	Pre-amp	Filter	Level	Limit	Margin	Mark
	(MHz)	(dBμV)	(dB/m)	(dB)	(dB)	(dB)	(dBμV/m)	(dBμV/m)	(dB)	(P/Q/A)
*	1112.18	63.46	24.97	2.56	44.74	0.65	46.91	74.00	-27.09	P
*	1112.18	53.68	24.97	2.56	44.74	0.65	37.13	54.00	-16.87	A
*	1562.18	59.25	27.10	2.78	44.56	0.77	45.34	74.00	-28.66	P
*	1562.18	53.56	27.10	2.78	44.56	0.77	39.65	54.00	-14.35	A
*	4882.16	56.80	33.32	4.43	42.50	0.57	52.62	74.00	-21.38	P
*	4882.16	46.92	33.32	4.43	42.50	0.57	42.74	54.00	-11.26	A

Remark:

1. AF: Antenna Factor, Cable: Cable Loss, Pre-Amp: Preamplifier gain, Filter: High Pass Filter Insertion Loss (3.5GHz)
2. Spectrum analyzer setting P(Peak): RBW=1MHz, VBW=3MHz, A(Average): RBW=1MHz, VBW 1/T
3. The result basic equation calculation is as follow:
Level = Reading + AF + Cable – Preamp + Filter, Margin = Level-Limit
4. The other emission levels were 10dB below the limit
5. The test distance is 3m.
6. *=Restricted bands of operation

Product Name	AUTOMATIC WIRELESS TURNTABLE	Test Date	3/24/2022
Model Name	AT-LP3XBT	Test By	Peter Chu
Test Mode	CH High TX / 8-DPSK	Temp & Humidity	25.5°C, 54%

Horizontal

	TX mode / CH High				Measurement Distance at 3m				Horizontal polarity	
	Freq.	Reading	AF	Cable Loss	Pre-amp	Filter	Level	Limit	Margin	Mark
	(MHz)	(dBμV)	(dB/m)	(dB)	(dB)	(dB)	(dBμV/m)	(dBμV/m)	(dB)	(P/Q/A)
*	1145.68	56.48	25.11	2.58	44.73	0.65	40.10	74.00	-33.90	P
*	1145.68	49.05	25.11	2.58	44.73	0.65	32.67	54.00	-21.33	A
*	1534.06	58.68	26.87	2.78	44.60	0.73	44.46	74.00	-29.54	P
*	1534.06	47.36	26.87	2.78	44.60	0.73	33.14	54.00	-20.86	A
*	4959.93	56.79	33.57	4.47	42.49	0.56	52.90	74.00	-21.10	P
*	4959.93	47.56	33.57	4.47	42.49	0.56	43.67	54.00	-10.33	A

Vertical

	TX mode / CH High				Measurement Distance at 3m				Vertical polarity	
	Freq.	Reading	AF	Cable Loss	Pre-amp	Filter	Level	Limit	Margin	Mark
	(MHz)	(dBμV)	(dB/m)	(dB)	(dB)	(dB)	(dBμV/m)	(dBμV/m)	(dB)	(P/Q/A)
*	1112.25	63.38	24.97	2.56	44.74	0.65	46.83	74.00	-27.17	P
*	1112.25	53.46	24.97	2.56	44.74	0.65	36.91	54.00	-17.09	A
*	1562.56	59.47	27.10	2.78	44.56	0.77	45.56	74.00	-28.44	P
*	1562.56	53.85	27.10	2.78	44.56	0.77	39.94	54.00	-14.06	A
*	4959.85	56.25	33.57	4.47	42.49	0.56	52.36	74.00	-21.64	P
*	4959.85	45.74	33.57	4.47	42.49	0.56	41.85	54.00	-12.15	A

Remark:

1. AF: Antenna Factor, Cable: Cable Loss, Pre-Amp: Preamplifier gain, Filter: High Pass Filter Insertion Loss (3.5GHz)
2. Spectrum analyzer setting P(Peak): RBW=1MHz, VBW=3MHz, A(Average): RBW=1MHz, VBW 1/T
3. The result basic equation calculation is as follow:
Level = Reading + AF + Cable – Preamp + Filter, Margin = Level-Limit
4. The other emission levels were 10dB below the limit
5. The test distance is 3m.
6. *=Restricted bands of operation

8.8.4 RESTRICTED BAND EDGES

Product Name	AUTOMATIC WIRELESS TURNTABLE	Test Date	2022/03/19
Model Name	AT-LP3XBT	Test By	Ted Huang
Test Mode	CH Low TX / GFSK	Temp & Humidity	26.5°C, 54%

Horizontal

TX mode / CH Low				Measurement Distance at 3m				Horizontal polarity			
Freq.	Reading	AF	Cable Loss	Pre-amp	Atten	Filter	Level	Limit	Margin	Mark	
(MHz)	(dBμV)	(dB/m)	(dB)	(dB)	(dB)	(dB)	(dBμV/m)	(dBμV/m)	(dB)	(P/Q/A)	
* 2390.00	54.50	30.13	3.08	43.63	15.21	0.00	59.29	74.00	-14.71	P	
* 2390.00	44.93	30.13	3.08	43.63	15.21	0.00	49.72	54.00	-4.28	A	

Vertical

TX mode / CH Low				Measurement Distance at 3m				Vertical polarity			
Freq.	Reading	AF	Cable Loss	Pre-amp	Atten	Filter	Level	Limit	Margin	Mark	
(MHz)	(dBμV)	(dB/m)	(dB)	(dB)	(dB)	(dB)	(dBμV/m)	(dBμV/m)	(dB)	(P/Q/A)	
* 2390.00	54.37	30.13	3.08	43.63	15.21	0.00	59.16	74.00	-14.84	P	
* 2390.00	44.86	30.13	3.08	43.63	15.21	0.00	49.65	54.00	-4.35	A	

Product Name	AUTOMATIC WIRELESS TURNTABLE	Test Date	2022/03/19
Model Name	AT-LP3XBT	Test By	Ted Huang
Test Mode	CH High TX / GFSK	Temp & Humidity	26.5°C, 54%

Horizontal

TX mode / CH High				Measurement Distance at 3m				Horizontal polarity			
Freq.	Reading	AF	Cable Loss	Pre-amp	Atten	Filter	Level	Limit	Margin	Mark	
(MHz)	(dBμV)	(dB/m)	(dB)	(dB)	(dB)	(dB)	(dBμV/m)	(dBμV/m)	(dB)	(P/Q/A)	
* 2483.50	58.58	30.02	3.14	43.57	15.21	0.00	63.38	74.00	-10.62	P	
* 2483.50	46.04	30.02	3.14	43.57	15.21	0.00	50.84	54.00	-3.16	A	

Vertical

TX mode / CH High				Measurement Distance at 3m				Vertical polarity			
Freq.	Reading	AF	Cable Loss	Pre-amp	Atten	Filter	Level	Limit	Margin	Mark	
(MHz)	(dBμV)	(dB/m)	(dB)	(dB)	(dB)	(dB)	(dBμV/m)	(dBμV/m)	(dB)	(P/Q/A)	
* 2483.50	54.64	30.02	3.14	43.57	15.21	0.00	59.44	74.00	-14.56	P	
* 2483.50	45.41	30.02	3.14	43.57	15.21	0.00	50.21	54.00	-3.79	A	

Product Name	AUTOMATIC WIRELESS TURNTABLE	Test Date	2022/03/19
Model Name	AT-LP3XBT	Test By	Ted Huang
Test Mode	CH Low TX / 8-DPSK	Temp & Humidity	26.5°C, 54%

Horizontal

TX mode / CH Low				Measurement Distance at 3m				Horizontal polarity			
Freq.	Reading	AF	Cable Loss	Pre-amp	Atten	Filter	Level	Limit	Margin	Mark	
(MHz)	(dBμV)	(dB/m)	(dB)	(dB)	(dB)	(dB)	(dBμV/m)	(dBμV/m)	(dB)	(P/Q/A)	
* 2390.00	53.77	30.13	3.08	43.63	15.21	0.00	58.56	74.00	-15.44	P	
* 2390.00	44.78	30.13	3.08	43.63	15.21	0.00	49.57	54.00	-4.43	A	

Vertical

TX mode / CH Low				Measurement Distance at 3m				Vertical polarity			
Freq.	Reading	AF	Cable Loss	Pre-amp	Atten	Filter	Level	Limit	Margin	Mark	
(MHz)	(dBμV)	(dB/m)	(dB)	(dB)	(dB)	(dB)	(dBμV/m)	(dBμV/m)	(dB)	(P/Q/A)	
* 2390.00	54.04	30.13	3.08	43.63	15.21	0.00	58.83	74.00	-15.17	P	
* 2390.00	45.02	30.13	3.08	43.63	15.21	0.00	49.81	54.00	-4.19	A	

Product Name	AUTOMATIC WIRELESS TURNTABLE	Test Date	2022/03/19
Model Name	AT-LP3XBT	Test By	Ted Huang
Test Mode	CH High TX / 8-DPSK	Temp & Humidity	26.5°C, 54%

Horizontal

TX mode / CH High				Measurement Distance at 3m				Horizontal polarity			
Freq.	Reading	AF	Cable Loss	Pre-amp	Atten	Filter	Level	Limit	Margin	Mark	
(MHz)	(dBμV)	(dB/m)	(dB)	(dB)	(dB)	(dB)	(dBμV/m)	(dBμV/m)	(dB)	(P/Q/A)	
* 2483.50	55.52	30.02	3.14	43.57	15.21	0.00	60.32	74.00	-13.68	P	
* 2483.50	46.15	30.02	3.14	43.57	15.21	0.00	50.95	54.00	-3.05	A	

Vertical

TX mode / CH High				Measurement Distance at 3m				Vertical polarity			
Freq.	Reading	AF	Cable Loss	Pre-amp	Atten	Filter	Level	Limit	Margin	Mark	
(MHz)	(dBμV)	(dB/m)	(dB)	(dB)	(dB)	(dB)	(dBμV/m)	(dBμV/m)	(dB)	(P/Q/A)	
* 2483.50	54.90	30.02	3.14	43.57	15.21	0.00	59.70	74.00	-14.30	P	
* 2483.50	45.59	30.02	3.14	43.57	15.21	0.00	50.39	54.00	-3.61	A	

Report No.: TMTN2202000174NR

Detector Mode : Peak

Polarity : Horizontal

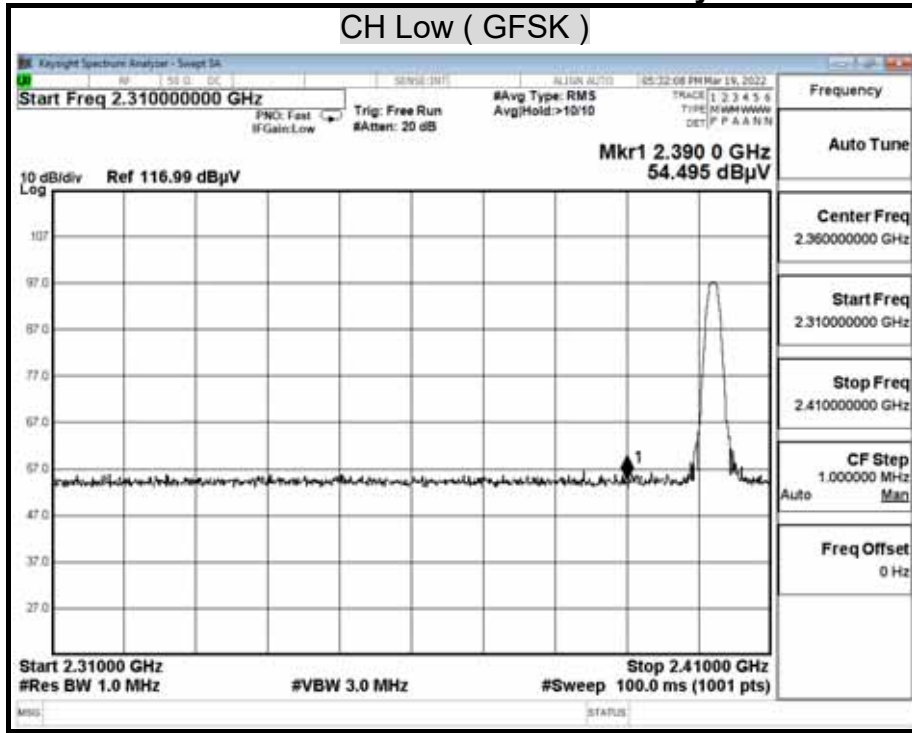

Detector Mode : Average

Polarity : Horizontal

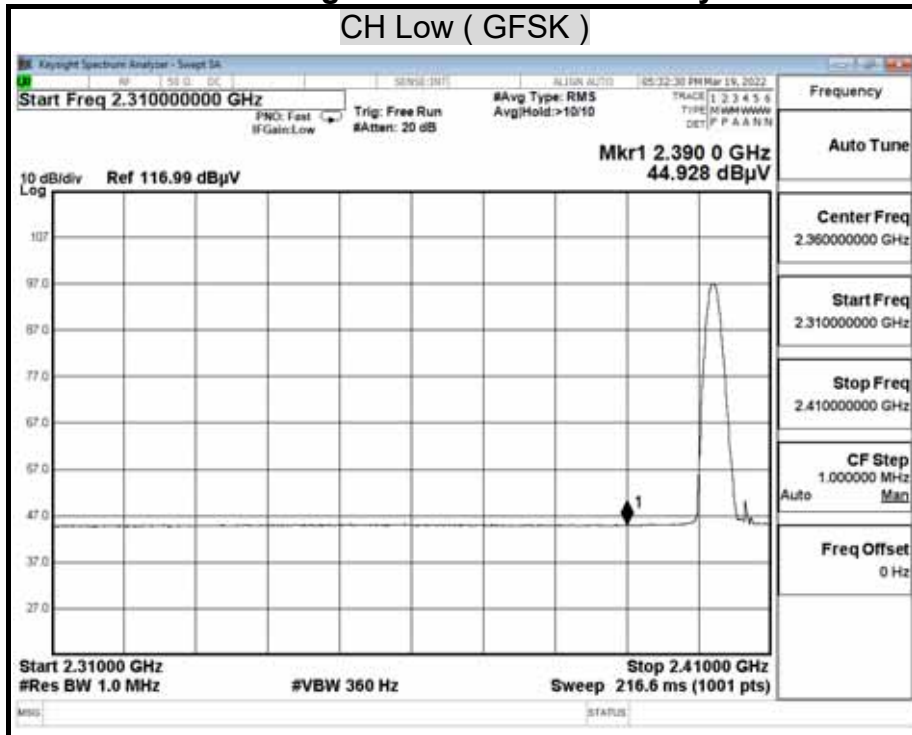

Detector Mode : Peak

Polarity : Vertical

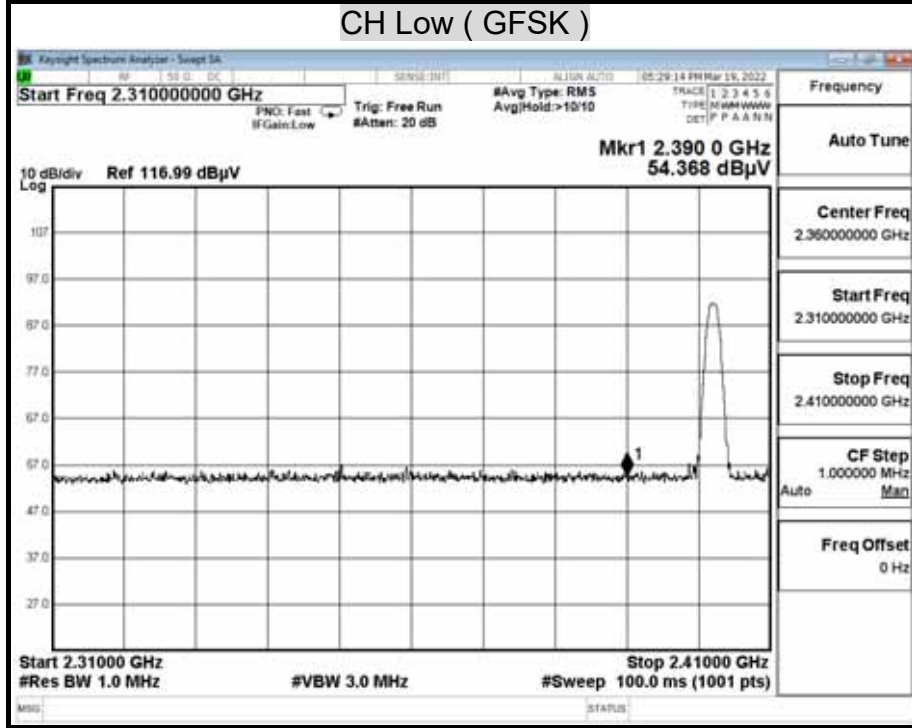

Detector Mode : Average

Polarity : Vertical

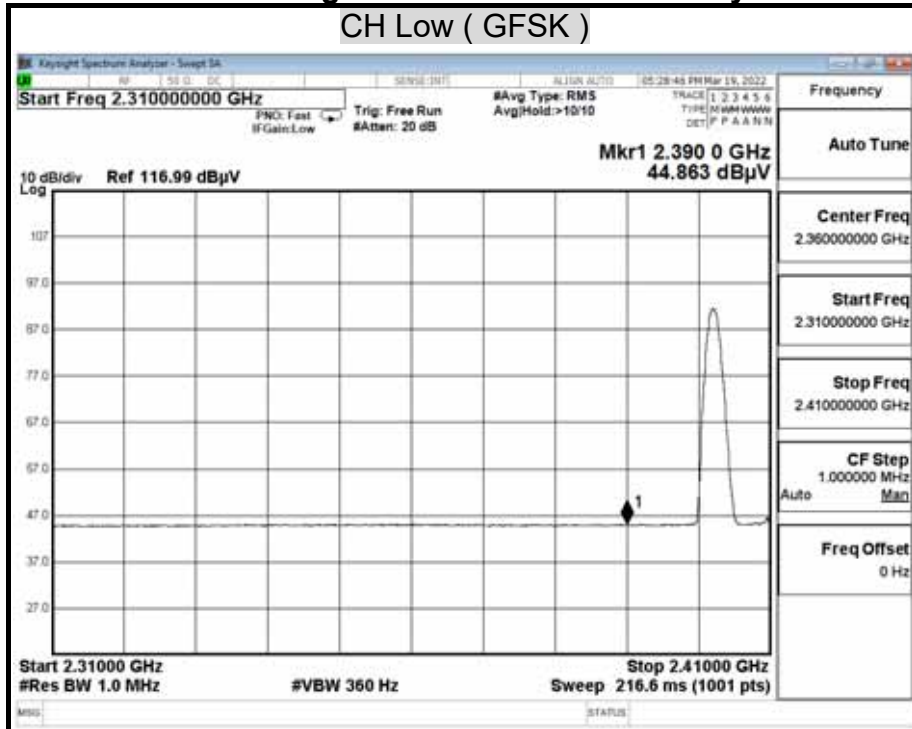

Detector Mode : Peak

Polarity : Horizontal

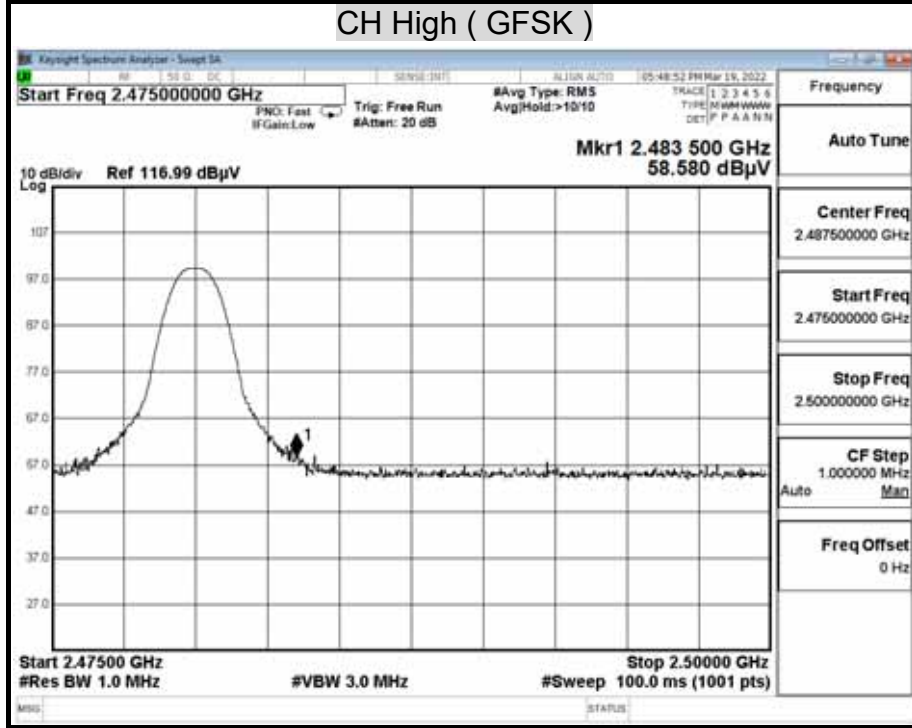

Detector Mode : Average

Polarity : Horizontal

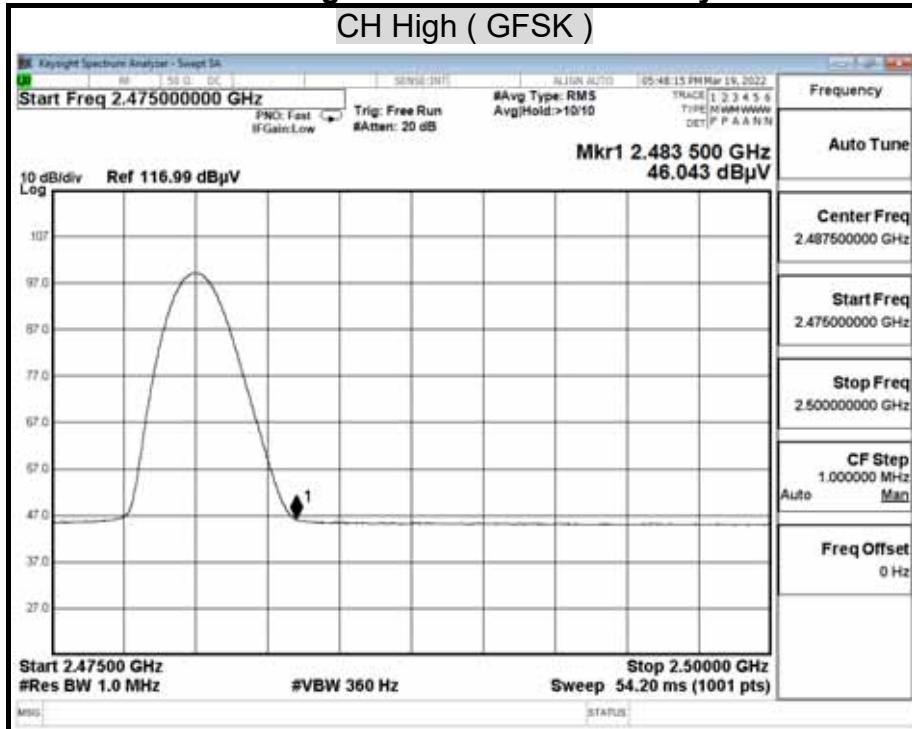

Detector Mode : Peak

Polarity : Vertical

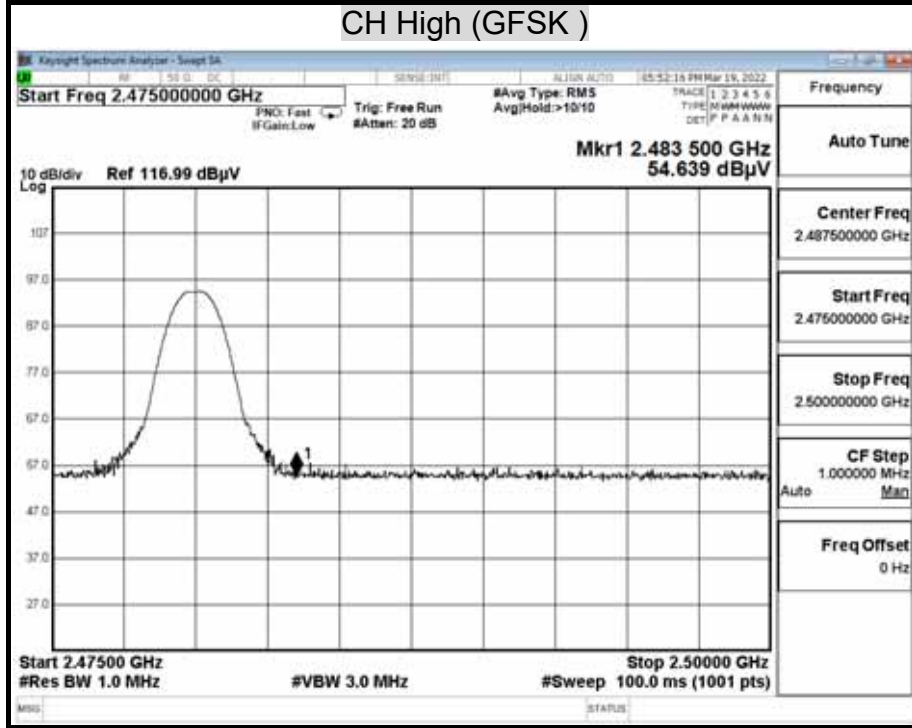

Detector Mode : Average

Polarity : Vertical

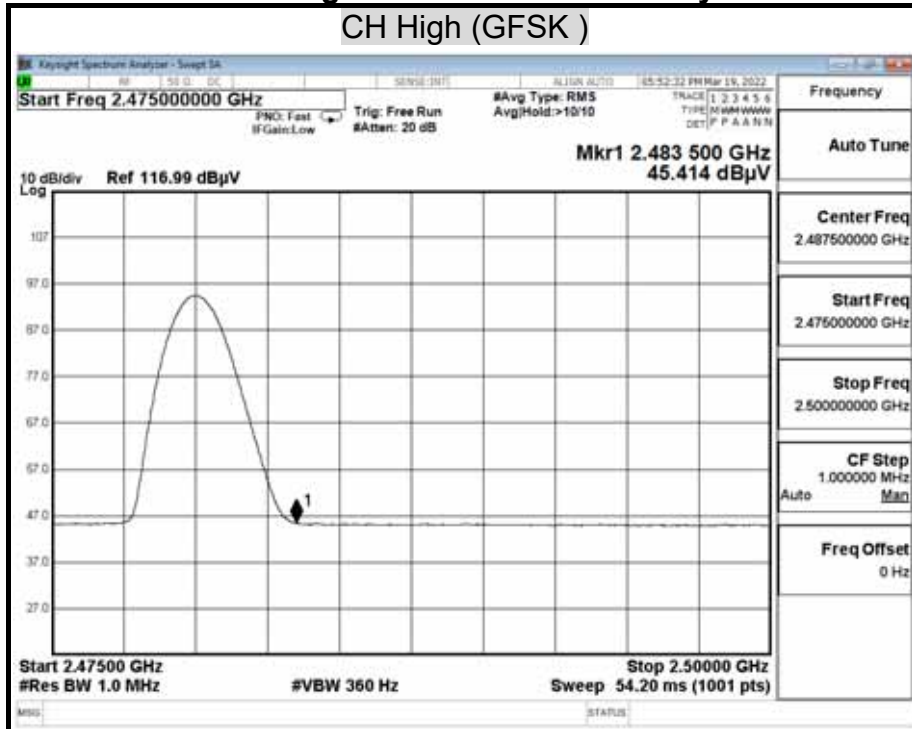

Detector Mode : Peak

Polarity : Horizontal

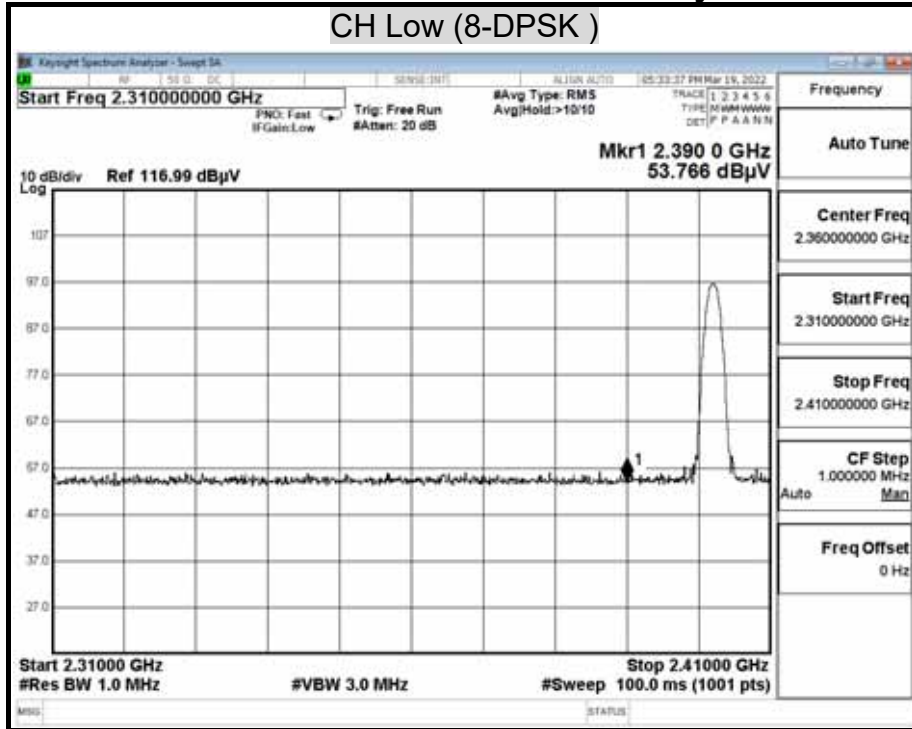

Detector Mode : Average

Polarity : Horizontal

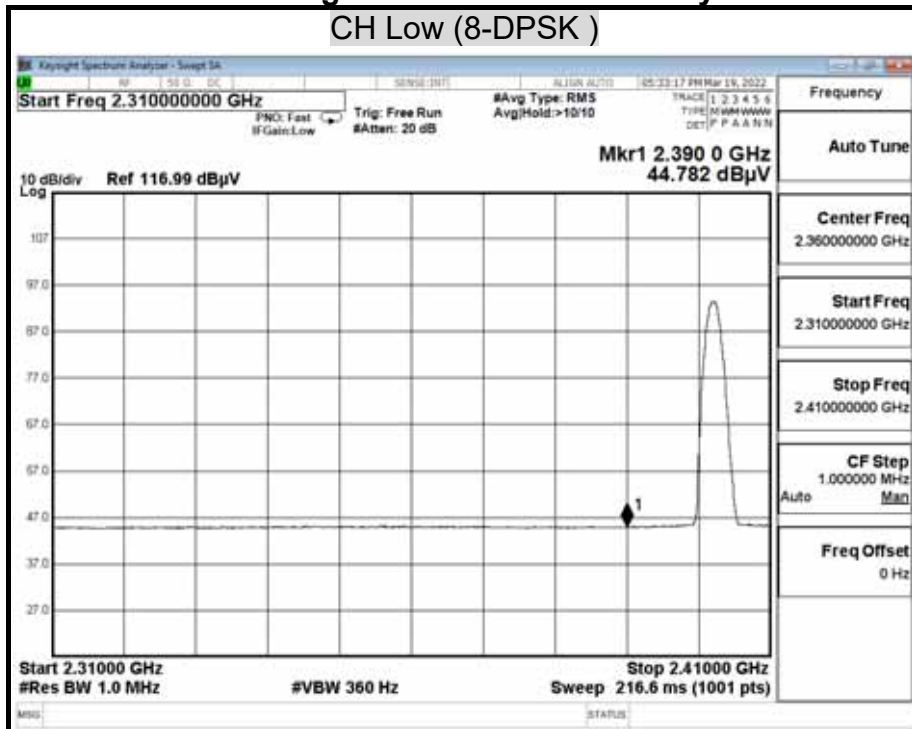

Detector Mode : Peak

Polarity : Vertical

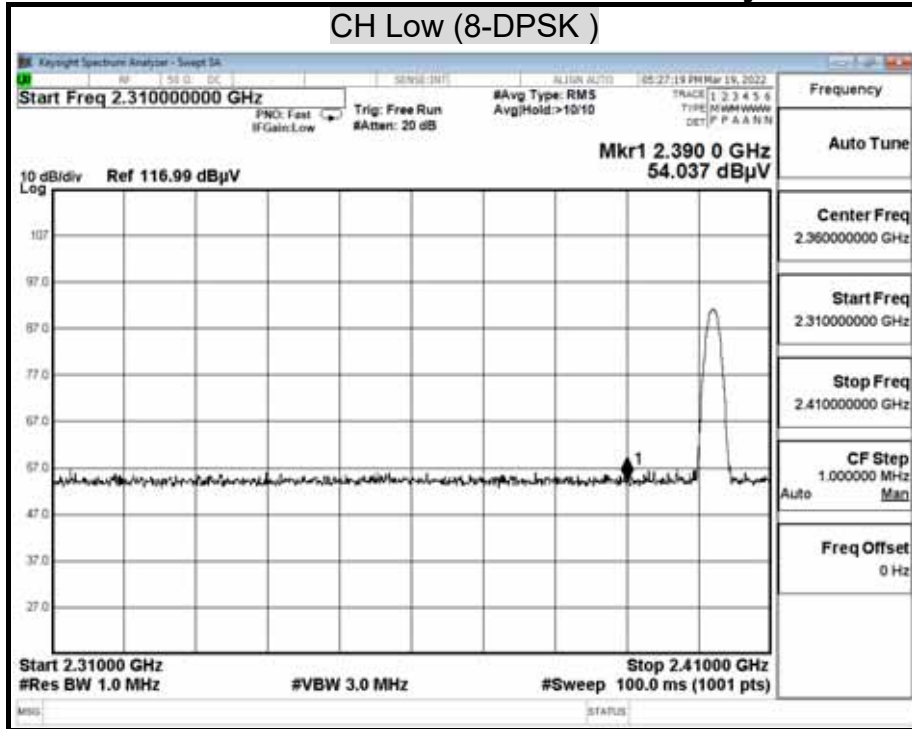

Detector Mode : Average

Polarity : Vertical

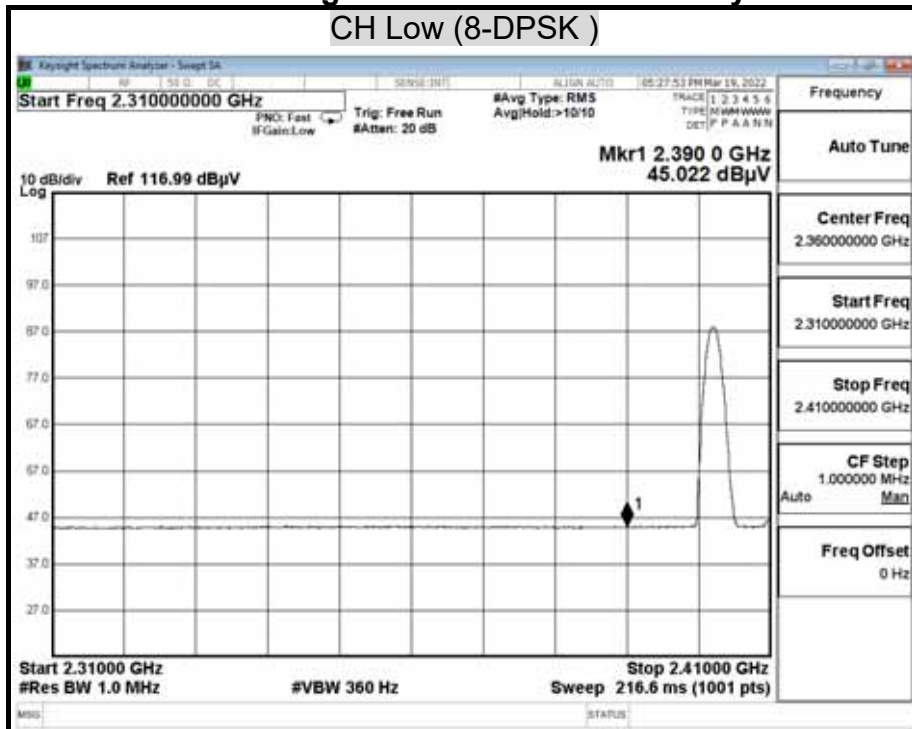

Detector Mode : Peak

Polarity : Horizontal

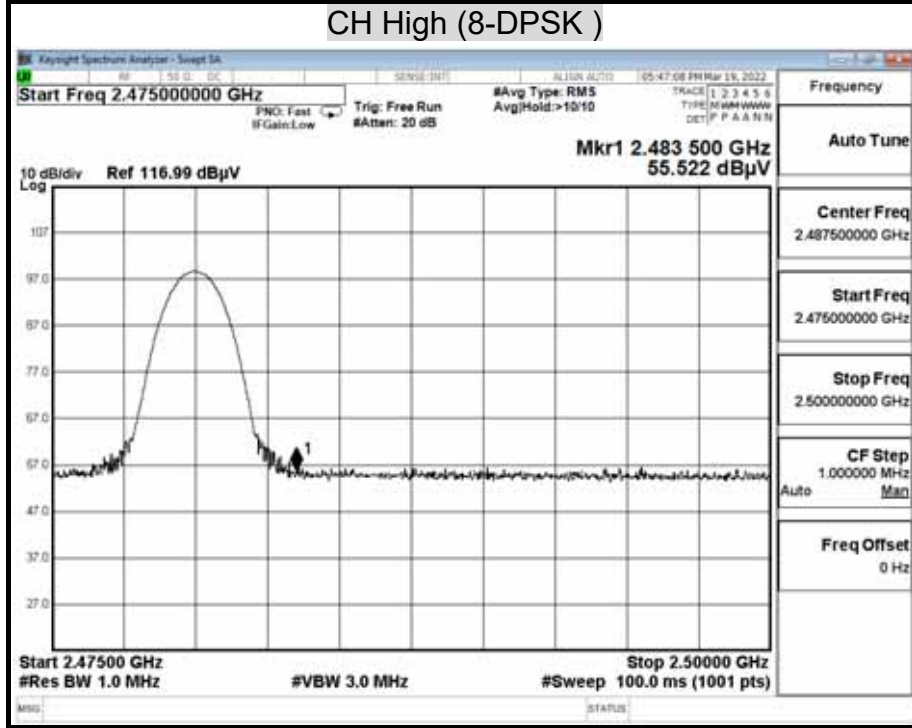

Detector Mode : Average

Polarity : Horizontal

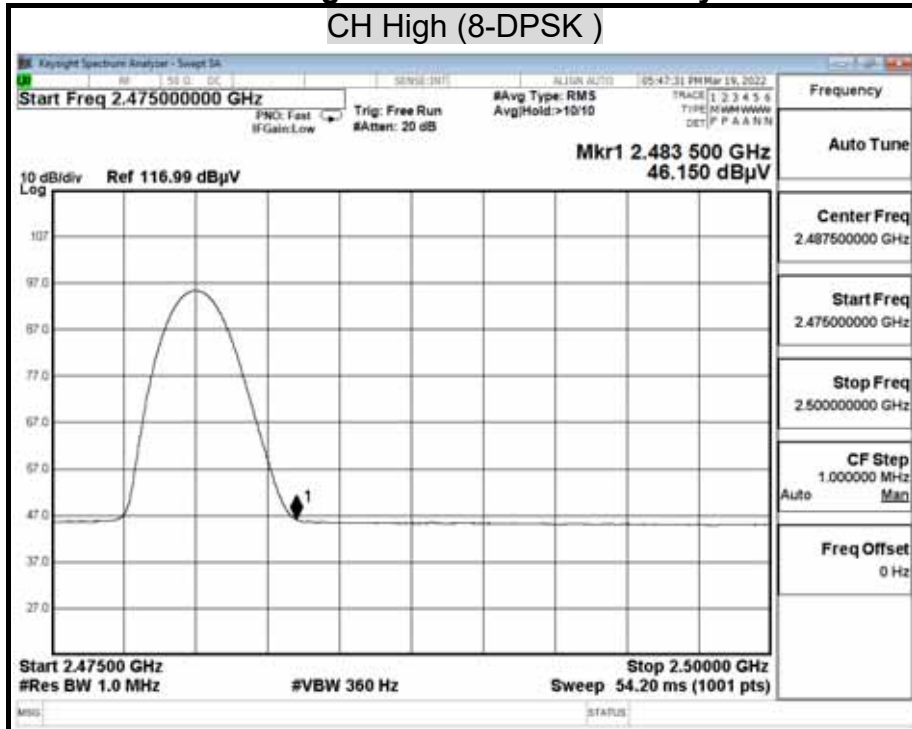

Detector Mode : Peak

Polarity : Vertical

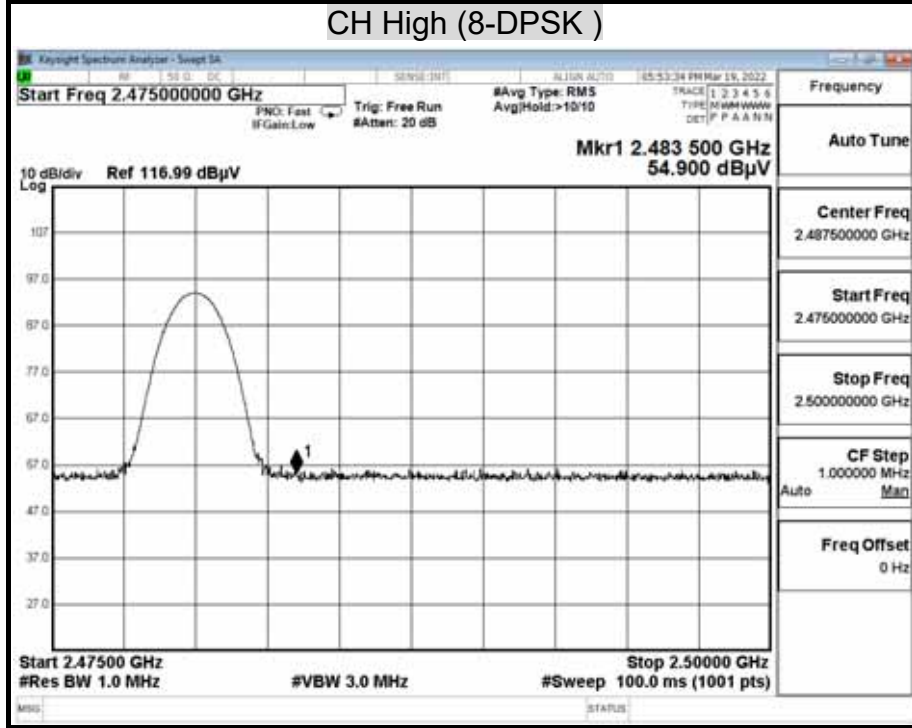

Detector Mode : Average

Polarity : Vertical

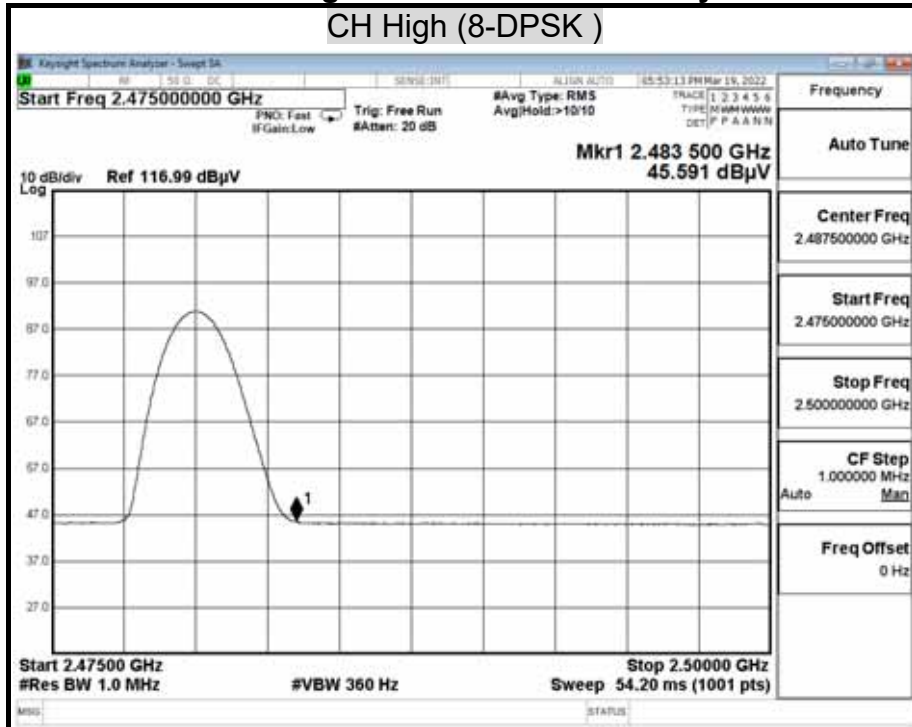

Report No.: TMTN2202000174NR

8.9 POWERLINE CONDUCTED EMISSIONS

LIMITS

§ 15.207 (a) Except as shown in paragraph (b) and (c) this section, for an intentional radiator that is designed to be connected to the public utility (AC) power line, the radio frequency voltage that is conducted back onto the AC power line on any frequency or frequencies within the band 150 kHz to 30 MHz shall not exceed the limits in the following table, as measured using a 50 μ H/50 ohms line impedance stabilization network (LISN). Compliance with the provisions of this paragraph shall be based on the measurement of the radio frequency voltage between each power line and ground at the power terminal.

The lower limit applies at the boundary between the frequency ranges.

Frequency of Emission (MHz)	Conducted limit (dB μ v)	
	Quasi-peak	Average
0.15 - 0.5	66 to 56	56 to 46
0.5 - 5	56	46
5 - 30	60	50

Report No.: TMTN2202000174NR

TEST SETUP

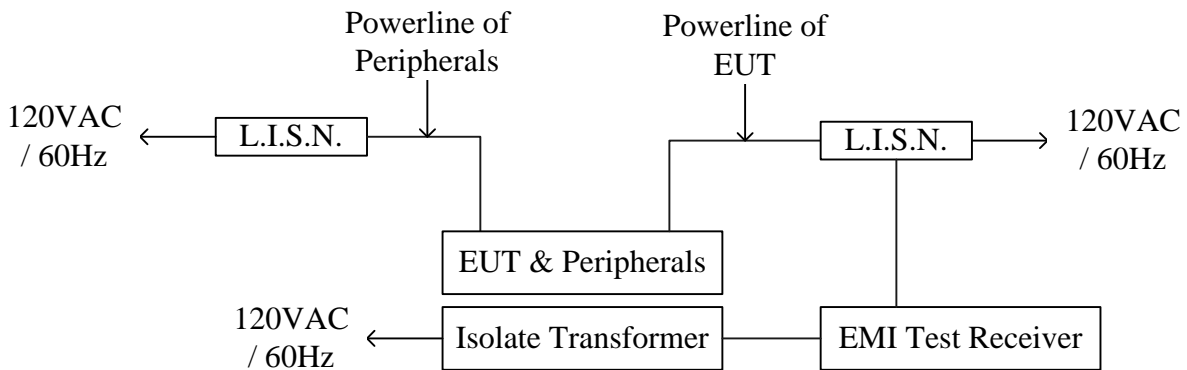
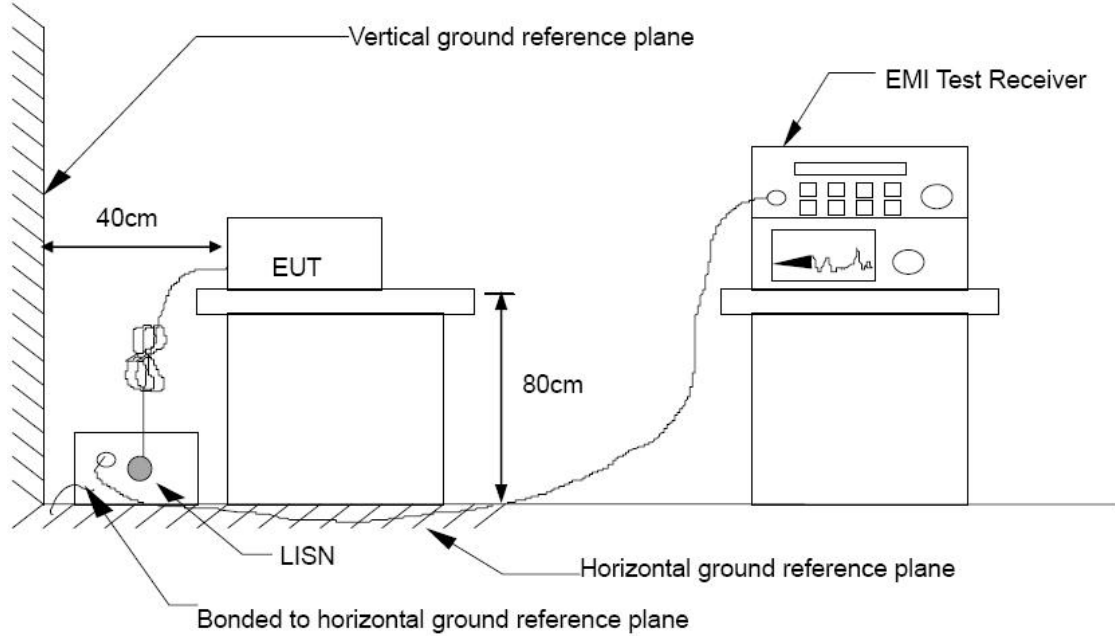

TEST PROCEDURE

The EUT is placed on a non-conducting table 40 cm from the vertical ground plane and 80cm above the horizontal ground plane. The EUT IS CONFIGURED IN ACCORDANCE WITH ANSI C63.10 : 2013.

The resolution bandwidth is set to 9 kHz for both quasi-peak detection and average detection measurements.

Line conducted data is recorded for both NEUTRAL and LINE.

Report No.: TMTN2202000174NR

TEST RESULTS

Test Voltage: AC 120V, 60Hz

Model No.	AT-LP3XBT	Test Mode	Normal Operation
Environmental Conditions	21.8 , 69% RH	Resolution Bandwidth	9 kHz
Tested by	Oz Ding		

LINE

(The chart below shows the highest readings taken from the final data.)

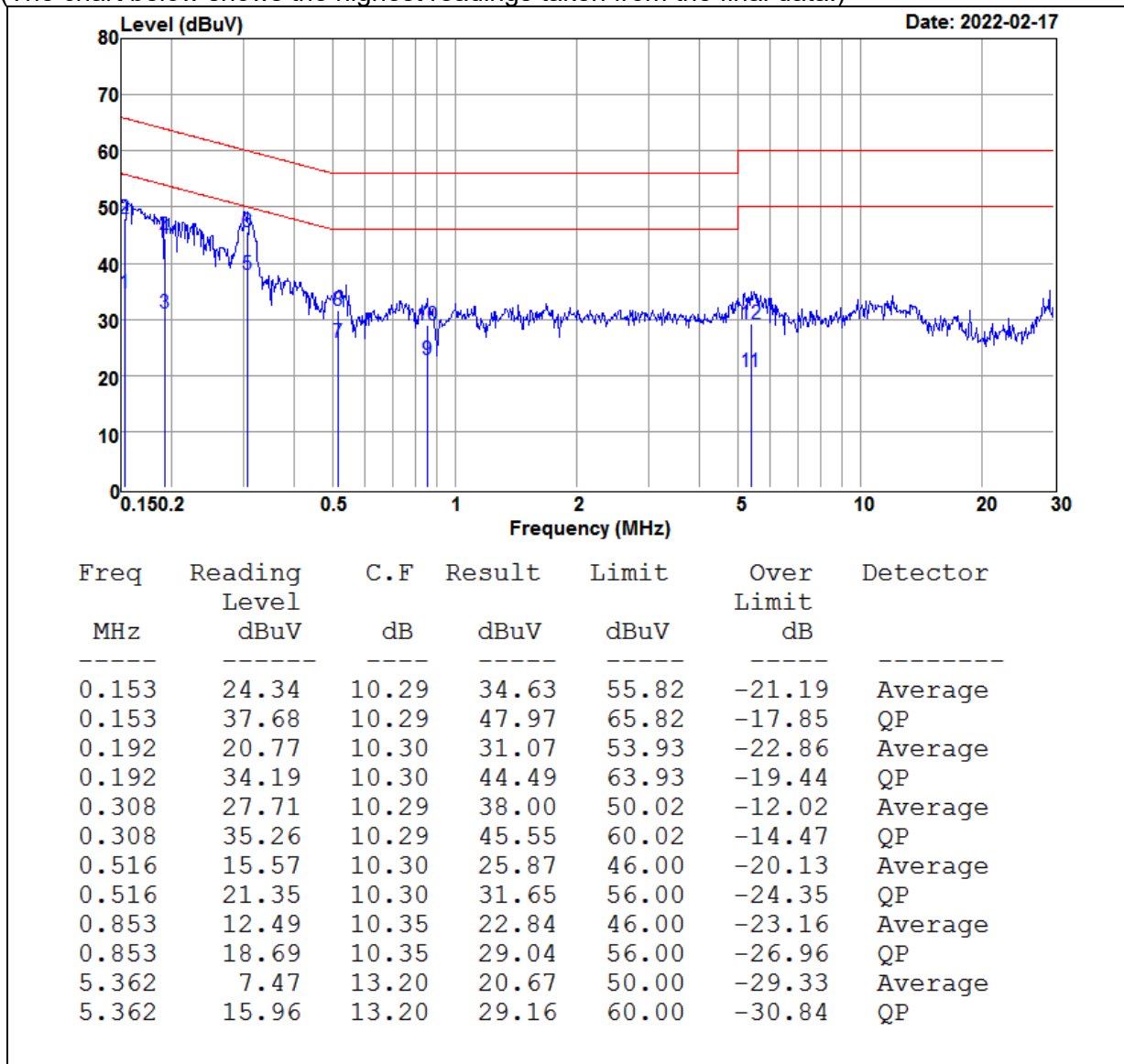

Report No.: TMTN2202000174NR

Model No.	AT-LP3XBT	Test Mode	Normal Operation
Environmental Conditions	21.8 , 69% RH	Resolution Bandwidth	9 kHz
Tested by	Oz Ding		

NEUTRAL

(The chart below shows the highest readings taken from the final data.)

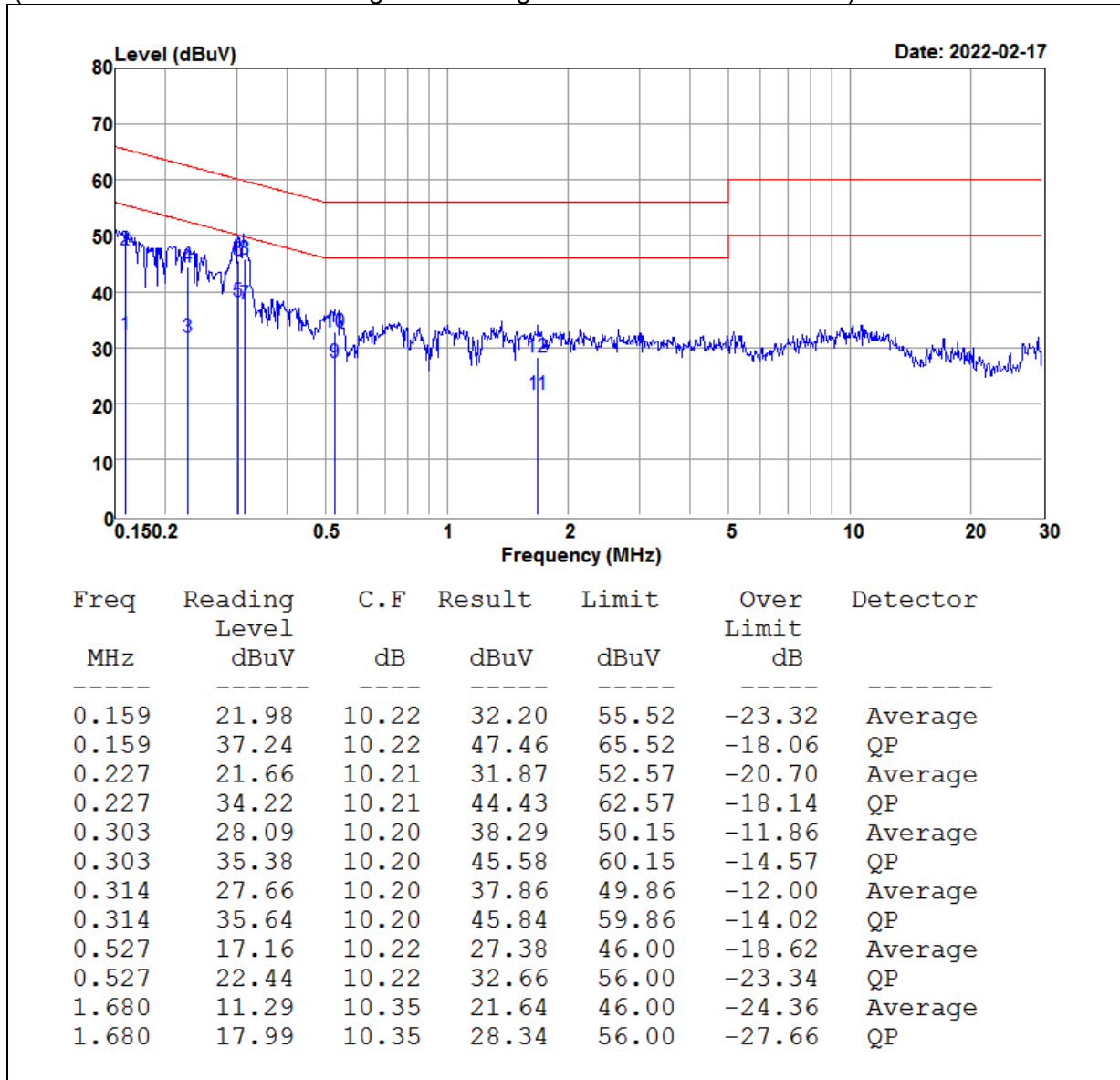

=== END of Report ===