

8.6 DUTY CYCLE

LIMIT

Nil (No dedicated limit specified in the Rules)

TEST SETUP

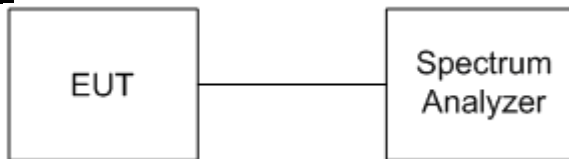

TEST PROCEDURE

1. Place the EUT on the table and set it in transmitting mode.
2. Remove the antenna from the EUT and then connect a low loss RF cable from the antenna port to the spectrum analyzer.
3. The zero-span mode on a spectrum analyzer or EMI receiver if the response time and spacing between bins on the sweep are sufficient to permit accurate measurements of the on and off times of the transmitted signal. Set the center frequency of the instrument to the center frequency of the transmission. Set $RBW \geq OBW$ if possible; otherwise, set RBW to the largest available value. Set $VBW \geq RBW$. Set detector = peak or average. The zero-span measurement method shall not be used unless both RBW and VBW are $> 50/T$ and the number of sweep points across duration T exceeds 100. (For example, if VBW and/or RBW are limited to 3 MHz, then the zero-span method of measuring duty cycle shall not be used if $T \leq 16.7$ microseconds.)

Report No.: T210622N01-RP1-1

TEST RESULTS

No non-compliance noted.

TEST DATA

Model Name	AT-LP3XBT	Test By	Ted Huang
Temp & Humidity	26.8°C, 56%	Test Date	2021/07/08

Modulation Type: GFSK / DH5

	us	Times	Ton	Total Ton time(ms)
Ton1	2900.000	1	2900	
Ton2		0	0	
Ton3			0	2.9
TP				3.76

Ton	2.900
TP(Ton+Toff)	3.760
Duty Cycle	0.771
Duty Factor	1.128

Modulation Type: 8-DPSK / 3-DH5

	us	Times	Ton	Total Ton time(ms)
Ton1	2920.000	1	2920	
Ton2		0	0	
Ton3			0	2.92
TP				3.76

Ton	2.920
TP(Ton+Toff)	3.760
Duty Cycle	0.777
Duty Factor	1.098

TEST PLOT

Duty Cycle

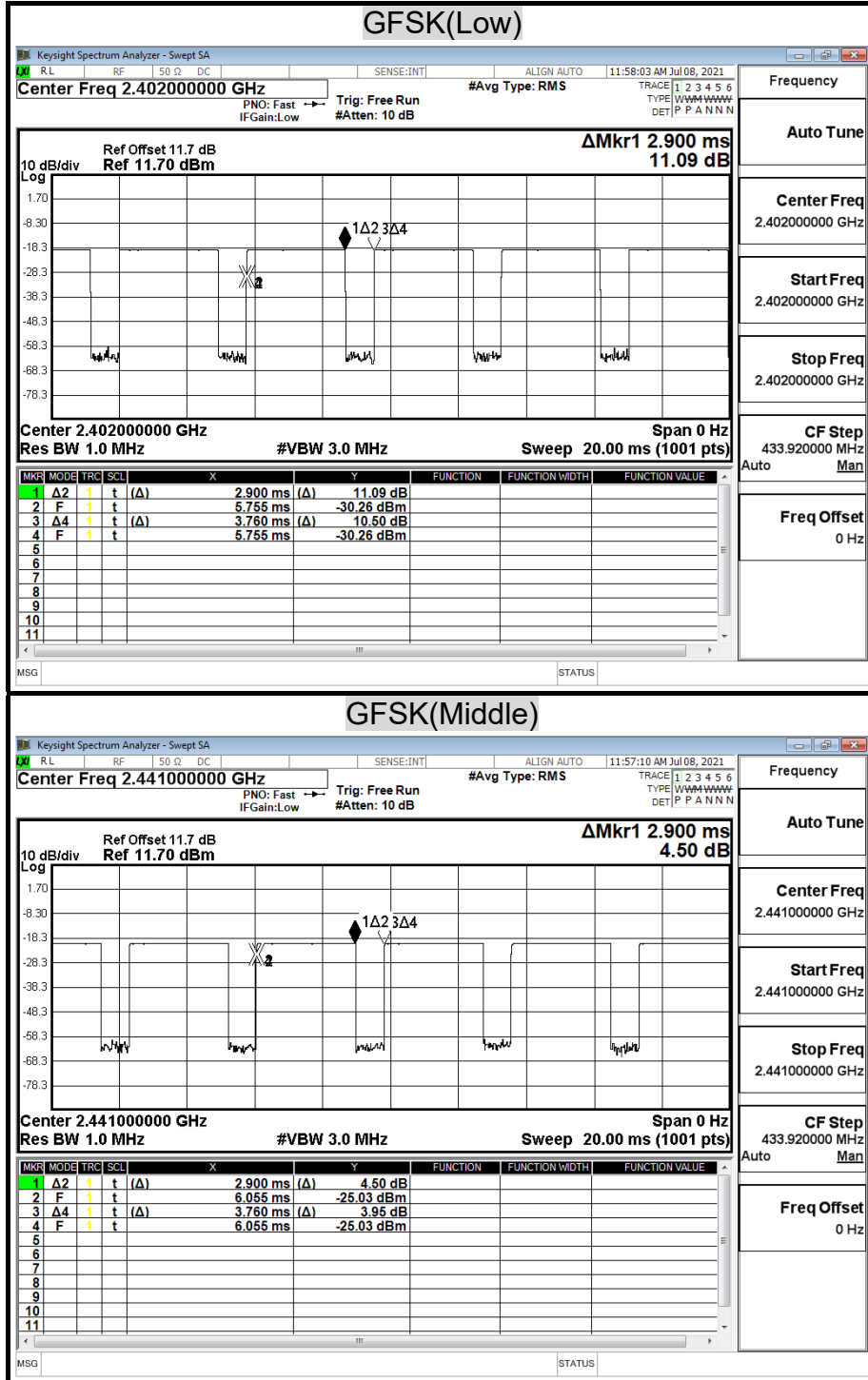

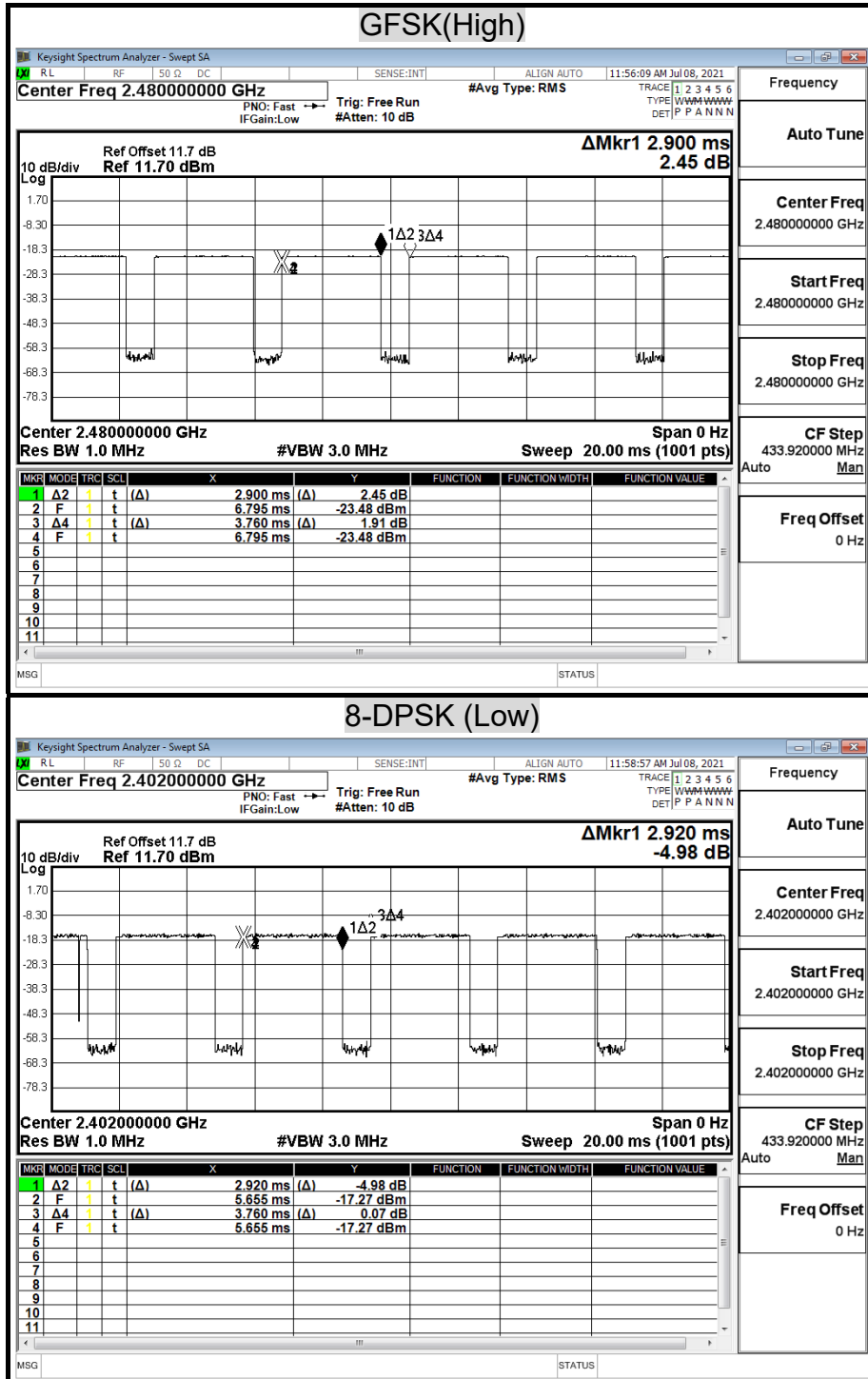

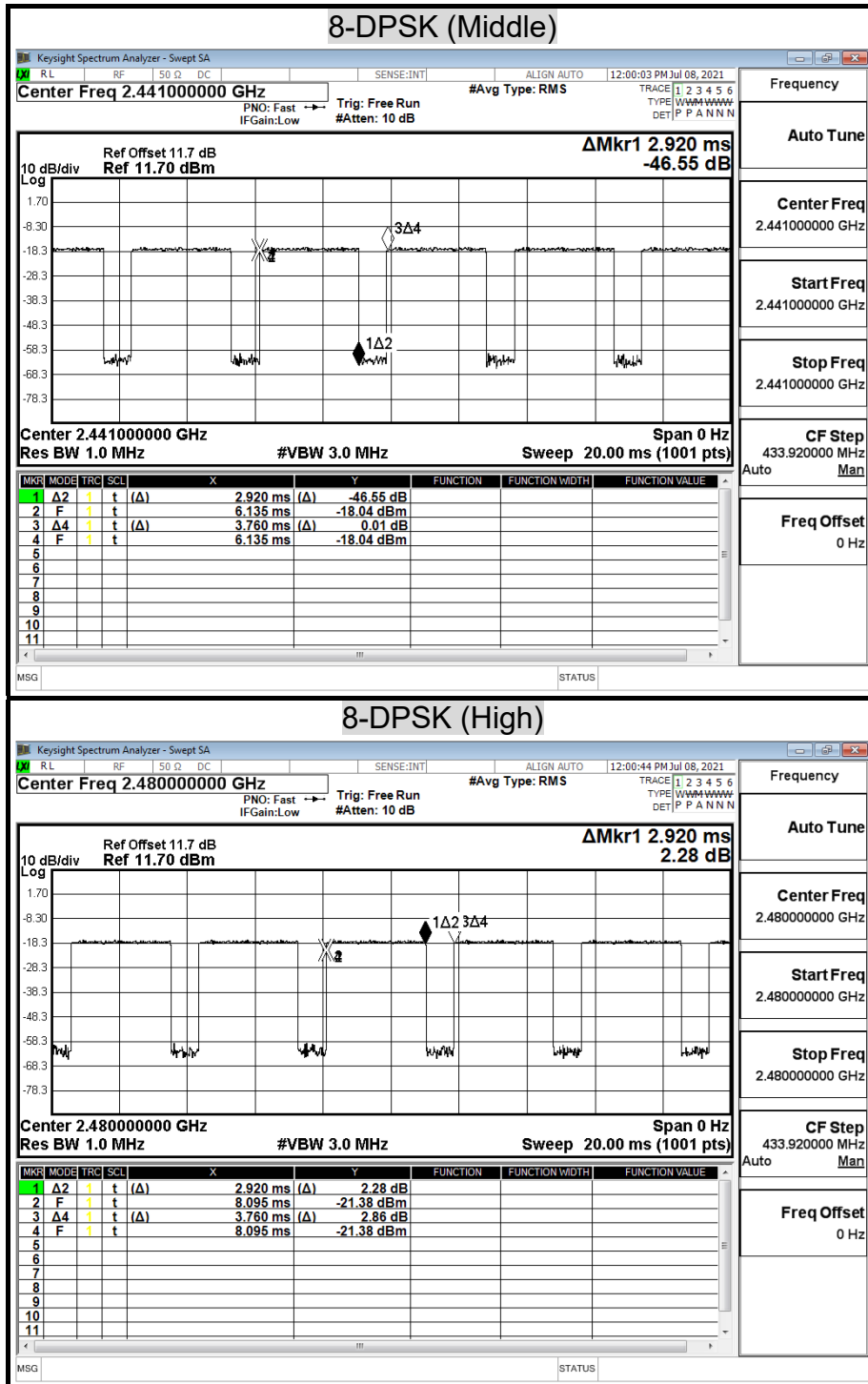

8.7 CONDUCTED SPURIOUS EMISSION

LIMITS

§ 15.247(d) In any 100 kHz bandwidth outside the frequency band in which the spread spectrum intentional radiator is operating, the radio frequency power that is produced by the intentional radiator shall be at least 20 dB below that in the 100 kHz bandwidth within the band and that contains the highest level of the desired power, based on either an RF conducted or a radiated measurement. Attenuation below the general limits specified in § 15.209(a) is not required. In addition, radiated emissions which fall in the restricted bands, as defined in § 15.205(a), must also comply with the radiated emission limits specified in § 15.209(a) (see § 15.205(c)).

TEST SETUP

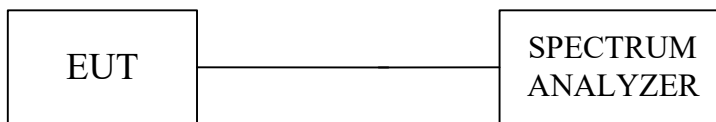

TEST PROCEDURE

The transmitter output is connected to a spectrum analyzer. The resolution bandwidth is set to 100 kHz. The video bandwidth is set to 300 kHz.

The spectrum from 30 MHz to 26.5 GHz is investigated with the transmitter set to the lowest, middle, and highest channels in the 2.4 GHz band.

Report No.: T210622N01-RP1-1

TEST RESULTS

Model Name	AT-LP3XBT	Test By	Ted Huang
Temp & Humidity	26.8°C, 56%	Test Date	2021/07/08

OUT-OF-BAND SPURIOUS EMISSIONS-CONDUCTED MEASUREMENT

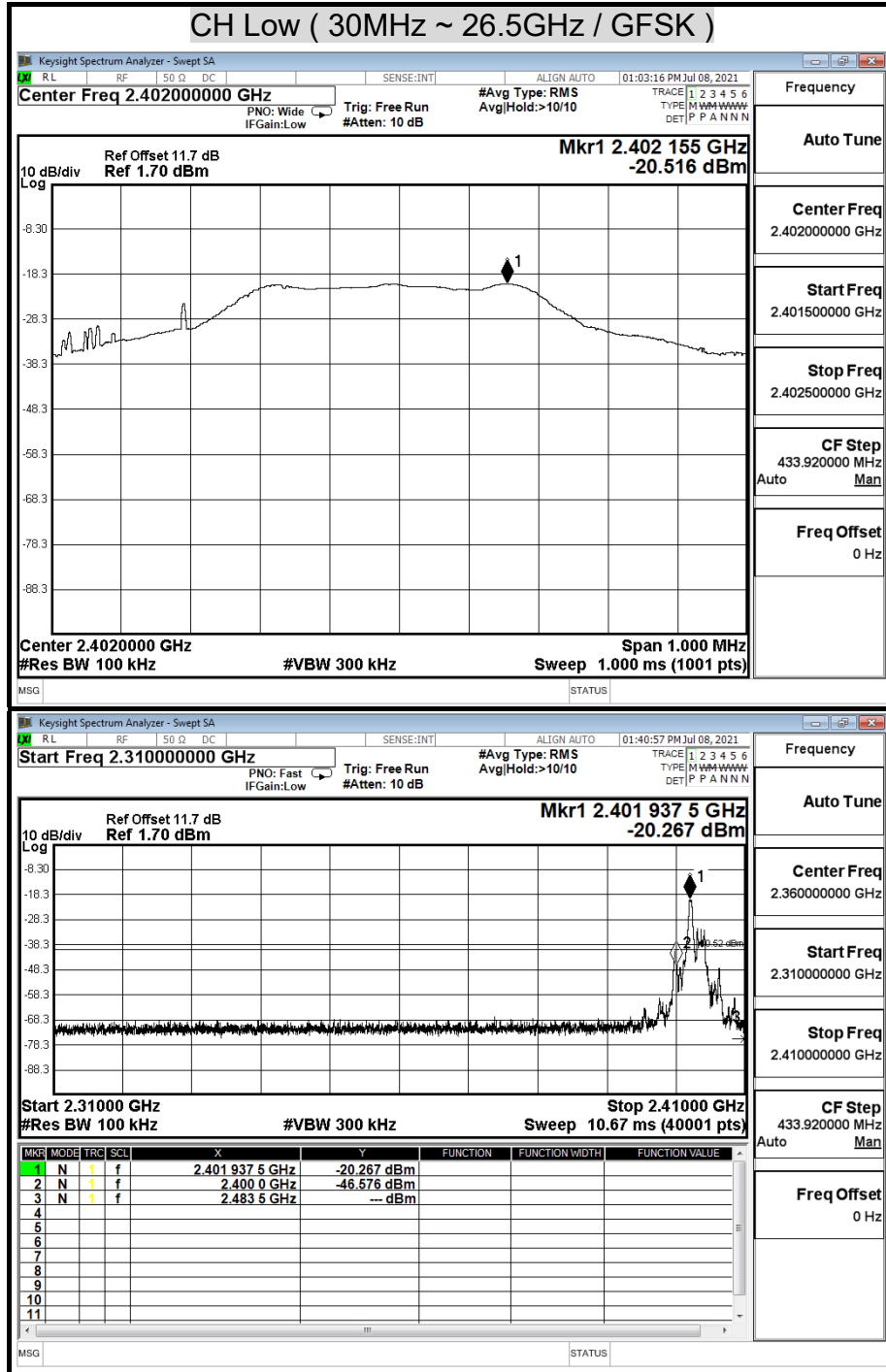

Report No.: T210622N01-RP1-1

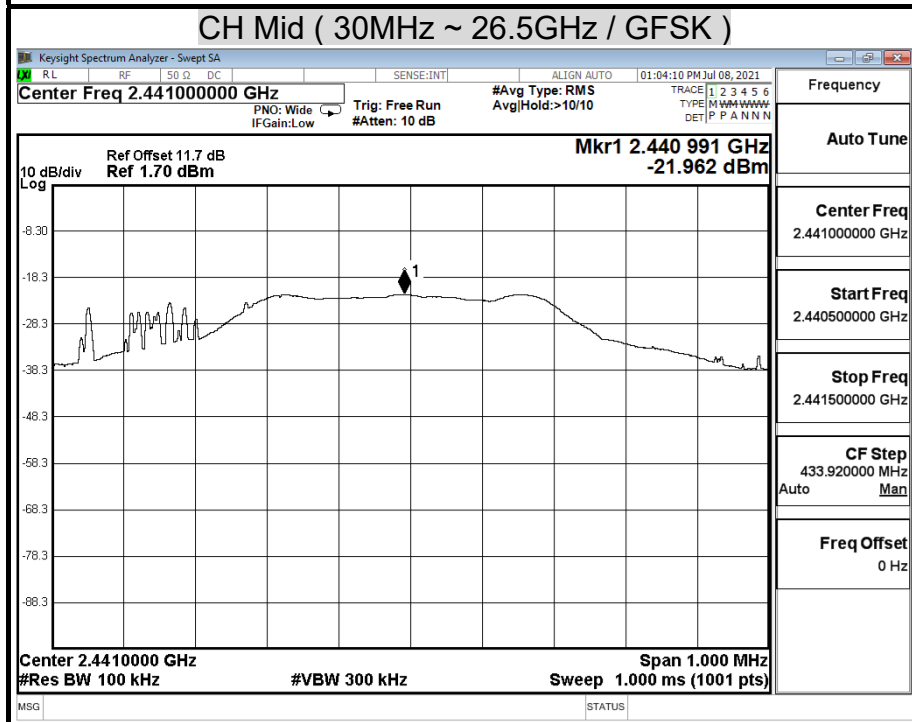
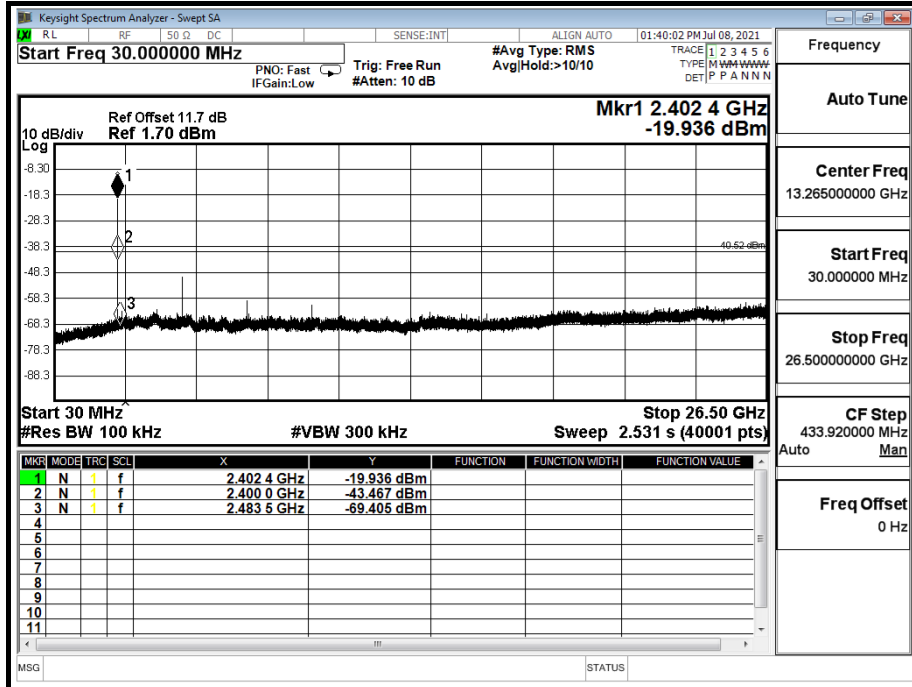

Report No.: T210622N01-RP1-1

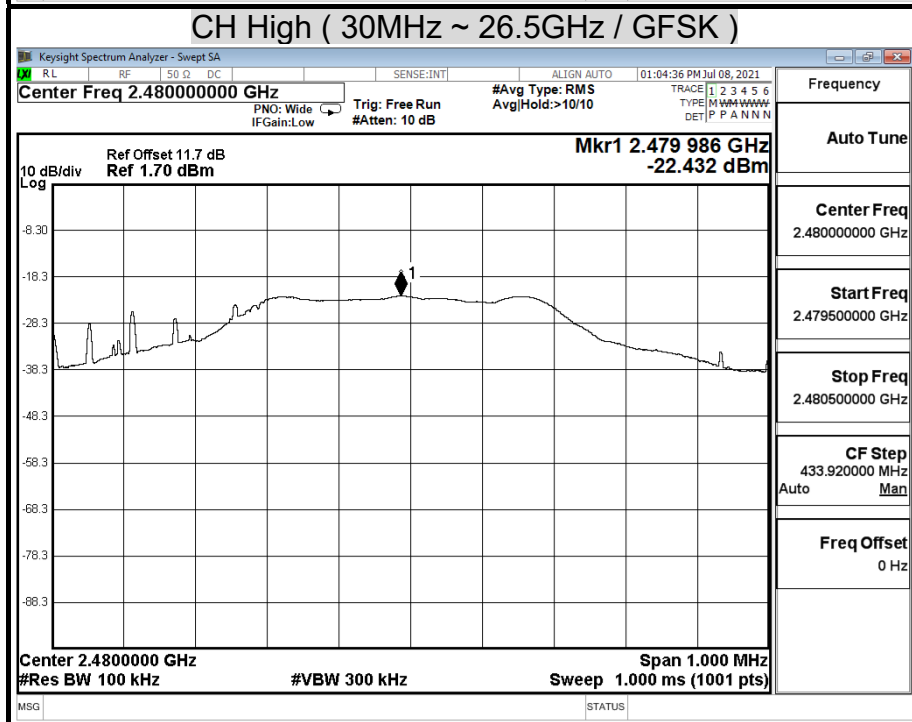
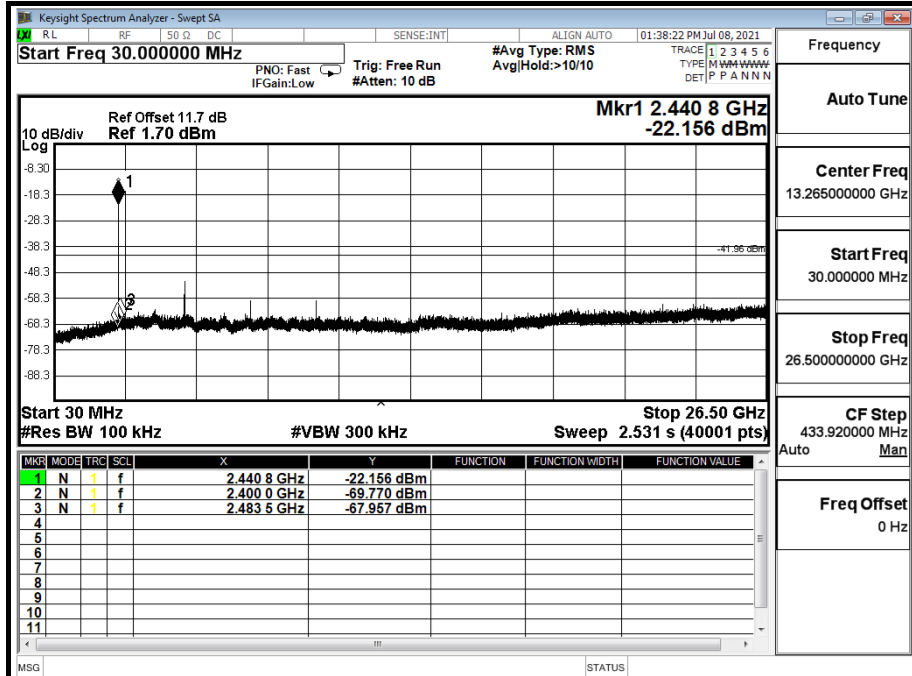

Report No.: T210622N01-RP1-1

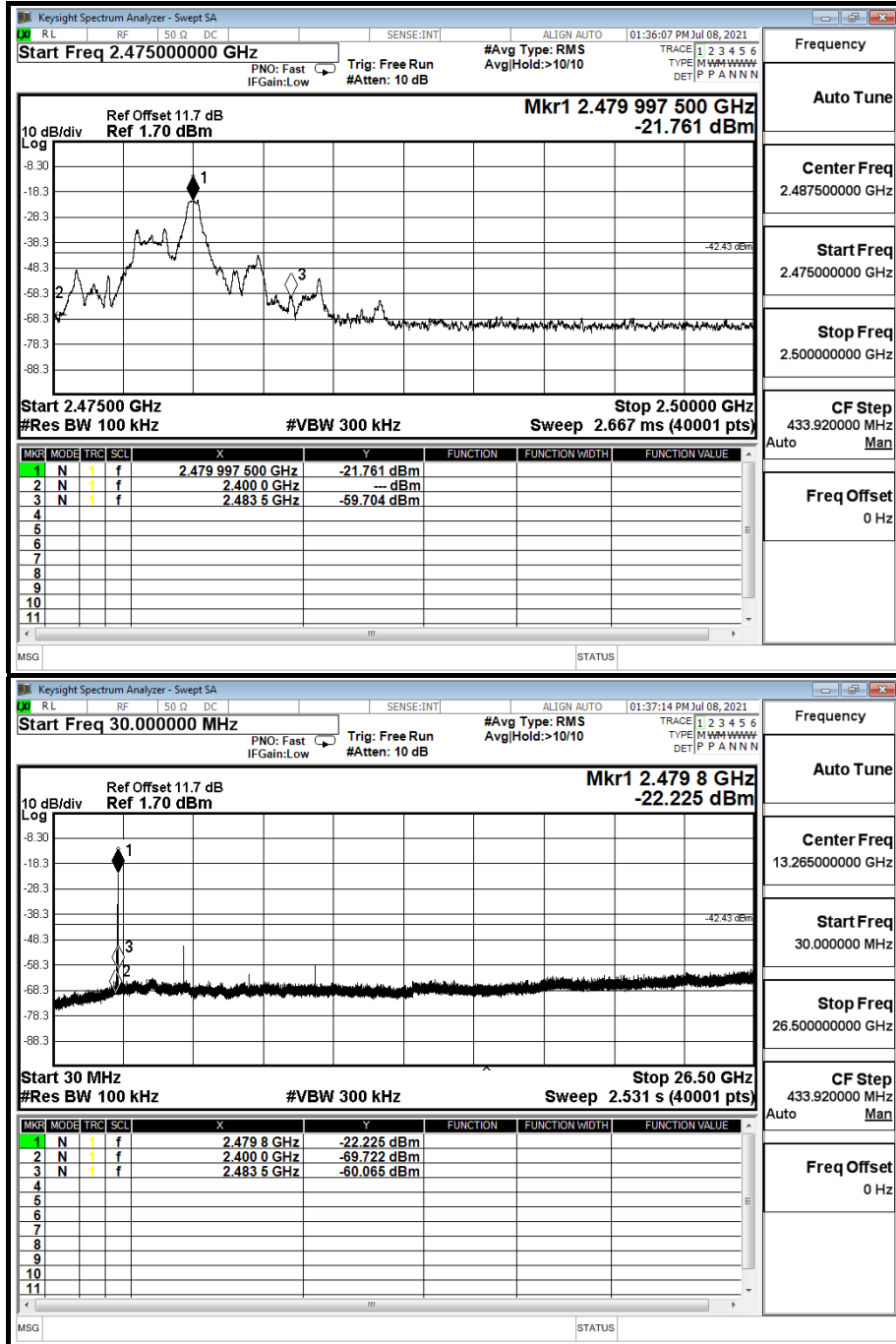

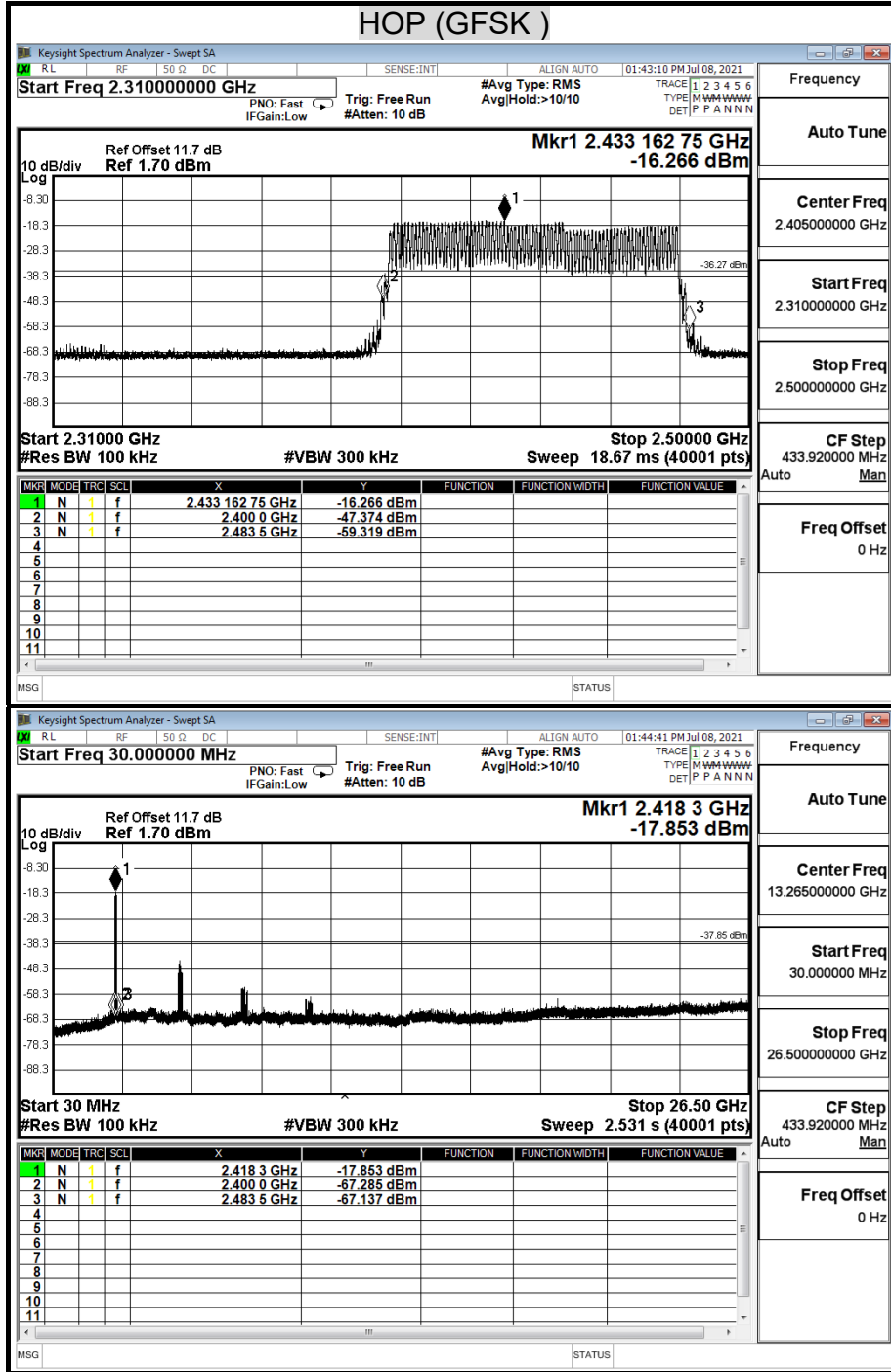

Report No.: T210622N01-RP1-1

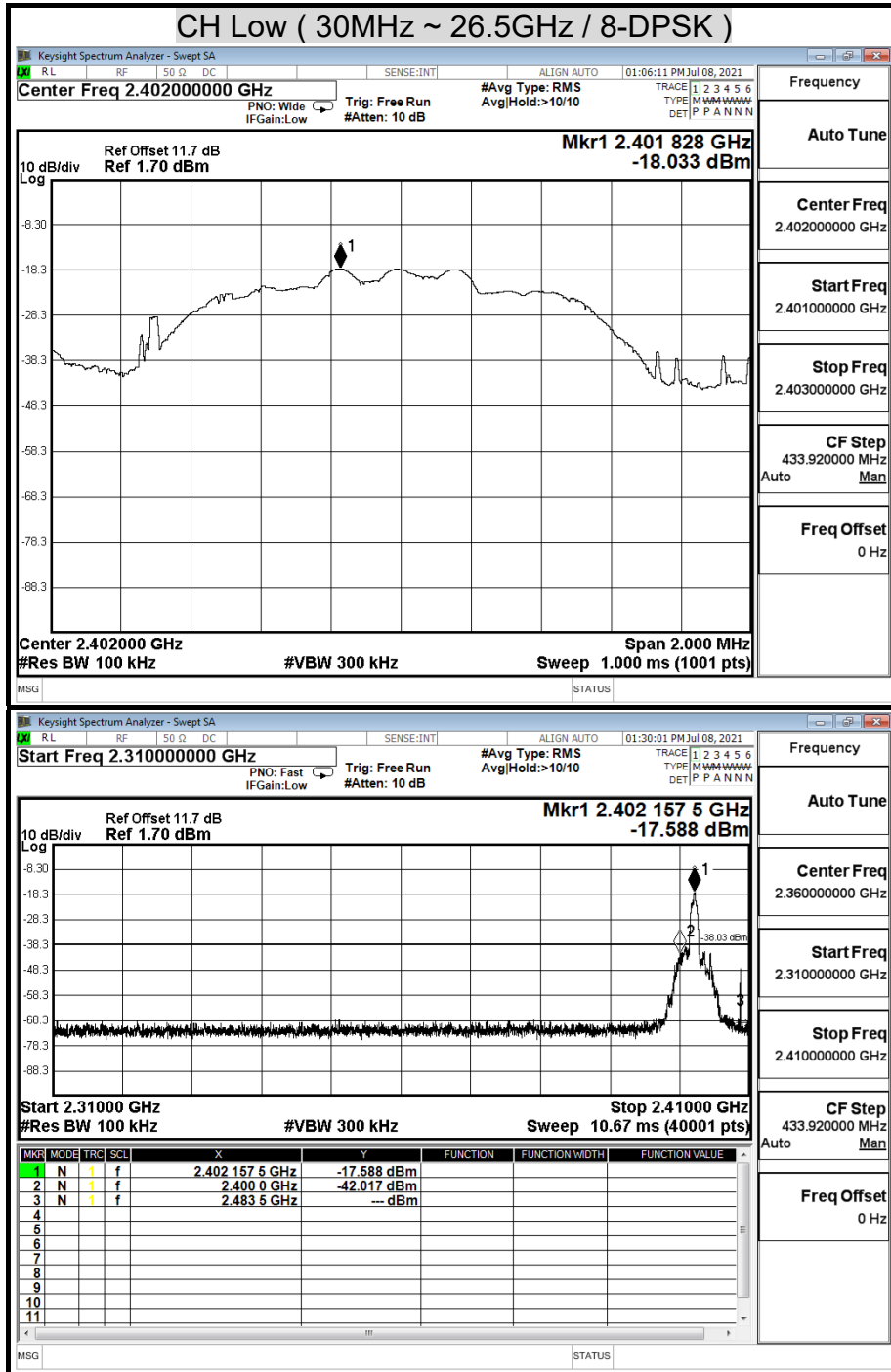

Report No.: T210622N01-RP1-1

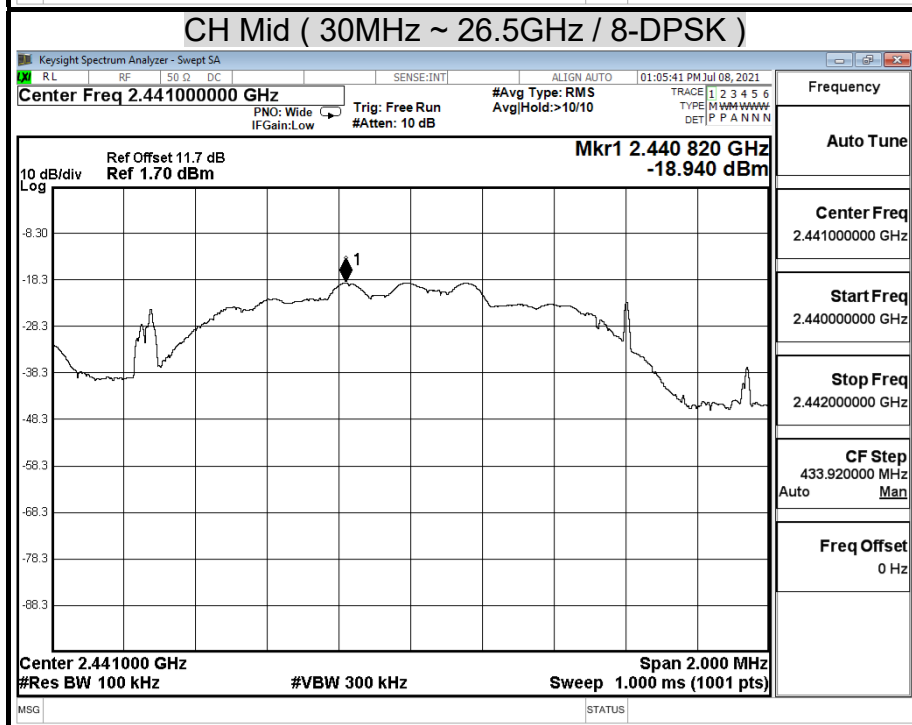
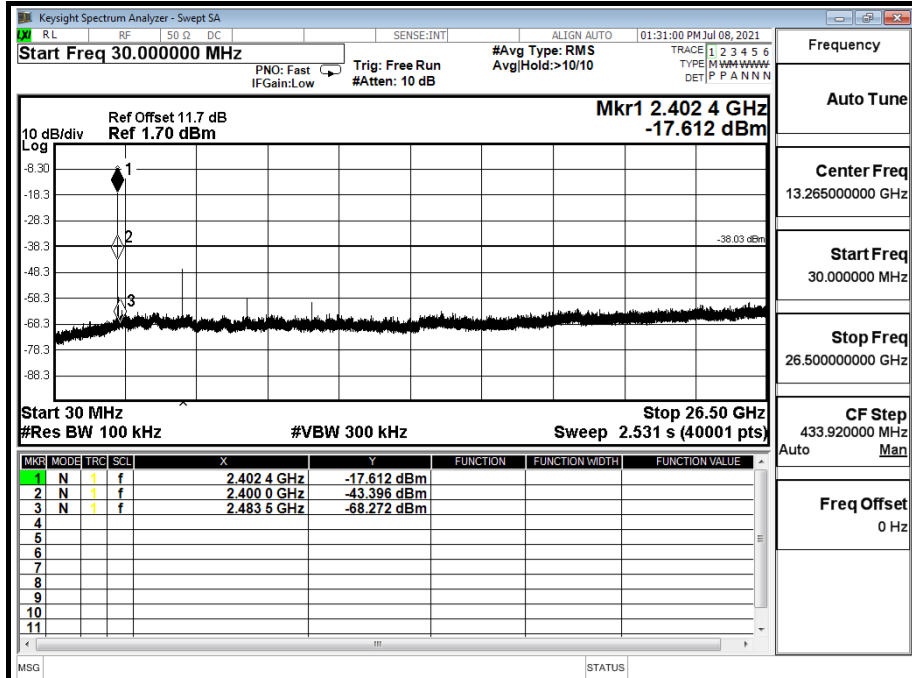

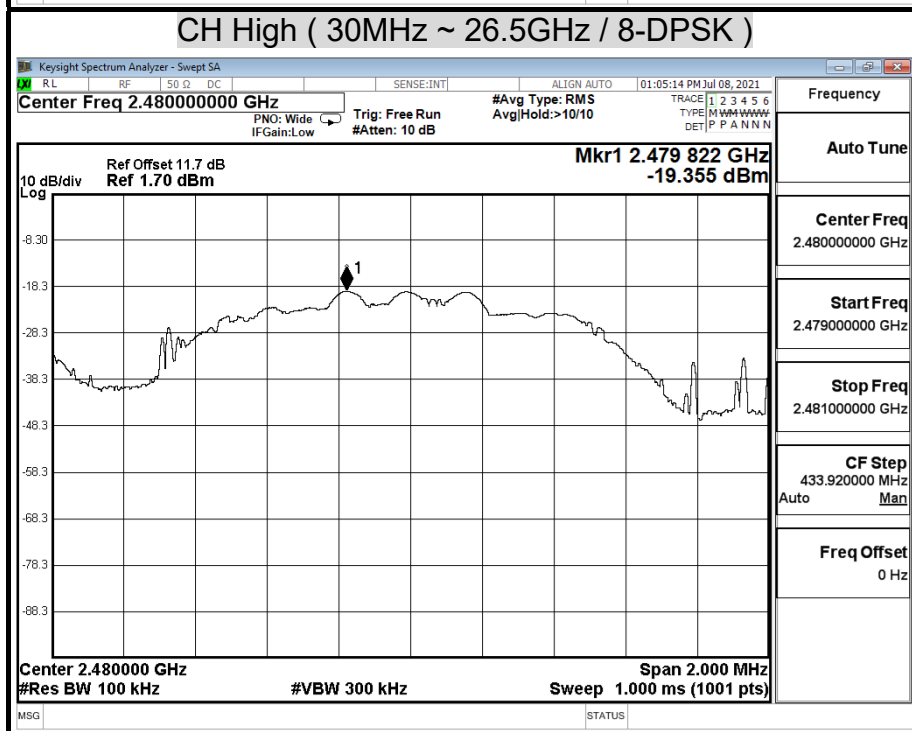
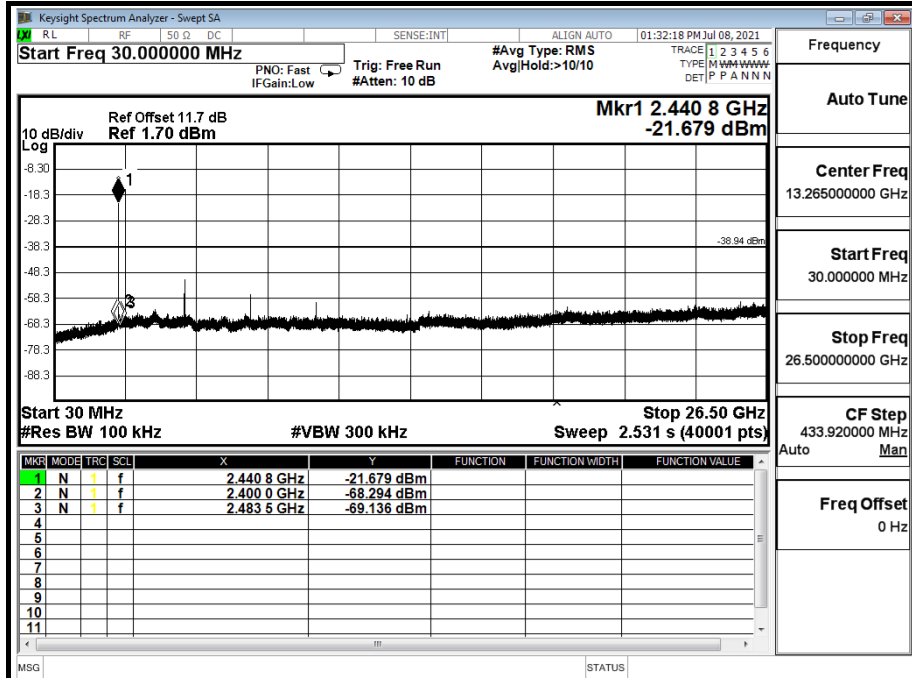

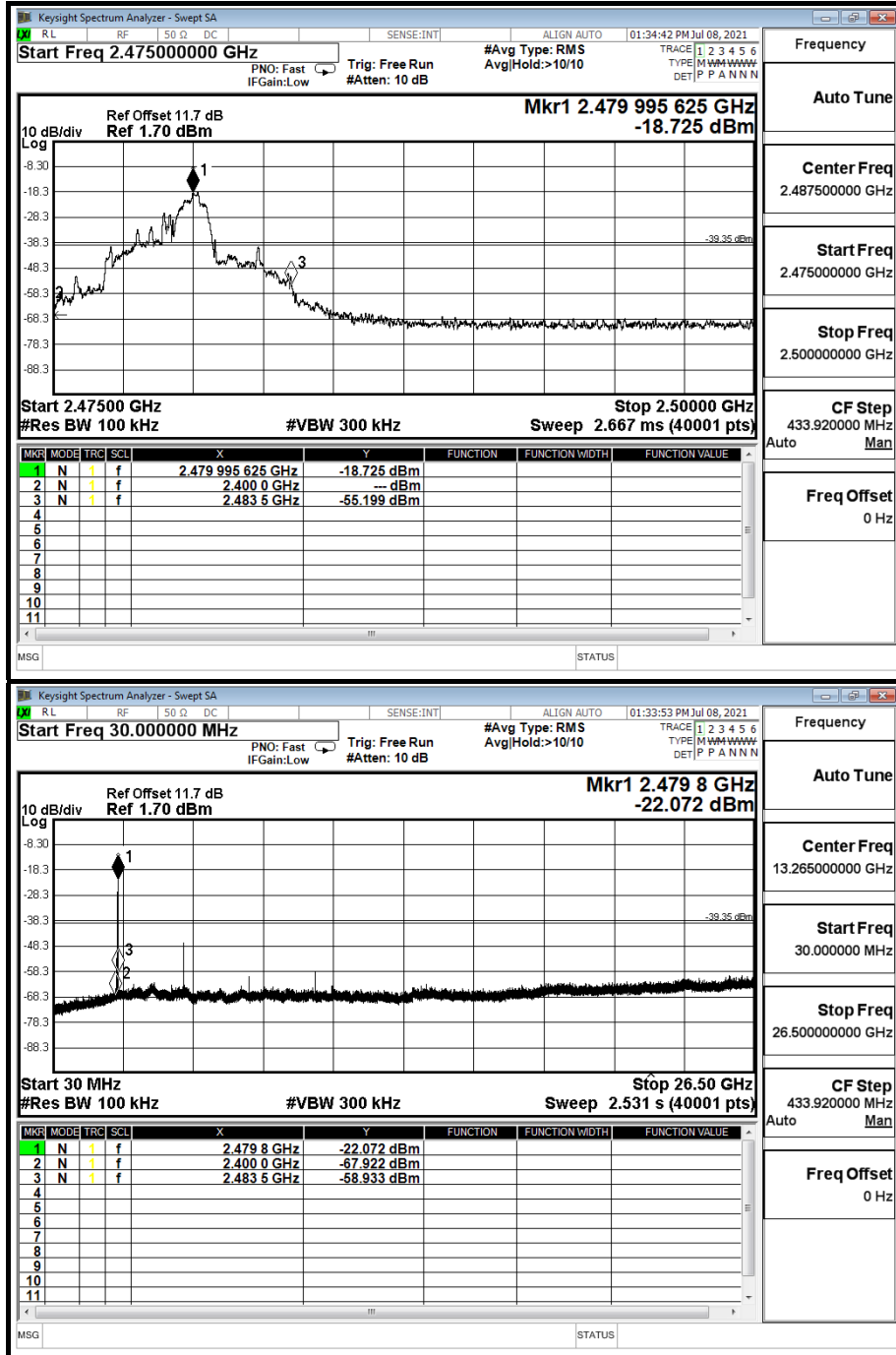

Report No.: T210622N01-RP1-1

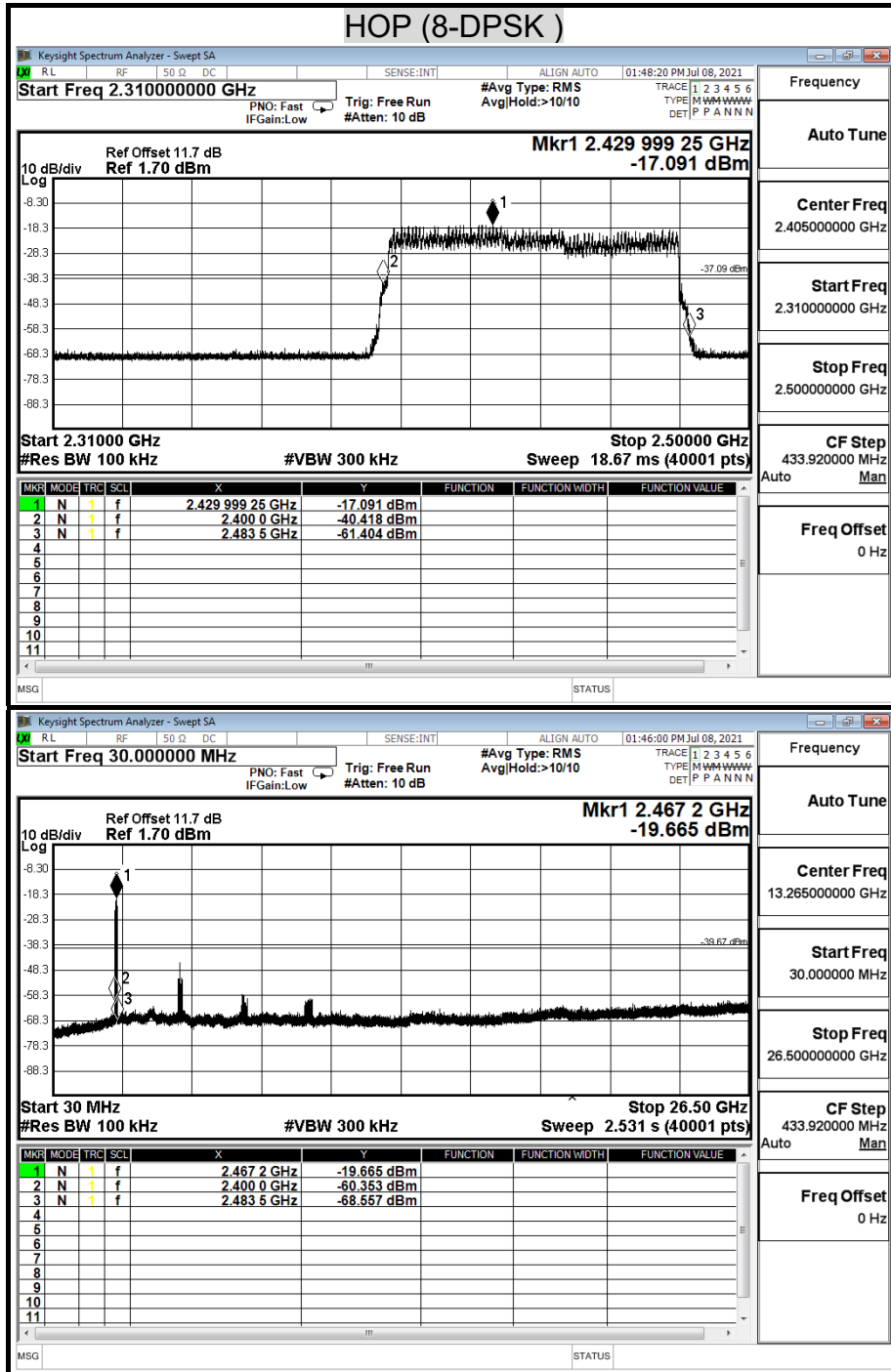

8.8 RADIATED EMISSIONS

8.8.1 TRANSMITTER RADIATED SUPURIOUS EMSSIONS

LIMITS

§ 15.205 (a) Except as shown in paragraph (d) of this section, only spurious emissions are permitted in any of the frequency bands listed below:

MHz	MHz	MHz	GHz
0.090 - 0.110	16.42 - 16.423	399.9 - 410	4.5 - 5.15
10.495 - 0.505	16.69475 - 16.69525	608 - 614	5.35 - 5.46
2.1735 - 2.1905	16.80425 - 16.80475	960 - 1240	7.25 - 7.75
4.125 - 4.128	25.5 - 25.67	1300 - 1427	8.025 - 8.5
4.17725 - 4.17775	37.5 - 38.25	1435 - 1626.5	9.0 - 9.2
4.20725 - 4.20775	73 - 74.6	1645.5 - 1646.5	9.3 - 9.5
6.215 - 6.218	74.8 - 75.2	1660 - 1710	10.6 - 12.7
6.26775 - 6.26825	108 - 121.94	1718.8 - 1722.2	13.25 - 13.4
6.31175 - 6.31225	123 - 138	2200 - 2300	14.47 - 14.5
8.291 - 8.294	149.9 - 150.05	2310 - 2390	15.35 - 16.2
8.362 - 8.366	156.52475 - 156.52525	2483.5 - 2500	17.7 - 21.4
8.37625 - 8.38675	156.7 - 156.9	2655 - 2900	22.01 - 23.12
8.41425 - 8.41475	162.0125 - 167.17	3260 - 3267	23.6 - 24.0
12.29 - 12.293	167.72 - 173.2	3332 - 3339	31.2 - 31.8
12.51975 - 12.52025	240 - 285	3345.8 - 3338	36.43 - 36.5
12.57675 - 12.57725	322 - 335.4	3600 - 4400	(²)
13.36 - 13.41			

¹ Until February 1, 1999, this restricted band shall be 0.490-0.510 MHz.

² Above 38.6

§ 15.205 (b) Except as provided in paragraphs (d) and (e), the field strength of emissions appearing within these frequency bands shall not exceed the limits shown in Section 15.209. At frequencies equal to or less than 1000 MHz, compliance with the limits in Section 15.209 shall be demonstrated using measurement instrumentation employing a CISPR quasi-peak detector. Above 1000 MHz, compliance with the emission limits in Section 15.209 shall be demonstrated based on the average value of the measured emissions. The provisions in Section 15.35 apply to these measurements.

Report No.: T210622N01-RP1-1

§ 15.209 (a) Except as provided elsewhere in this Subpart, the emissions from an intentional radiator shall not exceed the field strength levels specified in the following table :

Frequency (MHz)	Field Strength (microvolts/meter)	Measurement Distance (meters)
30 - 88	100 **	3
88 - 216	150 **	3
216 - 960	200 **	3
Above 960	500	3

** Except as provided in paragraph (g), fundamental emissions from intentional radiators operating under this Section shall not be located in the frequency bands 54-72 MHz, 76-88 MHz, 174-216 MHz or 470-806 MHz, However, operation within these frequency bands is permitted under other sections of this Part, e-g, Sections 15.231 and 15.241.

§ 15.209 (b) In the emission table above, the tighter limit applies at the band edges.

TEST SETUP

The diagram below shows the test setup that is utilized to make the measurements for emission from below 1GHz.

9kHz ~ 30MHz

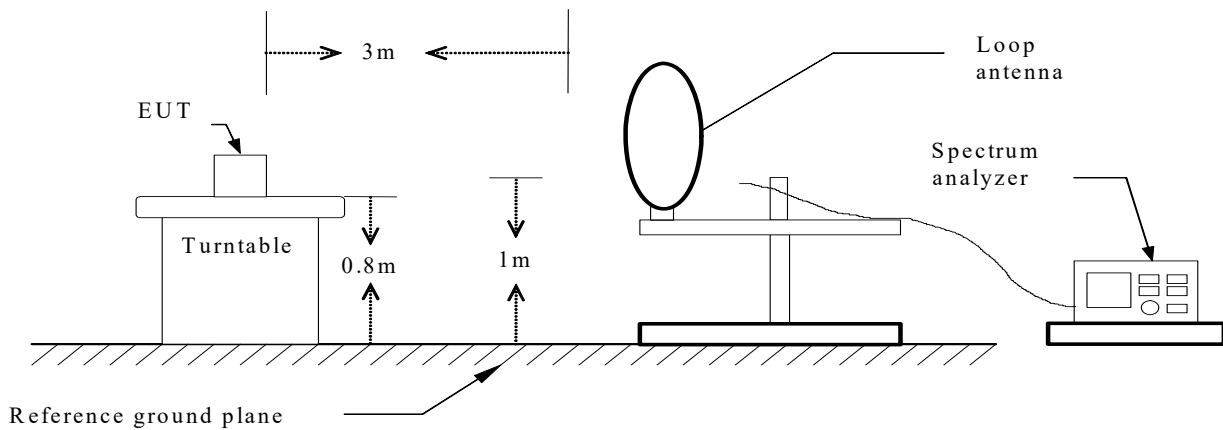

30MHz ~ 1GHz

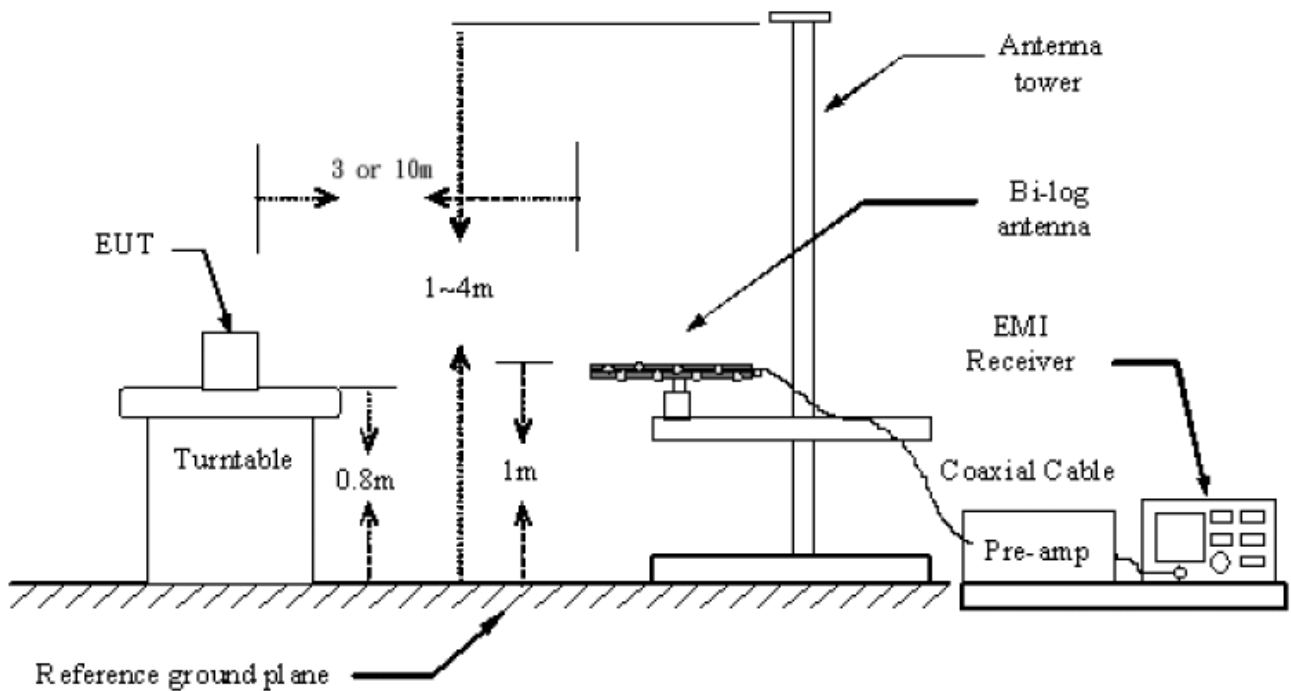

Report No.: T210622N01-RP1-1

The diagram below shows the test setup that is utilized to make the measurements for emission above 1GHz.

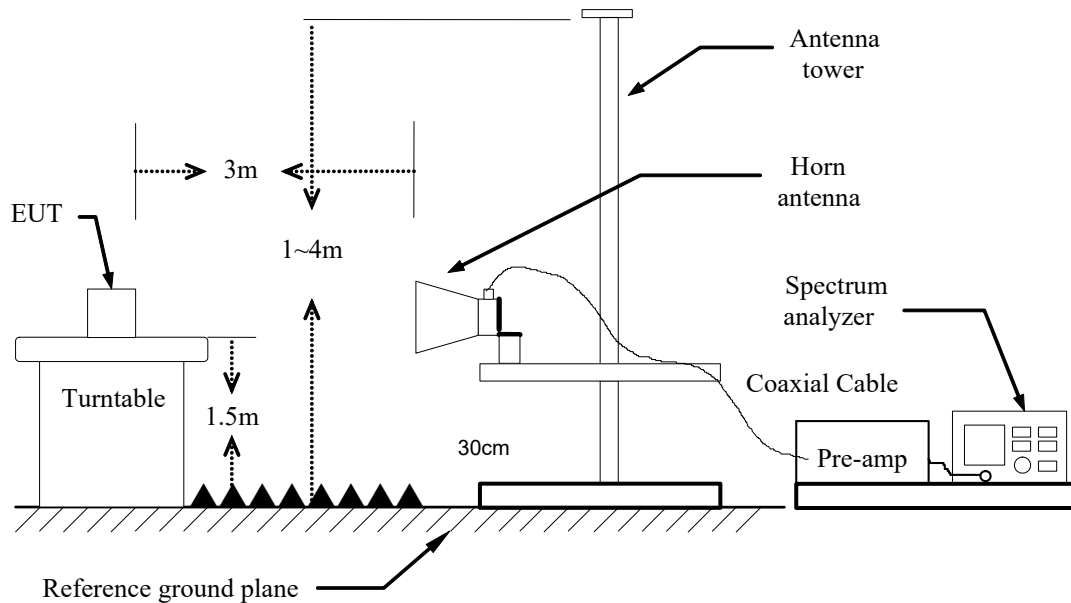

TEST PROCEDURE

- The EUT was placed on the top of a rotating table 0.8/1.5 meters above the ground at a 10/3 meter open site/chamber test site. The table was rotated 360 degrees to determine the position of the highest radiation.
- While measuring the radiated emission below 1GHz, the EUT was set 3 or 10 meters away from the interference-receiving antenna, which was mounted on the top of a variable-height antenna tower. While measuring the radiated emission above 1GHz, the EUT was set 3 or 10 meters away from the interference-receiving antenna.
- The antenna is a broadband antenna, and its height is varied from one meter to four meters above the ground to determine the maximum value of the field strength. Both horizontal and vertical polarization of the antenna are set to make the measurement.
- For each suspected emission, the EUT was arranged to its worst case and then the antenna was tuned to heights from 1 meter to 4 meters and the table was turned from 0 degrees to 360 degrees to find the maximum reading.
- The test-receiver system was set to Peak Detect Function and Specified Bandwidth with Maximum Hold Mode.
- If the emission level of the EUT in peak mode was 10 dB lower than the limit specified, then testing could be stopped and the peak values of the EUT would be reported. Otherwise the emissions that did not have 10 dB margin would be re-tested one by one using peak, quasi-peak or average method as specified and then reported in a data sheet.

Note :

- The resolution bandwidth and video bandwidth of test receiver/spectrum analyzer is 120 KHz for Peak detection (PK) and Quasi-peak detection (QP) at frequency below 1GHz.
- The resolution bandwidth and video bandwidth of test receiver/spectrum analyzer is 1 MHz for Peak detection and frequency above 1GHz.
- The resolution bandwidth of test receiver/spectrum analyzer is 1 MHz and the video bandwidth is 510 Hz for Average detection (AV) at frequency above 1GHz.

8.8.2 WORST-CASE RADIATED EMISSION BELOW 1 GHz

BELOW 1 GHz (9kHz ~ 30MHz)

No emission found between lowest internal used/generated frequency to 30MHz.

Report No.: T210622N01-RP1-1
BELOW 1 GHz (30MHz ~ 1GHz)

Product Name	Automatic Wireless Turntable	Test Date	2021/07/09
Model Name	AT-LP3XBT	Test By	Ted Huang
Test Mode	TX	Temp & Humidity	26.4°C, 56%

Vertical

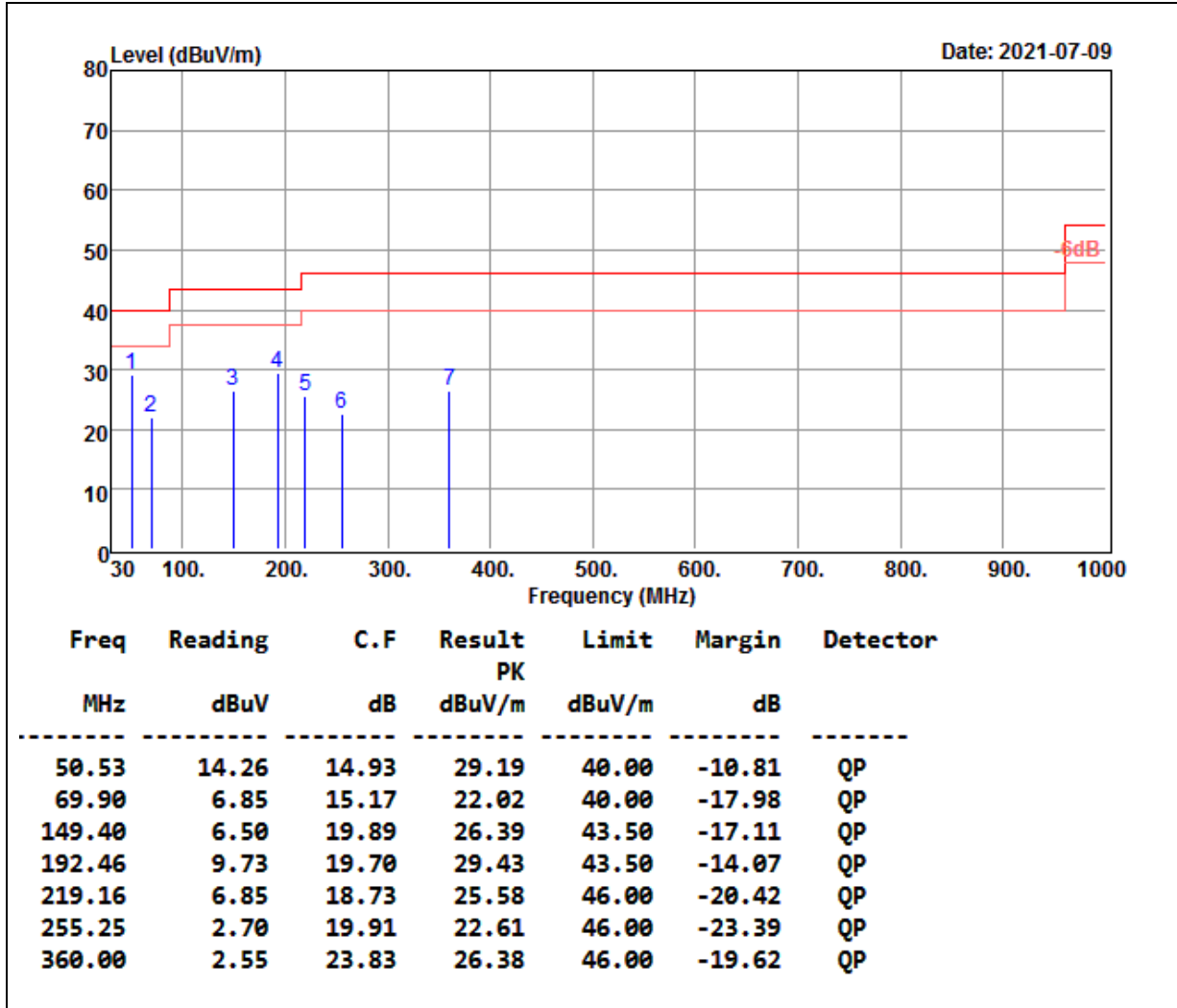

Remark:

1. No emission found between lowest internal used/generated frequency to 30MHz (9kHz~30MHz).
2. Radiated emissions measured were made with an instrument using peak/quasi-peak detector mode.
3. Quasi-peak test would be performed if the peak result were greater than the quasi-peak limit or as required by the applicant.
4. Margin (dB) = Remark result (dBUV/m) – Quasi-peak limit (dBUV/m).

Report No.: T210622N01-RP1-1

Product Name	Automatic Wireless Turntable	Test Date	2021/07/09
Model Name	AT-LP3XBT	Test By	Ted Huang
Test Mode	TX	Temp & Humidity	26.4°C, 56%

Horizontal

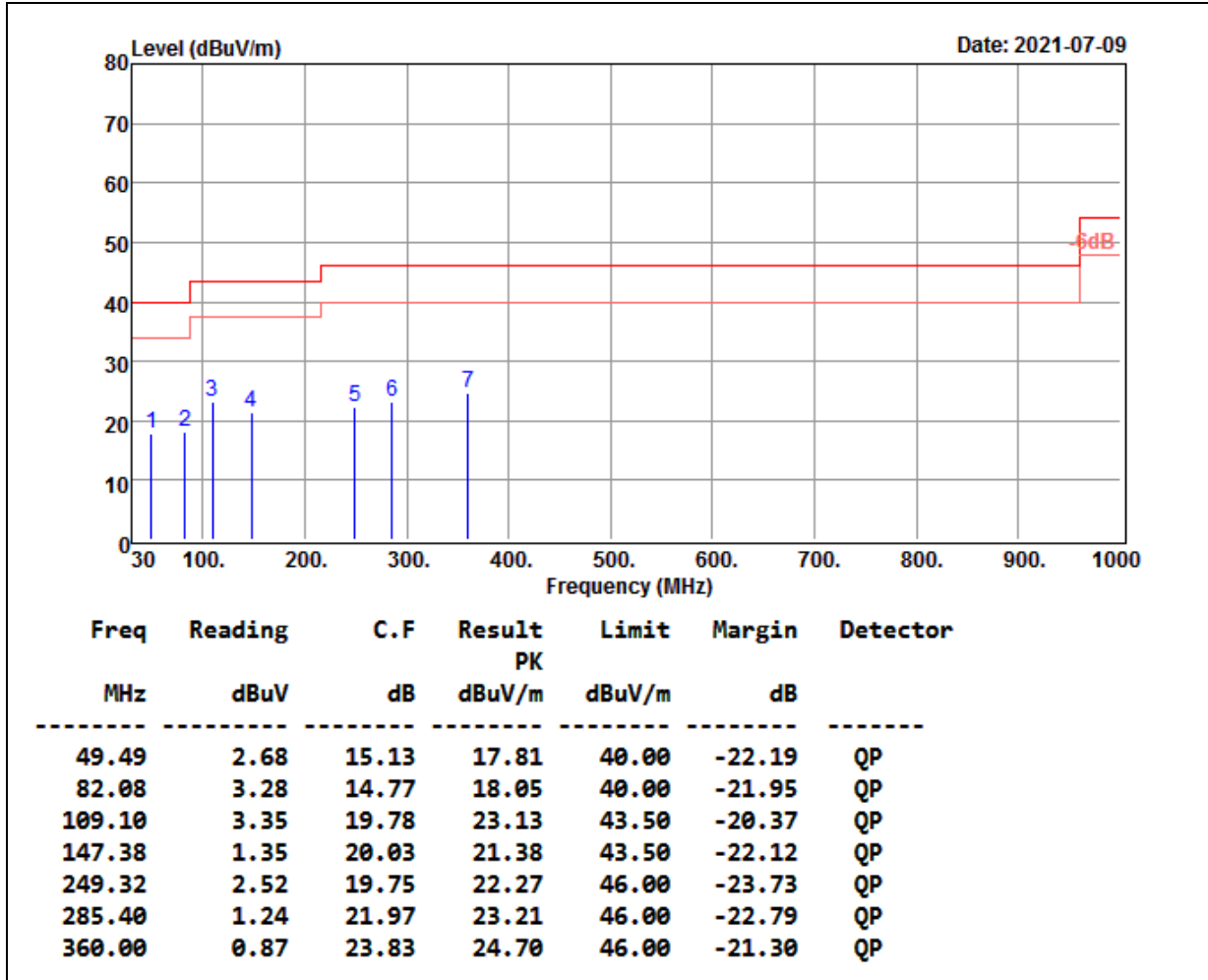

Remark:

1. No emission found between lowest internal used/generated frequency to 30MHz (9kHz~30MHz).
2. Radiated emissions measured were made with an instrument using peak/quasi-peak detector mode.
3. Quasi-peak test would be performed if the peak result were greater than the quasi-peak limit or as required by the applicant.
4. Margin (dB) = Remark result (dBuV/m) – Quasi-peak limit (dBuV/m).

8.8.3 TRANSMITTER RADIATED EMISSION ABOVE 1 GHz

Product Name	Automatic Wireless Turntable	Test Date	2021/07/08
Model Name	AT-LP3XBT	Test By	Ted Huang
Test Mode	CH Low TX / GFSK	Temp & Humidity	26.8°C, 56%

Horizontal

TX mode / CH Low				Measurement Distance at 3m			Horizontal polarity			
Freq.	Reading	AF	Cable Loss	Pre-amp	Filter	Level	Limit	Margin	Mark	
(MHz)	(dBμV)	(dB/m)	(dB)	(dB)	(dB)	(dBμV/m)	(dBμV/m)	(dB)	(P/Q/A)	
1728.24	60.38	28.43	3.40	44.42	0.70	48.48	74.00	-25.52	P	
1728.24	51.65	28.43	3.40	44.42	0.70	39.75	54.00	-14.25	A	
* 4804.00	63.02	33.07	5.45	42.61	0.22	59.16	74.00	-14.84	P	
* 4804.00	56.78	33.07	5.45	42.61	0.22	52.91	54.00	-1.09	A	
7206.48	56.61	38.68	6.57	42.44	0.27	59.69	74.00	-14.31	P	
7206.48	46.68	38.68	6.57	42.44	0.27	49.77	54.00	-4.23	A	

Vertical

TX mode / CH Low				Measurement Distance at 3m			Vertical polarity			
Freq.	Reading	AF	Cable Loss	Pre-amp	Filter	Level	Limit	Margin	Mark	
(MHz)	(dBμV)	(dB/m)	(dB)	(dB)	(dB)	(dBμV/m)	(dBμV/m)	(dB)	(P/Q/A)	
1710.28	62.72	28.28	3.38	44.45	0.68	50.61	74.00	-23.39	P	
1710.28	52.85	28.28	3.38	44.45	0.68	40.74	54.00	-13.26	A	
* 4803.96	59.72	33.07	5.45	42.61	0.22	55.86	74.00	-18.14	P	
* 4803.96	52.86	33.07	5.45	42.61	0.22	48.99	54.00	-5.01	A	
7205.91	55.80	38.68	6.57	42.44	0.27	58.88	74.00	-15.12	P	
7205.91	45.70	38.68	6.57	42.44	0.27	48.79	54.00	-5.21	A	

Remark:

1. AF: Antenna Factor, Cable: Cable Loss, Pre-Amp: Preamplifier gain, Filter: High Pass Filter Insertion Loss (3.5GHz)
2. Spectrum analyzer setting P(Peak): RBW=1MHz, VBW=1MHz, A(Average): RBW=1MHz, VBW=510Hz
3. The result basic equation calculation is as follow:
Level = Reading + AF + Cable – Preamp + Filter, Margin = Level-Limit
4. The other emission levels were 20dB below the limit
5. The test limit distance is 3M limit.
6. *=Restricted bands of operation

Report No.: T210622N01-RP1-1

Product Name	Automatic Wireless Turntable	Test Date	2021/07/08
Model Name	AT-LP3XBT	Test By	Ted Huang
Test Mode	CH Mid TX / GFSK	Temp & Humidity	26.8°C, 56%

Horizontal

TX mode / CH Mid				Measurement Distance at 3m			Horizontal polarity			
Freq.	Reading	AF	Cable Loss	Pre-amp	Filter	Level	Limit	Margin	Mark	
(MHz)	(dBμV)	(dB/m)	(dB)	(dB)	(dB)	(dBμV/m)	(dBμV/m)	(dB)	(P/Q/A)	
1726.78	60.24	28.41	3.40	44.43	0.70	48.32	74.00	-25.68	P	
1726.78	51.32	28.41	3.40	44.43	0.70	39.40	54.00	-14.60	A	
* 4881.86	62.01	33.32	5.51	42.60	0.23	58.48	74.00	-15.52	P	
* 4881.86	54.24	33.32	5.51	42.60	0.23	50.70	54.00	-3.30	A	
* 7322.86	55.39	39.13	6.59	42.28	0.27	59.09	74.00	-14.91	P	
* 7322.86	44.50	39.13	6.59	42.28	0.27	48.20	54.00	-5.80	A	

Vertical

TX mode / CH Mid				Measurement Distance at 3m			Vertical polarity			
Freq.	Reading	AF	Cable Loss	Pre-amp	Filter	Level	Limit	Margin	Mark	
(MHz)	(dBμV)	(dB/m)	(dB)	(dB)	(dB)	(dBμV/m)	(dBμV/m)	(dB)	(P/Q/A)	
* 1709.85	63.24	28.28	3.38	44.45	0.68	51.13	74.00	-22.87	P	
* 1709.85	53.56	28.28	3.38	44.45	0.68	41.45	54.00	-12.55	A	
* 4881.92	60.90	33.32	5.51	42.60	0.23	57.36	74.00	-16.64	P	
* 4881.92	54.19	33.32	5.51	42.60	0.23	50.65	54.00	-3.35	A	
* 7323.25	55.09	39.13	6.59	42.28	0.27	58.79	74.00	-15.21	P	
* 7323.25	44.16	39.13	6.59	42.28	0.27	47.86	54.00	-6.14	A	

Remark:

1. AF: Antenna Factor, Cable: Cable Loss, Pre-Amp: Preamplifier gain, Filter: High Pass Filter Insertion Loss (3.5GHz)
2. Spectrum analyzer setting P(Peak): RBW=1MHz, VBW=1MHz, A(Average): RBW=1MHz, VBW=510Hz
3. The result basic equation calculation is as follow:
Level = Reading + AF + Cable – Preamp + Filter, Margin = Level-Limit
4. The other emission levels were 20dB below the limit
5. The test limit distance is 3M limit.
6. *=Restricted bands of operation

Report No.: T210622N01-RP1-1

Product Name	Automatic Wireless Turntable	Test Date	2021/07/08
Model Name	AT-LP3XBT	Test By	Ted Huang
Test Mode	CH High TX / GFSK	Temp & Humidity	26.8°C, 56%

Horizontal

TX mode / CH High				Measurement Distance at 3m				Horizontal polarity		
Freq.	Reading	AF	Cable Loss	Pre-amp	Filter	Level	Limit	Margin	Mark	
(MHz)	(dBμV)	(dB/m)	(dB)	(dB)	(dB)	(dBμV/m)	(dBμV/m)	(dB)	(P/Q/A)	
1726.47	60.52	28.41	3.40	44.43	0.70	48.60	74.00	-25.40	P	
1726.47	51.78	28.41	3.40	44.43	0.70	39.86	54.00	-14.14	A	
* 4959.94	59.38	33.57	5.57	42.59	0.24	56.16	74.00	-17.84	P	
* 4959.94	51.88	33.57	5.57	42.59	0.24	48.66	54.00	-5.34	A	
* 7440.35	55.43	39.57	6.62	42.13	0.27	59.76	74.00	-14.24	P	
* 7440.35	45.19	39.57	6.62	42.13	0.27	49.52	54.00	-4.48	A	

Vertical

TX mode / CH High				Measurement Distance at 3m				Vertical polarity		
Freq.	Reading	AF	Cable Loss	Pre-amp	Filter	Level	Limit	Margin	Mark	
(MHz)	(dBμV)	(dB/m)	(dB)	(dB)	(dB)	(dBμV/m)	(dBμV/m)	(dB)	(P/Q/A)	
1714.68	62.56	28.32	3.39	44.44	0.68	50.50	74.00	-23.50	P	
1714.68	52.78	28.32	3.39	44.44	0.68	40.72	54.00	-13.28	A	
* 4959.97	60.07	33.57	5.57	42.59	0.24	56.85	74.00	-17.15	P	
* 4959.97	52.73	33.57	5.57	42.59	0.24	49.52	54.00	-4.48	A	
* 7439.53	55.54	39.57	6.62	42.13	0.27	59.86	74.00	-14.14	P	
* 7439.53	45.12	39.57	6.62	42.13	0.27	49.45	54.00	-4.55	A	

Remark:

1. AF: Antenna Factor, Cable: Cable Loss, Pre-Amp: Preamplifier gain, Filter: High Pass Filter Insertion Loss (3.5GHz)
2. Spectrum analyzer setting P(Peak): RBW=1MHz, VBW=1MHz, A(Average): RBW=1MHz, VBW=510Hz
3. The result basic equation calculation is as follow:
Level = Reading + AF + Cable – Preamp + Filter, Margin = Level-Limit
4. The other emission levels were 20dB below the limit
5. The test limit distance is 3M limit.
6. *=Restricted bands of operation

Report No.: T210622N01-RP1-1

Product Name	Automatic Wireless Turntable	Test Date	2021/07/08
Model Name	AT-LP3XBT	Test By	Ted Huang
Test Mode	CH Low TX / 8-DPSK	Temp & Humidity	26.8°C, 56%

Horizontal

TX mode / CH Low				Measurement Distance at 3m				Horizontal polarity		
Freq.	Reading	AF	Cable Loss	Pre-amp	Filter	Level	Limit	Margin	Mark	
(MHz)	(dBμV)	(dB/m)	(dB)	(dB)	(dB)	(dBμV/m)	(dBμV/m)	(dB)	(P/Q/A)	
1724.35	60.58	28.39	3.40	44.43	0.69	48.63	74.00	-25.37	P	
1724.35	51.79	28.39	3.40	44.43	0.69	39.84	54.00	-14.16	A	
* 4803.96	61.80	33.07	5.45	42.61	0.22	57.94	74.00	-16.06	P	
* 4803.96	55.29	33.07	5.45	42.61	0.22	51.43	54.00	-2.57	A	
7206.08	56.58	38.68	6.57	42.44	0.27	59.66	74.00	-14.34	P	
7206.08	46.62	38.68	6.57	42.44	0.27	49.71	54.00	-4.29	A	

Vertical

TX mode / CH Low				Measurement Distance at 3m				Vertical polarity		
Freq.	Reading	AF	Cable Loss	Pre-amp	Filter	Level	Limit	Margin	Mark	
(MHz)	(dBμV)	(dB/m)	(dB)	(dB)	(dB)	(dBμV/m)	(dBμV/m)	(dB)	(P/Q/A)	
1716.52	62.82	28.33	3.39	44.44	0.69	50.79	74.00	-23.21	P	
1716.52	53.17	28.33	3.39	44.44	0.69	41.14	54.00	-12.86	A	
* 4804.11	61.07	33.07	5.46	42.61	0.22	57.20	74.00	-16.80	P	
* 4804.11	54.55	33.07	5.46	42.61	0.22	50.69	54.00	-3.31	A	
7205.87	57.15	38.68	6.57	42.44	0.27	60.23	74.00	-13.77	P	
7205.87	46.55	38.68	6.57	42.44	0.27	49.64	54.00	-4.36	A	

Remark:

1. AF: Antenna Factor, Cable: Cable Loss, Pre-Amp: Preamplifier gain, Filter: High Pass Filter Insertion Loss (3.5GHz)
2. Spectrum analyzer setting P(Peak): RBW=1MHz, VBW=1MHz, A(Average): RBW=1MHz, VBW=510Hz
3. The result basic equation calculation is as follow:
Level = Reading + AF + Cable – Preamp + Filter, Margin = Level-Limit
4. The other emission levels were 20dB below the limit
5. The test limit distance is 3M limit.
6. *=Restricted bands of operation

Report No.: T210622N01-RP1-1

Product Name	Automatic Wireless Turntable	Test Date	2021/07/08
Model Name	AT-LP3XBT	Test By	Ted Huang
Test Mode	CH Mid TX / 8-DPSK	Temp & Humidity	26.8°C, 56%

Horizontal

TX mode / CH Mid				Measurement Distance at 3m				Horizontal polarity		
Freq.	Reading	AF	Cable Loss	Pre-amp	Filter	Level	Limit	Margin	Mark	
(MHz)	(dBμV)	(dB/m)	(dB)	(dB)	(dB)	(dBμV/m)	(dBμV/m)	(dB)	(P/Q/A)	
1727.65	60.72	28.42	3.40	44.42	0.70	48.81	74.00	-25.19	P	
1727.65	51.66	28.42	3.40	44.42	0.70	39.75	54.00	-14.25	A	
* 4882.11	61.43	33.32	5.51	42.60	0.23	57.90	74.00	-16.10	P	
* 4882.11	54.97	33.32	5.51	42.60	0.23	51.43	54.00	-2.57	A	
* 7323.07	55.53	39.13	6.59	42.28	0.27	59.23	74.00	-14.77	P	
* 7323.07	44.66	39.13	6.59	42.28	0.27	48.37	54.00	-5.63	A	

Vertical

TX mode / CH Mid				Measurement Distance at 3m				Vertical polarity		
Freq.	Reading	AF	Cable Loss	Pre-amp	Filter	Level	Limit	Margin	Mark	
(MHz)	(dBμV)	(dB/m)	(dB)	(dB)	(dB)	(dBμV/m)	(dBμV/m)	(dB)	(P/Q/A)	
1726.54	62.68	28.41	3.40	44.43	0.70	50.76	74.00	-23.24	P	
1726.54	52.79	28.41	3.40	44.43	0.70	40.87	54.00	-13.13	A	
* 4882.13	59.94	33.32	5.51	42.60	0.23	56.40	74.00	-17.60	P	
* 4882.13	52.89	33.32	5.51	42.60	0.23	49.35	54.00	-4.65	A	
* 7323.35	55.31	39.13	6.59	42.28	0.27	59.02	74.00	-14.98	P	
* 7323.35	44.87	39.13	6.59	42.28	0.27	48.57	54.00	-5.43	A	

Remark:

1. AF: Antenna Factor, Cable: Cable Loss, Pre-Amp: Preamplifier gain, Filter: High Pass Filter Insertion Loss (3.5GHz)
2. Spectrum analyzer setting P(Peak): RBW=1MHz, VBW=1MHz, A(Average): RBW=1MHz, VBW=510Hz
3. The result basic equation calculation is as follow:
Level = Reading + AF + Cable – Preamp + Filter, Margin = Level-Limit
4. The other emission levels were 20dB below the limit
5. The test limit distance is 3M limit.
6. *=Restricted bands of operation

Report No.: T210622N01-RP1-1

Product Name	Automatic Wireless Turntable	Test Date	2021/07/08
Model Name	AT-LP3XBT	Test By	Ted Huang
Test Mode	CH High TX / 8-DPSK	Temp & Humidity	26.8°C, 56%

Horizontal

TX mode / CH High				Measurement Distance at 3m			Horizontal polarity			
Freq.	Reading	AF	Cable Loss	Pre-amp	Filter	Level	Limit	Margin	Mark	
(MHz)	(dBμV)	(dB/m)	(dB)	(dB)	(dB)	(dBμV/m)	(dBμV/m)	(dB)	(P/Q/A)	
1734.28	60.45	28.47	3.40	44.42	0.70	48.62	74.00	-25.38	P	
1734.28	51.78	28.47	3.40	44.42	0.70	39.95	54.00	-14.05	A	
* 4959.91	62.32	33.57	5.57	42.59	0.24	59.10	74.00	-14.90	P	
* 4959.91	55.83	33.57	5.57	42.59	0.24	52.62	54.00	-1.38	A	
* 7439.81	55.71	39.57	6.62	42.13	0.27	60.04	74.00	-13.96	P	
* 7439.81	45.75	39.57	6.62	42.13	0.27	50.08	54.00	-3.92	A	

Vertical

TX mode / CH High				Measurement Distance at 3m			Vertical polarity			
Freq.	Reading	AF	Cable Loss	Pre-amp	Filter	Level	Limit	Margin	Mark	
(MHz)	(dBμV)	(dB/m)	(dB)	(dB)	(dB)	(dBμV/m)	(dBμV/m)	(dB)	(P/Q/A)	
1716.28	62.86	28.33	3.39	44.44	0.69	50.82	74.00	-23.18	P	
1716.28	52.68	28.33	3.39	44.44	0.69	40.64	54.00	-13.36	A	
* 4959.96	60.45	33.57	5.57	42.59	0.24	57.24	74.00	-16.76	P	
* 4959.96	53.12	33.57	5.57	42.59	0.24	49.90	54.00	-4.10	A	
* 7440.24	55.34	39.57	6.62	42.13	0.27	59.67	74.00	-14.33	P	
* 7440.24	45.53	39.57	6.62	42.13	0.27	49.86	54.00	-4.14	A	

Remark:

1. AF: Antenna Factor, Cable: Cable Loss, Pre-Amp: Preamplifier gain, Filter: High Pass Filter Insertion Loss (3.5GHz)
2. Spectrum analyzer setting P(Peak): RBW=1MHz, VBW=1MHz, A(Average): RBW=1MHz, VBW=510Hz
3. The result basic equation calculation is as follow:
Level = Reading + AF + Cable – Preamp + Filter, Margin = Level-Limit
4. The other emission levels were 20dB below the limit
5. The test limit distance is 3M limit.
6. *=Restricted bands of operation

Report No.: T210622N01-RP1-1

8.8.4 RESTRICTED BAND EDGES

Model Name	AT-LP3XBT	Test By	Ted Huang
Temp & Humidity	26.8°C, 56%	Test Date	2021/07/08

Detector Mode : Peak **Polarity : Horizontal**

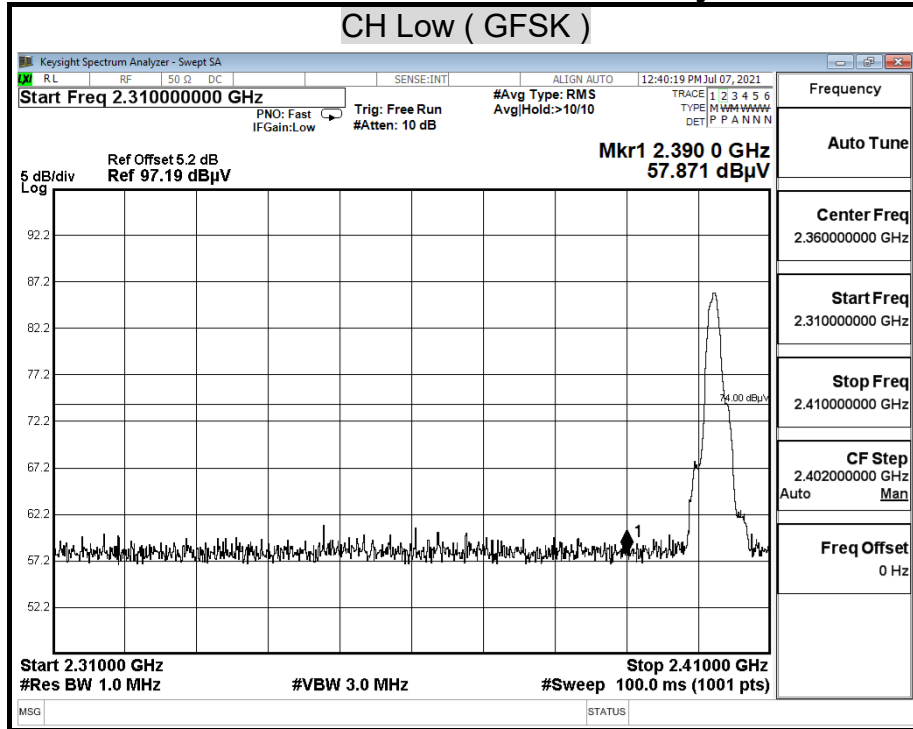

Detector Mode : Average **Polarity : Horizontal**

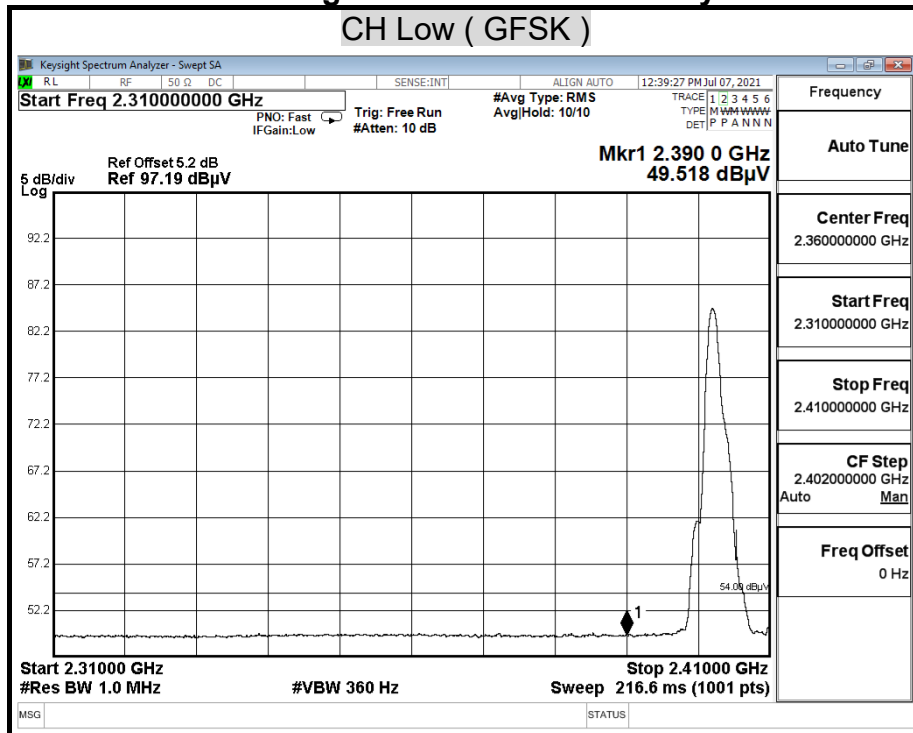

Detector Mode : Peak

Polarity : Vertical

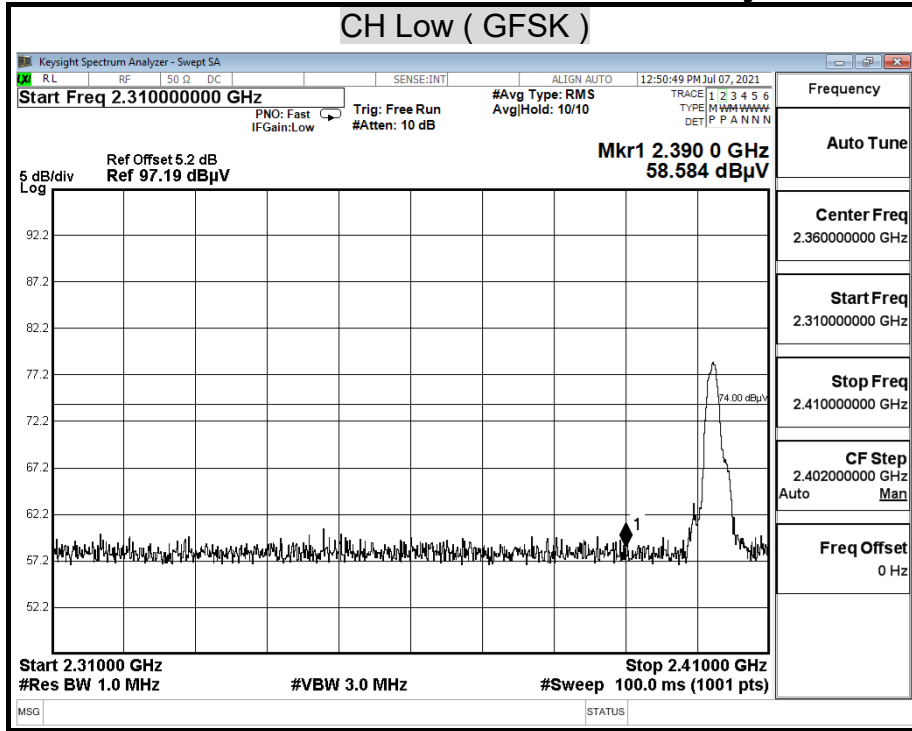

Detector Mode : Average

Polarity : Vertical

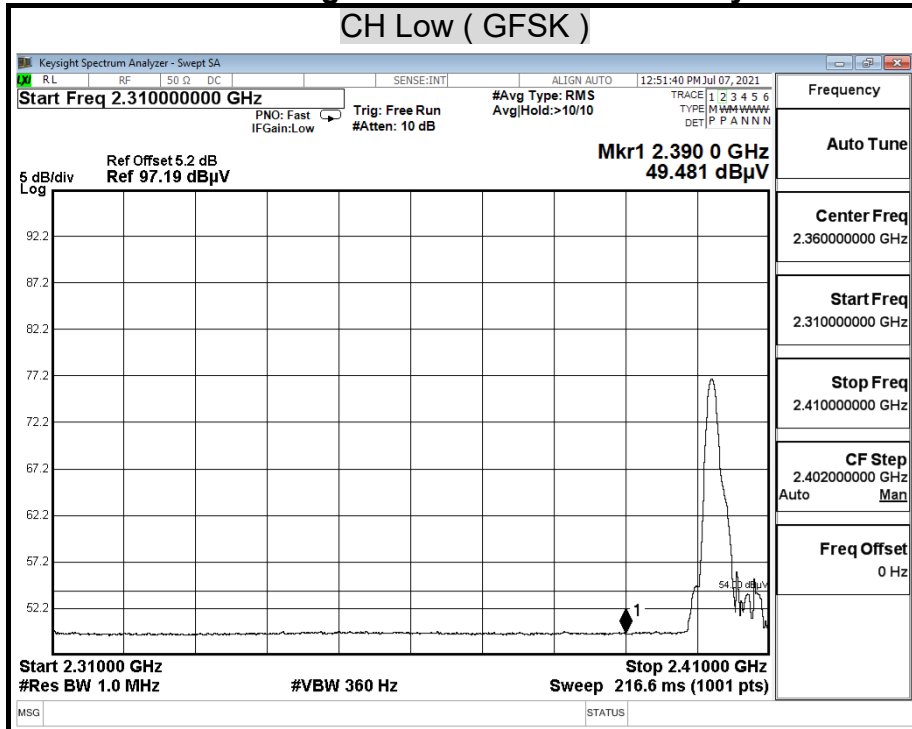

Detector Mode : Peak

Polarity : Horizontal

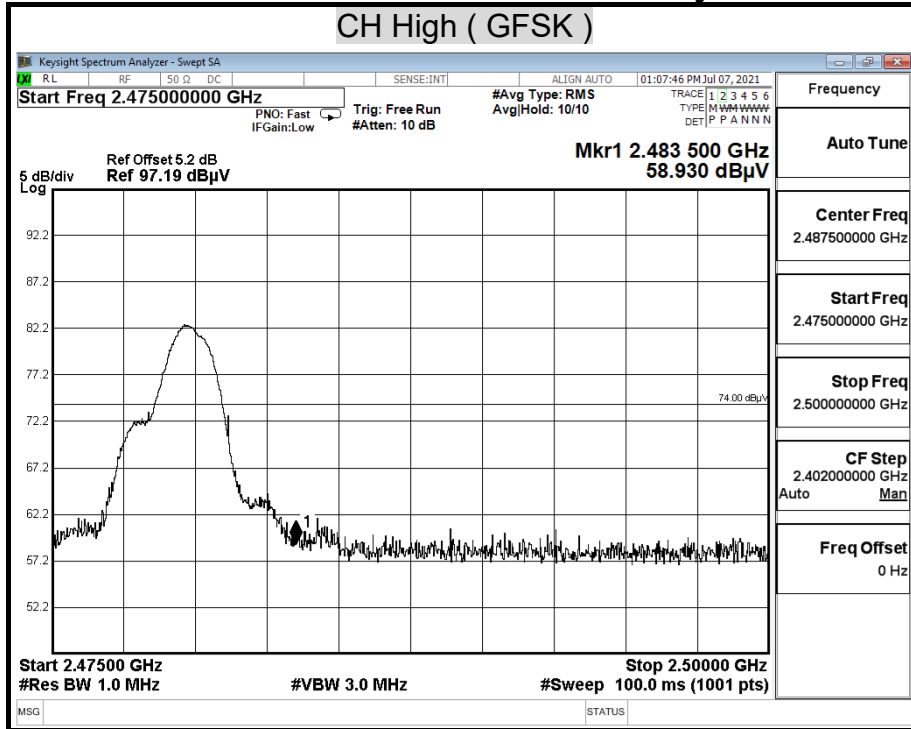

Detector Mode : Average

Polarity : Horizontal

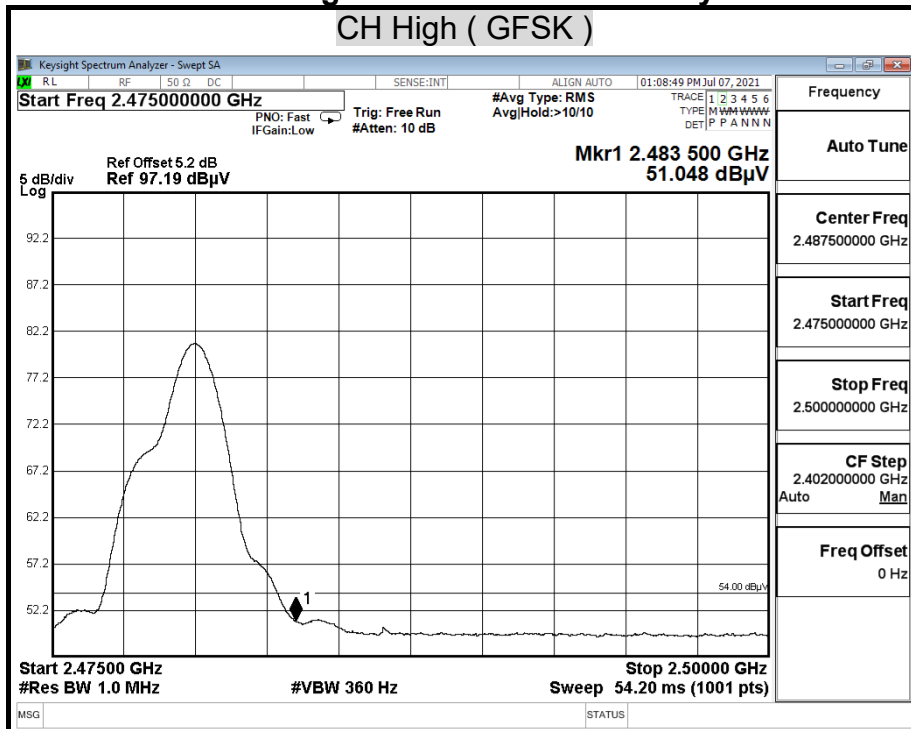

Detector Mode : Peak

Polarity : Vertical

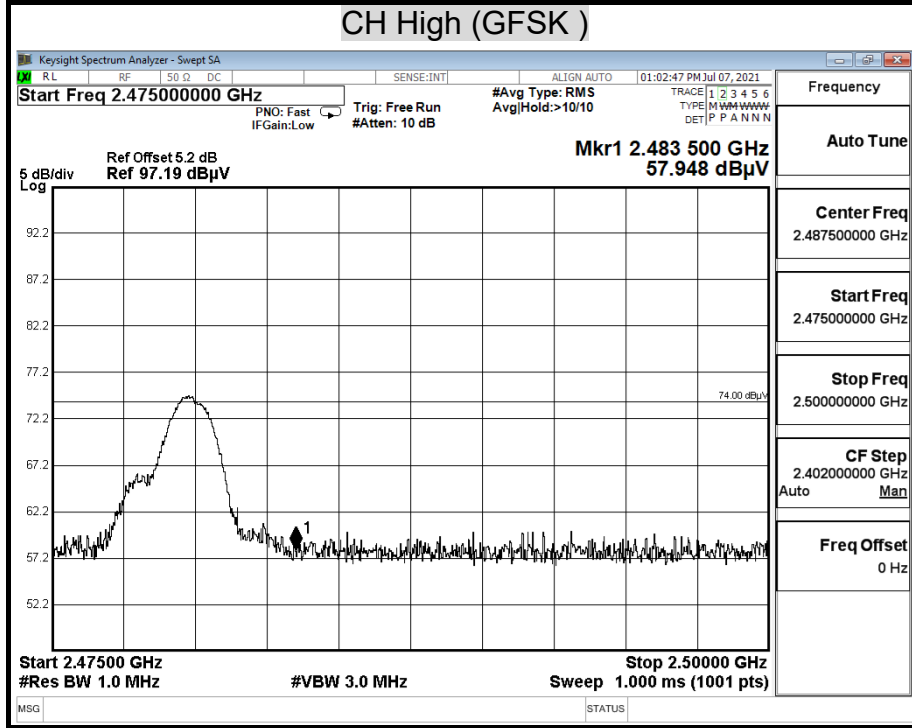

Detector Mode : Average

Polarity : Vertical

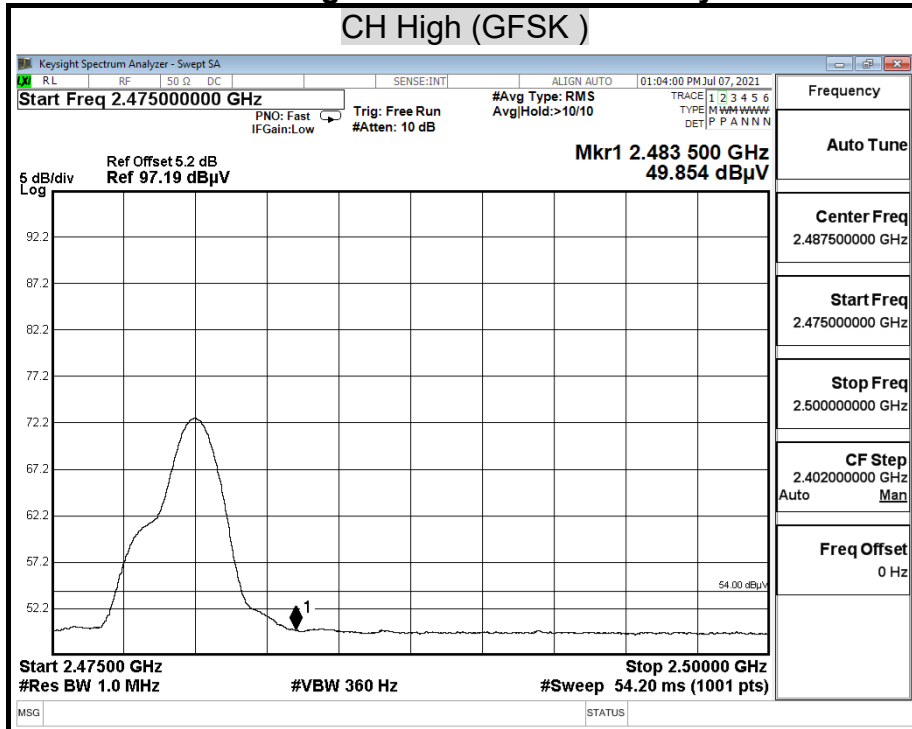

Detector Mode : Peak

Polarity : Horizontal

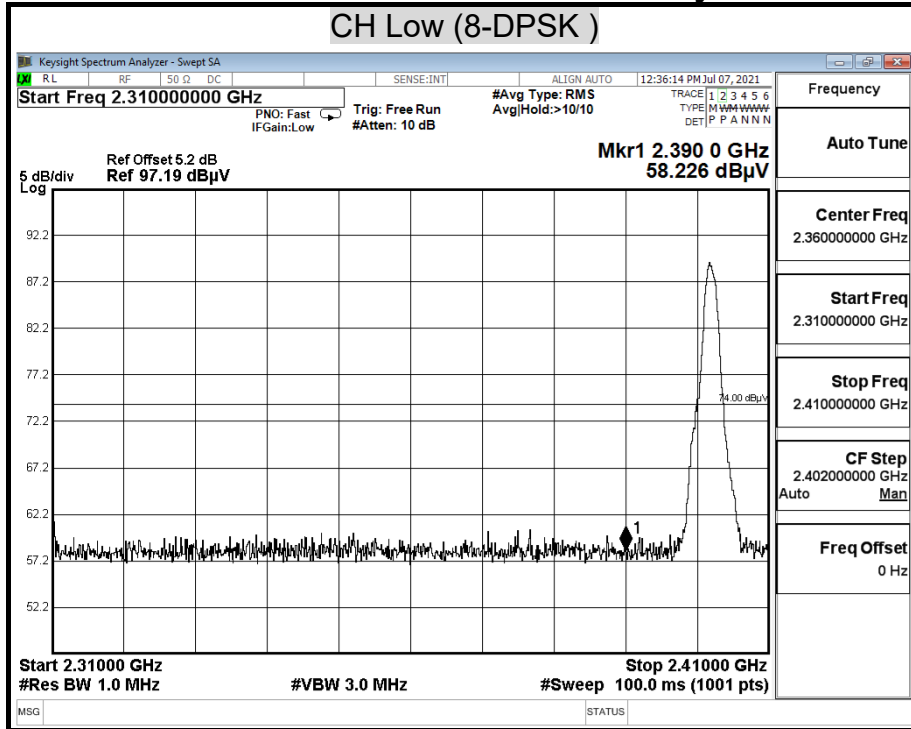

Detector Mode : Average

Polarity : Horizontal

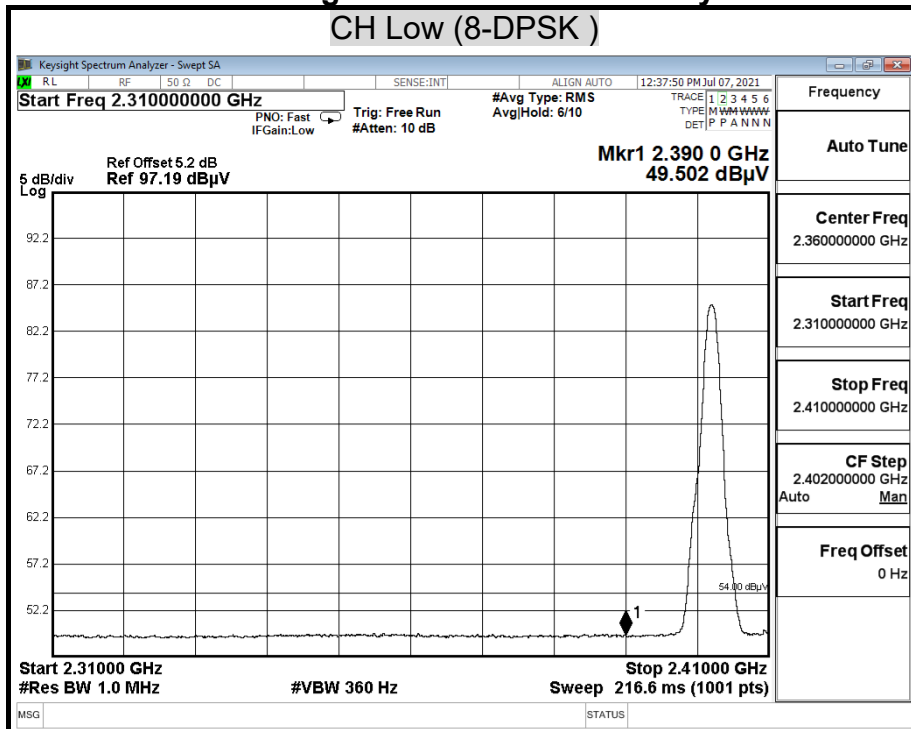

Detector Mode : Peak

Polarity : Vertical

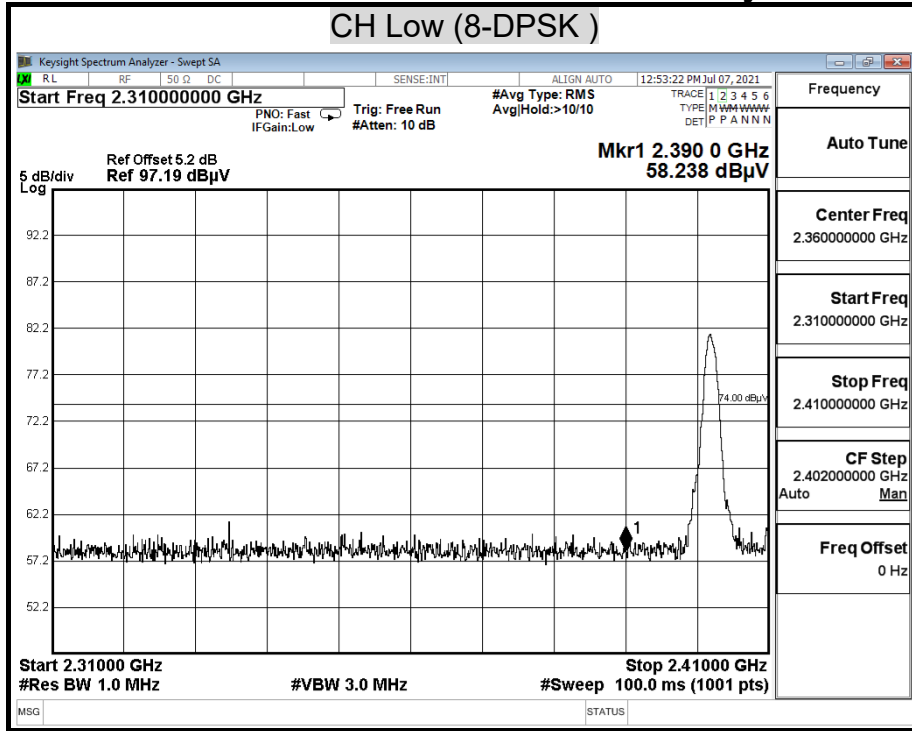

Detector Mode : Average

Polarity : Vertical

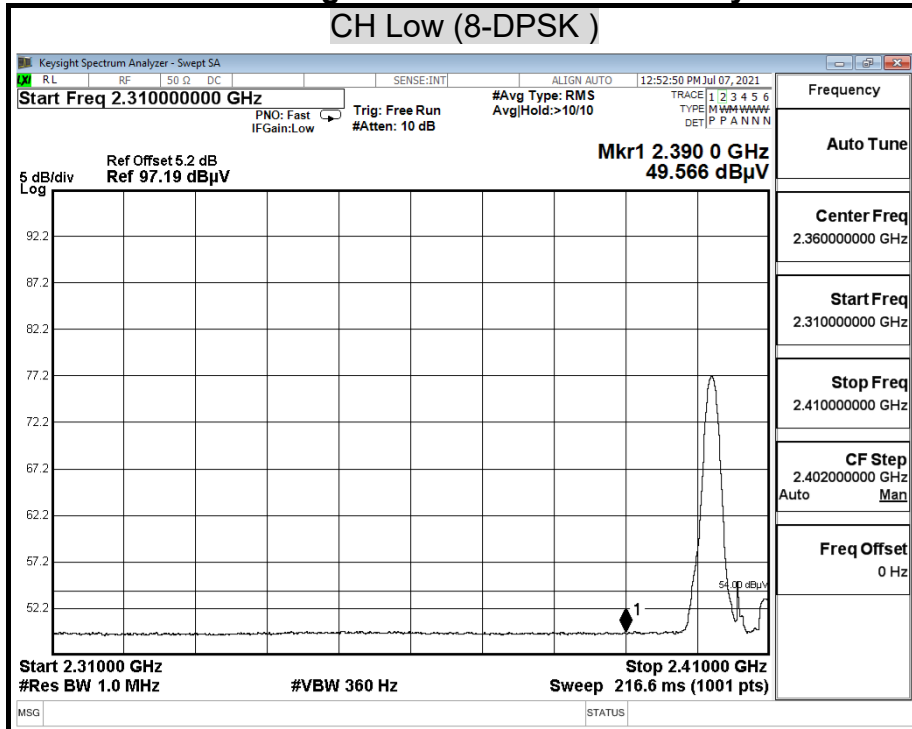

Detector Mode : Peak **Polarity : Horizontal**

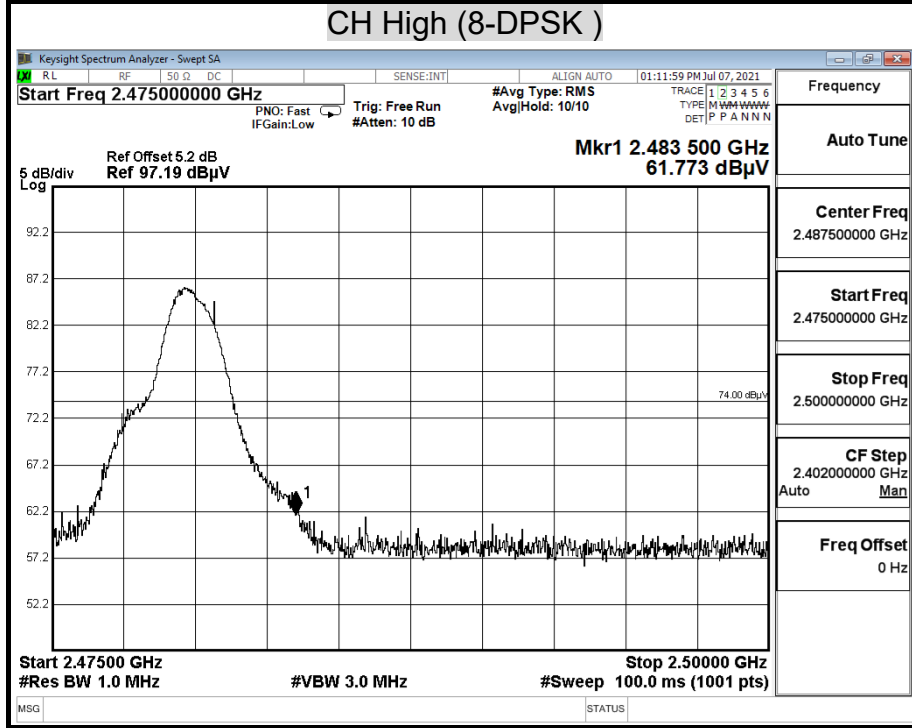

Detector Mode : Average **Polarity : Horizontal**

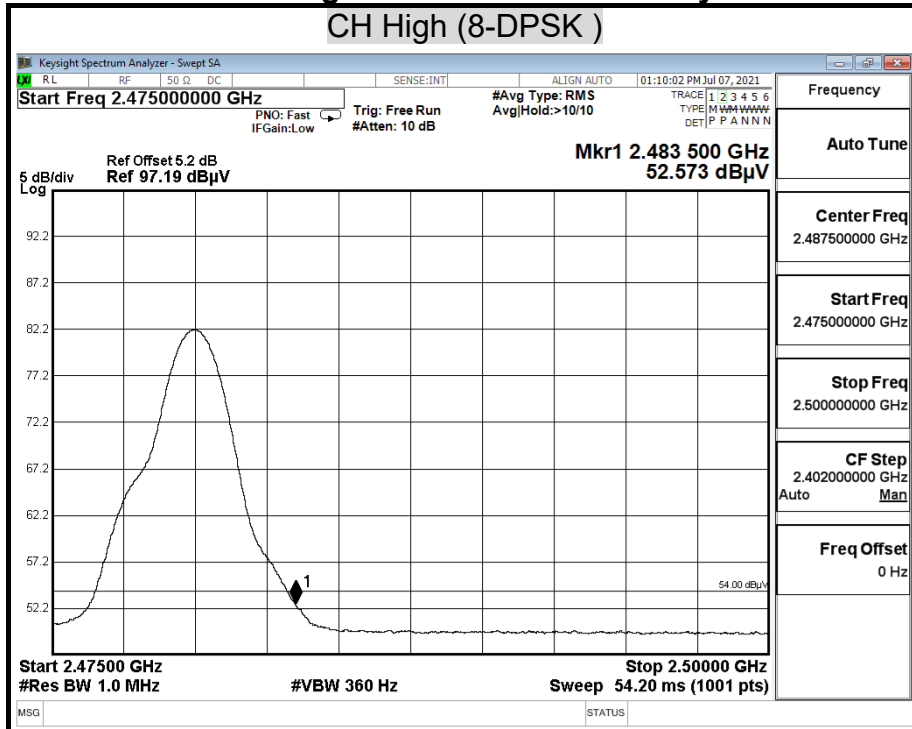

Report No.: T210622N01-RP1-1

Detector Mode : Peak **Polarity : Vertical**

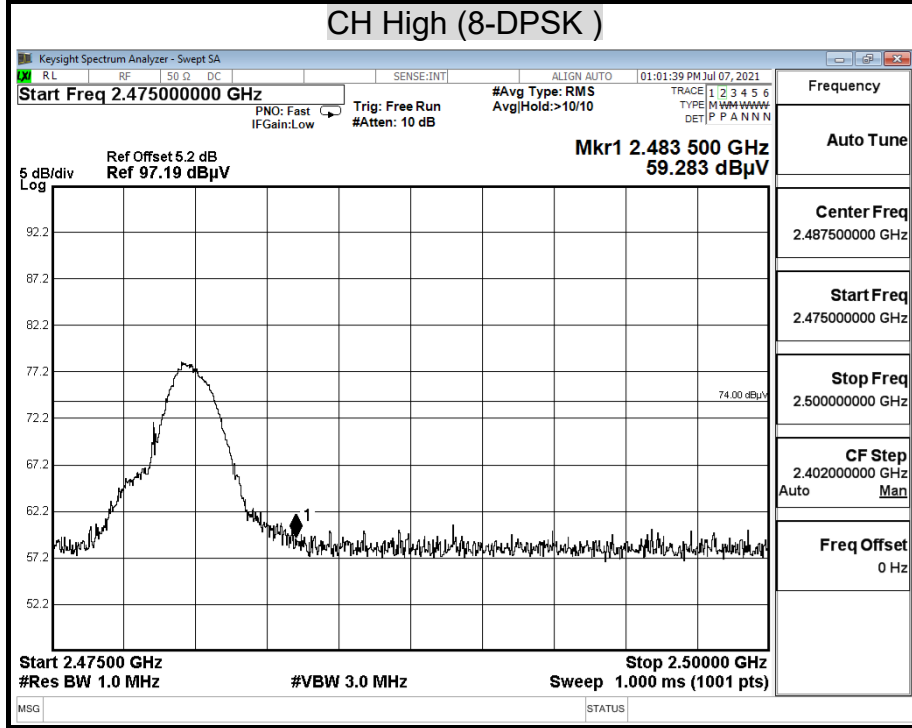

Detector Mode : Average **Polarity : Vertical**

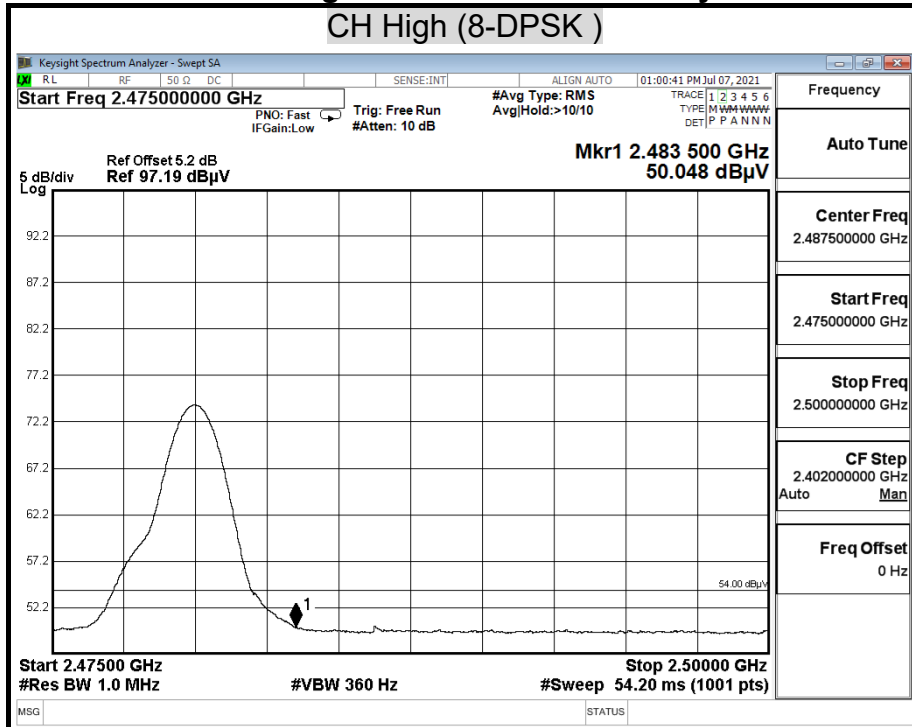

Report No.: T210622N01-RP1-1

8.9 POWERLINE CONDUCTED EMISSIONS

LIMITS

§ 15.207 (a) Except as shown in paragraph (b) and (c) this section, for an intentional radiator that is designed to be connected to the public utility (AC) power line, the radio frequency voltage that is conducted back onto the AC power line on any frequency or frequencies within the band 150 kHz to 30 MHz shall not exceed the limits in the following table, as measured using a 50 μ H/50 ohms line impedance stabilization network (LISN). Compliance with the provisions of this paragraph shall be based on the measurement of the radio frequency voltage between each power line and ground at the power terminal.

The lower limit applies at the boundary between the frequency ranges.

Frequency of Emission (MHz)	Conducted limit (dB μ v)	
	Quasi-peak	Average
0.15 - 0.5	66 to 56	56 to 46
0.5 - 5	56	46
5 - 30	60	50

Report No.: T210622N01-RP1-1

TEST SETUP

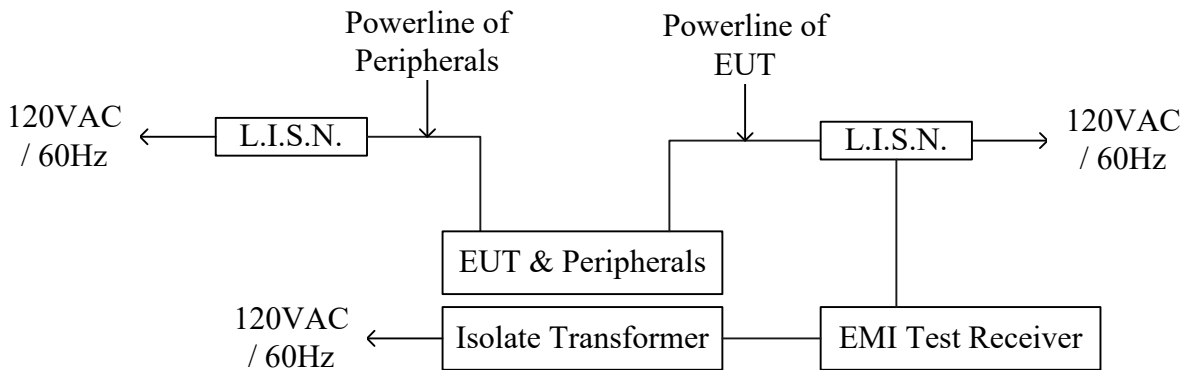
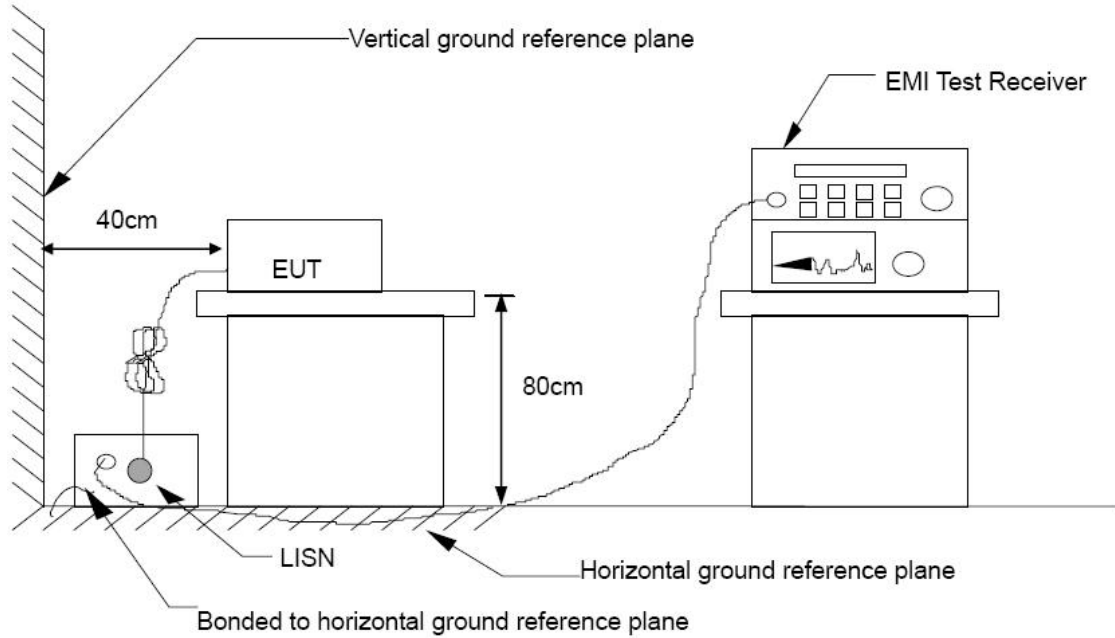

TEST PROCEDURE

The EUT is placed on a non-conducting table 40 cm from the vertical ground plane and 80cm above the horizontal ground plane. The EUT IS CONFIGURED IN ACCORDANCE WITH ANSI C63.10 : 2013.

The resolution bandwidth is set to 9 kHz for both quasi-peak detection and average detection measurements.

Line conducted data is recorded for both NEUTRAL and LINE.

Report No.: T210622N01-RP1-1

TEST RESULTS

Model No.	AT-LP3XBT	Test Mode	LINE
Environmental Conditions	26.4°C, 62% RH	Resolution Bandwidth	9 kHz
Tested by	Oz Ding		

LINE

(The chart below shows the highest readings taken from the final data.)

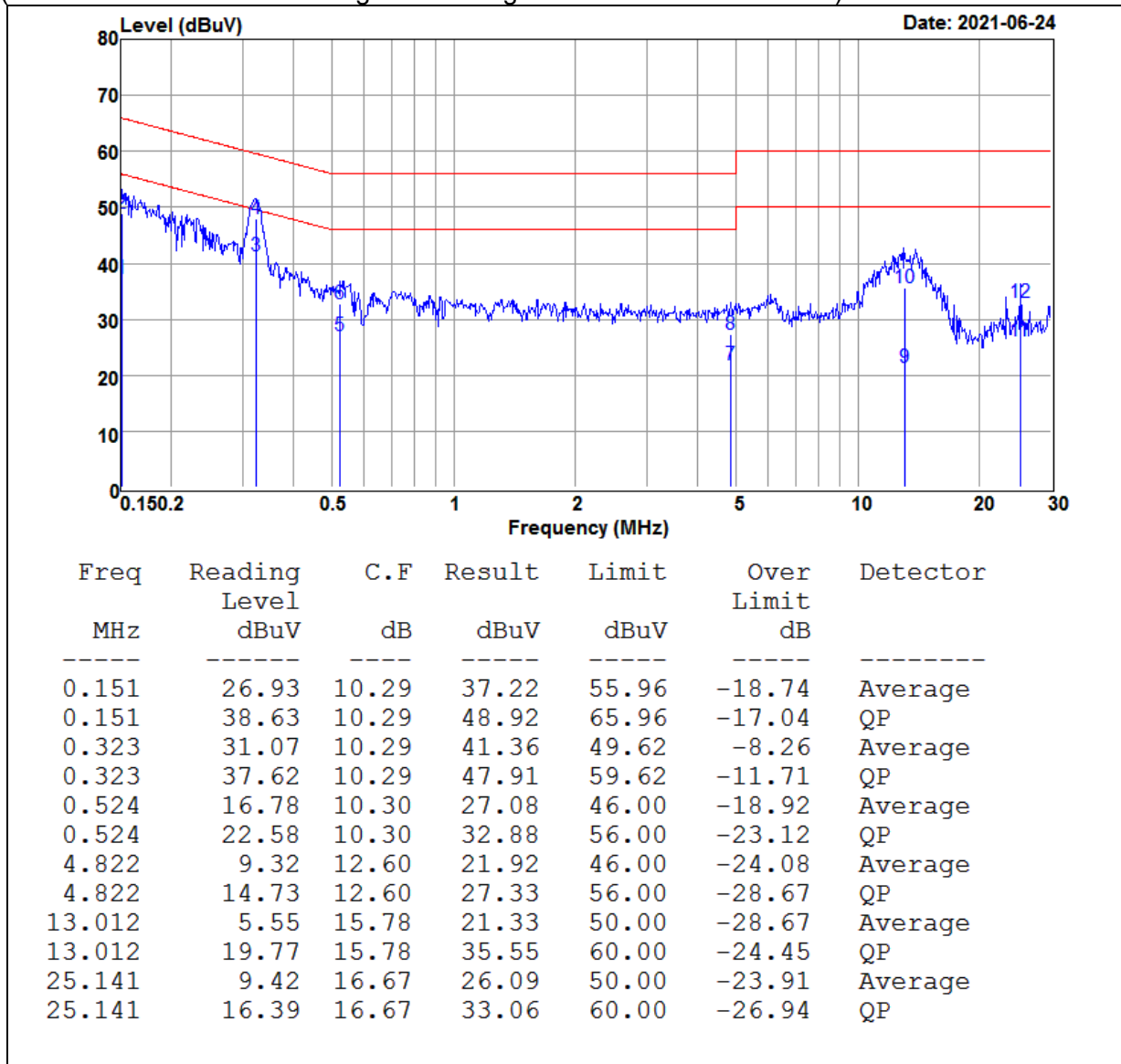

Report No.: T210622N01-RP1-1

Model No.	AT-LP3XBT	Test Mode	LINE
Environmental Conditions	26.4°C, 62% RH	Resolution Bandwidth	9 kHz
Tested by	Oz Ding		

NEUTRAL

(The chart below shows the highest readings taken from the final data.)

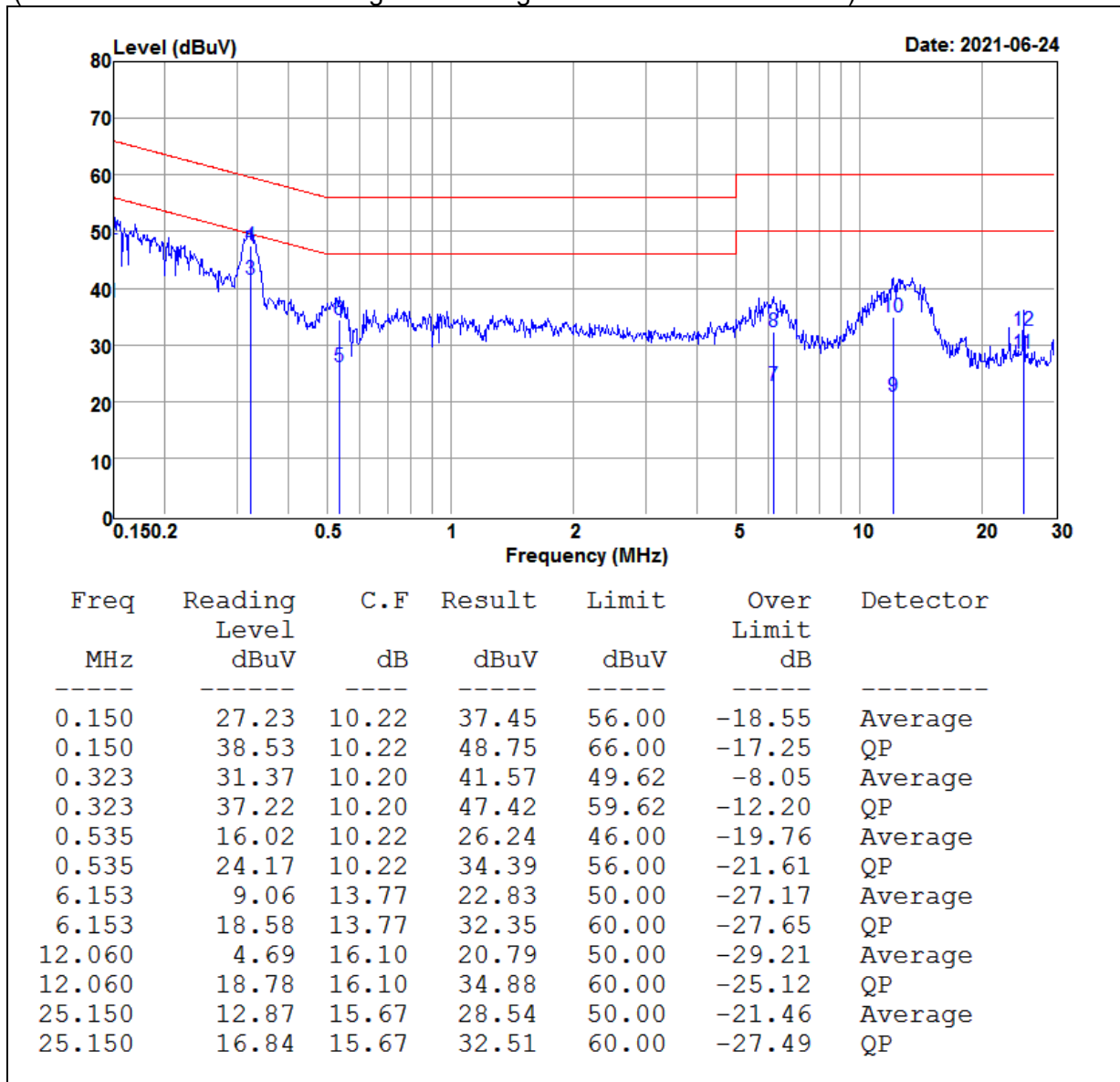

=== END of Report ===