



FCC ID: JFZLP3XBT
Report No.: T210622N01-RP1-1

Page: 1 / 101
Rev.: 00

FCC 47 CFR PART 15 SUBPART C AND ANSI C63.10: 2013 TEST REPORT

For

Automatic Wireless Turntable

Model: AT-LP3XBT

Data Applies To: N/A

Brand Name: audio-technica

Issued for

Audio-Technica Corporation

2-46-1 Nishi-naruse, Machida, Tokyo 194-8666, JAPAN

Issued By

Compliance Certification Services Inc.

Tainan Lab.

**No.8, Jiucengling, Xinhua Dist.,
Tainan City, Taiwan**

Issued Date: August 20, 2021

Note: *This report shall not be reproduced except in full, without the written approval of Compliance Certification Services Inc. This document may be altered or revised by Compliance Certification Services Inc. personnel only, and shall be noted in the revision section of the document. The client should not use it to claim product endorsement by TAF or any government agencies. The test results in the report only apply to the tested sample.*

Unless otherwise stated the results shown in this test report refer only to the sample(s) tested and such sample(s) are retained for 90 days only.
除非另有說明，此報告結果僅對測試之樣品負責，同時此樣品僅保留90天。本報告未經本公司書面許可，不可部份複製。

This document is issued by the Company subject to its General Conditions of Service printed overleaf, available on request or accessible at <http://www.sgs.com.tw/Terms-and-Conditions> and, for electronic format documents, subject to Terms and Conditions for Electronic Documents at <http://www.sgs.com.tw/Terms-and-Conditions>. Attention is drawn to the limitation of liability, indemnification and jurisdiction issues defined therein. Any holder of this document is advised that information contained hereon reflects the Company's findings at the time of its intervention only and within the limits of client's instruction, if any. The Company's sole responsibility is to its Client and this document does not exonerate parties to a transaction from exercising all their rights and obligations under the transaction documents. This document cannot be reproduced, except in full, without prior written approval of the Company. Any unauthorized alteration, forgery or falsification of the content or appearance of this document is unlawful and offenders may be prosecuted to the fullest extent of the law.

REVISION HISTORY

Rev.	Issue Date	Revisions	Effect Page	Revised By
00	August 20, 2021	Initial Issue	ALL	Gina Lin

TABLE OF CONTENTS

TITLE	PAGE NO.
1. TEST REPORT CERTIFICATION	4
2. TEST RESULT SUMMARY.....	5
3. EUT DESCRIPTION	6
3.1 DESCRIPTION OF EUT & POWER.....	6
4. DESCRIPTION OF TEST MODES	7
5. TEST METHODOLOGY	9
6. FACILITIES AND ACCREDITATIONS.....	10
6.1 FACILITIES	10
6.2 EQUIPMENT	10
6.3 LABORATORY ACCREDITATIONS LISTINGS.....	10
6.4 TABLE OF ACCREDITATIONS AND LISTINGS	11
6.5 MEASUREMENT EQUIPMENT USED	12
6.6 MEASURING INSTRUMENT CALIBRATION	13
6.7 MEASUREMENT UNCERTAINTY	13
7. SETUP OF EQUIPMENT UNDER TEST.....	14
7.1 SETUP CONFIGURATION OF EUT	14
7.2 SUPPORT EQUIPMENT.....	15
8. APPLICABLE LIMITS AND TEST RESULTS.....	17
8.1 20dB BANDWIDTH FOR HOPPING	17
8.2 MAXIMUM PEAK OUTPUT POWER	23
8.3 HOPPING CHANNEL SEPARATION.....	34
8.4 NUMBER OF HOPPING FREQUENCY USED	39
8.5 DWELL TIME ON EACH CHANNEL	42
8.6 DUTY CYCLE.....	56
8.7 CONDUCTED SPURIOUS EMISSION	61
8.8 RADIATED EMISSIONS	72
8.8.1 TRANSMITTER RADIATED SUPURIOUS EMSSIONS	72
8.8.2 WORST-CASE RADIATED EMISSION BELOW 1 GHZ.....	76
8.8.3 TRANSMITTER RADIATED EMISSION ABOVE 1 GHZ	79
8.8.4 RESTRICTED BAND EDGES	85
8.9 POWERLINE CONDUCTED EMISSIONS	93
APPENDIX I PHOTOGRPHS OF TEST SETUP	97

1. TEST REPORT CERTIFICATION

Applicant	:	Audio-Technica Corporation 2-46-1 Nishi-naruse, Machida, Tokyo 194-8666, JAPAN
Manufacturer	:	Audio-Technica Corporation 2-46-1 Nishi-naruse, Machida, Tokyo 194-8666, JAPAN
Equipment Under Test	:	Automatic Wireless Turntable
Model Number	:	AT-LP3XBT
Data Applies To	:	N/A
Brand Name	:	audio-technica
Date of Test	:	June 24, 2021 ~ July 09, 2021

APPLICABLE STANDARD	
STANDARD	TEST RESULT
FCC Part 15 Subpart C AND ANSI C63.10: 2013	PASS
Statements of Conformity	
Determining compliance shall be based on the results of the compliance measurement, not taking into account measurement instrumentation uncertainty.	

We hereby certify that:

The above equipment was tested by Compliance Certification Services Inc. The test data, data evaluation, test procedures, and equipment configurations shown in this report were made in accordance with the procedures given in **ANSI C63.10: 2013** and the energy emitted by the sample EUT tested as described in this report is in compliance with the requirements of FCC Rules Part 15.207, 15.209, 15.247.

The test results of this report relate only to the tested sample EUT identified in this report.

Approved by:



Eric Huang
Section Manager

Report No.: T210622N01-RP1-1

2. TEST RESULT SUMMARY

FCC Standard Section	Report Section	Test Item	Result
15.203	3	ANTENNA REQUIREMENT	Pass
15.247(a)(1)	8.1	20dB BANDWIDTH	Pass
15.247(b)(1)	8.2	MAXIMUM PEAK OUTPUT POWER	Pass
15.247(a)(1)	8.3	HOPPING CHANNEL SEPARATION	Pass
15.247(a)(1)(iii)	8.4	NUMBER OF HOPPING FREQUENCY USED	Pass
15.247(a)(1)(iii)	8.5	DWELL TIME	Pass
-	8.6	DUTY CYCLE	-
15.247(d)	8.7	CONDUCTED SPURIOUS EMISSION	Pass
15.247(d)	8.8	RADIATED EMISSIONS	Pass
15.207(a)	8.9	POWERLINE CONDUCTED EMISSIONS	Pass

3. EUT DESCRIPTION

3.1 DESCRIPTION OF EUT & POWER

Product	Automatic Wireless Turntable
Model Number	AT-LP3XBT
Data Applies To	N/A
Brand Name	audio-technica
Identify Number	T210622N01
Received Date	June 22, 2021
Reported Date	July 23, 2021
Frequency Range	2402MHz ~ 2480MHz
Transmit Peak Power	GFSK : -18.666dBm / 0.014mW 8DPSK: -14.529dBm / 0.035mW
Channel Spacing	1MHz
Transmit Data Rate	GFSK Mode : 1 Mbps 4/πDQPSK Mode : 2Mbps 8DPSK Mode : 3Mbps
Modulation Type	GFSK 、π/4DQPSK 、8DPSK
Number of Channels	79 Channels
EUT Power Supply	DC 12V (Powered by adapter)
Antenna Type	Manufacturer: Advanced Ceramic X Type: Multilayer Chip Antenna Model: AT3216-B2R7HAA Gain: 0.5 dBi
Firmware Version	V1.0
Software Version	V1.0

Power Adapter :

Manufacturer	Model No.	Power Input	Power Output
SHENZHEN FUJIA APPLIANCE CO., LTD.	FJ-SW1261200500DN	AC 100-240V, 50/60Hz, 0.4A	DC 12V, 0.5A, 6.0W

Remark:

1. The sample selected for test was production product and was provided by manufacturer.
2. This submittal(s) (test report) is intended for **FCC ID: JFZLP3XBT** filing to comply with Section 15.207, 15.209 and 15.247 of the FCC Part 15, Subpart C Rules.
3. For more details, please refer to the User's manual of the EUT.

4. DESCRIPTION OF TEST MODES

The EUT had been tested under operating condition.

There are three channels have been tested as following :

Channel	Frequency (MHz)
Low	2402
Middle	2441
High	2480

Radiated Emission Test (Below 1 GHz):

- Pre-Scan has been conducted to determine the worst-case mode from all possible combinations between available modulations, data rates and antenna ports (if EUT with antenna diversity architecture).
- Following channel(s) was (were) selected for the final test as listed below.

Normal Operation

Radiated Emission Test (Above 1 GHz):

- Pre-Scan has been conducted to determine the worst-case mode from all possible combinations between available modulations, data rates and antenna ports (if EUT with antenna diversity architecture).
- Following channel(s) was (were) selected for the final test as listed below.

Tested Channel	Modulation Technology	Modulation Type	Packet Type
Low, Mid, High	FHSS	GFSK	DH5
Low, Mid, High	FHSS	8-DPSK	3-DH5

Bandedge Measurement :

- Pre-Scan has been conducted to determine the worst-case mode from all possible combinations between available modulations, data rates and antenna ports (if EUT with antenna diversity architecture).
- Following channel(s) was (were) selected for the final test as listed below.

Tested Channel	Modulation Technology	Modulation Type	Packet Type
Low, High	FHSS	GFSK	DH5
Low, High	FHSS	8-DPSK	3-DH5

Antenna Port Conducted Measurement :

- Pre-Scan has been conducted to determine the worst-case mode from all possible combinations between available modulations, data rates and antenna ports (if EUT with antenna diversity architecture).
- Following channel(s) was (were) selected for the final test as listed below.

Tested Channel	Modulation Technology	Modulation Type	Packet Type
Low, Mid, High	FHSS	GFSK	DH5
Low, Mid, High	FHSS	8-DPSK	3-DH5

5. TEST METHODOLOGY

The tests documented in this report were performed in accordance with ANSI C63.10 : 2013 and FCC CFR 47 15.207, 15.209 and 15.247.

6. FACILITIES AND ACCREDITATIONS

6.1 FACILITIES

All measurement facilities used to collect the measurement data are located at

No.8, Jiucengling, Xinhua Dist., Tainan City 712, Taiwan (R.O.C.)

The sites are constructed in conformance with the requirements of ANSI C63.7, ANSI C63.10 and CISPR Publication 22.

6.2 EQUIPMENT

Radiated emissions are measured with one or more of the following types of linearly polarized antennas: tuned dipole, bi-conical, log periodic, bi-log, and/or ridged waveguide, horn. Spectrum analyzers with pre-selectors and quasi-peak detectors are used to perform radiated measurements.

Conducted emissions are measured with Line Impedance Stabilization Networks and EMI Test Receivers.

Calibrated wideband preamplifiers, coaxial cables, and coaxial attenuators are also used for making measurements.

All receiving equipment conforms to CISPR Publication 16-1, "Radio Interference Measuring Apparatus and Measurement Methods."

6.3 LABORATORY ACCREDITATIONS LISTINGS

The test facilities used to perform radiated and conducted emissions tests are accredited by Taiwan Accreditation Foundation for the specific scope of accreditation under Lab Code: 1109 to perform Electromagnetic Interference tests according to FCC PART 15 AND CISPR 22 requirements. No part of this report may be used to claim or imply product endorsement by TAF or any agency of the Government. In addition, the test facilities are listed with Federal Communications Commission (registration no: TW1109).

Report No.: T210622N01-RP1-1

6.4 TABLE OF ACCREDITATIONS AND LISTINGS

Our laboratories are accredited and approved by the following approval agencies according to ISO/IEC 17025.

Taiwan	TAF
---------------	-----

The measuring facility of laboratories has been authorized or registered by the following approval agencies.

Canada	Industry Canada (ISED#: 2324H)
Germany	TUV NORD
Taiwan	BSMI
USA	FCC
Japan	VCCI

Copies of granted accreditation certificates are available for downloading from our web site, <http://www.ccsrf.com>

Report No.: T210622N01-RP1-1

6.5 MEASUREMENT EQUIPMENT USED

For §8.8.2~8.8.3

Chamber 966 Room (Radiation Test)					
Name of Equipment	Manufacturer	Model	Serial Number	Calibration Date	Calibration Due
Active Loop Antenna	ETS-LINDREN	6502	8905-2356	08/02/2019	08/01/2021
Bilog Antenna With 6dB Attenuator	SUNOL SCIENCES & EMC I	JB1 & AT-N0681	A070506-1 & AT-N0681	09/14/2020	09/13/2021
Cable	Suhner	SUCOFLEX104PE A	20520/4PEA&O6	01/29/2021	01/28/2022
Double Ridged Guide Horn Antenna	ETS-LINDGREN	3116	00078900	03/30/2021	03/29/2022
EMI Test Receiver	R&S	ESCI	100960	02/05/2021	02/04/2022
EXA Spectrum Analyzer	KEYSIGHT	N9010A	MY54430216	07/20/2020	07/19/2021
Horn Antenna	Com-Power	AH-118	071032	05/04/2021	05/03/2022
Pre-Amplifier	EMCI	EMC012645	980098	01/29/2021	01/28/2022
Pre-Amplifier	HP	8447F	2443A01683	01/19/2021	01/18/2022
Pre-Amplifier	Com-Power	PAM-840A	461378	07/20/2020	07/19/2021
Type N coaxial cable	Suhner	CHA9513	6	01/19/2021	01/18/2022
Notch Filter	MICRO-TRONICS	BRM50702-01	018	N.C.R	N.C.R
Software	Excel(ccs-o6-2020 v1.1) , e3(v6.101222)				

For §8.1~8.7 8.8.4

Chamber 966 Room (Conducted Test)					
Name of Equipment	Manufacturer	Model	Serial Number	Calibration Date	Calibration Due
EXA Spectrum Analyzer	KEYSIGHT	N9010A	MY54430216	07/20/2020	07/19/2021
Power Meter	Anritsu	ML2487A	6K00003888	05/18/2021	05/17/2023
Power Sensor	Anritsu	MA2491A	033265	05/18/2021	05/17/2023
SMA Cable + 10dB Attenuator	CCS	SMA+10dB ATT	SMA/10dB	01/29/2021	01/28/2022
Software	Excel(ccs-o6-2020 v1.1)				

For §8.9

Conducted Emission room #1					
Name of Equipment	Manufacturer	Model	Serial Number	Calibration Date	Calibration Due
BNC Coaxial Cable	CCS	BNC50	11	01/21/2021	01/20/2022
EMI Test Receiver	R&S	ESCS 30	100348	02/25/2021	02/24/2022
LISN	FCC	FCC-LISN-50-32-2	08009	06/30/2020	06/29/2021
LISN	SCHWARZBECK	NNLK8130	8130124	01/15/2021	01/14/2022
Pulse Limiter	R&S	ESH3-Z2	100116	01/21/2021	01/20/2022
Test S/W	e3(6.101222)				

Report No.: T210622N01-RP1-1

6.6 MEASURING INSTRUMENT CALIBRATION

The measuring equipment utilized to perform the tests documented in this report has been calibrated in accordance with the manufacturer's recommendations, and is traceable to recognized national standards.

6.7 MEASUREMENT UNCERTAINTY

Where relevant, the following measurement uncertainty levels have been estimated for tests performed on the apparatus:

PARAMETER	UNCERTAINTY
Radiated Emission, 30 to 200 MHz Test Site : CB966	±3.1dB
Radiated Emission, 200 to 1000 MHz Test Site : CB966	±2.7dB
Radiated Emission, 1 to 6 GHz	± 2.7dB
Radiated Emission, 6 to 18 GHz	± 2.7dB
Radiated Emission, 18 to 26.5 GHz	± 2.7dB
Radiated Emission, 26 to 40 GHz	± 3.7dB
Power Line Conducted Emission	± 2.0dB

This measurement uncertainty is confidence of approximately 95%, k=2

Report No.: T210622N01-RP1-1

7. SETUP OF EQUIPMENT UNDER TEST

7.1 SETUP CONFIGURATION OF EUT

EMI

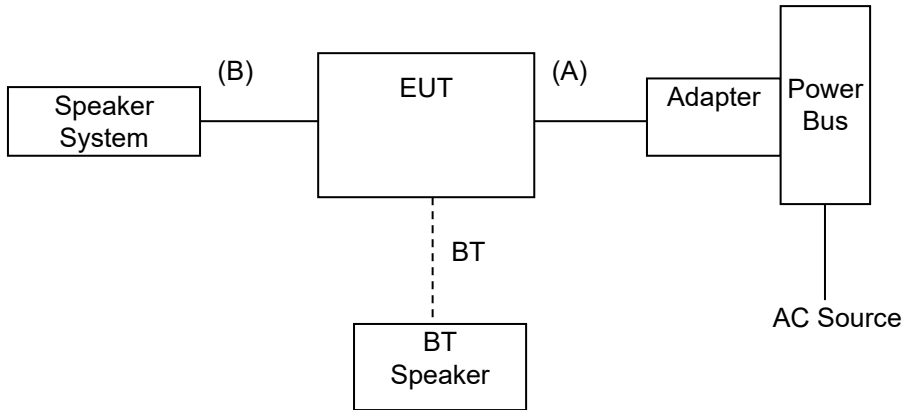

RF

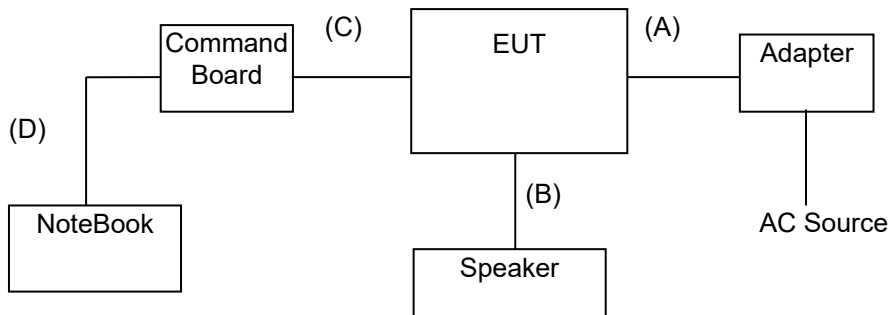

Report No.: T210622N01-RP1-1

7.2 SUPPORT EQUIPMENT

For EMI test

No.	Product	Manufacturer	Model No.	Certify No.	Signal cable
1	Speaker System	T.C.SATR	TCS2285	DOC	Unshd, 1.5m
2	Bluetooth speaker	KINYO	BTS-672	DOC	N/A

No.	Signal cable description	
A	DC power	Unshielded, 1.5m 1 pcs, with 1 core.
B	Audio	Shielded, 2.3m 1 pcs.

For RF test

No.	Product	Manufacturer	Model No.	Certify No.	Signal cable
1	Note Book	Acer	AS 3830TG	DOC	DC Power: unshd, 1.4m, 1core AC Power: unshd, 1.6m
2	Flask Disk	Transcend	Jet Flash790	DOC	N/A

No.	Signal cable description	
A	Power	Unshielded, 1.5m 1 pcs, with 1 core.
B	Audio	Unshielded, 1.0m 1 pcs.
C	Command	Unshielded, 0.4m 1 pcs.
D	USB	Shielded, 1.2m 1 pcs, with 1 core.

Note:

- 1) All the equipment/cables were placed in the worst-case configuration to maximize the emission during the test.
- 2) Grounding was established in accordance with the manufacturer's requirements and conditions for the intended use.
- 3) shd. = shielded; unshd. = unshielded

Report No.: T210622N01-RP1-1

EUT OPERATING CONDITION**RF Setup**

1. Set up all computers like the setup diagram.
2. The “CSR BlueSuite 2.6.4”, “Blue Test 3” software was used for testing.
3. Choose Transport “SPI” and Port “USB SPI (600373)”.

TX Mode:**GFSK(DH1):**

CFG PKT > Packet Type : 4 , Packet Type : 27

TXDATA1 > LO Freq : 2402 (2402,2441,2480) , Power : 2,0 (2,0 , 1,0)

GFSK(DH3):

CFG PKT > Packet Type : 11 , Packet Type : 183

TXDATA1 > LO Freq : 2402 (2402,2441,2480) , Power : 2,0 (2,0 , 1,0)

GFSK(DH5):

CFG PKT > Packet Type : 15 , Packet Type : 339

TXDATA1 > LO Freq : 2402 (2402,2441,2480) , Power : 2,0 (2,0 , 1,0)

8-DPSK(3DH1):

CFG PKT > Packet Type : 24 , Packet Type : 83

TXDATA1 > LO Freq : 2402 (2402,2441,2480) , Power : 81,0 (81,0 , 80,0)

8-DPSK(3DH3):

CFG PKT > Packet Type : 27 , Packet Type : 552

TXDATA1 > LO Freq : 2402 (2402,2441,2480) , Power : 81,0 (81,0 , 80,0)

8-DPSK(3DH5):

CFG PKT > Packet Type : 31 , Packet Type : 1021

TXDATA1 > LO Freq : 2402 (2402,2441,2480) , Power : 81,0 (81,0 , 80,0)

DSSS:

BLE TEST TX > Channel :0 (0,20,39)

Length : 37

Bit pattern : 0

RX Mode:**GFSK , 8-DPSK:**

RXDATA1

DSSS:

BLE TEST RX

4. All of the function are under run.
- 5 .Start test.

8. APPLICABLE LIMITS AND TEST RESULTS

8.1 20dB BANDWIDTH FOR HOPPING

LIMIT

None; for reporting purposes only.

TEST SETUP

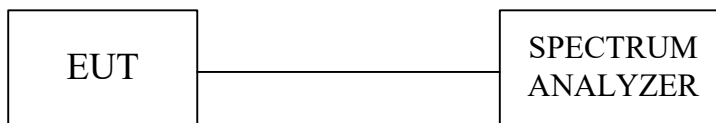

TEST PROCEDURE

The 20dB band width was measured with a spectrum analyzer connected to RF antenna connector (conducted measurement) while EUT was operating in transmit mode at the appropriate center frequency. The analyzer center frequency was set to the EUT carrier frequency, using the analyzer. Display Line and Marker Delta functions, the 20dB band width of the emission was determined.

TEST RESULTS

Model Name	AT-LP3XBT	Test By	Ted Huang
Temp & Humidity	26.8°C, 56%	Test Date	2021/07/08

Modulation Type: GFSK / DH5

Channel	Channel Frequency (MHz)	20dB Bandwidth (kHz)	Two-third of 20dB Bandwidth (MHz)	Pass / Fail
Low	2402	841.00	0.56	PASS
Middle	2441	840.00	0.56	PASS
High	2480	823.00	0.55	PASS

Modulation Type: 8-DPSK / 3-DH5

Channel	Channel Frequency (MHz)	20dB Bandwidth (kHz)	Two-third of 20dB Bandwidth (MHz)	Pass / Fail
Low	2402	1256.00	0.84	PASS
Middle	2441	1269.00	0.85	PASS
High	2480	1267.00	0.84	PASS

20dB BANDWIDTH

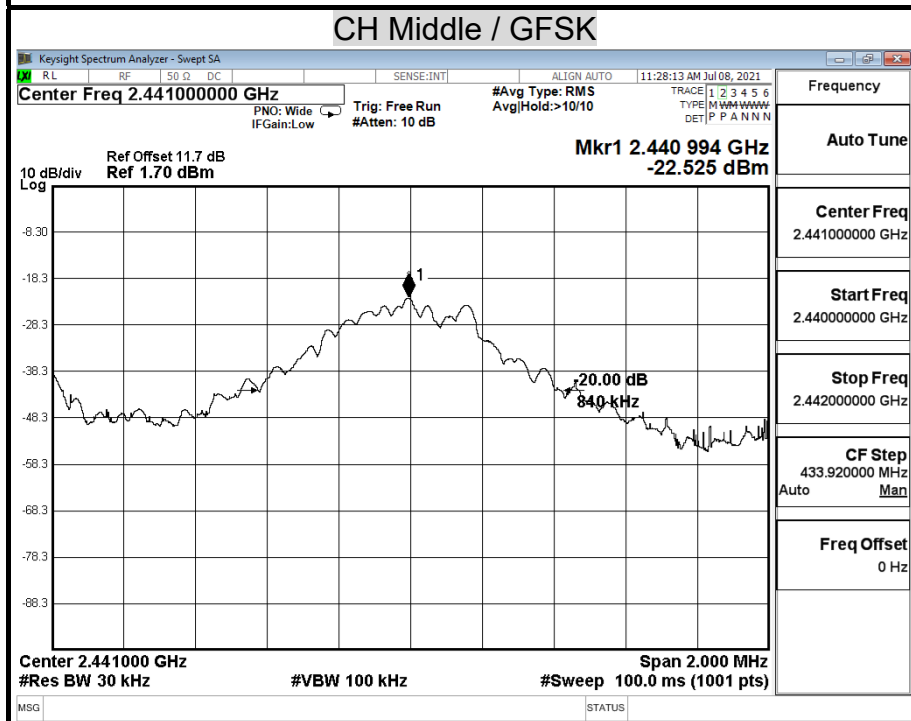
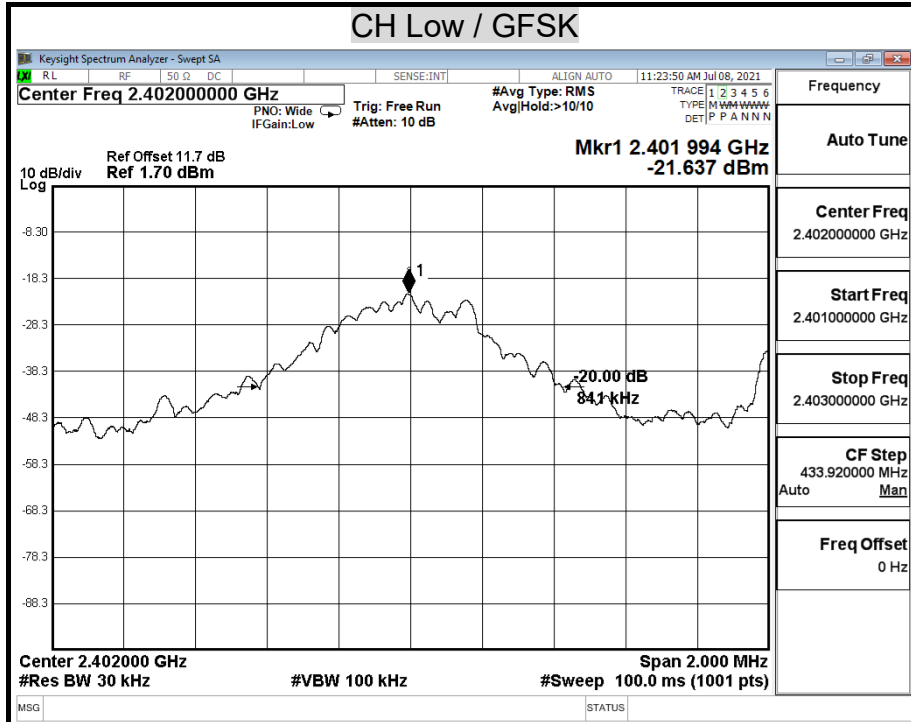

Report No.: T210622N01-RP1-1

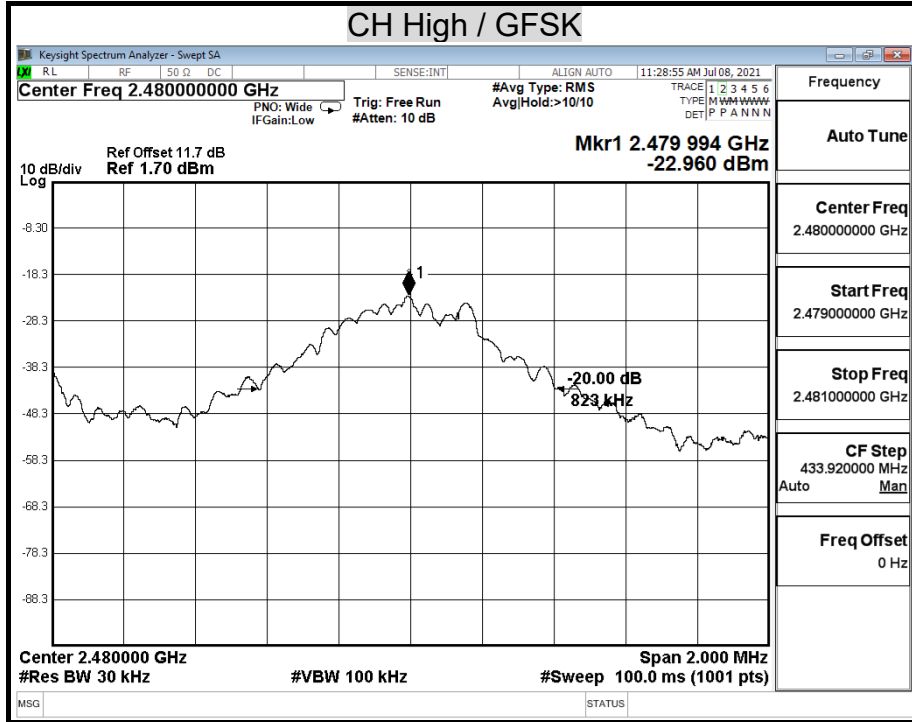

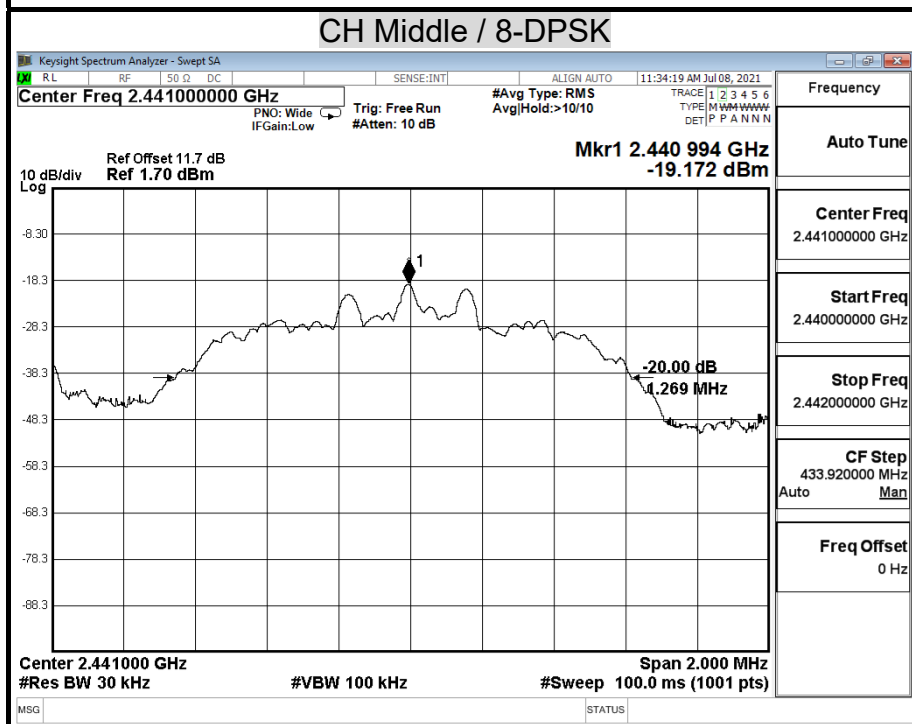
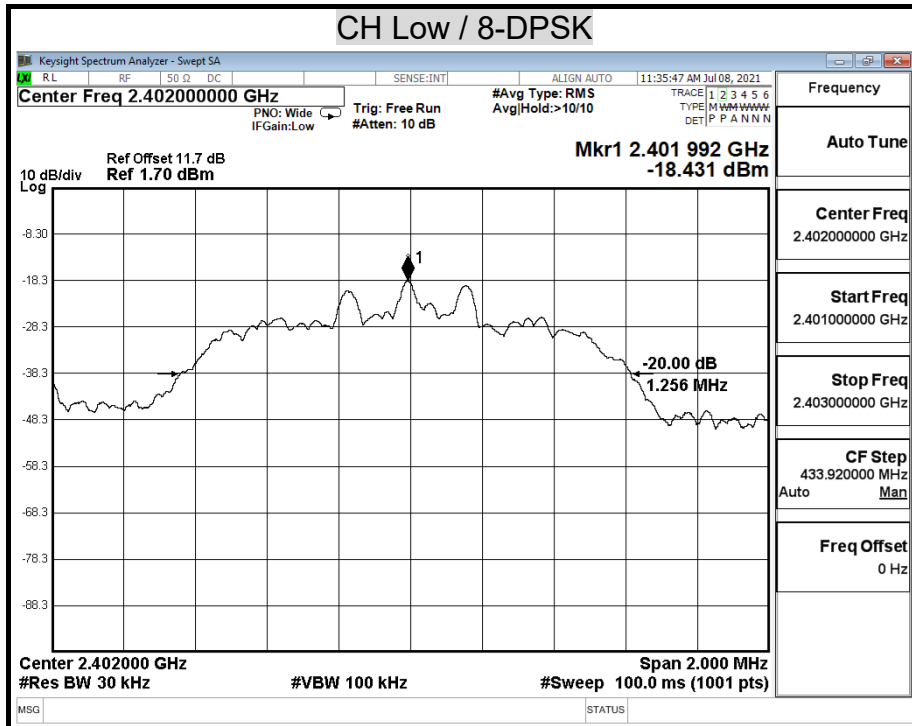

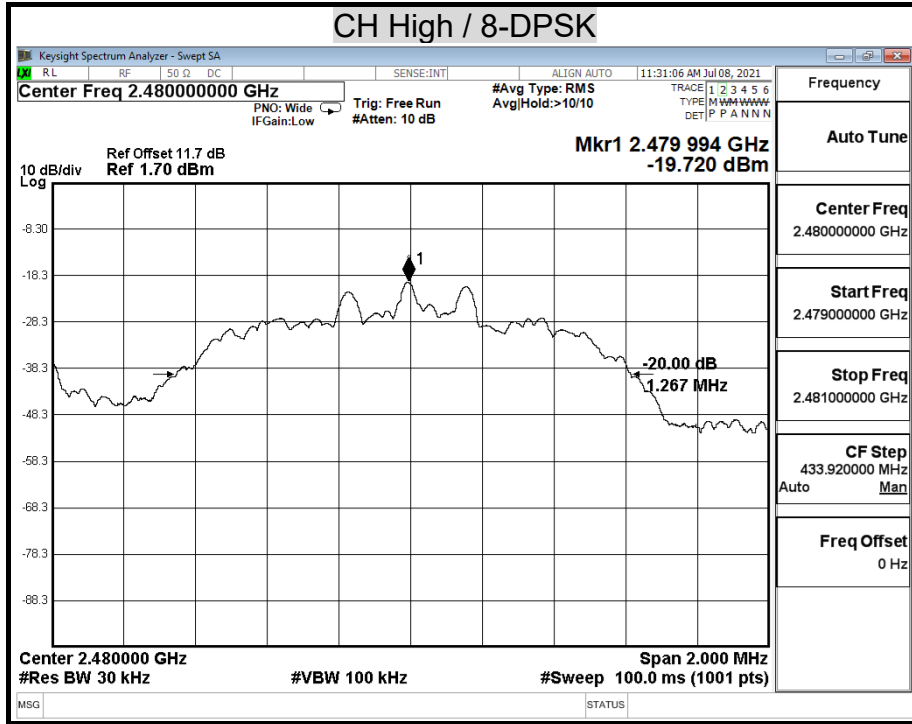

Report No.: T210622N01-RP1-1

8.2 MAXIMUM PEAK OUTPUT POWER

LIMIT

§15.247(b)(1) For frequency hopping systems operating in the 2400-2483.5 MHz band employing at least 75 non-overlapping hopping channels, and all frequency hopping systems in the 5725-5850 MHz band: 1 watt. For all other frequency hopping systems in the 2400-2483.5 MHz band: 0.125 watts.

Test Configuration

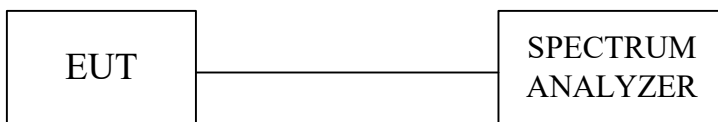

TEST PROCEDURE

The RF power output was measured with a Spectrum Analyzer connected to the RF Antenna connector (conducted measurement) while EUT was operating in transmit mode at the appropriate center frequency, A power meter was used to record the shape of the transmit signal.

Span = approximately 5 times the 20 dB bandwidth, centered on a hopping channel

RBW > the 20 dB bandwidth of the emission being measured

VBW ≥ RBW

Sweep = auto

Detector function = peak

Trace = max hold

Report No.: T210622N01-RP1-1

TEST RESULTS

Model Name	AT-LP3XBT	Test By	Ted Huang
Temp & Humidity	26.8°C, 56%	Test Date	2021/07/08

Modulation Type: GFSK / DH5

Channel	Channel Frequency (MHz)	Peak Power Output (dBm)	Peak Power Output (mW)	Limit (mW)	Result
Low	2402	-18.67	0.01	125	PASS
Mid	2441	-19.77	0.01		PASS
High	2480	-20.25	0.01		PASS

Modulation Type: 8-DPSK / 3-DH5

Channel	Channel Frequency (MHz)	Peak Power Output (dBm)	Peak Power Output (mW)	Limit (mW)	Result
Low	2402	-14.53	0.04	125	PASS
Mid	2441	-15.21	0.03		PASS
High	2480	-15.75	0.03		PASS

Average Power Data

Modulation Type: GFSK / DH5

Channel	Channel Frequency (MHz)	Average Power (dBm)
Low	2402	-23.90
Middle	2441	-25.18
High	2480	-25.66

Modulation Type: 8-DPSK / 3-DH5

Channel	Channel Frequency (MHz)	Average Power (dBm)
Low	2402	-19.00
Middle	2441	-19.45
High	2480	-19.99

MAXIMUM PEAK OUTPUT POWER

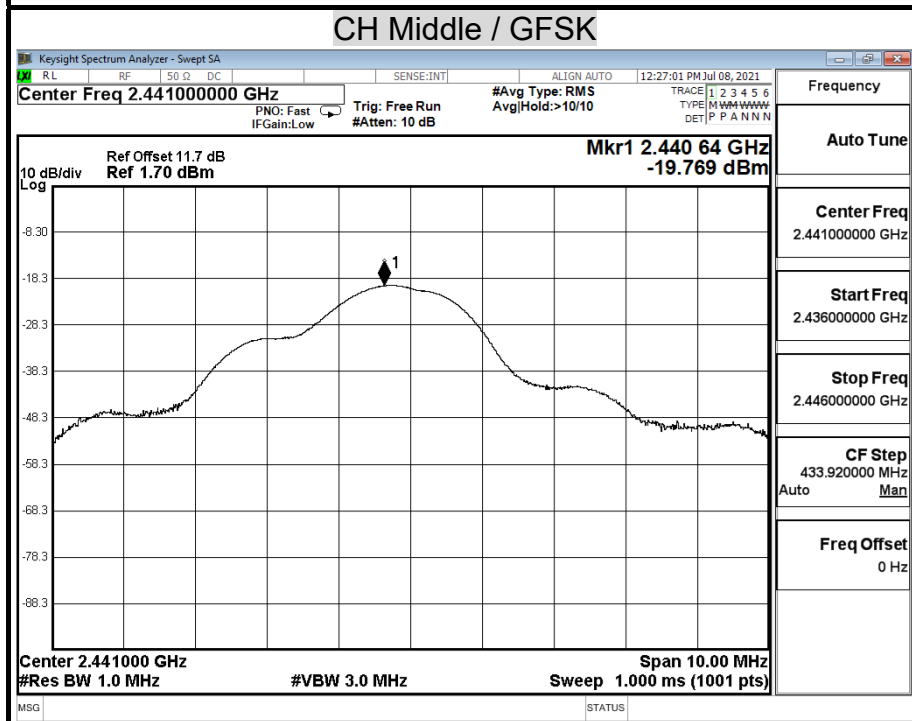
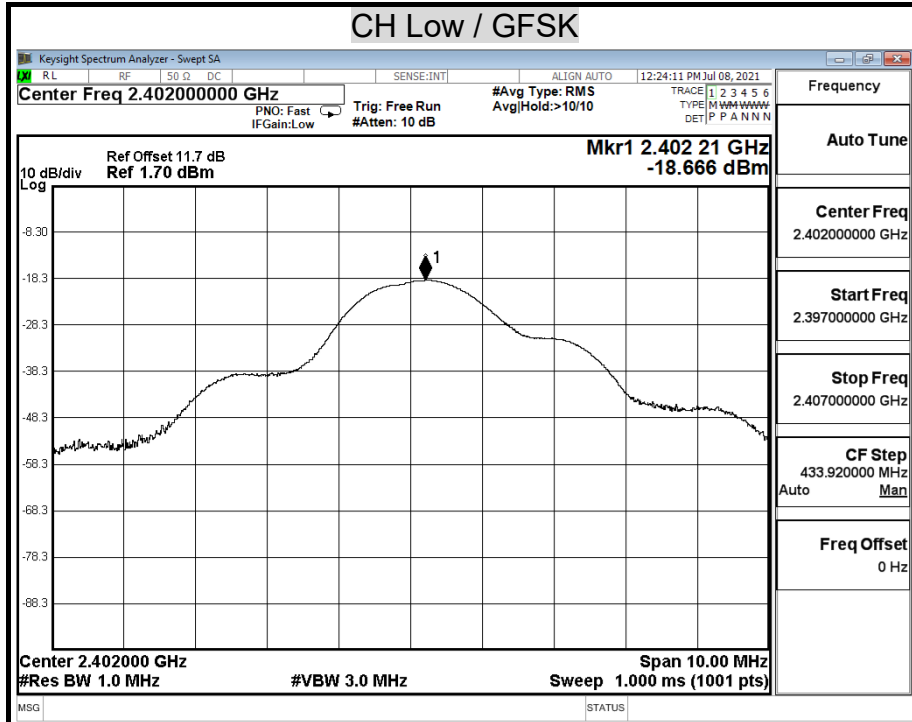

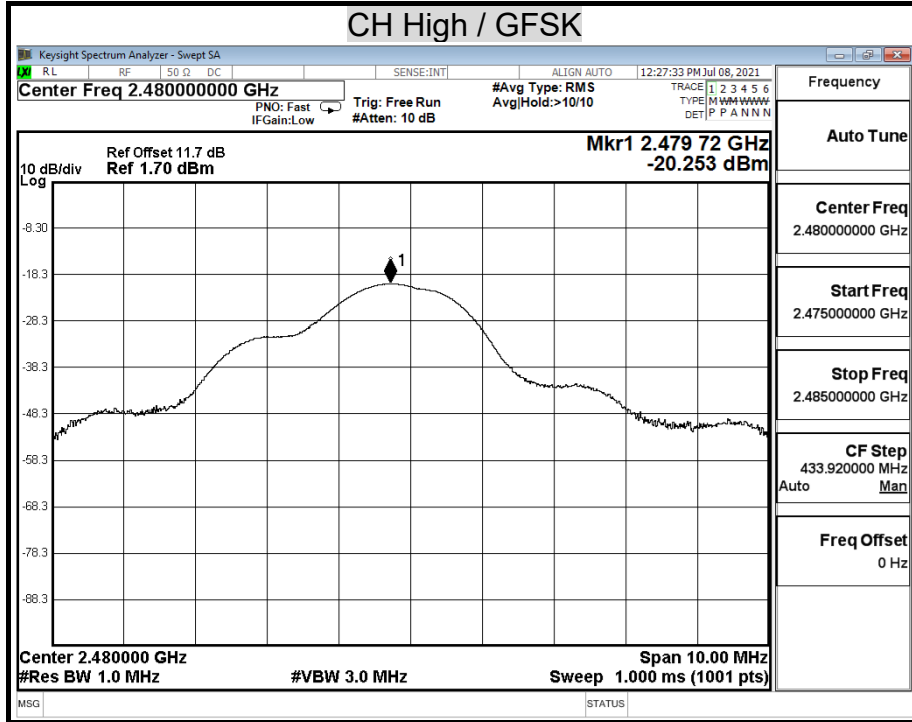

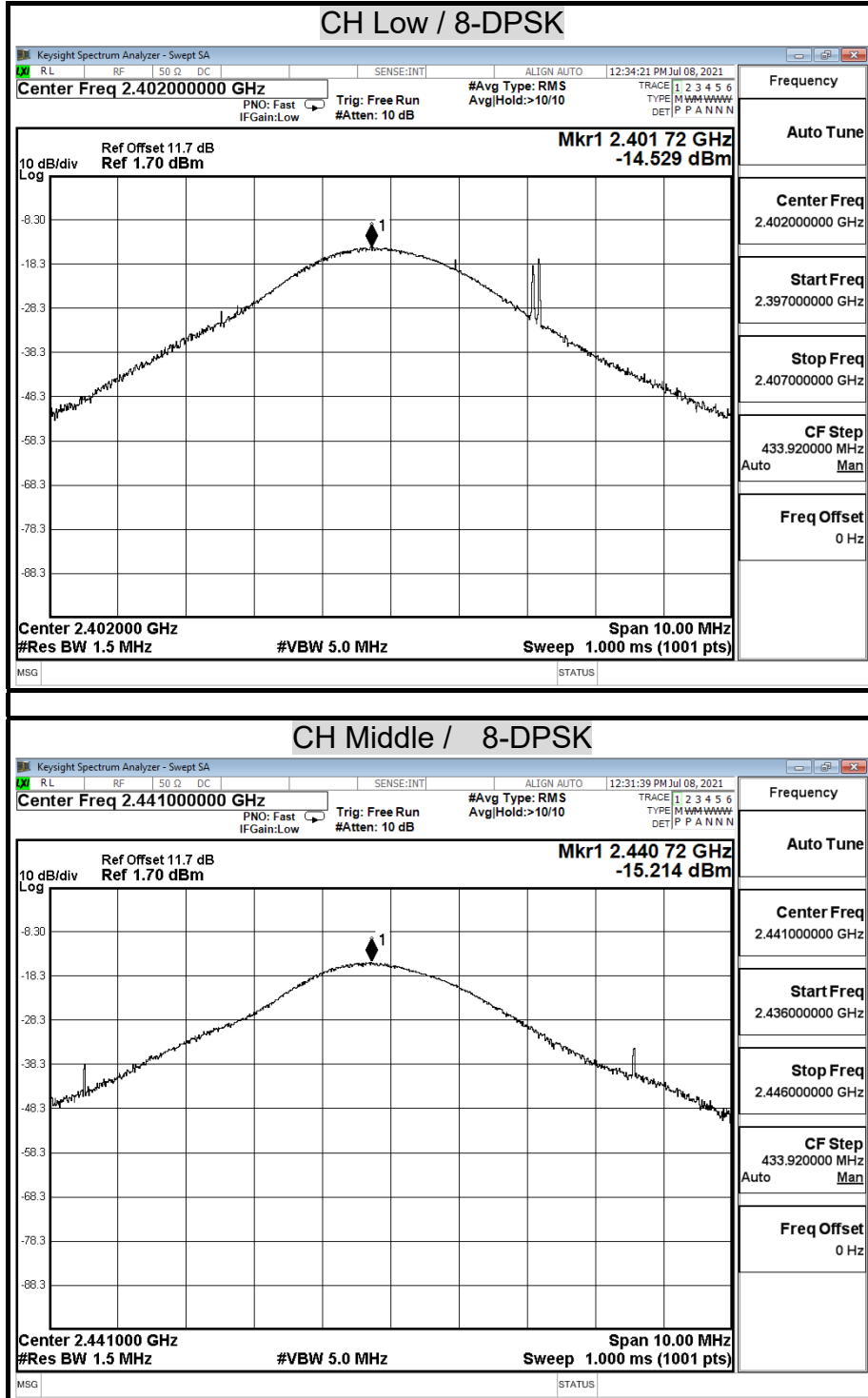

Report No.: T210622N01-RP1-1

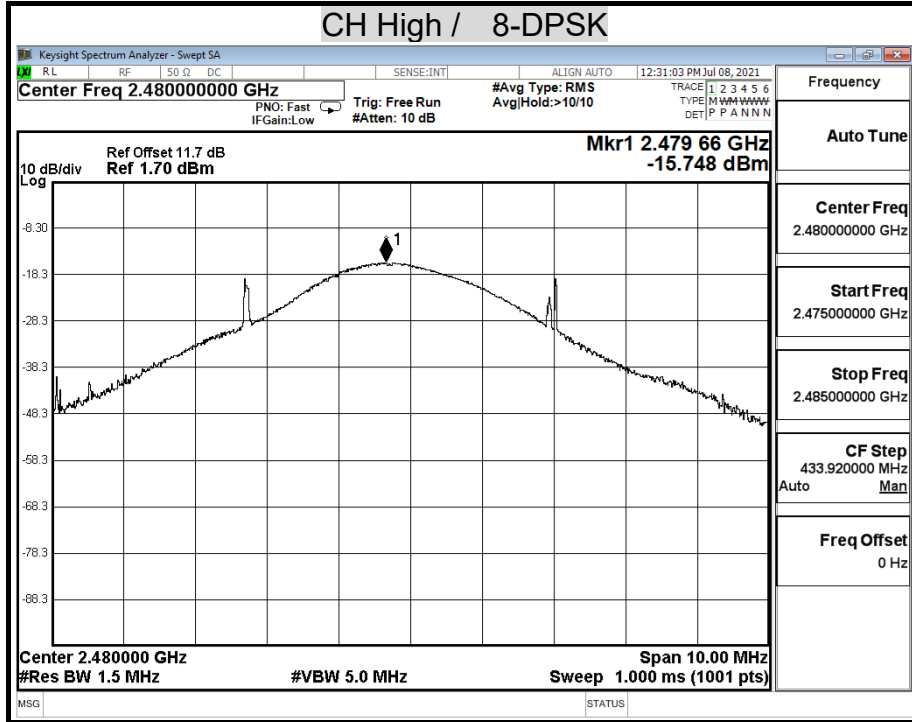

AVERAGE POWER

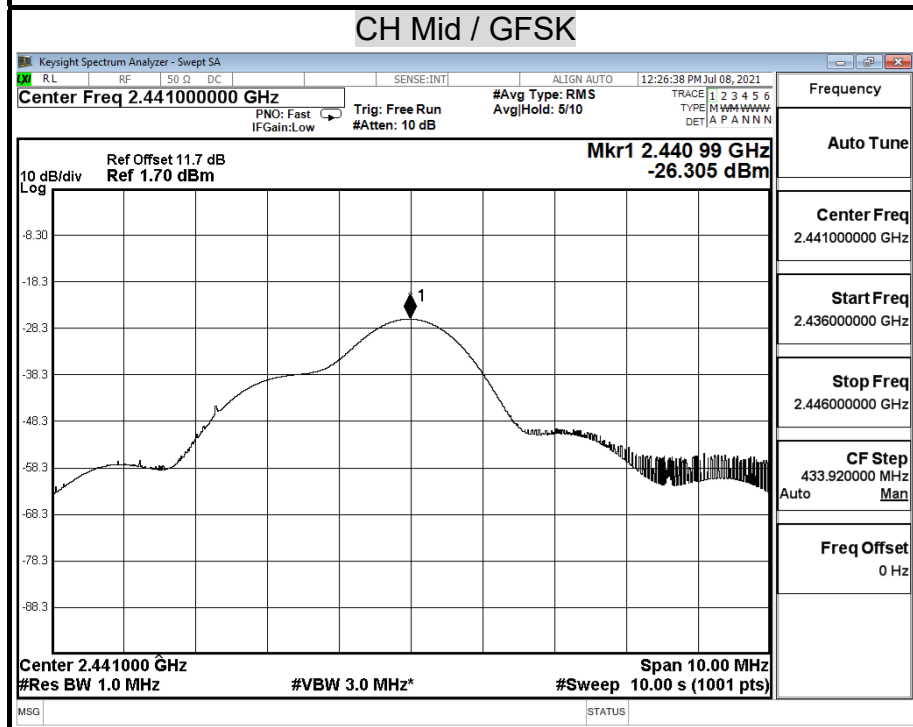
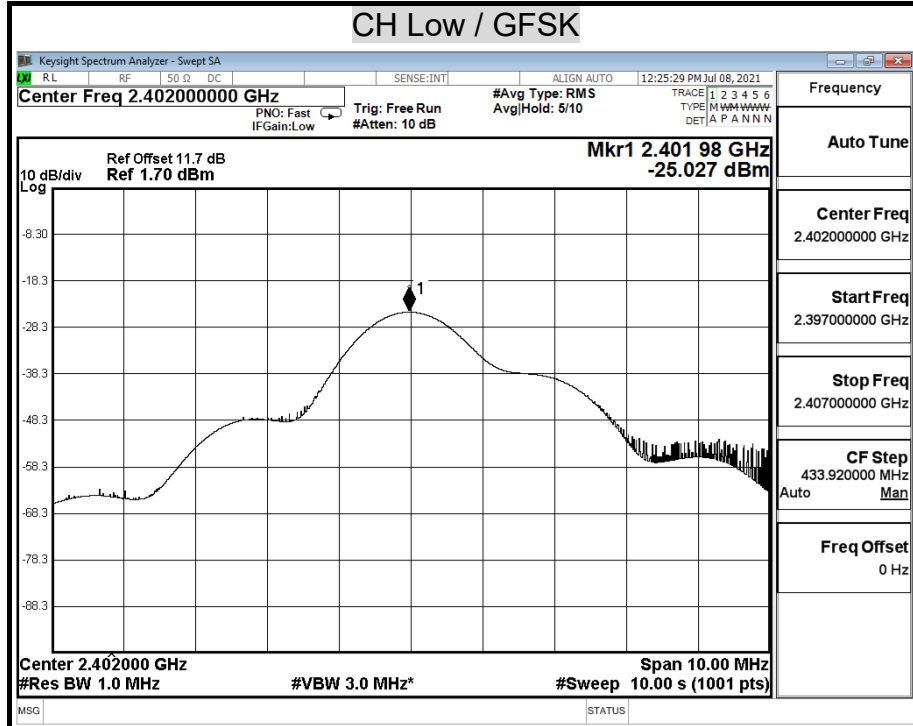

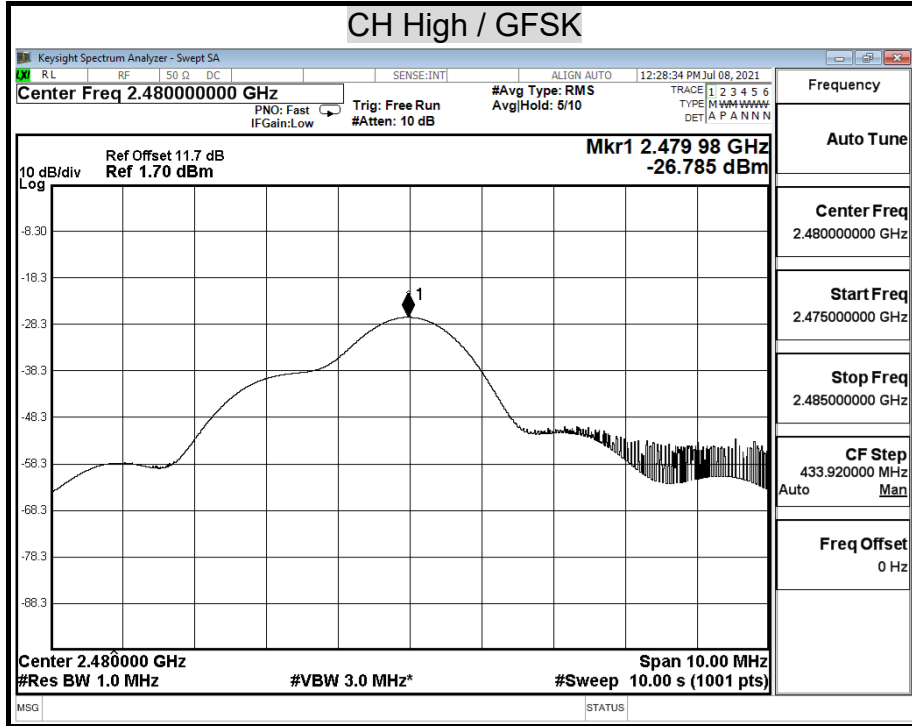

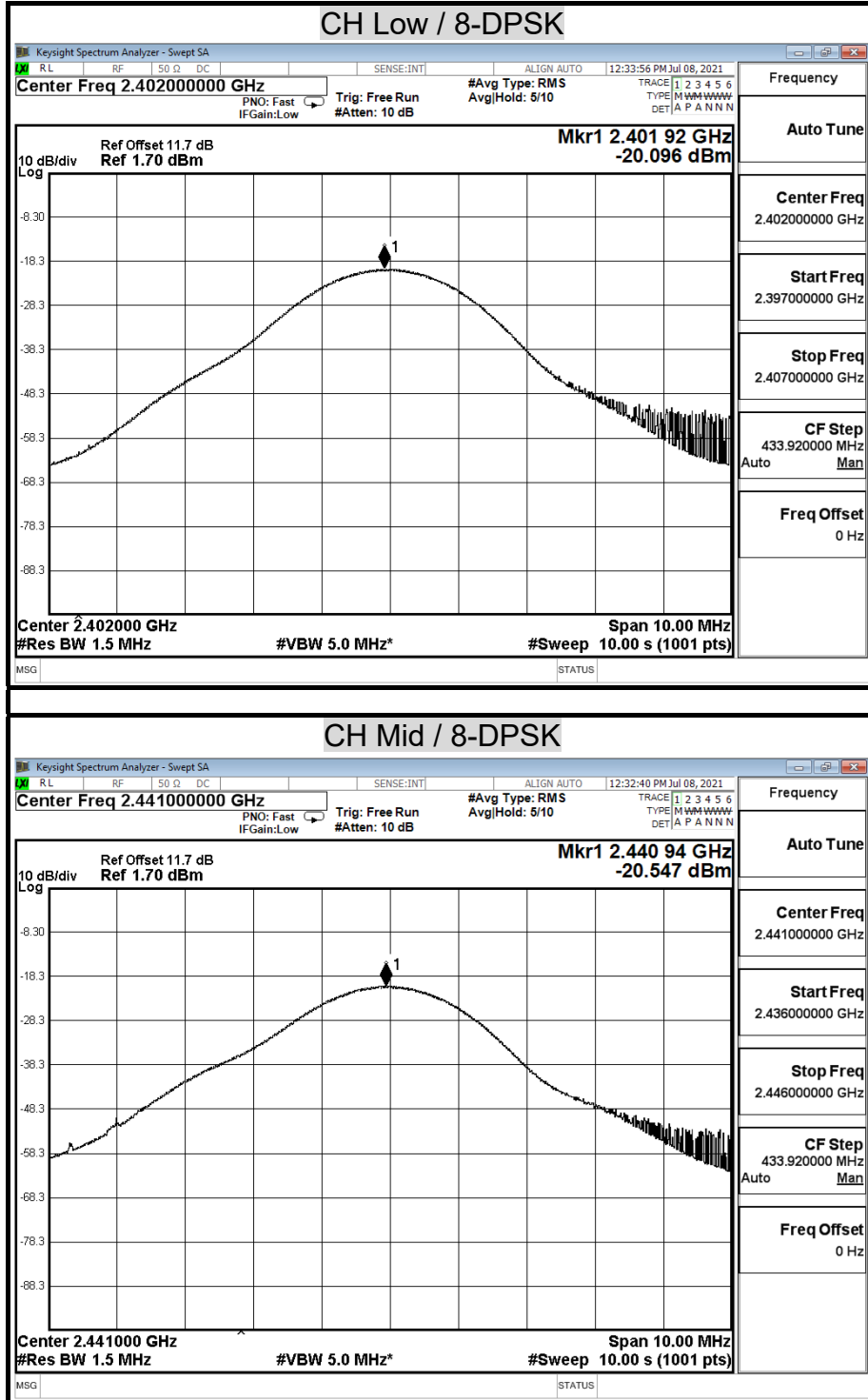

Report No.: T210622N01-RP1-1

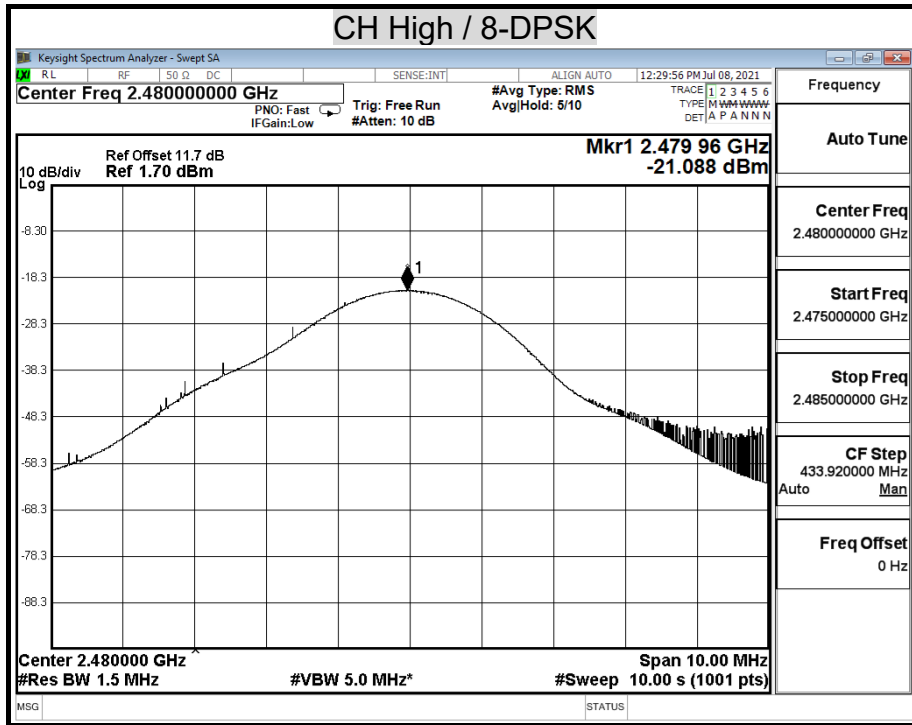

8.3 HOPPING CHANNEL SEPARATION

LIMIT

§15.247(a)(1) Frequency hopping systems shall have hopping channel carrier frequencies separated by a minimum of 25 kHz or the 20 dB bandwidth of the hopping channel, whichever is greater. Alternatively, frequency hopping systems operating in the 2400-2483.5 MHz band may have hopping channel carrier frequencies that are separated by 25 kHz or two-thirds of the 20 dB bandwidth of the hopping channel, whichever is greater, provided the systems operate with an output power no greater than 125 mW. The system shall hop to channel frequencies that are selected at the system hopping rate from a pseudo randomly ordered list of hopping frequencies. Each frequency must be used equally on the average by each transmitter. The system receivers shall have input bandwidths that match the hopping channel bandwidths of their corresponding transmitters and shall shift frequencies in synchronization with the transmitted signals.

TEST SETUP

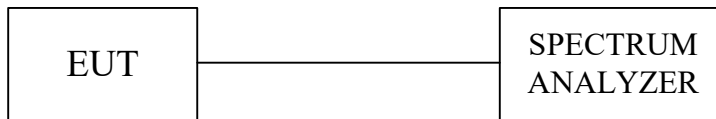

TEST PROCEDURE

1. Check the calibration of the measuring instrument using either an internal calibrator or a known signal from an external generator.
2. Position the EUT as shown in test setup without connection to measurement instrument. Turn on the EUT and connect it to measurement instrument. Then set it to any one convenient frequency within its operating range.
3. By using the MaxHold function record the separation of adjacent channels.
4. Measure the frequency difference of these two adjacent channels by spectrum analyzer MARK function. And then plot the result on spectrum analyzer screen.
5. Repeat above procedures until all frequencies measured were complete.

Report No.: T210622N01-RP1-1

TEST RESULTS

Refer to section 8.1, 20dB bandwidth measurement, the measured channel separation should be greater than two-third of 20dB bandwidth or Minimum bandwidth.

Model Name	AT-LP3XBT	Test By	Ted Huang
Temp & Humidity	26.8°C, 56%	Test Date	2021/07/08

Modulation Type: GFSK / DH5

Channel	Adjacent Hopping Channel Separation (MHz)	Two -third of 20dB bandwidth (MHz)	Minimum Bandwidth (kHz)	Result
2402MHz	1.00	0.56	25 KHz	PASS
2441MHz	1.00	0.56	25 KHz	PASS
2480MHz	1.00	0.55	25 KHz	PASS

Modulation Type: 8-DPSK / 3-DH5

Channel	Adjacent Hopping Channel Separation (kHz)	Two -third of 20dB bandwidth (kHz)	Minimum Bandwidth (kHz)	Result
2402MHz	1.00	0.84	25 KHz	PASS
2441MHz	1.00	0.85	25 KHz	PASS
2480MHz	1.00	0.84	25 KHz	PASS

Report No.: T210622N01-RP1-1

HOPPING CHANNEL SEPARATION

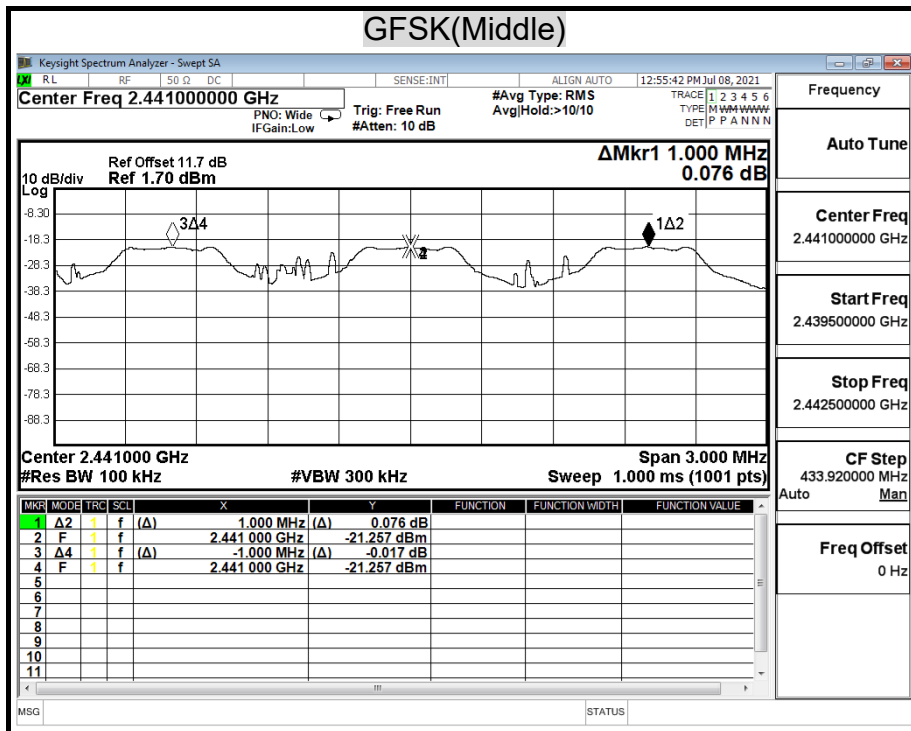
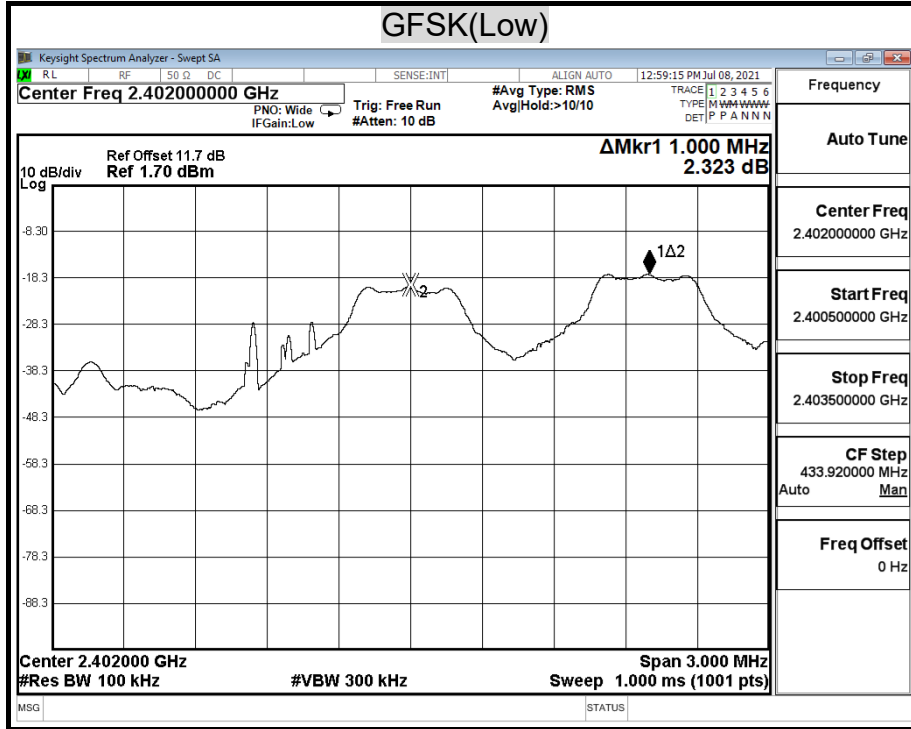

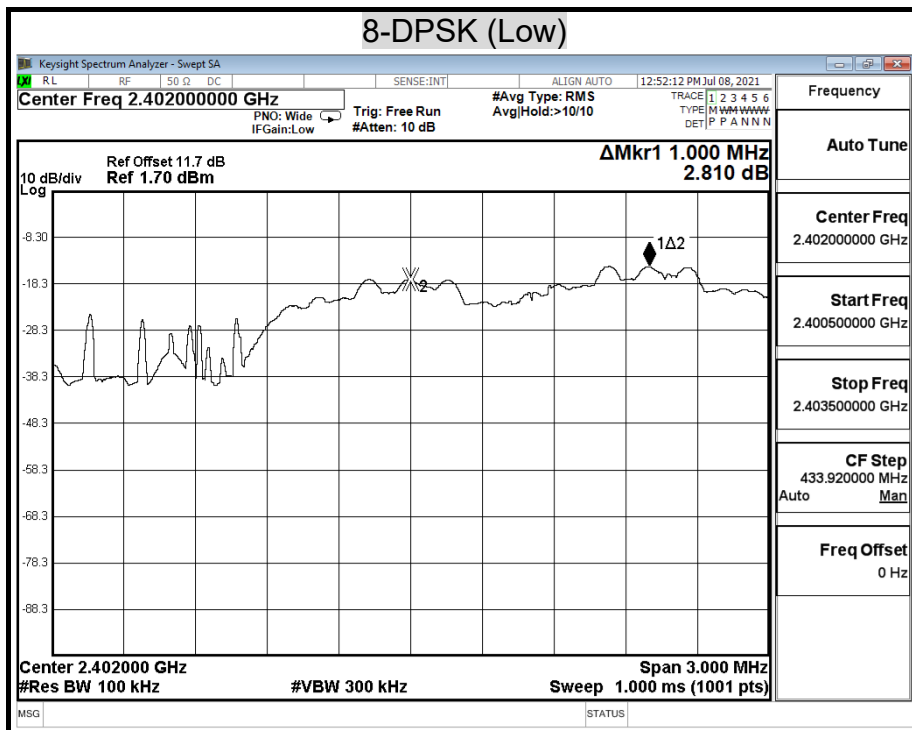
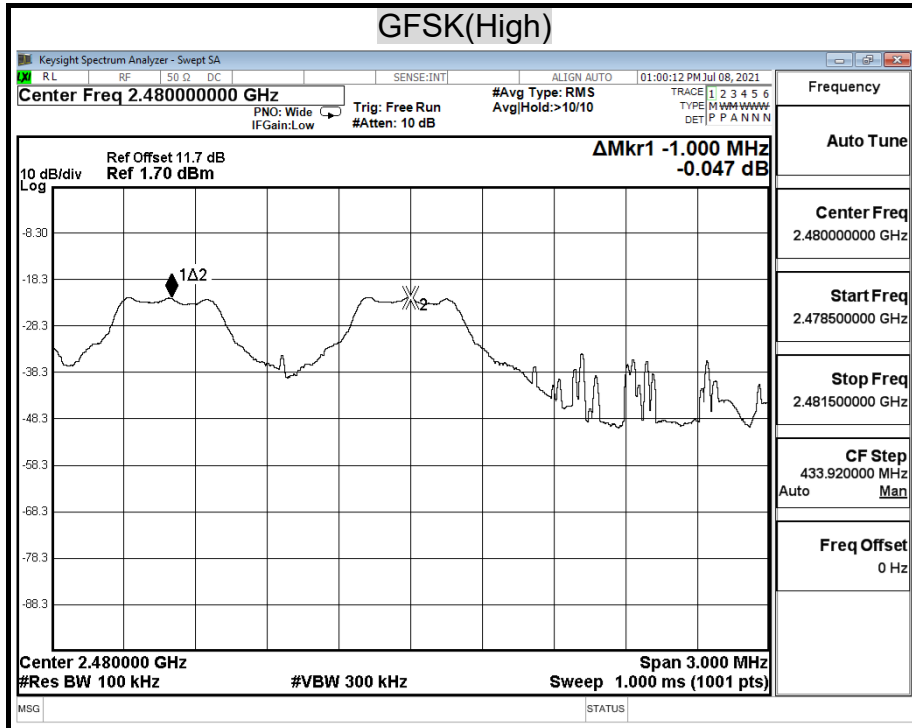

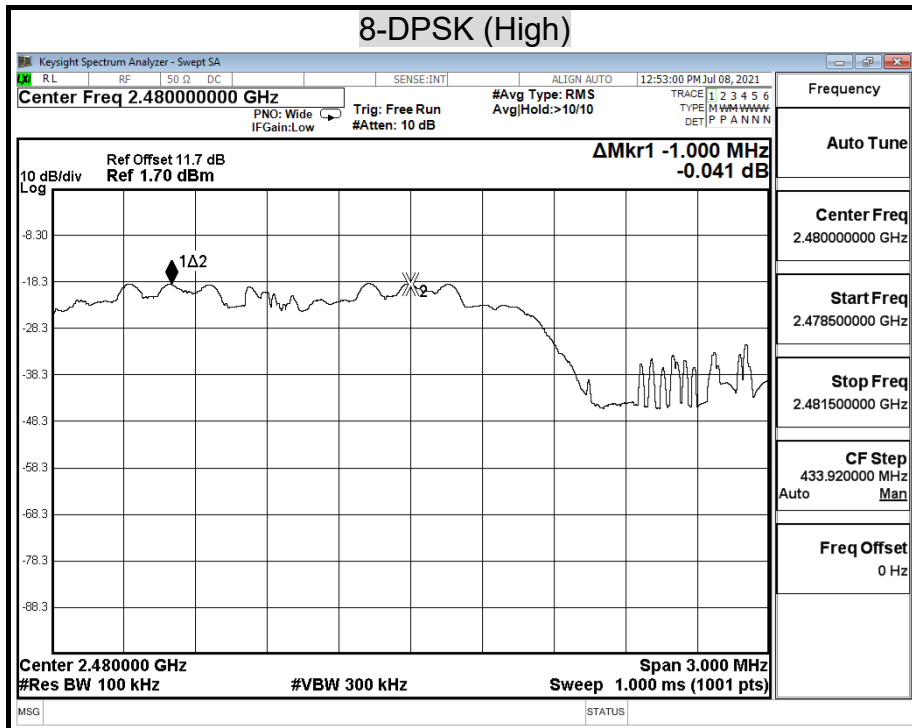
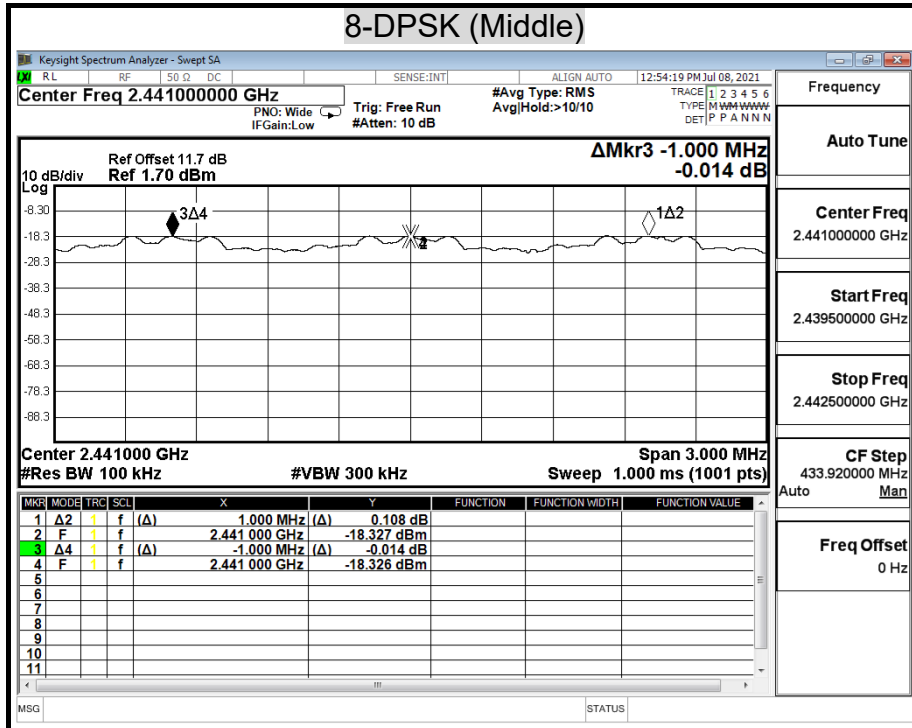

8.4 NUMBER OF HOPPING FREQUENCY USED

LIMIT

§15.247(a)(1)(iii) For frequency hopping systems in the 2400-2483.5 MHz band shall use at least 15 channels.

TEST SETUP

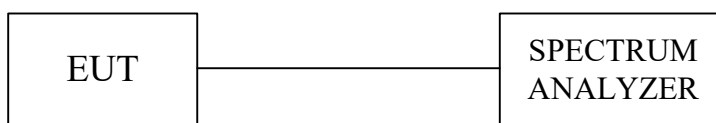

TEST PROCEDURE

- 1 Check the calibration of the measuring instrument (spectrum analyzer) using either an internal calibrator or a known signal from an external generator.
- 2 Position the EUT as shown in test setup without connection to measurement instrument. Turn on the EUT and connect its antenna terminal to measurement instrument via a low loss cable. Then set it to any one measured frequency within its operating range and make sure the instrument is operated in its linear range.
- 3 Set the spectrum analyzer on MaxHold Mode, and then keep the EUT in hopping mode. Record all the signals from each channel until each one has been recorded.
- 4 Set the spectrum analyzer on View mode and then plot the result on spectrum analyzer screen.
- 5 Repeat above procedures until all frequencies measured were complete.

TEST RESULTS

Model Name	AT-LP3XBT	Test By	Ted Huang
Temp & Humidity	26.8°C, 56%	Test Date	2021/07/08

Modulation Type: GFSK / DH5

Result(No.of CH)	Limit(No.of CH)	Result
79	>15	PASS

Modulation Type: 8-DPSK / 3-DH5

Result(No.of CH)	Limit(No.of CH)	Result
79	>15	PASS

Report No.: T210622N01-RP1-1

NUMBER OF HOPPING FREQUENCY USED

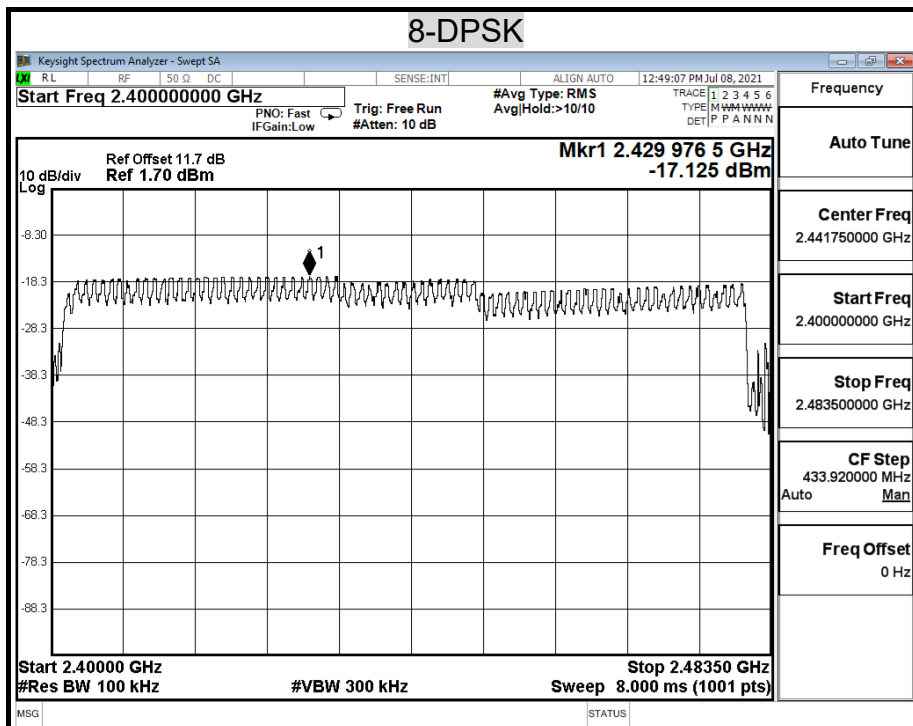
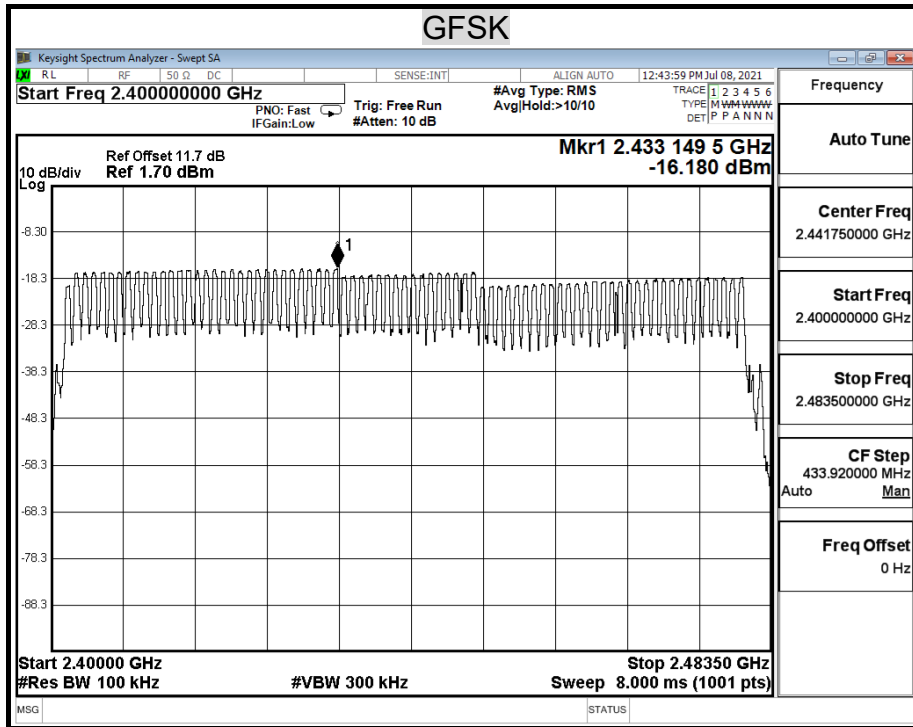

8.5 DWELL TIME ON EACH CHANNEL

LIMIT

§15.247(a)(1)(iii) For frequency hopping system operating in the 2400-2483.5MHz band, the average time of occupancy on any frequency shall not be greater than 0.4 second within a 31.6 second period.

TEST SETUP

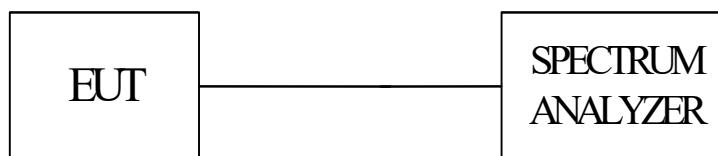

TEST PROCEDURE

1. Check the calibration of the measuring instrument using either an internal calibrator or a known signal from an external generator.
2. Position the EUT as shown in test setup without connection to measurement instrument. Turn on the EUT and connect its antenna terminal to measurement instrument via a low loss cable. Then set it to any one measured frequency within its operating range and make sure the instrument is operated in its linear range.
3. Adjust the center frequency of spectrum analyzer on any frequency be measured and set spectrum analyzer to zero span mode. And then, set RBW and VBW of spectrum analyzer to proper value.
4. Measure the time duration of one transmission on the measured frequency. And then plot the result with time difference of this time duration.
5. Repeat above procedures until all frequencies measured were complete.
6. The Bluetooth Headset has 3 type of payload, DH1, DH3, DH5. The hopping rate is 1600 per second. The longer the payload is, the slower the hopping rate is.

Report No.: T210622N01-RP1-1

TEST RESULTS

Time of occupancy on the TX channel in 31.6sec = time domain slot length × hop rate ÷ number of hop per channel × 31.6

Refer to the attached graph.

The hopping rates of Bluetooth devices change with different types of payload. The longer the payload is, the slower the hopping rate. The hopping rate scenario is defined in Bluetooth core specification.

Model Name	AT-LP3XBT	Test By	Ted Huang
Temp & Humidity	26.8°C, 56%	Test Date	2021/07/08

Modulation Type: GFSK / DH5

Transmitting Frequency	Packet type	Dwell time (ms)	Time of occupancy on the TX channel in 31.6sec (ms)	Limit for Time of occupancy on the TX channel in 31.6sec (ms)	Results
2441MHz	DH1	0.400	128.00	400.00	PASS
2441MHz	DH3	1.650	264.00	400.00	PASS
2441MHz	DH5	2.900	309.33	400.00	PASS
2441MHz	AFH	2.900	154.67	400.00	PASS

DH1 Dwell time= 0.400 ms×(1600÷2)÷79×31.6= 128.00 (ms)
 DH3 Dwell time= 1.650 ms×(1600÷4)÷79×31.6= 264.00 (ms)
 DH5 Dwell time= 2.900 ms×(1600÷6)÷79×31.6= 309.33 (ms)
 AFH Dwell time= 2.900 ms×(800÷6)÷20×8= 154.67 (ms)

Modulation Type: 8-DPSK / 3-DH5

Transmitting Frequency	Packet type	Dwell time (ms)	Time of occupancy on the TX channel in 31.6sec (ms)	Limit for Time of occupancy on the TX channel in 31.6sec (ms)	Results
2441MHz	3DH1	0.410	131.20	400.00	PASS
2441MHz	3DH3	1.670	267.20	400.00	PASS
2441MHz	3DH5	2.920	311.47	400.00	PASS
2441MHz	AFH	2.920	155.73	400.00	PASS

3DH1 Dwell time= 0.410 ms×(1600÷2)÷79×31.6= 131.20 (ms)
 3DH3 Dwell time= 1.670 ms×(1600÷4)÷79×31.6= 267.20 (ms)
 3DH5 Dwell time= 2.920 ms×(1600÷6)÷79×31.6= 311.47 (ms)
 AFH Dwell time= 2.920 ms×(800÷6)÷20×8= 155.73 (ms)

DWELL TIME ON EACH PAYLOAD

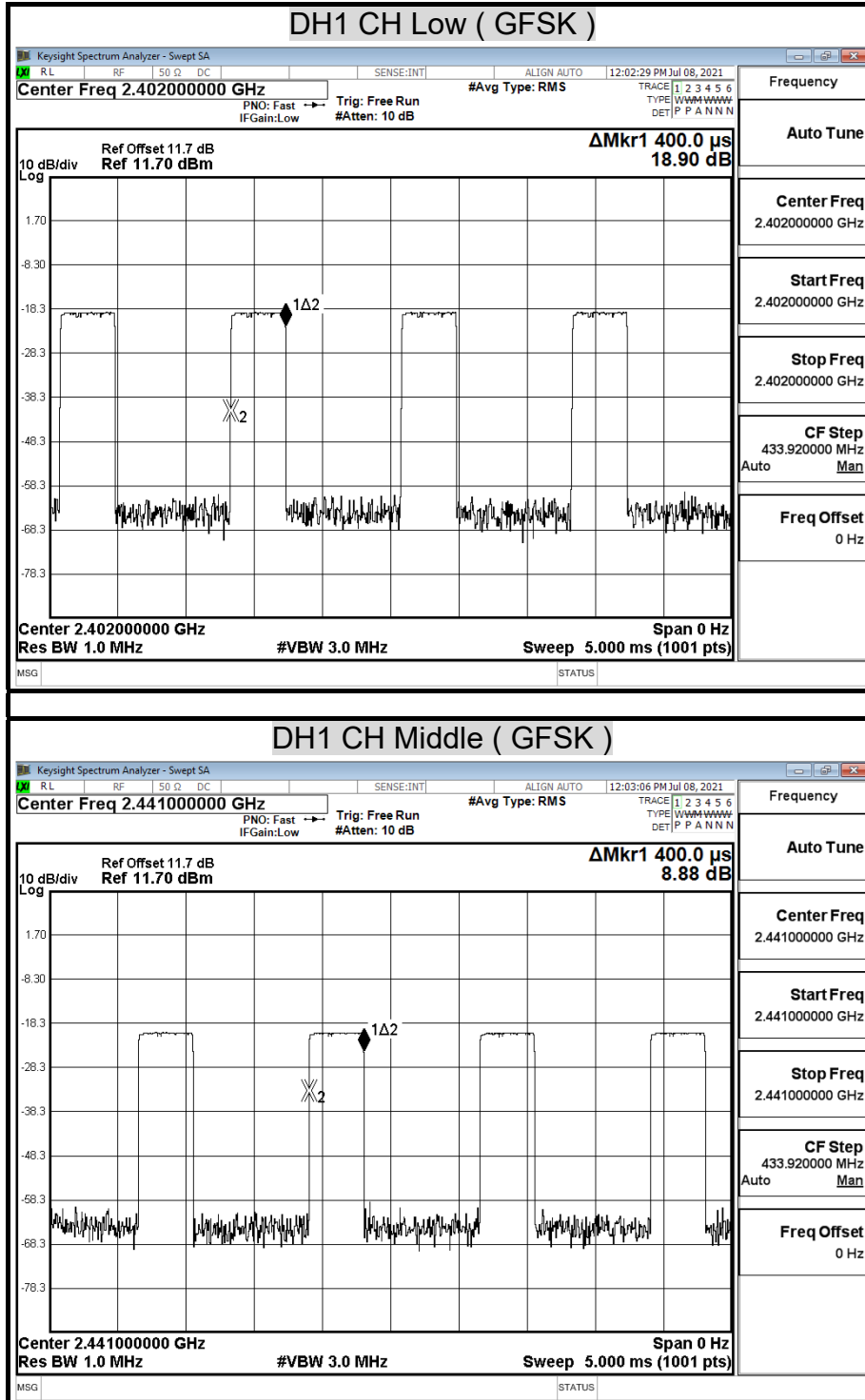

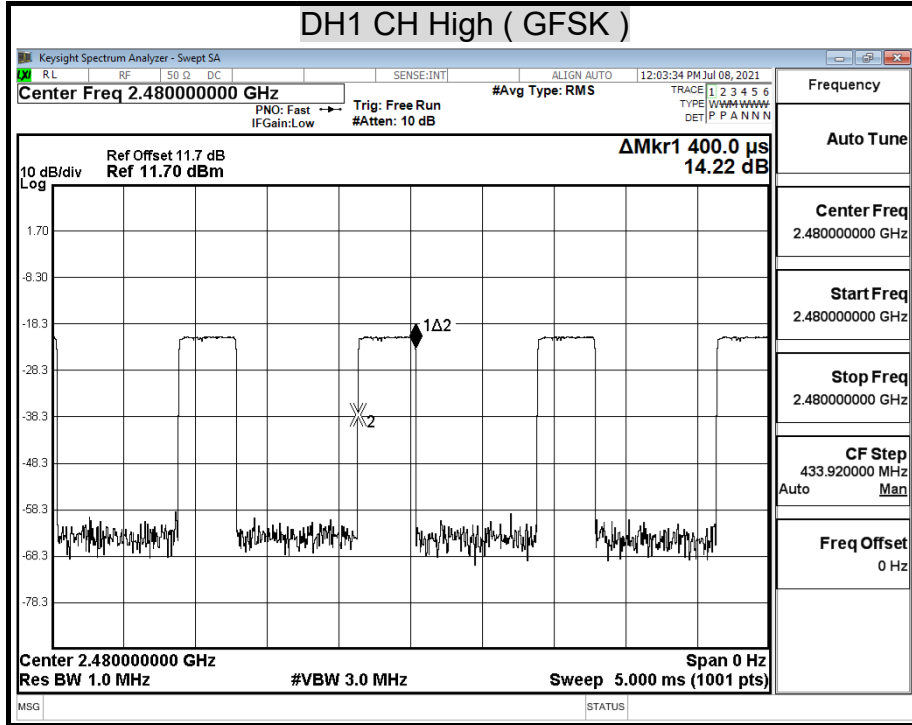

Report No.: T210622N01-RP1-1

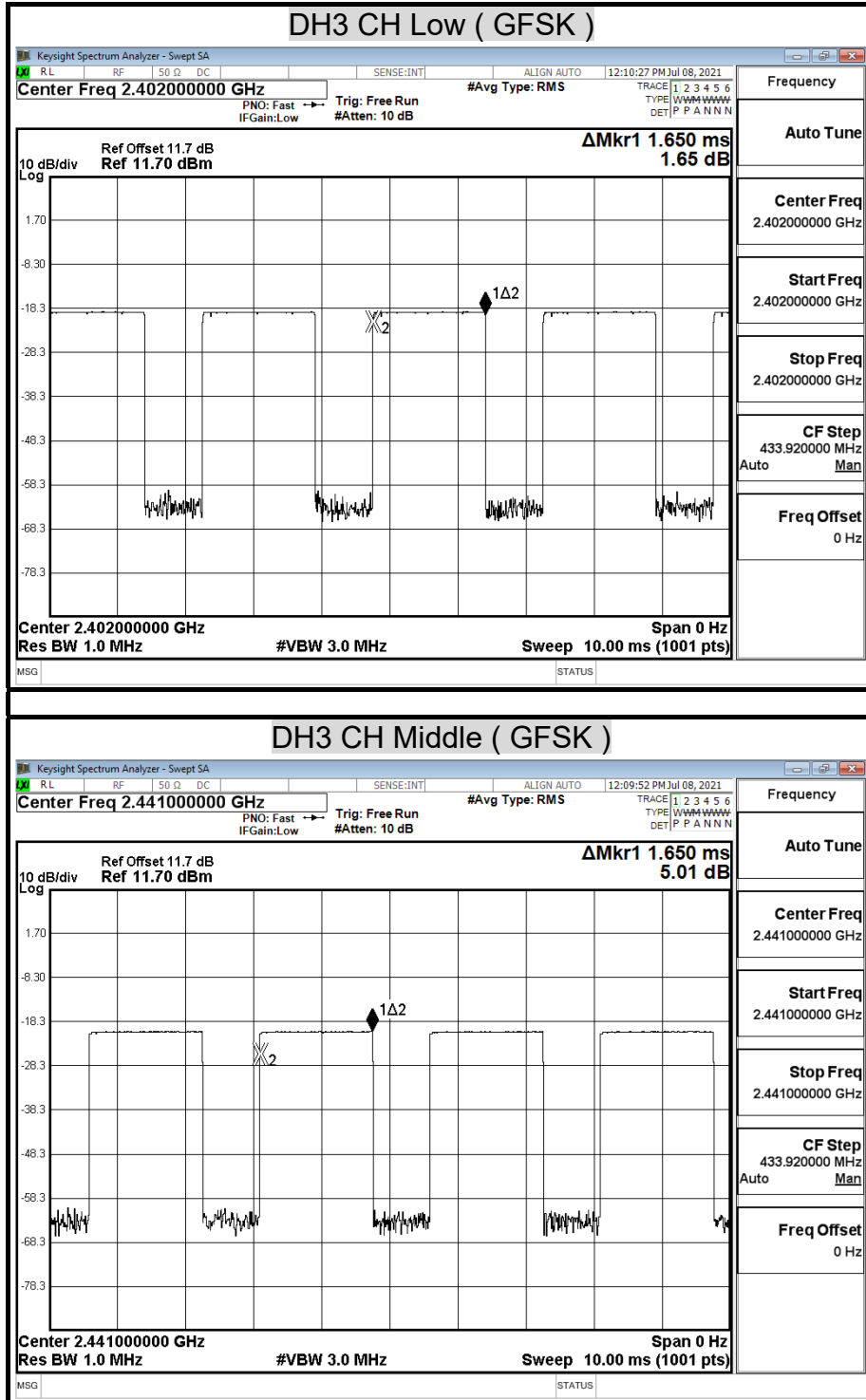

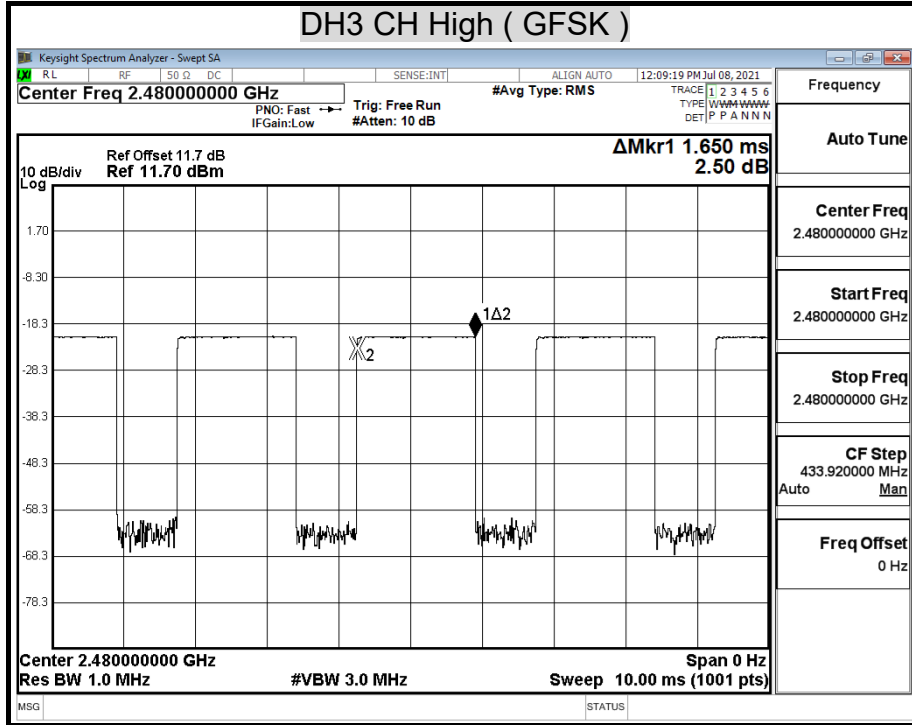

Report No.: T210622N01-RP1-1

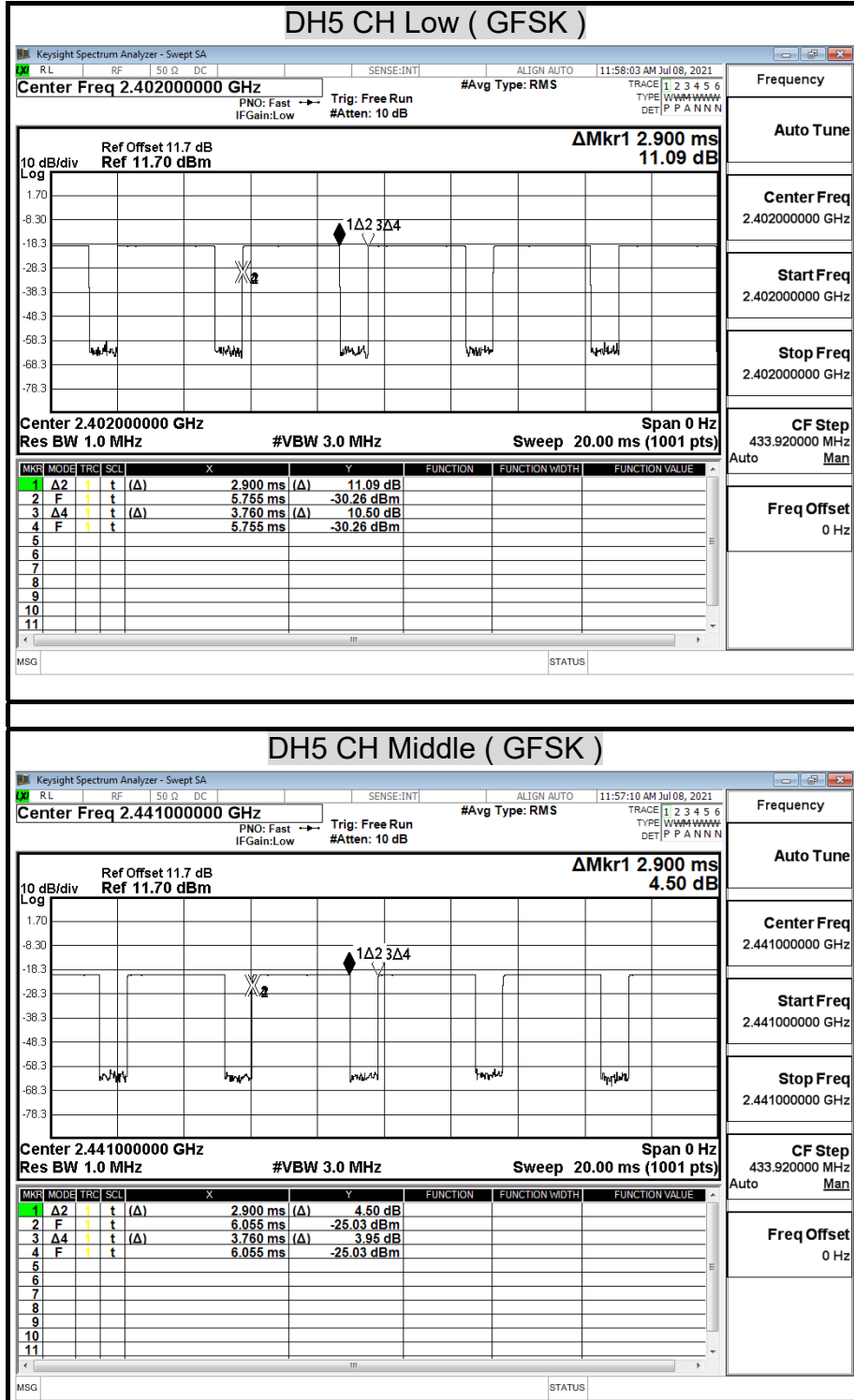

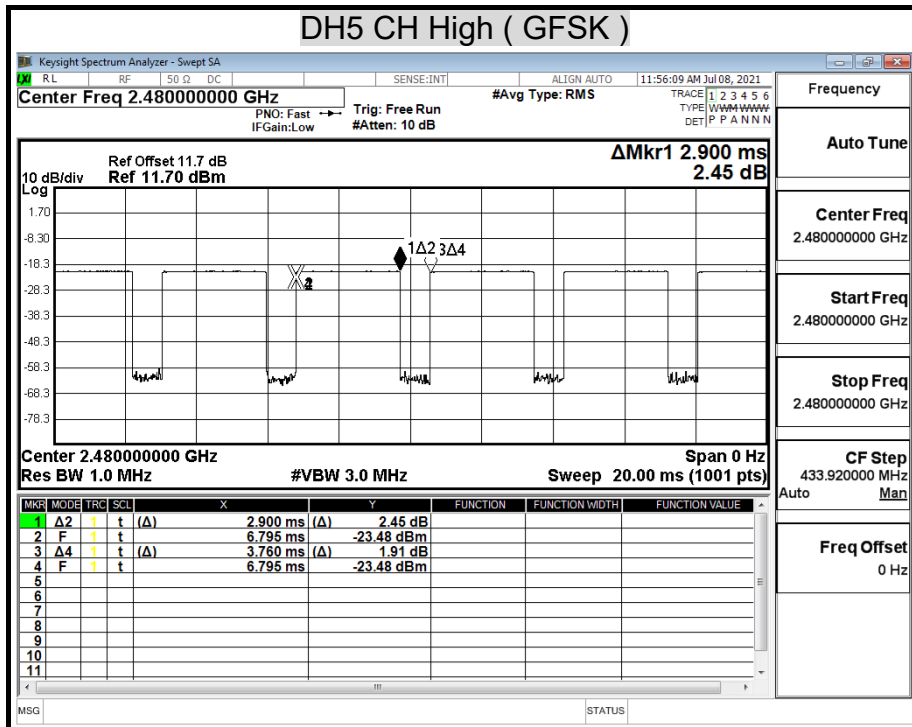

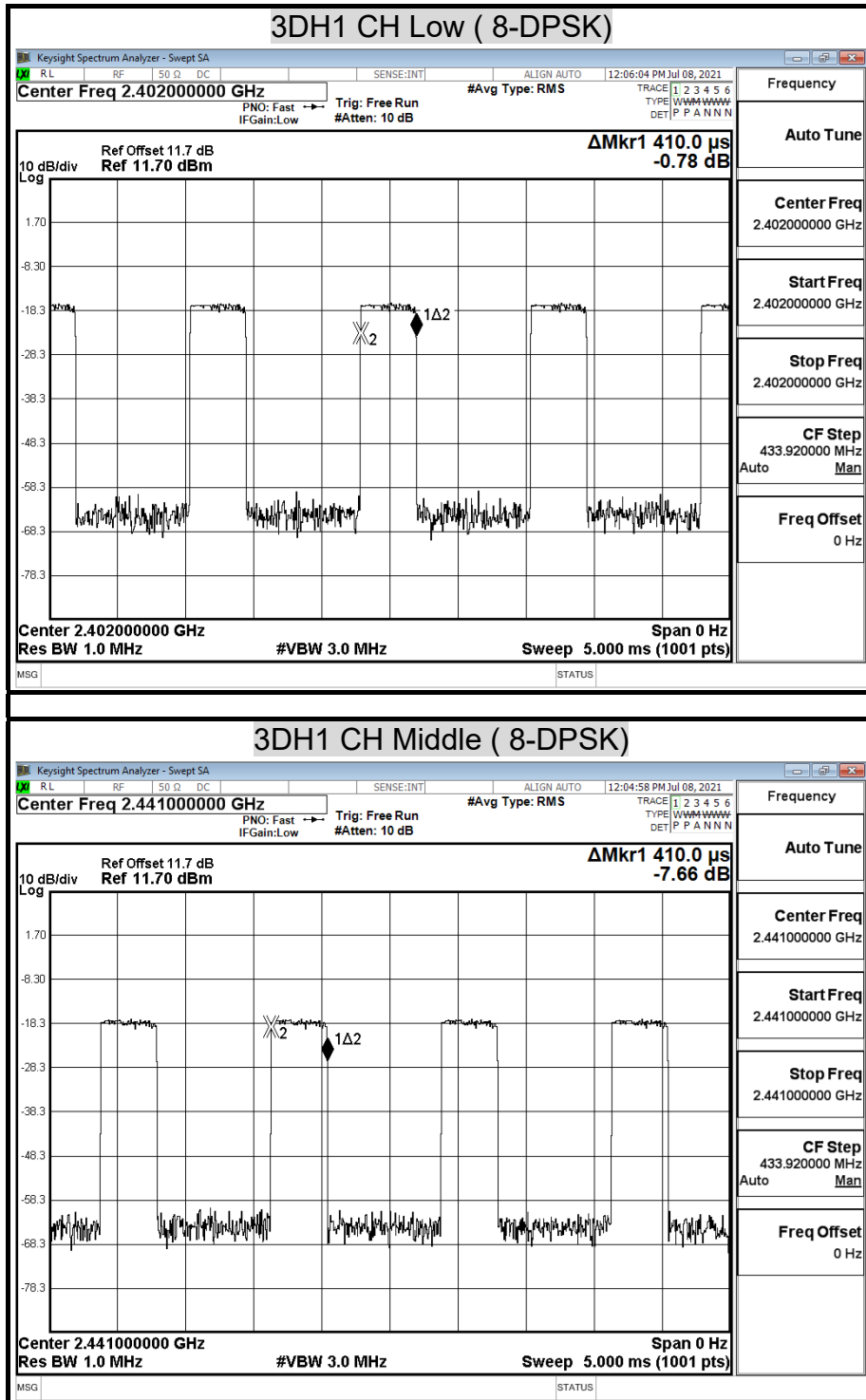

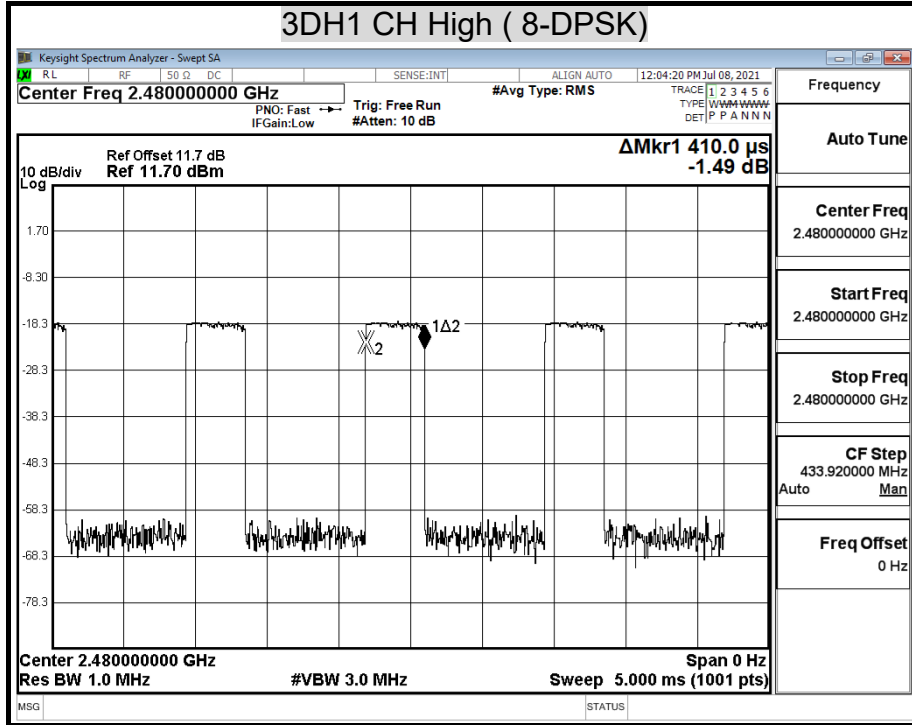

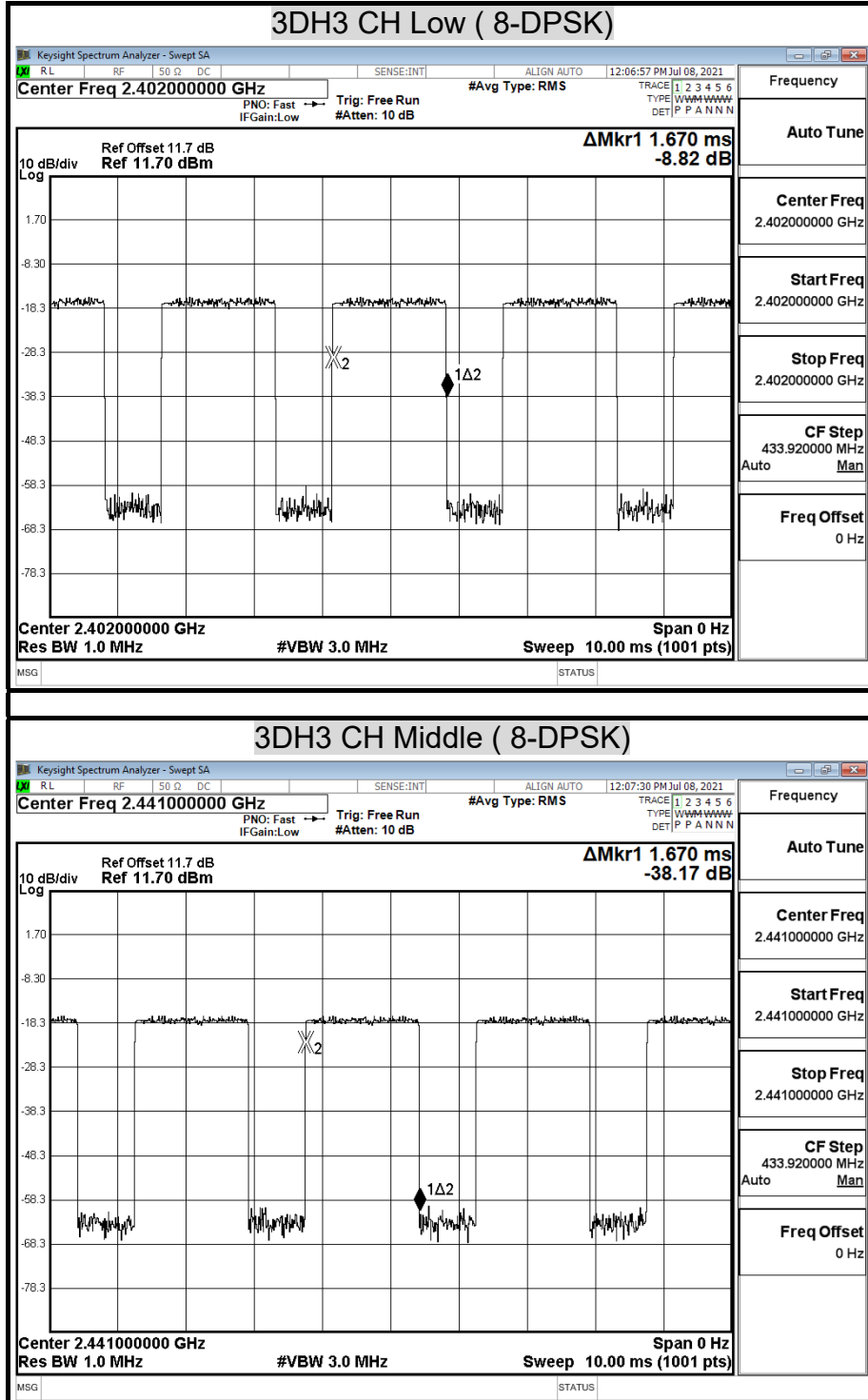

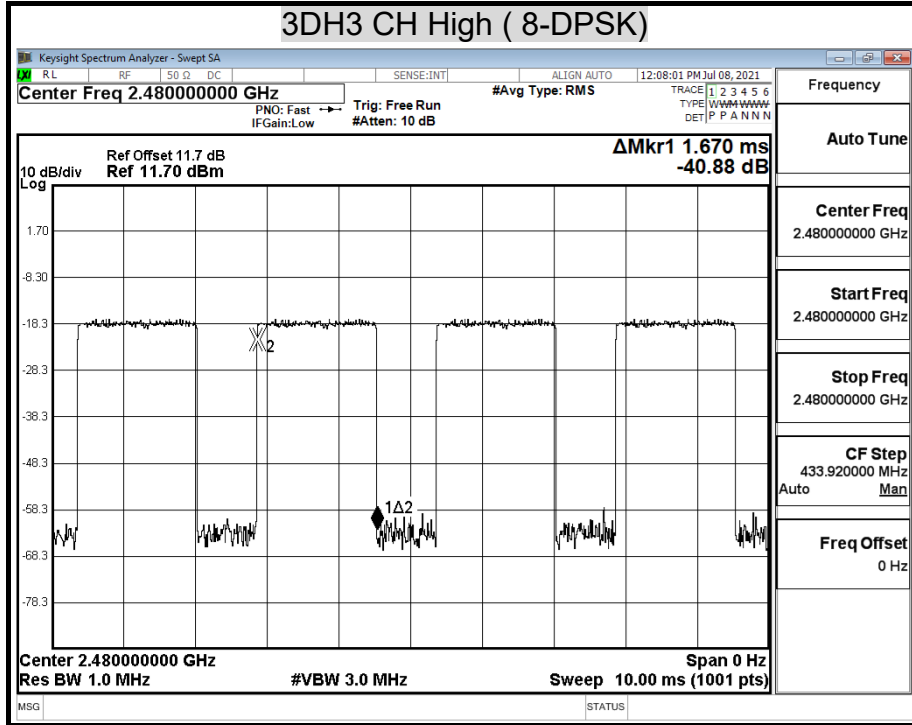

Report No.: T210622N01-RP1-1

