

FCC 47 CFR PART 15 SUBPART C AND ANSI C63.10: 2013 TEST REPORT

For

DIRECT DRIVE Turntable

Model: AT-LP120XBT-USB

Data Applies To: N/A

Brand Name: audio-technica

Issued for

**Audio-Technica Corporation
2-46-1 Nishi-naruse, Machida, Tokyo 194-8666, JAPAN**

Issued By

**Compliance Certification Services Inc.
Tainan Laboratory
No.8,Jiucengling, Xinhua Dist., Tainan City
712, Taiwan (R.O.C.)
TEL: 886-6-580-2201
FAX: 886-6-580-2202**

Issued Date: August 23, 2019

Note: *This report shall not be reproduced except in full, without the written approval of Compliance Certification Services Inc. This document may be altered or revised by Compliance Certification Services Inc. personnel only, and shall be noted in the revision section of the document. The client should not use it to claim product endorsement by TAF or any government agencies. The test results in the report only apply to the tested sample.*

Unless otherwise stated the results shown in this test report refer only to the sample(s) tested and such sample(s) are retained for 90 days only.
除非另有說明，此報告結果僅對測試之樣品負責，同時此樣品僅保留90天。本報告未經本公司書面許可，不可部分複製。

This document is issued by the Company subject to its General Conditions of Service printed overleaf, available on request or accessible at www.sgs.com/terms_and_conditions.htm and for electronic format documents, subject to Terms and Conditions for Electronic Documents at www.sgs.com/terms_e-document.htm. Attention is drawn to the limitation of liability, indemnification and jurisdiction issues defined therein. Any holder of this document is advised that information contained hereon reflects the Company's findings at the time of its intervention only and within the limits of Client's instructions, if any. The Company's sole responsibility is to its Client and this document does not exonerate parties to a transaction from exercising all their rights and obligations under the transaction documents. This document cannot be reproduced except in full, without prior written approval of the Company. Any unauthorized alteration, forgery or falsification of the content or appearance of this document is unlawful and offenders may be prosecuted to the fullest extent of the law.

REVISION HISTORY

| Rev. | Issue Date | Revisions | Effect Page | Revised By |
|------|-----------------|-------------------------------|-------------|------------|
| 00 | August 08, 2019 | Initial Issue | ALL | Gina Lin |
| 01 | August 23, 2019 | See the following note rev.01 | ALL | Gina Lin |
| | | | | |
| | | | | |

Note:

Rev.00 Issue Date: August 08, 2019
Original Report
Rev.01 Issue Date: August 23, 2019
Revise typo & add lab registration.

TABLE OF CONTENTS

| TITLE | PAGE NO. |
|---|------------|
| 1. TEST REPORT CERTIFICATION | 4 |
| 2. TEST RESULT SUMMARY..... | 5 |
| 3. EUT DESCRIPTION | 6 |
| 3.1 DESCRIPTION OF EUT & POWER..... | 6 |
| 4. DESCRIPTION OF TEST MODES | 8 |
| 5. TEST METHODOLOGY | 10 |
| 6. FACILITIES AND ACCREDITATIONS..... | 11 |
| 6.1 FACILITIES | 11 |
| 6.2 EQUIPMENT | 11 |
| 6.3 LABORATORY ACCREDITATIONS LISTINGS..... | 11 |
| 6.4 TABLE OF ACCREDITATIONS AND LISTINGS | 12 |
| 6.5 MEASUREMENT EQUIPMENT USED | 13 |
| 6.6 MEASURING INSTRUMENT CALIBRATION | 14 |
| 6.7 MEASUREMENT UNCERTAINTY | 14 |
| 7. SETUP OF EQUIPMENT UNDER TEST..... | 15 |
| 7.1 SETUP CONFIGURATION OF EUT | 15 |
| 7.2 SUPPORT EQUIPMENT..... | 17 |
| 8. APPLICABLE LIMITS AND TEST RESULTS..... | 20 |
| 8.1 20DB BANDWIDTH FOR HOPPING..... | 20 |
| 8.2 MAXIMUM PEAK OUTPUT POWER | 26 |
| 8.3 HOPPING CHANNEL SEPARATION..... | 37 |
| 8.4 NUMBER OF HOPPING FREQUENCY USED | 42 |
| 8.5 DWELL TIME ON EACH CHANNEL | 45 |
| 8.6 DUTY CYCLE..... | 59 |
| 8.7 CONDUCTED SPURIOUS EMISSION | 64 |
| 8.8 RADIATED EMISSIONS | 73 |
| 8.8.1 TRANSMITTER RADIATED SUPURIOUS EMSSIONS | 73 |
| 8.8.2 WORST-CASE RADIATED EMISSION BELOW 1 GHZ..... | 77 |
| 8.8.3 TRANSMITTER RADIATED EMISSION ABOVE 1 GHZ | 80 |
| 8.8.4 RESTRICTED BAND EDGES | 86 |
| 8.9 POWERLINE CONDUCTED EMISSIONS | 94 |
| APPENDIX I PHOTOGRPHS OF TEST SETUP | 100 |

Report No.: T190605N02-RP1-1

1. TEST REPORT CERTIFICATION

| | | |
|-----------------------------|---|--|
| Applicant | : | Audio-Technica Corporation 2-46-1 Nishi-naruse, Machida, Tokyo 194-8666, JAPAN |
| Manufacturer | : | Audio-Technica Corporation 2-46-1 Nishi-naruse, Machida, Tokyo 194-8666, JAPAN |
| Equipment Under Test | : | DIRECT DRIVE Turntable |
| Model Number | : | AT-LP120XBT-USB |
| Data Applies To | : | N/A |
| Brand Name | : | audio-technica |
| Date of Test | : | June 14, 2019, June 19, 2019 July 03, 2019 |

| APPLICABLE STANDARD | |
|--|-------------|
| STANDARD | TEST RESULT |
| FCC Part 15 Subpart C AND ANSI C63.10: 2013 | PASS |

| Statements of Conformity |
|--|
| Determining compliance shall be based on the results of the compliance measurement, not taking into account measurement instrumentation uncertainty. |

We hereby certify that:

The above equipment was tested by Compliance Certification Services Inc. The test data, data evaluation, test procedures, and equipment configurations shown in this report were made in accordance with the procedures given in **ANSI C63.10: 2013** and the energy emitted by the sample EUT tested as described in this report is in compliance with the requirements of FCC Rules Part 15.207, 15.209, 15.247.

The test results of this report relate only to the tested sample EUT identified in this report.

Approved by:



Jeter Wu
Assistant Manager

Reviewed by:

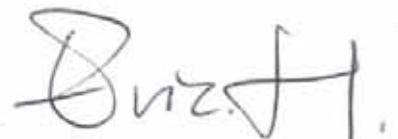

Eric Huang
Section Manager

2. TEST RESULT SUMMARY

| FCC Standard Section | Report Section | Test Item | Result |
|----------------------|----------------|----------------------------------|--------|
| 15.203 | 3 | ANTENNA REQUIREMENT | Pass |
| 15.247(a)(1) | 8.1 | 20dB BANDWIDTH | Pass |
| 15.247(b)(1) | 8.2 | MAXIMUM PEAK OUTPUT POWER | Pass |
| 15.247(a)(1) | 8.3 | HOPPING CHANNEL SEPARATION | Pass |
| 15.247(a)(1)(iii) | 8.4 | NUMBER OF HOPPING FREQUENCY USED | Pass |
| 15.247(a)(1)(iii) | 8.5 | DWELL TIME | Pass |
| - | 8.6 | DUTY CYCLE | - |
| 15.247(d) | 8.7 | CONDUCTED SPURIOUS EMISSION | Pass |
| 15.247(d) | 8.8 | RADIATED EMISSIONS | Pass |
| 15.207(a) | 8.9 | POWERLINE CONDUCTED EMISSIONS | Pass |

3. EUT DESCRIPTION

3.1 DESCRIPTION OF EUT & POWER

| | |
|----------------------------|---|
| Product | DIRECT DRIVE Turntable |
| Model Number | AT-LP120XBT-USB |
| Data Applies To | N/A |
| Brand Name | audio-technica |
| Identify Number | Engineering sample |
| Received Date | June 05, 2019 |
| Reported Date | July 16, 2019 |
| Frequency Range | 2402 ~ 2480 MHz |
| Transmit Peak Power | GFSK : -10.129dBm / 0.097073346mW 8DPSK: -6.058dBm / 0.247856322mW |
| Channel Spacing | 1MHz |
| Transmit Data Rate | GFSK Mode : 1 Mbps 4/ DQPSK Mode : 2Mbps 8DPSK Mode : 3Mbps |
| Modulation Type | Frequency Hopping Spread Spectrum |
| Number of Channels | 79 Channels |
| EUT Power Supply | DC 12V (Powered by Adapter) |
| Antenna Type | Manufacturer: Advanced Ceramic X Type: Multilayer Chip Antenna Model: AT3216-A2R4PAAT/LF Gain: 1.5 dBi |
| Firmware Version | V1.0 |
| Software Version | V1.0 |

Power Adapter :

| No. | Manufacturer | Model No. | Power Input | Power Output |
|-----|----------------|---------------|---------------------------|---------------|
| 1 | audio-technica | FJ-SW1202000N | 100-240Vac, 50/60Hz, 0.6A | 12Vdc, 2000mA |

Remark:

1. The sample selected for test was production product and was provided by manufacturer.
2. This submittal(s) (test report) is intended for **FCC ID: JFZLP120XBT** filing to comply with Section 15.207, 15.209 and 15.247 of the FCC Part 15, Subpart C Rules.
3. For more details, please refer to the User's manual of the EUT.

4. DESCRIPTION OF TEST MODES

The EUT had been tested under operating condition.

There are three channels have been tested as following :

| Channel | Frequency (MHz) |
|---------|-----------------|
| Low | 2402 |
| Middle | 2441 |
| High | 2480 |

Radiated Emission Test (Below 1 GHz):

- Pre-Scan has been conducted to determine the worst-case mode from all possible combinations between available modulations, data rates and antenna ports (if EUT with antenna diversity architecture).
- Following channel(s) was (were) selected for the final test as listed below.

Normal Operation

Radiated Emission Test (Above 1 GHz):

- Pre-Scan has been conducted to determine the worst-case mode from all possible combinations between available modulations, data rates and antenna ports (if EUT with antenna diversity architecture).
- Following channel(s) was (were) selected for the final test as listed below.

| Tested Channel | Modulation Technology | Modulation Type | Packet Type |
|----------------|-----------------------|-----------------|-------------|
| Low, Mid, High | FHSS | GFSK | DH5 |
| Low, Mid, High | FHSS | 8-DPSK | 3-DH5 |

Report No.: T190605N02-RP1-1

Bandedge Measurement :

- Pre-Scan has been conducted to determine the worst-case mode from all possible combinations between available modulations, data rates and antenna ports (if EUT with antenna diversity architecture).
- Following channel(s) was (were) selected for the final test as listed below.

| Tested Channel | Modulation Technology | Modulation Type | Packet Type |
|----------------|-----------------------|-----------------|-------------|
| Low, High | FHSS | GFSK | DH5 |
| Low, High | FHSS | 8-DPSK | 3-DH5 |

Antenna Port Conducted Measurement :

- Pre-Scan has been conducted to determine the worst-case mode from all possible combinations between available modulations, data rates and antenna ports (if EUT with antenna diversity architecture).
- Following channel(s) was (were) selected for the final test as listed below.

| Tested Channel | Modulation Technology | Modulation Type | Packet Type |
|----------------|-----------------------|-----------------|-------------|
| Low, Mid, High | FHSS | GFSK | DH5 |
| Low, Mid, High | FHSS | 8-DPSK | 3-DH5 |



Report No.: T190605N02-RP1-1

Page: 10 / 105
Rev.: 01

5. TEST METHODOLOGY

The tests documented in this report were performed in accordance with ANSI C63.10 : 2013 and FCC CFR 47 15.207, 15.209 and 15.247.

6. FACILITIES AND ACCREDITATIONS

6.1 FACILITIES

All measurement facilities used to collect the measurement data are located at

No.8, Jiucengling, Xinhua Dist., Tainan City 712, Taiwan (R.O.C.)

The sites are constructed in conformance with the requirements of ANSI C63.7, ANSI C63.10 and CISPR Publication 22.

6.2 EQUIPMENT

Radiated emissions are measured with one or more of the following types of linearly polarized antennas: tuned dipole, bi-conical, log periodic, bi-log, and/or ridged waveguide, horn. Spectrum analyzers with pre-selectors and quasi-peak detectors are used to perform radiated measurements.

Conducted emissions are measured with Line Impedance Stabilization Networks and EMI Test Receivers.

Calibrated wideband preamplifiers, coaxial cables, and coaxial attenuators are also used for making measurements.

All receiving equipment conforms to CISPR Publication 16-1, "Radio Interference Measuring Apparatus and Measurement Methods."

6.3 LABORATORY ACCREDITATIONS LISTINGS

The test facilities used to perform radiated and conducted emissions tests are accredited by Taiwan Accreditation Foundation for the specific scope of accreditation under Lab Code: 1109 to perform Electromagnetic Interference tests according to FCC PART 15 AND CISPR 22 requirements. No part of this report may be used to claim or imply product endorsement by TAF or any agency of the Government. In addition, the test facilities are listed with Federal Communications Commission (registration no: TW1109).

6.4 TABLE OF ACCREDITATIONS AND LISTINGS

Our laboratories are accredited and approved by the following approval agencies according to ISO/IEC 17025.

| | |
|---------------|-----|
| Taiwan | TAF |
|---------------|-----|

The measuring facility of laboratories has been authorized or registered by the following approval agencies.

| | |
|----------------|--------------------------------|
| Canada | Industry Canada (ISED#: 2324H) |
| Germany | TUV NORD |
| Taiwan | BSMI |
| USA | FCC |
| Japan | VCCI |

Copies of granted accreditation certificates are available for downloading from our web site, <http://www.ccsrf.com>

6.5 MEASUREMENT EQUIPMENT USED

For §8.8.2~8.8.3

| Chamber 966 Room (Radiation Test) | | | | | |
|-----------------------------------|----------------|------------------------|---------------|------------------|-----------------|
| Name of Equipment | Manufacturer | Model | Serial Number | Calibration Date | Calibration Due |
| Active Loop Antenna | ETS-LINDREN | 6502 | 8905-2356 | 07/20/2017 | 07/19/2019 |
| Amplifier | HP | 8447F | 2443A01671 | 01/25/2019 | 01/24/2020 |
| Bi-Log Antenna | Sunol | JB1 | A070506-2 | 02/09/2019 | 02/08/2020 |
| Cable | Rosnol+Suhner | SUCOFLEX 104PEA | SN25737 /4PEA | 05/28/2019 | 05/27/2020 |
| Double Ridged Guide Horn Antenna | ETS-LINDGREN | 3116 | 00078900 | 03/29/2019 | 03/28/2021 |
| EMI Test Receiver | R&S | ESCI | 100960 | 11/07/2018 | 11/06/2019 |
| EXA Spectrum Analyzer | KEYSIGHT | N9010A | MY54430216 | 07/05/2019 | 07/04/2020 |
| Horn Antenna | Com-Power | AH-118 | 071032 | 04/30/2019 | 04/29/2020 |
| Pre-Amplifier | EMCI | EMC012645 | 980098 | 01/25/2019 | 01/24/2020 |
| Pre-Amplifier | MITEQ | AMF-6F-1800400 0-37-8P | 985646 | 06/18/2019 | 06/17/2020 |
| Hi-Pass Filter | MICRO-TRONIC S | BRM50702-01 | 018 | N.C.R | N.C.R |

For §8.1~8.7 8.8.4

| Chamber 966 Room (Conducted Test) | | | | | |
|-----------------------------------|--------------|--------------|---------------|------------------|-----------------|
| Name of Equipment | Manufacturer | Model | Serial Number | Calibration Date | Calibration Due |
| EXA Spectrum Analyzer | KEYSIGHT | N9010A | MY54430216 | 07/05/2019 | 07/04/2020 |
| SMA Cable + 10dB Attenuator | CCS | SMA+10dB ATT | SMA/10dB | 01/25/2019 | 01/24/2020 |

For §8.9

| Conducted Emission room #1 | | | | | |
|----------------------------|--------------|------------------|---------------|------------------|-----------------|
| Name of Equipment | Manufacturer | Model | Serial Number | Calibration Date | Calibration Due |
| BNC Coaxial Cable | CCS | BNC50 | 11 | 02/25/2019 | 02/24/2020 |
| EMI Test Receiver | R&S | ESCS 30 | 100348 | 02/19/2019 | 02/18/2020 |
| LISN | SCHWARZBECK | NNLK8130 | 8130124 | 01/02/2019 | 01/01/2020 |
| LISN | FCC | FCC-LISN-50-32-2 | 08009 | 06/12/2019 | 06/11/2020 |
| Pulse Limiter | R&S | ESH3-Z2 | 100116 | 02/25/2019 | 02/24/2020 |
| Test S/W | e3(6.101222) | | | | |

Report No.: T190605N02-RP1-1

6.6 MEASURING INSTRUMENT CALIBRATION

The measuring equipment utilized to perform the tests documented in this report has been calibrated in accordance with the manufacturer's recommendations, and is traceable to recognized national standards.

6.7 MEASUREMENT UNCERTAINTY

Where relevant, the following measurement uncertainty levels have been estimated for tests performed on the apparatus:

| PARAMETER | UNCERTAINTY |
|--|-------------|
| Radiated Emission, 150kHz to 30 MHz Test Site : Chamber 966 | ±5.2dB |
| Radiated Emission, 30 to 200 MHz Test Site : Chamber 966 | ±3.1dB |
| Radiated Emission, 200 to 1000 MHz Test Site : Chamber 966 | ±2.62dB |
| Radiated Emission, 1 to 18 GHz | ± 3.58dB |
| Radiated Emission, 18 to 26 GHz | ± 3.59dB |
| Radiated Emission, 26 to 40 GHz | ± 3.81dB |
| Power Line Conducted Emission | ±1.56dB |
| Bandwidth | 136.49kHz |
| Peak Output Power MU | ±1.904dB |
| Bandedge MU | ±0.095dBuV |
| Channel Separation MU | 361.69Hz |
| Duty Cycle MU | 0.064ms |
| Frequency Stability MU | 0.223kHz |

This measurement uncertainty is confidence of approximately 95%, k=2

7. SETUP OF EQUIPMENT UNDER TEST

7.1 SETUP CONFIGURATION OF EUT

EMI

【LINE】

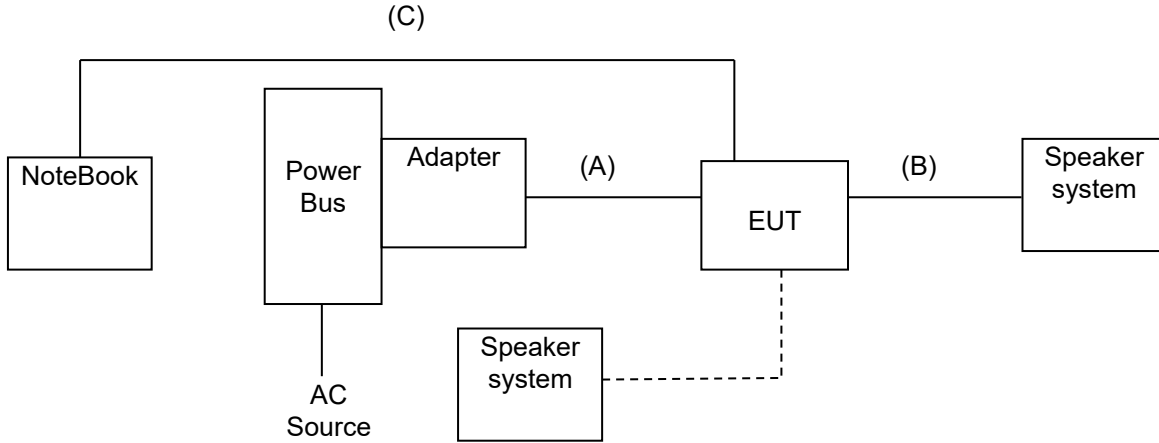

【PHONO】

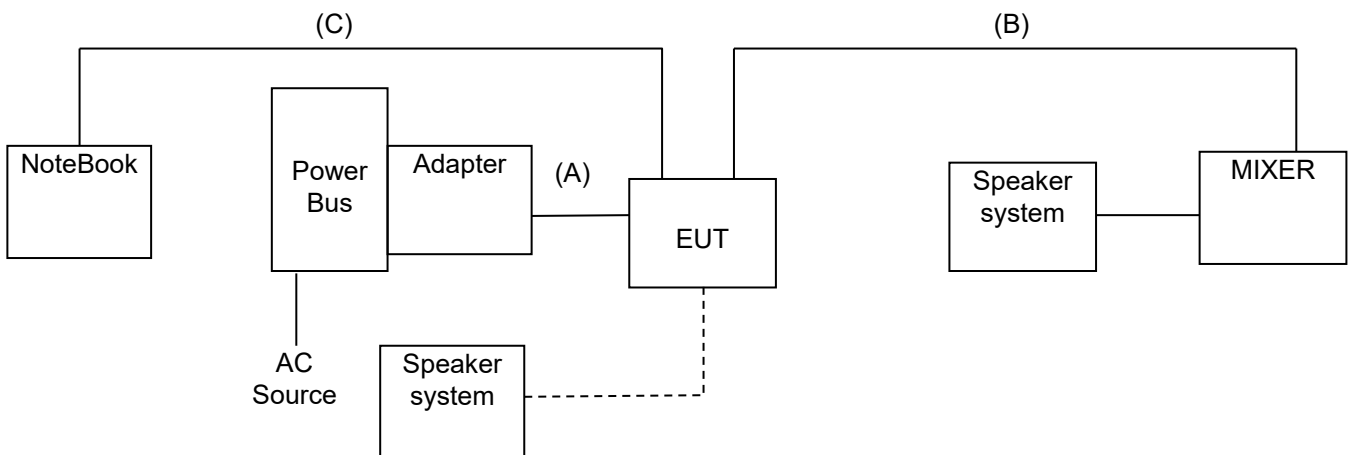

RF

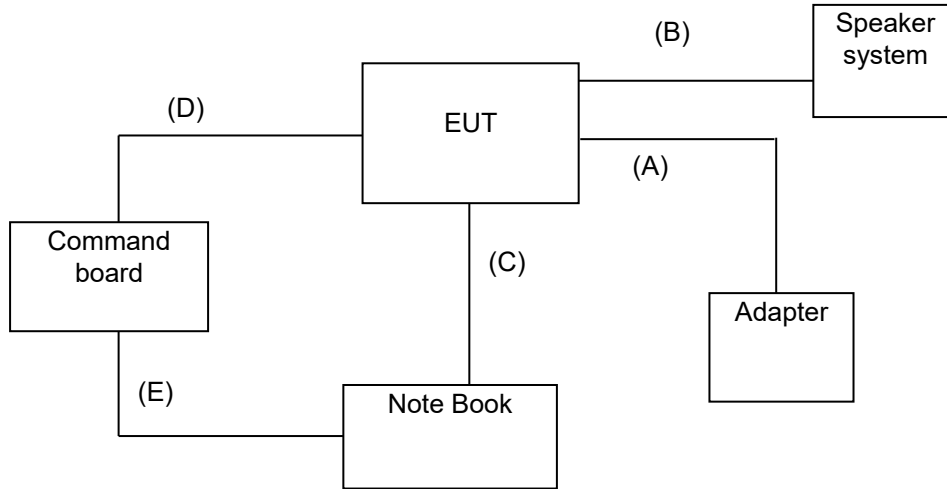

7.2 SUPPORT EQUIPMENT

For EMI test

| No. | Product | Manufacturer | Model No. | Certify No. | Signal cable |
|-----|-------------------|--------------|---------------|-------------|--------------------------|
| 1 | MIXER | HANPIN | HP-MU1 | N/A | N/A |
| 2 | Speaker System | T.C.SATR | TCS2285 | DoC | Audio cable, unshd, 1.4m |
| 3 | Note Book | TOSHIBA | PORTEGE R30-A | DoC | Power cable, unshd, 1.8m |
| 4 | Bluetooth Speaker | KINYO | BTS-672 | N/A | N/A |

| No. | Signal cable description | |
|-----|--------------------------|--------------------------------------|
| A | DC Power | Unshielded, 1.5m 1 pcs. with 1 core. |
| B | Audio | Shielded, 1.0m 1 pcs. |
| C | USB | Shielded, 2.0m 1 pcs. |

For RF test

| No. | Product | Manufacturer | Model No. | Certify No. | Signal cable |
|-----|----------------|--------------|-----------|-------------|--------------------------|
| 1 | Note Book | Acer | AS 3830TG | DoC | Power cable, unshd, 1.6m |
| 2 | Speaker System | T.C.SATR | TCS2285 | DoC | Audio cable, unshd, 1.4m |

| No. | Signal cable description | |
|-----|--------------------------|--|
| A | Power | Unshielded, 1.5m 1 pcs. with 1 core. |
| B | Audio | Unshielded, 1.0m 1 pcs. |
| C | USB | Unshielded, 2.0m 1 pcs. |
| D | Command | Unshielded, 0.35m 1 pcs. with 2 cores. |
| E | USB | Unshielded, 1.2m 1 pcs. with 1 core. |

Note:

- 1) All the equipment/cables were placed in the worst-case configuration to maximize the emission during the test.
- 2) Grounding was established in accordance with the manufacturer's requirements and conditions for the intended use.
- 3) shd. = shielded; unshd. = unshielded

EUT OPERATING CONDITION**RF Setup**

1. Set up all computers like the setup diagram.
2. The “CSR BlueSuite 2.6.4”, “Blue Test 3” software was used for testing.
3. Choose Transport “SPI” and Port “USB SPI (600373)”.

TX Mode:**GFSK(DH1):**

CFG PKT > Packet Type : 4 , Packet Type : 27

TXDATA1 > LO Freq : 2402 (2402,2441,2480) , Power : 100,0(100,0 , 83,0 , 81,0)

GFSK(DH3):

CFG PKT > Packet Type : 11 , Packet Type : 183

TXDATA1 > LO Freq : 2402 (2402,2441,2480) , Power : 100,0(100,0 , 83,0 , 81,0)

GFSK(DH5):

CFG PKT > Packet Type : 15 , Packet Type : 339

TXDATA1 > LO Freq : 2402 (2402,2441,2480) , Power : 100,0(100,0 , 83,0 , 81,0)

8-DPSK(3DH1):

CFG PKT > Packet Type : 24 , Packet Type : 83

TXDATA1 > LO Freq : 2402 (2402,2441,2480) , Power : 255,10(255,10 , 190,0)

8-DPSK(3DH3):

CFG PKT > Packet Type : 27 , Packet Type : 552

TXDATA1 > LO Freq : 2402 (2402,2441,2480) , Power : 255,10(255,10 , 190,0)

8-DPSK(3DH5):

CFG PKT > Packet Type : 31 , Packet Type : 1021

TXDATA1 > LO Freq : 2402 (2402,2441,2480) , Power : 255,10(255,10 , 190,0)

GFSK(4.0):

BLE TEST TX > Channel :0 (0,20,39)

Length : 37

Bit pattern : 0

Report No.: T190605N02-RP1-1

RX Mode:

GFSK , 8-DPSK:

RXDATA1

GFSK(4.0):

BLE TEST RX

4. All of the function are under run.

5 .Start test.

8. APPLICABLE LIMITS AND TEST RESULTS

8.1 20dB BANDWIDTH FOR HOPPING

LIMIT

None; for reporting purposes only.

TEST SETUP

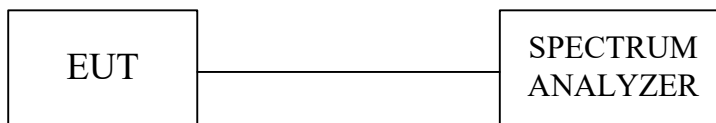

TEST PROCEDURE

The 20dB band width was measured with a spectrum analyzer connected to RF antenna connector (conducted measurement) while EUT was operating in transmit mode at the appropriate center frequency. The analyzer center frequency was set to the EUT carrier frequency, using the analyzer. Display Line and Marker Delta functions, the 20dB band width of the emission was determined.

TEST RESULTS

| | | | |
|----------------------------|-----------------|------------------|------------|
| Model Name | AT-LP120XBT-USB | Test By | Ted Huang |
| Temp & Humidity | 26.2°C, 66% | Test Date | 2019/06/19 |

Modulation Type: GFSK / DH5

| Channel | Channel Frequency (MHz) | 20dB Bandwidth (kHz) | Pass / Fail |
|---------|-------------------------|----------------------|-------------|
| Low | 2402 | 891 | N/A |
| Middle | 2441 | 890 | N/A |
| High | 2480 | 892 | N/A |

Modulation Type: 8-DPSK / 3-DH5

| Channel | Channel Frequency (MHz) | 20dB Bandwidth (kHz) | Pass / Fail |
|---------|-------------------------|----------------------|-------------|
| Low | 2402 | 1230 | N/A |
| Middle | 2441 | 1229 | N/A |
| High | 2480 | 1233 | N/A |

20dB BANDWIDTH

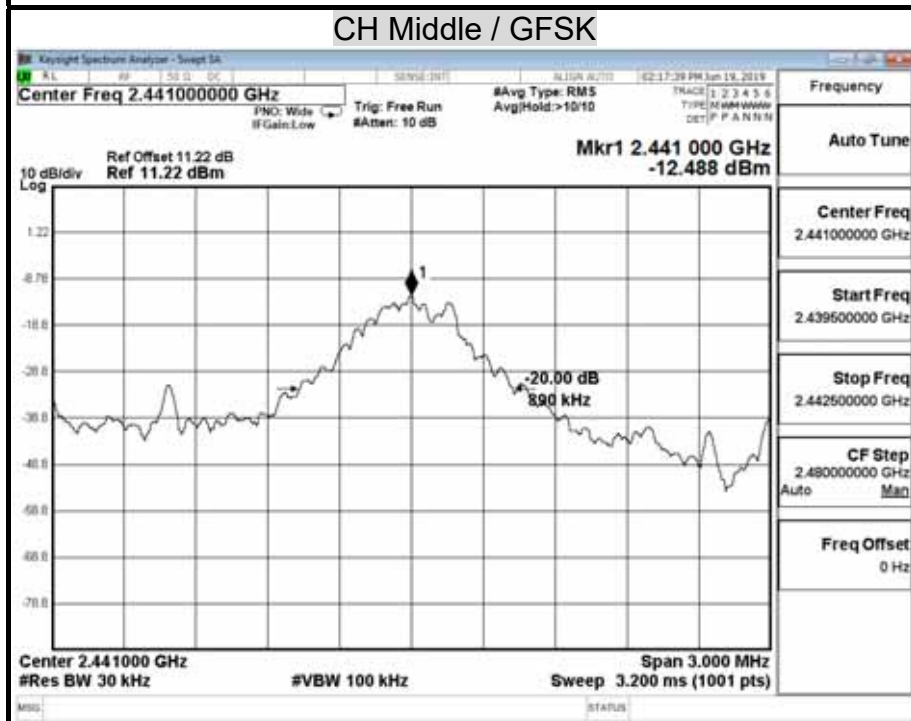
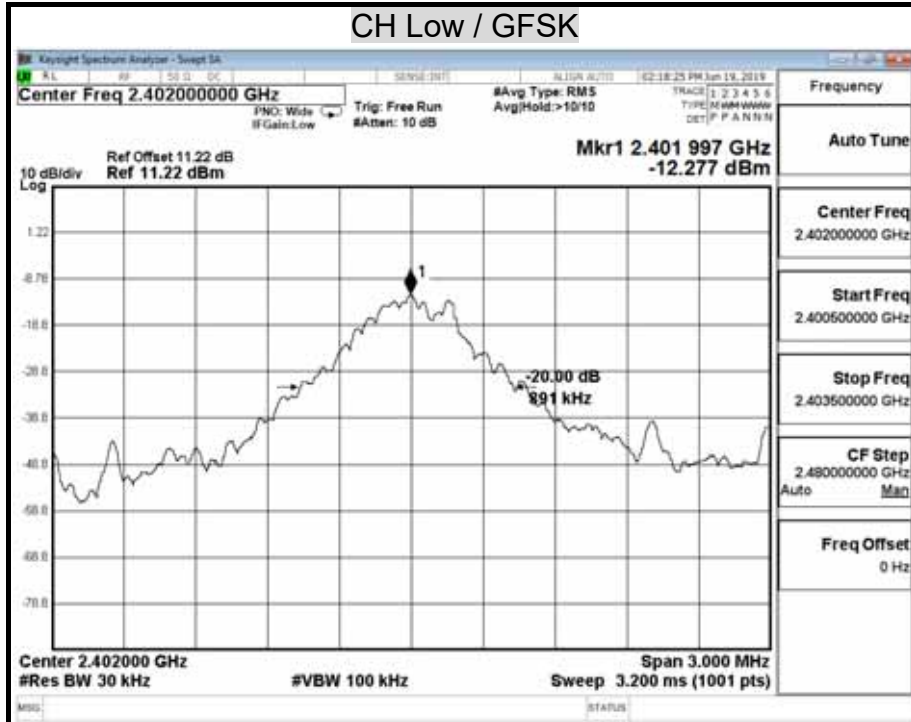



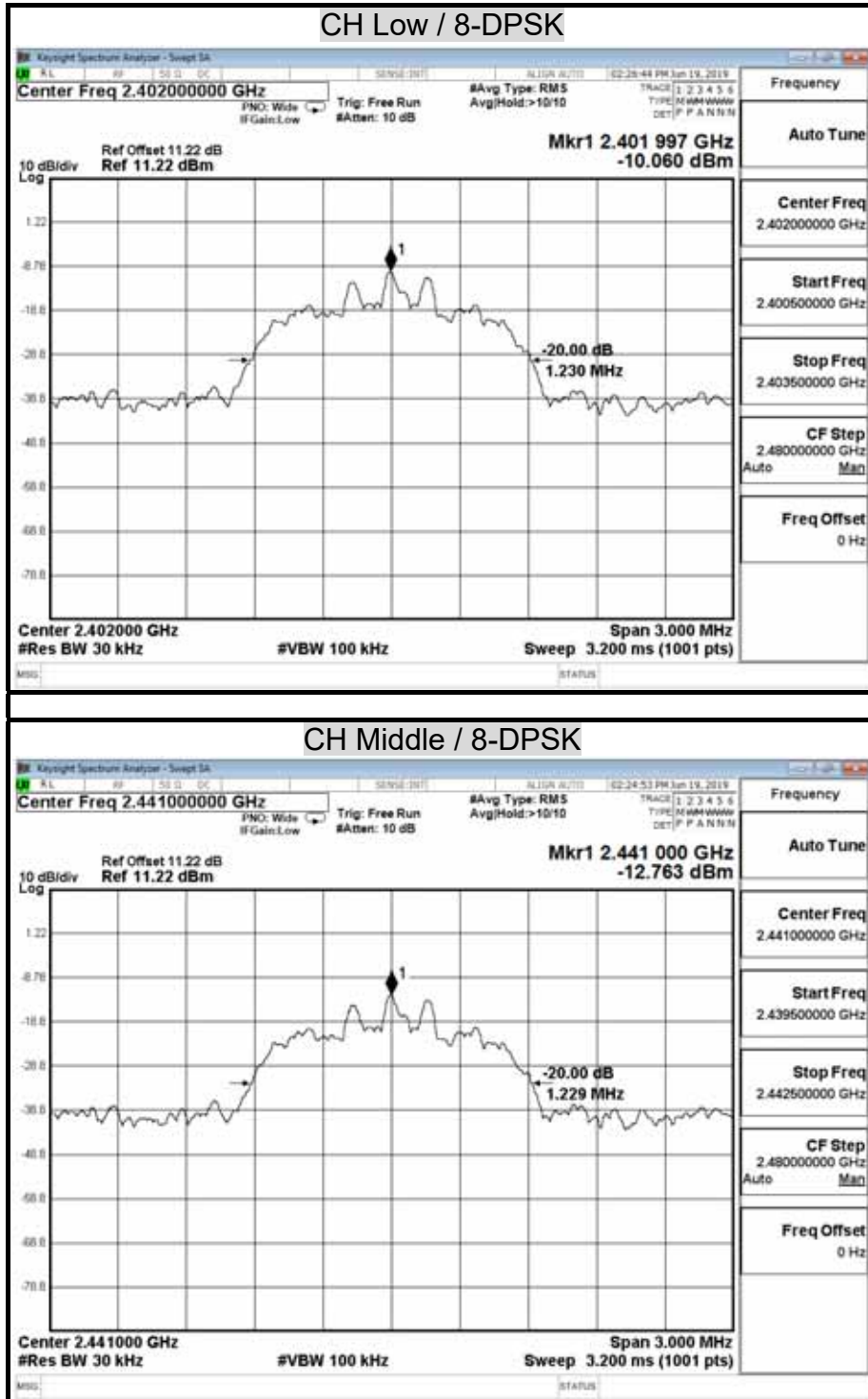

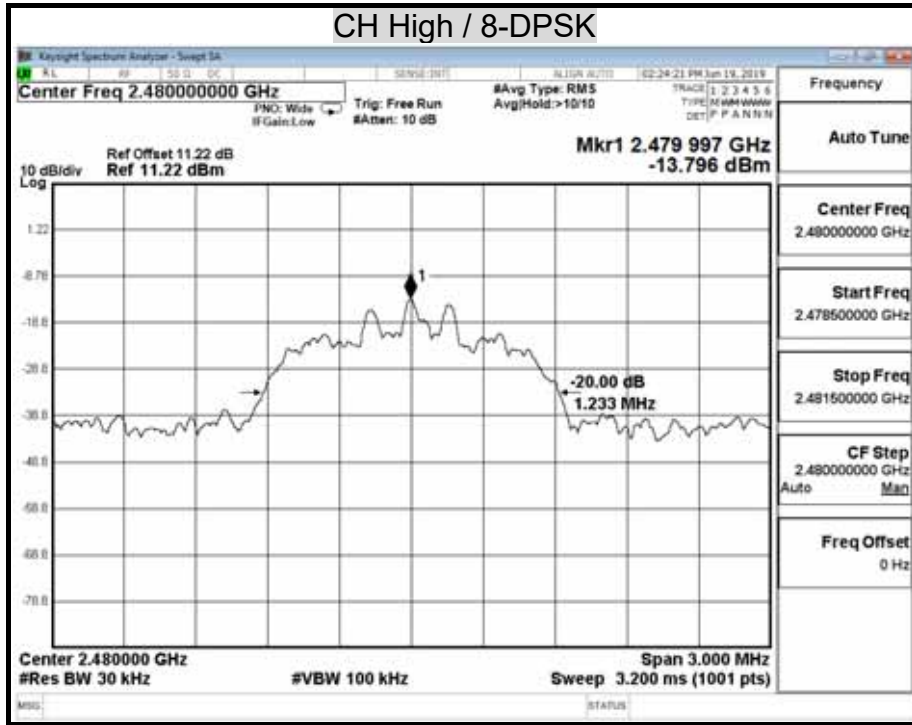

8.2 MAXIMUM PEAK OUTPUT POWER

LIMIT

§15.247(b)(1) For frequency hopping systems operating in the 2400-2483.5 MHz band employing at least 75 non-overlapping hopping channels, and all frequency hopping systems in the 5725-5850 MHz band: 1 watt. For all other frequency hopping systems in the 2400-2483.5 MHz band: 0.125 watts.

Test Configuration

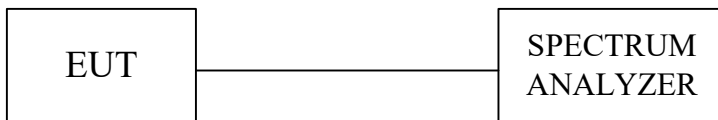

TEST PROCEDURE

The RF power output was measured with a Spectrum Analyzer connected to the RF Antenna connector (conducted measurement) while EUT was operating in transmit mode at the appropriate center frequency, A power meter was used to record the shape of the transmit signal.

Span = approximately 5 times the 20 dB bandwidth, centered on a hopping channel

RBW > the 20 dB bandwidth of the emission being measured

VBW ≥ RBW

Sweep = auto

Detector function = peak

Trace = max hold

TEST RESULTS

| | | | |
|----------------------------|-----------------|------------------|------------|
| Model Name | AT-LP120XBT-USB | Test By | Ted Huang |
| Temp & Humidity | 26.2°C, 66% | Test Date | 2019/06/19 |

Modulation Type: GFSK / DH5

| Channel | Channel Frequency (MHz) | Peak Power Output (dBm) | Peak Power Output (mW) | Limit (W) | Result |
|---------|-------------------------|-------------------------|------------------------|-----------|--------|
| Low | 2402 | -10.42 | 0.09084 | 1 | PASS |
| Mid | 2441 | -10.13 | 0.09707 | | PASS |
| High | 2480 | -15.08 | 0.03104 | | PASS |

Modulation Type: 8-DPSK / 3-DH5

| Channel | Channel Frequency (MHz) | Peak Power Output (dBm) | Peak Power Output (mW) | Limit (W) | Result |
|---------|-------------------------|-------------------------|------------------------|-----------|--------|
| Low | 2402 | -6.06 | 0.24786 | 1 | PASS |
| Mid | 2441 | -8.08 | 0.15570 | | PASS |
| High | 2480 | -9.07 | 0.12397 | | PASS |

Average Power Data

Modulation Type: GFSK / DH5

| Channel | Channel Frequency (MHz) | Average Power (dBm) |
|---------|-------------------------|---------------------|
| Low | 2402 | -12.12 |
| Middle | 2441 | -12.38 |
| High | 2480 | -18.14 |

Modulation Type: 8-DPSK / 3-DH5

| Channel | Channel Frequency (MHz) | Average Power (dBm) |
|---------|-------------------------|---------------------|
| Low | 2402 | -12.42 |
| Middle | 2441 | -14.97 |
| High | 2480 | -16.05 |

MAXIMUM PEAK OUTPUT POWER

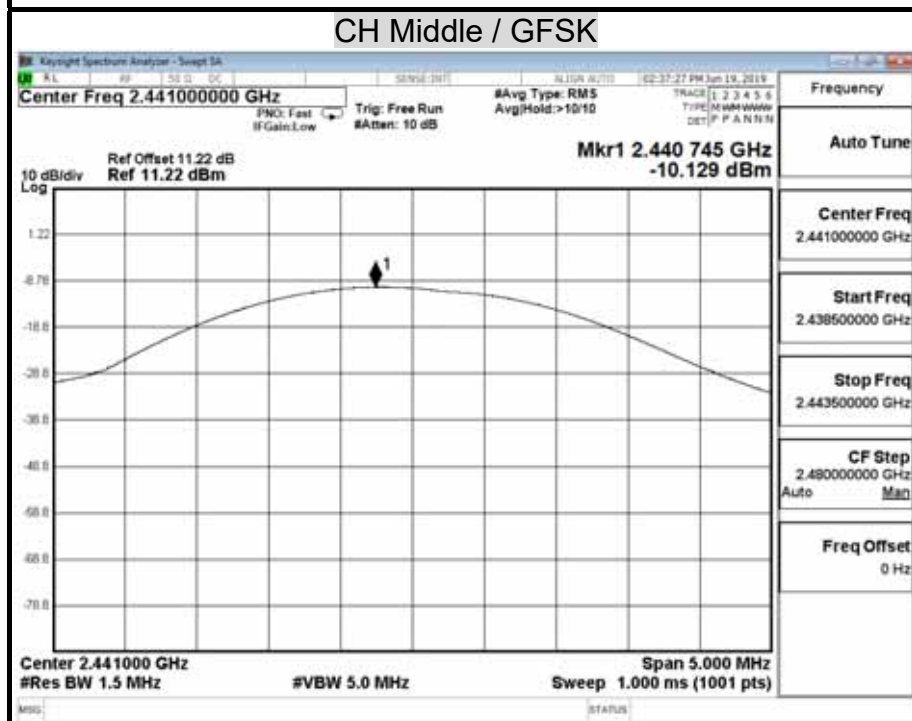
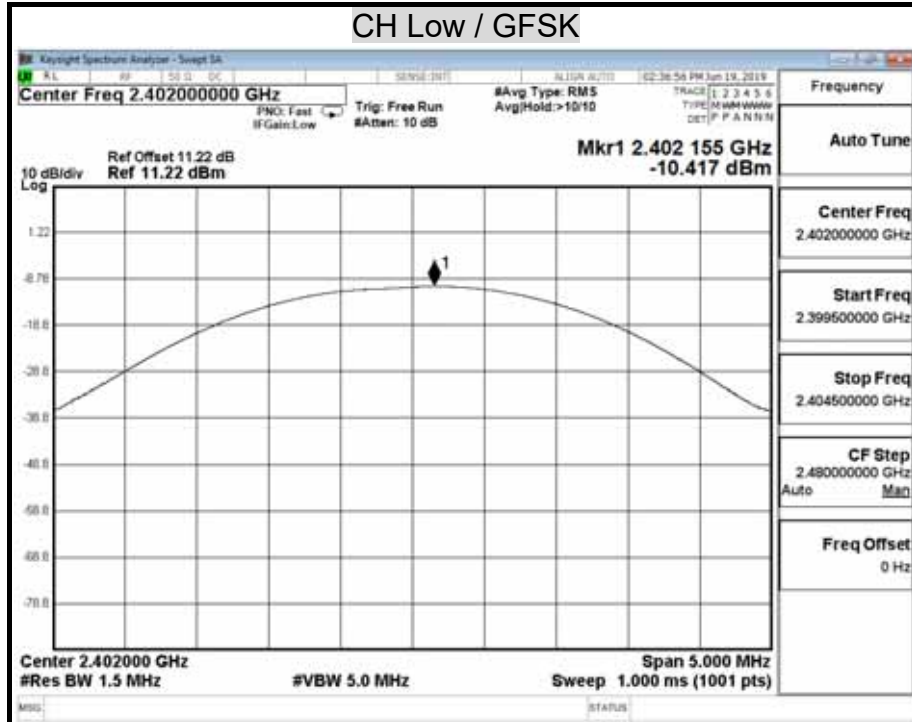

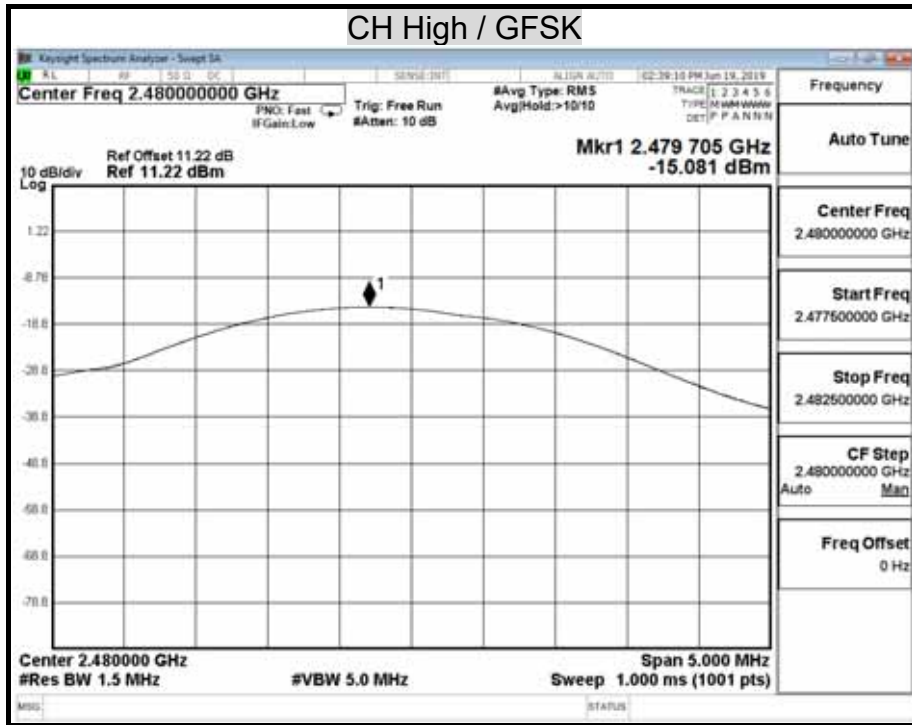

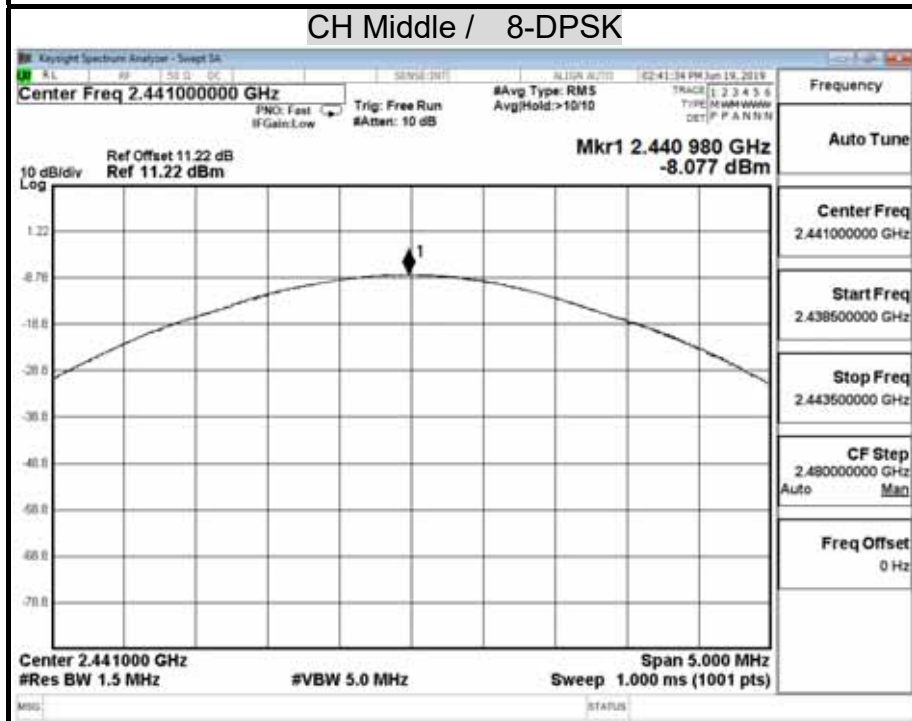
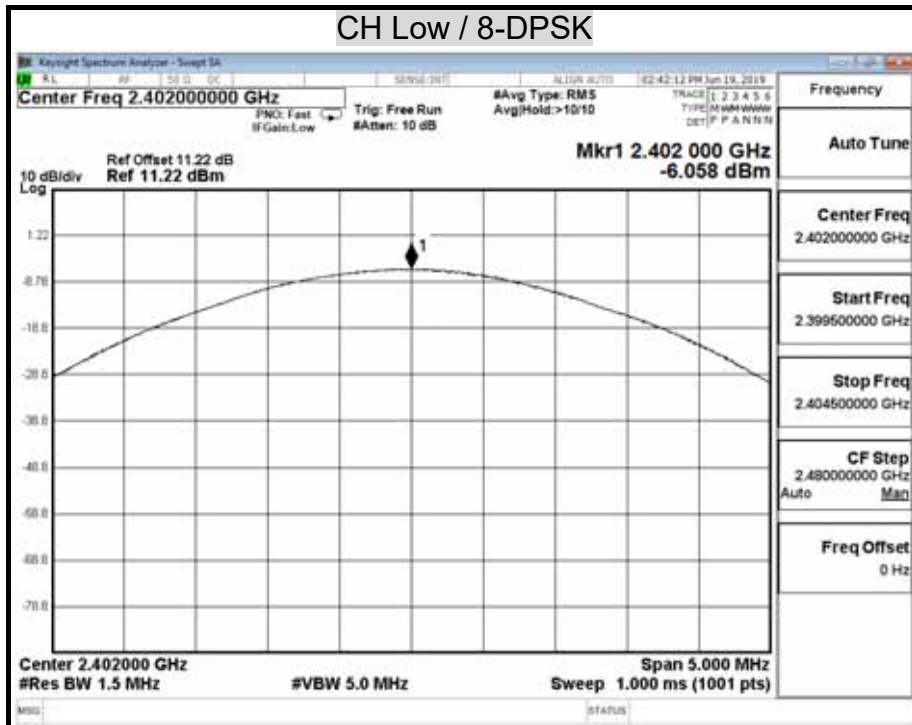

Report No.: T190605N02-RP1-1

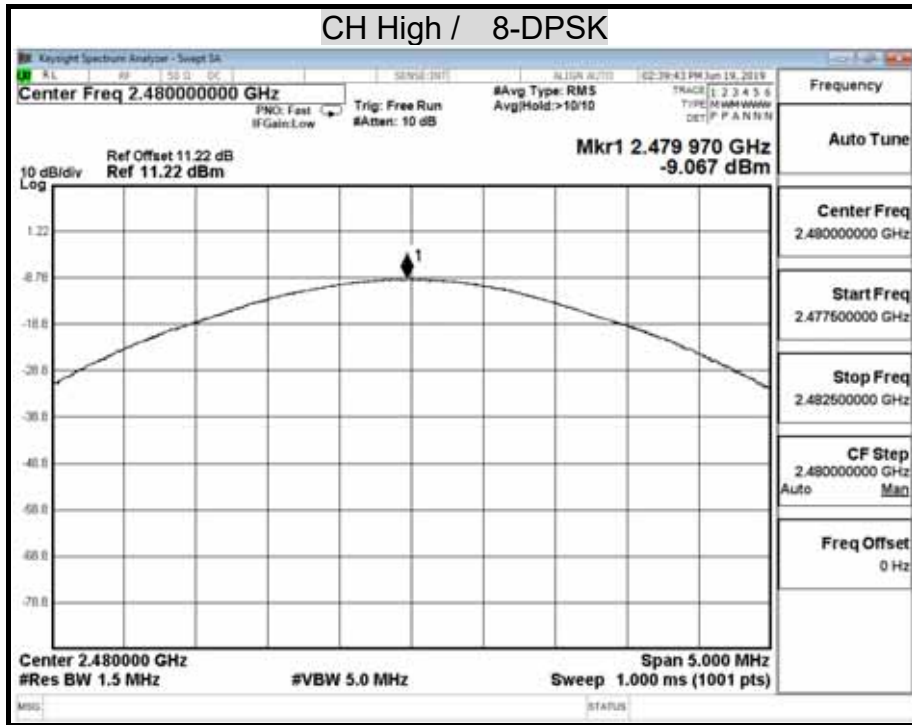

AVERAGE POWER

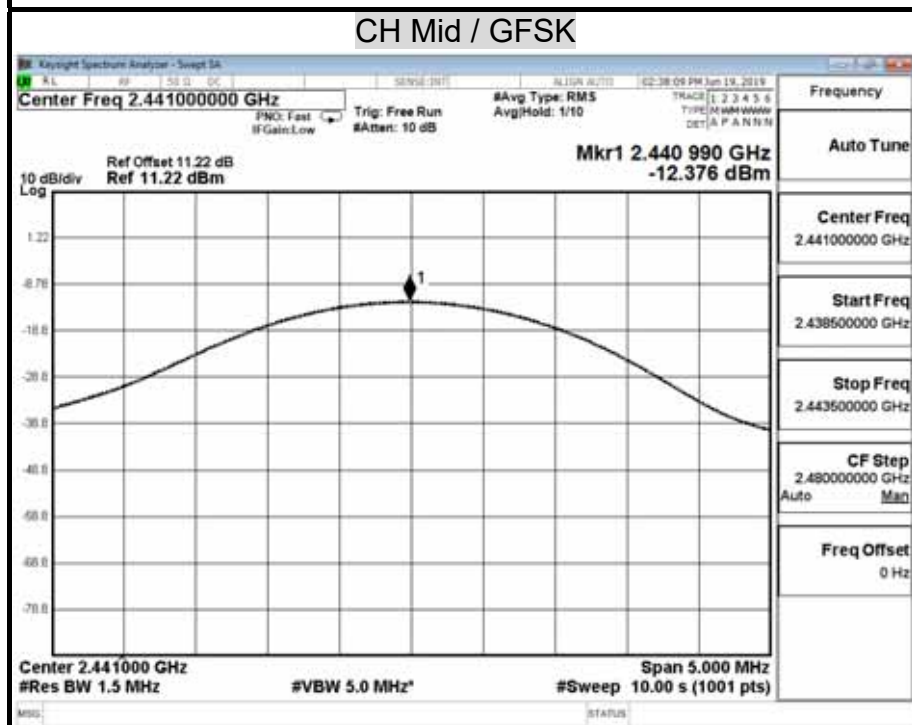
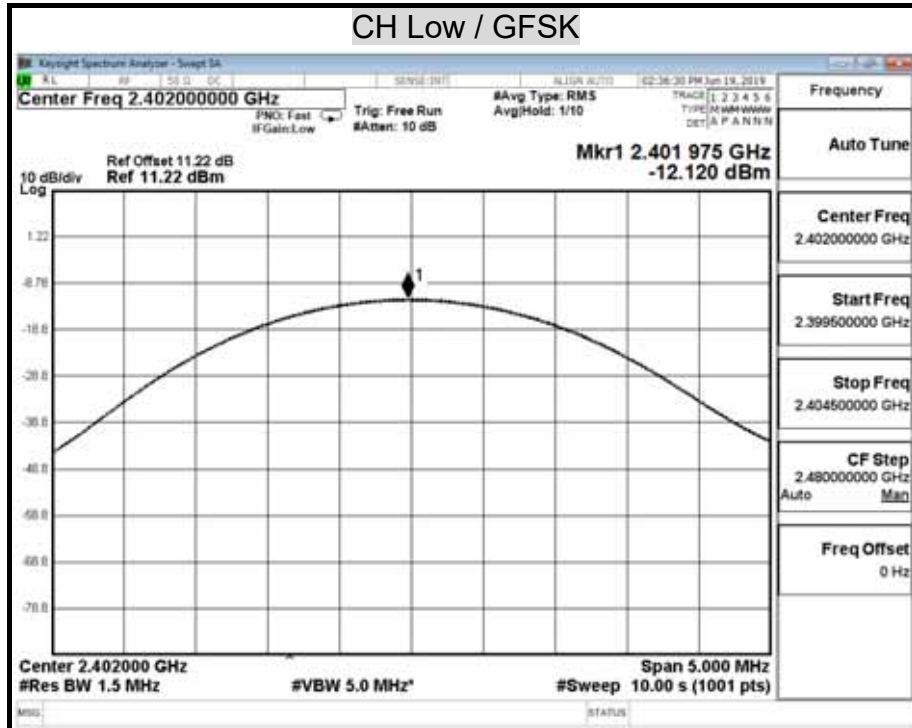

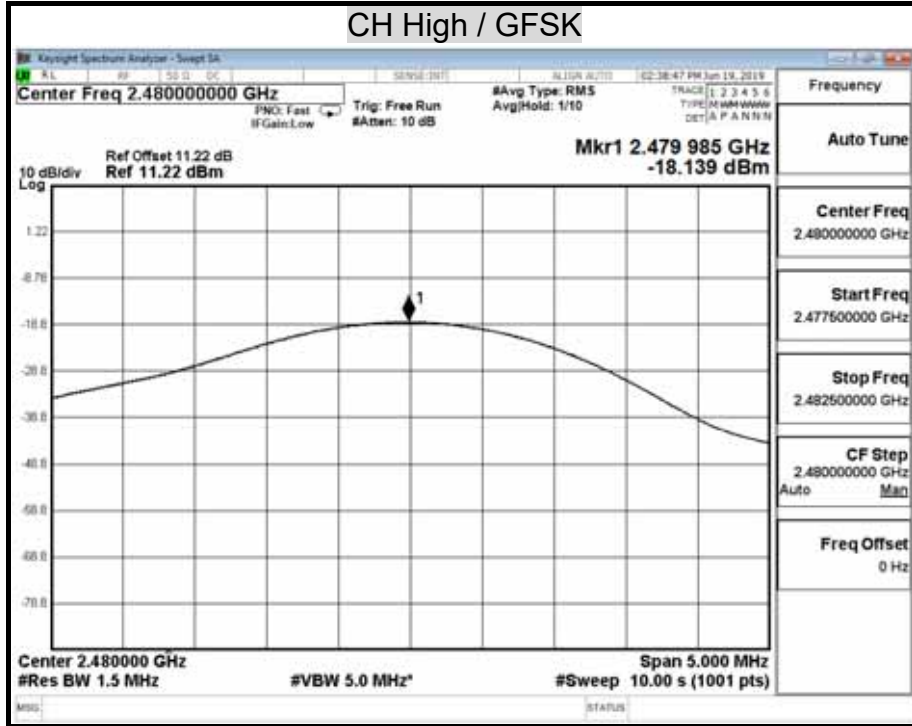

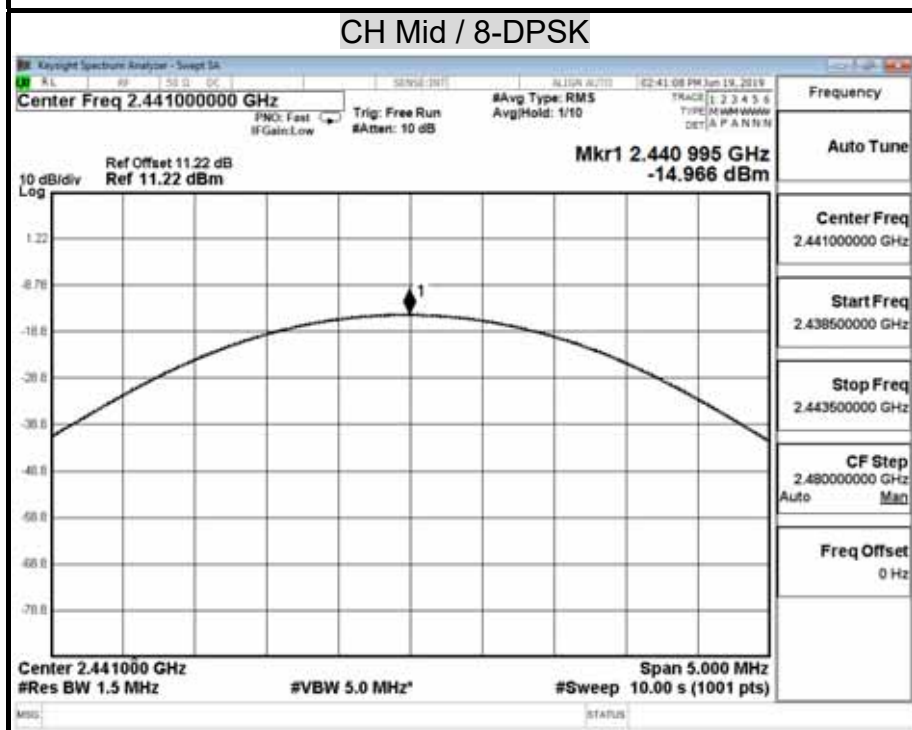
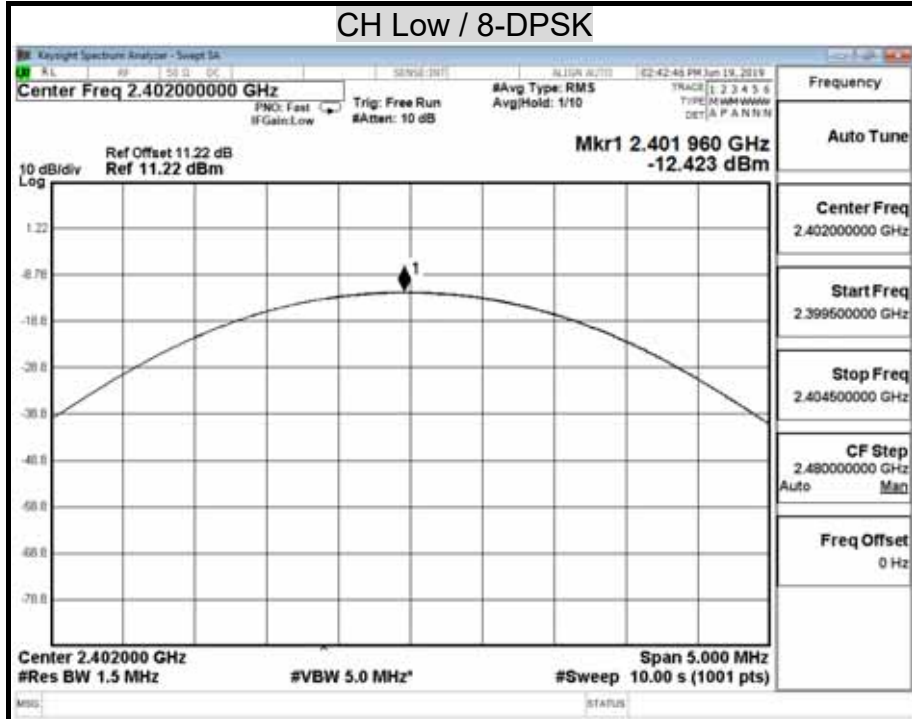

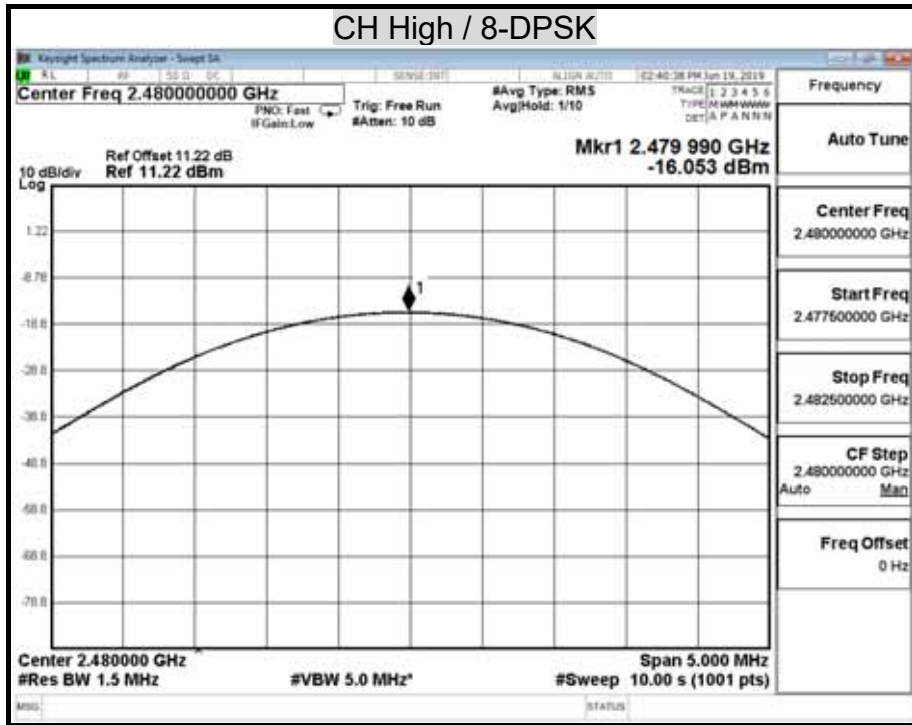

8.3 HOPPING CHANNEL SEPARATION

LIMIT

§15.247(a)(1) Frequency hopping systems shall have hopping channel carrier frequencies separated by a minimum of 25 kHz or the 20 dB bandwidth of the hopping channel, whichever is greater. Alternatively, frequency hopping systems operating in the 2400-2483.5 MHz band may have hopping channel carrier frequencies that are separated by 25 kHz or two-thirds of the 20 dB bandwidth of the hopping channel, whichever is greater, provided the systems operate with an output power no greater than 125 mW. The system shall hop to channel frequencies that are selected at the system hopping rate from a pseudo randomly ordered list of hopping frequencies. Each frequency must be used equally on the average by each transmitter. The system receivers shall have input bandwidths that match the hopping channel bandwidths of their corresponding transmitters and shall shift frequencies in synchronization with the transmitted signals.

TEST SETUP

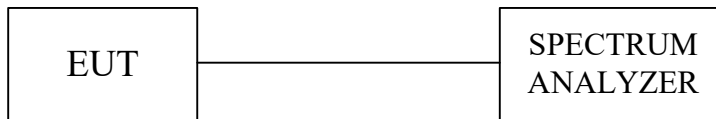

TEST PROCEDURE

1. Check the calibration of the measuring instrument using either an internal calibrator or a known signal from an external generator.
2. Position the EUT as shown in test setup without connection to measurement instrument. Turn on the EUT and connect it to measurement instrument. Then set it to any one convenient frequency within its operating range.
3. By using the MaxHold function record the separation of adjacent channels.
4. Measure the frequency difference of these two adjacent channels by spectrum analyzer MARK function. And then plot the result on spectrum analyzer screen.
5. Repeat above procedures until all frequencies measured were complete.

Report No.: T190605N02-RP1-1

TEST RESULTS

Refer to section 8.1, 20dB bandwidth measurement, the measured channel separation should be greater than two-third of 20dB bandwidth or Minimum bandwidth.

| | | | |
|----------------------------|-----------------|------------------|------------|
| Model Name | AT-LP120XBT-USB | Test By | Ted Huang |
| Temp & Humidity | 26.2°C, 66% | Test Date | 2019/06/19 |

Modulation Type: GFSK / DH5

| Channel | Adjacent Hopping Channel Separation (MHz) | Two -third of 20dB bandwidth (MHz) | Minimum Bandwidth (kHz) | Result |
|---------|---|------------------------------------|-------------------------|--------|
| 2402MHz | 1.00 | 0.59 | 25 KHz | PASS |
| 2441MHz | 1.00 | 0.59 | 25 KHz | PASS |
| 2480MHz | 1.00 | 0.59 | 25 KHz | PASS |

Modulation Type: 8-DPSK / 3-DH5

| Channel | Adjacent Hopping Channel Separation (kHz) | Two -third of 20dB bandwidth (kHz) | Minimum Bandwidth (kHz) | Result |
|---------|---|------------------------------------|-------------------------|--------|
| 2402MHz | 1.00 | 0.82 | 25 KHz | PASS |
| 2441MHz | 1.00 | 0.82 | 25 KHz | PASS |
| 2480MHz | 1.00 | 0.82 | 25 KHz | PASS |

HOPPING CHANNEL SEPARATION

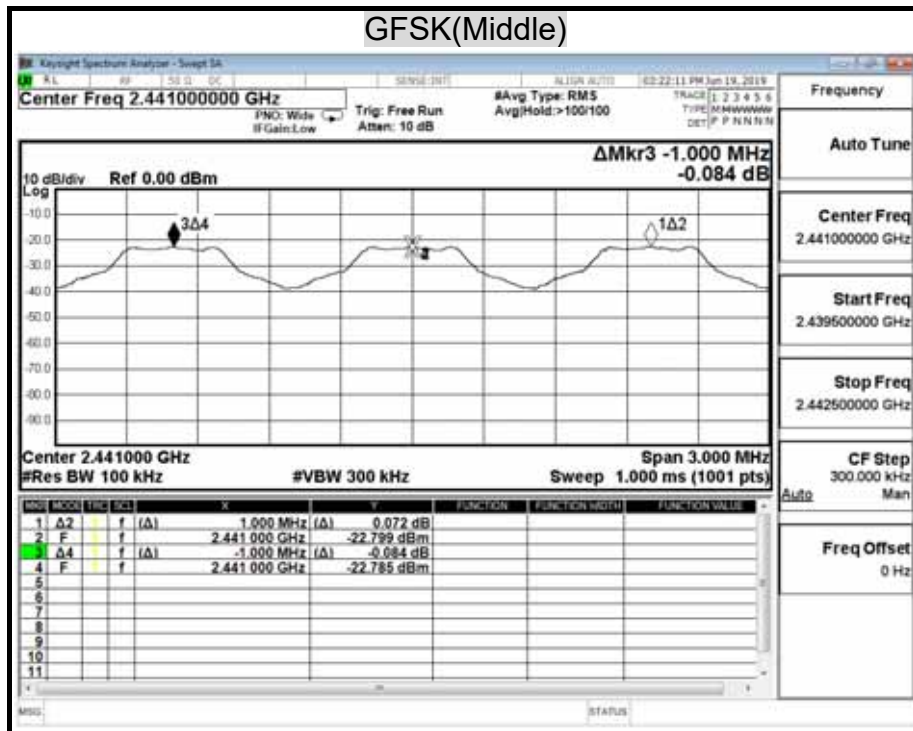
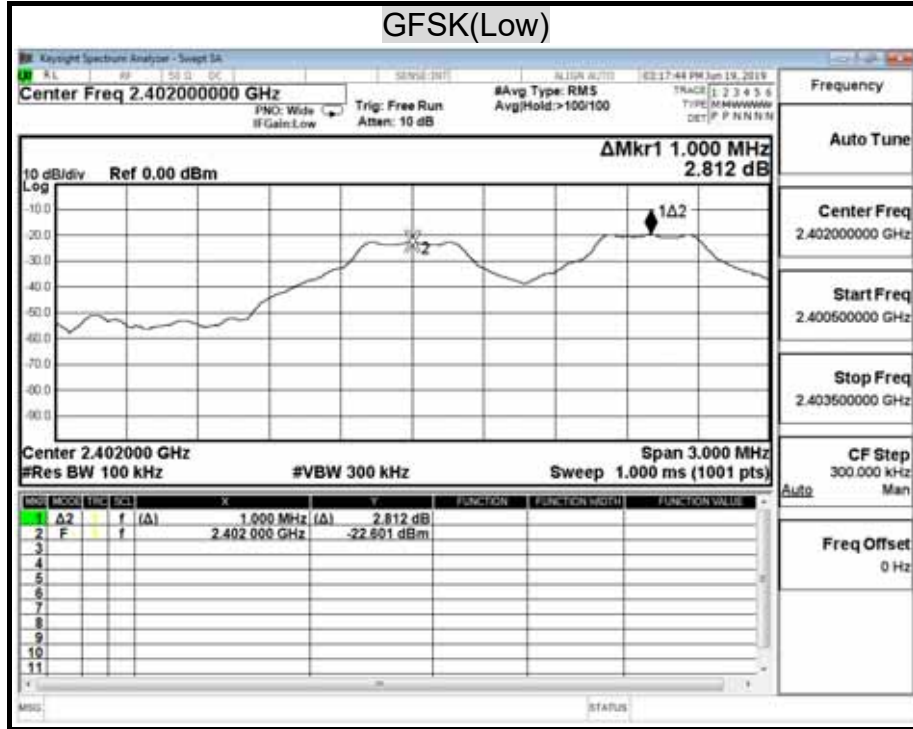

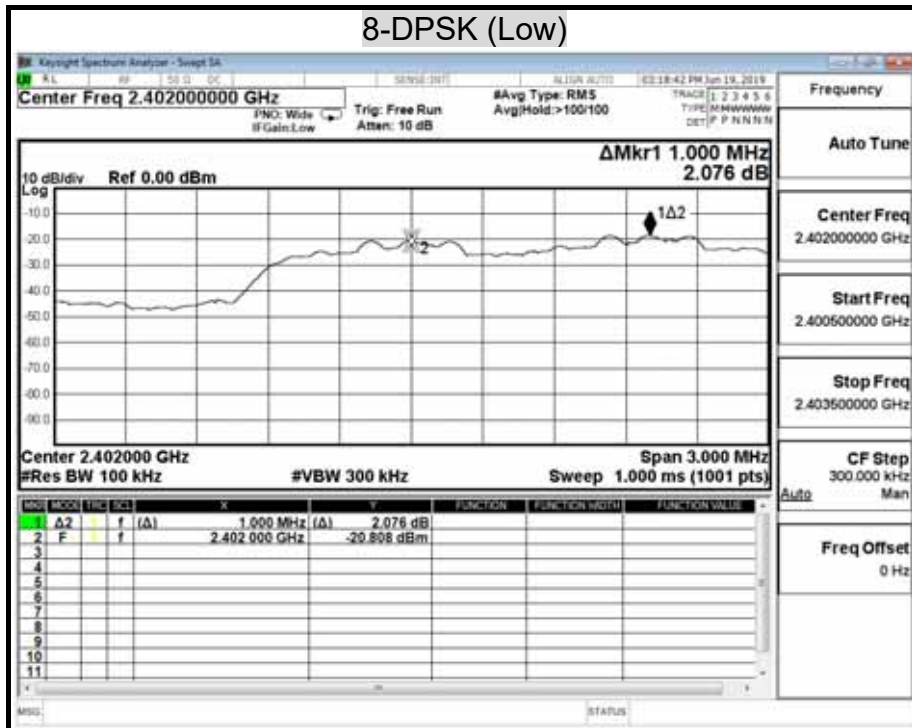
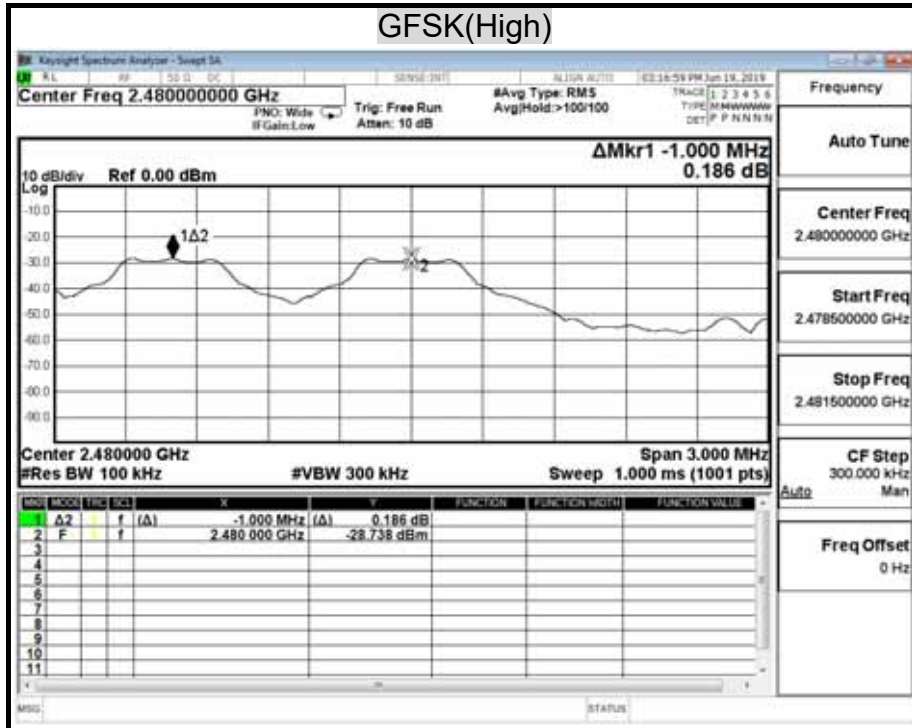

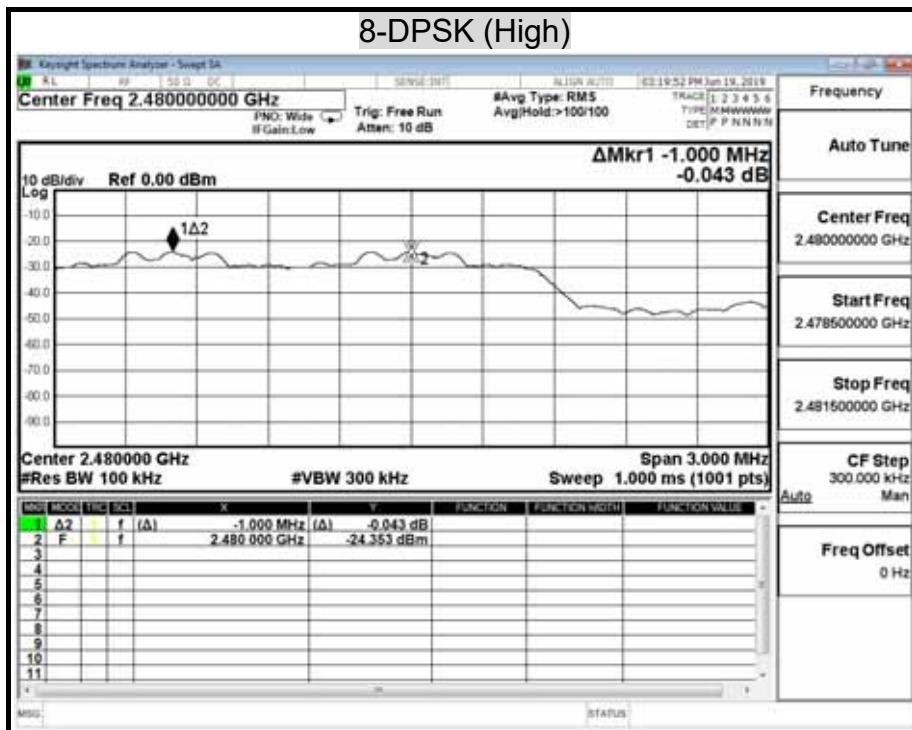
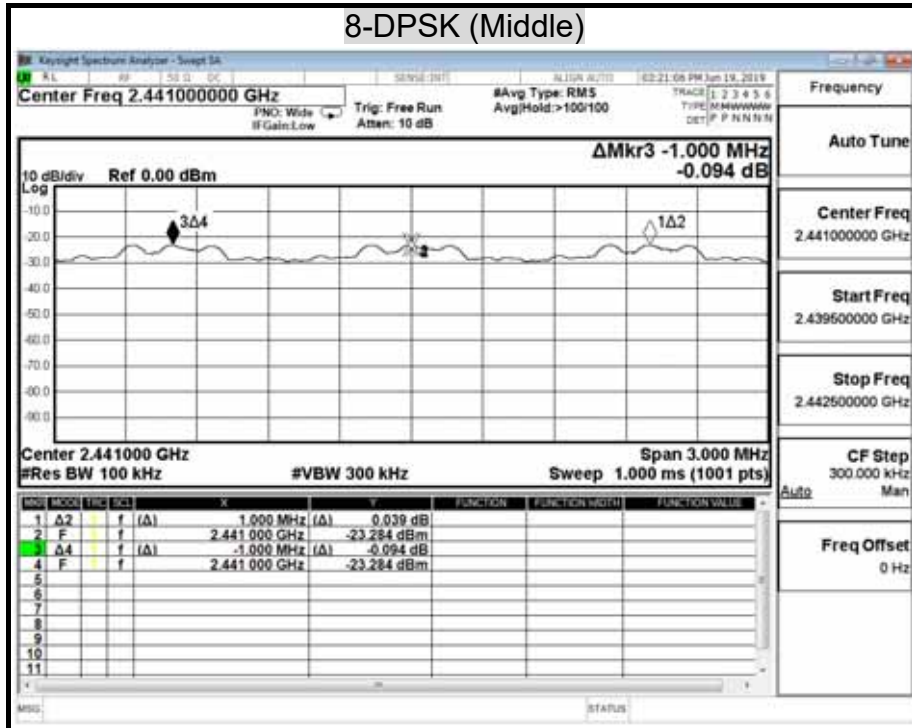

8.4 NUMBER OF HOPPING FREQUENCY USED

LIMIT

§15.247(a)(1)(iii) For frequency hopping systems in the 2400-2483.5 MHz band shall use at least 15 channels.

TEST SETUP

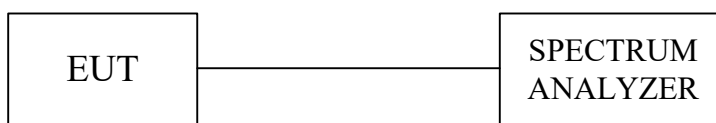

TEST PROCEDURE

- 1 Check the calibration of the measuring instrument (spectrum analyzer) using either an internal calibrator or a known signal from an external generator.
- 2 Position the EUT as shown in test setup without connection to measurement instrument. Turn on the EUT and connect its antenna terminal to measurement instrument via a low loss cable. Then set it to any one measured frequency within its operating range and make sure the instrument is operated in its linear range.
- 3 Set the spectrum analyzer on MaxHold Mode, and then keep the EUT in hopping mode. Record all the signals from each channel until each one has been recorded.
- 4 Set the spectrum analyzer on View mode and then plot the result on spectrum analyzer screen.
- 5 Repeat above procedures until all frequencies measured were complete.

TEST RESULTS

| | | | |
|----------------------------|-----------------|------------------|------------|
| Model Name | AT-LP120XBT-USB | Test By | Ted Huang |
| Temp & Humidity | 26.2°C, 66% | Test Date | 2019/06/19 |

Modulation Type: GFSK / DH5

| Result(No.of CH) | Limit(No.of CH) | Result |
|-------------------------|------------------------|---------------|
| 79 | >75 | PASS |

Modulation Type: 8-DPSK / 3-DH5

| Result(No.of CH) | Limit(No.of CH) | Result |
|-------------------------|------------------------|---------------|
| 79 | >75 | PASS |

NUMBER OF HOPPING FREQUENCY USED

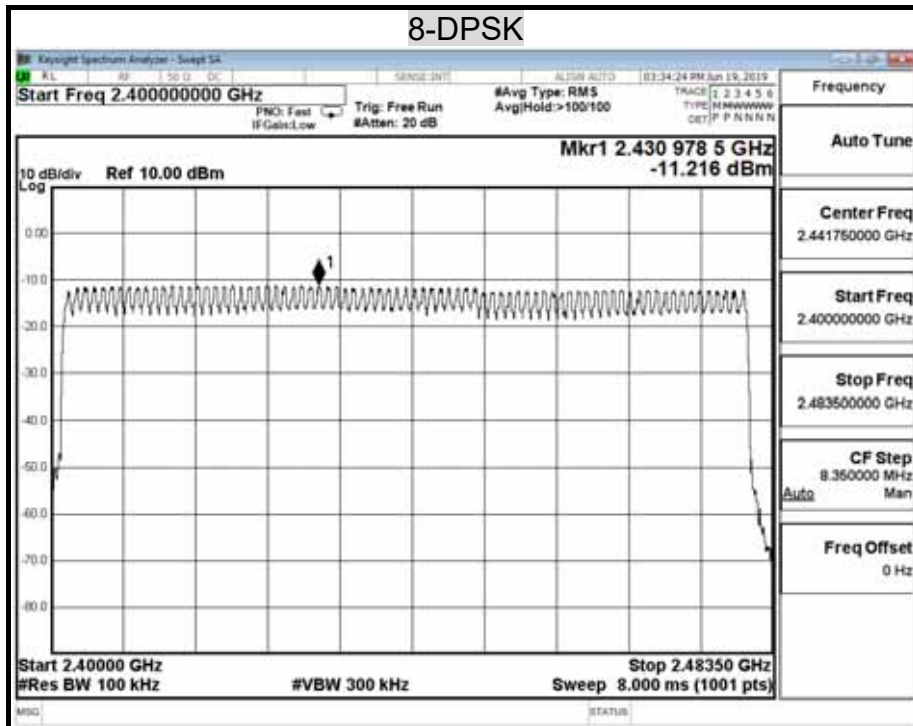
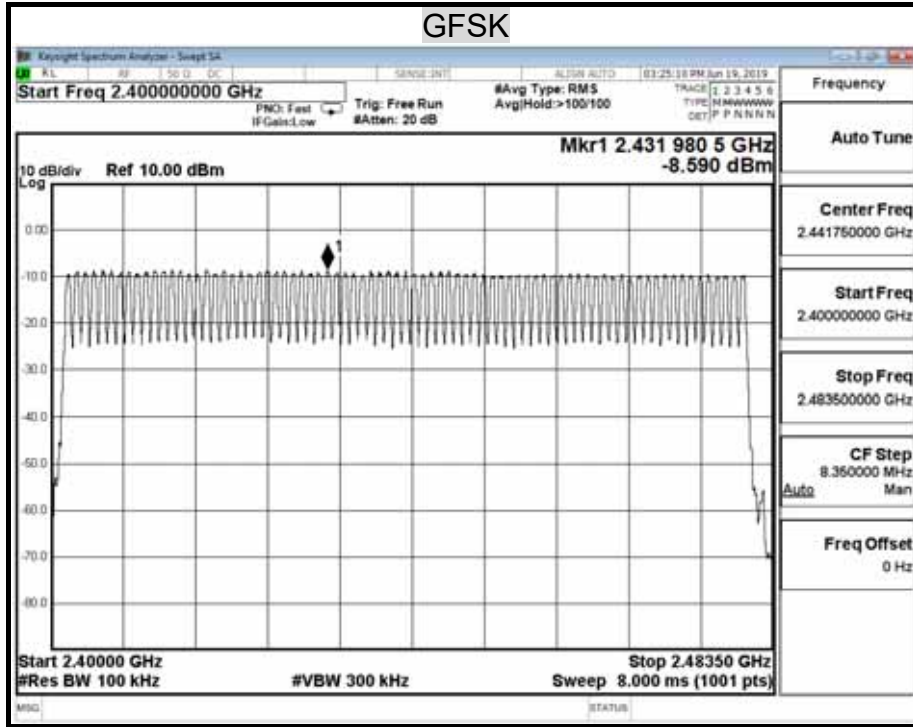

8.5 DWELL TIME ON EACH CHANNEL

LIMIT

§15.247(a)(1)(iii) For frequency hopping system operating in the 2400-2483.5MHz band, the average time of occupancy on any frequency shall not be greater than 0.4 second within a 31.6 second period.

TEST SETUP

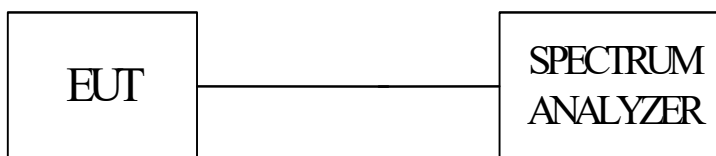

TEST PROCEDURE

1. Check the calibration of the measuring instrument using either an internal calibrator or a known signal from an external generator.
2. Position the EUT as shown in test setup without connection to measurement instrument. Turn on the EUT and connect its antenna terminal to measurement instrument via a low loss cable. Then set it to any one measured frequency within its operating range and make sure the instrument is operated in its linear range.
3. Adjust the center frequency of spectrum analyzer on any frequency be measured and set spectrum analyzer to zero span mode. And then, set RBW and VBW of spectrum analyzer to proper value.
4. Measure the time duration of one transmission on the measured frequency. And then plot the result with time difference of this time duration.
5. Repeat above procedures until all frequencies measured were complete.
6. The Bluetooth Headset has 3 type of payload, DH1, DH3, DH5. The hopping rate is 1600 per second. The longer the payload is, the slower the hopping rate is.

Report No.: T190605N02-RP1-1

TEST RESULTS

Time of occupancy on the TX channel in 31.6sec = time domain slot length × hop rate ÷ number of hop per channel × 31.6

Refer to the attached graph.

The hopping rates of Bluetooth devices change with different types of payload. The longer the payload is, the slower the hopping rate. The hopping rate scenario is defined in Bluetooth core specification.

| | | | |
|----------------------------|-----------------|------------------|------------|
| Model Name | AT-LP120XBT-USB | Test By | Ted Huang |
| Temp & Humidity | 26.2°C, 66% | Test Date | 2019/06/19 |

Modulation Type: GFSK / DH5

| Transmitting Frequency | Packet type | Dwell time (ms) | Time of occupancy on the TX channel in 31.6sec (ms) | Limit for Time of occupancy on the TX channel in 31.6sec (ms) | Results |
|------------------------|-------------|-----------------|---|---|---------|
| 2441MHz | DH1 | 0.400 | 128.00 | 400.00 | PASS |
| 2441MHz | DH3 | 1.660 | 265.60 | 400.00 | PASS |
| 2441MHz | DH5 | 2.900 | 309.33 | 400.00 | PASS |
| 2441MHz | AFH | 2.900 | 154.67 | 400.00 | PASS |

DH1 Dwell time= $0.400 \text{ ms} \times (1600 \div 2) \div 79 \times 31.6 = 128.00 \text{ (ms)}$
 DH3 Dwell time= $1.660 \text{ ms} \times (1600 \div 4) \div 79 \times 31.6 = 265.60 \text{ (ms)}$
 DH5 Dwell time= $2.900 \text{ ms} \times (1600 \div 6) \div 79 \times 31.6 = 309.33 \text{ (ms)}$
 AFH Dwell time= $2.900 \text{ ms} \times (800 \div 6) \div 20 \times 8 = 154.67 \text{ (ms)}$

Modulation Type: 8-DPSK / 3-DH5

| Transmitting Frequency | Packet type | Dwell time (ms) | Time of occupancy on the TX channel in 31.6sec (ms) | Limit for Time of occupancy on the TX channel in 31.6sec (ms) | Results |
|------------------------|-------------|-----------------|---|---|---------|
| 2441MHz | 3DH1 | 0.415 | 132.80 | 400.00 | PASS |
| 2441MHz | 3DH3 | 1.660 | 265.60 | 400.00 | PASS |
| 2441MHz | 3DH5 | 2.900 | 309.33 | 400.00 | PASS |
| 2441MHz | AFH | 2.900 | 154.67 | 400.00 | PASS |

3DH1 Dwell time= $0.415 \text{ ms} \times (1600 \div 2) \div 79 \times 31.6 = 132.80 \text{ (ms)}$
 3DH3 Dwell time= $1.660 \text{ ms} \times (1600 \div 4) \div 79 \times 31.6 = 265.60 \text{ (ms)}$
 3DH5 Dwell time= $2.900 \text{ ms} \times (1600 \div 6) \div 79 \times 31.6 = 309.33 \text{ (ms)}$
 AFH Dwell time= $2.900 \text{ ms} \times (800 \div 6) \div 20 \times 8 = 154.67 \text{ (ms)}$

DWELL TIME ON EACH PAYLOAD

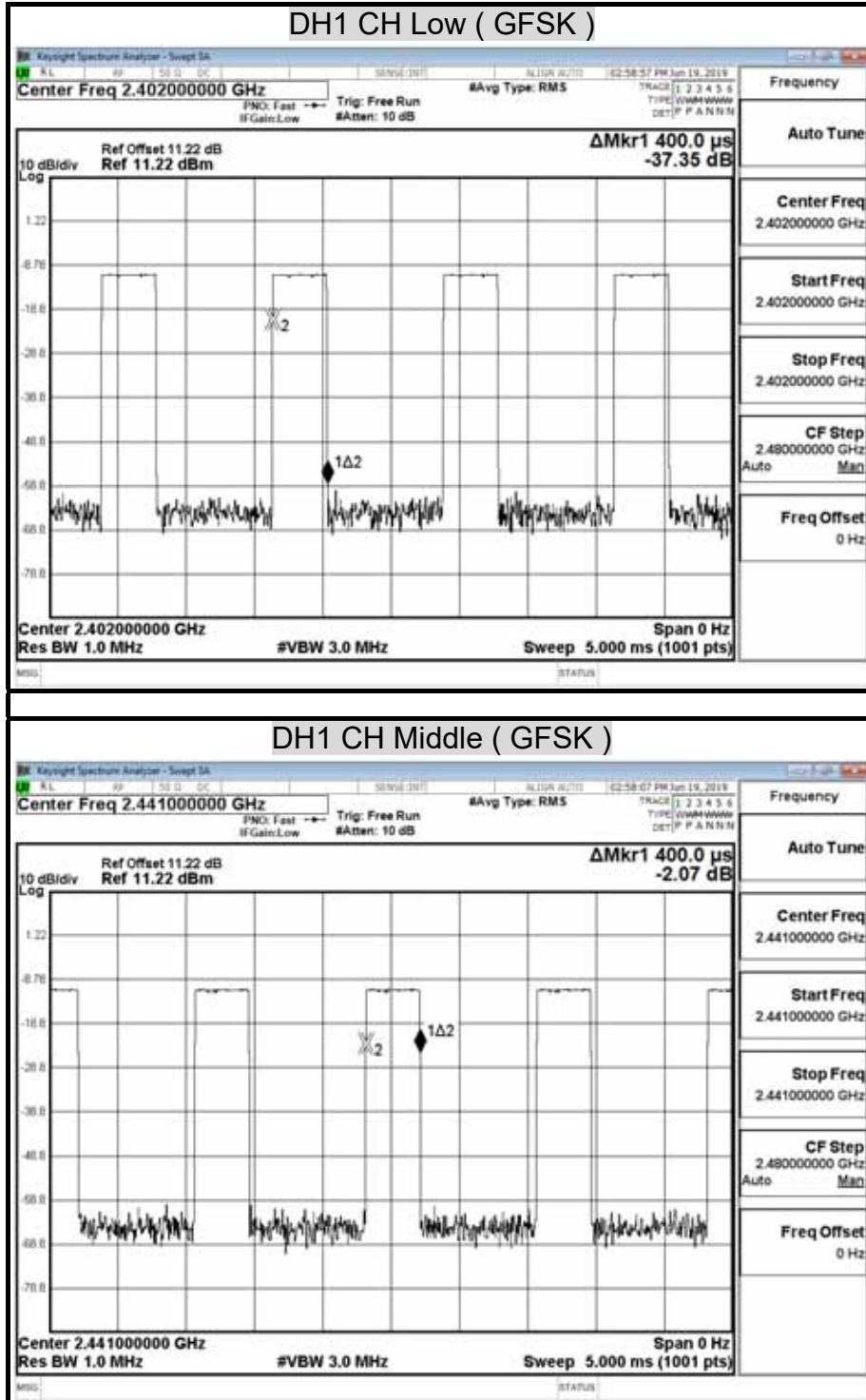

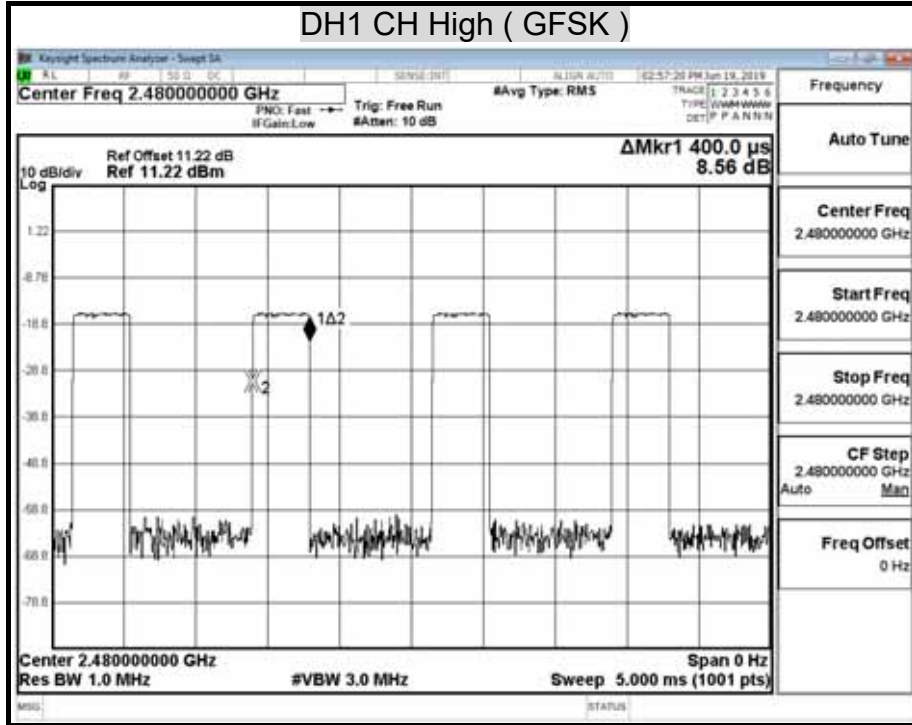

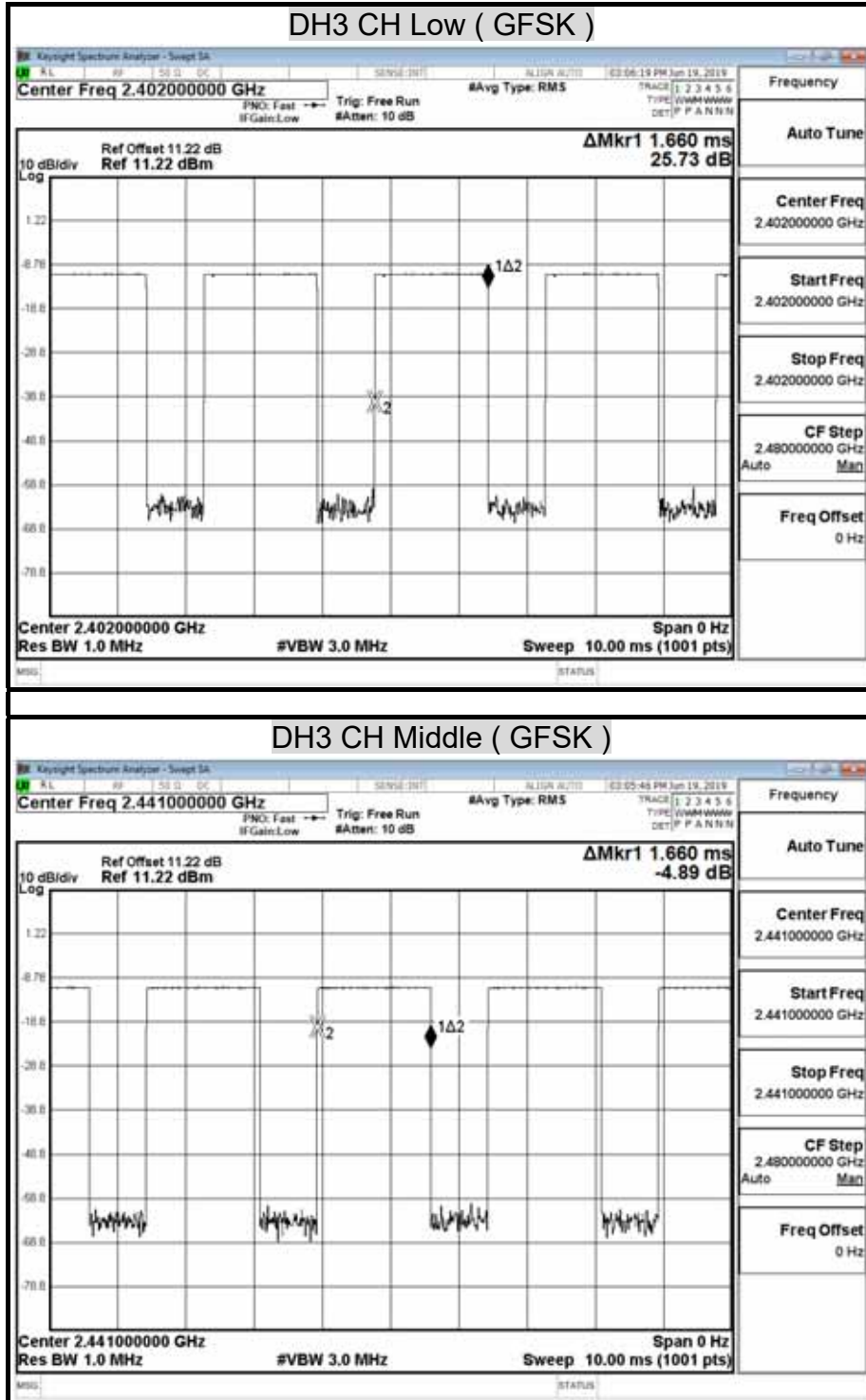

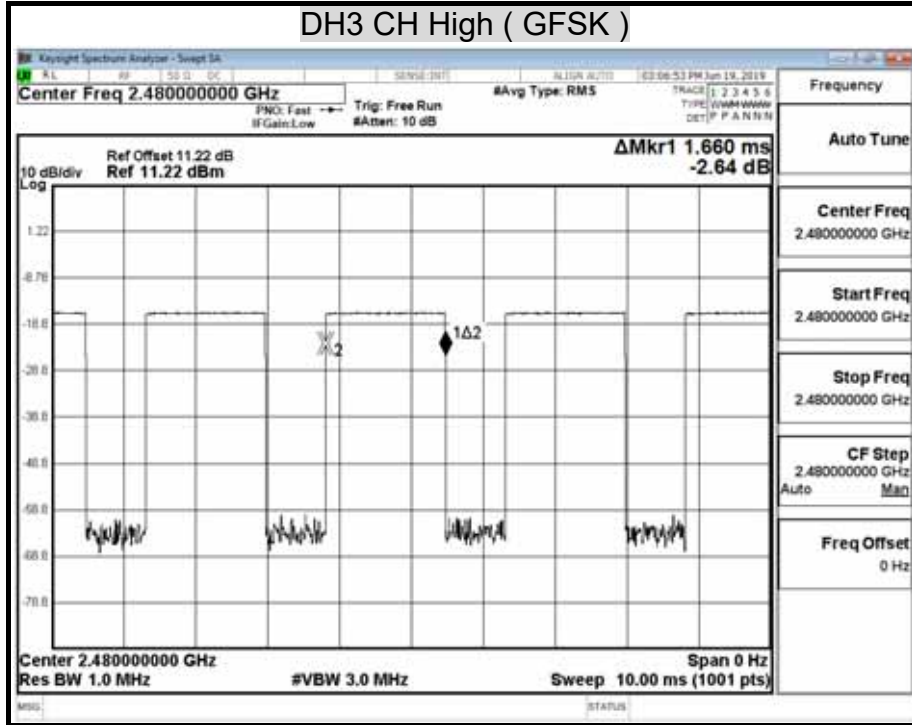

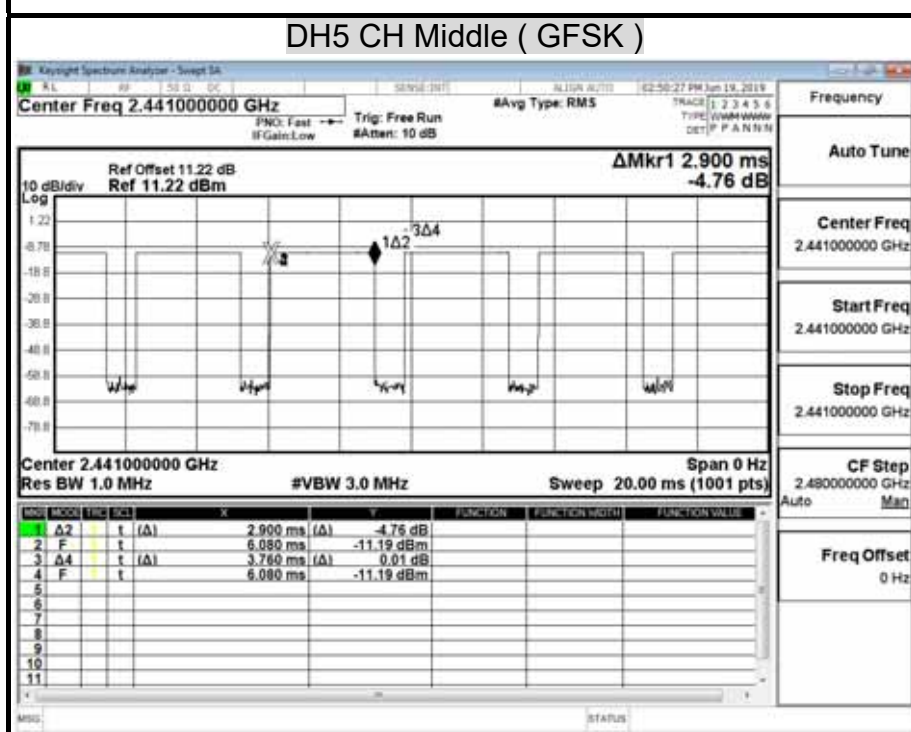
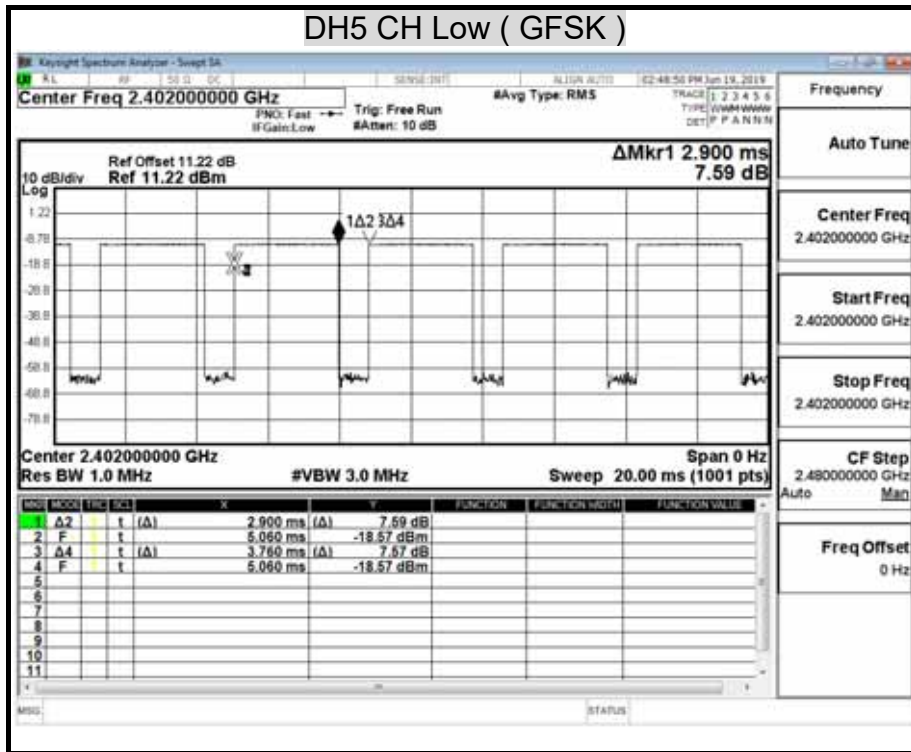

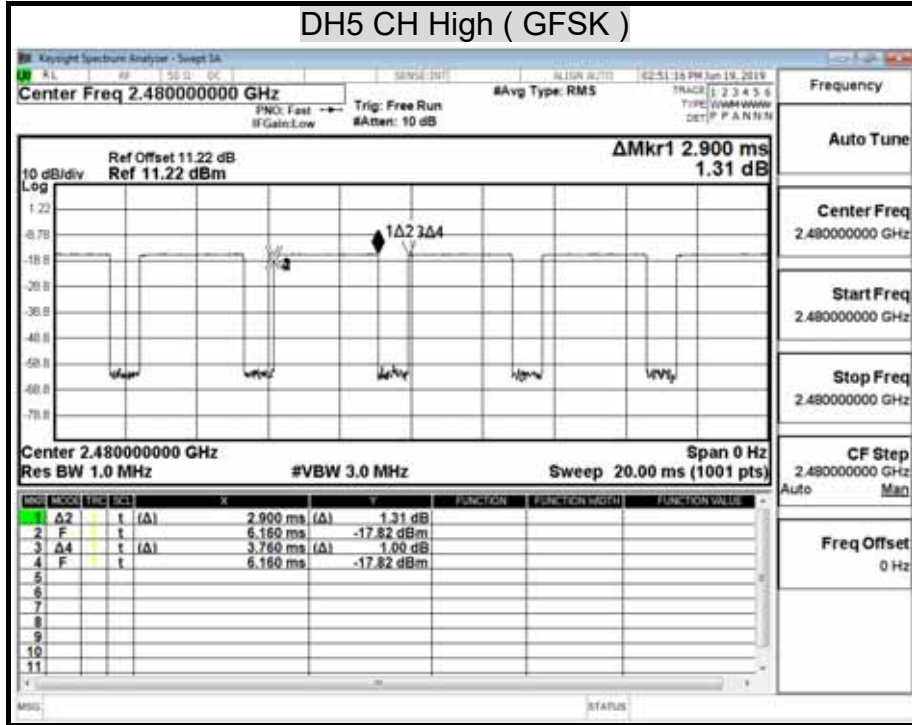

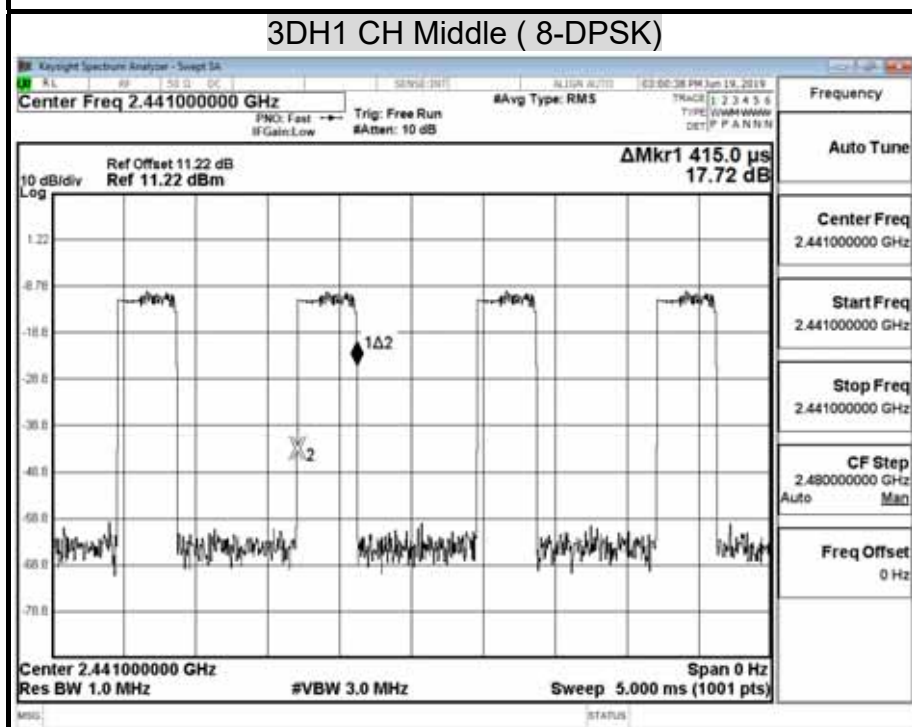
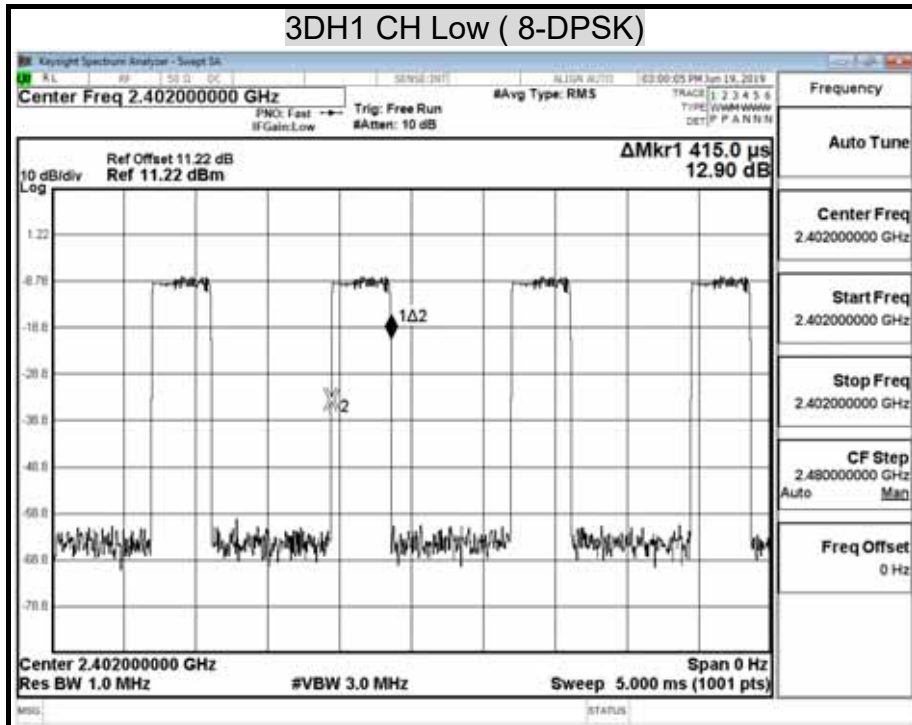

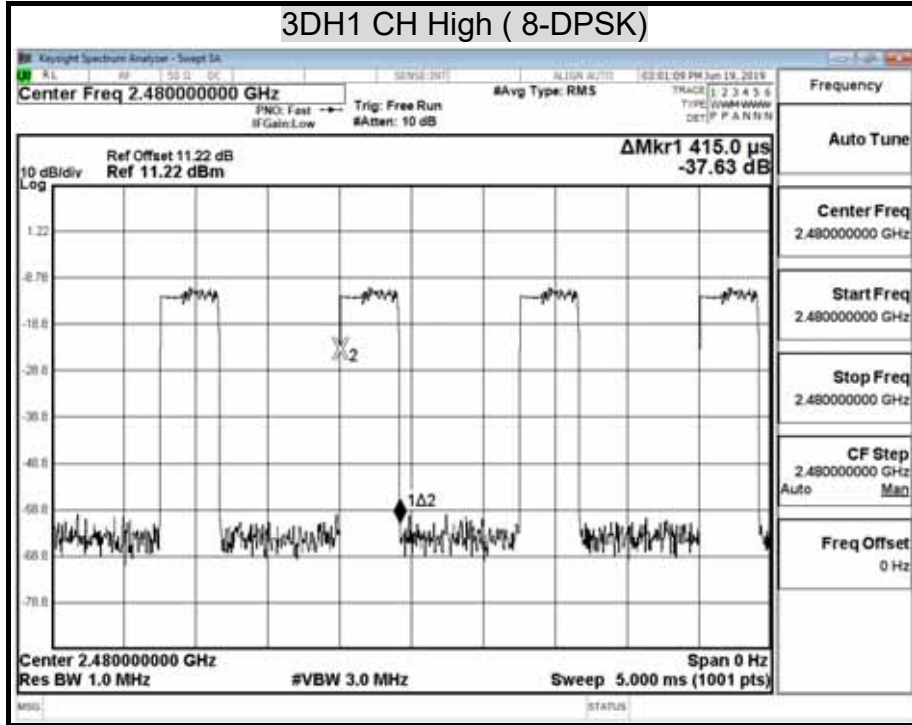

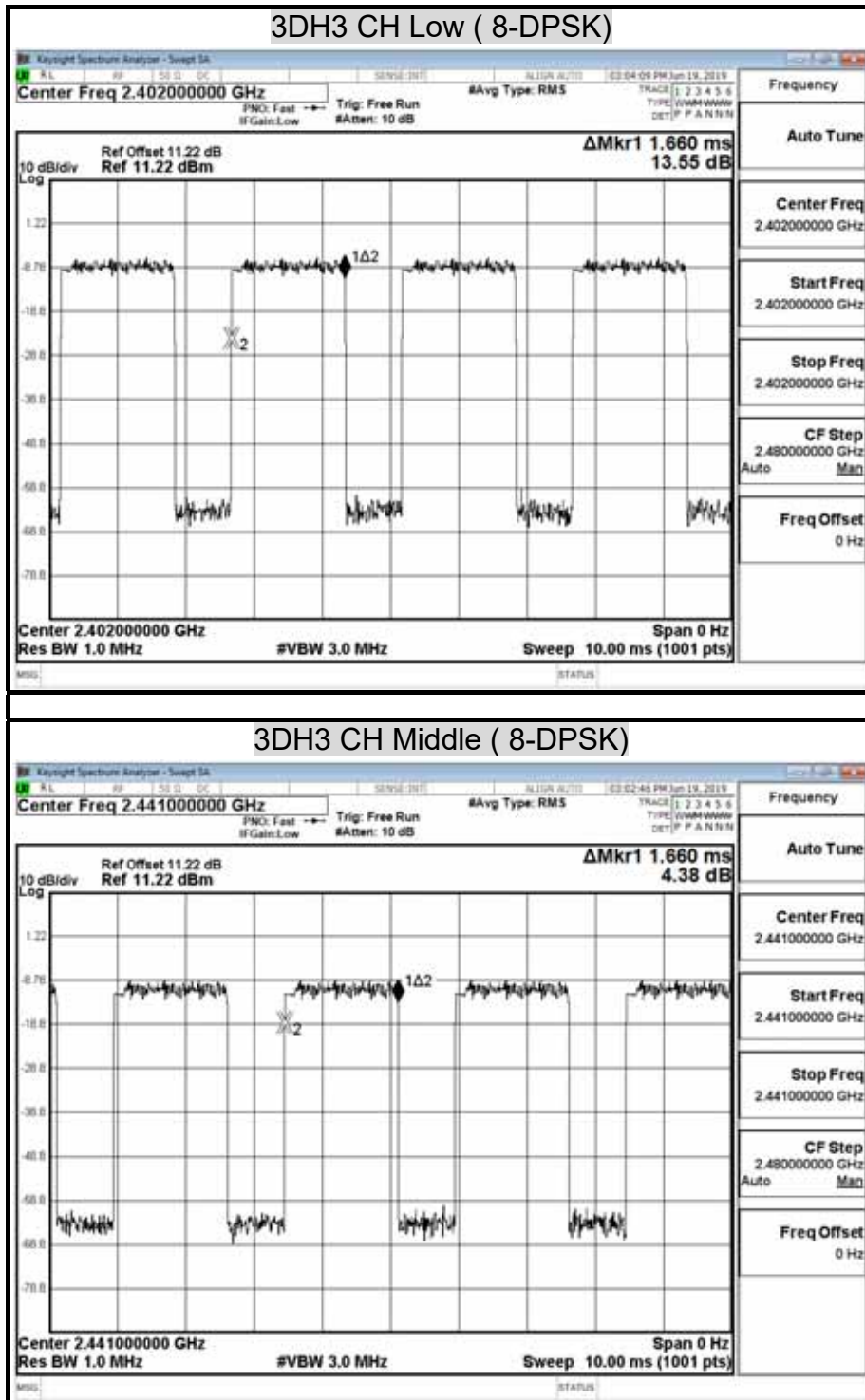

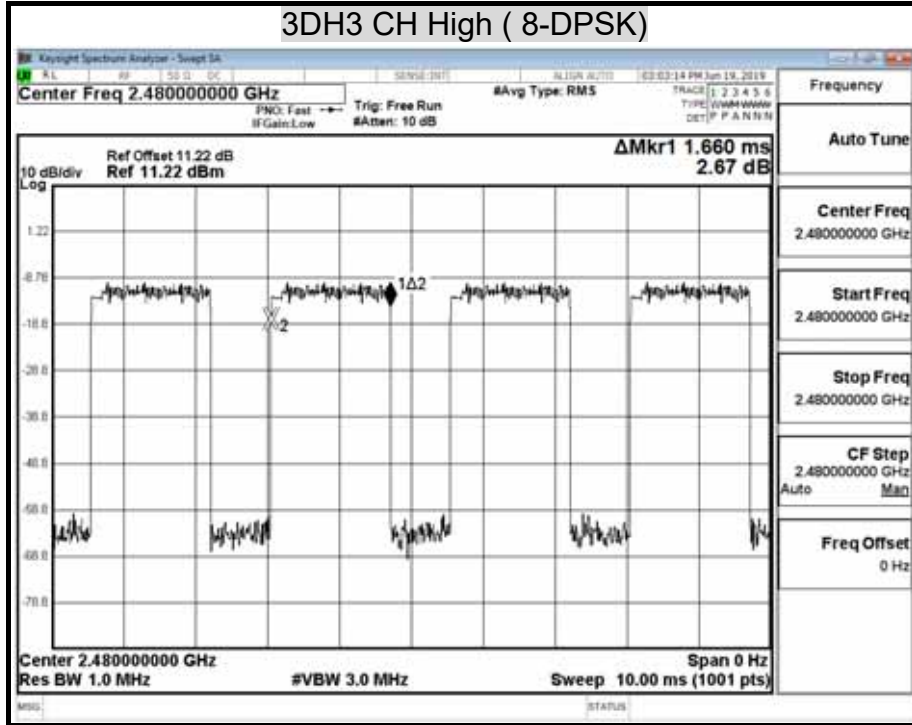

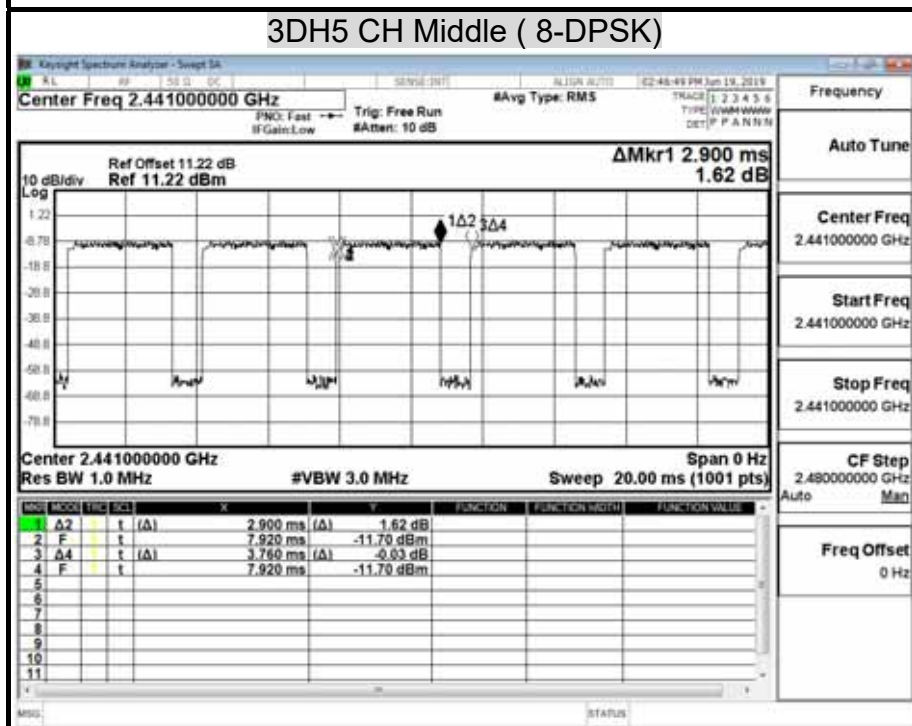
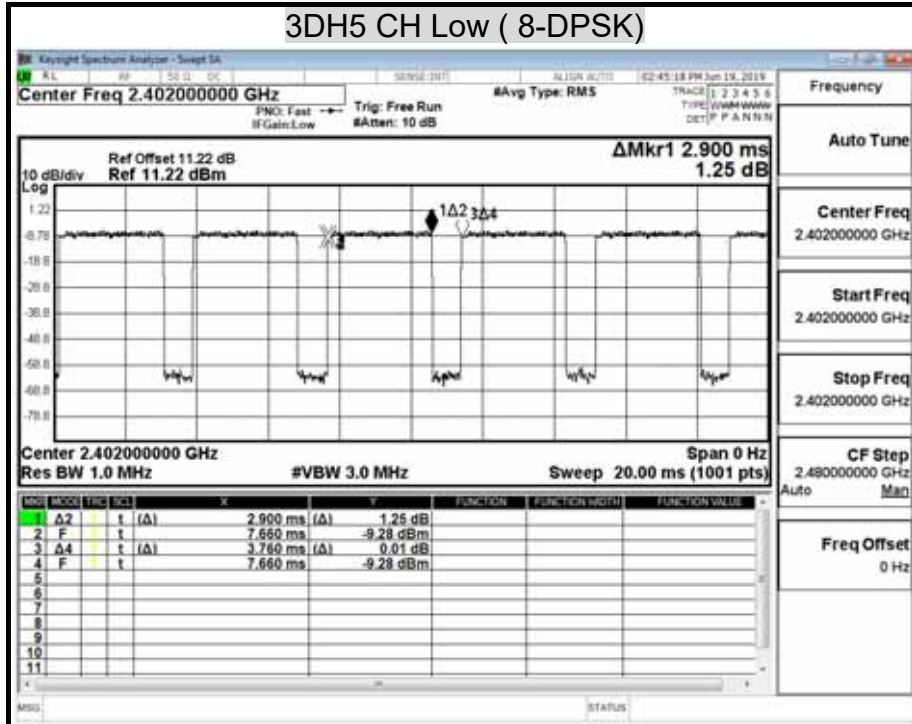

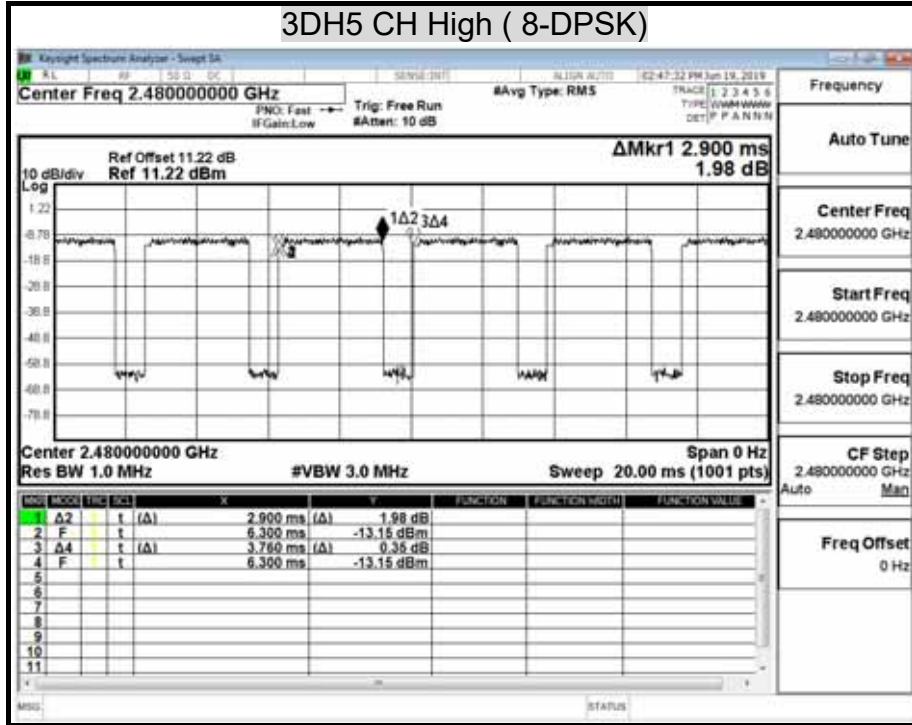

8.6 DUTY CYCLE

LIMIT

Nil (No dedicated limit specified in the Rules)

TEST SETUP

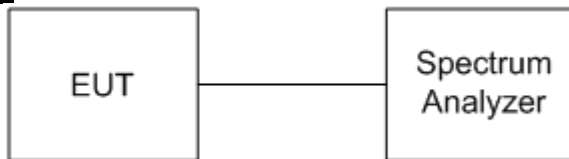

TEST PROCEDURE

1. Place the EUT on the table and set it in transmitting mode.
2. Remove the antenna from the EUT and then connect a low loss RF cable from the antenna port to the spectrum analyzer.
3. The zero-span mode on a spectrum analyzer or EMI receiver if the response time and spacing between bins on the sweep are sufficient to permit accurate measurements of the on and off times of the transmitted signal. Set the center frequency of the instrument to the center frequency of the transmission. Set $RBW \geq OBW$ if possible; otherwise, set RBW to the largest available value. Set $VBW \geq RBW$. Set detector = peak or average. The zero-span measurement method shall not be used unless both RBW and VBW are $> 50/T$ and the number of sweep points across duration T exceeds 100. (For example, if VBW and/or RBW are limited to 3 MHz, then the zero-span method of measuring duty cycle shall not be used if $T \leq 16.7$ microseconds.)

Report No.: T190605N02-RP1-1

TEST RESULTS

No non-compliance noted.

TEST DATA

| | | | |
|----------------------------|-----------------|------------------|------------|
| Model Name | AT-LP120XBT-USB | Test By | Ted Huang |
| Temp & Humidity | 26.2°C, 66% | Test Date | 2019/06/19 |

Modulation Type: GFSK / DH5

| | us | Times | Ton | Total Ton time(ms) |
|------|----------|-------|------|--------------------|
| Ton1 | 2900.000 | 1 | 2900 | |
| Ton2 | | 0 | 0 | |
| Ton3 | | | 0 | 2.9 |
| TP | | | | 3.76 |

| | |
|--------------|-------------|
| Ton | 2.9 |
| TP(Ton+Toff) | 3.76 |
| Duty Cycle | 0.771276596 |
| Duty Factor | 1.12789847 |

Modulation Type: 8-DPSK / 3-DH5

| | us | Times | Ton | Total Ton time(ms) |
|------|----------|-------|------|--------------------|
| Ton1 | 2900.000 | 1 | 2900 | |
| Ton2 | | 0 | 0 | |
| Ton3 | | | 0 | 2.9 |
| TP | | | | 3.76 |

| | |
|--------------|-------------|
| Ton | 2.9 |
| TP(Ton+Toff) | 3.76 |
| Duty Cycle | 0.771276596 |
| Duty Factor | 1.12789847 |

TEST PLOT

Duty Cycle

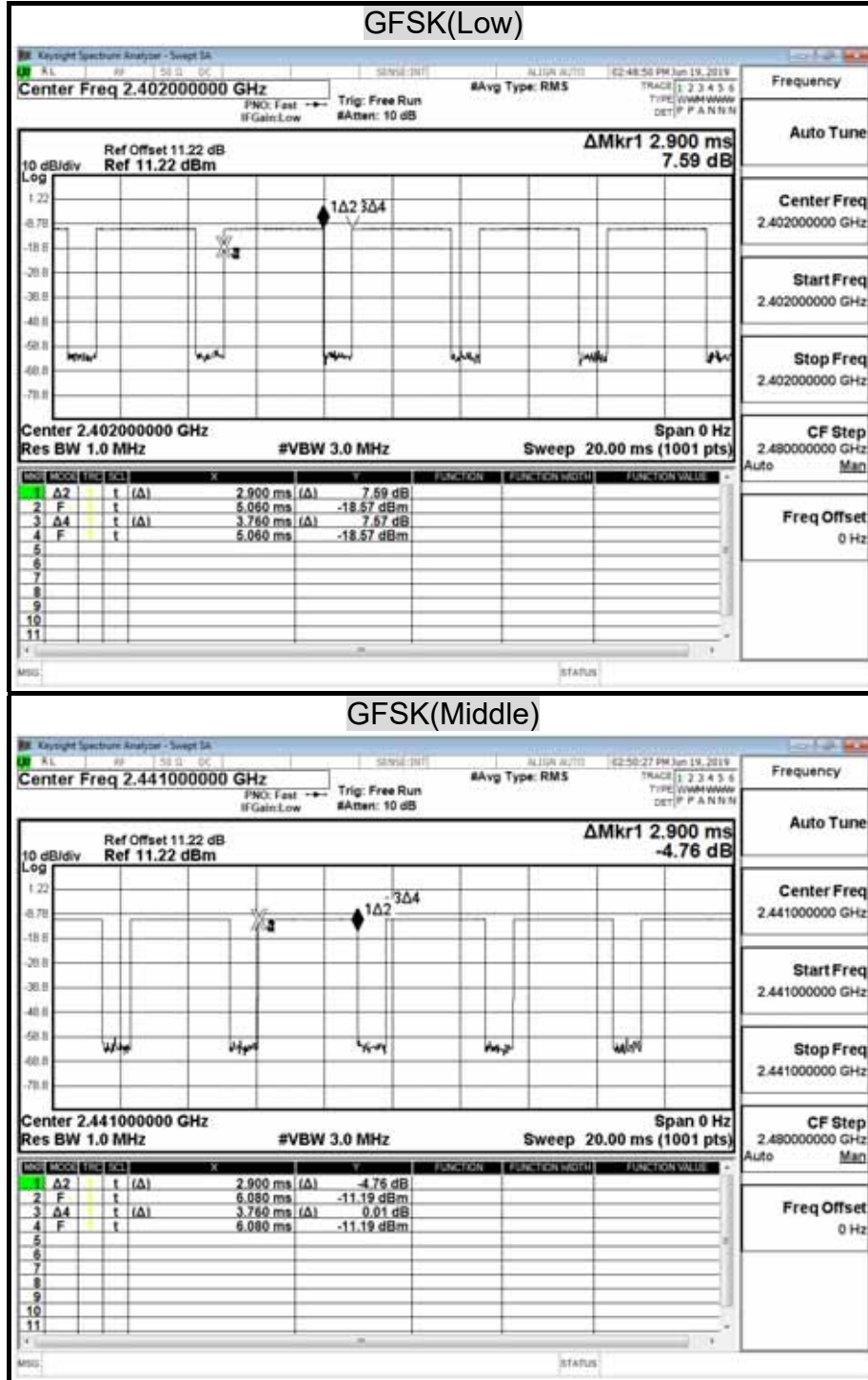

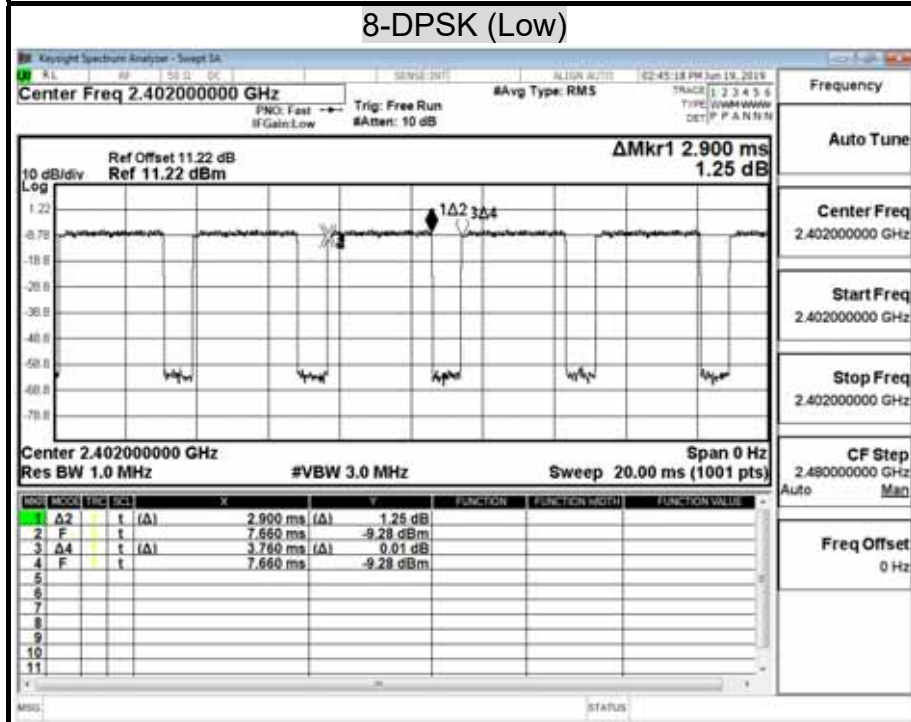
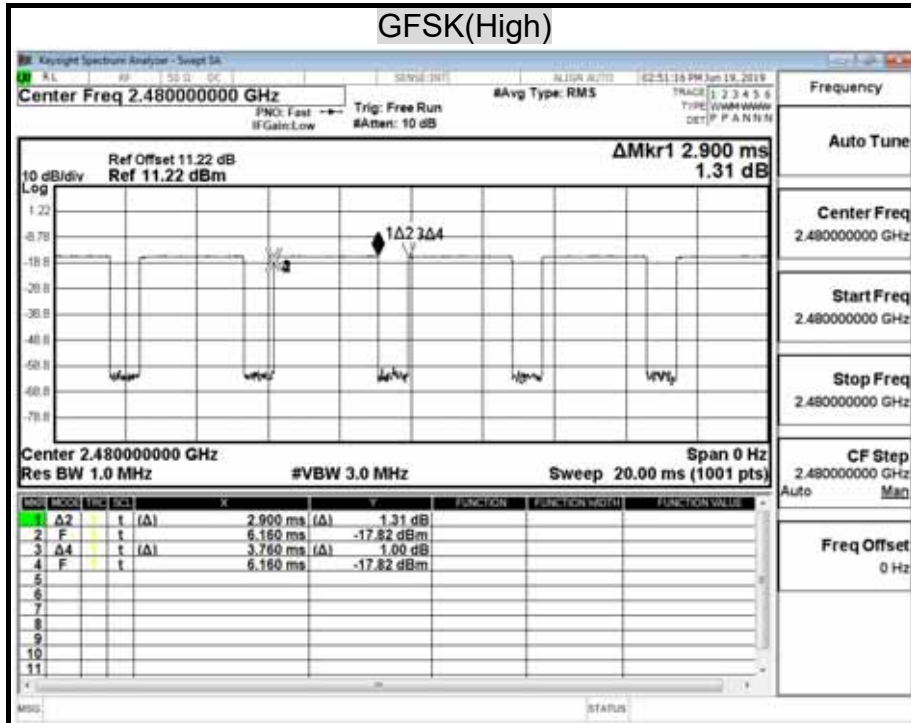

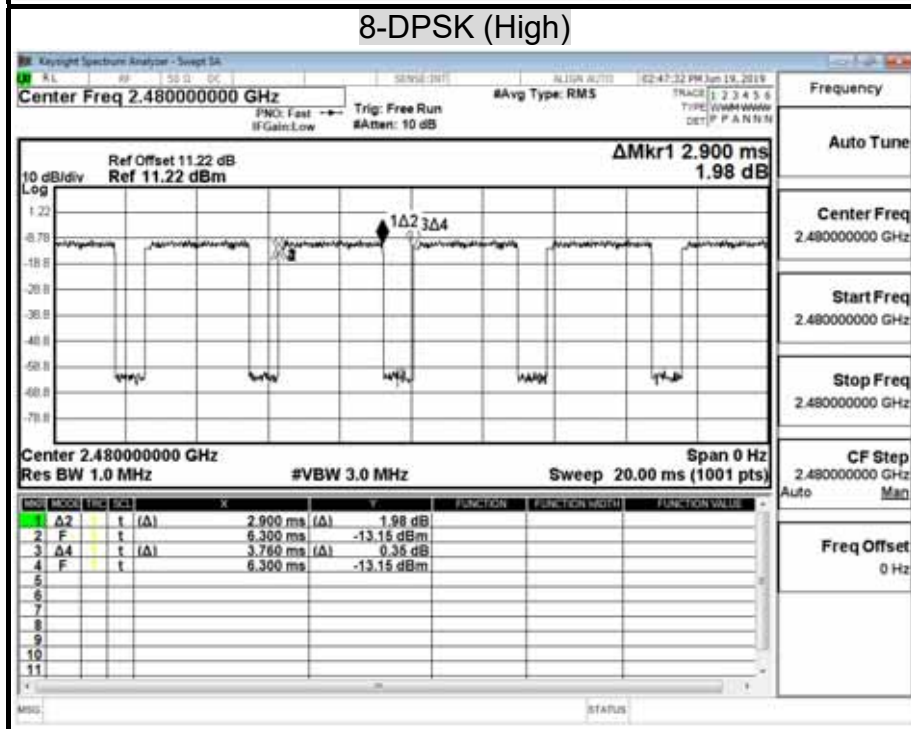
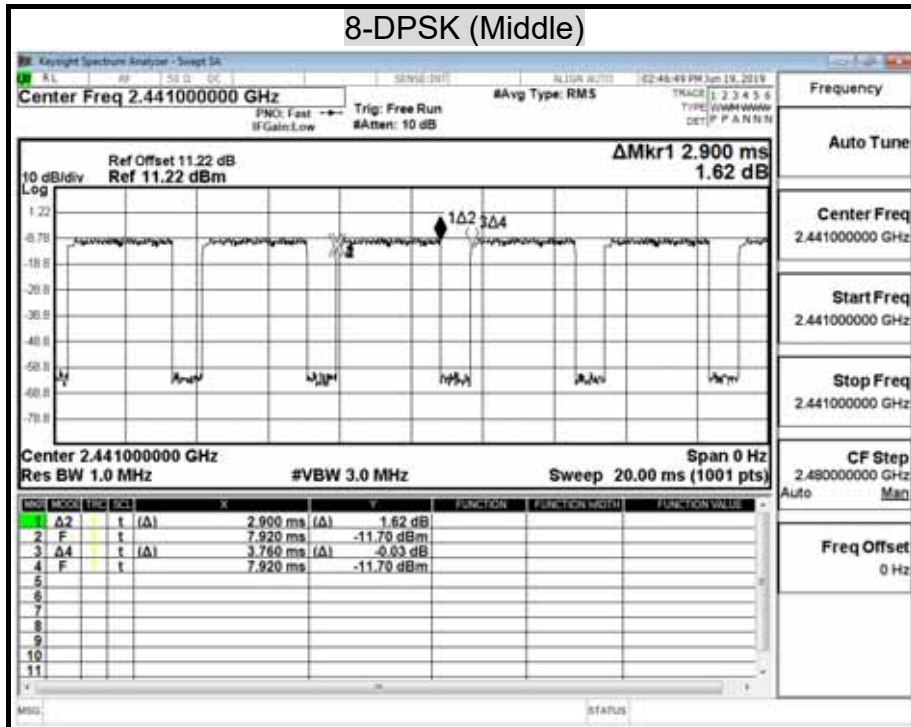

8.7 CONDUCTED SPURIOUS EMISSION

LIMITS

§ 15.247(d) In any 100 kHz bandwidth outside the frequency band in which the spread spectrum intentional radiator is operating, the radio frequency power that is produced by the intentional radiator shall be at least 20 dB below that in the 100 kHz bandwidth within the band and that contains the highest level of the desired power, based on either an RF conducted or a radiated measurement. Attenuation below the general limits specified in § 15.209(a) is not required. In addition, radiated emissions which fall in the restricted bands, as defined in § 15.205(a), must also comply with the radiated emission limits specified in § 15.209(a) (see § 15.205(c)).

TEST SETUP



TEST PROCEDURE

The transmitter output is connected to a spectrum analyzer. The resolution bandwidth is set to 100 kHz. The video bandwidth is set to 300 kHz.

The spectrum from 30 MHz to 26.5 GHz is investigated with the transmitter set to the lowest, middle, and highest channels in the 2.4 GHz band.

Report No.: T190605N02-RP1-1

TEST RESULTS

| | | | |
|----------------------------|-----------------|------------------|------------|
| Model Name | AT-LP120XBT-USB | Test By | Ted Huang |
| Temp & Humidity | 26.2°C, 66% | Test Date | 2019/06/19 |

OUT-OF-BAND SPURIOUS EMISSIONS-CONDUCTED MEASUREMENT
CH Low (30MHz ~ 26.5GHz / GFSK)

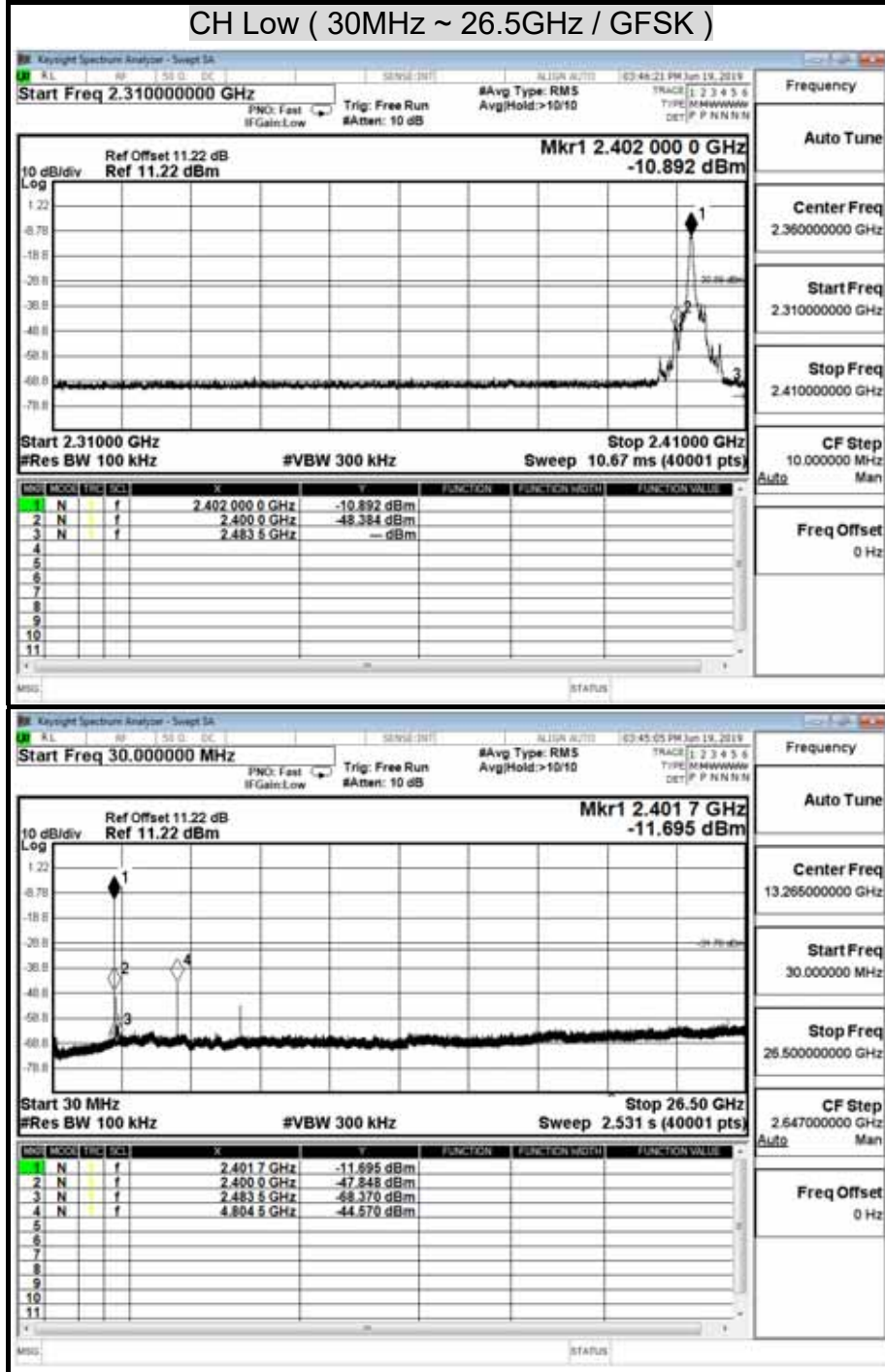

Report No.: T190605N02-RP1-1

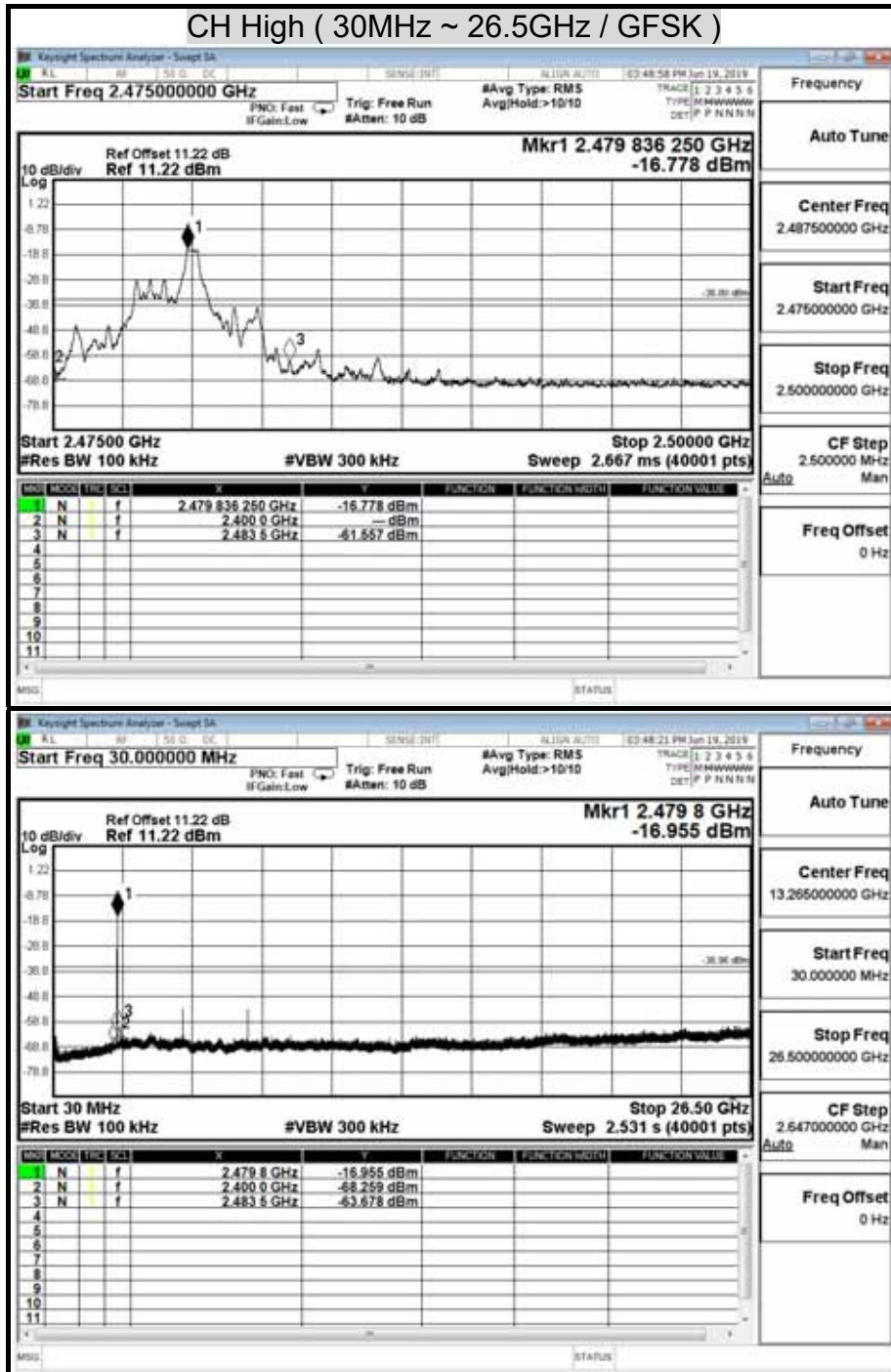

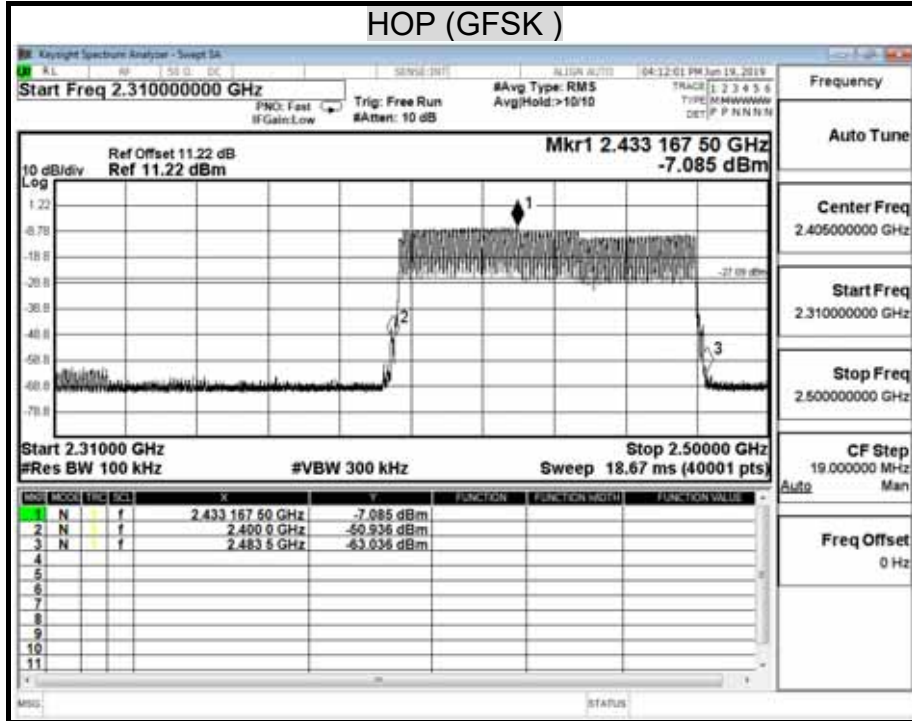

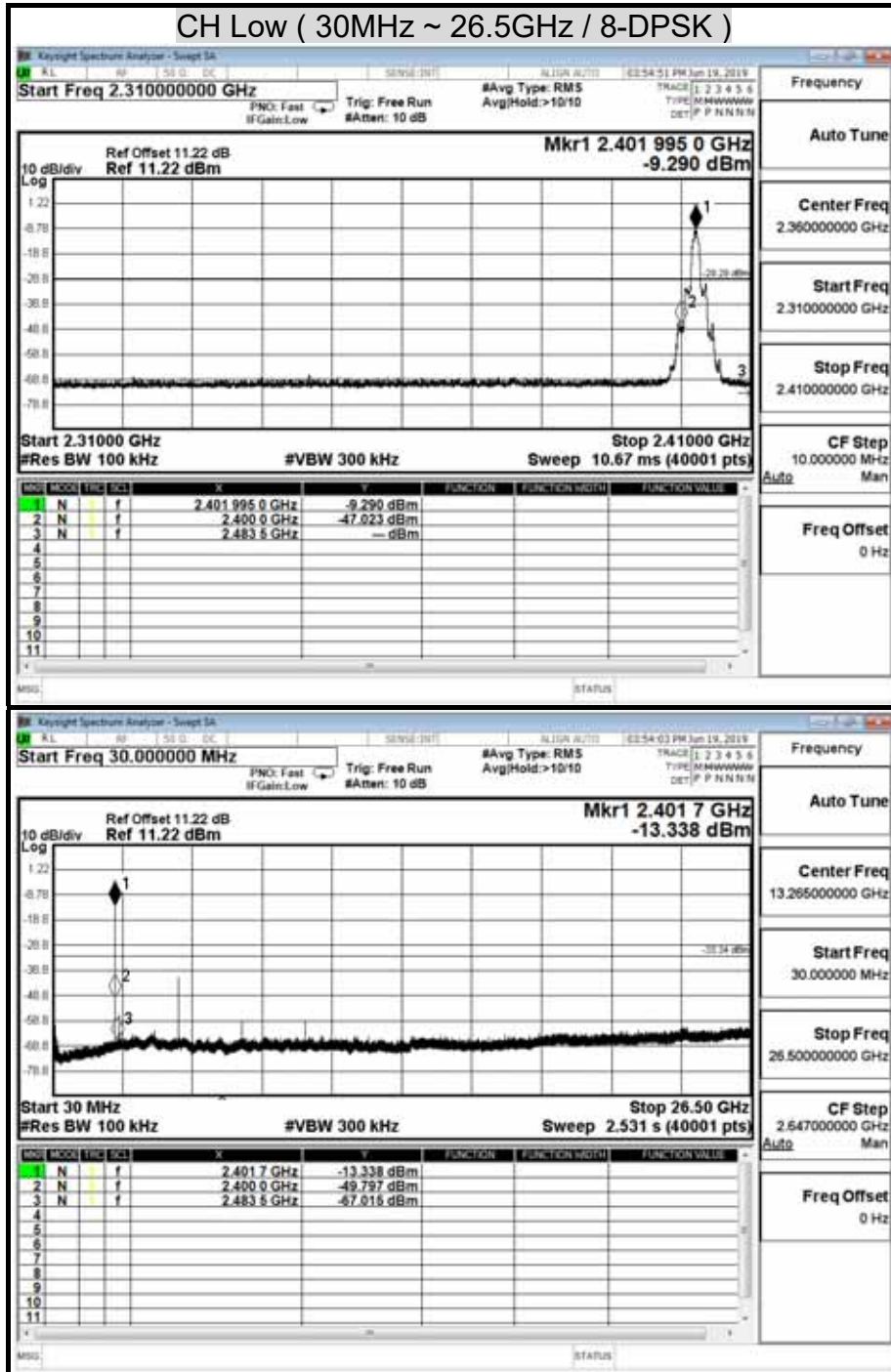

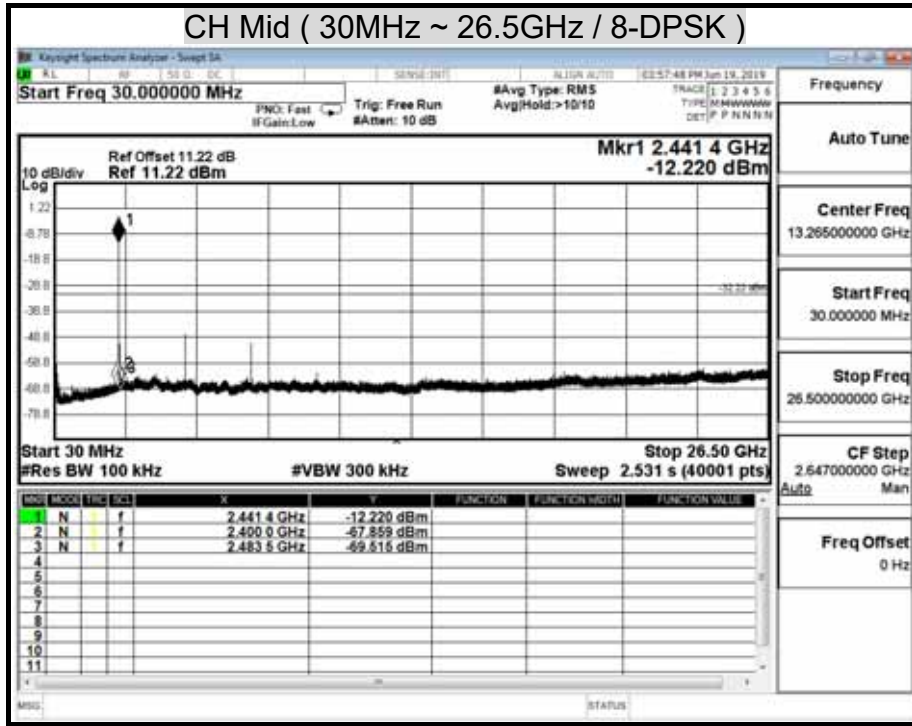

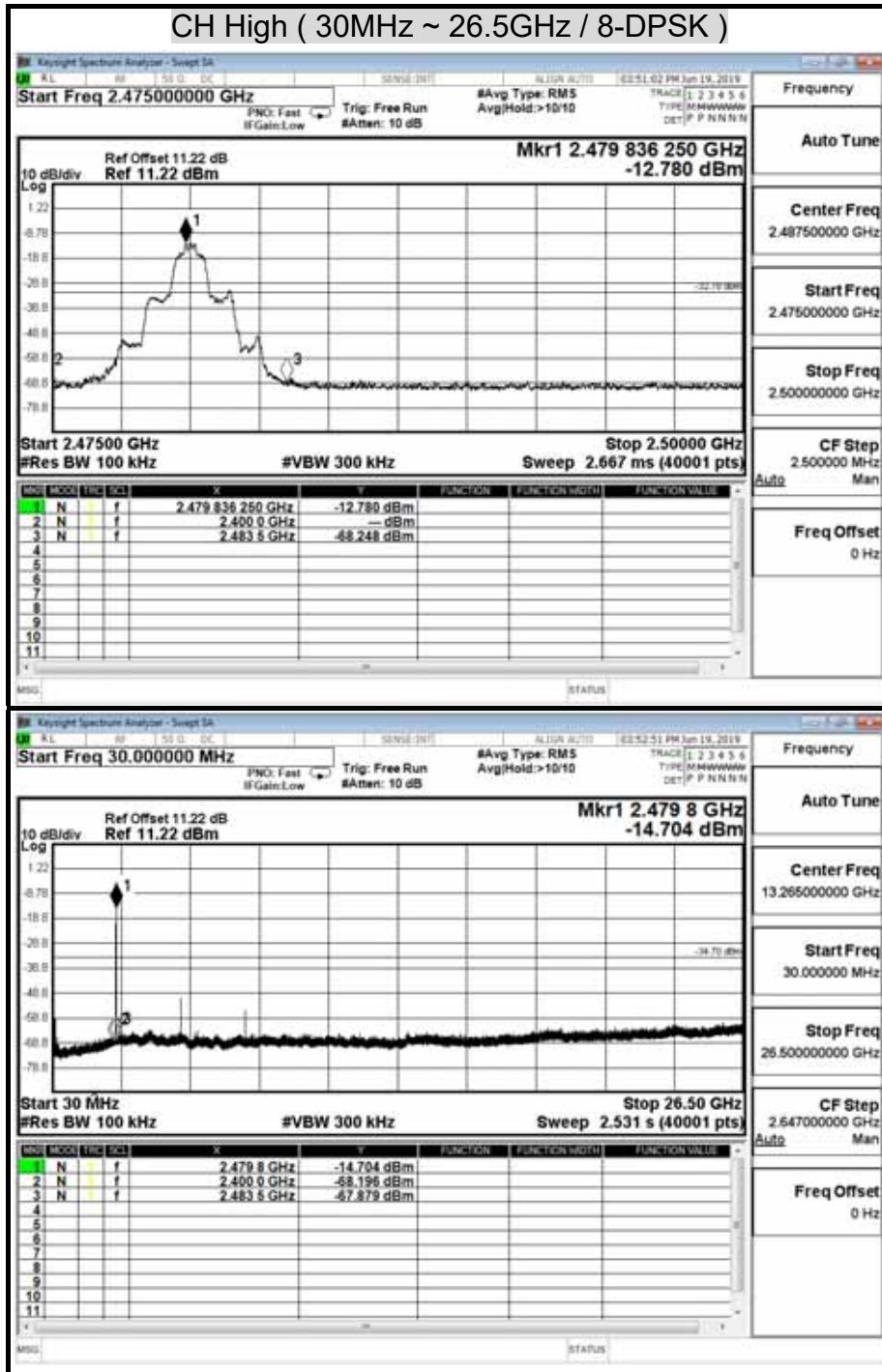

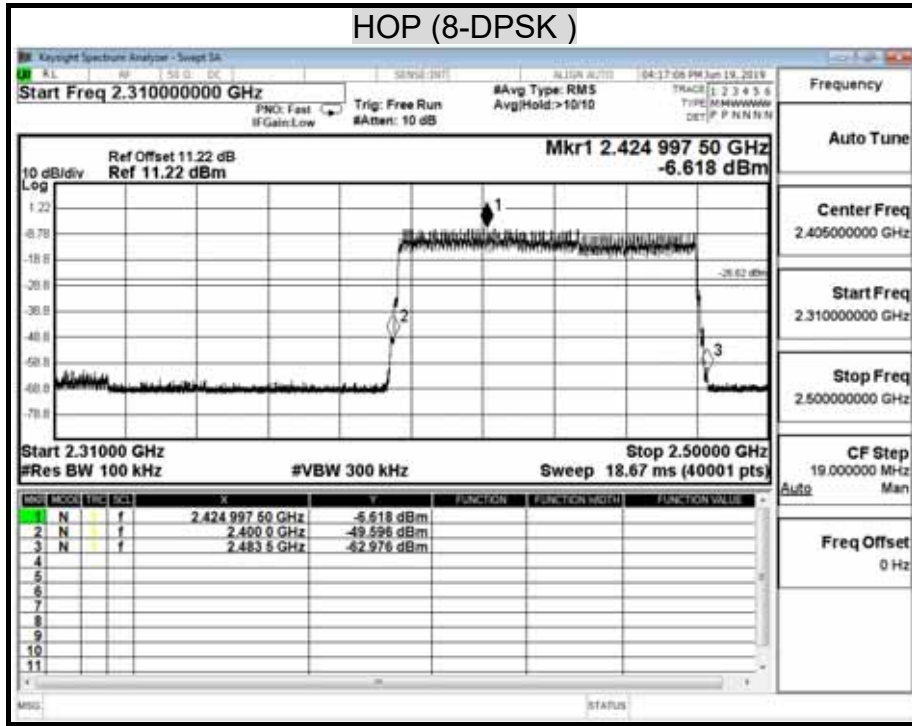

8.8 RADIATED EMISSIONS

8.8.1 TRANSMITTER RADIATED SUPURIOUS EMSSIONS

LIMITS

§ 15.205 (a) Except as shown in paragraph (d) of this section, only spurious emissions are permitted in any of the frequency bands listed below:

| MHz | MHz | MHz | GHz |
|---------------------|--------------------------|-----------------|------------------|
| 0.090 - 0.110 | 16.42 - 16.423 | 399.9 - 410 | 4.5 - 5.15 |
| 10.495 - 0.505 | 16.69475 - 16.69525 | 608 - 614 | 5.35 - 5.46 |
| 2.1735 - 2.1905 | 16.80425 - 16.80475 | 960 - 1240 | 7.25 - 7.75 |
| 4.125 - 4.128 | 25.5 - 25.67 | 1300 - 1427 | 8.025 - 8.5 |
| 4.17725 - 4.17775 | 37.5 - 38.25 | 1435 - 1626.5 | 9.0 - 9.2 |
| 4.20725 - 4.20775 | 73 - 74.6 | 1645.5 - 1646.5 | 9.3 - 9.5 |
| 6.215 - 6.218 | 74.8 - 75.2 | 1660 - 1710 | 10.6 - 12.7 |
| 6.26775 - 6.26825 | 108 - 121.94 | 1718.8 - 1722.2 | 13.25 - 13.4 |
| 6.31175 - 6.31225 | 123 - 138 | 2200 - 2300 | 14.47 - 14.5 |
| 8.291 - 8.294 | 149.9 - 150.05 | 2310 - 2390 | 15.35 - 16.2 |
| 8.362 - 8.366 | 156.52475 - 156.52525 | 2483.5 - 2500 | 17.7 - 21.4 |
| 8.37625 - 8.38675 | 156.7 - 156.9 | 2655 - 2900 | 22.01 - 23.12 |
| 8.41425 - 8.41475 | 162.0125 - 167.17 | 3260 - 3267 | 23.6 - 24.0 |
| 12.29 - 12.293 | 167.72 - 173.2 | 3332 - 3339 | 31.2 - 31.8 |
| 12.51975 - 12.52025 | 240 - 285 | 3345.8 - 3338 | 36.43 - 36.5 |
| 12.57675 - 12.57725 | 322 - 335.4 | 3600 - 4400 | (²) |
| 13.36 - 13.41 | | | |

¹ Until February 1, 1999, this restricted band shall be 0.490-0.510 MHz.

² Above 38.6

§ 15.205 (b) Except as provided in paragraphs (d) and (e), the field strength of emissions appearing within these frequency bands shall not exceed the limits shown in Section 15.209. At frequencies equal to or less than 1000 MHz, compliance with the limits in Section 15.209 shall be demonstrated using measurement instrumentation employing a CISPR quasi-peak detector. Above 1000 MHz, compliance with the emission limits in Section 15.209 shall be demonstrated based on the average value of the measured emissions. The provisions in Section 15.35 apply to these measurements.

Report No.: T190605N02-RP1-1

§ 15.209 (a) Except as provided elsewhere in this Subpart, the emissions from an intentional radiator shall not exceed the field strength levels specified in the following table :

| Frequency (MHz) | Field Strength (microvolts/meter) | Measurement Distance (meters) |
|------------------------|--|--------------------------------------|
| 30 - 88 | 100 ** | 3 |
| 88 - 216 | 150 ** | 3 |
| 216 - 960 | 200 ** | 3 |
| Above 960 | 500 | 3 |

** Except as provided in paragraph (g), fundamental emissions from intentional radiators operating under this Section shall not be located in the frequency bands 54-72 MHz, 76-88 MHz, 174-216 MHz or 470-806 MHz, However, operation within these frequency bands is permitted under other sections of this Part, e-g, Sections 15.231 and 15.241.

§ 15.209 (b) In the emission table above, the tighter limit applies at the band edges.

TEST SETUP

The diagram below shows the test setup that is utilized to make the measurements for emission from below 1GHz.

9kHz ~ 30MHz

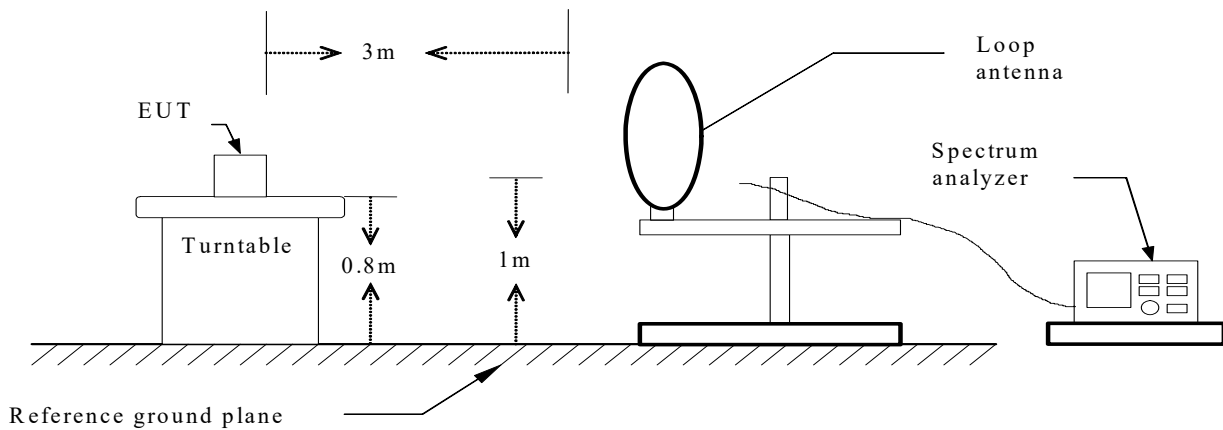

30MHz ~ 1GHz

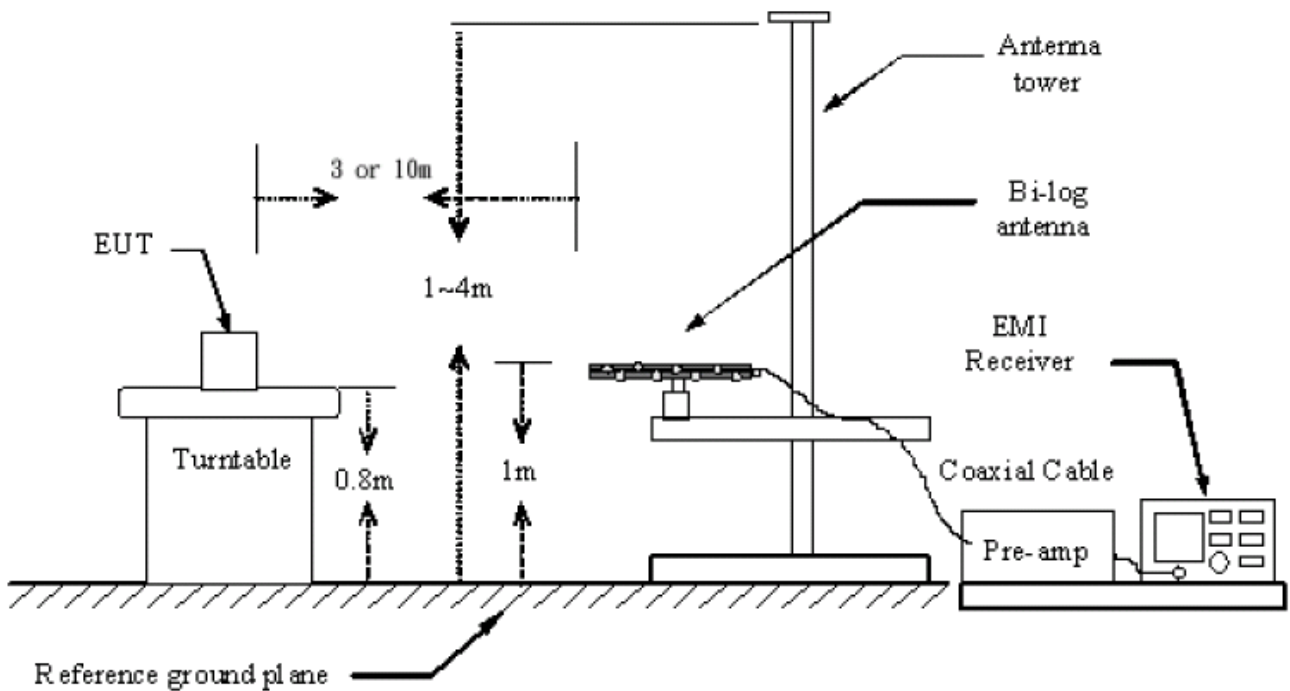

Report No.: T190605N02-RP1-1

The diagram below shows the test setup that is utilized to make the measurements for emission above 1GHz.

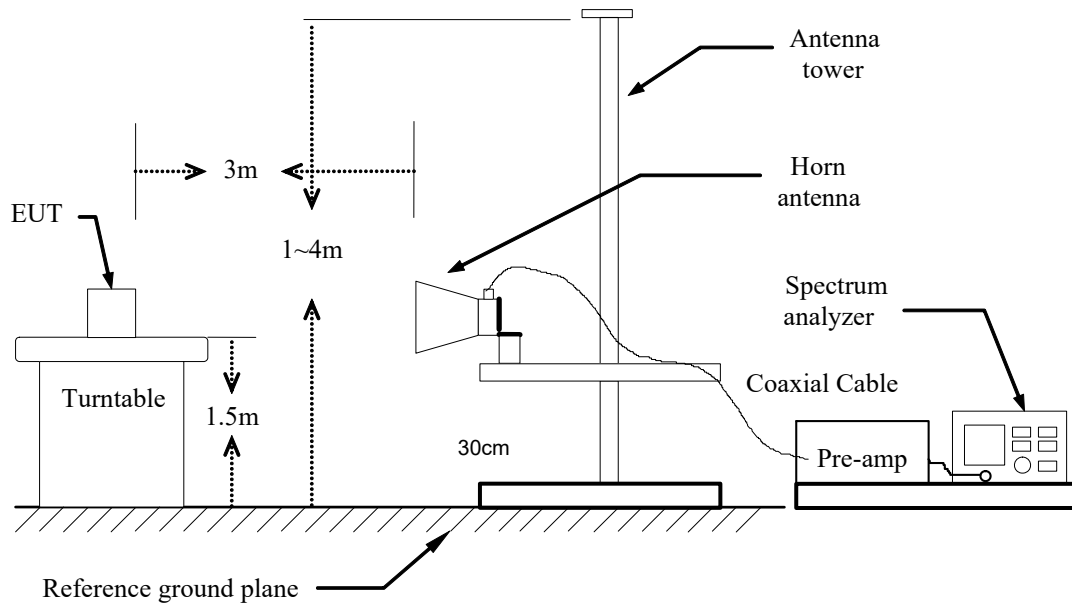

TEST PROCEDURE

- The EUT was placed on the top of a rotating table 0.8/1.5 meters above the ground at a 10/3 meter open site/chamber test site. The table was rotated 360 degrees to determine the position of the highest radiation.
- While measuring the radiated emission below 1GHz, the EUT was set 3 or 10 meters away from the interference-receiving antenna, which was mounted on the top of a variable-height antenna tower. While measuring the radiated emission above 1GHz, the EUT was set 3 or 10 meters away from the interference-receiving antenna.
- The antenna is a broadband antenna, and its height is varied from one meter to four meters above the ground to determine the maximum value of the field strength. Both horizontal and vertical polarization of the antenna are set to make the measurement.
- For each suspected emission, the EUT was arranged to its worst case and then the antenna was tuned to heights from 1 meter to 4 meters and the table was turned from 0 degrees to 360 degrees to find the maximum reading.
- The test-receiver system was set to Peak Detect Function and Specified Bandwidth with Maximum Hold Mode.
- If the emission level of the EUT in peak mode was 10 dB lower than the limit specified, then testing could be stopped and the peak values of the EUT would be reported. Otherwise the emissions that did not have 10 dB margin would be re-tested one by one using peak, quasi-peak or average method as specified and then reported in a data sheet.

Note :

- The resolution bandwidth and video bandwidth of test receiver/spectrum analyzer is 120 KHz for Peak detection (PK) and Quasi-peak detection (QP) at frequency below 1GHz.
- The resolution bandwidth and video bandwidth of test receiver/spectrum analyzer is 1 MHz for Peak detection and frequency above 1GHz.
- The resolution bandwidth of test receiver/spectrum analyzer is 1 MHz and the video bandwidth is 510 Hz for Average detection (AV) at frequency above 1GHz.

8.8.2 WORST-CASE RADIATED EMISSION BELOW 1 GHz

BELOW 1 GHz (9kHz ~ 30MHz)

No emission found between lowest internal used/generated frequency to 30MHz.

Report No.: T190605N02-RP1-1
BELOW 1 GHz (30MHz ~ 1GHz)

| | | | |
|---------------------|------------------------|----------------------------|-------------|
| Product Name | DIRECT DRIVE Turntable | Test Date | 2019/06/14 |
| Model Name | AT-LP120XBT-USB | Test By | Ted Huang |
| Test Mode | TX | Temp & Humidity | 26.5°C, 66% |

Vertical



Remark:

1. No emission found between lowest internal used/generated frequency to 30MHz (9kHz~30MHz).
2. Radiated emissions measured were made with an instrument using peak/quasi-peak detector mode.
3. Quasi-peak test would be performed if the peak result were greater than the quasi-peak limit or as required by the applicant.
4. Margin (dB) = Remark result (dBuV/m) – Quasi-peak limit (dBuV/m).

Report No.: T190605N02-RP1-1

| | | | |
|---------------------|------------------------|----------------------------|-------------|
| Product Name | DIRECT DRIVE Turntable | Test Date | 2019/06/14 |
| Model Name | AT-LP120XBT-USB | Test By | Ted Huang |
| Test Mode | TX | Temp & Humidity | 26.5°C, 66% |

Horizontal

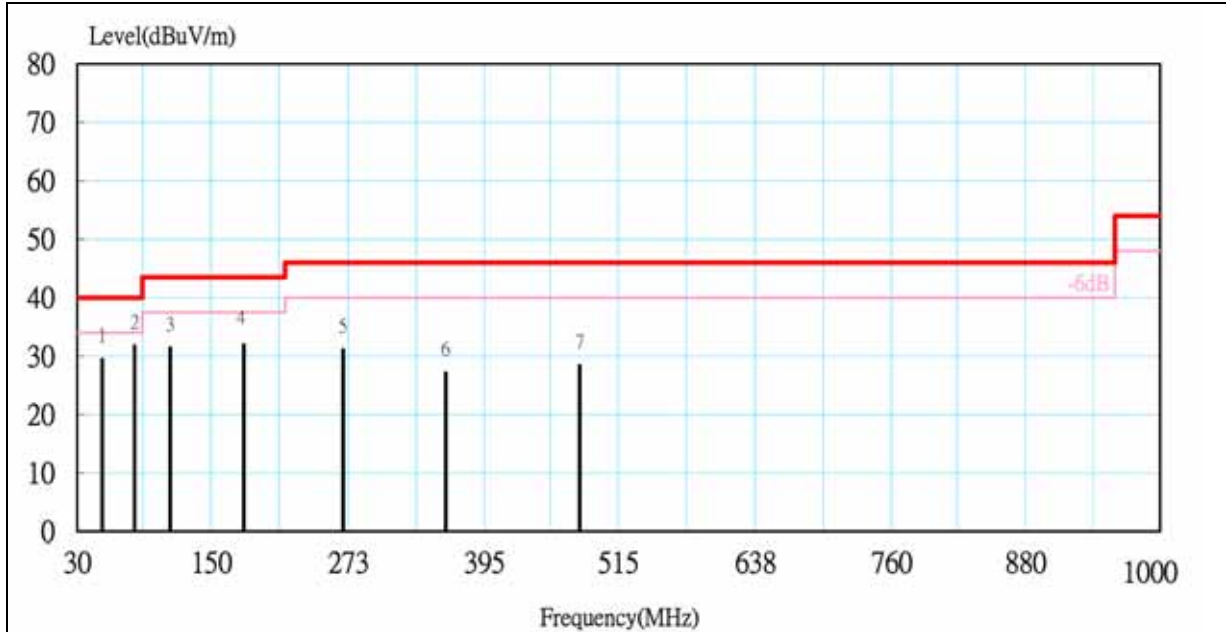

| No. | Freq- uency | Meter Reading at 3 m Level | Antenna Factor | Cable Loss | Emission at 3 m Level | Limits | Margin | Detector Mode |
|-----|----------------|-------------------------------|-------------------|---------------|--------------------------|----------|--------|------------------|
| | (MHz) | (dBμV) | (dB/m) | (dB) | (dBμV/m) | (dBμV/m) | (dB) | PK/QP |
| 1 | 52.38 | 20.12 | 8.43 | 0.95 | 29.51 | 40.00 | -10.49 | QP |
| 2 | 81.14 | 22.48 | 8.14 | 1.20 | 31.82 | 40.00 | -8.18 | QP |
| 3 | 113.80 | 16.45 | 13.49 | 1.50 | 31.45 | 43.50 | -12.05 | QP |
| 4 | 179.65 | 18.48 | 11.52 | 2.02 | 32.01 | 43.50 | -11.49 | QP |
| 5 | 268.45 | 15.33 | 13.05 | 2.77 | 31.15 | 46.00 | -14.85 | QP |
| 6 | 360.00 | 8.42 | 15.26 | 3.52 | 27.20 | 46.00 | -18.80 | QP |
| 7 | 480.00 | 6.44 | 17.62 | 4.37 | 28.43 | 46.00 | -17.57 | QP |

Remark:

1. No emission found between lowest internal used/generated frequency to 30MHz (9kHz~30MHz).
2. Radiated emissions measured were made with an instrument using peak/quasi-peak detector mode.
3. Quasi-peak test would be performed if the peak result were greater than the quasi-peak limit or as required by the applicant.
4. Margin (dB) = Remark result (dBuV/m) – Quasi-peak limit (dBuV/m).

8.8.3 TRANSMITTER RADIATED EMISSION ABOVE 1 GHz

| | | | |
|---------------------|------------------------|----------------------------|-------------|
| Product Name | DIRECT DRIVE Turntable | Test Date | 2019/06/19 |
| Model Name | AT-LP120XBT-USB | Test By | Ted Huang |
| Test Mode | CH Low TX / GFSK | Temp & Humidity | 26.2°C, 66% |

Horizontal

| TX mode / CH Low | | | | Measurement Distance at 3m | | | Horizontal polarity | | | |
|------------------|---------|--------|------------|----------------------------|--------|----------|---------------------|--------|---------|--|
| Freq. | Reading | AF | Cable Loss | Pre-amp | Filter | Level | Limit | Margin | Mark | |
| (MHz) | (dBμV) | (dB/m) | (dB) | (dB) | (dB) | (dBμV/m) | (dBμV/m) | (dB) | (P/Q/A) | |
| 1250.32 | 61.23 | 25.35 | 2.00 | 45.61 | 0.43 | 43.39 | 74.00 | -30.61 | P | |
| 1250.32 | 50.75 | 25.35 | 2.00 | 45.61 | 0.43 | 32.91 | 54.00 | -21.09 | A | |
| * 4804.05 | 62.85 | 33.23 | 4.10 | 44.36 | 0.22 | 56.05 | 74.00 | -17.95 | P | |
| * 4804.05 | 57.40 | 33.23 | 4.10 | 44.36 | 0.22 | 50.60 | 54.00 | -3.40 | A | |
| 7206.12 | 58.78 | 38.74 | 5.11 | 43.83 | 0.27 | 59.07 | 74.00 | -14.93 | P | |
| 7206.12 | 51.89 | 38.74 | 5.11 | 43.83 | 0.27 | 52.18 | 54.00 | -1.82 | A | |

Vertical

| TX mode / CH Low | | | | Measurement Distance at 3m | | | Vertical polarity | | | |
|------------------|---------|--------|------------|----------------------------|--------|----------|-------------------|--------|---------|--|
| Freq. | Reading | AF | Cable Loss | Pre-amp | Filter | Level | Limit | Margin | Mark | |
| (MHz) | (dBμV) | (dB/m) | (dB) | (dB) | (dB) | (dBμV/m) | (dBμV/m) | (dB) | (P/Q/A) | |
| * 1329.62 | 61.08 | 25.72 | 2.06 | 45.53 | 0.44 | 43.76 | 74.00 | -30.24 | P | |
| * 1329.62 | 50.46 | 25.72 | 2.06 | 45.53 | 0.44 | 33.14 | 54.00 | -20.86 | A | |
| * 4804.30 | 60.64 | 33.23 | 4.10 | 44.36 | 0.22 | 53.83 | 74.00 | -20.17 | P | |
| * 4804.30 | 56.19 | 33.23 | 4.10 | 44.36 | 0.22 | 49.39 | 54.00 | -4.61 | A | |
| 7206.14 | 57.34 | 38.74 | 5.11 | 43.83 | 0.27 | 57.63 | 74.00 | -16.37 | P | |
| 7206.14 | 49.46 | 38.74 | 5.11 | 43.83 | 0.27 | 49.75 | 54.00 | -4.25 | A | |

Remark:

1. AF: Antenna Factor, Cable: Cable Loss, Pre-Amp: Preamplifier gain, Filter: High Pass Filter Insertion Loss (3.5GHz)
2. Spectrum analyzer setting P(Peak): RBW=1MHz, VBW=1MHz, A(Average): RBW=1MHz, VBW=510Hz
3. The result basic equation calculation is as follow:
Level = Reading + AF + Cable – Preamp + Filter, Margin = Level-Limit
4. The other emission levels were 20dB below the limit
5. The test limit distance is 3M limit.
6. *=Restricted bands of operation

| | | | |
|---------------------|------------------------|----------------------------|-------------|
| Product Name | DIRECT DRIVE Turntable | Test Date | 2019/06/19 |
| Model Name | AT-LP120XBT-USB | Test By | Ted Huang |
| Test Mode | CH Mid TX / GFSK | Temp & Humidity | 26.2°C, 66% |

Horizontal

| TX mode / CH Mid | | | | Measurement Distance at 3m | | | Horizontal polarity | | | |
|------------------|---------|--------|------------|----------------------------|--------|----------|---------------------|--------|---------|--|
| Freq. | Reading | AF | Cable Loss | Pre-amp | Filter | Level | Limit | Margin | Mark | |
| (MHz) | (dBμV) | (dB/m) | (dB) | (dB) | (dB) | (dBμV/m) | (dBμV/m) | (dB) | (P/Q/A) | |
| 1250.25 | 60.88 | 25.35 | 2.00 | 45.61 | 0.43 | 43.04 | 74.00 | -30.96 | P | |
| 1250.25 | 50.38 | 25.35 | 2.00 | 45.61 | 0.43 | 32.54 | 54.00 | -21.46 | A | |
| * 4881.91 | 63.68 | 33.50 | 4.12 | 44.37 | 0.23 | 57.16 | 74.00 | -16.84 | P | |
| * 4881.91 | 59.06 | 33.50 | 4.12 | 44.37 | 0.23 | 52.54 | 54.00 | -1.46 | A | |
| * 7323.22 | 57.68 | 39.16 | 5.16 | 43.69 | 0.27 | 58.58 | 74.00 | -15.42 | P | |
| * 7323.22 | 50.89 | 39.16 | 5.16 | 43.69 | 0.27 | 51.79 | 54.00 | -2.21 | A | |

Vertical

| TX mode / CH Mid | | | | Measurement Distance at 3m | | | Vertical polarity | | | |
|------------------|---------|--------|------------|----------------------------|--------|----------|-------------------|--------|---------|--|
| Freq. | Reading | AF | Cable Loss | Pre-amp | Filter | Level | Limit | Margin | Mark | |
| (MHz) | (dBμV) | (dB/m) | (dB) | (dB) | (dB) | (dBμV/m) | (dBμV/m) | (dB) | (P/Q/A) | |
| * 1329.58 | 61.24 | 25.72 | 2.06 | 45.53 | 0.44 | 43.92 | 74.00 | -30.08 | P | |
| * 1329.58 | 50.67 | 25.72 | 2.06 | 45.53 | 0.44 | 33.35 | 54.00 | -20.65 | A | |
| * 4881.87 | 63.40 | 33.50 | 4.12 | 44.37 | 0.23 | 56.88 | 74.00 | -17.12 | P | |
| * 4881.87 | 59.39 | 33.50 | 4.12 | 44.37 | 0.23 | 52.87 | 54.00 | -1.13 | A | |
| * 7323.20 | 57.72 | 39.16 | 5.16 | 43.69 | 0.27 | 58.62 | 74.00 | -15.38 | P | |
| * 7323.20 | 50.30 | 39.16 | 5.16 | 43.69 | 0.27 | 51.20 | 54.00 | -2.80 | A | |

Remark:

1. AF: Antenna Factor, Cable: Cable Loss, Pre-Amp: Preamplifier gain, Filter: High Pass Filter Insertion Loss (3.5GHz)
2. Spectrum analyzer setting P(Peak): RBW=1MHz, VBW=1MHz, A(Average): RBW=1MHz, VBW=510Hz
3. The result basic equation calculation is as follow:
Level = Reading + AF + Cable – Preamp + Filter, Margin = Level-Limit
4. The other emission levels were 20dB below the limit
5. The test limit distance is 3M limit.
6. *=Restricted bands of operation

Report No.: T190605N02-RP1-1

| | | | |
|---------------------|------------------------|----------------------------|-------------|
| Product Name | DIRECT DRIVE Turntable | Test Date | 2019/06/19 |
| Model Name | AT-LP120XBT-USB | Test By | Ted Huang |
| Test Mode | CH High TX / GFSK | Temp & Humidity | 26.2°C, 66% |

Horizontal

| TX mode / CH High | | | | Measurement Distance at 3m | | | | Horizontal polarity | | |
|-------------------|---------|--------|------------|----------------------------|--------|----------|----------|---------------------|---------|--|
| Freq. | Reading | AF | Cable Loss | Pre-amp | Filter | Level | Limit | Margin | Mark | |
| (MHz) | (dBμV) | (dB/m) | (dB) | (dB) | (dB) | (dBμV/m) | (dBμV/m) | (dB) | (P/Q/A) | |
| 1250.28 | 61.42 | 25.35 | 2.00 | 45.61 | 0.43 | 43.58 | 74.00 | -30.42 | P | |
| 1250.28 | 50.88 | 25.35 | 2.00 | 45.61 | 0.43 | 33.04 | 54.00 | -20.96 | A | |
| * 4959.84 | 63.04 | 33.76 | 4.15 | 44.38 | 0.24 | 56.80 | 74.00 | -17.20 | P | |
| * 4959.84 | 58.81 | 33.76 | 4.15 | 44.38 | 0.24 | 52.57 | 54.00 | -1.43 | A | |
| * 7439.87 | 56.66 | 39.58 | 5.21 | 43.55 | 0.27 | 58.17 | 74.00 | -15.83 | P | |
| * 7439.87 | 49.13 | 39.58 | 5.21 | 43.55 | 0.27 | 50.64 | 54.00 | -3.36 | A | |

Vertical

| TX mode / CH High | | | | Measurement Distance at 3m | | | | Vertical polarity | | |
|-------------------|---------|--------|------------|----------------------------|--------|----------|----------|-------------------|---------|--|
| Freq. | Reading | AF | Cable Loss | Pre-amp | Filter | Level | Limit | Margin | Mark | |
| (MHz) | (dBμV) | (dB/m) | (dB) | (dB) | (dB) | (dBμV/m) | (dBμV/m) | (dB) | (P/Q/A) | |
| * 1329.70 | 61.24 | 25.72 | 2.06 | 45.53 | 0.44 | 43.93 | 74.00 | -30.07 | P | |
| * 1329.70 | 50.68 | 25.72 | 2.06 | 45.53 | 0.44 | 33.37 | 54.00 | -20.63 | A | |
| * 4959.91 | 63.50 | 33.76 | 4.15 | 44.38 | 0.24 | 57.26 | 74.00 | -16.74 | P | |
| * 4959.91 | 59.18 | 33.76 | 4.15 | 44.38 | 0.24 | 52.94 | 54.00 | -1.06 | A | |
| * 7439.88 | 57.38 | 39.58 | 5.21 | 43.55 | 0.27 | 58.89 | 74.00 | -15.11 | P | |
| * 7439.88 | 48.71 | 39.58 | 5.21 | 43.55 | 0.27 | 50.23 | 54.00 | -3.77 | A | |

Remark:

1. AF: Antenna Factor, Cable: Cable Loss, Pre-Amp: Preamplifier gain, Filter: High Pass Filter Insertion Loss (3.5GHz)
2. Spectrum analyzer setting P(Peak): RBW=1MHz, VBW=1MHz, A(Average): RBW=1MHz, VBW=510Hz
3. The result basic equation calculation is as follow:
Level = Reading + AF + Cable – Preamp + Filter, Margin = Level-Limit
4. The other emission levels were 20dB below the limit
5. The test limit distance is 3M limit.
6. *=Restricted bands of operation

| | | | |
|---------------------|------------------------|----------------------------|-------------|
| Product Name | DIRECT DRIVE Turntable | Test Date | 2019/06/19 |
| Model Name | AT-LP120XBT-USB | Test By | Ted Huang |
| Test Mode | CH Low TX / 8-DPSK | Temp & Humidity | 26.2°C, 66% |

Horizontal

| TX mode / CH Low | | | | Measurement Distance at 3m | | | | Horizontal polarity | | |
|------------------|---------|--------|------------|----------------------------|--------|----------|----------|---------------------|---------|--|
| Freq. | Reading | AF | Cable Loss | Pre-amp | Filter | Level | Limit | Margin | Mark | |
| (MHz) | (dBμV) | (dB/m) | (dB) | (dB) | (dB) | (dBμV/m) | (dBμV/m) | (dB) | (P/Q/A) | |
| 1250.33 | 60.84 | 25.35 | 2.00 | 45.61 | 0.43 | 43.00 | 74.00 | -31.00 | P | |
| 1250.33 | 50.26 | 25.35 | 2.00 | 45.61 | 0.43 | 32.42 | 54.00 | -21.58 | A | |
| * 4803.98 | 64.77 | 33.23 | 4.10 | 44.36 | 0.22 | 57.96 | 74.00 | -16.04 | P | |
| * 4803.98 | 59.47 | 33.23 | 4.10 | 44.36 | 0.22 | 52.67 | 54.00 | -1.33 | A | |
| 7206.03 | 58.95 | 38.74 | 5.11 | 43.83 | 0.27 | 59.25 | 74.00 | -14.75 | P | |
| 7206.03 | 51.61 | 38.74 | 5.11 | 43.83 | 0.27 | 51.90 | 54.00 | -2.10 | A | |

Vertical

| TX mode / CH Low | | | | Measurement Distance at 3m | | | | Vertical polarity | | |
|------------------|---------|--------|------------|----------------------------|--------|----------|----------|-------------------|---------|--|
| Freq. | Reading | AF | Cable Loss | Pre-amp | Filter | Level | Limit | Margin | Mark | |
| (MHz) | (dBμV) | (dB/m) | (dB) | (dB) | (dB) | (dBμV/m) | (dBμV/m) | (dB) | (P/Q/A) | |
| * 1329.54 | 61.08 | 25.72 | 2.06 | 45.53 | 0.44 | 43.76 | 74.00 | -30.24 | P | |
| * 1329.54 | 50.56 | 25.72 | 2.06 | 45.53 | 0.44 | 33.24 | 54.00 | -20.76 | A | |
| * 4804.07 | 63.75 | 33.23 | 4.10 | 44.36 | 0.22 | 56.94 | 74.00 | -17.06 | P | |
| * 4804.07 | 58.82 | 33.23 | 4.10 | 44.36 | 0.22 | 52.02 | 54.00 | -1.98 | A | |
| 7206.15 | 58.12 | 38.74 | 5.11 | 43.83 | 0.27 | 58.41 | 74.00 | -15.59 | P | |
| 7206.15 | 50.65 | 38.74 | 5.11 | 43.83 | 0.27 | 50.94 | 54.00 | -3.06 | A | |

Remark:

1. AF: Antenna Factor, Cable: Cable Loss, Pre-Amp: Preamplifier gain, Filter: High Pass Filter Insertion Loss (3.5GHz)
2. Spectrum analyzer setting P(Peak): RBW=1MHz, VBW=1MHz, A(Average): RBW=1MHz, VBW=510Hz
3. The result basic equation calculation is as follow:
Level = Reading + AF + Cable – Preamp + Filter, Margin = Level-Limit
4. The other emission levels were 20dB below the limit
5. The test limit distance is 3M limit.
6. *=Restricted bands of operation

| | | | |
|---------------------|------------------------|----------------------------|-------------|
| Product Name | DIRECT DRIVE Turntable | Test Date | 2019/06/19 |
| Model Name | AT-LP120XBT-USB | Test By | Ted Huang |
| Test Mode | CH Mid TX / 8-DPSK | Temp & Humidity | 26.2°C, 66% |

Horizontal

| TX mode / CH Mid | | | | Measurement Distance at 3m | | | | Horizontal polarity | | |
|------------------|---------|--------|------------|----------------------------|--------|----------|----------|---------------------|---------|--|
| Freq. | Reading | AF | Cable Loss | Pre-amp | Filter | Level | Limit | Margin | Mark | |
| (MHz) | (dBμV) | (dB/m) | (dB) | (dB) | (dB) | (dBμV/m) | (dBμV/m) | (dB) | (P/Q/A) | |
| 1250.34 | 61.28 | 25.35 | 2.00 | 45.61 | 0.43 | 43.44 | 74.00 | -30.56 | P | |
| 1250.34 | 50.74 | 25.35 | 2.00 | 45.61 | 0.43 | 32.90 | 54.00 | -21.10 | A | |
| * 4882.05 | 64.05 | 33.50 | 4.12 | 44.37 | 0.23 | 57.53 | 74.00 | -16.47 | P | |
| * 4882.05 | 58.14 | 33.50 | 4.12 | 44.37 | 0.23 | 51.62 | 54.00 | -2.38 | A | |
| * 7323.07 | 58.24 | 39.16 | 5.16 | 43.69 | 0.27 | 59.14 | 74.00 | -14.86 | P | |
| * 7323.07 | 50.48 | 39.16 | 5.16 | 43.69 | 0.27 | 51.39 | 54.00 | -2.61 | A | |

Vertical

| TX mode / CH Mid | | | | Measurement Distance at 3m | | | | Vertical polarity | | |
|------------------|---------|--------|------------|----------------------------|--------|----------|----------|-------------------|---------|--|
| Freq. | Reading | AF | Cable Loss | Pre-amp | Filter | Level | Limit | Margin | Mark | |
| (MHz) | (dBμV) | (dB/m) | (dB) | (dB) | (dB) | (dBμV/m) | (dBμV/m) | (dB) | (P/Q/A) | |
| * 1329.82 | 61.56 | 25.72 | 2.06 | 45.53 | 0.44 | 44.25 | 74.00 | -29.75 | P | |
| * 1329.82 | 50.76 | 25.72 | 2.06 | 45.53 | 0.44 | 33.45 | 54.00 | -20.55 | A | |
| * 4882.09 | 64.35 | 33.50 | 4.12 | 44.37 | 0.23 | 57.83 | 74.00 | -16.17 | P | |
| * 4882.09 | 58.65 | 33.50 | 4.12 | 44.37 | 0.23 | 52.13 | 54.00 | -1.87 | A | |
| * 7322.83 | 57.72 | 39.16 | 5.16 | 43.69 | 0.27 | 58.62 | 74.00 | -15.38 | P | |
| * 7322.83 | 49.87 | 39.16 | 5.16 | 43.69 | 0.27 | 50.77 | 54.00 | -3.23 | A | |

Remark:

1. AF: Antenna Factor, Cable: Cable Loss, Pre-Amp: Preamplifier gain, Filter: High Pass Filter Insertion Loss (3.5GHz)
2. Spectrum analyzer setting P(Peak): RBW=1MHz, VBW=1MHz, A(Average): RBW=1MHz, VBW=510Hz
3. The result basic equation calculation is as follow:
Level = Reading + AF + Cable – Preamp + Filter, Margin = Level-Limit
4. The other emission levels were 20dB below the limit
5. The test limit distance is 3M limit.
6. *=Restricted bands of operation

| | | | |
|---------------------|------------------------|----------------------------|-------------|
| Product Name | DIRECT DRIVE Turntable | Test Date | 2019/06/19 |
| Model Name | AT-LP120XBT-USB | Test By | Ted Huang |
| Test Mode | CH High TX / 8-DPSK | Temp & Humidity | 26.2°C, 66% |

Horizontal

| TX mode / CH High | | | | Measurement Distance at 3m | | | | Horizontal polarity | | |
|-------------------|---------|--------|------------|----------------------------|--------|----------|----------|---------------------|---------|--|
| Freq. | Reading | AF | Cable Loss | Pre-amp | Filter | Level | Limit | Margin | Mark | |
| (MHz) | (dBμV) | (dB/m) | (dB) | (dB) | (dB) | (dBμV/m) | (dBμV/m) | (dB) | (P/Q/A) | |
| 1250.30 | 61.34 | 25.35 | 2.00 | 45.61 | 0.43 | 43.50 | 74.00 | -30.50 | P | |
| 1250.30 | 50.86 | 25.35 | 2.00 | 45.61 | 0.43 | 33.02 | 54.00 | -20.98 | A | |
| * 4960.05 | 62.92 | 33.76 | 4.15 | 44.38 | 0.24 | 56.68 | 74.00 | -17.32 | P | |
| * 4960.05 | 58.97 | 33.76 | 4.15 | 44.38 | 0.24 | 52.74 | 54.00 | -1.26 | A | |
| * 7440.13 | 55.97 | 39.58 | 5.21 | 43.55 | 0.27 | 57.48 | 74.00 | -16.52 | P | |
| * 7440.13 | 48.78 | 39.58 | 5.21 | 43.55 | 0.27 | 50.29 | 54.00 | -3.71 | A | |

Vertical

| TX mode / CH High | | | | Measurement Distance at 3m | | | | Vertical polarity | | |
|-------------------|---------|--------|------------|----------------------------|--------|----------|----------|-------------------|---------|--|
| Freq. | Reading | AF | Cable Loss | Pre-amp | Filter | Level | Limit | Margin | Mark | |
| (MHz) | (dBμV) | (dB/m) | (dB) | (dB) | (dB) | (dBμV/m) | (dBμV/m) | (dB) | (P/Q/A) | |
| * 1329.66 | 61.25 | 25.72 | 2.06 | 45.53 | 0.44 | 43.94 | 74.00 | -30.06 | P | |
| * 1329.66 | 50.58 | 25.72 | 2.06 | 45.53 | 0.44 | 33.27 | 54.00 | -20.73 | A | |
| * 4960.10 | 64.96 | 33.76 | 4.15 | 44.38 | 0.24 | 58.72 | 74.00 | -15.28 | P | |
| * 4960.10 | 58.47 | 33.76 | 4.15 | 44.38 | 0.24 | 52.23 | 54.00 | -1.77 | A | |
| * 7439.91 | 57.11 | 39.58 | 5.21 | 43.55 | 0.27 | 58.62 | 74.00 | -15.38 | P | |
| * 7439.91 | 47.96 | 39.58 | 5.21 | 43.55 | 0.27 | 49.47 | 54.00 | -4.53 | A | |

Remark:

1. AF: Antenna Factor, Cable: Cable Loss, Pre-Amp: Preamplifier gain, Filter: High Pass Filter Insertion Loss (3.5GHz)
2. Spectrum analyzer setting P(Peak): RBW=1MHz, VBW=1MHz, A(Average): RBW=1MHz, VBW=510Hz
3. The result basic equation calculation is as follow:
Level = Reading + AF + Cable – Preamp + Filter, Margin = Level-Limit
4. The other emission levels were 20dB below the limit
5. The test limit distance is 3M limit.
6. *=Restricted bands of operation

8.8.4 RESTRICTED BAND EDGES

| | | | |
|----------------------------|-----------------|------------------|------------|
| Model Name | AT-LP120XBT-USB | Test By | Ted Huang |
| Temp & Humidity | 26.2°C, 66% | Test Date | 2019/06/19 |

Detector Mode : Peak **Polarity : Horizontal**

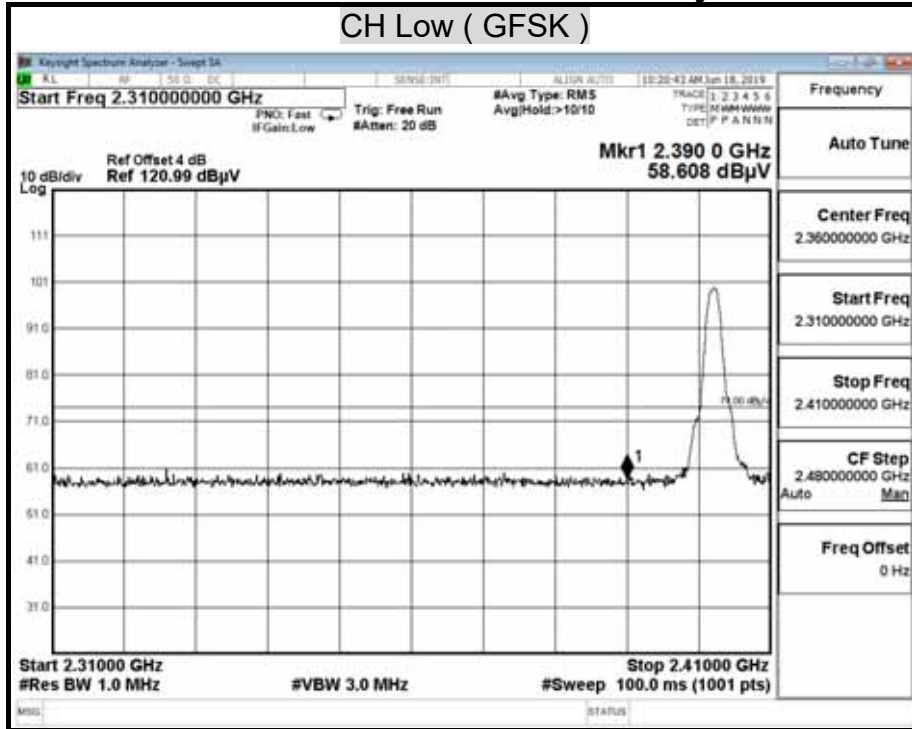

Detector Mode : Average **Polarity : Horizontal**

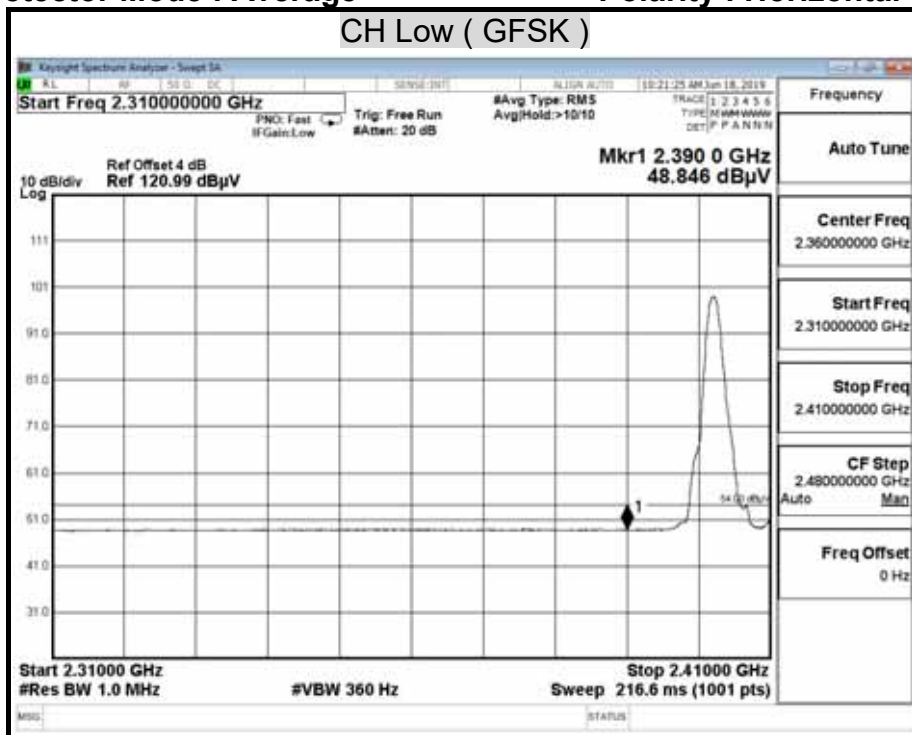

Detector Mode : Peak

Polarity : Vertical

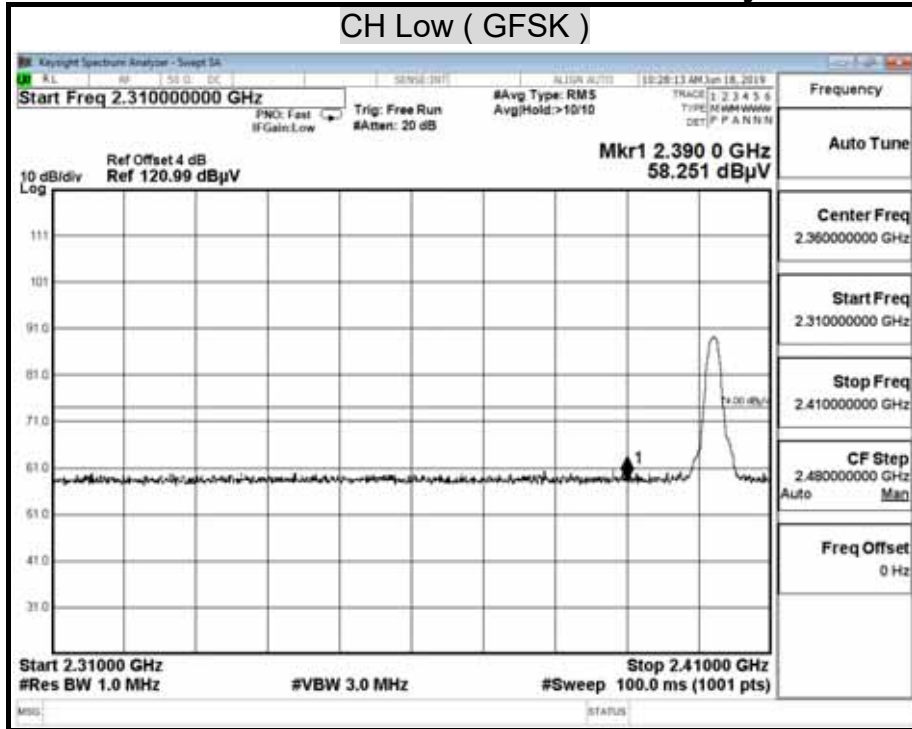

Detector Mode : Average

Polarity : Vertical

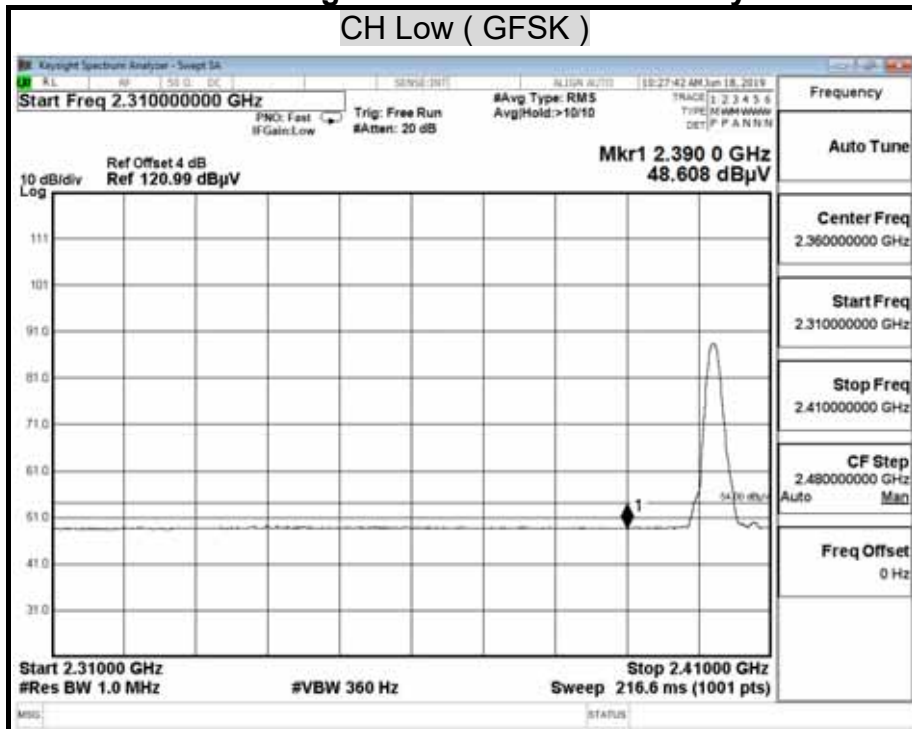

Detector Mode : Peak **Polarity : Horizontal**

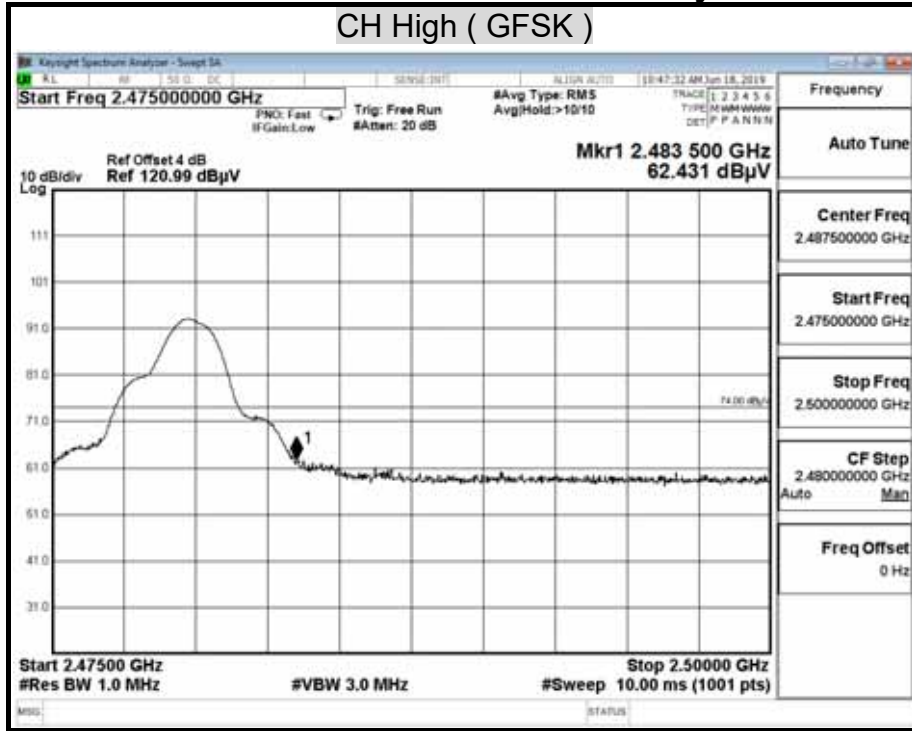

Detector Mode : Average **Polarity : Horizontal**

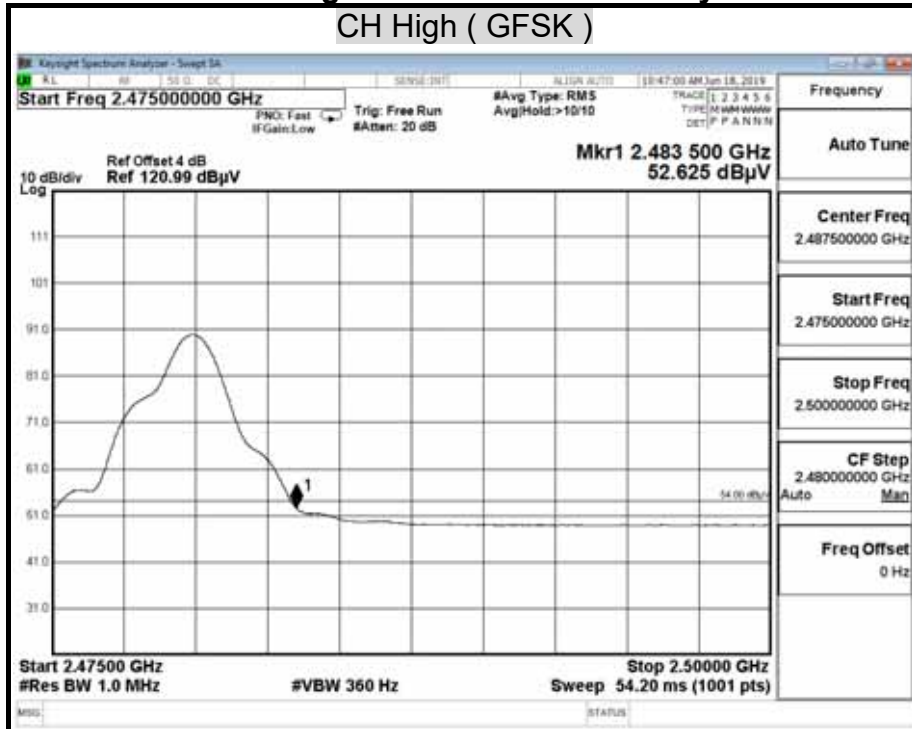

Detector Mode : Peak

Polarity : Vertical

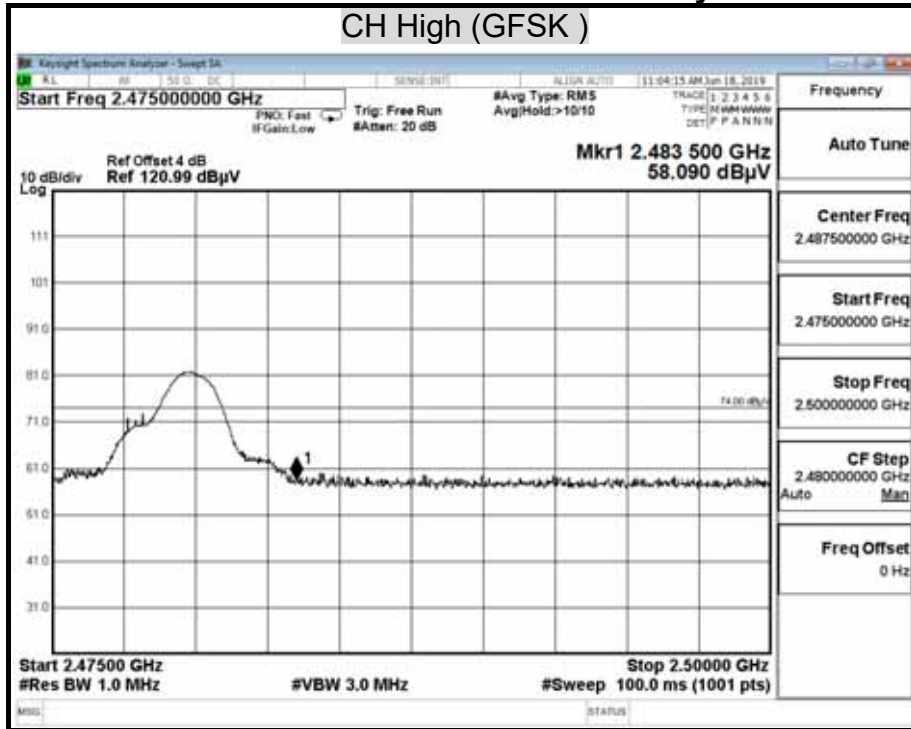

Detector Mode : Average

Polarity : Vertical

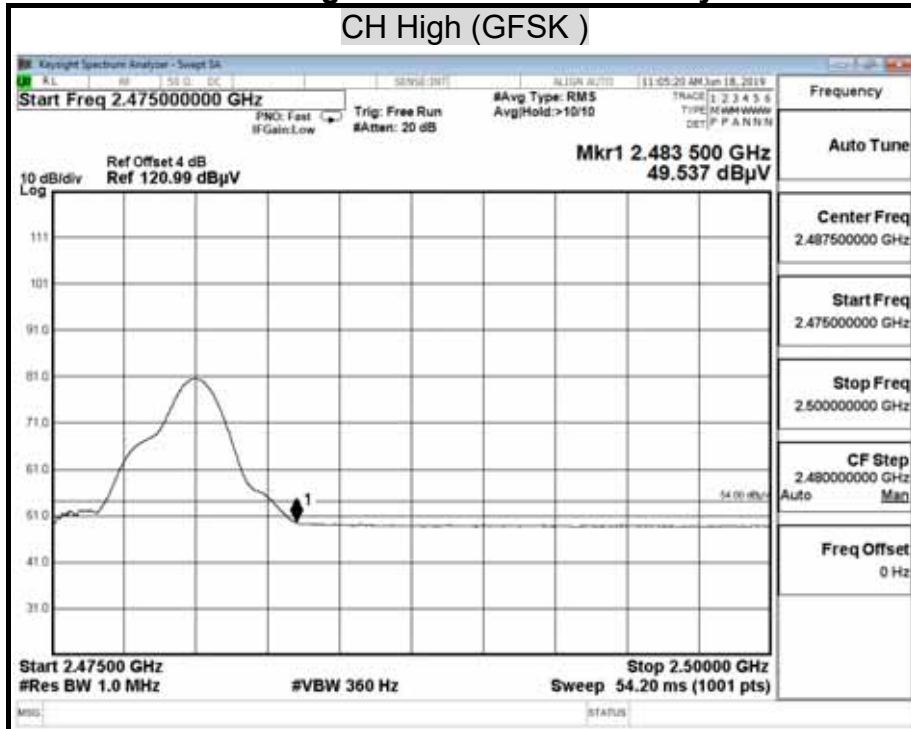

Detector Mode : Peak **Polarity : Horizontal**

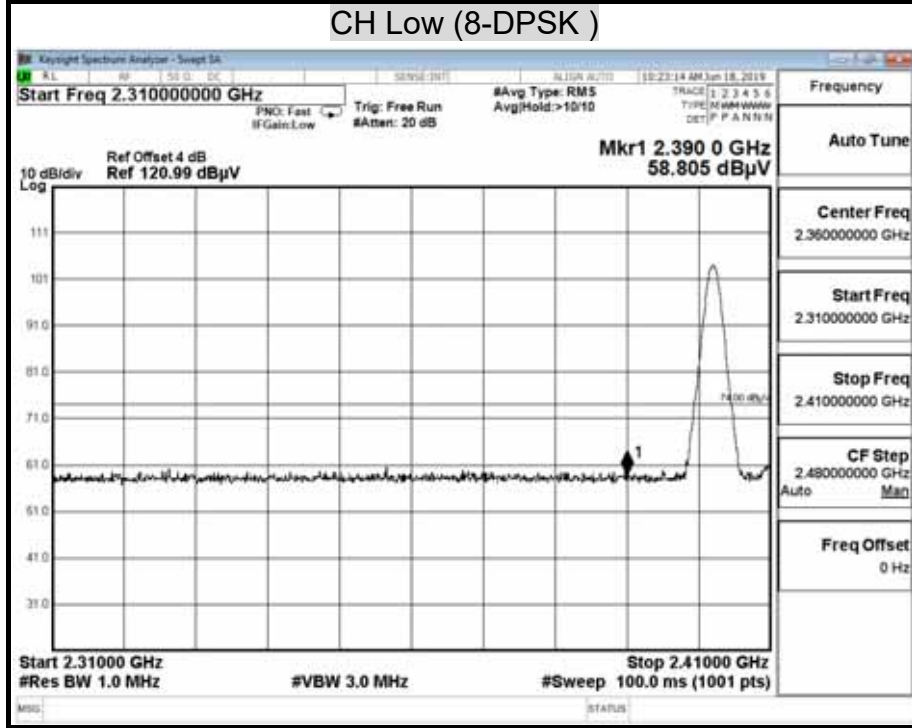

Detector Mode : Average **Polarity : Horizontal**

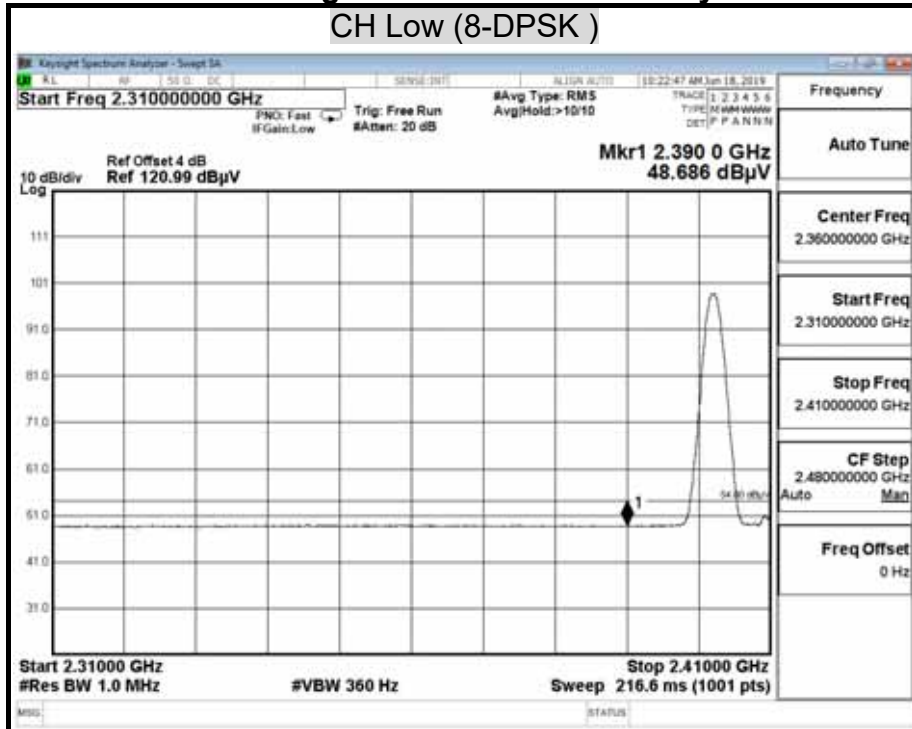

Detector Mode : Peak

Polarity : Vertical

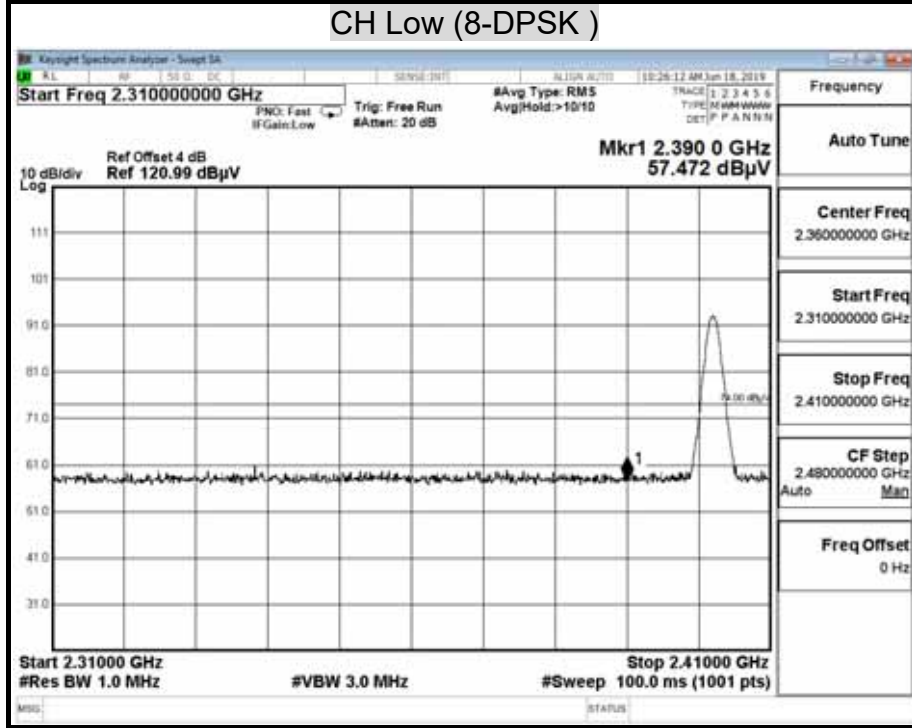

Detector Mode : Average

Polarity : Vertical

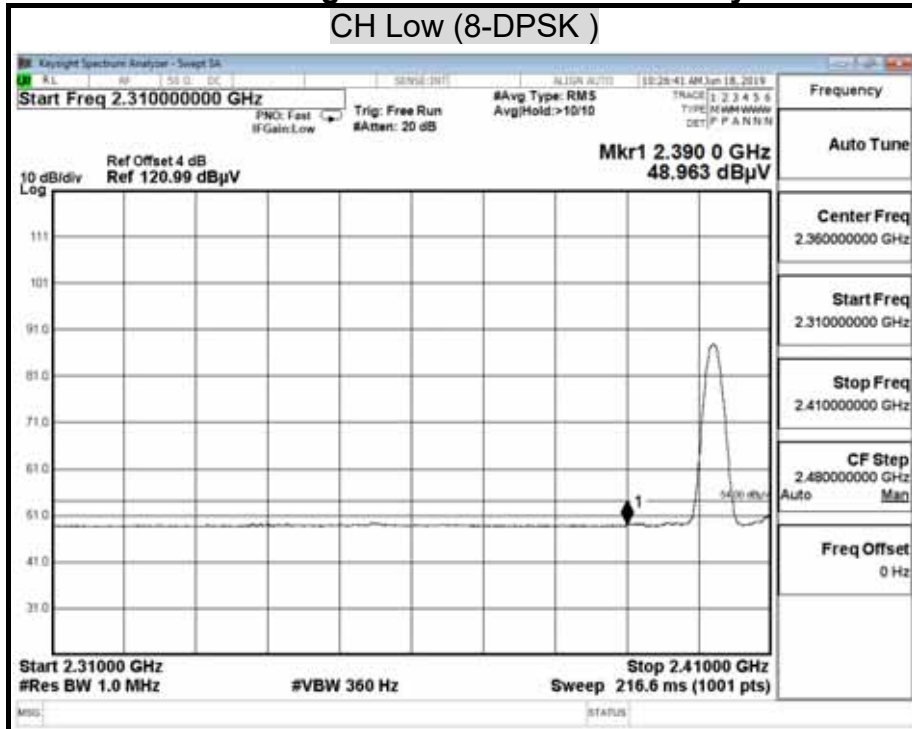

Detector Mode : Peak

Polarity : Vertical

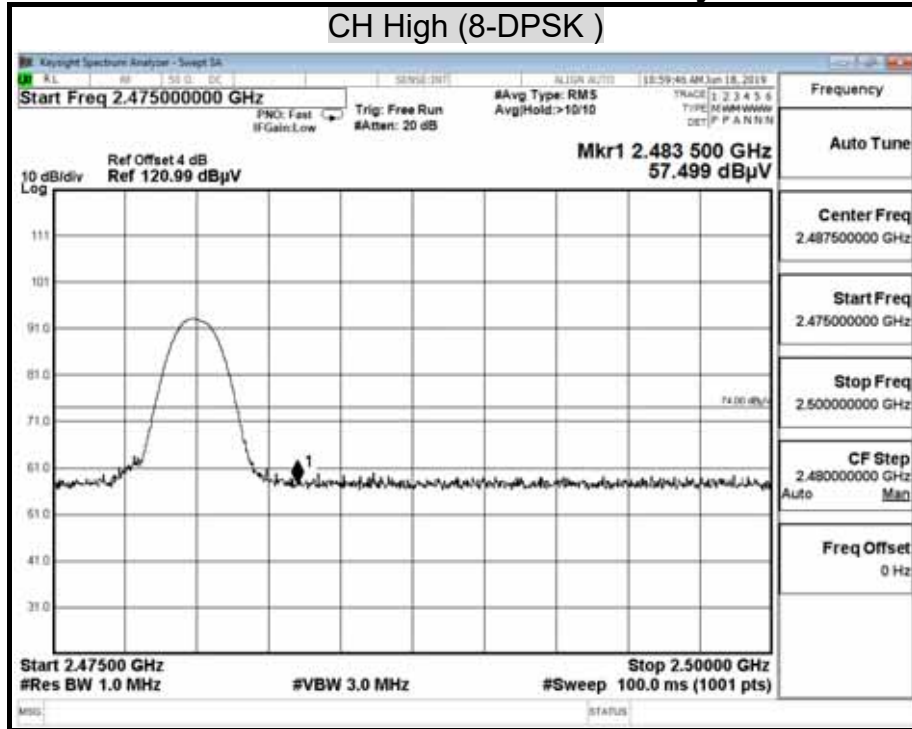

Detector Mode : Average

Polarity : Vertical

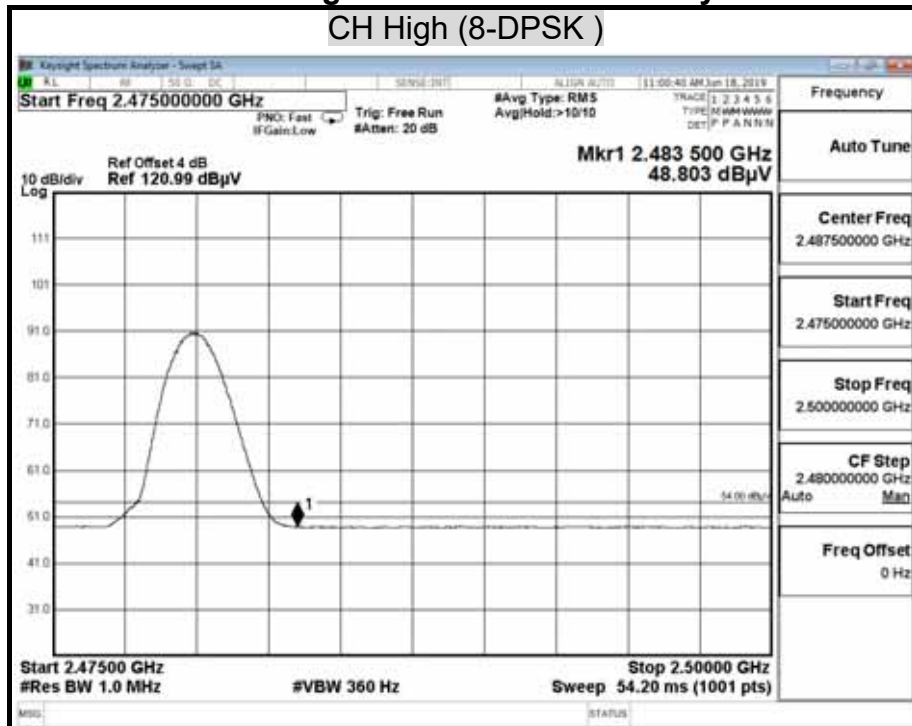

Report No.: T190605N02-RP1-1

8.9 POWERLINE CONDUCTED EMISSIONS

LIMITS

§ 15.207 (a) Except as shown in paragraph (b) and (c) this section, for an intentional radiator that is designed to be connected to the public utility (AC) power line, the radio frequency voltage that is conducted back onto the AC power line on any frequency or frequencies within the band 150 kHz to 30 MHz shall not exceed the limits in the following table, as measured using a 50 μ H/50 ohms line impedance stabilization network (LISN). Compliance with the provisions of this paragraph shall be based on the measurement of the radio frequency voltage between each power line and ground at the power terminal.

The lower limit applies at the boundary between the frequency ranges.

| Frequency of Emission (MHz) | Conducted limit (dB μ v) | |
|-----------------------------|------------------------------|----------|
| | Quasi-peak | Average |
| 0.15 - 0.5 | 66 to 56 | 56 to 46 |
| 0.5 - 5 | 56 | 46 |
| 5 - 30 | 60 | 50 |

Report No.: T190605N02-RP1-1

TEST SETUP

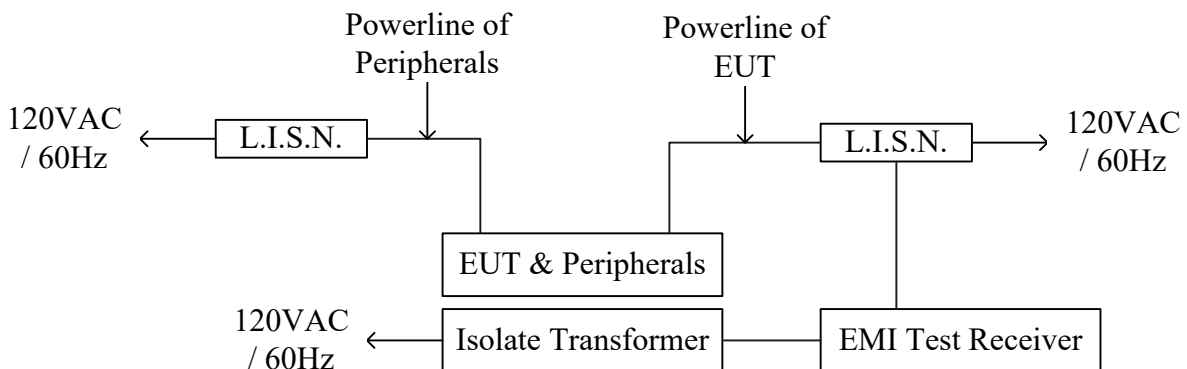
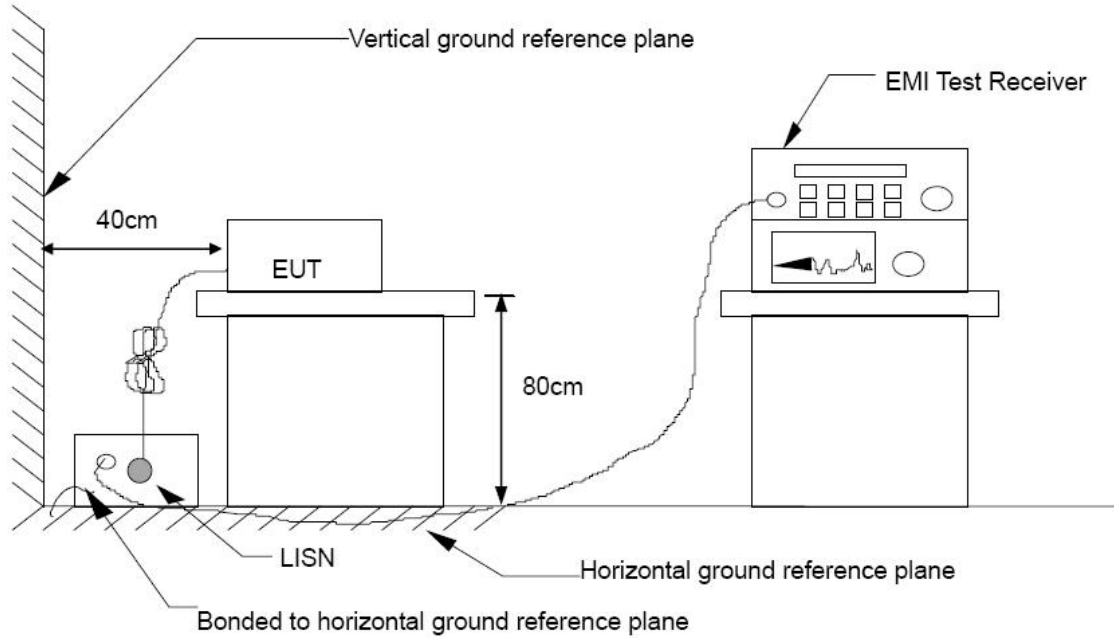

TEST PROCEDURE

The EUT is placed on a non-conducting table 40 cm from the vertical ground plane and 80cm above the horizontal ground plane. The EUT IS CONFIGURED IN ACCORDANCE WITH ANSI C63.10 : 2013.

The resolution bandwidth is set to 9 kHz for both quasi-peak detection and average detection measurements.

Line conducted data is recorded for both NEUTRAL and LINE.

Report No.: T190605N02-RP1-1

TEST RESULTS

| | | | |
|---------------------------------|-----------------|-----------------------------|-------|
| Model No. | AT-LP120XBT-USB | Test Mode | LINE |
| Environmental Conditions | 25 , 70% RH | Resolution Bandwidth | 9 kHz |
| Tested by | Leo Wang | | |

LINE

(The chart below shows the highest readings taken from the final data.)

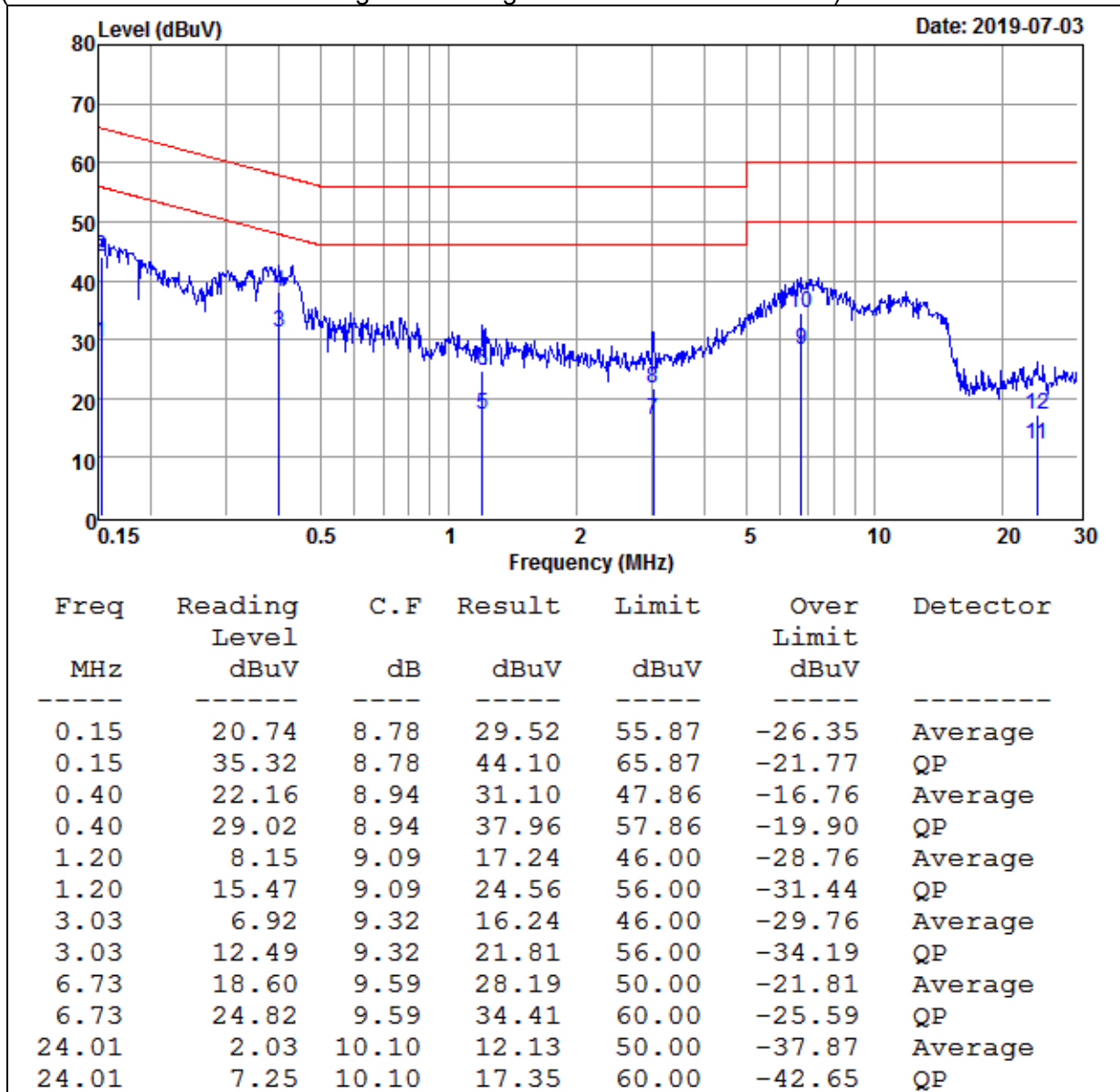

- REMARKS :
1. Level (dBuV) = Read Level (dBuV) + LISN Factor (dB) + Cable Loss (dB)
 2. Over Limit (dBuV) = Measured Level (dBuV) – Limits (dBuV)

Report No.: T190605N02-RP1-1

| | | | |
|---------------------------------|-----------------|-----------------------------|-------|
| Model No. | AT-LP120XBT-USB | Test Mode | LINE |
| Environmental Conditions | 25 , 70% RH | Resolution Bandwidth | 9 kHz |
| Tested by | Leo Wang | | |

NEUTRAL

(The chart below shows the highest readings taken from the final data.)

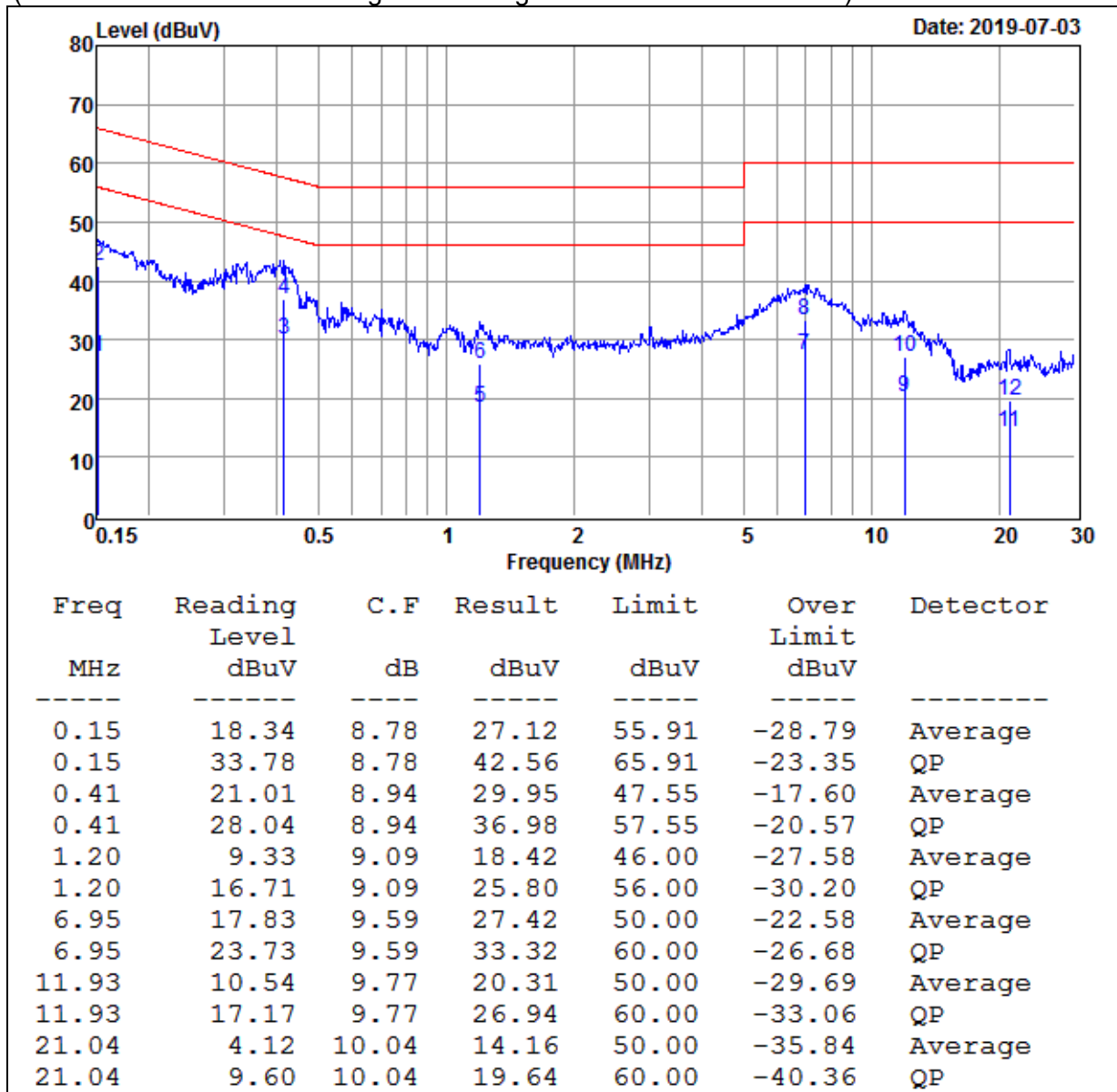

REMARKS : 1. Level (dBuV) = Read Level (dBuV) + LISN Factor (dB) + Cable Loss (dB)
2. Over Limit (dBuV) = Measured Level (dBuV) – Limits (dBuV)

Report No.: T190605N02-RP1-1

| | | | |
|---------------------------------|-----------------|-----------------------------|-------|
| Model No. | AT-LP120XBT-USB | Test Mode | PHONO |
| Environmental Conditions | 25 , 70% RH | Resolution Bandwidth | 9 kHz |
| Tested by | Leo Wang | | |

LINE

(The chart below shows the highest readings taken from the final data.)

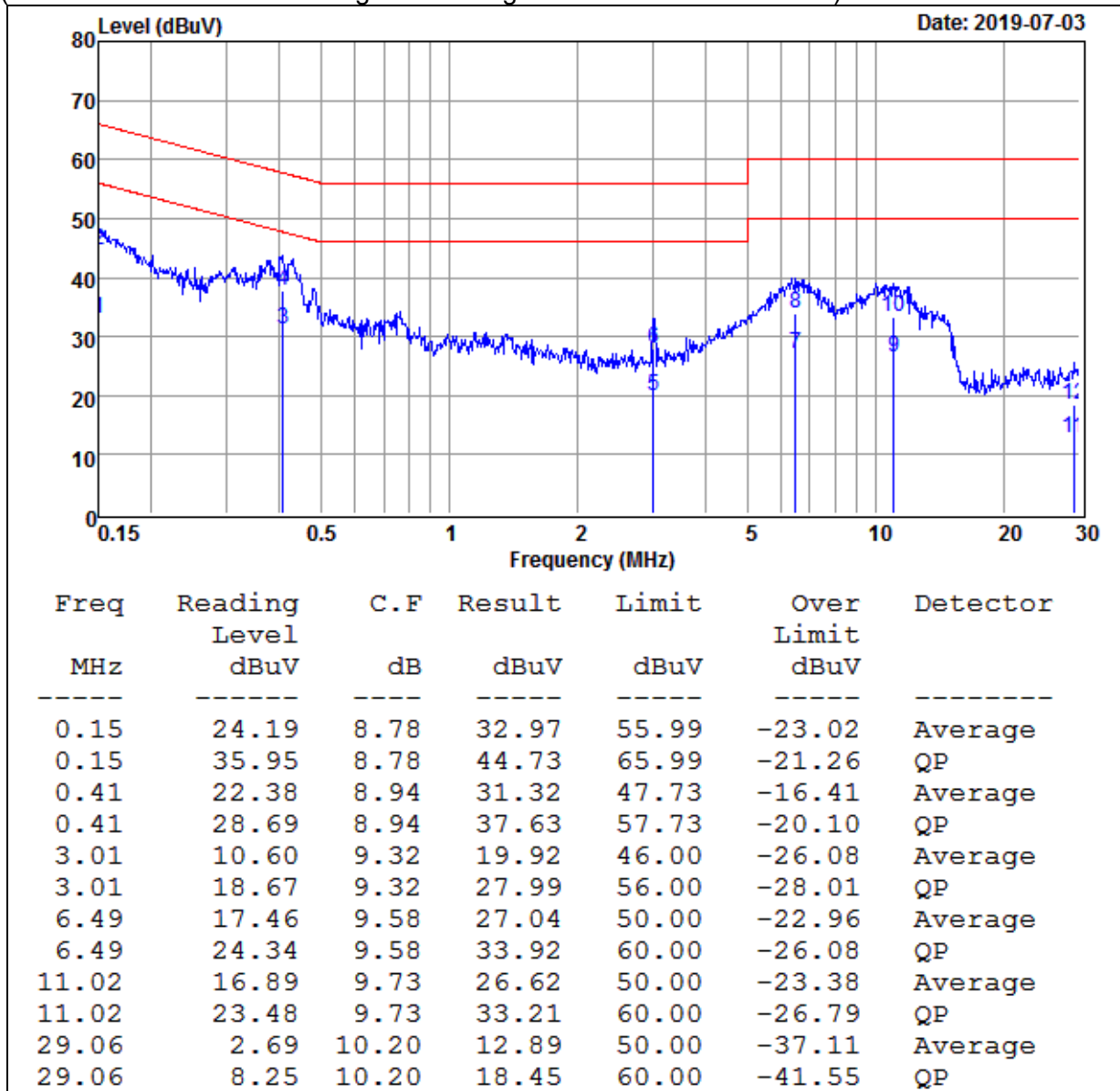

REMARKS : 1. Level (dBuV) = Read Level (dBuV) + LISN Factor (dB) + Cable Loss (dB)
2. Over Limit (dBuV) = Measured Level (dBuV) – Limits (dBuV)

Report No.: T190605N02-RP1-1

| | | | |
|---------------------------------|-----------------|-----------------------------|-------|
| Model No. | AT-LP120XBT-USB | Test Mode | PHONO |
| Environmental Conditions | 25 , 70% RH | Resolution Bandwidth | 9 kHz |
| Tested by | Leo Wang | | |

NEUTRAL

(The chart below shows the highest readings taken from the final data.)

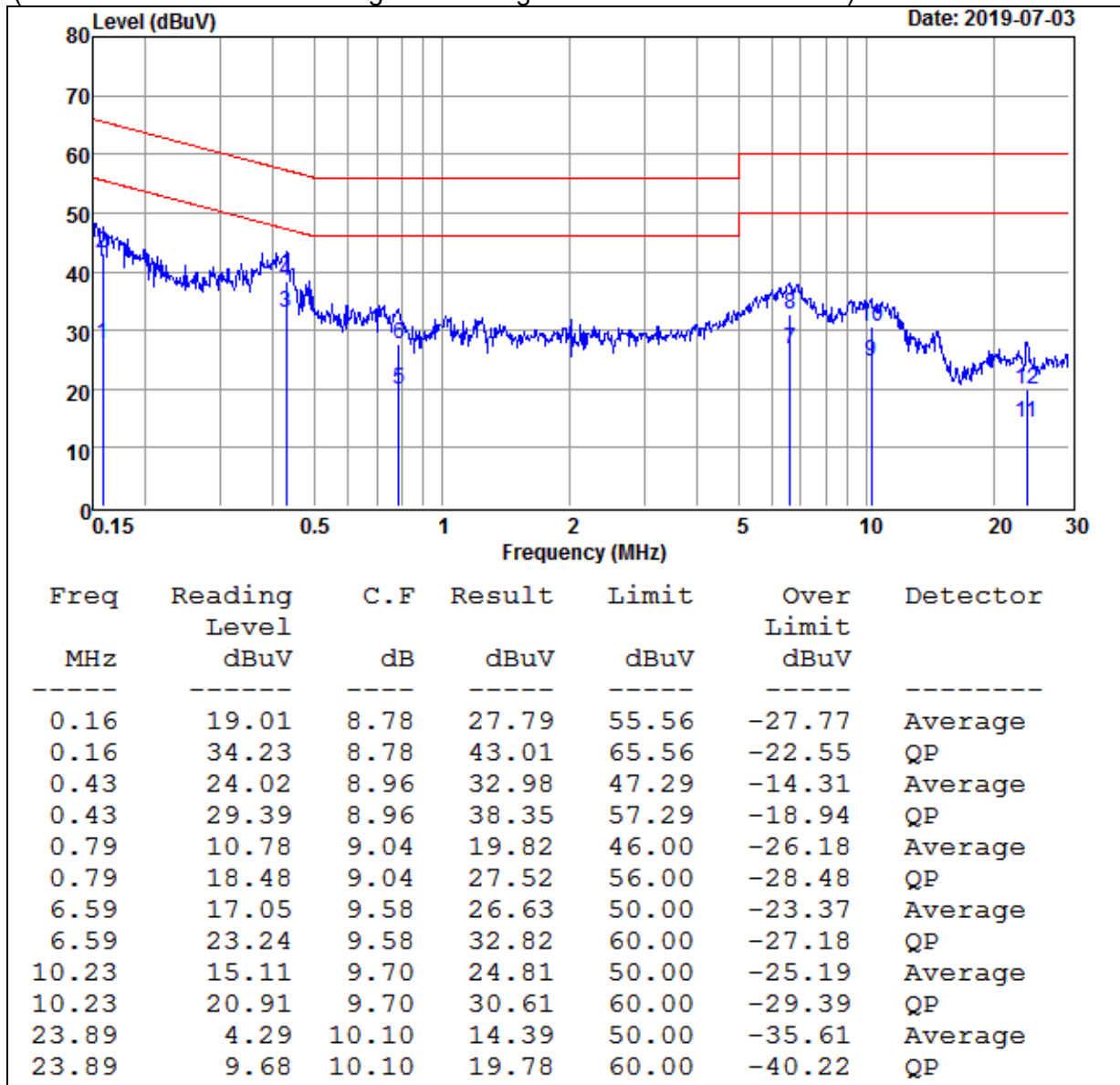

REMARKS : 1. Level (dBuV) = Read Level (dBuV) + LISN Factor (dB) + Cable Loss (dB)
2. Over Limit (dBuV) = Measured Level (dBuV) – Limits (dBuV)

=== END of Report ===