

High channel

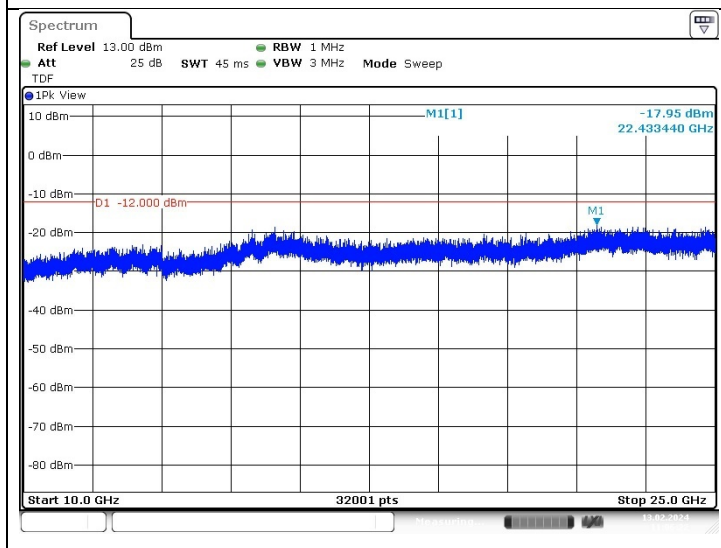
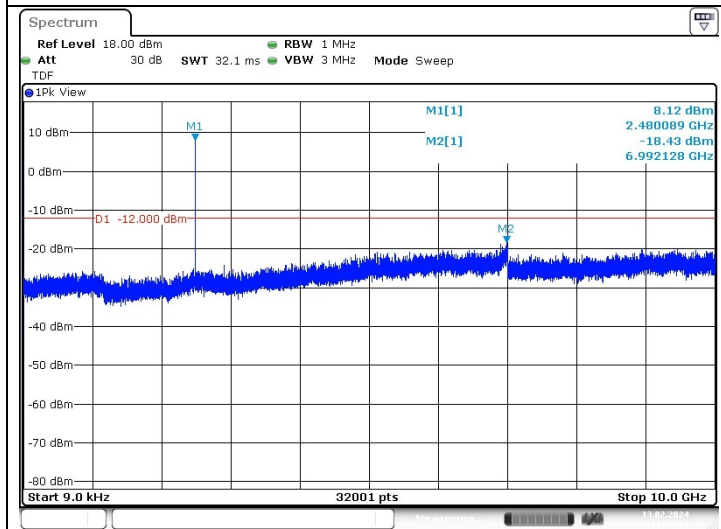
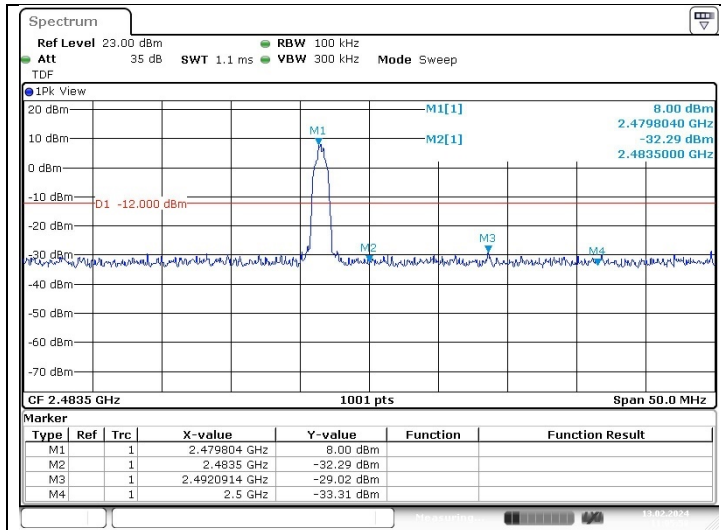

Mode: 8DPSK_hopping function turned on

Band edge compliance

Low channel

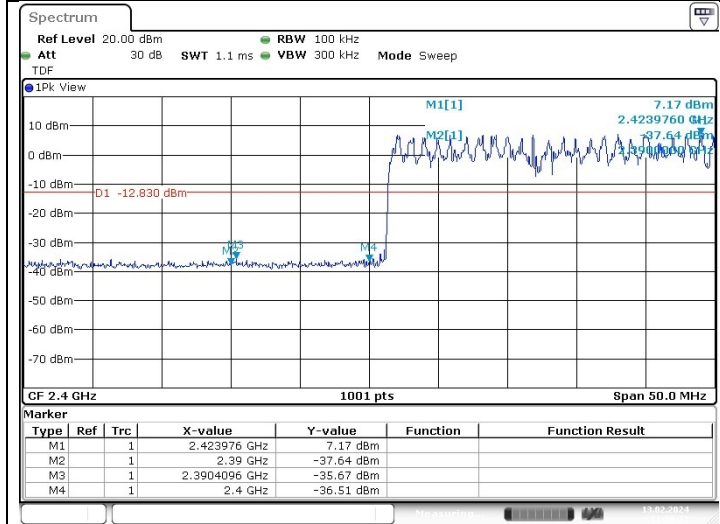

High channel

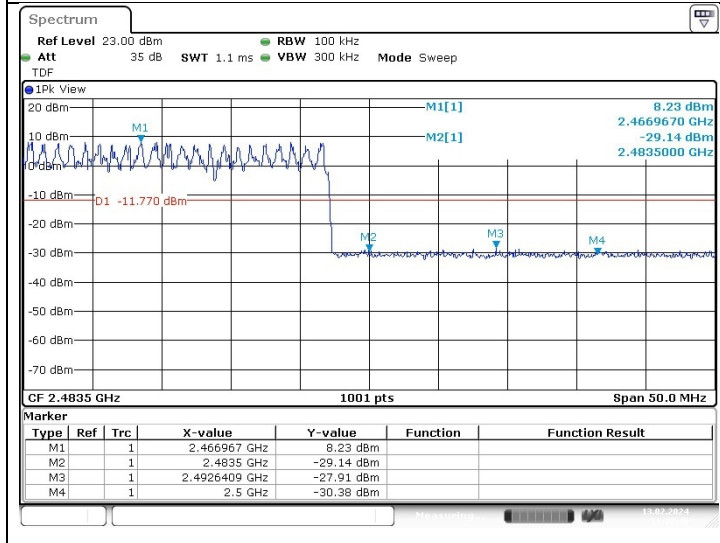

3. 20 dB Bandwidth and 99 % Bandwidth

3.1. Test Setup

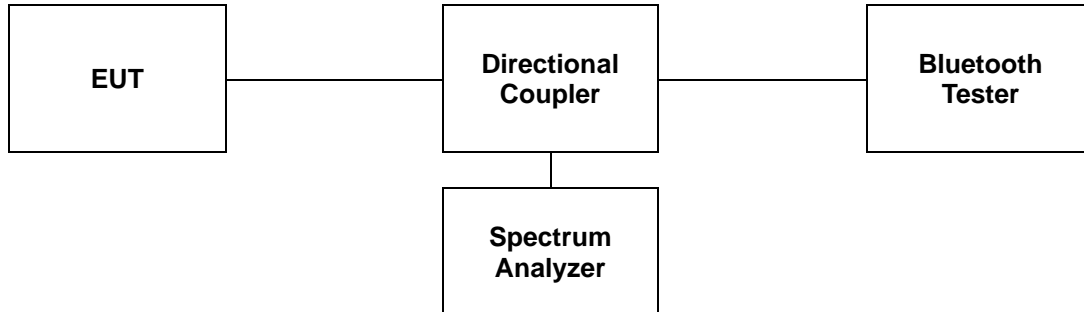

3.2. Limit

Limit: Not Applicable

3.3. Test Procedure

3.3.1. 20 dB Bandwidth

The test follows ANSI C63.10-2013.

The 20 dB bandwidth was measured with a spectrum analyzer connected to RF antenna connector (conducted measurement) while EUT was operating in transmit mode at the appropriate center frequency.

Use the following spectrum analyzer setting:

1. Span = approximately 2 to 5 times the 20 dB bandwidth.
2. RBW \geq 1 % to 5 % of the 20 dB bandwidth.
3. VBW \geq 3 x RBW
4. Sweep = auto
5. Detector = peak
6. Trace = max hold

The marker-to-peak function to set the mark to the peak of the emission. Use the marker-delta function to measure 20 dB down one side of the emission. Reset the function, and move the marker to the other side of the emission, until it is (as close as possible to) even with the reference marker level. The marker-delta reading at this point is 20 dB bandwidth of the emission.

3.3.2. 99 % Bandwidth

- The span of the spectrum analyzer shall be set large enough to capture all products of the modulation process, including the emission skirts, around the carrier frequency, but small enough to avoid having other emissions (e.g. on adjacent channels) within the span.
- The detector of the spectrum analyzer shall be set to "Sample". However, a peak, or peak hold, may be used in place of the sampling detector since this usually produces a wider bandwidth than the actual bandwidth (worst-case measurement). Use of a peak hold (or "Max Hold") may be necessary to determine the occupied / x dB bandwidth if the device is not transmitting continuously.
- The resolution bandwidth (RBW) shall be in the range of 1 % to 5 % of the actual occupied / x dB bandwidth and the video bandwidth (VBW) shall not be smaller than three times the RBW value. Video averaging is not permitted.

Note: It may be necessary to repeat the measurement a few times until the RBW and VBW are in compliance with the above requirement.

For the 99 % emission bandwidth, the trace data points are recovered and directly summed in linear power level terms. The recovered amplitude data points, beginning at the lowest frequency, are placed in a running sum until 0.5 % of the total is reached, and that frequency recorded. The process is repeated for the highest frequency data points (starting at the highest frequency, at the right side of the span, and going down in frequency). This frequency is then recorded. The difference between the two recorded frequencies is the occupied bandwidth (or the 99 % emission bandwidth).

3.4. Test Results

Ambient temperature : (23 ± 1) °C
 Relative humidity : 47 % R.H.

Mode	Data Rate (Mbps)	Channel	Frequency (MHz)	20 dB Bandwidth (MHz)	99 % Bandwidth (MHz)
GFSK	1	Low	2 402	0.914	0.860
		Middle	2 441	0.926	0.860
		High	2 480	0.926	0.860
π/4DQPSK	2	Low	2 402	1.232	1.151
		Middle	2 441	1.229	1.151
		High	2 480	1.232	1.146
8DPSK	3	Low	2 402	1.238	1.133
		Middle	2 441	1.235	1.133
		High	2 480	1.229	1.137

- Test plots

20 dB Bandwidth

Mode: GFSK

Low Channel

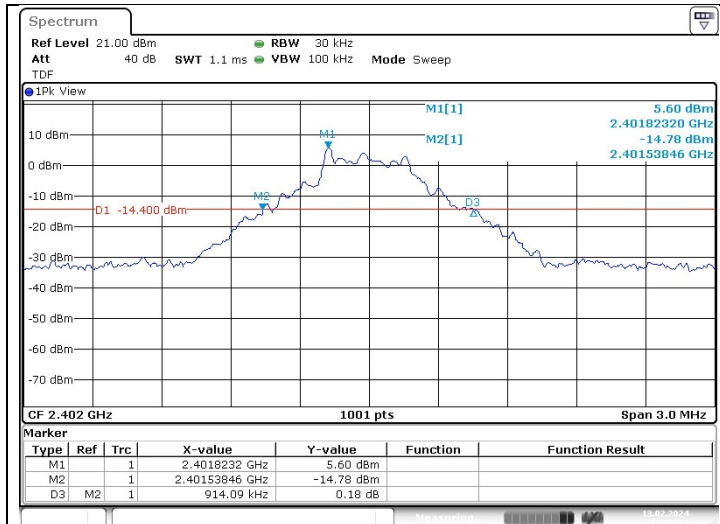

Middle Channel

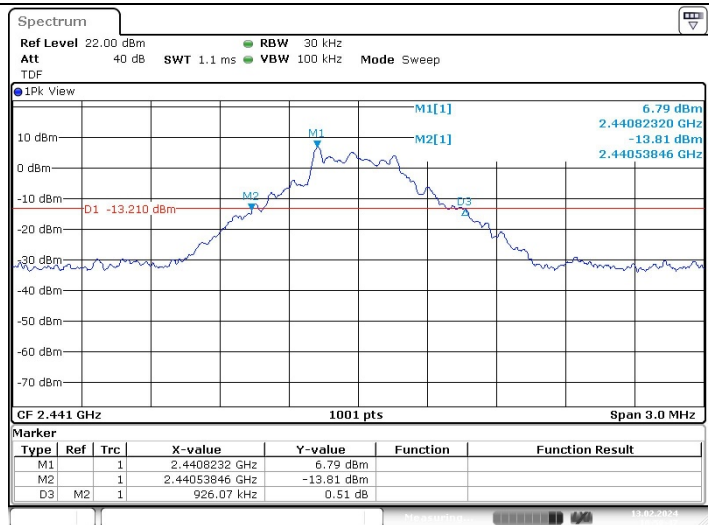

High Channel

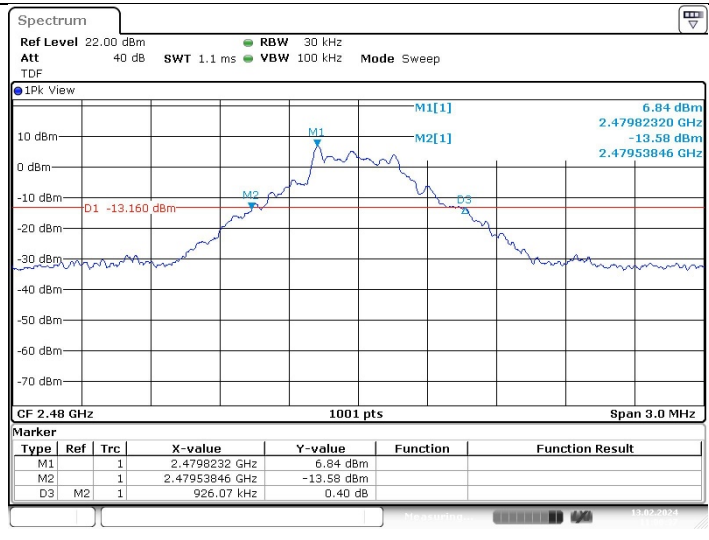

Mode: $\pi/4$ DQPSK

Low Channel

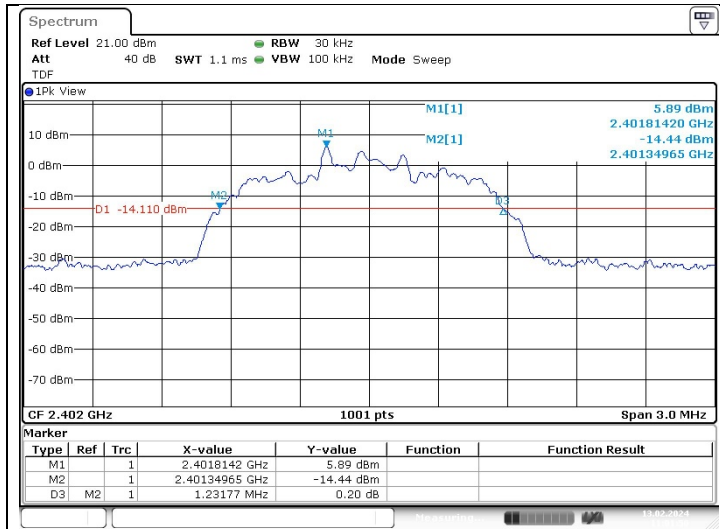

Middle Channel

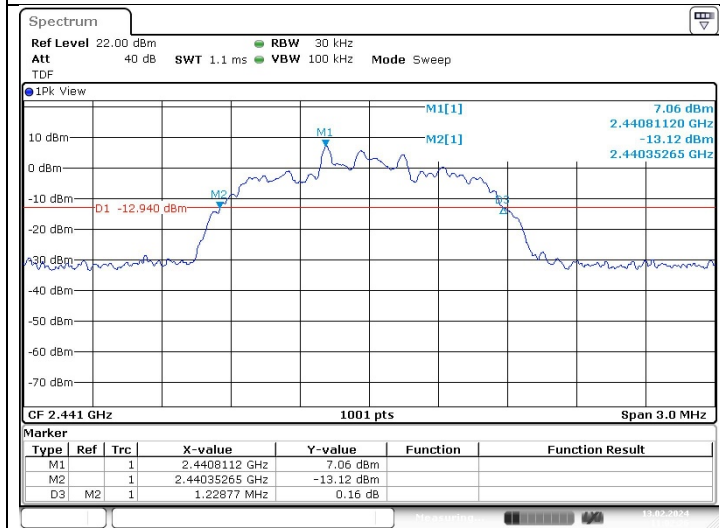

High Channel

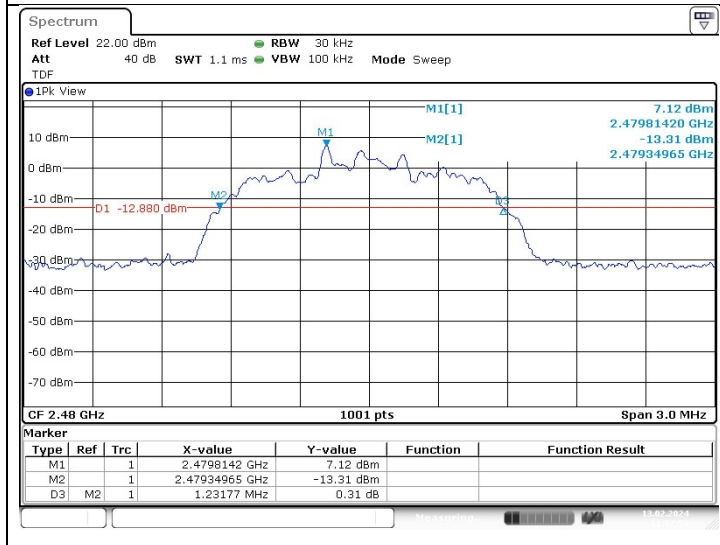

Mode: 8DPSK

Low Channel

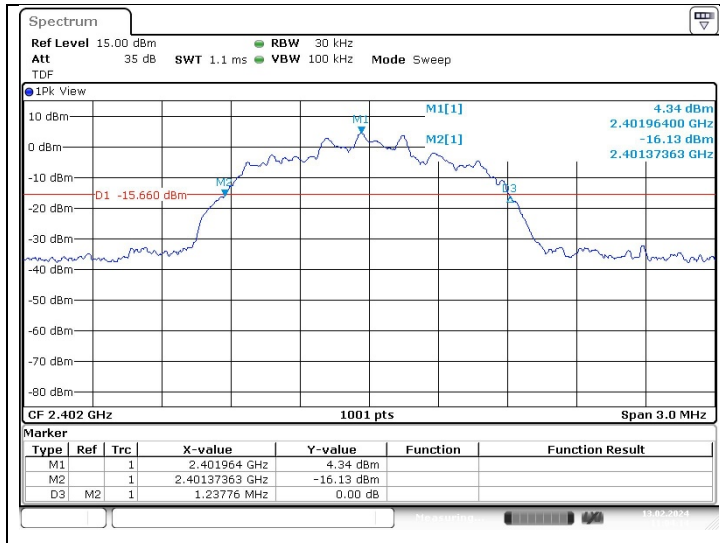

Middle Channel

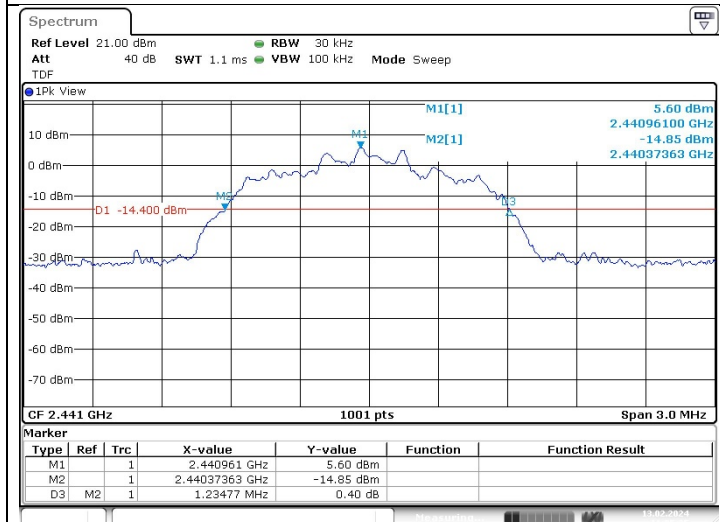

High Channel

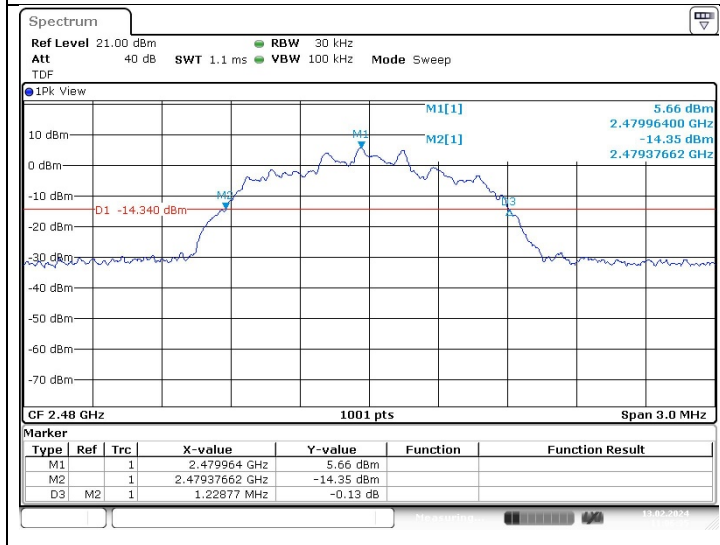

99 % Bandwidth

Mode: GFSK

Low Channel



Middle Channel



High Channel

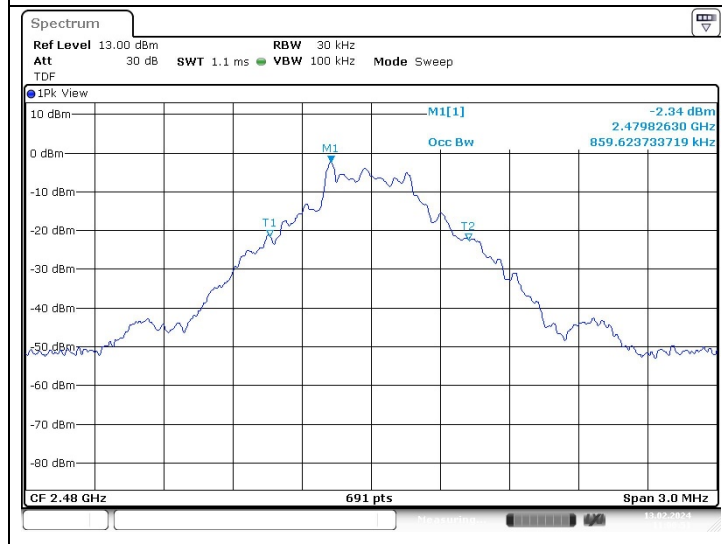

Mode: $\pi/4$ DQPSK

Low Channel

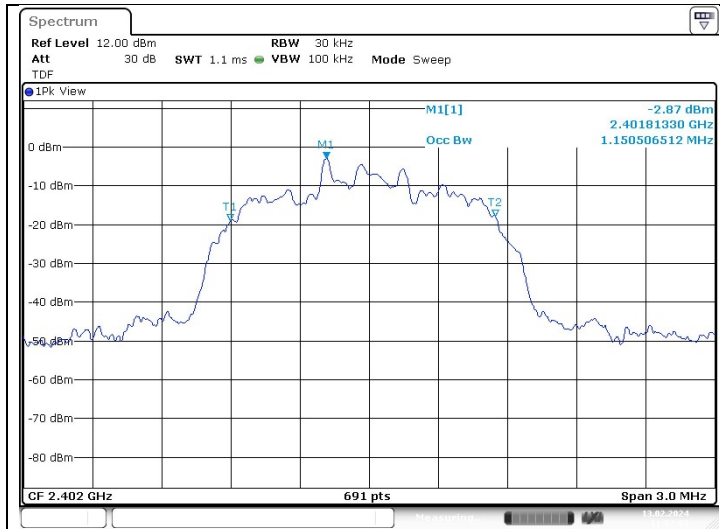

Middle Channel

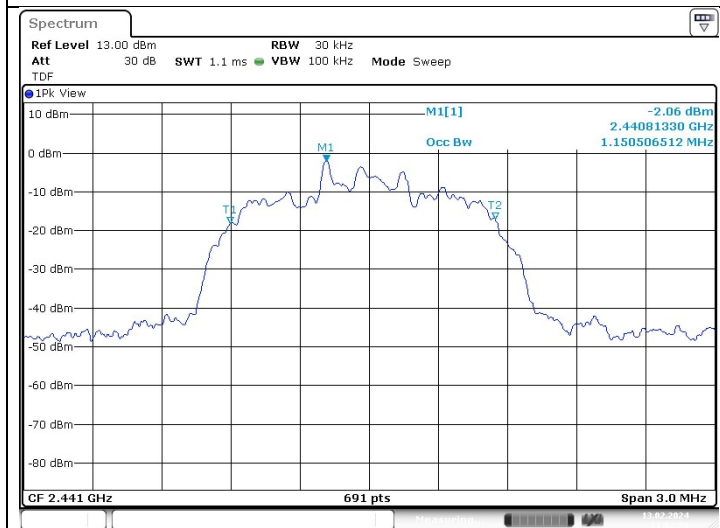

High Channel

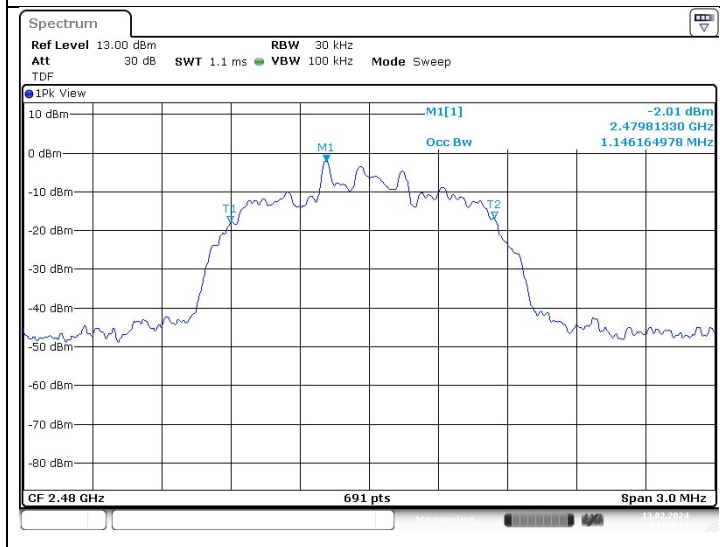

Mode: 8DPSK

Low Channel

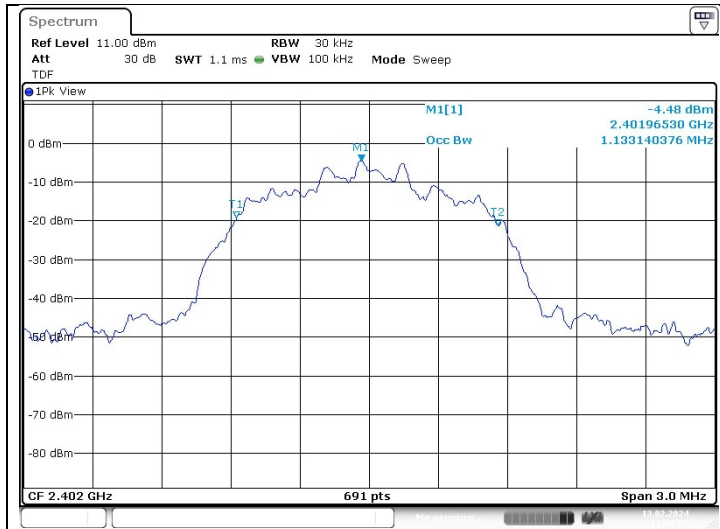

Middle Channel

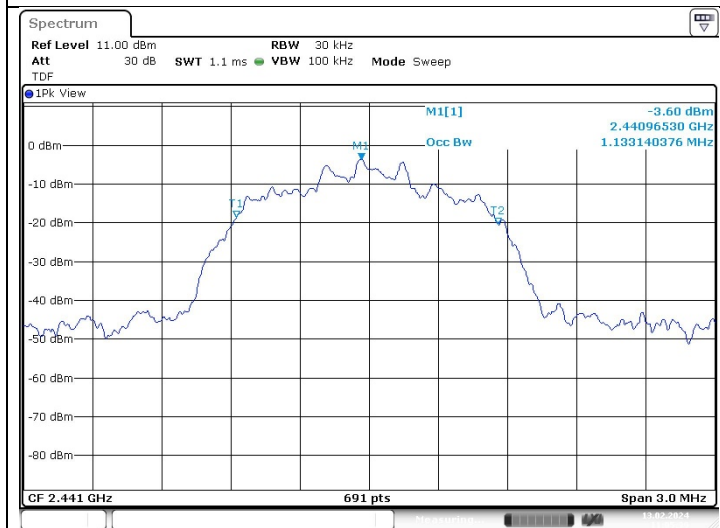

High Channel

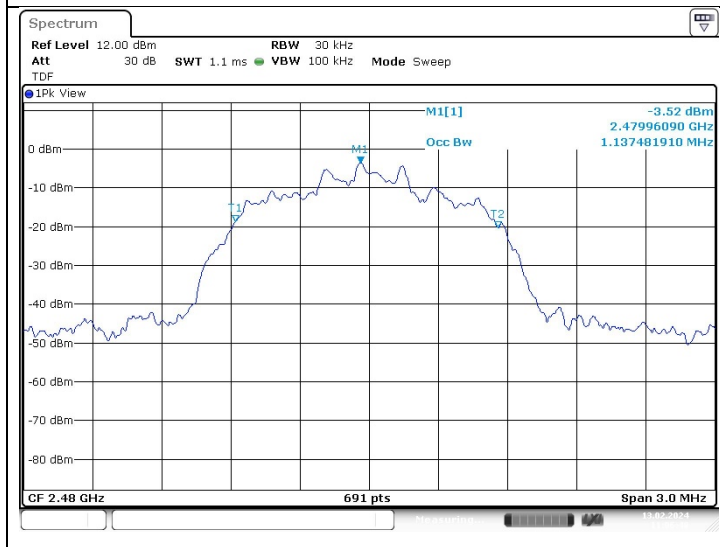

4. Maximum Peak Conducted Output Power

4.1. Test Setup

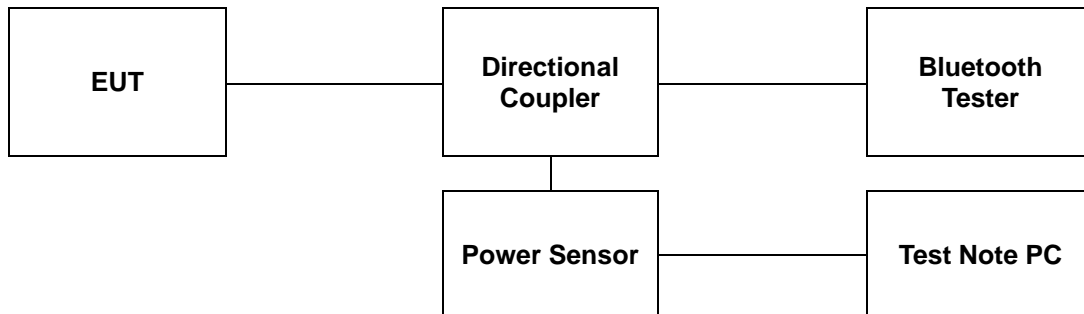

4.2. Limit

4.2.1. FCC

1. §15.247(a)(1), Frequency hopping systems shall have hopping channel carrier frequencies separated by a minimum of 25 kHz or the 20 dB bandwidth of the hopping channel, whichever is greater. Alternatively, frequency hopping systems operating in the 2 400-2 483.5 MHz band may have hopping channel carrier frequencies that are separated by 25 kHz or two-thirds of the 20 dB bandwidth of the hopping channel, whichever is greater, provided the systems operate with an output power no greater than 125 mW.
2. §15.247(b)(1), For frequency hopping systems operating in the 2 400-2 483.5 MHz band employing at least 75 non-overlapping hopping channels, and all frequency hopping systems in the 5 725-5 850 MHz band: 1 watt. For all other frequency hopping systems in the 2 400-2 483.5 MHz band: 0.125 watts.

4.2.2. IC

1. According to RSS-247 Issue 3, 5.1(b), FHSs shall have hopping channel carrier frequencies separated by a minimum of 25 kHz or the 20 dB bandwidth of the hopping channel, whichever is greater. Alternatively, FHSs operating in the band 2 400-2 483.5 MHz may have hopping channel carrier frequencies that are separated by 25 kHz or two thirds of the 20 dB bandwidth of the hopping channel, whichever is greater, provided that the systems operate with an output power no greater than 0.125 W.
2. According to RSS-247 Issue 3, 5.4(b), for FHSs operating in the band 2 400-2 483.5 MHz, the maximum peak conducted output power shall not exceed 1.0 W if the hopset uses 75 or more hopping channels; the maximum peak conducted output power shall not exceed 0.125 W if the hopset uses less than 75 hopping channels. The e.i.r.p. shall not exceed 4 W, except as provided in section 5.4(e).

4.3. Test Procedure

The test follows ANSI C63.10-2013. Using the power sensor instead of a spectrum analyzer.

1. Place the EUT on the table and set it in the transmitting mode.
2. Remove the antenna from the EUT and then connect a low loss RF cable from the antenna port to the Power sensor.
3. Test program: (S/W name: R&S Power Viewer, Version: 3.2.0)
4. Measure each channel.

4.4. Test Results

Ambient temperature : (23 ± 1) °C
 Relative humidity : 47 % R.H.

Mode	Data Rate (Mbps)	Channel	Frequency (MHz)	Average Power Result (dB m)	Peak Power Result (dB m)	Limit (dB m)
GFSK	1	Low	2 402	6.57	7.07	30
		Middle	2 441	7.35	7.86	
		High	2 480	<u>7.51</u>	<u>8.02</u>	
π/4DQPSK	2	Low	2 402	6.40	8.80	20.97
		Middle	2 441	7.05	9.40	
		High	2 480	7.17	9.53	
8DPSK	3	Low	2 402	6.43	9.46	
		Middle	2 441	<u>7.23</u>	<u>10.18</u>	
		High	2 480	7.18	10.15	

Remark;

In the case of AFH, the limit for peak power is 0.125 W.

5. Carrier Frequency Separation

5.1. Test Setup

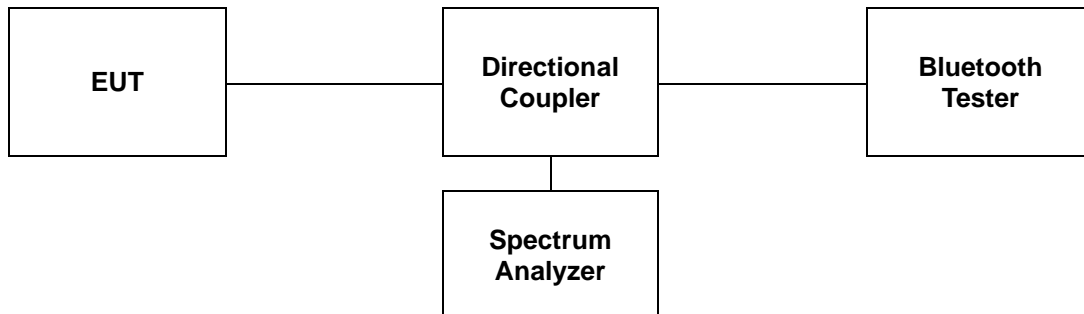

5.2. Limit

5.2.1. FCC

§15.247(a)(1), Frequency hopping systems shall have hopping channel carrier frequencies separated by a minimum of 25 kHz or the 20 dB bandwidth of the hopping channel, whichever is greater. Alternatively, frequency hopping systems operating in the 2 400-2 483.5 MHz band may have hopping channel carrier frequencies that are separated by 25 kHz or two-thirds of the 20 dB bandwidth of the hopping channel, whichever is greater, provided the systems operate with an output power no greater than 125 mW.

5.2.2. IC

According to RSS-247 Issue 3, 5.1(b), FHSs shall have hopping channel carrier frequencies separated by a minimum of 25 kHz or the 20 dB bandwidth of the hopping channel, whichever is greater. Alternatively, FHSs operating in the band 2 400-2 483.5 MHz may have hopping channel carrier frequencies that are separated by 25 kHz or two thirds of the 20 dB bandwidth of the hopping channel, whichever is greater, provided that the systems operate with an output power no greater than 0.125 W.

5.3. Test Procedure

The test follows section 7.8.2 Carrier frequency separation of ANSI C63.10-2013.

The device is operating in hopping mode between 79 channels and also supporting Adaptive Frequency Hopping with hopping between 20 channels. As compared with each operating mode, 79 channels are chosen as a representative for test.

Use the following spectrum analyzer settings:

1. Span: Wide enough to capture the peaks of two adjacent channels
2. RBW: Start with the RBW set to approximately 30 % of the channel spacing; adjust as necessary to best identify the center of each individual channel.
3. VBW \geq RBW
4. Sweep: Auto
5. Detector function: Peak
6. Trace: Max hold
7. Allow the trace to stabilize.

Use the marker-delta function to determine the between the peaks of the adjacent channels.

5.4. Test Results

Ambient temperature : (23 ± 1) °C
 Relative humidity : 47 % R.H.

Mode	Frequency (MHz)	Adjacent Hopping Channel Separation (kHz)	20 dB Bandwidth (kHz)
GFSK	2 441	1 000	0.926

Mode	Frequency (MHz)	Adjacent Hopping Channel Separation (kHz)	Two-third of 20 dB Bandwidth (kHz)
8DPSK	2 441	1 000	0.823

Remark;

Measurement is made with EUT operating in hopping mode between 79 channels providing a worst case scenario as compared to AFH mode hopping between 20 channels.

- Test plots

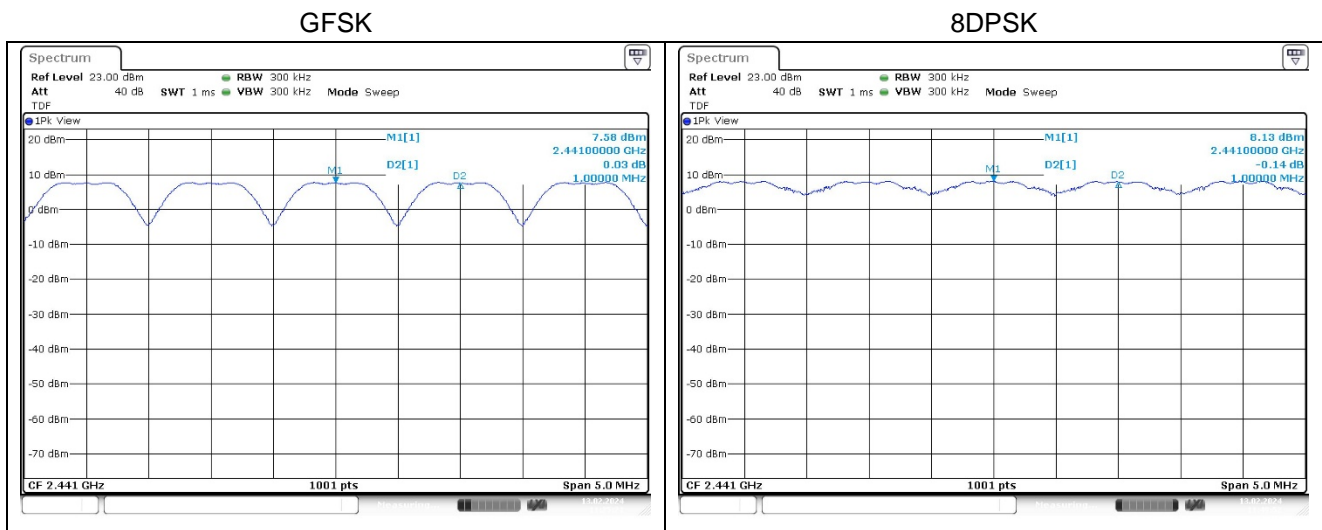

6. Number of Hopping Frequencies

6.1. Test Setup

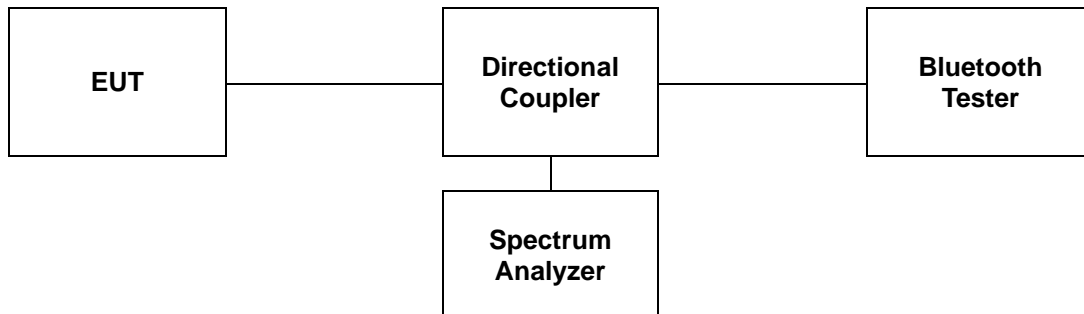

6.2. Limit

6.2.1. FCC

§15.247(a)(1)(iii), Frequency hopping systems in the 2 400-2 483.5 MHz band shall use at least 15 channels. The average time of occupancy on any channel shall not be greater than 0.4 seconds within a period of 0.4 seconds multiplied by the number of hopping channels employed. Frequency hopping systems may avoid or suppress transmissions on a particular hopping frequency provided that a minimum of 15 channels are used.

6.2.2. IC

According to RSS-247 Issue 3, 5.1(d), FHSs operating in the band 2 400-2 483.5 MHz shall use at least 15 hopping channels. The average time of occupancy on any channel shall not be greater than 0.4 seconds within a period of 0.4 seconds, multiplied by the number of hopping channels employed. Transmissions on particular hopping frequencies may be avoided or suppressed provided that at least 15 hopping channels are used.

6.3. Test Procedure

The test follows section 7.8.3 Number of hopping frequencies of ANSI C63.10-2013.

The device supports Adaptive Frequency Hopping and will use a minimum of 20 channels of the 79 available channels.

The EUT shall have its hopping function enabled. Use the following spectrum analyzer settings:

1. Span: The frequency band of operation. Depending on the number of channels the device supports, it may be necessary to divide the frequency range of operation across multiple spans, to allow the individual channels to be clearly seen.
2. RBW: To identify clearly the individual channels, set the RBW to less than 30 % of the channel spacing or the 20 dB bandwidth, whichever is smaller.
3. VBW \geq RBW
4. Sweep: Auto
5. Detector function: Peak
6. Trace: Max hold
7. Allow the trace to stabilize.

6.4. Test Results

Ambient temperature : (23 ± 1) °C
 Relative humidity : 47 % R.H.

Mode	Number of Hopping Frequency	Limit
GFSK	79	≥ 15
8DPSK	79	≥ 15

Remark;

Measurement is made with EUT operating in hopping mode between 79 channels providing a worst case scenario as compared to AFH mode hopping between 20 channels.

- Test plots

GFSK

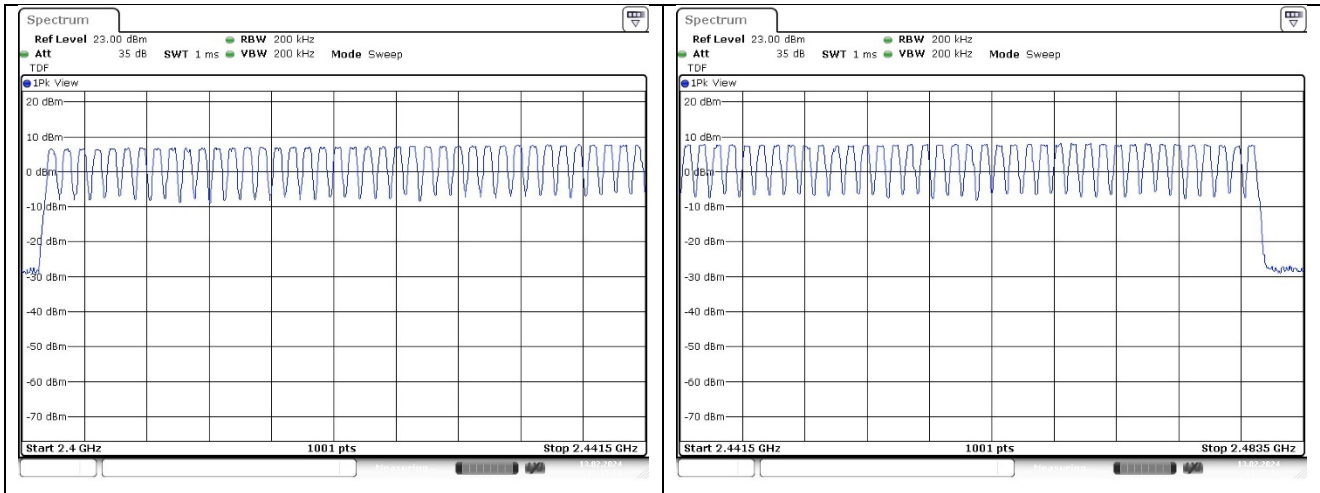

8DPSK

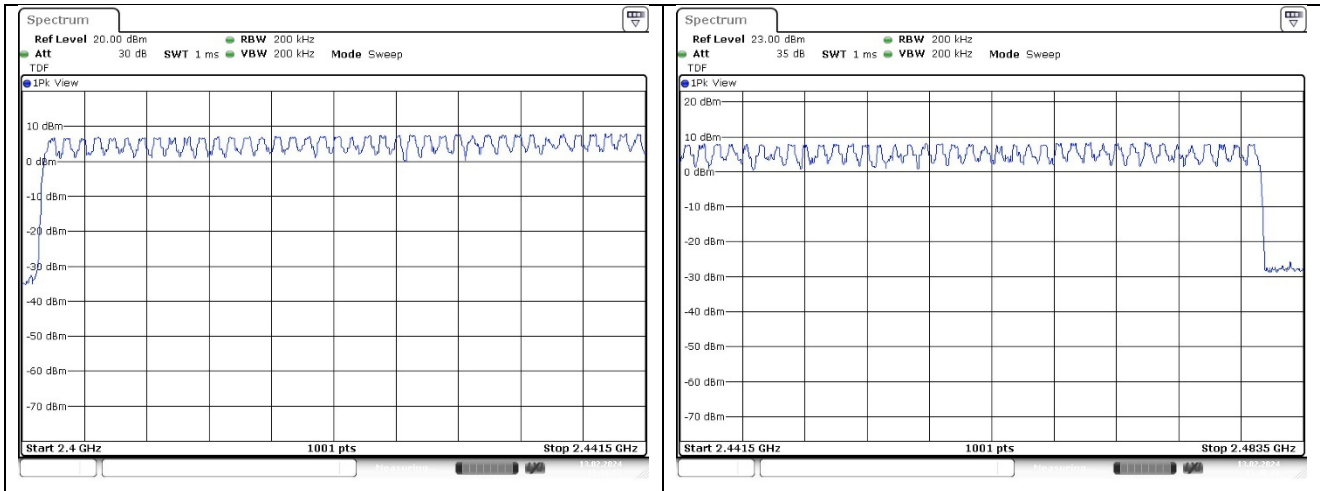

7. Time of Occupancy (Dwell Time)

7.1. Test Set up

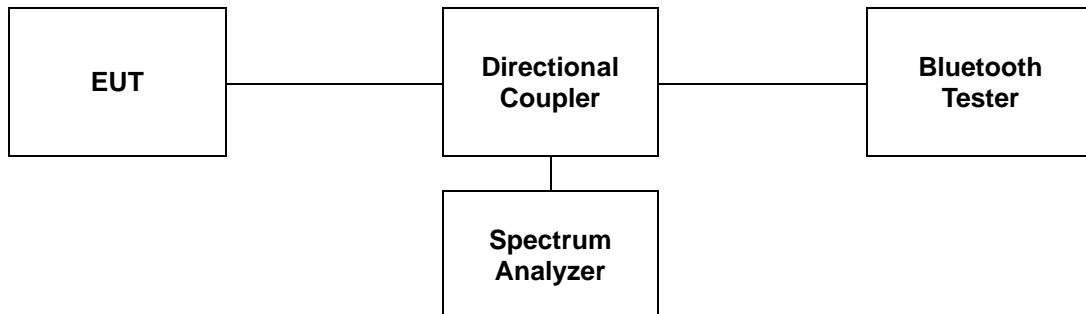

7.2. Limit

7.2.1. FCC

§15.247(a)(1)(iii), Frequency hopping systems in the 2 400-2 483.5 MHz band, the average time of occupancy on any frequency shall not be greater than 0.4 second within a 31.6 second period.

7.2.2. IC

According to RSS-247 Issue 3, 5.1(d), FHSs operating in the band 2 400-2 483.5 MHz shall use at least 15 hopping channels. The average time of occupancy on any channel shall not be greater than 0.4 seconds within a period of 0.4 seconds, multiplied by the number of hopping channels employed. Transmissions on particular hopping frequencies may be avoided or suppressed provided that at least 15 hopping channels are used.

A period time = 0.4 (s) * 79 = 31.6 (s)

*Adaptive Frequency Hopping

A period time = 0.4 (s) * 20 = 8 (s)

7.3. Test Procedure

The test follows section 7.8.4 Time of occupancy of ANSI C63.10-2013.

1. Check the calibration of the measuring instrument using either an internal calibrator or a known signal from an external generator.
2. Position the EUT as shown in test setup without connection to measurement instrument. Turn on the EUT and connect its antenna terminal to measurement instrument via a low loss cable.
3. Measure the time duration of one transmission on the measured frequency. And then plot the result with time difference of this time duration.
4. The Bluetooth has 3 type of payload, DH1, DH3, DH5 and 3DH1, 3DH3, 3DH5. The hopping rate is insisted of 1 600 per second.

The EUT must have its hopping function enabled. Use the following spectrum analyzer setting:

1. Span = Zero span, centered on a hopping channel.
2. RBW shall be \leq channel spacing and where possible RBW should be set $\gg 1/T$, where T is the expected dwell time per channel.
3. Sweep = As necessary to capture the entire dwell time per hopping channel; where possible use a video trigger and trigger delay so that the transmitted signal starts a little to the right of the start of the plot.
4. Detector function: Peak
5. Trace: Max hold

Use the marker-delta function to determine the transmit time per hop. If this value varies with different modes of operation, then repeat this test for each variation in transmit time.

7.4. Test Results

Ambient temperature : (23 ± 1) °C
 Relative humidity : 47 % R.H.

7.4.1. Packet Type: DH1,3DH1

Mode	Frequency (MHz)	Dwell Time (ms)	Time of occupancy on the Tx Channel in 31.6 sec (ms)	Limit for time of occupancy on the Tx Channel in 31.6 sec (ms)
GFSK	2 441	0.38	121.60	400
8DPSK	2 441	0.39	124.80	400

Remark;

Time of occupancy on the TX channel in 31.6 sec
 In case of GFSK: $0.38 \times \{(1\ 600 \div 2) / 79\} \times 31.6 = 121.60$ ms
 In case of 8DPSK: $0.39 \times \{(1\ 600 \div 2) / 79\} \times 31.6 = 124.80$ ms

- Test plots

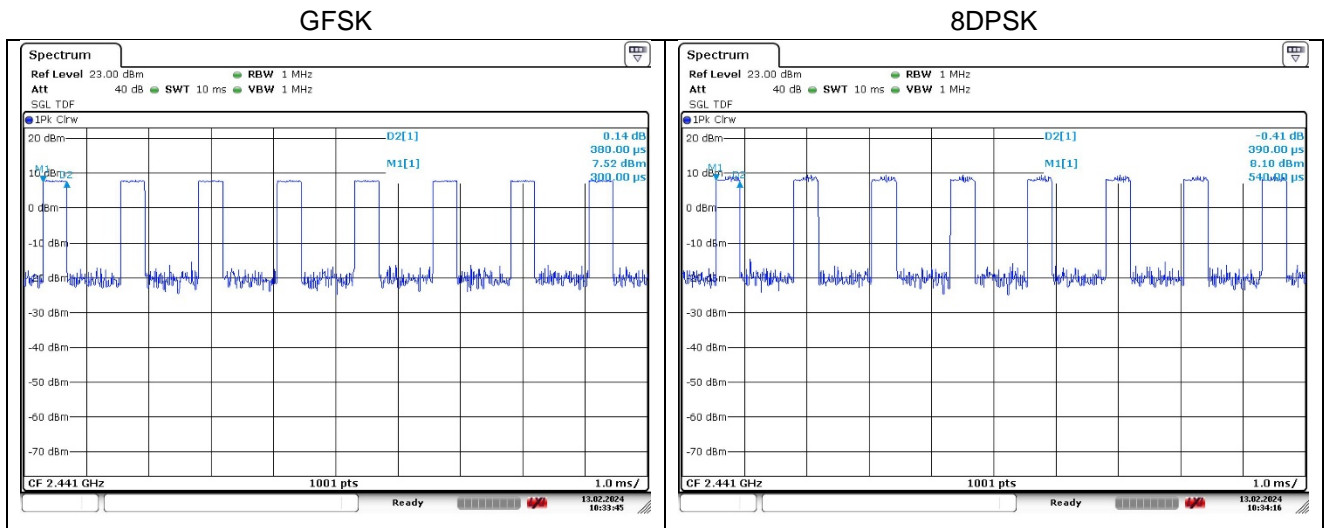

7.4.2. Packet Type: DH3, 3DH3

Mode	Frequency (MHz)	Dwell Time (ms)	Time of occupancy on the Tx Channel in 31.6 sec (ms)	Limit for time of occupancy on the Tx Channel in 31.6 sec (ms)
GFSK	2 441	1.64	262.40	400
8DPSK	2 441	1.64	262.40	400

Remark;

Time of occupancy on the TX channel in 31.6 sec

In case of GFSK and 8DPSK: $1.64 \times \{(1\ 600 \div 4) / 79\} \times 31.6 = 262.40$ ms

- Test plots

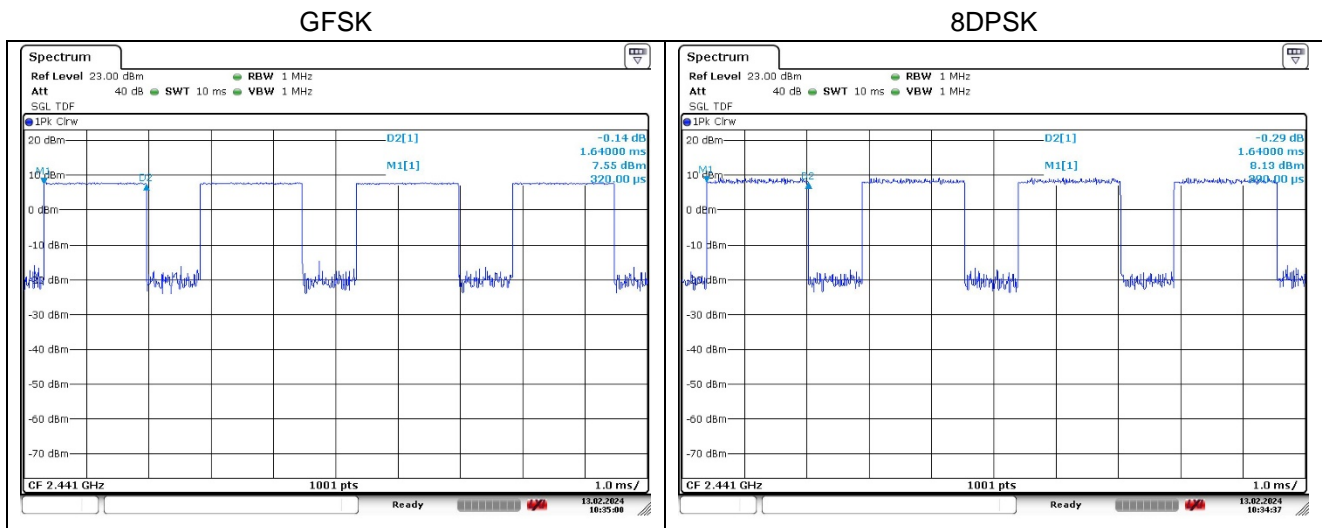

7.4.3. Packet Type: DH5, 3DH5

Mode	Frequency (MHz)	Dwell Time (ms)	Time of occupancy on the Tx Channel in 31.6 sec (ms)	Limit for time of occupancy on the Tx Channel in 31.6 sec (ms)
GFSK	2 441	2.89	308.27	400
8DPSK	2 441	2.90	309.33	400

Remark;

Time of occupancy on the TX channel in 31.6 sec

In case of GFSK: $2.89 \times \{(1\ 600 \div 6) / 79\} \times 31.6 = 308.27$ ms

In case of 8DPSK: $2.90 \times \{(1\ 600 \div 6) / 79\} \times 31.6 = 309.33$ ms

- Test plots

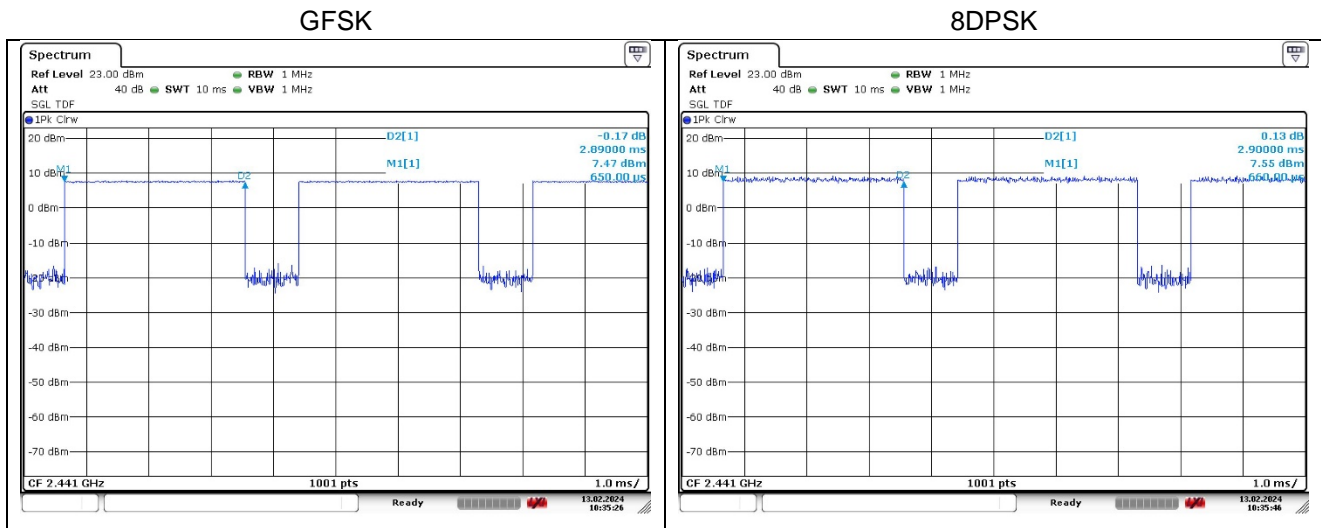

7.4.4. Packet Type: DH1 3DH1(Adaptive Frequency Hopping)

Mode	Frequency (MHz)	Dwell Time (ms)	Time of occupancy on the Tx Channel in 8 sec (ms)	Limit for time of occupancy on the Tx Channel in 8 sec (ms)
GFSK	2 441	0.38	60.80	400
8DPSK	2 441	0.39	62.40	400

Remark;

Time of occupancy on the TX channel in 8 sec

In case of GFSK: $0.38 \times \{(800 \div 2) / 20\} \times 8 = 60.80$ ms

In case of 8DPSK: $0.39 \times \{(800 \div 2) / 20\} \times 8 = 62.40$ ms

- Test plots

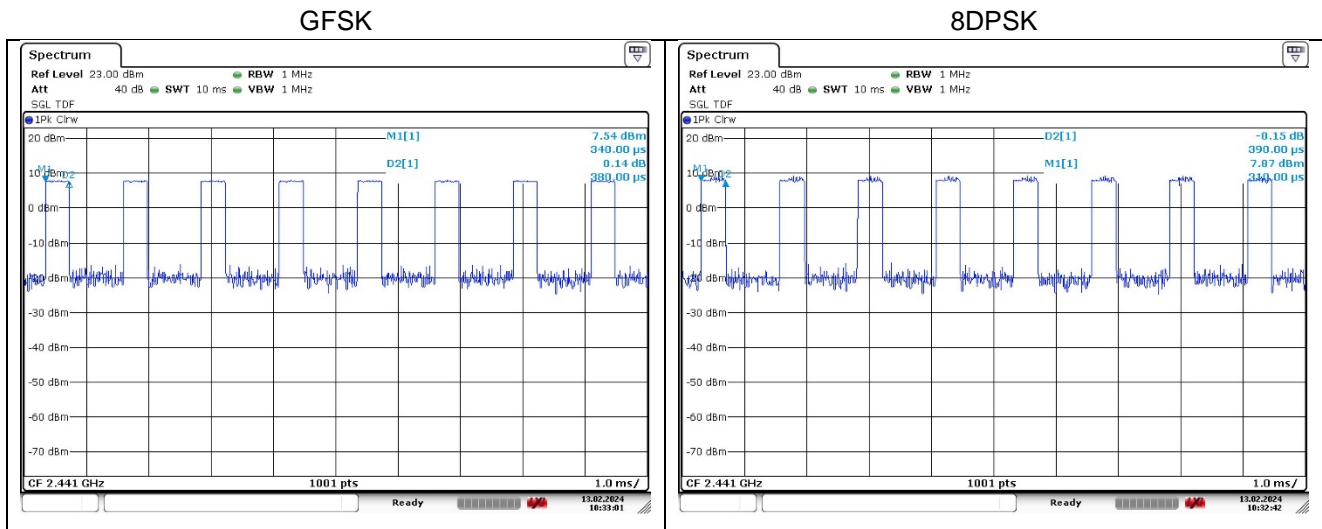

7.4.5. Packet Type: DH3, 3DH3 (Adaptive Frequency Hopping)

Mode	Frequency (MHz)	Dwell Time (ms)	Time of occupancy on the Tx Channel in 8 sec (ms)	Limit for time of occupancy on the Tx Channel in 8 sec (ms)
GFSK	2 441	1.64	131.20	400
8DPSK	2 441	1.64	131.20	400

Remark;

Time of occupancy on the TX channel in 8 sec

In case of GFSK and 8DPSK: $1.64 \times \{(800 \div 4) / 20\} \times 8 = 131.20$ ms

- Test plots

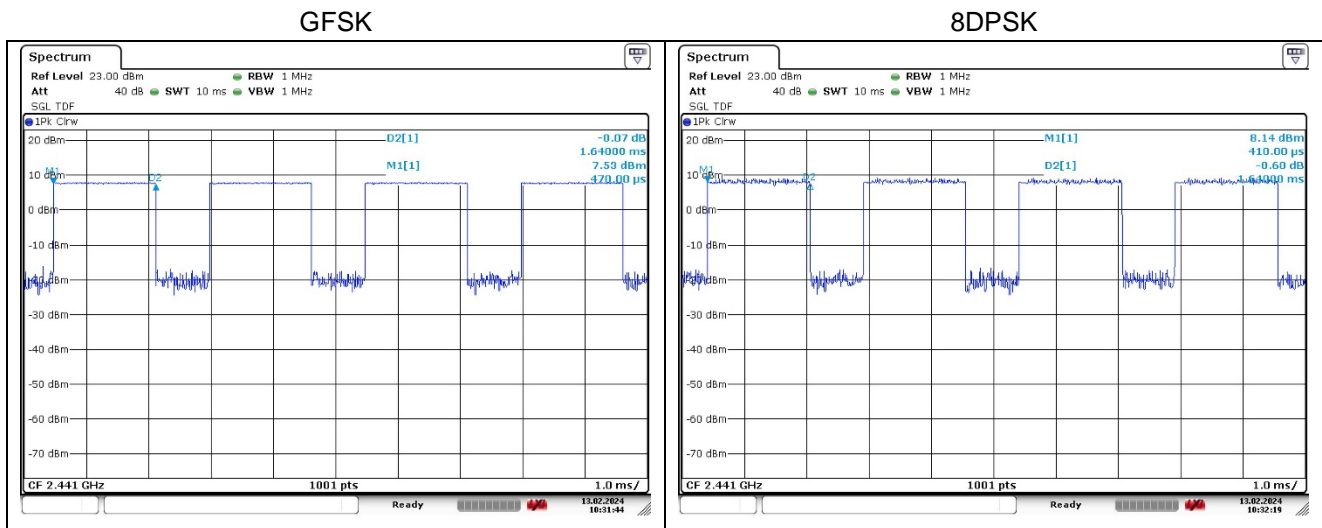

7.4.6. Packet Type: DH5, 3DH5 (Adaptive Frequency Hopping)

Mode	Frequency (MHz)	Dwell Time (ms)	Time of occupancy on the Tx Channel in 8 sec (ms)	Limit for time of occupancy on the Tx Channel in 8 sec (ms)
GFSK	2 441	2.88	153.60	400
8DPSK	2 441	2.90	154.67	400

Remark;

Time of occupancy on the TX channel in 8 sec

In case of GFSK: $2.88 \times \{(800 \div 6) / 20\} \times 8 = 153.60$ ms

In case of 8DPSK: $2.90 \times \{(800 \div 6) / 20\} \times 8 = 154.67$ ms

- Test plots

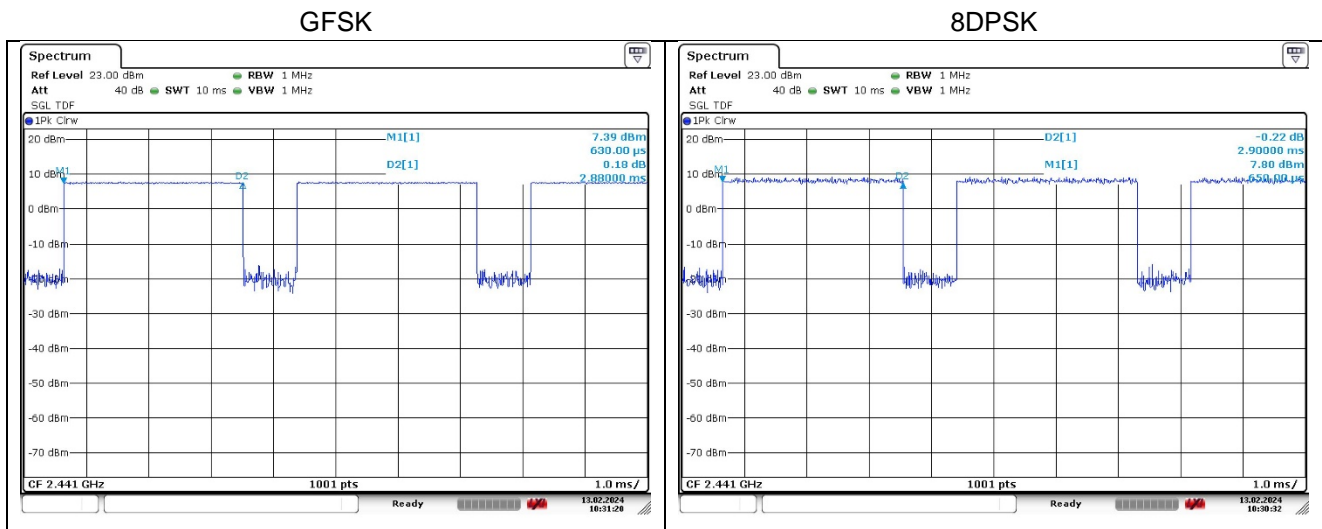

8. Antenna Requirement

8.1. Standard Applicable

For intentional device, according to FCC 47 CFR Section §15.203, an intentional radiator shall be designed to ensure that no antenna other than that furnished by the responsible party shall be used with the device. The use of a permanently attached antenna or of an antenna that uses a unique coupling to the intentional radiator shall be considered sufficient to comply with the provisions of this section. The manufacturer may design the unit so that a broken antenna can be replaced by the user, but the use of a standard antenna jack or electrical connector is prohibited. And according to FCC 47 CFR Section §15.247(b) if transmitting antennas of directional gain greater than 6 dB i are used, the conducted output power shall be reduced appropriate, by the amount in dB that the directional gain of the antenna exceeds 6 dB i.

8.2. Antenna Connected Construction

Antenna used in this product is FPCB antenna with gain of -0.26 dB i

- End of the Test Report -