

FCC/IC - TEST REPORT

Report Number : **68.950.22.0759.01** Date of Issue: **September 05, 2022**

Model / HVIN : **AT-SB2022, AT-SB727**

Product Type : **WIRELESS STEREO DISC PLAYER SYSTEM**

Applicant : **Audio-Technica Corporation**

Address : **2-46-1 Nishi-naruse, Machida, Tokyo, 194-8666 JAPAN**

Manufacturer : **Audio-Technica Corporation**

Address : **2-46-1 Nishi-naruse, Machida, Tokyo, 194-8666 JAPAN**

Test Result : **Positive** **Negative**

Total pages including Appendices : **67**

Any use for advertising purposes must be granted in writing. This technical report may only be quoted in full. This report is the result of a single examination of the object in question and is not generally applicable evaluation of the quality of other products in regular production. For further details, please see testing and certification regulation, chapter A-3.4.



1 Table of Contents

1	Table of Contents	2
2	Details about the Test Laboratory	3
3	Description of the Equipment Under Test	4
4	Summary of Test Standards	5
5	Summary of Test Results.....	6
6	General Remarks	7
7	Test Setups	8
8	Systems Test Configuration	9
9	Technical Requirement	10
9.1	Conducted Emission	10
9.2	Conducted Peak Output Power & EIRP.....	13
9.3	20 dB Bandwidth and 99% Occupied Bandwidth	15
9.4	Carrier Frequency Separation	25
9.5	Number of Hopping Frequencies.....	28
9.6	Dwell Time.....	31
9.7	Spurious RF Conducted Emissions	39
9.8	Band Edge Testing.....	54
9.9	Spurious Radiated Emissions for Transmitter	62
10	Test Equipment List.....	65
11	System Measurement Uncertainty	67



2 Details about the Test Laboratory

Details about the Test Laboratory

Company name: TÜV SÜD Certification and Testing (China) Co., Ltd. Shenzhen Branch
Building 12 & 13, Zhiheng Wisdomland Business Park, Guankou Erlu, Nantou,
Nanshan District, Shenzhen 518052, P.R. China

Telephone: 86 755 8828 6998
Fax: 86 755 828 5299

FCC Registration No.: 514049

FCC Designation Number: CA5009

IC Registration No.: 10320A

3 Description of the Equipment Under Test

Product:	WIRELESS STEREO DISC PLAYER SYSTEM
Model no.:	AT-SB2022, AT-SB727
Hardware Version Identification No. (HVIN)	V22
FCC ID:	JFZAT-SB2022
IC:	1752B-ATSB2022
Options and accessories:	N/A
Rating:	5.0VDC, 0.5A (supplied by adaptor) or 3.6VDC, 2100mAh, 7.56Wh (built-in type Lithium-ion Battery)
RF Transmission Frequency:	2402MHz-2480MHz
No. of Operated Channel:	79
Modulation:	GFSK, $\pi/4$ -DQPSK, 8DPSK
Antenna Type:	Integrated antenna
Antenna	Gain: 1.39dBi
Description of the EUT:	The Equipment Under Test (EUT) is a WIRELESS STEREO DISC PLAYER SYSTEM which support Bluetooth function (BR+EDR)

NOTE 1: The above EUT's information is declared by manufacturer. Please refer to the specifications or user's manual for more detailed description.

NOTE 2: Models AT-SB2022 and AT-SB727 are all identical except for model number and enclosure colour, So RF testing was applied on AT-SB2022, model AT-SB727 is deemed to fulfill relevant RF requirement without further testing.

4 Summary of Test Standards

Test Standards	
FCC Part 15 Subpart C 10-1-2021 Edition	PART 15 - RADIO FREQUENCY DEVICES Subpart C - Intentional Radiators
RSS-Gen Issue 5 April 2018 + A1 + A2	General Requirements for Compliance of Radio Apparatus
RSS-247 Issue 2 February 2017	Digital Transmission Systems (DTSS), Frequency Hopping Systems (FHSS) and License-Exempt Local Area Network (LE- LAN) Devices

All the test methods were according to KDB 558074 D01 15.247 Meas Guidance v05r02 Measurement Guidance and ANSI C63.10 (2013).

5 Summary of Test Results

Technical Requirements			
FCC Part 15 Subpart C/ RSS-247 Issue 2/RSS-Gen Issue 5			
Test Condition		Pages	Test Result
§15.207& RSS-Gen 8.8	Conducted emission AC power port	10	Pass
§15.247(b)(1) & RSS-247 5.4(b)	Conducted peak output power	13	Pass
RSS-247 5.4(b)	Equivalent Isotropic Radiated Power	13	Pass
§15.247(e) & RSS-247 5.2(b)	Power spectral density	--	N/A
§15.247(a)(2) & RSS-247 5.2(a) & RSS-Gen 6.7	6dB bandwidth and 99% Occupied Bandwidth	--	N/A
§15.247(a)(1) & RSS-247 5.1(a) & RSS-Gen 6.7	20dB bandwidth and 99% Occupied Bandwidth	15	Pass
§15.247(a)(1) & RSS-247 5.1(b)	Min. of Hopping Channel Carrier Frequency Separation	25	Pass
§15.247(a)(1)(iii) & RSS-247 5.1(d)	Min number of hopping frequencies	28	Pass
§15.247(a)(1)(iii) & RSS-247 5.1(d)	Dwell Time - Average Time of Occupancy	31	Pass
§15.247(d) & RSS-247 5.5	Spurious RF conducted emissions	34	Pass
§15.247(d) & RSS-247 5.5	Band edge	45	Pass
§15.247(d) & §15.209 & RSS-247 5.5 & RSS-Gen 6.13	Spurious radiated emissions for transmitter	51	Pass
§15.203 & RSS-Gen 6.8	Antenna requirement	See note 2	Pass

Note 1: N/A=Not Applicable.

Note 2: The EUT uses an external antenna and manufacturer will stick it down with glue, which gain is - 0.5dBi. In accordance to §15.203 & RSS-Gen 6.8, it is considered sufficiently to comply with the provisions of this section.

6 General Remarks

Remarks

This submittal(s) (test report) is intended for FCC ID: JFZAT-SB2022, IC: 1752B-ATSB2022, complies with Section 15.207, 15.209, 15.247 of the FCC Part 15, Subpart C rules and RSS-247, RSS-GEN.

SUMMARY:

All tests according to the regulations cited on page 5 were

■ - Performed

□ - **Not** Performed

The Equipment Under Test

■ - **Fulfills** the general approval requirements.

□ - **Does not** fulfill the general approval requirements.

Sample Received Date: May 27, 2022

Testing Start Date: April 27, 2022

Testing End Date: June 6, 2022

- TÜV SÜD Certification and Testing (China) Co., Ltd. Shenzhen Branch -

Reviewed by:



John Zhi
Project Manager

Prepared by:



Grace Gao
Project Engineer

Tested by:



Carry Cai
Test Engineer

7 Test Setups

7.1 AC Power Line Conducted Emission test setups

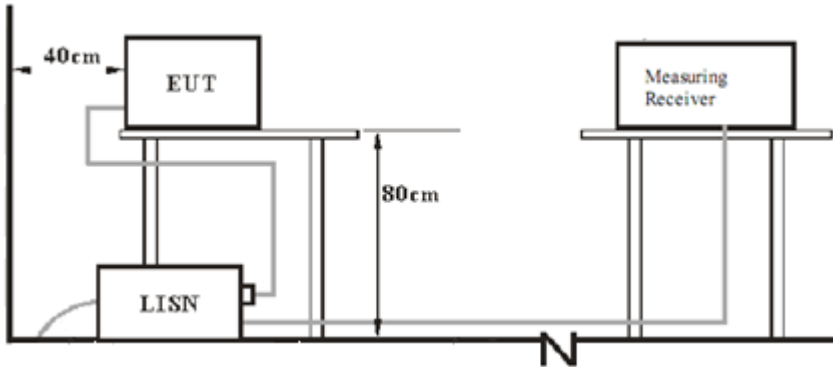

7.2 Radiated test setups Below 1GHz

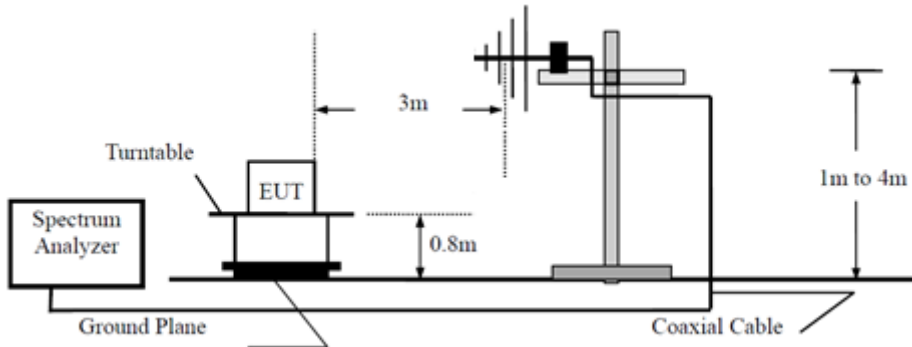

Above 1GHz

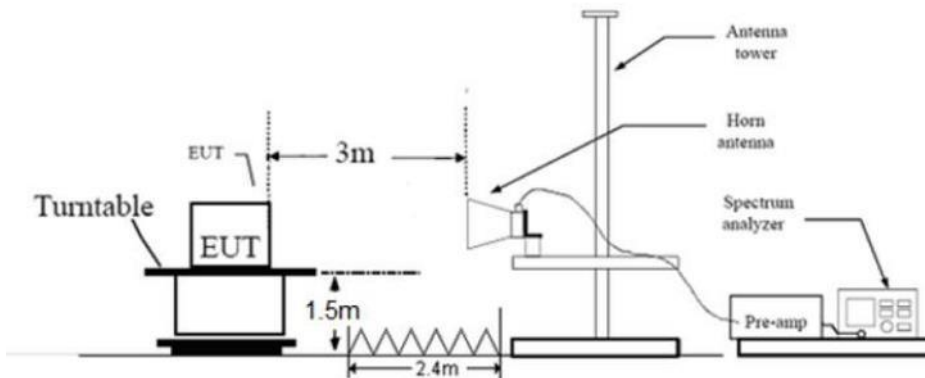

7.3 Conducted RF test setups

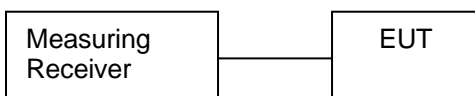

8 Systems Test Configuration

Auxiliary Equipment Used during Test:

Description	Manufacturer	Model NO.	S/N
Laptop	Thinkpad	T460S	SL10K24796JS
Adaptor (Input : 100-240VAC, 0.45A, 50-60Hz Output: 5VDC, 2A)	Apple	A1357	/
Vinyl disc	Chuhuoyinxiang	/	/
Stereo	/	/	/

Cables Used During Test:

Cable	Length	Shielded/unshielded	With / without ferrite
USB Charging Cable	1.523m	Unshielded	Without ferrite
RCA Audio line	1.23m	Unshielded	Without ferrite

The system was configured to hopping mode and non-hopping mode.

Hopping mode: typical working mode (normal hopping status)

Non-hopping mode: The system was configured to operate at a signal channel transmitting. The test software allows the configuration and operation at the worst-case duty and the highest transmit power

9 Technical Requirement

9.1 Conducted Emission

Test Method

1. The EUT was placed 0.4 meter from the conducting wall of the shielding room was kept at least 80 centimeters from any other grounded conducting surface.
2. Connect EUT to the power mains through a line impedance stabilization network (LISN).
3. All the support units are connecting to the other LISN.
4. The LISN provides 50 ohm coupling impedance for the measuring instrument.
5. Both sides of AC line were checked for maximum conducted interference.
6. The frequency range from 150 kHz to 30 MHz was searched.
7. Set the test-receiver system to Peak Detect Function and specified bandwidth (IF Bandwidth = 9kHz) with Maximum Hold Mode. Then measurement is also conducted by Average Detector and Quasi-Peak Detector Function respectively.

Limit

Frequency MHz	QP Limit dB μ V	AV Limit dB μ V
0.150-0.500	66-56*	56-46*
0.500-5	56	46
5-30	60	50

*Decreases with the logarithm of the frequency.

Conducted Emission

Product Type : WIRELESS STEREO DISC PLAYER SYSTEM
 M/N : AT-SB2022
 Operating Condition : Normal Working
 Test Specification : Line
 Comment : AC 120V/60Hz

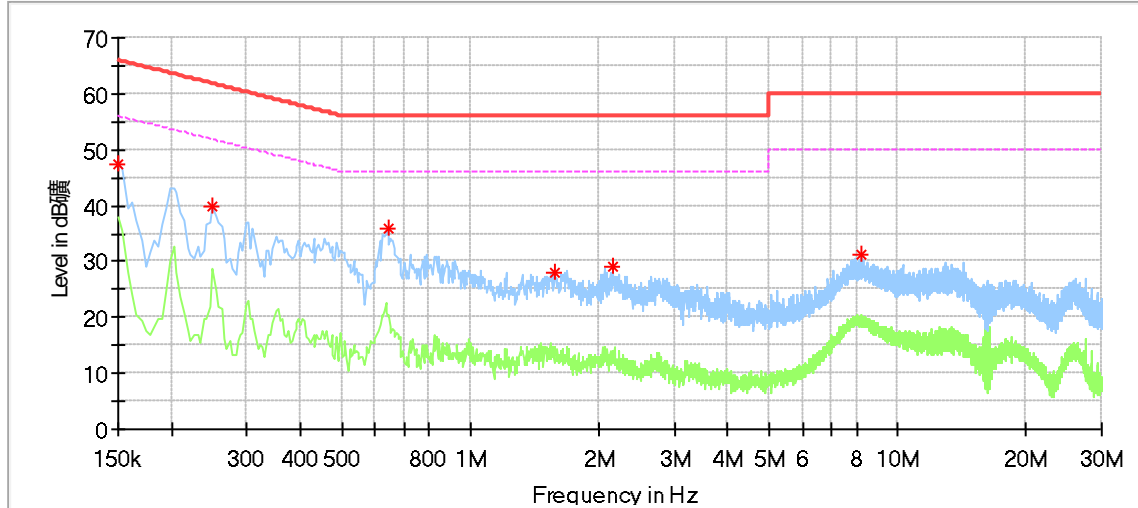

Critical Freqs

Frequency (MHz)	MaxPeak (dBμV)	Average (dBμV)	Limit (dBμV)	Margin (dB)	Line	Corr. (dB)
0.150000	47.21	---	66.00	18.79	L1	9.25
0.250000	39.83	---	61.76	21.93	L1	9.23
0.642000	35.78	---	56.00	20.22	L1	9.20
1.578000	28.11	---	56.00	27.89	L1	9.22
2.158000	28.90	---	56.00	27.10	L1	9.23
8.250000	31.13	---	60.00	28.87	L1	9.38

Final Result

Frequency (MHz)	QuasiPeak (dBμV)	Average (dBμV)	Limit (dBμV)	Margin (dB)	Line	Corr. (dB)
---	---	---	---	---		---

Remark:

Max Peak= Read level + Corrector factor

Correct factor=cable loss + LISN factor

Conducted Emission

Product Type : WIRELESS STEREO DISC PLAYER SYSTEM
 M/N : AT-SB2022
 Operating Condition : Normal Working
 Test Specification : Neutral
 Comment : AC 120V/60Hz

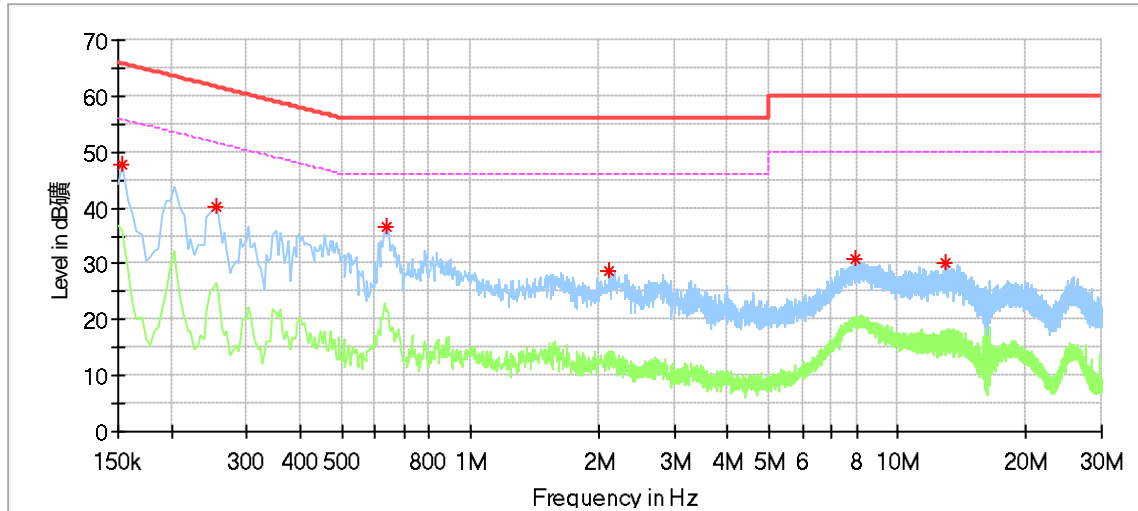

Critical Freqs

Frequency (MHz)	MaxPeak (dBμV)	Average (dBμV)	Limit (dBμV)	Margin (dB)	Line	Corr. (dB)
0.154000	47.58	---	65.78	18.20	N	9.40
0.254000	40.06	---	61.63	21.57	N	9.39
0.638000	36.51	---	56.00	19.49	N	9.39
2.106000	28.77	---	56.00	27.23	N	9.42
7.974000	30.89	---	60.00	29.11	N	9.58
12.950000	30.07	---	60.00	29.93	N	9.62

Final Result

Frequency (MHz)	QuasiPeak (dBμV)	Average (dBμV)	Limit (dBμV)	Margin (dB)	Line	Corr. (dB)
---	---	---	---	---		---

Remark:

Max Peak= Read level + Corrector factor

Correct factor=cable loss + LISN factor

9.2 Conducted Peak Output Power & EIRP

Test Method

1. The RF output of EUT was connected to the test receiver by RF cable. The path loss was compensated to the results for each measurement.
2. Set to the maximum power setting and enable the EUT transmit continuously
3. Use the following test receiver settings:
Span = approximately 5 times the 20dB bandwidth, centered on a hopping channel
RBW > the 20dB bandwidth of the emission being measured, VBW ≥ RBW,
Sweep = auto, Detector function = peak, Trace = max hold
4. Allow the trace to stabilize. Use the marker-to-peak function to set the marker to the peak of the emission. The indicated level is the peak output power and record the results in the test report.
5. Repeat above procedures until all frequencies measured were complete.

Limits

According to §15.247 (b) (1) & RSS-247 5.4(b), conducted peak output power limit as below:

Frequency Range MHz	Limit W	Limit dBm
2400-2483.5	≤1	≤30

According to & RSS-247 5.4(b), EIRP limit as below:

Frequency Range MHz	Limit W	Limit dBm
2400-2483.5	≤4	≤36

Conducted Peak Output Power & EIRP

Bluetooth Mode GFSK modulation Test Result

Frequency MHz	Conducted Peak Output Power dBm	Antenna Gain dBi	EIRP dBm	Result
Low channel 2402MHz	6.11	1.39	7.50	Pass
Middle channel 2441MHz	5.49	1.39	6.88	Pass
High channel 2480MHz	5.05	1.39	6.44	Pass

Bluetooth Mode $\pi/4$ -DQPSK modulation Test Result

Frequency MHz	Conducted Peak Output Power dBm	Antenna Gain dBi	EIRP dBm	Result
Low channel 2402MHz	6.34	1.39	7.73	Pass
Middle channel 2441MHz	5.74	1.39	7.13	Pass
High channel 2480MHz	5.29	1.39	6.68	Pass

Bluetooth Mode 8DPSK modulation Test Result

Frequency MHz	Conducted Peak Output Power dBm	Antenna Gain dBi	EIRP dBm	Result
Low channel 2402MHz	5.76	1.39	7.15	Pass
Middle channel 2441MHz	5.12	1.39	6.51	Pass
High channel 2480MHz	4.67	1.39	6.06	Pass

9.3 20 dB Bandwidth and 99% Occupied Bandwidth

Test Method

1. The RF output of EUT was connected to the test receiver by RF cable. The path loss was compensated to the results for each measurement.
2. Set to the maximum power setting and enable the EUT transmit continuously.
3. Use the following test receiver settings:
 Span = approximately 5 times the 20dB bandwidth, centered on a hopping channel
 RBW > the 20dB bandwidth of the emission being measured, VBW ≥ RBW,
 Sweep = auto, Detector function = peak, Trace = max hold
4. Allow the trace to stabilize. Use the marker-to-peak function to set the marker to the peak of the emission. Measure the frequency difference of two frequencies that were attenuated 20 dB from the reference level. Record the frequency difference as the emission bandwidth. Record the results.
5. Repeat above procedures until all frequencies measured were complete.

Limit

Limit [kHz]

N/A

20 dB bandwidth and 99% Occupied Bandwidth

Bluetooth Mode GFSK Modulation test result

Frequency MHz	20 dB Bandwidth MHz	99% Bandwidth MHz	Limit MHz	Result
2402	1.119	0.869	--	Pass
2441	1.116	0.869	--	Pass
2480	1.116	0.863	--	Pass

Low channel 2402MHz

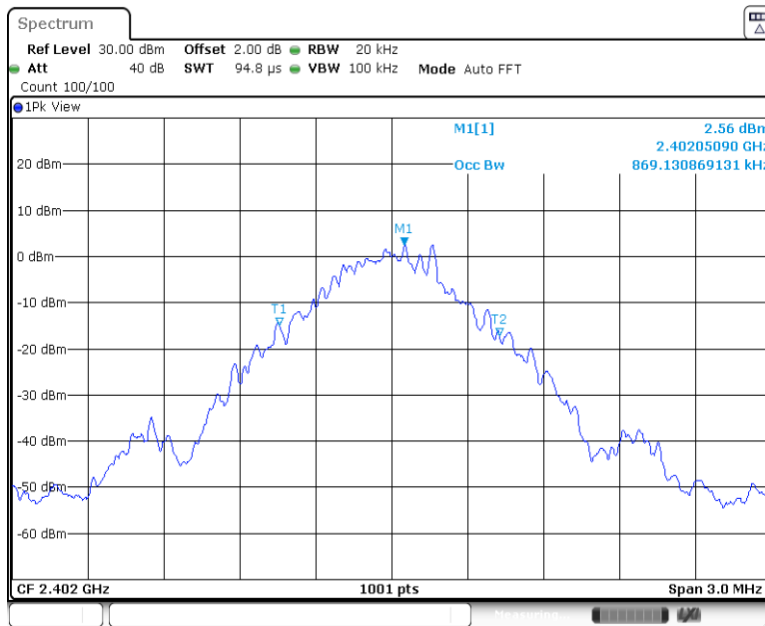

Date: 17.AUG.2022 17:09:50

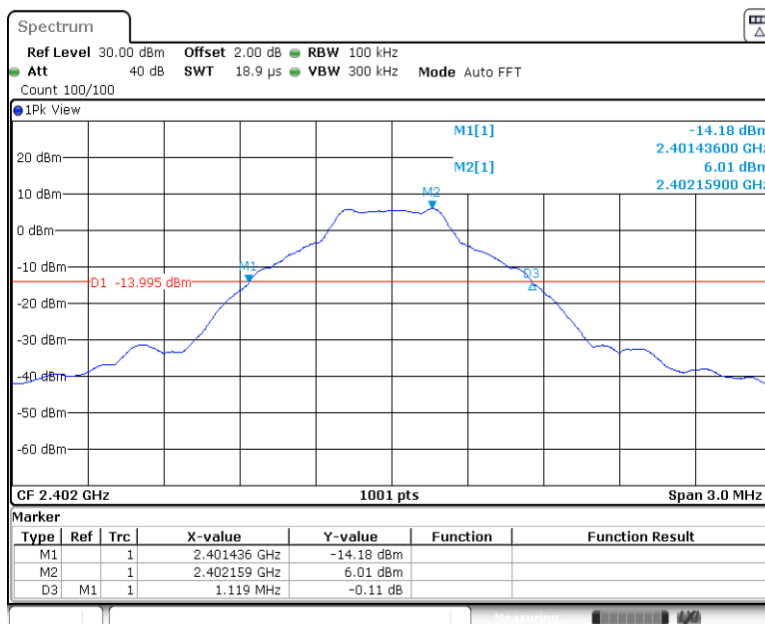

Date: 17.AUG.2022 17:09:39

20 dB bandwidth and 99% Occupied Bandwidth

Middle channel 2441MHz

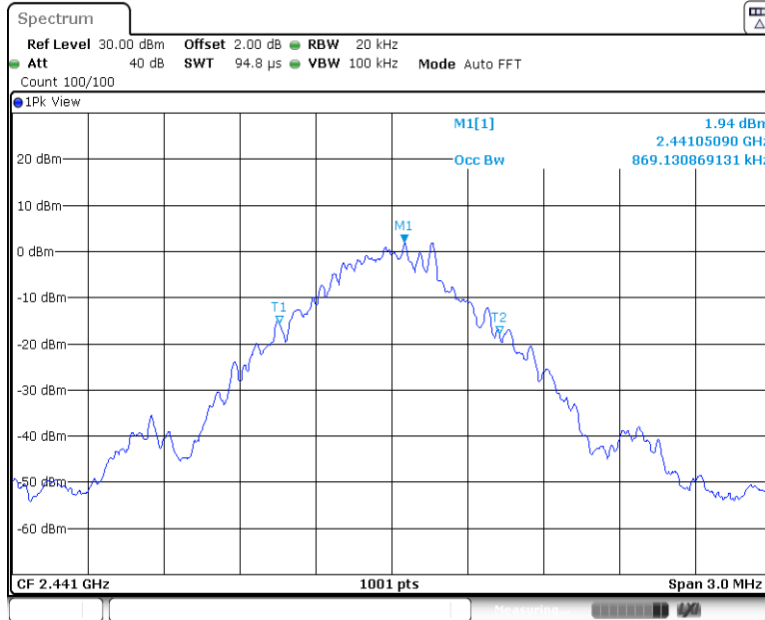

Date: 17.AUG.2022 17:11:51

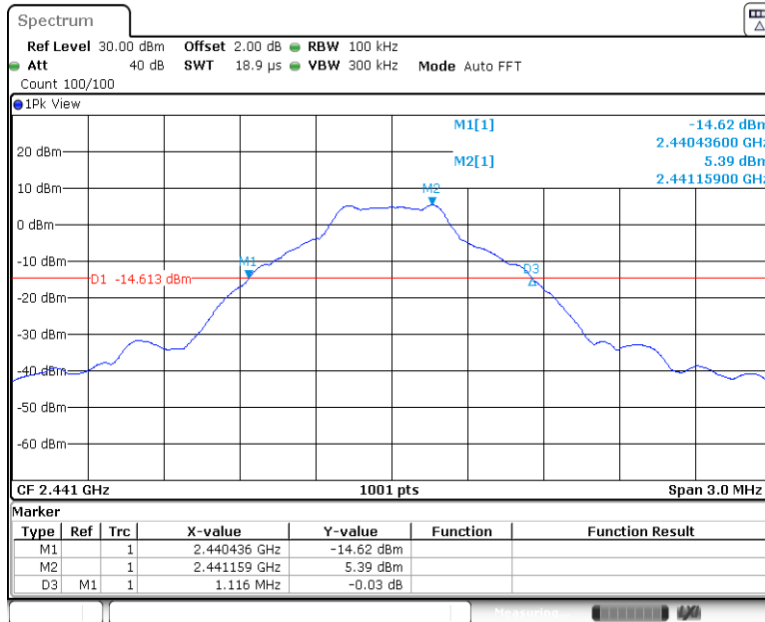

Date: 17.AUG.2022 17:11:40

20 dB bandwidth and 99% Occupied Bandwidth

High channel 2480MHz

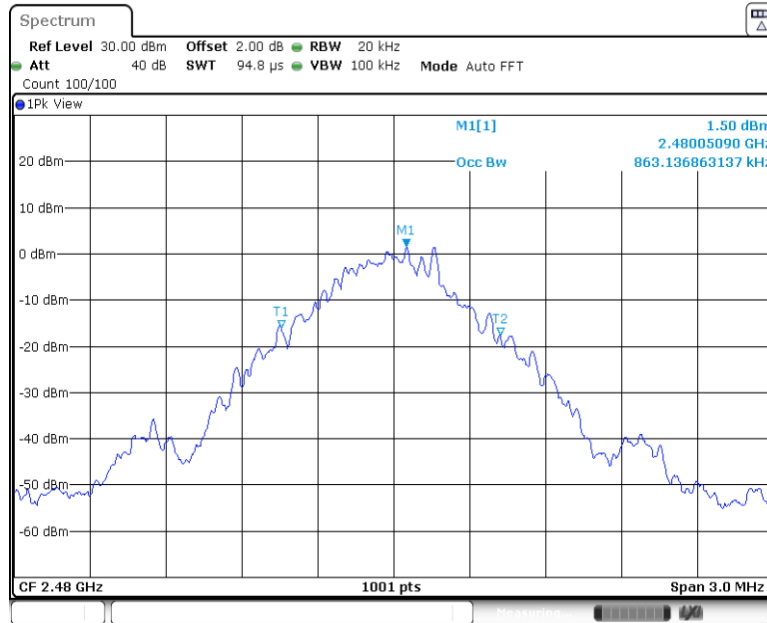

Date: 17.AUG.2022 17:13:43

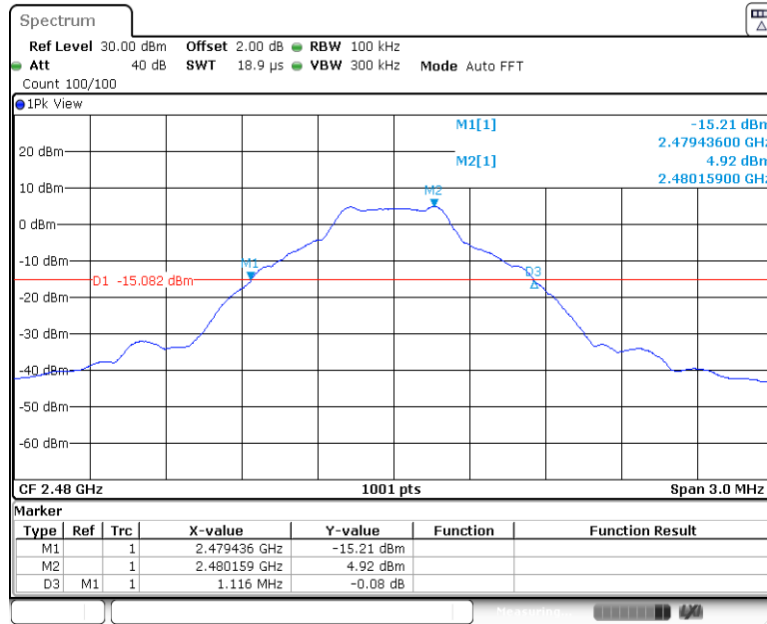

Date: 17.AUG.2022 17:13:32

20 dB bandwidth and 99% Occupied Bandwidth

Bluetooth Mode $\pi/4$ -DQPSK Modulation test result

Frequency MHz	20 dB Bandwidth MHz	99% Bandwidth MHz	Limit MHz	Result
2402	1.404	1.187	--	Pass
2441	1.401	1.187	--	Pass
2480	1.398	1.187	--	Pass

Low channel 2402MHz

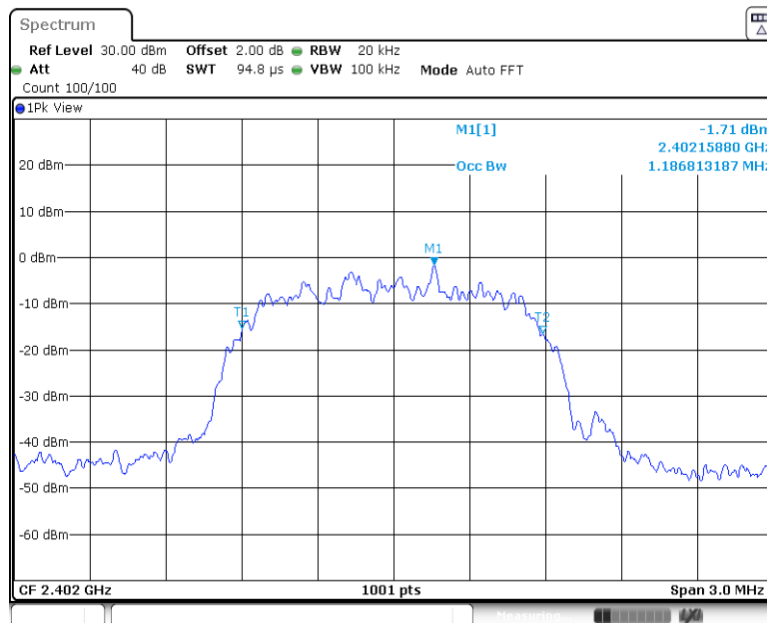

Date: 17.AUG.2022 17:16:17

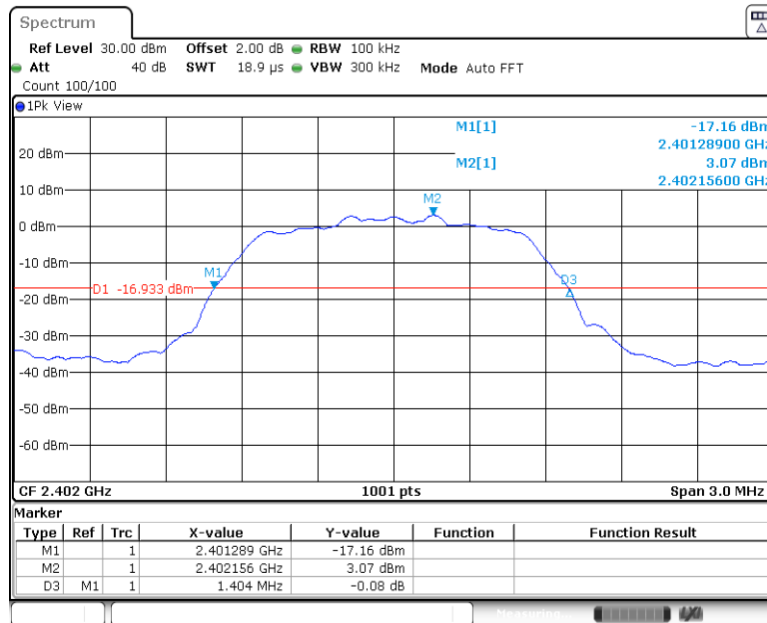

Date: 17.AUG.2022 17:16:06

20 dB bandwidth and 99% Occupied Bandwidth

Middle channel 2441MHz

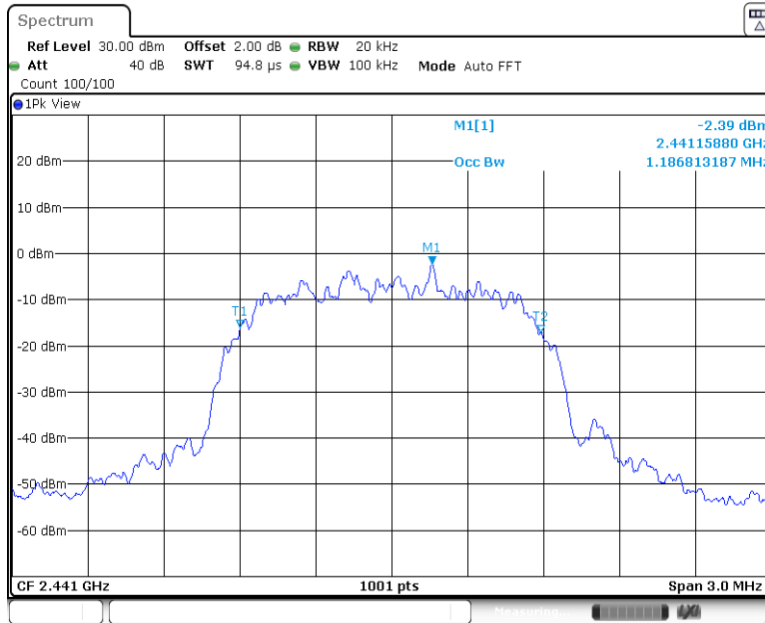

Date: 17.AUG.2022 17:17:59

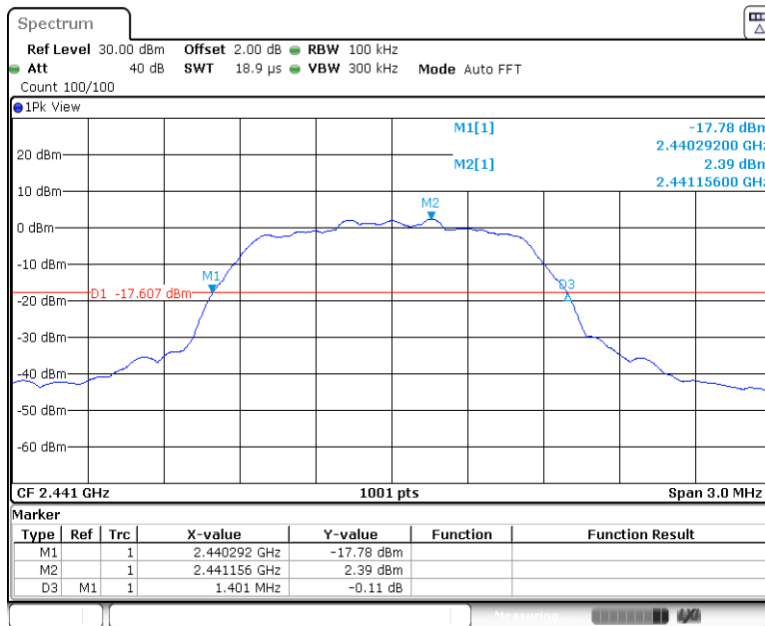

Date: 17.AUG.2022 17:17:48

20 dB bandwidth and 99% Occupied Bandwidth

High channel 2480MHz

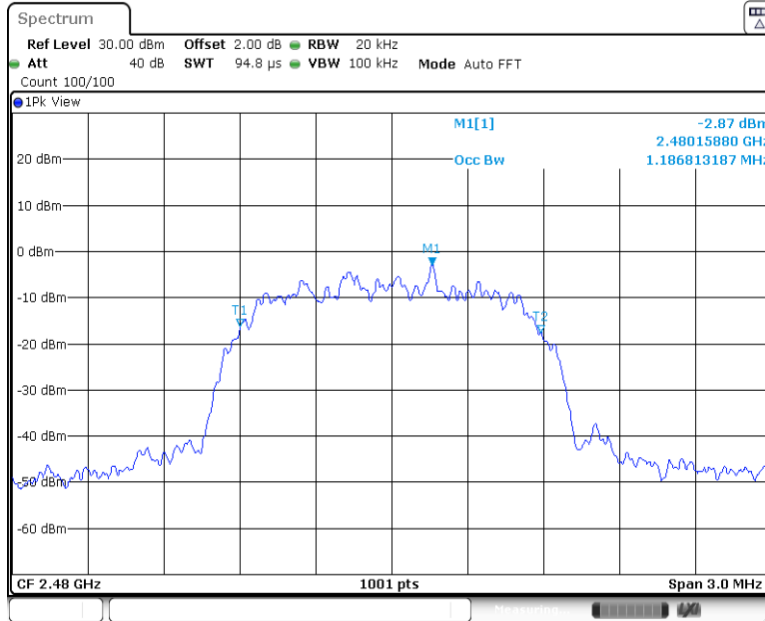

Date: 17.AUG.2022 17:19:37

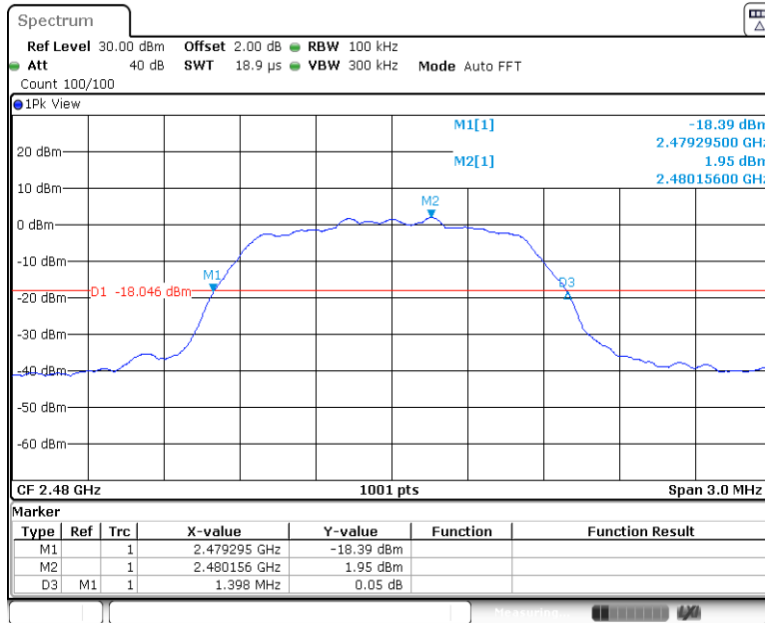

Date: 17.AUG.2022 17:19:26

20 dB bandwidth and 99% Occupied Bandwidth

Bluetooth Mode 8DPSK Modulation test result

Frequency MHz	20 dB Bandwidth MHz	99% Bandwidth MHz	Limit MHz	Result
2402	1.395	1.193	--	Pass
2441	1.395	1.19	--	Pass
2480	1.392	1.187	--	Pass

Low channel 2402MHz

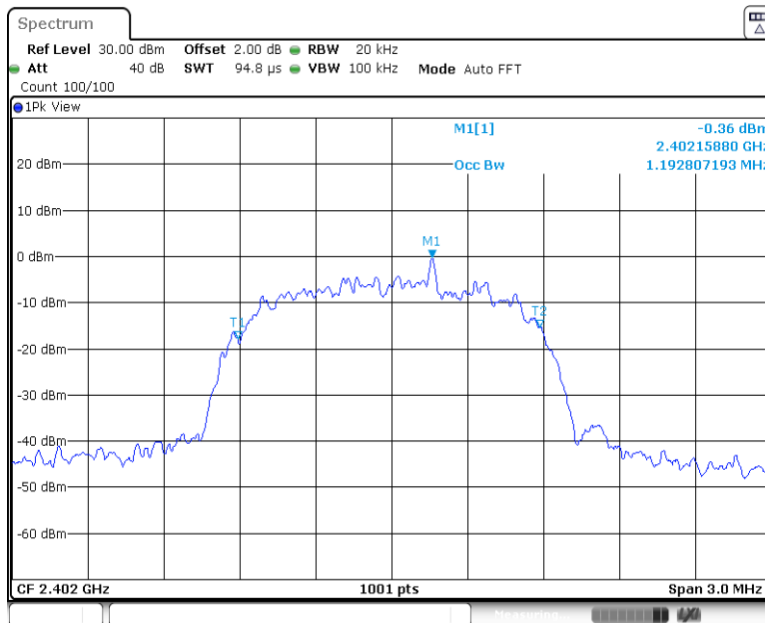

Date: 17.AUG.2022 17:21:58

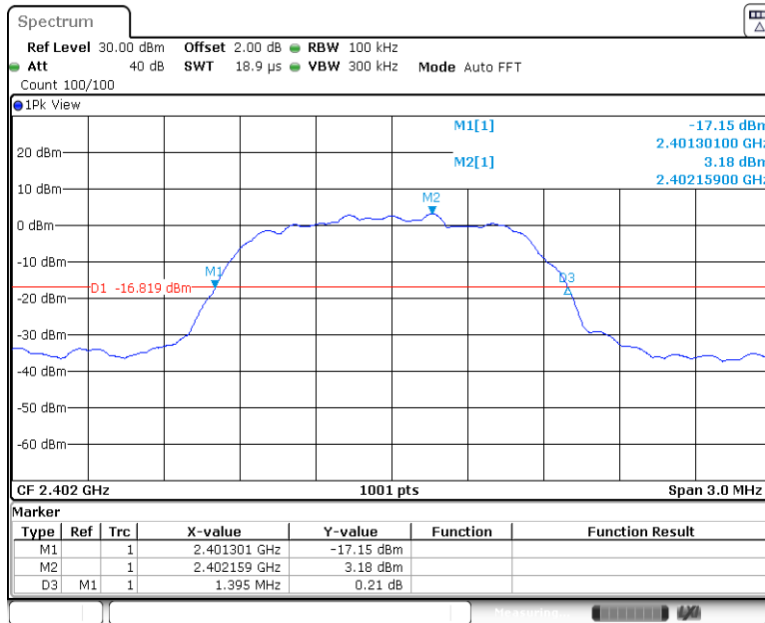

Date: 17.AUG.2022 17:21:48

20 dB bandwidth and 99% Occupied Bandwidth

Middle channel 2441MHz

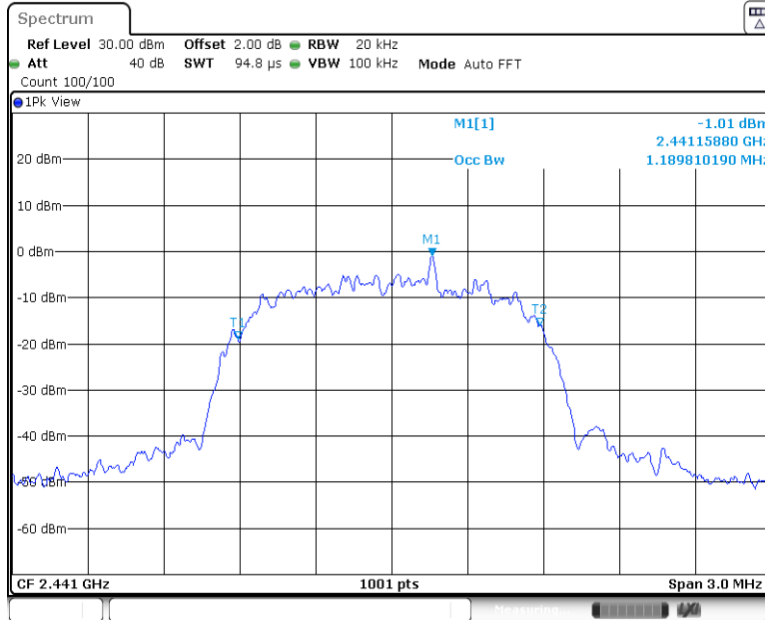

Date: 17.AUG.2022 17:23:51

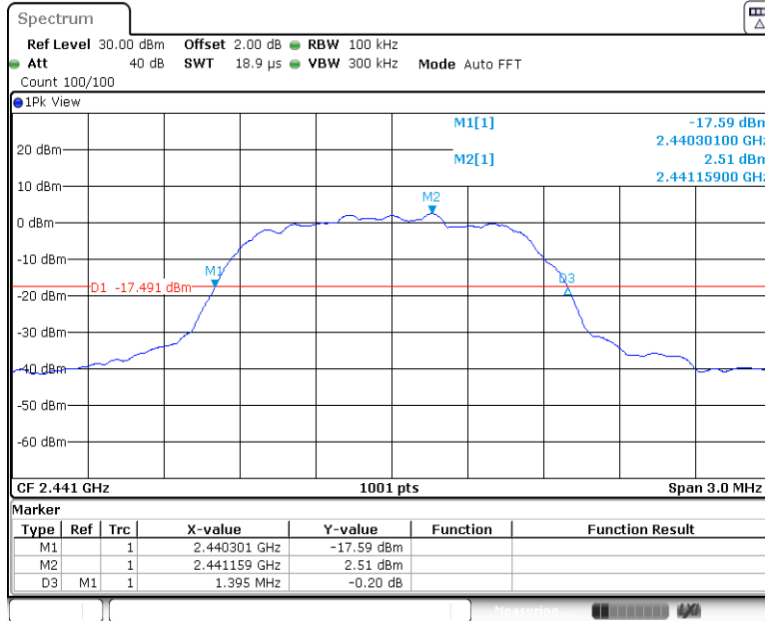

Date: 17.AUG.2022 17:23:40

20 dB bandwidth and 99% Occupied Bandwidth

High channel 2480MHz

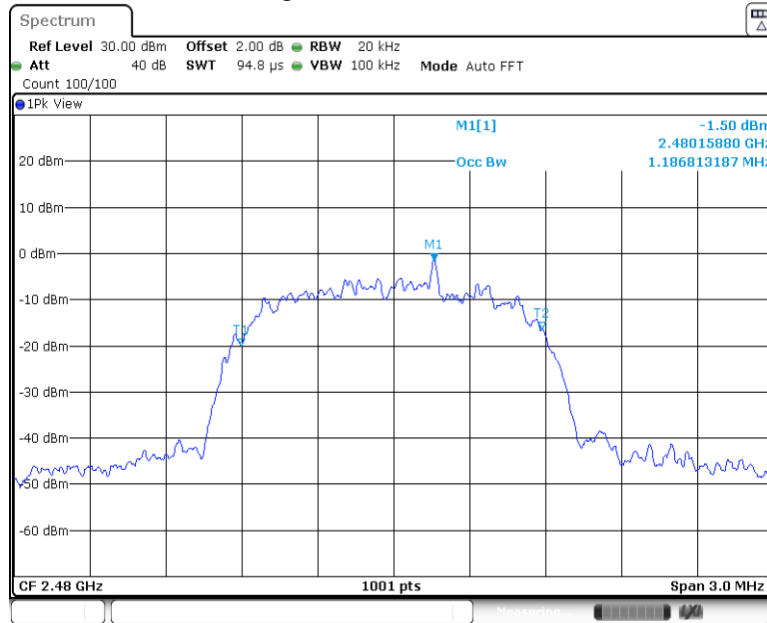

Date: 17.AUG.2022 17:25:23

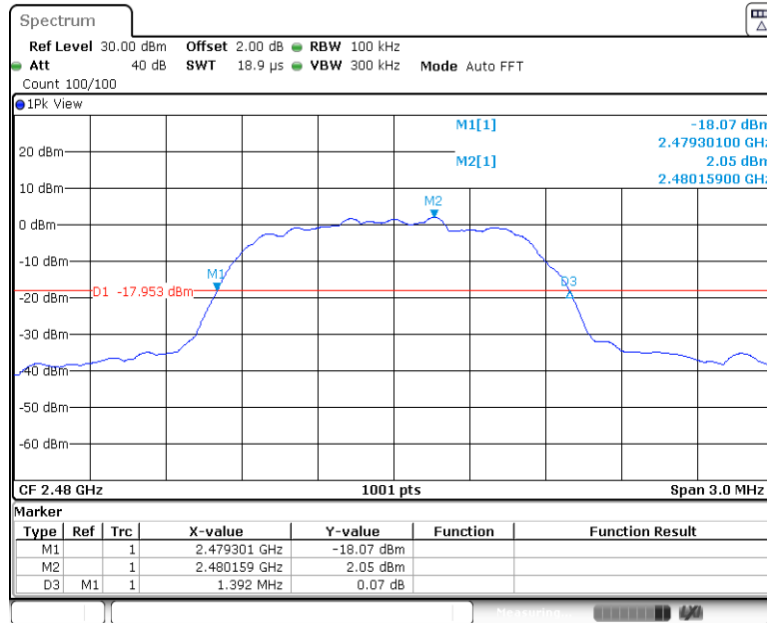

Date: 17.AUG.2022 17:25:12

9.4 Carrier Frequency Separation

Test Method

1. The RF output of EUT was connected to the test receiver by RF cable The path loss was compensated to the results for each measurement.
2. Set to the maximum power setting and enable the EUT transmit to hopping mode.
3. Use the following spectrum analyzer settings:
Span = wide enough to capture the peaks of two adjacent channels, RBW \geq 1% of the span, VBW) \geq RBW, Sweep = auto, Detector function = peak
4. By using the Max-Hold function record the separation of two adjacent channels.
5. Measure the frequency difference of these two adjacent channels by spectrum analyzer marker function. Record the results.
6. Repeat above procedures until all frequencies measured were complete.

Limit

Limit kHz
≥25kHz or 2/3 of the 20 dB bandwidth which is greater

Limit

Frequency MHz	2/3 of 20 dB Bandwidth kHz
2402	887
2441	940
2480	940

Carrier Frequency Separation

Test result: The measurement was performed with the typical configuration (normal hopping status).

Modulation	Frequency MHz	Carrier Frequency Separation MHz	Result
GFSK	2441	1	Pass
$\pi/4$ -DQPSK	2441	1	Pass
8DPSK	2441	1	Pass

GFSK Mode: 2441MHz

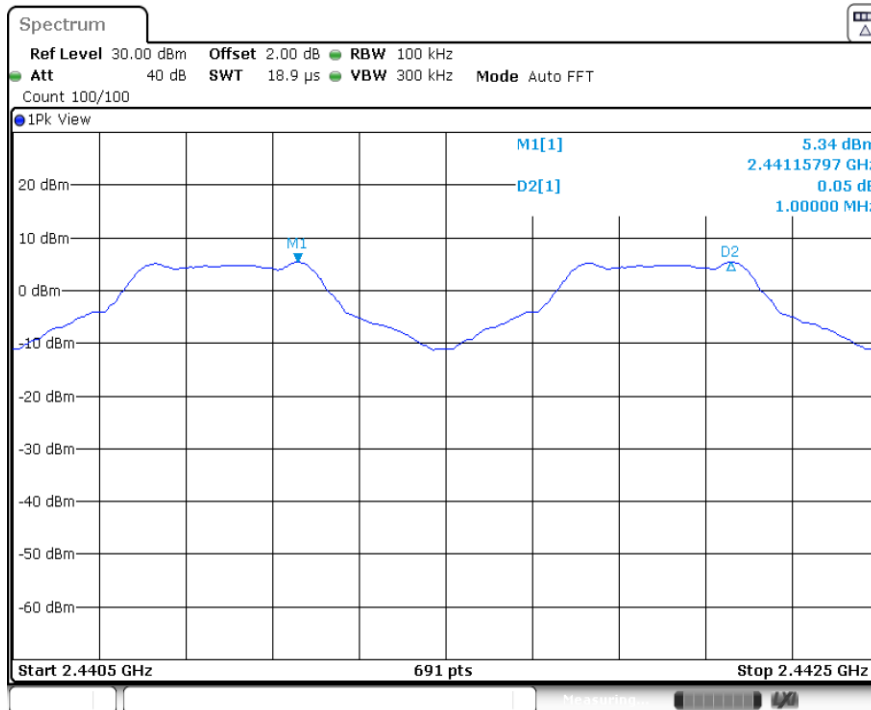

Date: 17.AUG.2022 17:28:47

Carrier Frequency Separation

$\pi/4$ -DQPSK Mode: 2441MHz

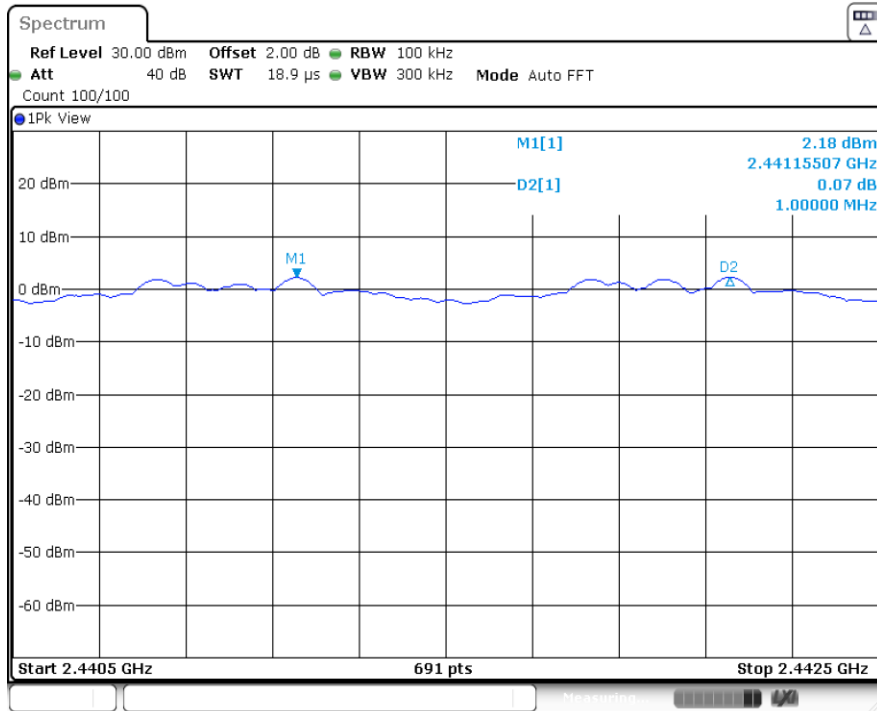

Date: 17.AUG.2022 17:44:45

8DPSK Mode: 2480MHz

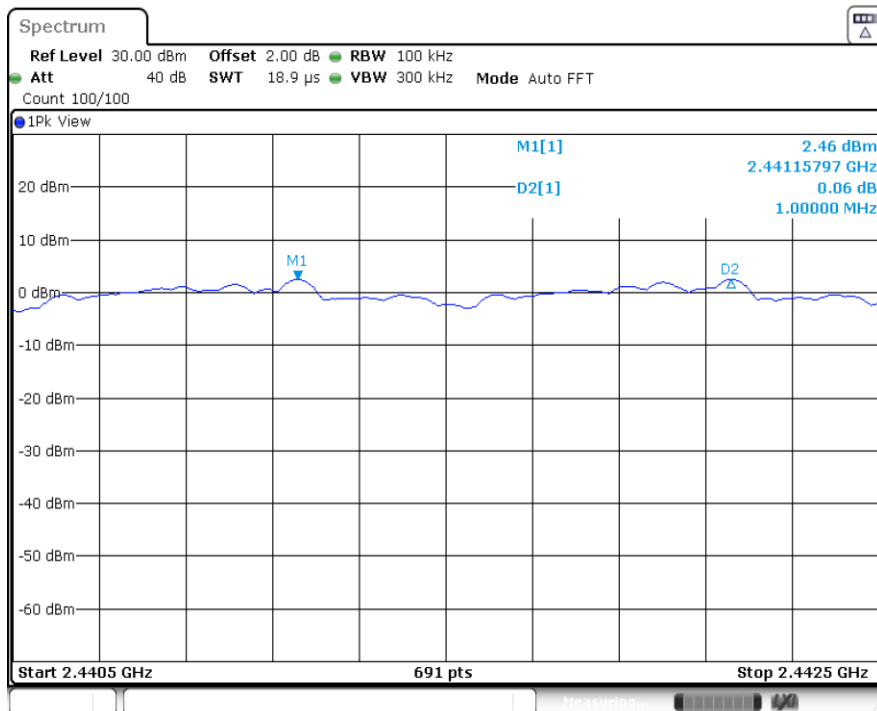

Date: 17.AUG.2022 17:49:17

9.5 Number of Hopping Frequencies

Test Method

1. The RF output of EUT was connected to the test receiver by RF cable. The path loss was compensated to the results for each measurement.
2. Set to the maximum power setting and enable the EUT transmit to hopping mode.
3. Use the following spectrum analyzer settings:
Span = wide enough to capture the peaks of two adjacent channels, $RBW \geq 1\%$ of the span, $VBW \geq RBW$, Sweep = auto, Detector function = peak
4. Set the spectrum analyzer on Max-Hold Mode,
5. Record all the signals from each channel until each one has been recorded.
6. Repeat above procedures until all frequencies measured were complete.

Limit

Limit
number
—————
 ≥ 15

Number of Hopping Frequencies

Test result: The measurement was performed with the typical configuration (normal hopping status), and the total hopping channels is constant for the all modulation mode according with the Bluetooth Core Specification.

Number of hopping frequencies	Result
79	Pass

GFSK Mode

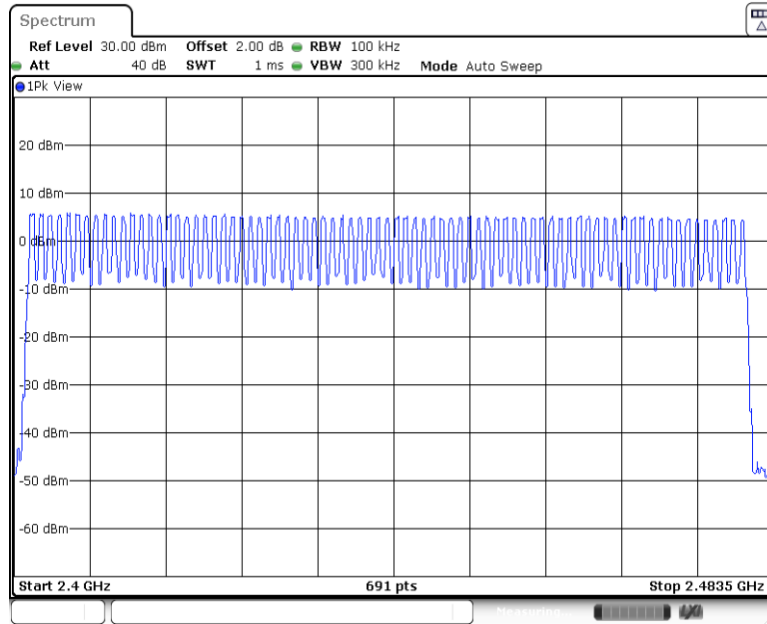

Date: 17.AUG.2022 17:29:16

$\pi/4$ -DQPSK Mode

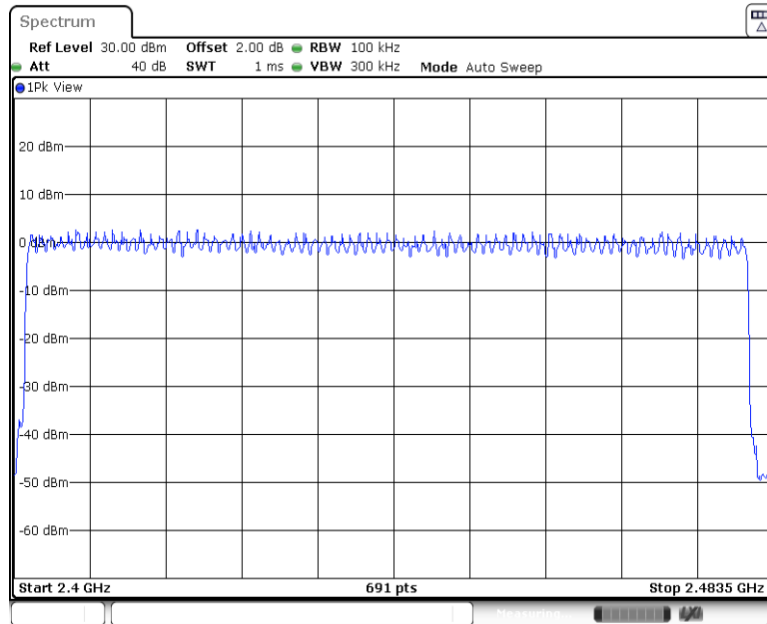

Date: 17.AUG.2022 17:45:04

Number of Hopping Frequencies

8DPSK Mode

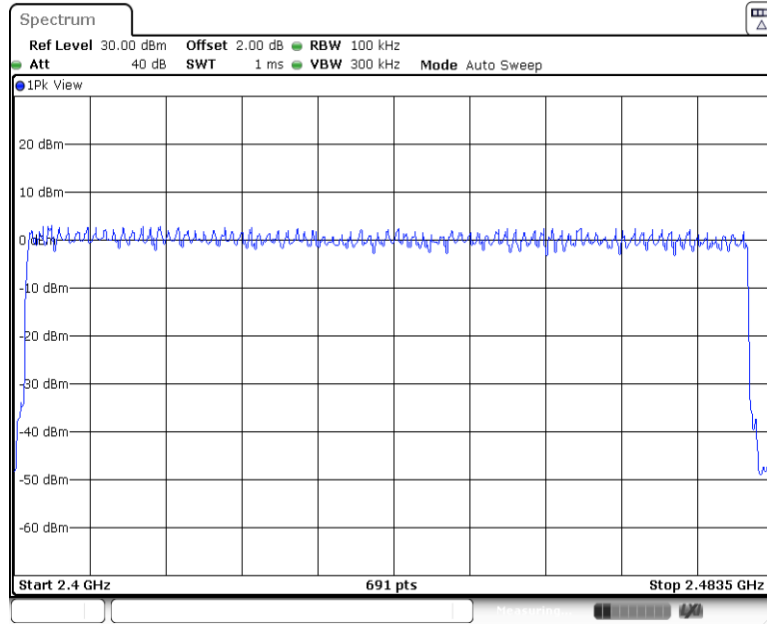

Date: 17.AUG.2022 17:49:45

9.6 Dwell Time

Test Method

1. The RF output of EUT was connected to the test receiver by RF cable. The path loss was compensated to the results for each measurement.
2. Set to the maximum power setting and enable the EUT transmit to hopping mode.
3. Use the following spectrum analyzer settings:
RBW: 1MHz; VBW: 1MHz; SPAN: Zero Span
Set the spectrum analyzer on Max-Hold Mode,
4. Adjust the center frequency of spectrum analyzer on any frequency be measured.
5. Measure the Dwell Time by spectrum analyzer Marker function. Record the results.
Dwell Time = Burst Width * Total Hops
6. Repeat above procedures until all frequencies measured were complete.

Limit

The average time of occupancy on any frequency shall not be greater than 0.4 seconds within a period of 0.4 seconds multiplied by the number of hopping channels employed.

Dwell Time

Dwell time

The maximum dwell time shall be 0.4 s.

According to the Bluetooth Core Specification, the worse result (DH5 mode) was reported to show compliance.

The Dwell Time = Burst Width * Total Hops. The detailed calculations are showed as follows:

The duration for dwell time calculation: 0.4 [s] * hopping number = 0.4 [s] * 79 [ch] = 31.6 [s*ch];

The burst width, which is directly measured, refers to the duration on one channel hop.

Test Result

Test Mode	Antenna	Channel	Burst Width (ms)	Total Hops	Result (s)	Limit (s)	Verdict
DH1	Ant0	Hop	0.38	320	0.122	<=0.4	PASS
DH5	Ant0	Hop	2.87	60	0.172	<=0.4	PASS
2DH1	Ant0	Hop	0.38	320	0.123	<=0.4	PASS
2DH5	Ant0	Hop	2.87	130	0.373	<=0.4	PASS
3DH1	Ant0	Hop	0.38	320	0.123	<=0.4	PASS
3DH5	Ant0	Hop	2.87	90	0.258	<=0.4	PASS

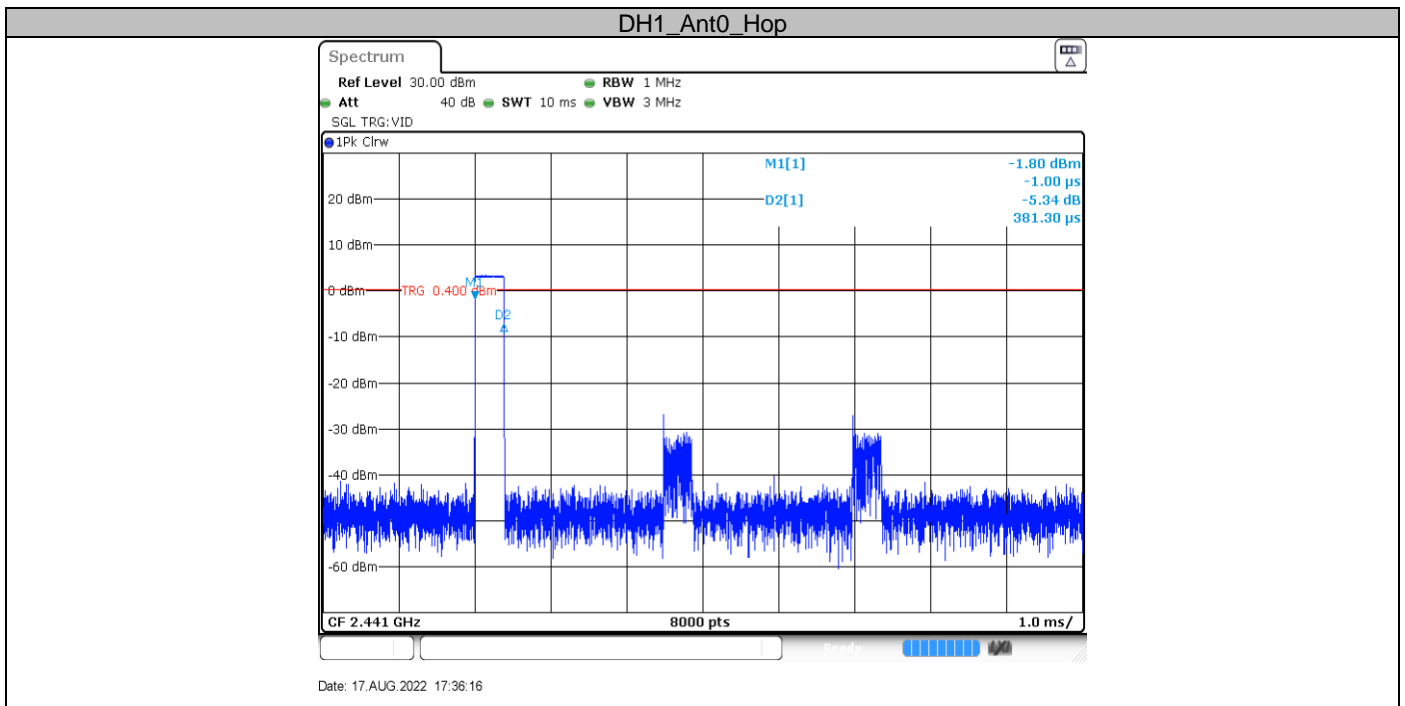

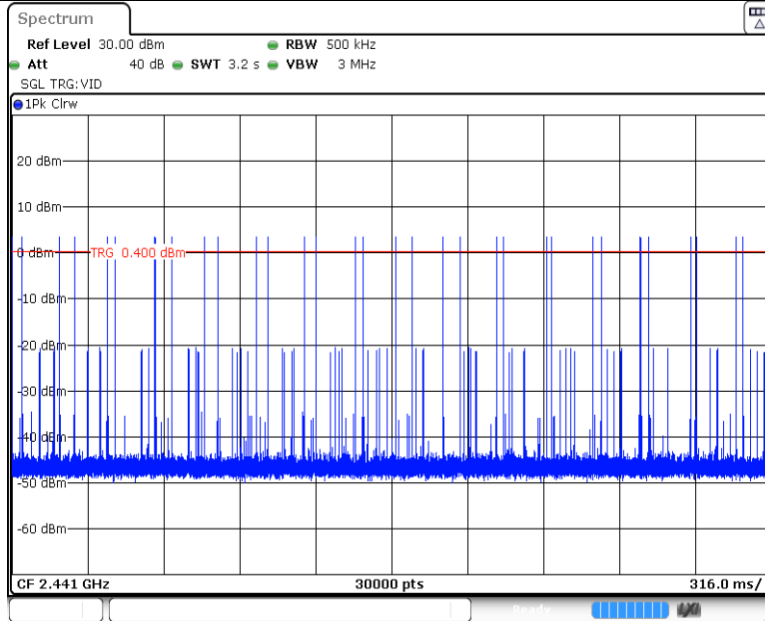

Date: 17.AUG.2022 17:36:21

DH5_Ant0_Hop

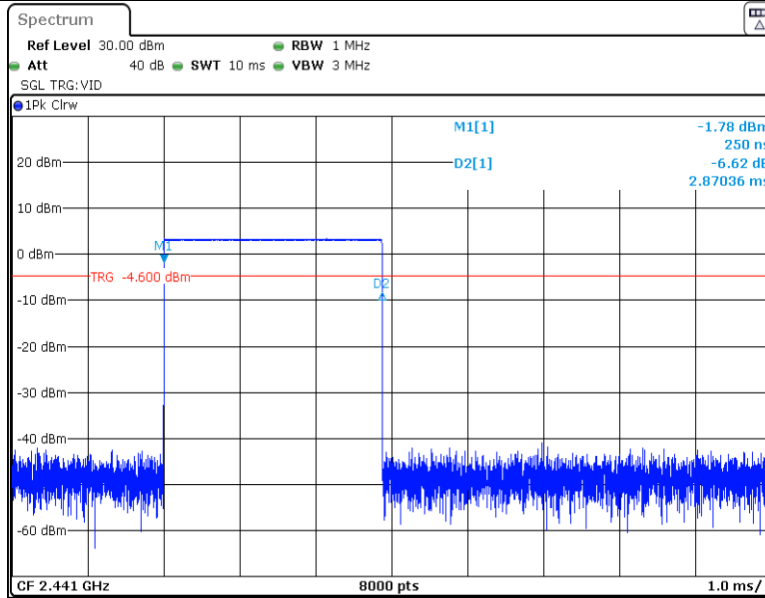

Date: 17.AUG.2022 17:35:13

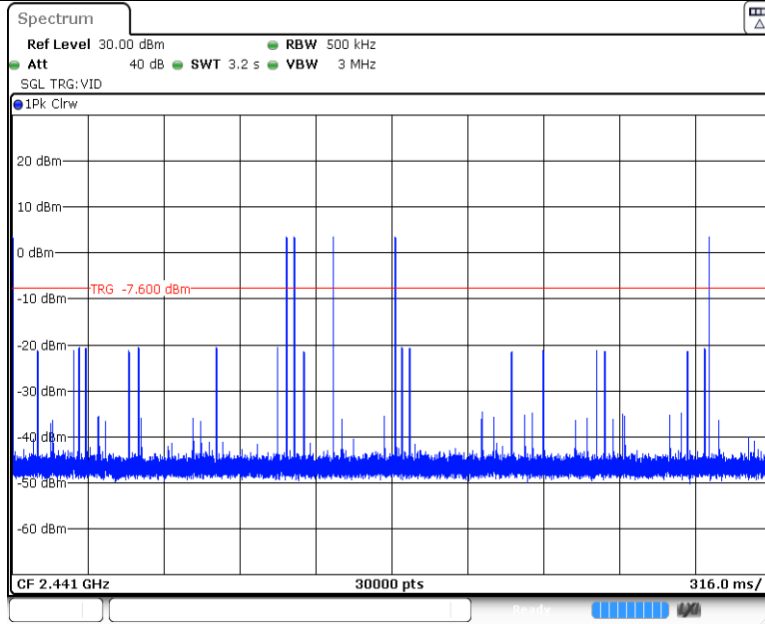

Date: 17.AUG.2022 17:35:19

2DH1_Ant0_Hop

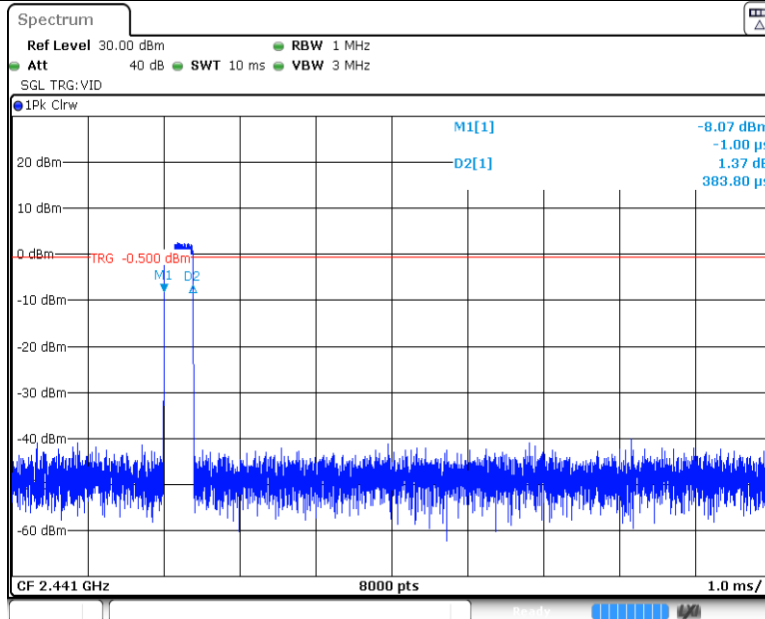

Date: 17.AUG.2022 17:46:00

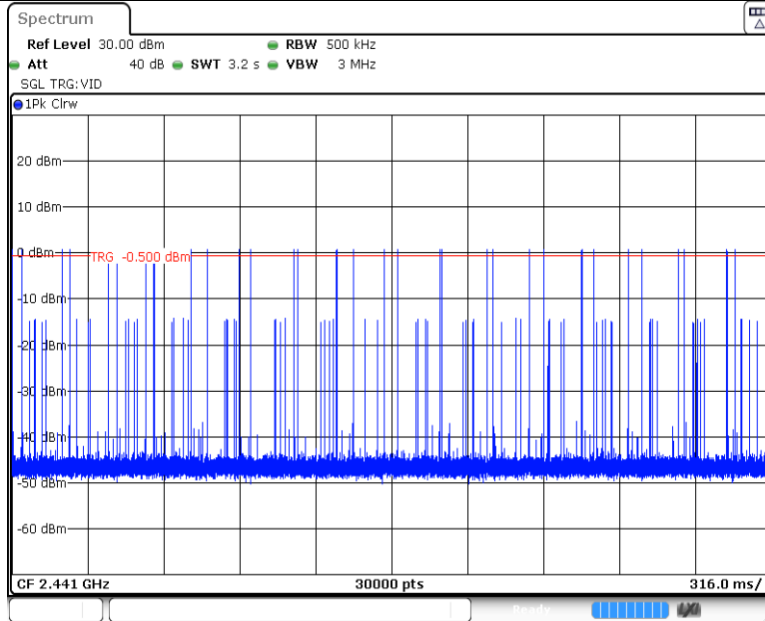

Date: 17.AUG.2022 17:46:05

2DH5_Ant0_Hop

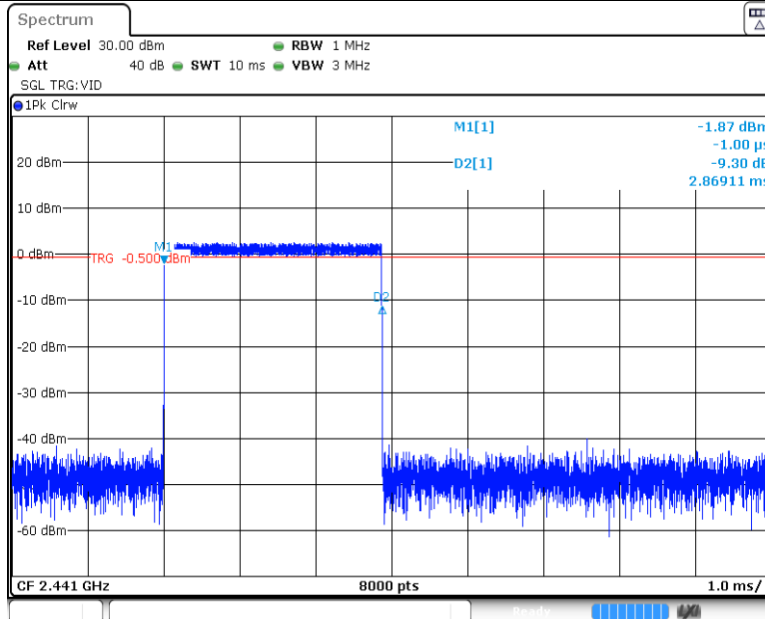

Date: 17.AUG.2022 17:45:16

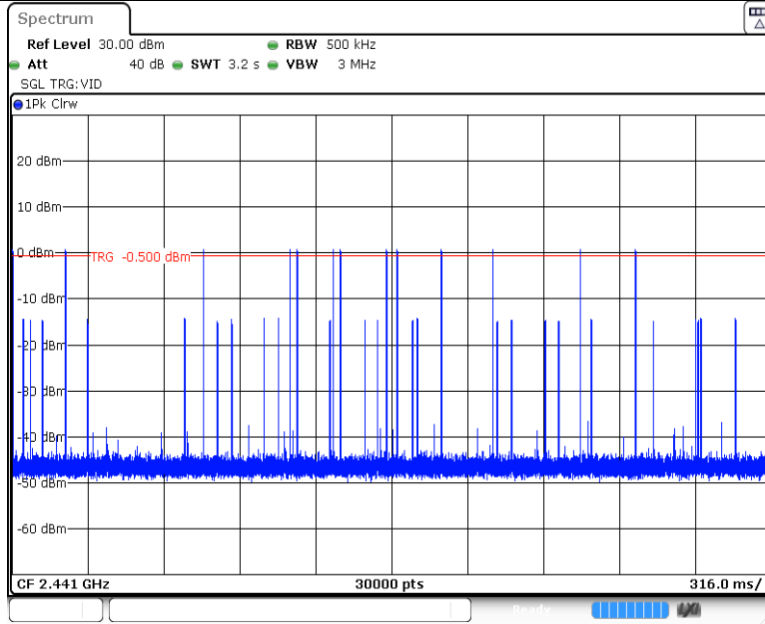

Date: 17.AUG.2022 17:45:21

3DH1_Ant0_Hop

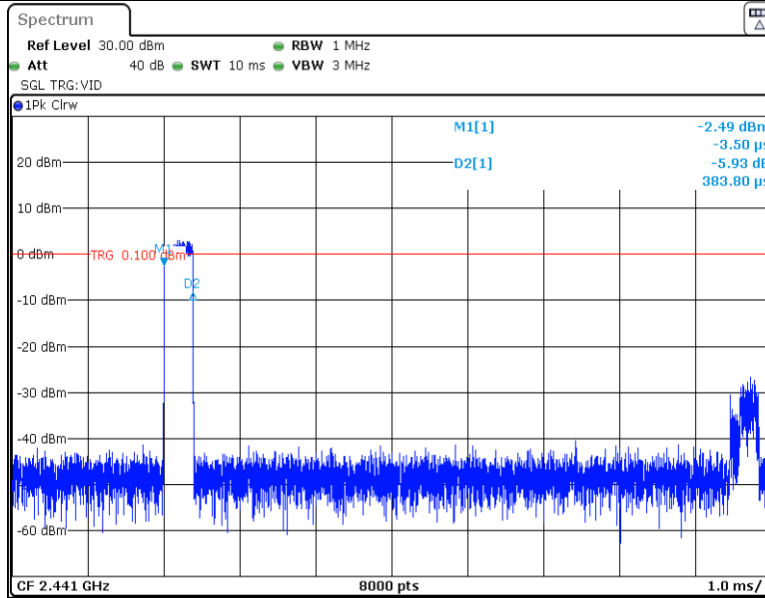

Date: 17.AUG.2022 17:50:52

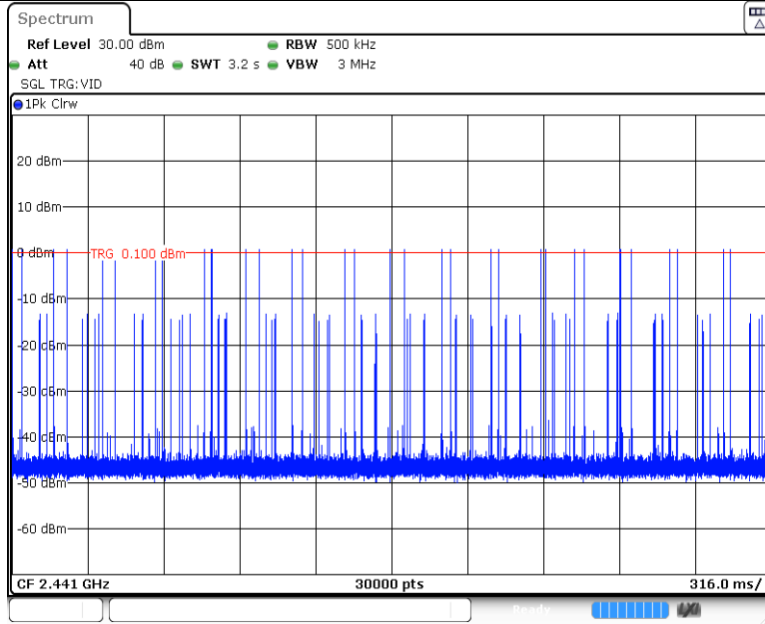

Date: 17.AUG.2022 17:50:58

3DH5_Ant0_Hop

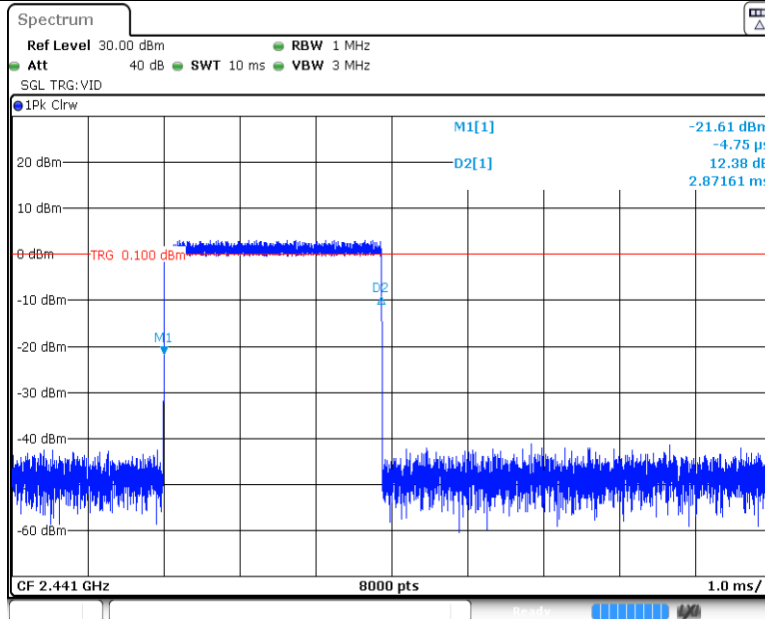

Date: 17.AUG.2022 17:49:58

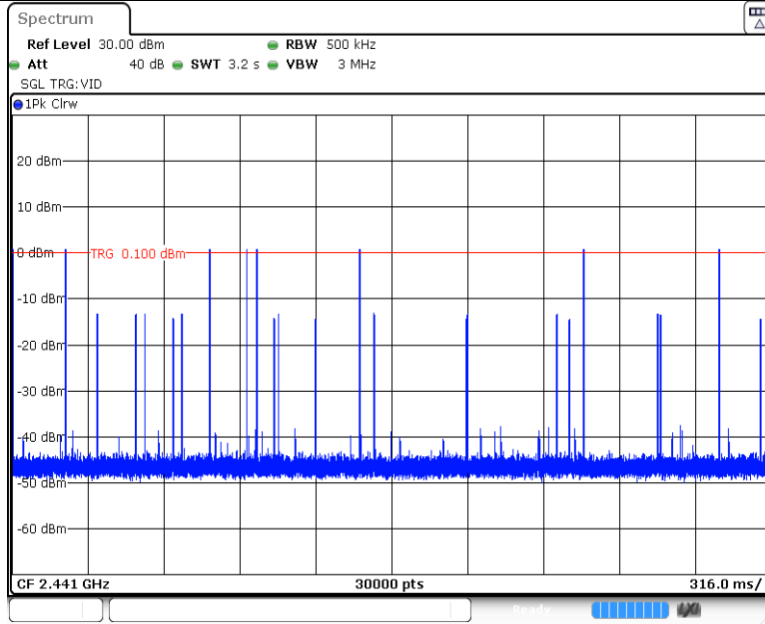

Date: 17.AUG.2022 17:50:04



9.7 Spurious RF Conducted Emissions

Test Method

1. The RF output of EUT was connected to the spectrum analyzer by RF cable. The path loss was compensated to the results for each measurement.
2. Set to the maximum power setting and enable the EUT transmit continuously.
3. Set RBW = 100 kHz, VBW=300 kHz, Peak Detector. Unwanted Emissions measured in any 100 kHz bandwidth outside of the authorized frequency band shall be attenuated by at least 20 dB relative to the maximum in-band peak PSD level in 100 kHz when maximum peak conducted output power procedure is used. If the transmitter complies with the conducted power limits based on the use of RMS averaging over a time interval, the attenuation required under this paragraph shall be 30 dB instead of 20 dB.
4. Measure and record the results in the test report.
5. The RF fundamental frequency should be excluded against the limit line in the operating frequency

Limit

Frequency Range MHz	Limit (dBc)
30-25000	-20

Spurious RF Conducted Emissions

Test Mode	Antenna	Channel (MHz)	Frequency Range (MHz)	Reference Level	Result (dBm)	Limit (dBm)	Verdict
DH5	Ant0	2402	Reference	6.12	6.12	---	PASS
			30~1000	30~1000	-67.19	<=-14.59	PASS
			1000~26500	1000~26500	-49.55	<=-14.59	PASS
		2441	Reference	5.40	5.40	---	PASS
			30~1000	30~1000	-66.22	<=-14.84	PASS
			1000~26500	1000~26500	-51.47	<=-14.84	PASS
		2480	Reference	4.79	4.79	---	PASS
			30~1000	30~1000	-66.54	<=-14.17	PASS
			1000~26500	1000~26500	-51.24	<=-14.17	PASS
2DH5	Ant0	2402	Reference	3.11	3.11	---	PASS
			30~1000	30~1000	-67.24	<=-15.71	PASS
			1000~26500	1000~26500	-37.39	<=-15.71	PASS
		2441	Reference	2.43	2.43	---	PASS
			30~1000	30~1000	-66.92	<=-16.07	PASS
			1000~26500	1000~26500	-51.54	<=-16.07	PASS
		2480	Reference	1.79	1.79	---	PASS
			30~1000	30~1000	-67	<=-15.44	PASS
			1000~26500	1000~26500	-51.02	<=-15.44	PASS
3DH5	Ant0	2402	Reference	3.28	3.28	---	PASS
			30~1000	30~1000	-66.79	<=-15.76	PASS
			1000~26500	1000~26500	-37.37	<=-15.76	PASS
		2441	Reference	2.52	2.52	---	PASS
			30~1000	30~1000	-67.13	<=-16.14	PASS
			1000~26500	1000~26500	-51.34	<=-16.14	PASS
		2480	Reference	1.91	1.91	---	PASS
			30~1000	30~1000	-67.1	<=-15.5	PASS
			1000~26500	1000~26500	-51.32	<=-15.5	PASS

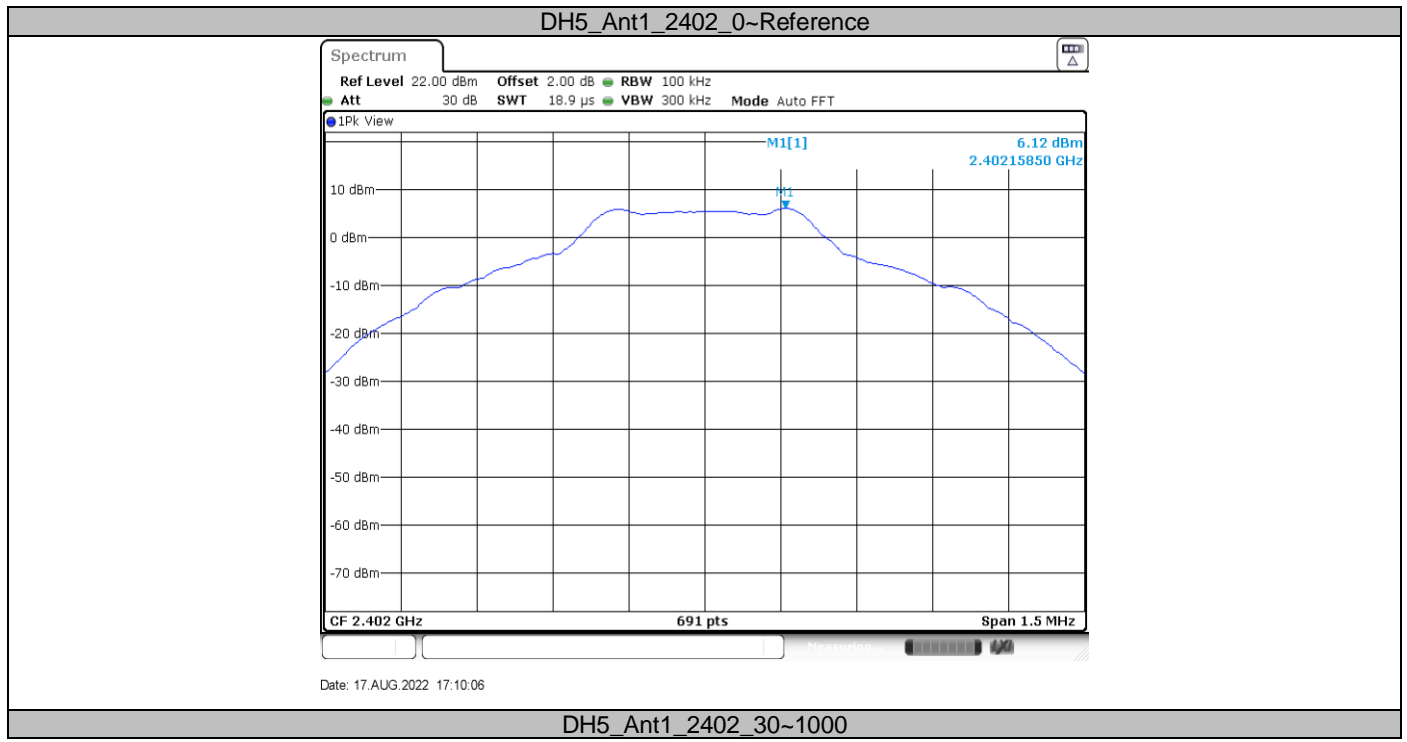

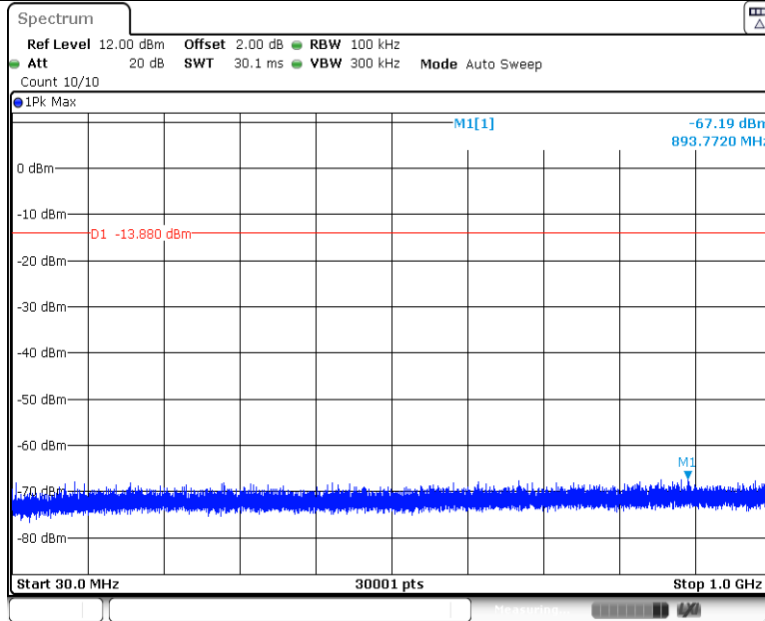

Date: 17.AUG.2022 17:10:12

DH5_Ant1_2402_1000~26500

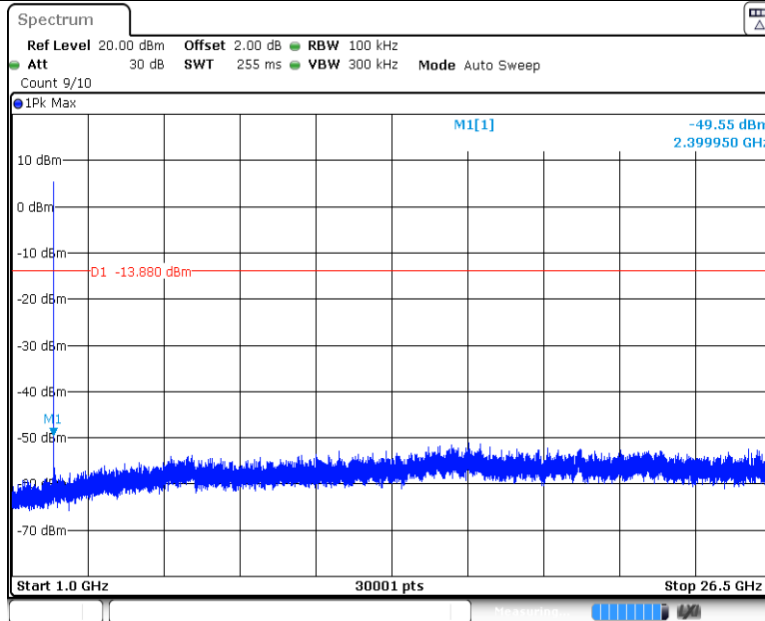

Date: 17.AUG.2022 17:10:19

DH5_Ant1_2441_0~Reference

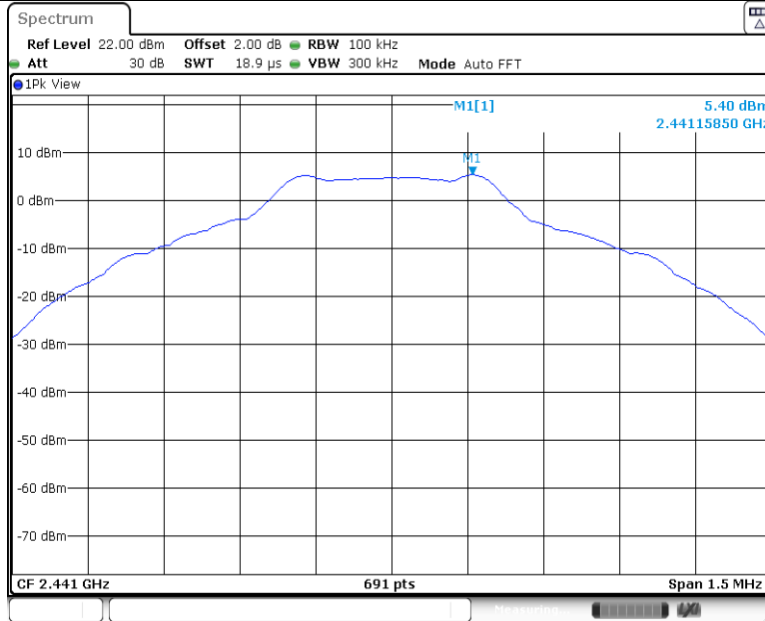

Date: 17.AUG.2022 17:11:57

DH5_Ant1_2441_30~1000

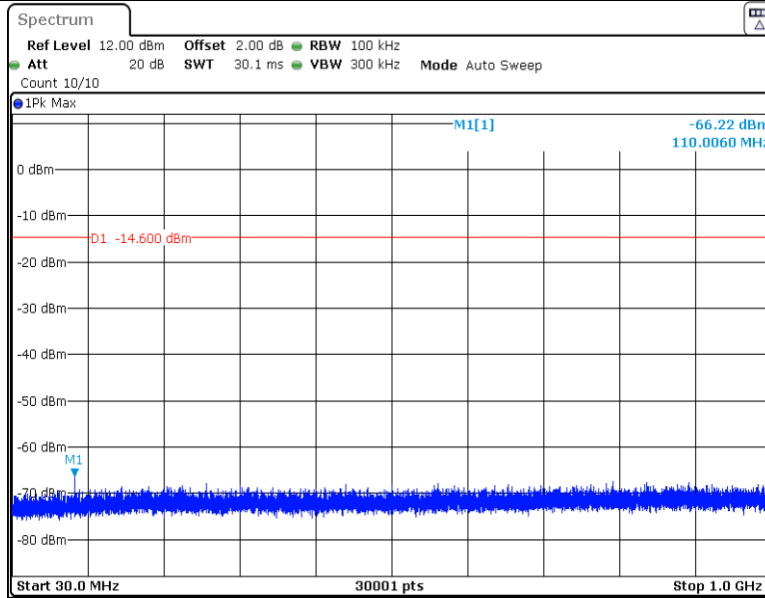

Date: 17.AUG.2022 17:12:03

DH5_Ant1_2441_1000~26500

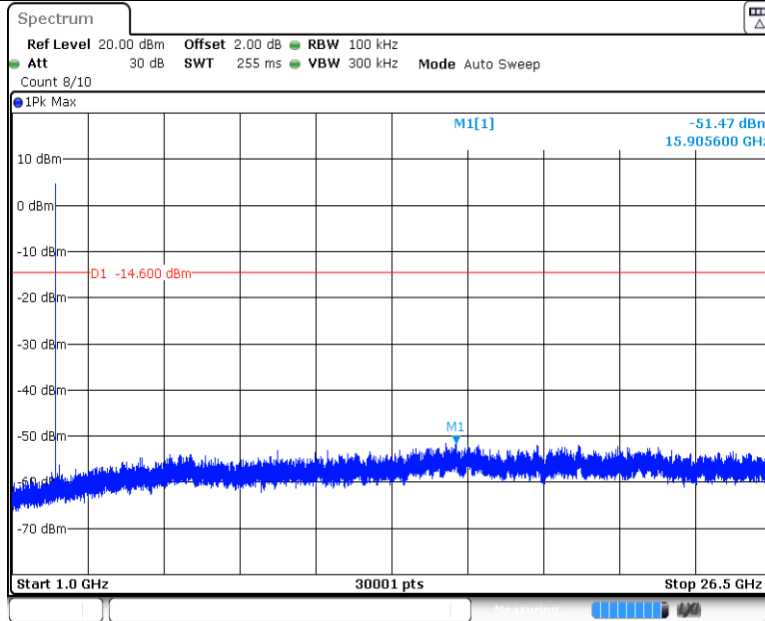

Date: 17.AUG.2022 17:12:11

DH5_Ant1_2480_0~Reference

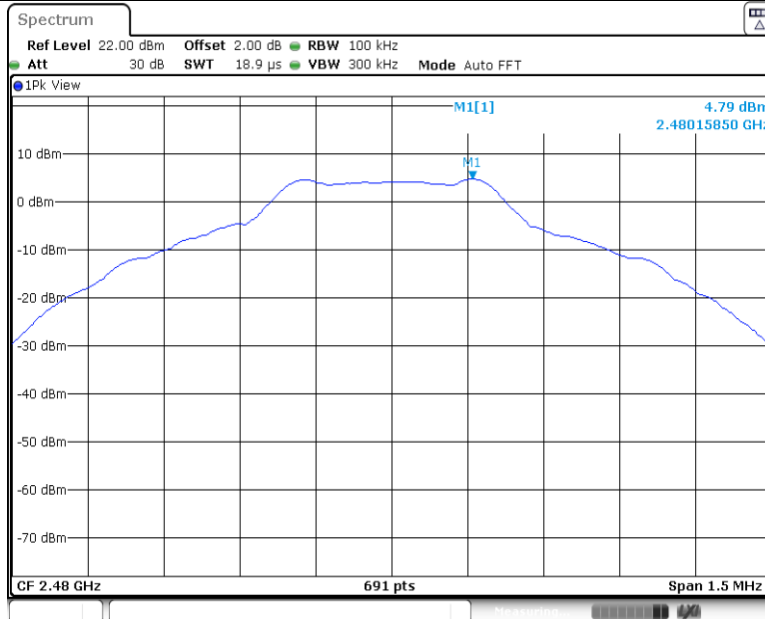

Date: 17.AUG.2022 17:13:58

DH5_Ant1_2480_30~1000

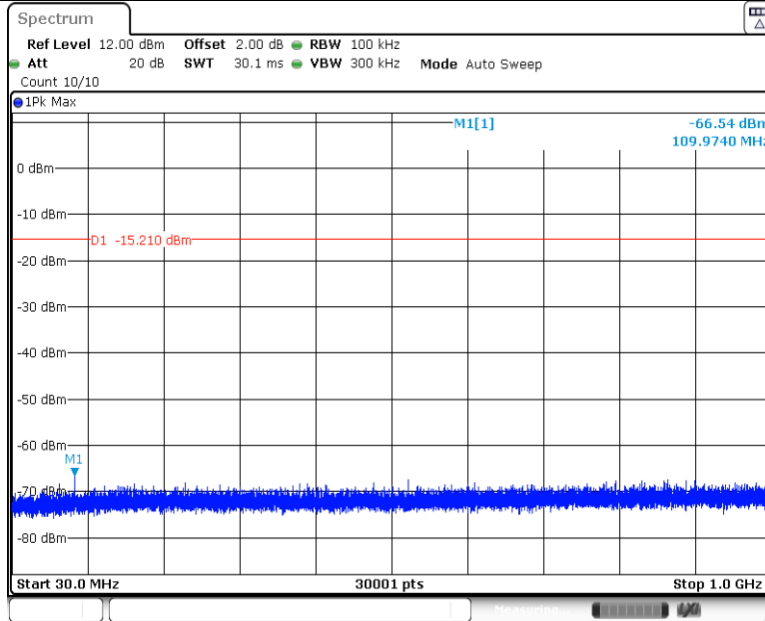

Date: 17.AUG.2022 17:14:04

DH5_Ant1_2480_1000~26500

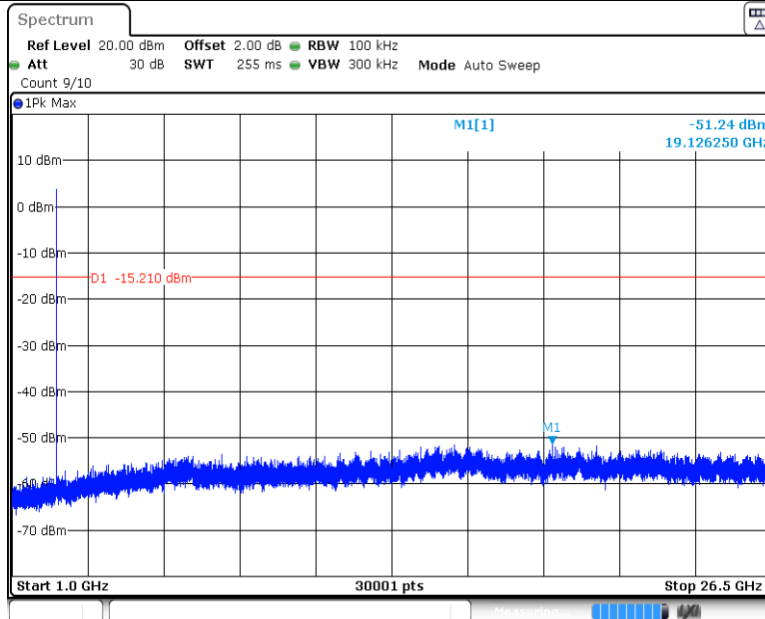

Date: 17.AUG.2022 17:14:12

2DH5_Ant1_2402_0~Reference

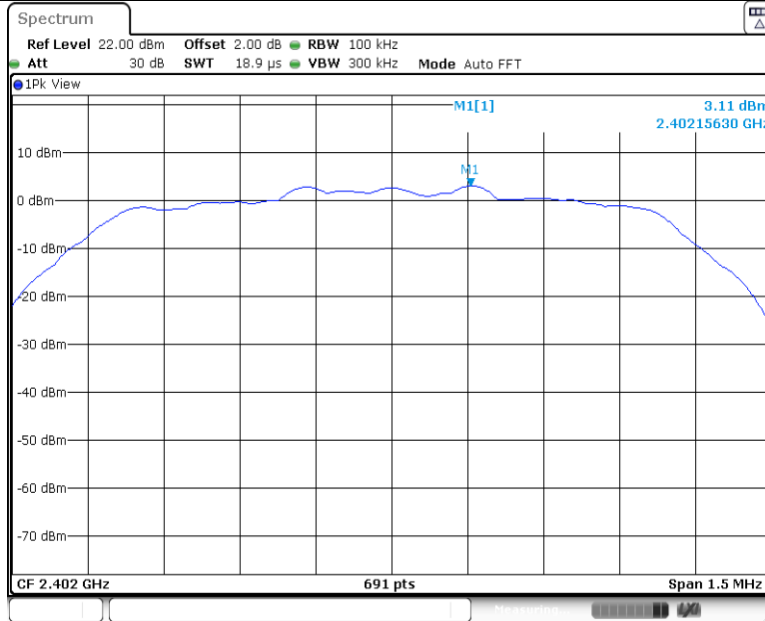

Date: 17.AUG.2022 17:16:31

2DH5_Ant1_2402_30~1000

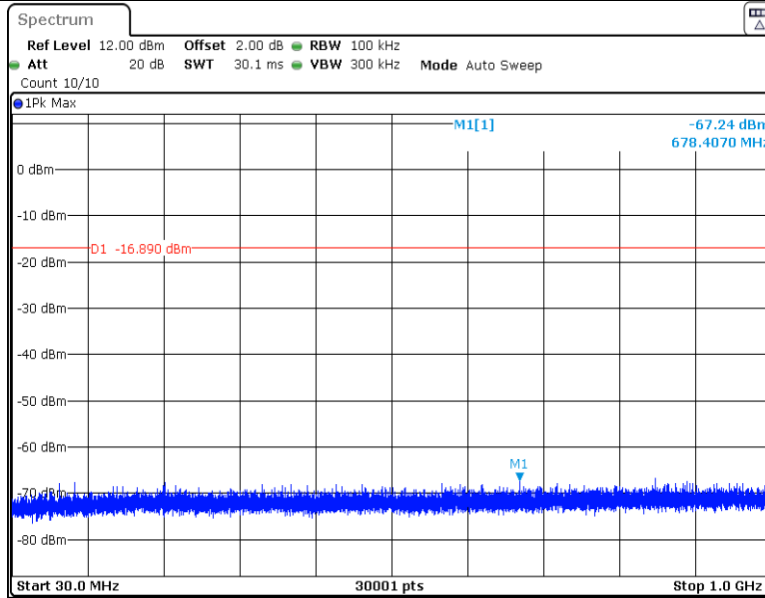

Date: 17.AUG.2022 17:16:37

2DH5_Ant1_2402_1000~26500

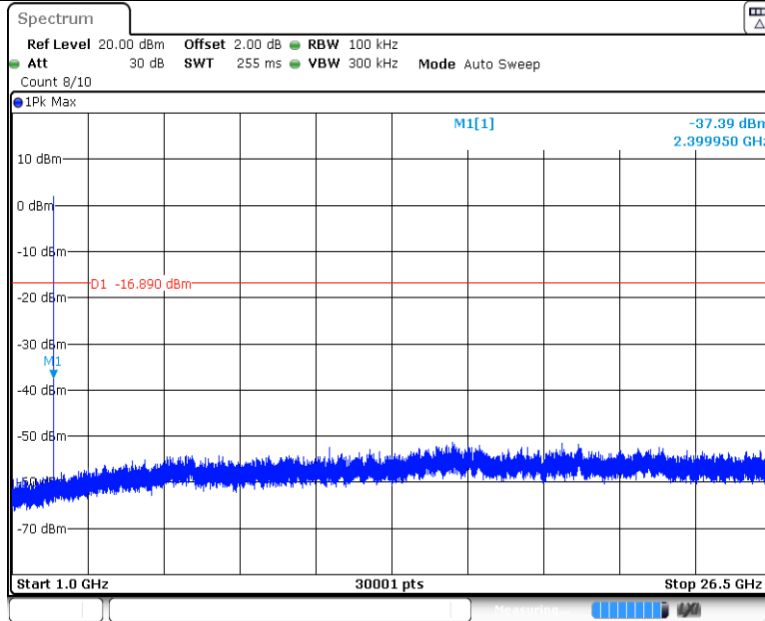

Date: 17.AUG.2022 17:16:45

2DH5_Ant1_2441_0~Reference

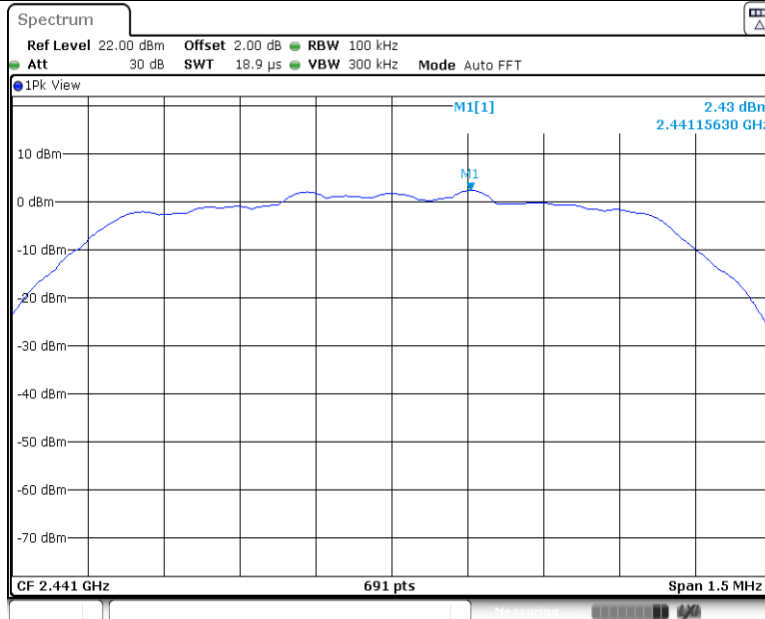

Date: 17.AUG.2022 17:18:05

2DH5_Ant1_2441_30~1000

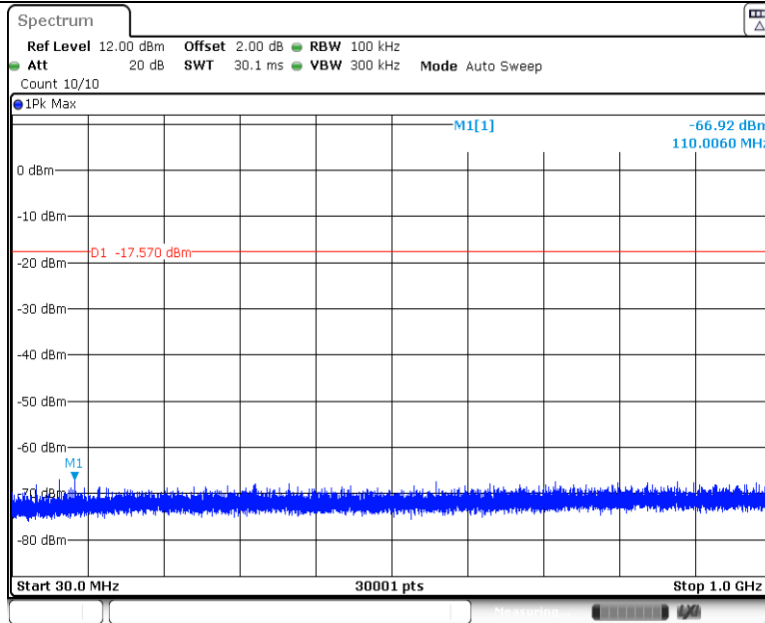

Date: 17.AUG.2022 17:18:11

2DH5_Ant1_2441_1000~26500

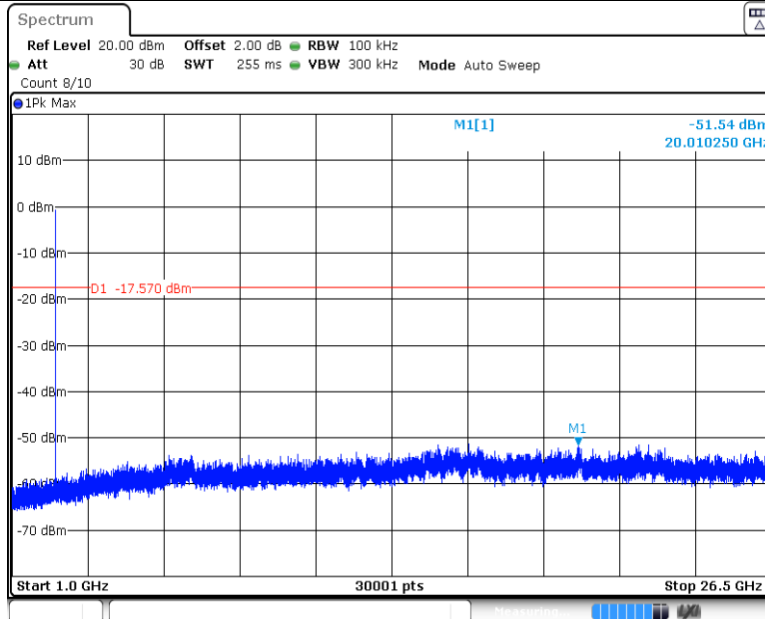

Date: 17.AUG.2022 17:18:19

2DH5_Ant1_2480_0~Reference

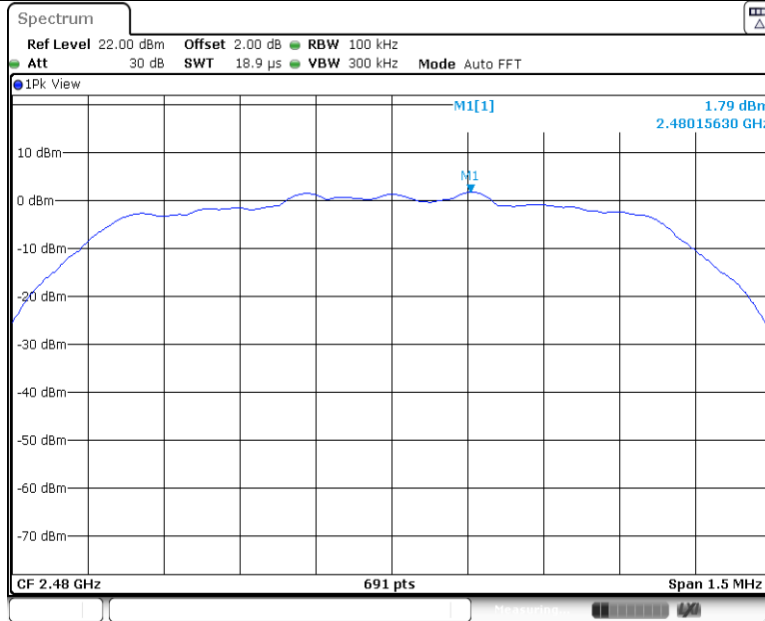

Date: 17.AUG.2022 17:19:52

2DH5_Ant1_2480_30~1000

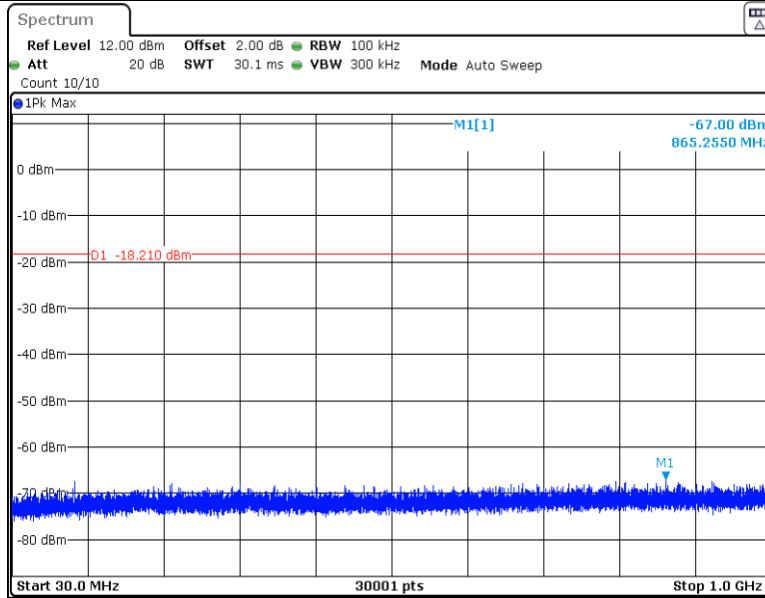

Date: 17.AUG.2022 17:19:58

2DH5_Ant1_2480_1000~26500

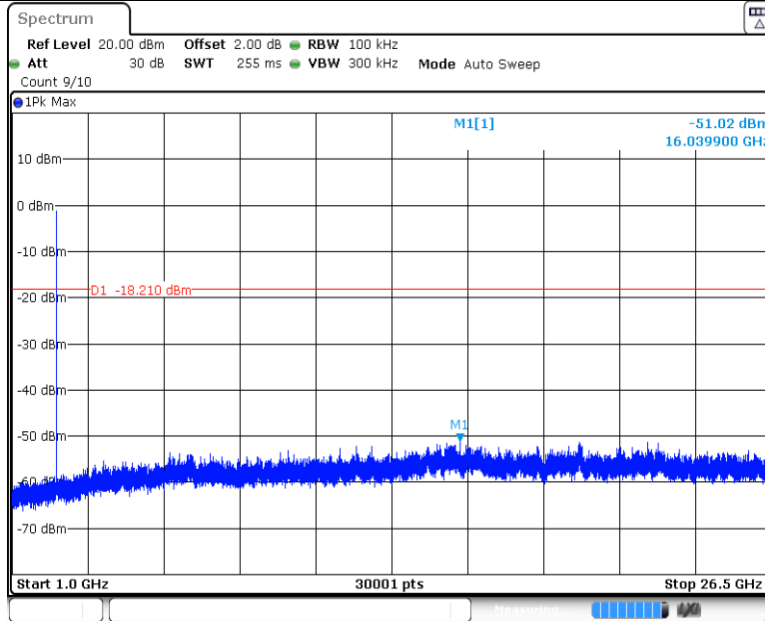

Date: 17.AUG.2022 17:20:06

3DH5_Ant1_2402_0~Reference

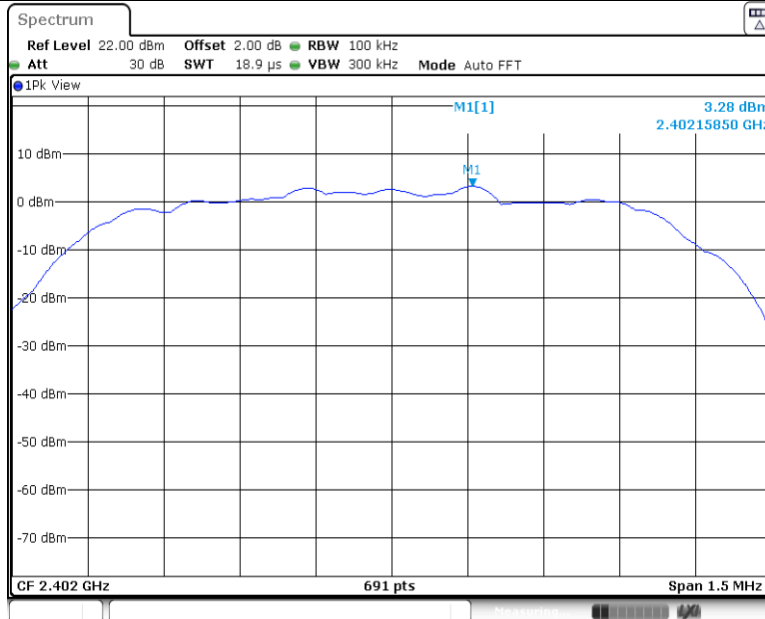

Date: 17.AUG.2022 17:22:13

3DH5_Ant1_2402_30~1000

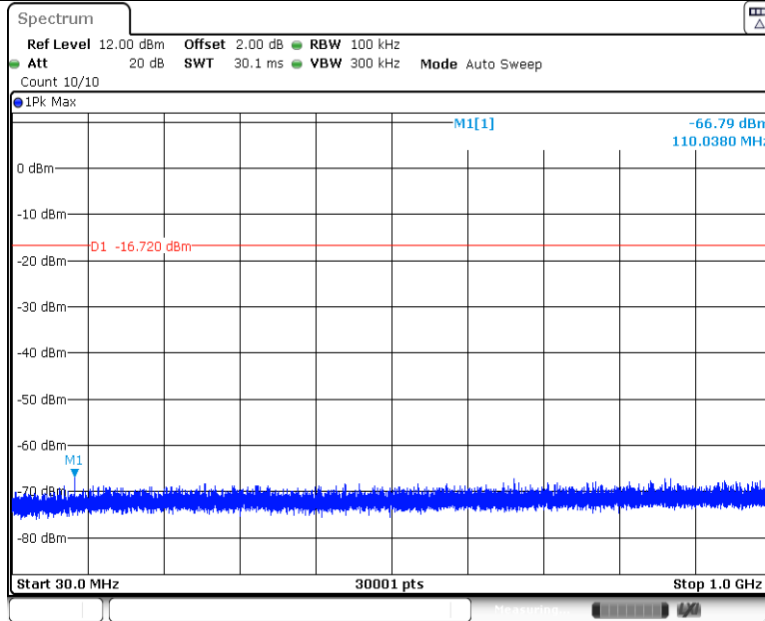

Date: 17.AUG.2022 17:22:19

3DH5_Ant1_2402_1000~26500

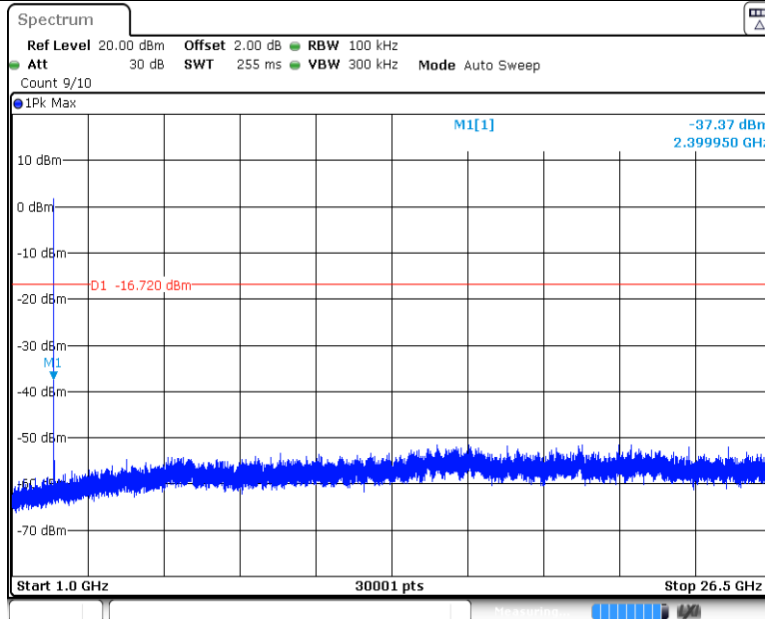

Date: 17.AUG.2022 17:22:27

3DH5_Ant1_2441_0~Reference

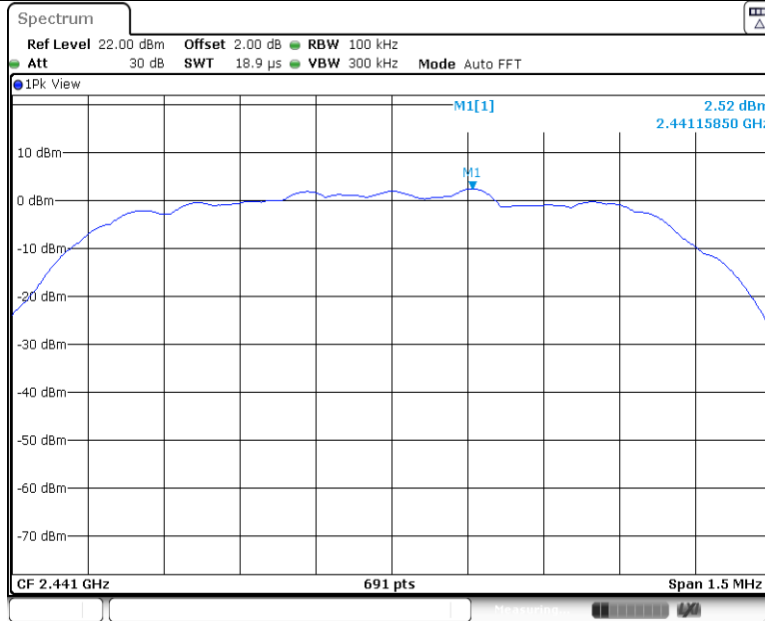

Date: 17.AUG.2022 17:23:56

3DH5_Ant1_2441_30~1000

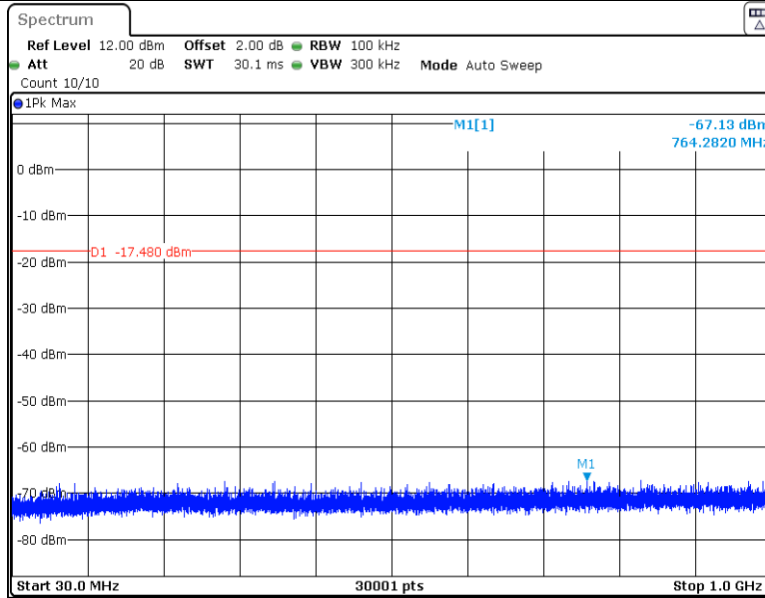

Date: 17.AUG.2022 17:24:02

3DH5_Ant1_2441_1000~26500

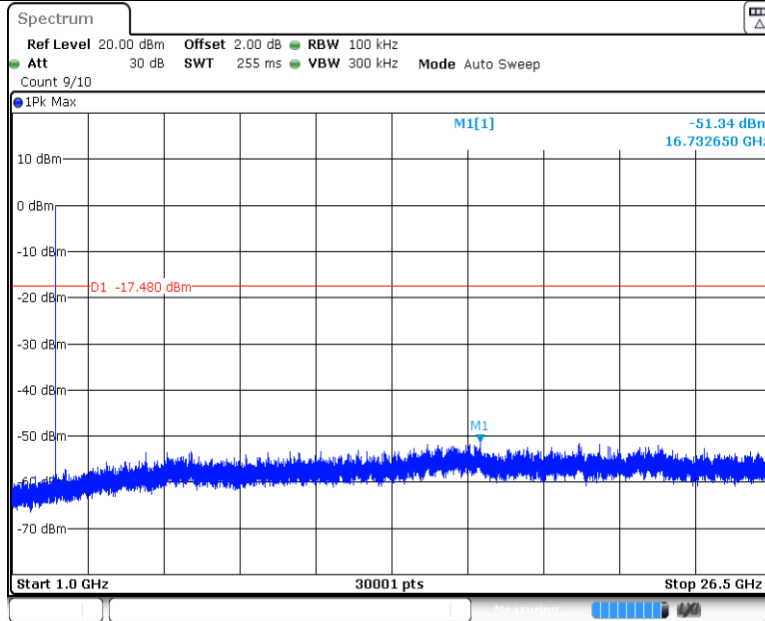

Date: 17.AUG.2022 17:24:10

3DH5_Ant1_2480_0~Reference

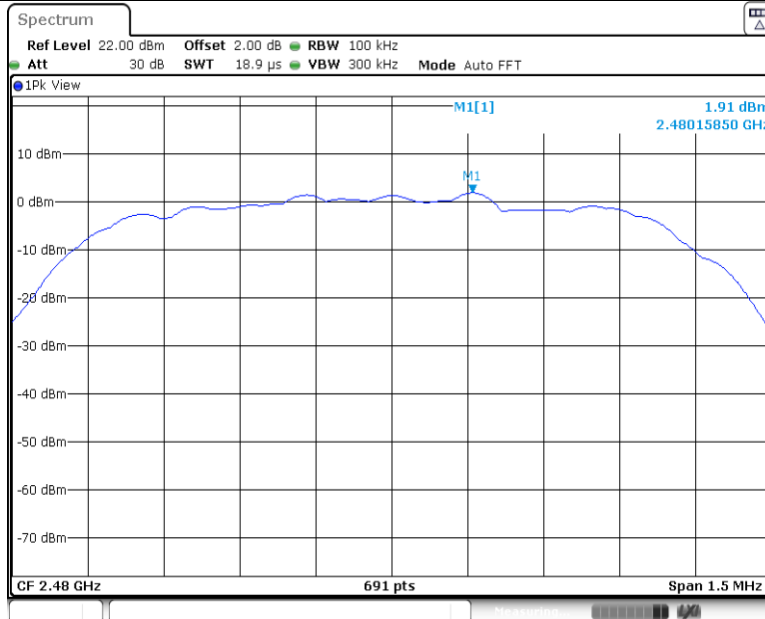

Date: 17.AUG.2022 17:25:38

3DH5_Ant1_2480_30~1000

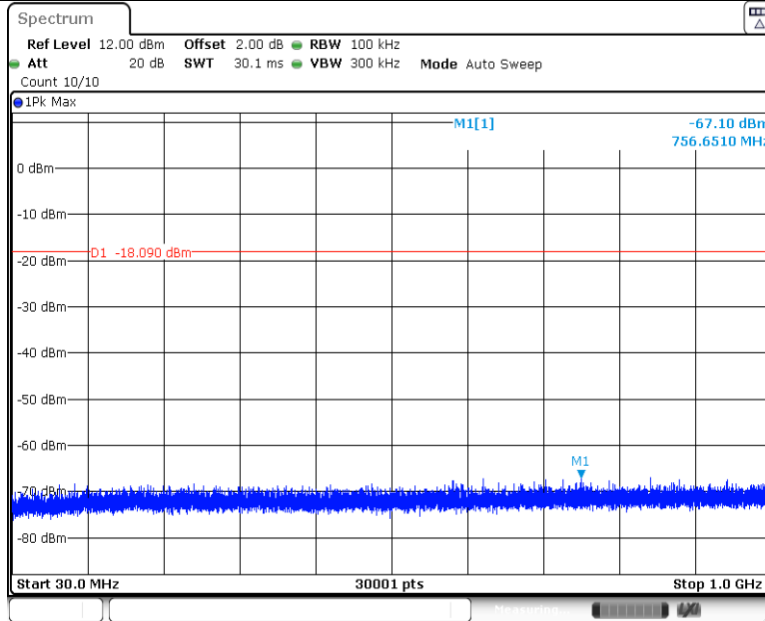

Date: 17.AUG.2022 17:25:44

3DH5_Ant1_2480_1000~26500

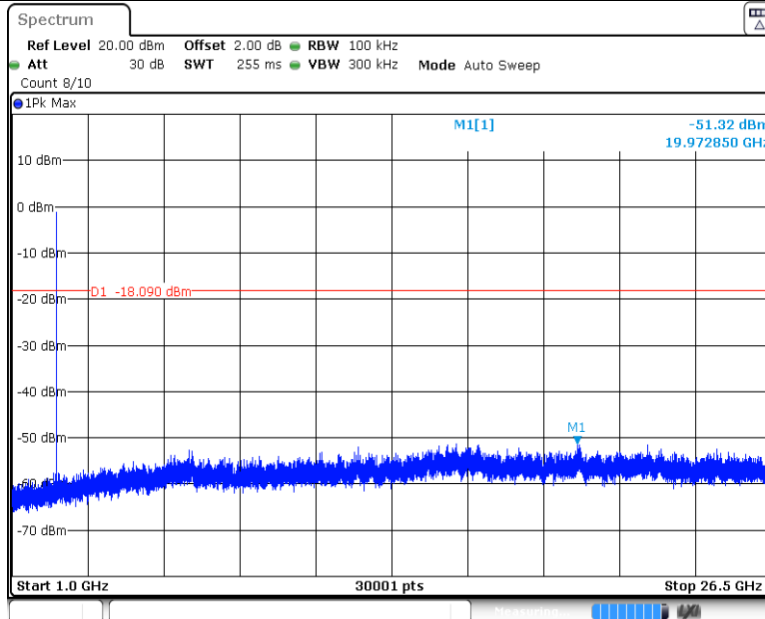

Date: 17.AUG.2022 17:25:52

9.8 Band Edge Testing

Test Method

1. The RF output of EUT was connected to the spectrum analyzer by RF cable. The path loss was compensated to the results for each measurement.
2. Set to the maximum power setting and enable the EUT transmit continuously.
3. Set RBW = 100 kHz, VBW=300 kHz, Peak Detector. Unwanted Emissions measured in any 100 kHz bandwidth outside of the authorized frequency band shall be attenuated by at least 20 dB relative to the maximum in-band peak PSD level in 100 kHz when maximum peak conducted output power procedure is used. If the transmitter complies with the conducted power limits based on the use of RMS averaging over a time interval, the attenuation required under this paragraph shall be 30 dB instead of 20 dB.
4. Measure and record the results in the test report.
5. The RF fundamental frequency should be excluded against the limit line in the operating frequency
6. Set to the maximum power setting and enable the EUT hopping mode, repeat the test.

Limit:

In any 100kHz bandwidth outside the frequency band in which the spread spectrum or digitally modulated device is operating, the RF power that is produced shall be at least 20 dB below that in the 100 kHz bandwidth within the band that contains the highest level of the desired power, based on either an RF conducted or a radiated measurement, provided that the transmitter demonstrates compliance with the peak conducted power limits.

Band Edge

Test Mode	Antenna	Channel	Channel (MHz)	Reference Level (dBm)	Result (dBm)	Limit (dBm)	Verdict
DH5	Ant0	Low	2402	5.51	-52.36	<=-15.22	PASS
		High	2480	4.60	-55.87	<=-14.27	PASS
		Low	Hop_2402	5.15	-57.85	-14.99	PASS
		High	Hop_2480	4.76	-56.65	-14.37	PASS
2DH5	Ant0	Low	2402	1.52	-54.43	<=-15.68	PASS
		High	2480	1.66	-56.79	<=-15.65	PASS
		Low	Hop_2402	-0.83	-57.19	-18.72	PASS
		High	Hop_2480	0.94	-57.19	-15.84	PASS
3DH5	Ant0	Low	2402	1.60	-53.72	<=-15.82	PASS
		High	2480	1.77	-56.44	<=-15.59	PASS
		Low	Hop_2402	0.34	-58.06	-17.14	PASS
		High	Hop_2480	2.07	-56.35	-15.67	PASS

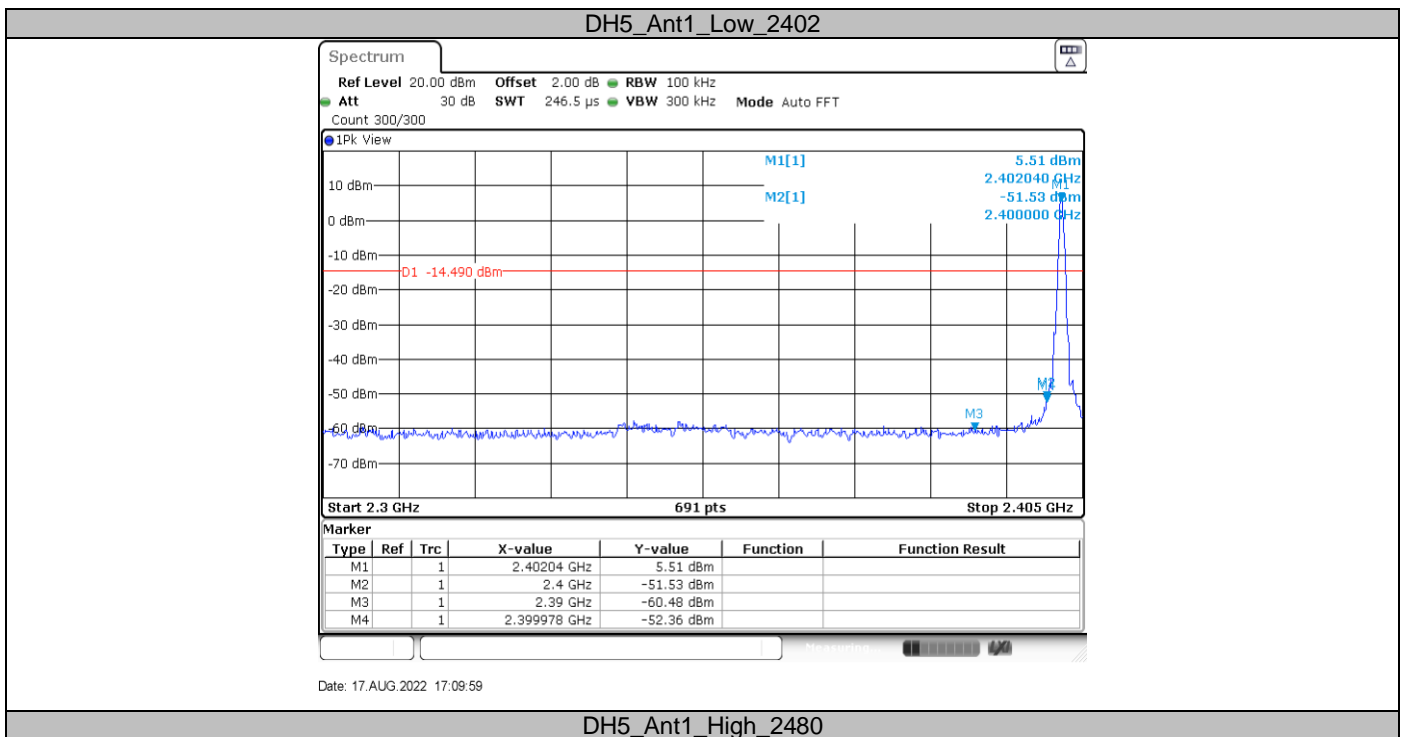

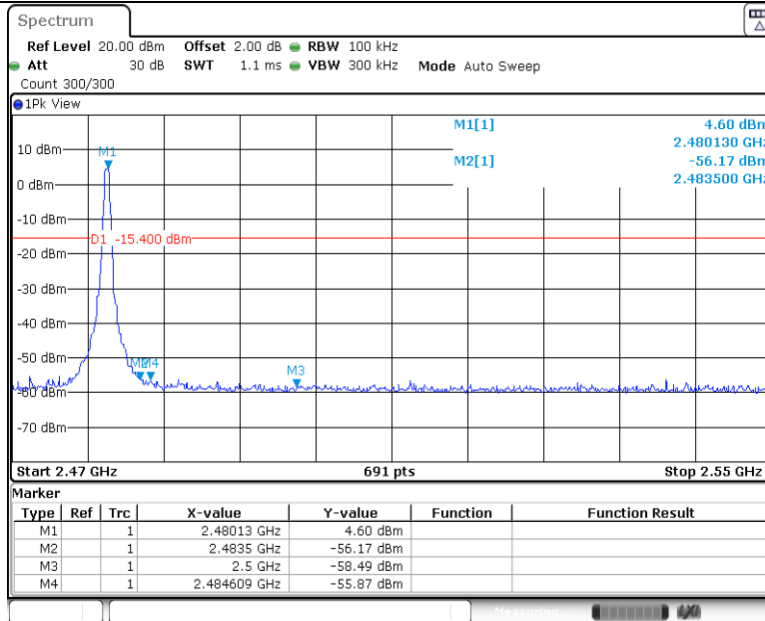

Date: 17.AUG.2022 17:13:52

DH5_Ant1_Low_Hop_2402

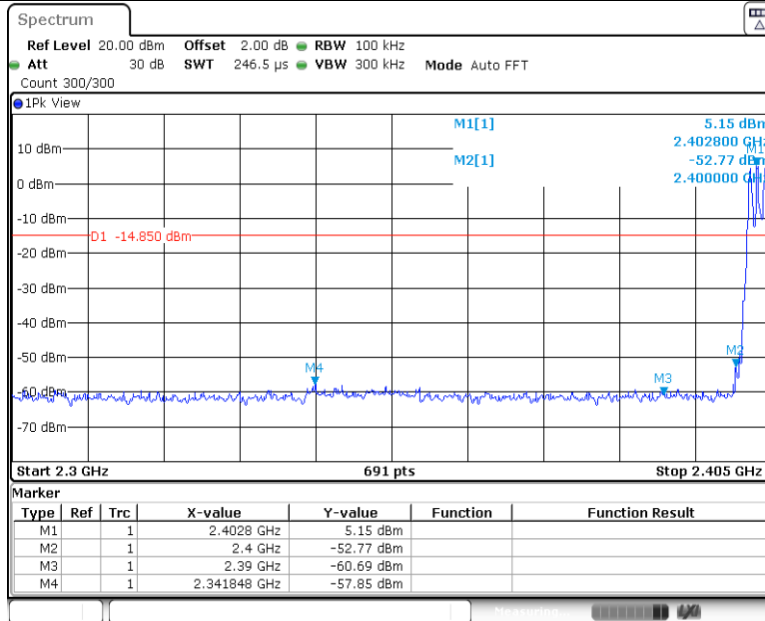

Date: 17.AUG.2022 17:26:42

DH5_Ant1_High_Hop_2480

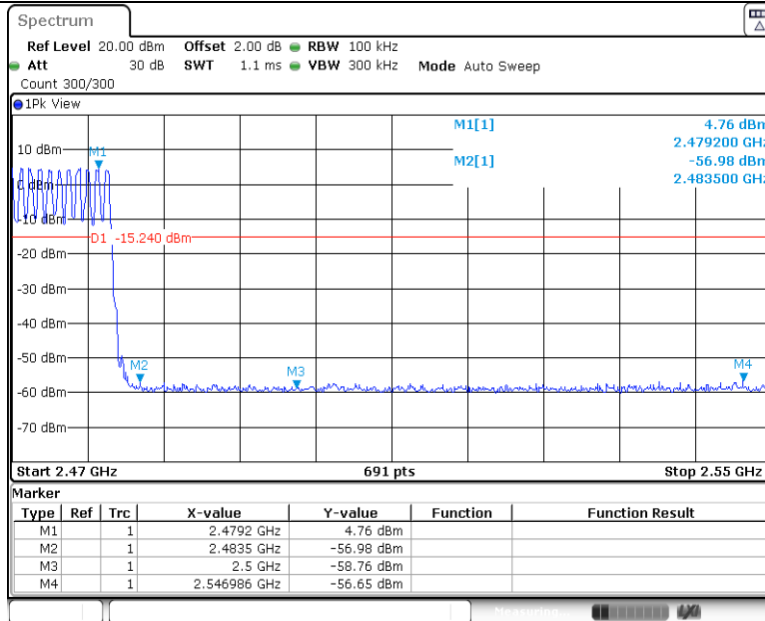

Date: 17.AUG.2022 17:37:04

2DH5_Ant1_Low_2402

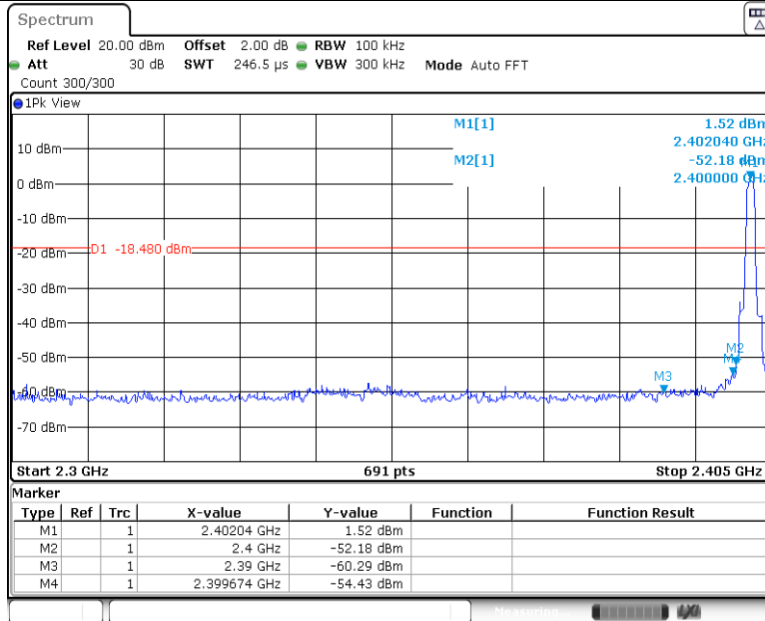

Date: 17.AUG.2022 17:16:26

2DH5_Ant1_High_2480

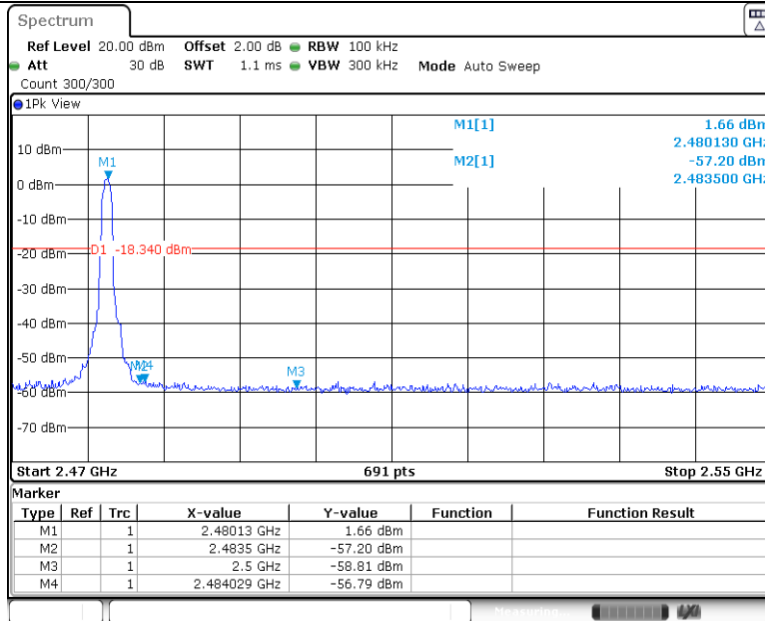

Date: 17.AUG.2022 17:19:46

2DH5_Ant1_Low_Hop_2402

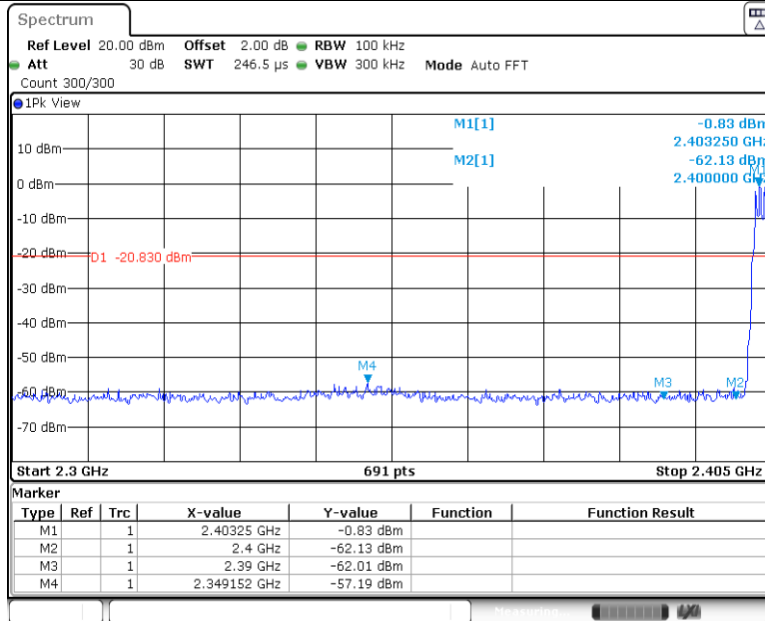

Date: 17.AUG.2022 17:37:59

2DH5_Ant1_High_Hop_2480

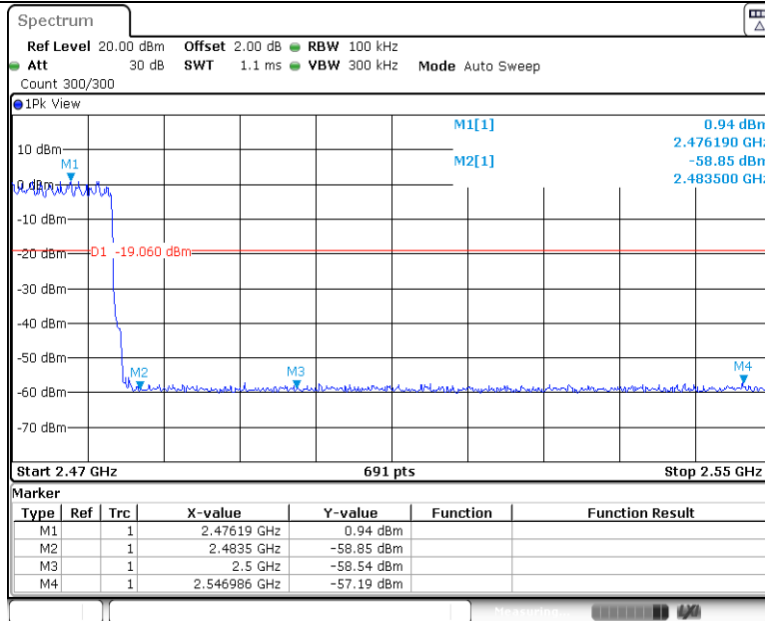

Date: 17.AUG.2022 17:46:34

3DH5_Ant1_Low_2402

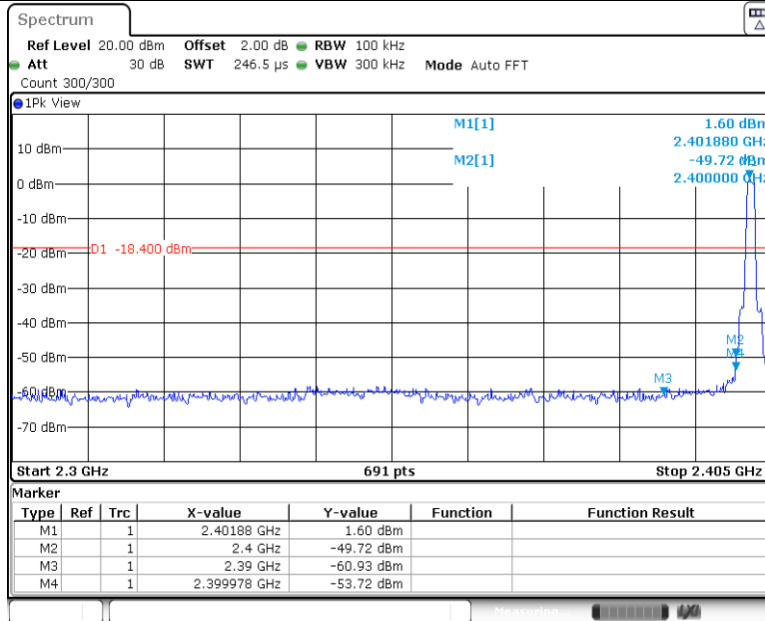

Date: 17.AUG.2022 17:22:08

3DH5_Ant1_High_2480

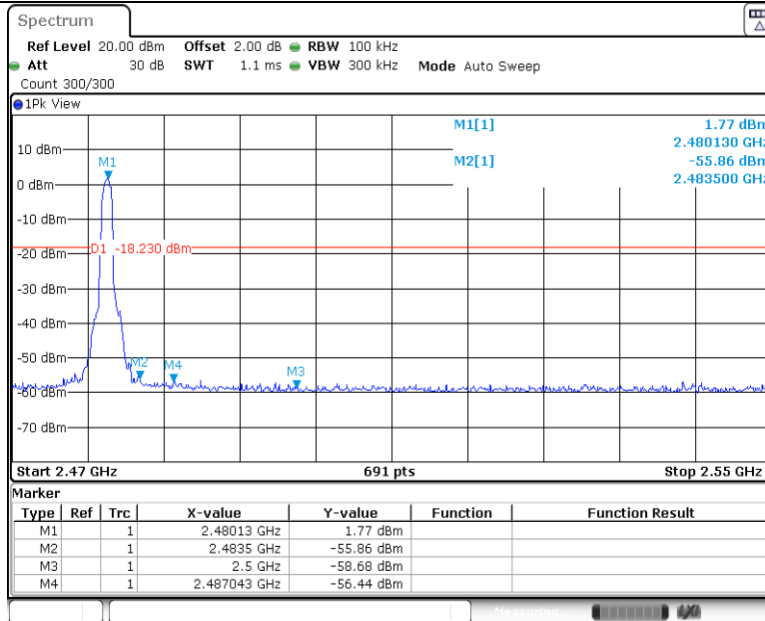

Date: 17.AUG.2022 17:25:32

3DH5_Ant1_Low_Hop_2402

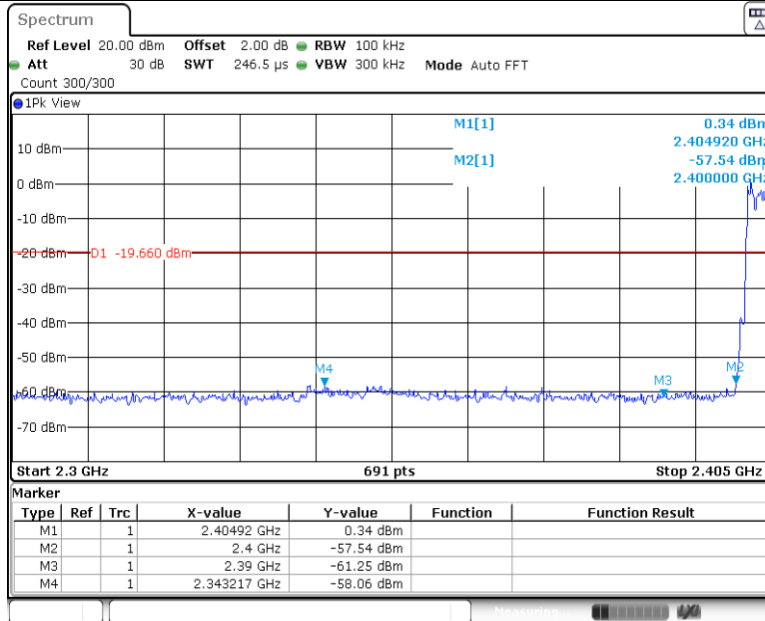

Date: 17.AUG.2022 17:47:48

3DH5_Ant1_High_Hop_2480

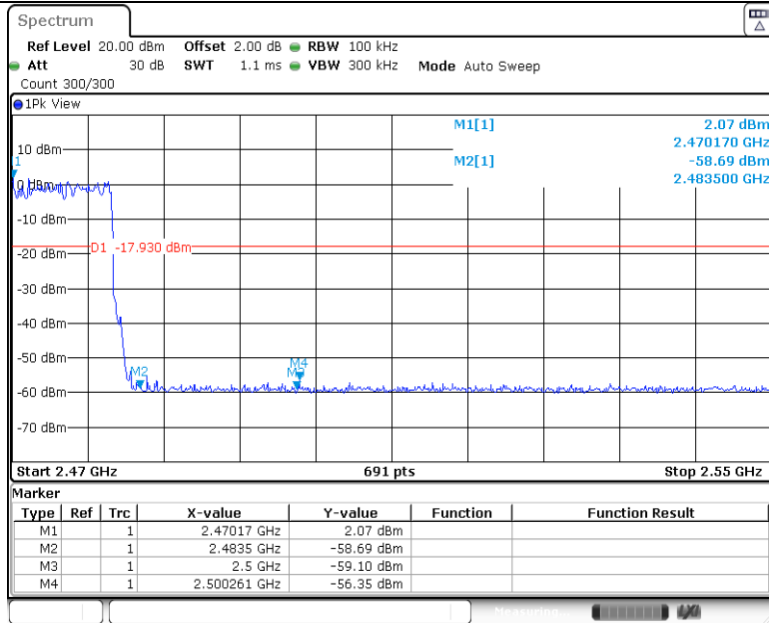

Date: 17.AUG.2022 17:51:28

9.9 Spurious Radiated Emissions for Transmitter

Test Method

1. The EUT was placed on a turn table which is 1.5m above ground plane for above 1GHz and 0.8m above ground for below 1GHz at 3 meters chamber room for test. The table was rotated 360 degrees to determine the position of the highest radiation.
2. Set to the maximum power setting and enable the EUT transmit continuously
3. The EUT was set 3 meters away from the interference – receiving antenna, which was mounted on the top of a variable – height antenna tower.
4. The height of antenna is varied from one meter to four meters above the ground to determine the maximum value of the field strength. Both horizontal and vertical polarizations of the antenna are set to make the measurement.
5. For each suspected emission, the EUT was arranged to its worst case and then the antenna was tuned to heights from 1 meter to 4 meters and the rotatable table was turned from 0 degrees to 360 degrees to find the maximum reading.
6. Use the following spectrum analyzer settings According to C63.10:
 - (1) Span shall wide enough to fully capture the emission being measured;
 - (2) Set RBW=100 kHz for $f < 1$ GHz; VBW RBW; Sweep = auto; Detector function = peak; Trace = max hold;
 - (3) Set RBW = 1 MHz, VBW= 3MHz for $f \geq 1$ GHz for peak measurement.
 For average measurement:
 - VBW = 10 Hz, when duty cycle is no less than 98 percent.
 - VBW $\geq 1/T$, when duty cycle is less than 98 percent where T is the minimum transmission duration over which the transmitter is on and is transmitting at its maximum power control level for the tested mode of operation.
7. Repeat above procedures until all frequencies measured were complete.

Note:

- 1: The resolution bandwidth and video bandwidth of test receiver/spectrum analyzer is 120 KHz for Quasi-peak detection (QP) at frequency below 1GHz.
- 2: The resolution bandwidth of test receiver/spectrum analyzer is 1MHz and the video bandwidth is 3MHz for peak detection (PK) at frequency above 1GHz.
- 3: The resolution bandwidth of test receiver/spectrum analyzer is 1MHz and the video bandwidth is 3MHz for RMS Average ((duty cycle < 98%) for Average detection (AV) at frequency above 1GHz, then the measurement results was added to a correction factor ($20\log(1/\text{duty cycle})$).
- 4: The resolution bandwidth of test receiver/spectrum analyzer is 1MHz and the video bandwidth is 10Hz (duty cycle > 98%) for Average detection (AV) at frequency above 1GHz.

Spurious Radiated Emissions for Transmitter

Limit

The radio emission outside the operating frequency band shall be at least 20 dB below that in the 100 kHz bandwidth within the band that contains the highest level of the desired power. Radiated emissions which fall in the restricted bands, as defined in section 15.205 & RSS-GEN 8.10, must comply with the radiated emission limits specified in section 15.209 & RSS-Gen 6.13.

Frequency MHz	Field Strength uV/m	Field Strength dB μ V/m	Detector
30-88	100	40	QP
88-216	150	43.5	QP
216-960	200	46	QP
960-1000	500	54	QP
Above 1000	500	54	AV
Above 1000	5000	74	PK

Spurious radiated emissions for transmitter

According to C63.10, if the peak (or quasi-peak) measured value complies with the average limit, it is unnecessary to perform an average measurement, so AV emission value did not show in below table if the peak value complies with average limit.

The only worse case (which is subject to the maximum EIRP, 8DPSK mode, 2480MHz) test result is listed in the report.

Transmitting spurious emission test result as below:

DPSK Modulation 2480MHz Test Result

Frequency Band	Frequency	Emission Level	Polarization	Limit	Detector	Margin	Correct factor	Result
	MHz	dBuV/m		dBuV/m		dBuV/m	(dB/m)	
30-1000MHz	50.747222	21.34	H	40.00	QP	18.66	20.86	Pass
	102.049444	19.55	H	40.00	QP	23.95	18.64	Pass
	246.040556	31.68	H	40.00	QP	14.32	19.80	Pass
	267.596111	35.29	H	43.50	QP	10.71	20.04	Pass
	294.271111	38.58	H	46.00	QP	7.42	20.64	Pass
	674.942222	30.42	H	46.00	QP	15.58	28.62	Pass
	Other Frequencies	--	H	--	QP	--	--	Pass
	30.215556	25.24	V	40.00	QP	14.76	16.82	Pass
	46.651667	22.88	V	40.00	QP	17.12	21.06	Pass
	132.604444	21.63	V	40.00	QP	21.87	15.43	Pass
	178.248333	25.03		40.00		18.47	16.42	Pass
	237.310556	27.67		40.00		18.33	19.48	Pass
	296.588333	29.70	V	43.50	QP	16.30	20.70	Pass
Other Frequencies	--	V	--	QP	--	--	Pass	
1000-2500MHz	7440.000	44.08	H	74	PK	29.92	8.94	Pass
	10102.000	45.74	H	74	PK	28.26	12.56	Pass
	15286.500	49.17	H	74	PK	24.83	19.02	Pass
	Other frequency	---	H	74	PK	---	---	Pass
	1240.000	42.64	V	74	PK	31.36	-8.33	Pass
	6575.500	44.37	V	74	PK	29.63	8.99	Pass
	14879.000	50.36	V	74	PK	23.64	17.27	Pass
	Other frequency	---	V	74	PK	---	---	Pass

Remark:

- (1) "*" means the emission(s) appear within the restrict bands shall follow the requirement of section 15.205 & RSS-GEN 8.10.
- (2) Data of measurement within this frequency range shown "--" in the table above means the reading of emissions are the noise floor or attenuated more than 20dB below the permissible limits or the field strength is too small to be measured.
- (3) Corrected Amplitude = Read level + Corrector factor
 Above 1GHz: Corrector factor = Antenna Factor + Cable Loss- Amplifier Gain
 Below 1GHz: Corrector factor = Antenna Factor + Cable Loss

10 Test Equipment List

List of Test Instruments

Radiated Emission 2# Test

DESCRIPTION	MANUFACTURER	MODEL NO.	EQUIPMENT ID	SERIAL NO.	CAL INTERVAL (YEAR)	CAL. DUE DATE
EMI Test Receiver	Rohde & Schwarz	ESR 26	68-4-74-14-002	101269	1	2023-5-28
Trilog Super Broadband Test Antenna	Schwarzbeck	VULB 9162	68-4-80-19-003	284	1	2023-1-17
Wave Guide Antenna	ETS	3117	68-4-80-19-001	00218954	1	2023-5-9
Pre-amplifier	Rohde & Schwarz	SCU 18F	68-4-29-19-001	100745	1	2023-5-28
Pre-amplifier	Rohde & Schwarz	SCU 18F	68-4-29-19-002	100746	1	2023-5-28
Sideband Horn Antenna	Q-PAR	QWH-SL-18-40-K-SG	68-4-80-14-008	12827	1	2023-7-12
Pre-amplifier	Rohde & Schwarz	SCU 40A	68-4-29-14-002	100432	1	2023-7-27
Attenuator	Mini-circuits	UNAT-6+	68-4-81-21-002	15542	1	2023-5-27
3m Semi-anechoic chamber	TDK	SAC-3 #2	68-4-90-19-006	----	2	2023-5-28
Test software	Rohde & Schwarz	EMC32	68-4-90-19-006-A01	Version1 0.35.02	N/A	N/A

Conducted Emission 2# Test

DESCRIPTION	MANUFACTURER	MODEL NO.	EQUIPMENT ID	SERIAL NO.	CAL INTERVAL (YEAR)	CAL. DUE DATE
EMI Test Receiver	Rohde & Schwarz	ESR 3	68-4-74-19-002	102590	1	2023-5-27
LISN	Rohde & Schwarz	ENV216	68-4-87-19-001	102472	1	2023-5-27
ISN	Rohde & Schwarz	ENY81	68-4-87-14-003	100177	1	2023-5-27
ISN	Rohde & Schwarz	ENY81-CA6	68-4-87-14-004	101664	1	2023-5-27
High Voltage Probe	Schwarzbeck	TK9420(VT 9420)	68-4-27-14-001	9420-584	1	2023-5-27
RF Current Probe	Rohde & Schwarz	EZ-17	68-4-27-14-002	100816	1	2023-5-31
Attenuator	Shanghai Huaxiang	TS2-26-3	68-4-81-16-003	080928189	1	2023-5-27
Test software	Rohde & Schwarz	EMC32	68-4-90-19-005-A01	Version10.3 5.02	N/A	N/A
Shielding Room	TDK	CSR #2	68-4-90-19-005	----	3	2022-11-07

Conducted RF Test System

DESCRIPTION	MANUFACTURER	MODEL NO.	EQUIPMENT ID	SERIAL NO.	CAL INTERVAL (YEAR)	CAL. DUE DATE
Signal Analyzer	Rohde & Schwarz	FSV40	68-4-74-14-004	101030	1	2023-5-27
RF Switch Module	Rohde & Schwarz	OSP120/O SP-B157	68-4-93-14-003	101226/100 851	1	2023-5-27
Power Splitter	Weinschel	1580	68-4-85-14-	SC319	1	2023-05-28



			001			
Test software	Tonscend	System for BT/WIFI	68-4-74-14-006-A13	Version 2.6.77.0518	N/A	N/A
Shielding Room	TDK	TS8997	68-4-90-19-003	----	3	2022-11-07

11 System Measurement Uncertainty

For a 95% confidence level, the measurement expanded uncertainties for defined systems, in accordance with the recommendations of ISO 17025 were:

System Measurement Uncertainty	
Test Items	Extended Uncertainty
Uncertainty for Conducted Emission 150kHz-30MHz (for test using AMN ENV432 or ENV4200)	3.31dB
Uncertainty for Radiated Emission in new 3m chamber (68-4-90-19-006) 30MHz-1000MHz	Horizontal: 4.67dB; Vertical: 4.65dB;
Uncertainty for Radiated Emission in new 3m chamber (68-4-90-19-006) 1000MHz-18000MHz	Horizontal: 4.76dB; Vertical: 4.75dB;
Uncertainty for Radiated Emission 18000MHz-40000MHz	Horizontal: 4.51dB; Vertical: 4.50dB;
Uncertainty for Conducted RF test	RF Power Conducted: 1.27dB Frequency test involved: 0.6×10^{-7} or 1%

Measurement Uncertainty Decision Rule:

Determination of conformity with the specification limits is based on the decision rule according to IEC Guide 115: 2007, clause 4.4.3 and 4.5.1.

THE END