



**APPLICATION FOR FCC CERTIFICATION**

**ALCATEL USA**

**Digitally Modulated Radio**

<b>MODEL</b>	<b>FCC ID</b>
<b>MDR-8705E-8</b>	<b>JF6-8705u-8</b>
<b>MDR-8705E-16</b>	<b>JF6-8705u-16</b>
<b>MDR-8705E-52</b>	<b>JF6-8705u-52</b>
<b>MDR-8705E-155</b>	<b>JF6-8705u-155</b>

**Number of Pages: 50**

**Date of Report: July 1, 2005**

## Table of Contents

<b>1.0 Summary of tests -----</b>	<b>3</b>
<b>2.0 General Description -----</b>	<b>4</b>
<b>2.1 Standard Features-----</b>	<b>4</b>
<b>2.2 Naming Convention -----</b>	<b>7</b>
<b>2.3 System Configuration-----</b>	<b>8</b>
<b>2.4 Radio Configuration-----</b>	<b>8</b>
<b>2.5 Features and Options-----</b>	<b>8</b>
<b>2.6 Functional Description-----</b>	<b>12</b>
<b>3.0 Test Methodology-----</b>	<b>15</b>
<b>3.1 Test Facility-----</b>	<b>15</b>
<b>3.2 EUT Setup-----</b>	<b>15</b>
<b>3.3 List of Test Equipment-----</b>	<b>16</b>
<b>4.0 Measurements Results-----</b>	<b>17</b>
<b>4.1 Maximum Conducted Output Power-----</b>	<b>17</b>
<b>4.2 Minimum 6DB RF Bandwidth-----</b>	<b>18</b>
<b>4.3 Peak Power Spectral Density-----</b>	<b>20</b>
<b>4.4 Out of Band Conducted Emissions-----</b>	<b>25</b>
<b>4.4.1 MDR-8705u-8-----</b>	<b>26</b>
<b>4.4.2 MDR-8705u-16-----</b>	<b>31</b>
<b>4.4.3 MDR-8705u-52-----</b>	<b>36</b>
<b>4.4.4 MDR-8705u-155-----</b>	<b>41</b>
<b>4.5 Out of Band Radiated Emissions-----</b>	<b>47</b>
<b>4.6 Radiated Emissions in Restricted Bands-----</b>	<b>47</b>
<b>4.7 Antenna Requirement-----</b>	<b>50</b>

## 1.0 Summary of FCC 15.247 Tests

**Model: MDR-8705E-8**                      **FCC ID: JF6-8705u-8**  
**Model: MDR-8705E-16**                **FCC ID: JF6-8705u-16**  
**Model: MDR-8705E-52**                **FCC ID: JF6-8705u-52**  
**Model: MDR-8705E-155**               **FCC ID: JF6-8705u-155**

<b>Test</b>	<b>FCC Reference</b>	<b>Results</b>
<b>Output Power</b>	<b>15.247 (b) (3)</b>	<b>Pass</b>
<b>6dB Bandwidth</b>	<b>15.247 (a) (2)</b>	<b>Pass</b>
<b>Peak Power Spectral Density</b>	<b>15.247 (d)</b>	<b>Pass</b>
<b>Out of Band Conducted Emissions</b>	<b>15.247 (c)</b>	<b>Pass</b>
<b>AC Conducted Emissions</b>	<b>15.207</b>	<b>Not required; battery operation only</b>
<b>Out of Band Radiated Emissions</b>	<b>15.247 (c)</b>	<b>N/A</b>
<b>Antenna requirement</b>	<b>15.203</b>	<b>Pass</b>

Elec. Design Engineer: Troy Taylor

Date: 07/01/05

RF Group Manager: Duane Mortensen

Date: 07/01/05

## 2.0 General Description

The MDR-8705-XX is the MDR-8000/i/s/u version for the unlicensed frequency band: 5725-5850 MHz. It is the latest addition of the Alcatel family of digital microwave products.

The MDR-8000/i/s/u series Microwave Digital Radios (see figure 2-1) consists of:

- Solid-state, licensed, digital radios that provide transport for DS1, E1, DS3 and OC3 in 2, 4, 6, 7, 8, 10, and 11 GHz RF frequency bands.
- Solid-state, unlicensed digital radios that provide transport for DS1, DS3 and OC3 in the 5 GHz RF frequency band.

The following capacities and modulation schemes are available:

- MDR-8000 – 2, 4, 8, 12, and 16 North American Standard DS1 channels at either 32 or 128 TCM, 1 or 3 North American Standard DS3 channels with 1 or 3 wayside DS1 channels at 64 QAM
- MDR-8000i – 2, 4, 8, 12, or 16 CCITT E1 channels at either 32 or 128 TCM
- MDR-8000s – 3 North American Standard OC3 with 3 wayside DS1 channels at 128 TCM
- MDR-8000u – 2, 4, 8, 12, and 16 North American Standard DS1 channels at 128 TCM or 1 DS3 channel at 64 QAM, 1 North American Standard 1STS1 channel with 1 wayside DS1 channel at 128 TCM and 1 North American Standard OC3 channel with 3 way sides DS1 channels at 128 TCM.

The radio fits into a standard 19 in. (483 mm) rack and occupies seven vertical rack increments. Up to four fully-equipped hot-standby radios can be mounted in a standard 7 ft rack. The radio is front accessible and can be mounted against a wall or back-to-back against other equipment.

## 2.1 STANDARD FEATURES

Standard features include:

- Frequency bands from 2 to 11 GHz
- Committee of European Post and Telegraph (CEPT)/Federal Communications Commission (FCC) applications
- DS1, E1, DS3, and OC3 Traffic capacities.
- International Telecommunications Union (ITU)/ETSI/FCC compliant
- Five configuration options

- Upstream management compatibility
- User-friendly Personal Computer (PC) monitor and control
- Automatic Transmitter Power Control (ATPC)
- Adaptive Time Domain Equalization (TDE)
- Extended Link Monitor Channel (ELMC)
- MCS-11/Telemetry Byte Oriented Serial (TBOS) Alarm/Control Interface
- Two independent PCM audio channels

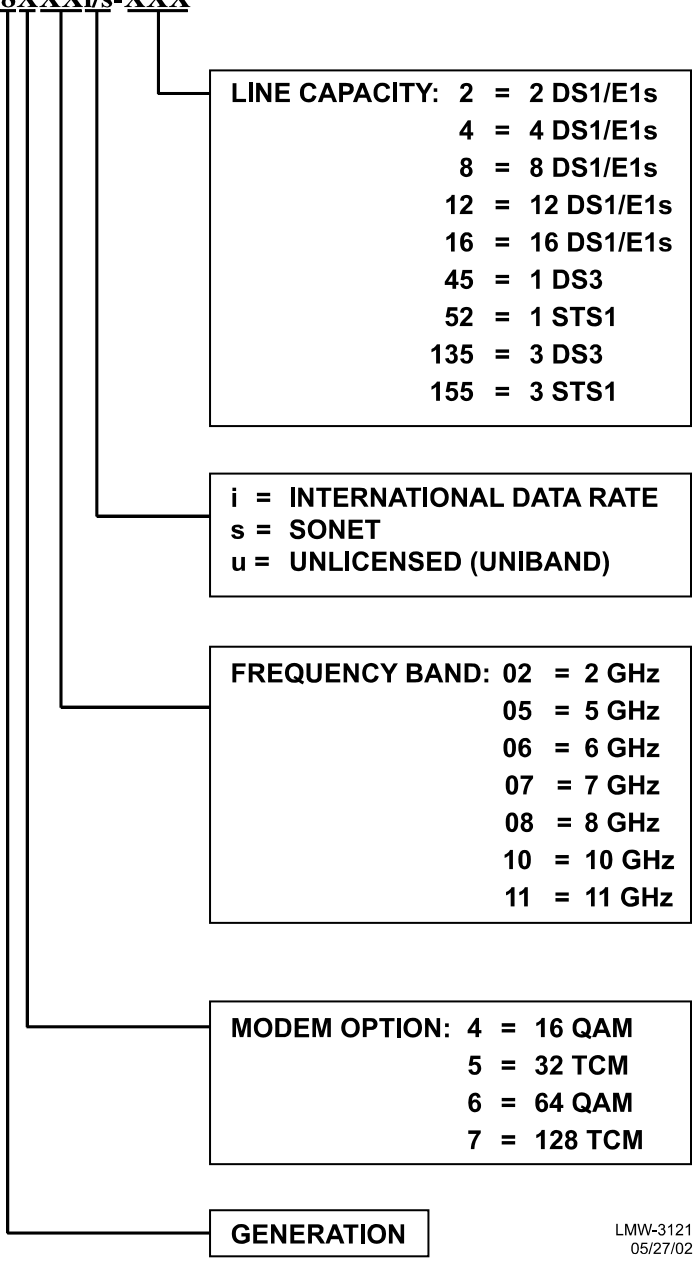

**Figure 2-1 Typical MDR-8000/i/s/u Series Microwave Digital Radio**

## 2.2 NAMING CONVENTION

The MDR-8000/i/s/u series radio naming conventions are as follows:

**MDR-8XXXi/s-XXX**



LMW-3121  
05/27/02

## **2.3 SYSTEM CONFIGURATIONS**

The MDR–8000/i/s radio can be provisioned as a terminal, synchronous repeater, ring terminal, or ring repeater.

## **2.4 RADIO CONFIGURATIONS**

### **2.4.1 Basic Configurations**

The MDR–8000/i/s/u supports the three basic configurations:

- Non–standby – available in all frequency bands – stand alone transmitter/receiver combination
- Hot–standby – available in all frequency bands – pair of transmitters and receivers, both pairs operating on the same set of go and return frequencies.
- Frequency diversity – available in all frequency bands except 2 GHz – pair of transmitters and receivers, each pair operating on a different set of go and return frequencies.

### **2.4.2 Ring**

Non–standby radios are typically used in ring systems where the radios are protected by the ring architecture.

### **2.4.3 Space Diversity Add–On**

Space diversity can be added to any of the three basic configurations and ring systems.

### **2.4.4 Optical 2 X 4 Configuration**

Hot–standby and frequency diversity configuration are available with 2–fiber or 4–fiber optical interfaces.

## **2.5 FEATURES AND OPTIONS**

Features and options for the MDR–8000/i/s/u series of microwave digital radios are described in the following paragraphs.

### **2.5.1 Primary Power**

The MDR–8000/i/s/u series radios operate from 20.5 to 60 V dc primary power with positive or negative ground.



## **2.5.2 Transmit Power Level Options**

The standard radio is provided without a power amplifier (PA) module for low-power applications. The optional PA module is available for high-power requirements. There are different levels for the different frequency bands. Refer to the electrical characteristics table in this section for specific levels.

## **2.5.3 Differential Absolute Delay Equalization (DADE)**

DADEing adjusts the differential absolute delay between the main and diversity signals in a space diversity configuration. DADEing is an automatic function within the MDR-8000/i/s/u receivers, reducing the time required for initial turn-up and test.

## **2.5.4 Trellis Encoding and Time Domain Equalization (TDE)**

Trellis encoding (DS1/E1/OC3) ensures that even with the most severe multipath, only the correct digital data is demodulated. TDE further reduces the disruptive effects of multipath distortion.

## **2.5.5 MCS-11 Alarm/Control Interface**

MCS-11 is standard in the MDR-8000. The MDR-8000 can interface with any alarm system that is based on the MCS-11 protocol. Use with the TSM-2500 network management system to develop a central access point to monitor and control the transmission system

## **2.5.6 Foreign Alarm Interface**

This provisioning option provides serial alarm/status reporting for the Telemetry Byte Oriented Serial (TBOS) protocol. A wire-wrap adapter is provided to mate to connector J305 on the backplane.

## **2.5.7 Relay Interface Option**

The optional AE-27AF Relay Interface unit provides relay closure indications of radio alarms and status. The relay interface also provides up to 16 station alarm inputs and six relay closure control outputs.

## **2.5.8 Extended Link Monitor Channel**

ELMC is standard and performance monitoring, alarm and status information, and remote controls are accessible through the ELMC channel, independent of network management interfaces.

Optional remote provisioning and downloading capability is provided via an ELMC option key that is mounted on the controller module.

## **2.5.9 Automatic Transmitter Power Control Provisioning Option**

Automatic Transmitter Power Control (ATPC) is a standard feature that can be enabled or disabled using the USI provisioning screens. When ATPC is disabled, transmitter power is fixed at the recommended maximum level. When ATPC is enabled, transmitter power may be reduced up to 10 dB from the maximum power level when the far end RSL is above a minimum level. When ATPC is enabled with timeout, transmitter ATPC activity is limited to a maximum time without returning to minimum transmit power. After five minutes of activity, the transmit power is forced to minimum until the far end RSL returns to normal levels.

## **2.5.10 Service Channels Provisioning Options**

The MDR–8000 provides a 256 kb/s auxiliary channel for servicing the radio. This is an overhead channel and is independent of the traffic channels. The 256 kb/s service channel contains four 64 kb/s service channels. Three of the four 64 kb/s channels (Service Channel 1, 2, and 3) can be provisioned on the USI for a specific use. Service channel 4 is dedicated to radio commands and ELMC. Service channel 4 is not provisionable. Only 16 kb/s out of the 64 kb/s in this channel are used.

## **2.5.11 Unlicensed Radio**

The MDR–8705u (unlicensed) radio provides fast deployment of service; no license and small antennas (no FCC requirements) allow immediate turnup. After the license is received, the unlicensed radio can be easily converted to the lower 6 GHz licensed band.

The MDR–8705u radio operates in the 5725–5850 Industrial Unlicensed band in accordance with FCC Part 15.247. This unlicensed radio, although operating in the same band as a spread spectrum radio, operates using narrower bandwidths than spread spectrum. Advantages and disadvantages of the unlicensed radio follow:

Advantages:

- Fast installation and turn up
- OC3 capacities
- Field convertible to lower 6 GHz licensed band
- Common network management with licensed radios.
- Common spares and training with licensed radios

Disadvantages:

- No interference protection
- Operating restrictions

- 5.725 to 5.850 GHz band
- XMT output power 1 Watt
- Performance could deteriorate due to interference as the frequency band becomes congested.

## 2.5.12 Modulation and Digital Filtering

### High Capacity OC3 Radios

The OC3 radio uses the 128 TCM modulation scheme. The 128 TCM provides maximum spectral efficiency for use at congested nodal sites requiring numerous paths or where only limited RF bandwidths are available. A simple capacity key change converts the radio from one type of modulation to the other, offering the user the maximum benefit depending on capacity, path length, and availability requirements. This flexibility also provides radio users the most alternatives in frequency congested areas.

The MDR-8000u/i/s employs digital filtering in the transmitter to further reduce out-of-band emissions and digital filtering in the receiver to reject nearby interfering signals. Digital filtering also allows optimum filter partitioning between the transmitter and receiver to produce the greatest system gain attainable for a given modulation technique. Improved filter consistency, repeatability and reliability are additional benefits of digital filters that result in lower user cost by reducing maintenance and replacement part expenses.

### Electrical Differences

The major differences between the radios within each RF band are the number and type of input signals that each radio will accept and the bandwidth efficiency. Table 1-1 summarizes the major electrical differences between these radios.

<b>Table 1–1. MDR–8000/i/s/u Radio Types</b>			
<i>RADIO TYPE</i>	<i>CAPACITY (MBPS)</i>	<i>MODULATION</i>	<i>RF BANDWIDTH REQUIREMENT</i>
MDR-85xx-2	2 X 1.544	32 TCM	1.25 MHz (1)
MDR-85xx-4	4 X 1.544	32 TCM	2.50 MHz (1)
MDR-85xx-8	8 X 1.544	32 TCM	3.75 MHz (1)
MDR-85xx-12	12 X 1.544	32 TCM	5.50 MHz (1)
MDR-85xx-16	16 X 1.544	32 TCM	7.50 MHz (1)
MDR-87xx-2	2 X 1.544	128 TCM	0.80 MHz (1)
MDR-87xx-4	4 X 1.544	128 TCM	1.25 MHz (1)
MDR-87xx-8	8 X 1.544	128 TCM	2.50 MHz (1)
MDR-87xx-12	12 X 1.544	128 TCM	3.75 MHz (1)
MDR-87xx-16	16 X 1.544	128 TCM	5.00 MHz (1)
MDR-85xxi-2	2 X 2.048	32 TCM	1.25 MHz (2)
MDR-85xxi-4	4 X 2.048	32 TCM	2.50 MHz (2)
MDR-85xxi-8	8 X 2.048	32 TCM	5.00 MHz (2)
MDR-85xxi-12	12 X 2.048	32 TCM	7.00 MHz (2)
MDR-85xxi-16	16 X 2.048	32 TCM	9.00 MHz (2)
MDR-87xxi-2	2 X 2.048	128 TCM	0.80 MHz (2)
MDR-87xxi-4	4 X 2.048	128 TCM	1.5 MHz (2)
MDR-87xxi-8	8 X 2.048	128 TCM	3.0 MHz (2)
MDR-87xxi-12	12 X 2.048	128 TCM	5.0 MHz (2)
MDR-87xxi-16	16 X 2.048	128 TCM	7.0 MHz (2)
MDR-86xx-45	1 X 44.736	64 QAM	10 MHz
MDR-86xx-135	3 X 44.736	64 QAM	30 MHz
MDR-87xx-52	1 X 51.840	128 TCM	10 MHz
MDR-87xx-155	3 X 51.840	128 TCM	30 MHz
<i>[1]</i> FCC channel bandwidth <i>[2]</i> 99% power bandwidth			

## 2.6 Functional Description

This section presents a short functional description of the MDR–8000 series radios. The descriptive information covers the radio’s main functions only.

Theory of operation, module description, turn-up procedures, and maintenance are located in the MDR-8000/i/s/u Instruction Book.

### **2.6.1 MDR–8000 Main Functions**

See figure 1–1. In the transmit direction the MDR–8000 uses a modulation structure where the I and Q baseband signals modulate the in–phase and quadrature phase components of the transmitter.

The OC3 I/O interface converts the format of the incoming OC3 data streams to I,Q, data, and clock. The OC3 I/O interface module uses the OC3 signals to generate 128 trellis code amplitude modulated (TCM) baseband signals. The transmitter processes the TCM baseband signals to generate the modulated TCM RF signal. The RF signal is then amplified and applied directly to the antenna branching or further amplified by a solid–state amplifier (optional) and applied to the antenna branching.

In the receive direction, the MDR–8000 uses a demodulation conversion structure. The received TCM signal is fed into a filter followed by a receiver module. The receiver module directly converts the RF signal to I and Q baseband signals and provides all of the acquisition loops. The receiver also provides countermeasures to dynamic path distortions. Clock and digital data are extracted from the analog channels and passed on to the I/O interface. The digital data is processed by the I/O interface module and converted to an OC3 format.

The MDR–8000 consists of I/O, transmit, receive, control and monitor, and power distribution subsystems.

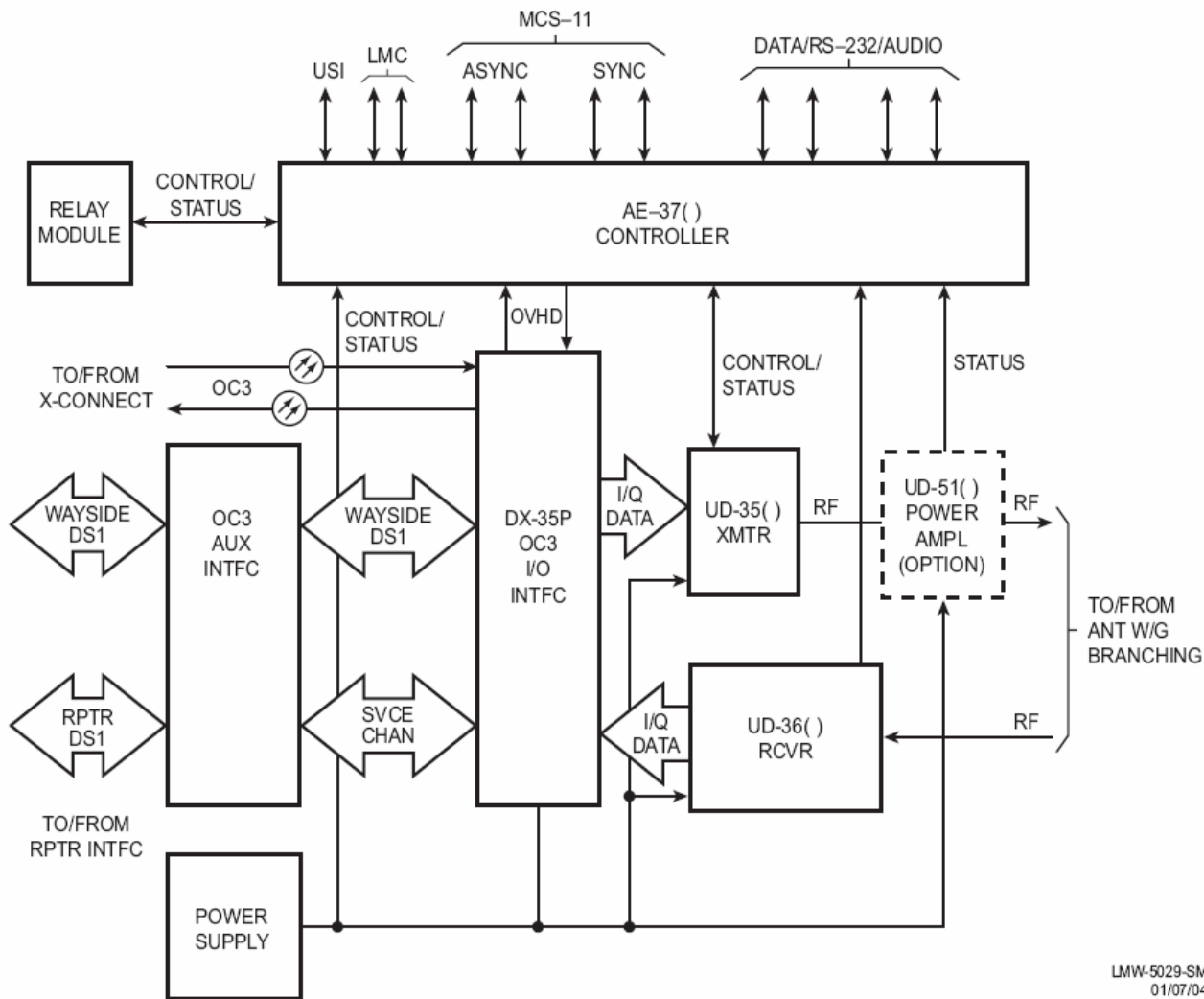

LMW-5029-SM  
01/07/04

**Figure 3-3 OC3 Non-Standby System Functional Block Diagram**  
**Figure 2.6.1-OC3 Non-Standby System Functional Block Diagram**

### **3.0 Test Methodology**

#### **3.1 Test Facility**

All the measurements were made in accordance with the procedures in part 2 of CFR 47 and were performed in the microwave lab of the Alcatel USA Wireless Transmission Division in Plano, Texas.

The radiated measurements were performed in the Alcatel USA Reliability Lab of the Transmission Network Division (Anna 3 meter & 10 meter Site), Plano, Texas.

#### **3.2 EUT Setup**

For conducted emission measurements, the equipment under test (EUT) was configured for testing as the customer would normally use it:

- mounted in a 19 in. wide by 7-ft. high aluminum rack
- connected to the OC3/DS1 test set
- shelf cover attached
- connected to antenna or power attenuator
- connected to a DC power supply

I/O cables were connected to the EUT and peripherals in the manner required for normal operation of the system.

During testing all cables and RF connectors were checked for proper attachment and contact.

For radiated emission measurements, the EUT was placed on a wooden turntable in an anechoic chamber. The cables were properly attached and operational. The EUT was configured to transmit (29dBm).

#### **Ambient Temperature and Humidity**

The temperature during testing was within 18 °C to 30 °C

The humidity was between 20% and 70%.

### 3.3 List of Test Equipment

#### ALCATEL USA, Wireless Transmission Division, Microwave Lab

Test Equipment	Mfg	Model #	Asset #	Serial	Cal Date	Cal Due
Spectrum Analyzer	Agilent	E4407 B	A43555	US40241249	12/4/2003	12/31/2005
Power Meter	HP	436A	A15882	1629A01483	12/4/2003	12/31/2005
Power Head	HP	8481B	A17706	1801A00317	10/14/2003	4/3/2005
Freq. Counter	Agilent	53181A	A48084	MY40004395	4/5/2004	4/30/2005
Data Test Set	Agilent	OmniBER 719	A48145	GB 19000334	8/19/2004	8/31/2006

#### ALCATEL USA, Transmission Network Division, Quality Lab

Test Equipment	Mfg	Model #	Cal Due
Spectrum Analyzer	HP	HP8566B	3/31/2005
Quasi-Peak Adapter	HP	HP85650A	7/31/2004
RF Amplifier	Kalmus	0.003-1000 MHz	02/29/2005
RF Amplifier	1 - 12 GHz	Lab Built	N/A (Calibrated for every test)
Antenna	EMCO	Bi-Log Antenna 30-1200 MHz	3/31/2005
Antenna	EMCO	Horn Antenna 1 – 12 GHz	3/31/2005



## 4.0 Measurements Results

### 4.1 Maximum Conducted Output Power FCC 15.247(b)(3) and ET Docket No. 99-231

#### Requirements for systems using digital modulation in the 5725-5850 MHz band:

- (b) The maximum peak output power of the intentional radiator shall not exceed the following:
  - (3) for systems using digital modulation in 5725-5850MHz band: 1 Watt (30 dBm).
  - (ii) Systems operating in the 5725-5850 MHz band that are used exclusively for fixed, point-to-point operations may employ transmitting antennas with directional gain greater than 6 dBi without any corresponding reduction in transmit peak output power.

**Test Conditions:** The conducted output power was checked directly on a radio configured for 29 dBm. The power level was checked on two different channels at low end (5740 MHz) and high end (5805 MHz) of the unlicensed band.

The antenna port was connected directly to a power meter equipped with power head calibrated for the 5725-5850 MHz band.

<b>Frequency MHz</b>	<b>Output Power</b>
<b>Low End: 5740</b>	<b>29 dBm (.794 Watt)</b>
<b>High End: 5805</b>	<b>29 dBm (.794 Watt)</b>

The lower power configurations (15 or 25 dBm) will meet this requirement.

## 4.2 Minimum 6dB RF Bandwidth, FCC Rule 15.247 (a)(2)

### Requirements for systems using digital modulation in the 5725-5850 MHz band:

The minimum 6 dB bandwidth shall be at least 500 kHz

**Test Conditions:** The antenna port of the EUT was connected to the input of a spectrum analyzer. The RES BW of the analyzer was set to 100 kHz and the spectrum analyzer center was set to the channel carrier frequency. The occupied bandwidth measure function was used to catch the emission bandwidth. The measurement was performed on the worst case only which is a radio configured for the lowest capacity (8 DS1, MDR-8705u-8).

This radio configuration has the narrowest RF spectrum and therefore the other radio configurations- 16 DS1 (MDR-8705u-16), 1 STS1 (MDR-8705u-52) and OC3 (MDR-8705u-155) will comply with FCC 15.247(a)(2).

<b>Radio Config.</b>	<b>Capac./Modul.</b>	<b>6dB Bandwidth</b>	<b>Notes</b>
<b>MDR-8705u-8</b>	<b>8 DS1/128 TCM</b>	<b>2.2152 MHz</b>	

The measurement is shown on plot 4.2.1

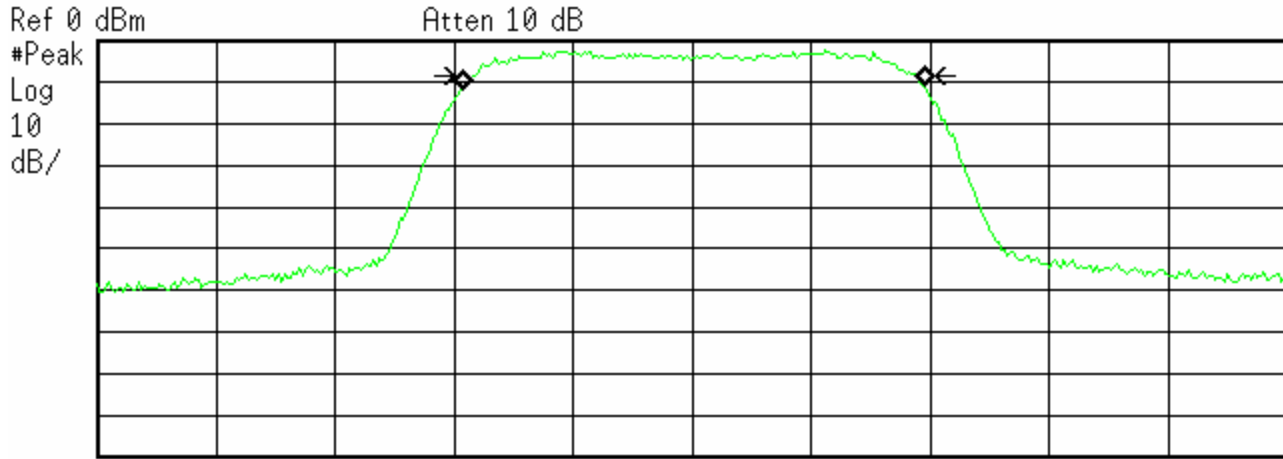

Center 5.805 GHz Span 5.747 MHz  
#Res BW 100 kHz #VBW 100 kHz #Sweep 300 ms (401 pts)

Occupied Bandwidth  
2.2152 MHz

Occ BW % Pwr 99.00 %  
x dB -6.00 dB

Transmit Freq Error 7.282 kHz  
x dB Bandwidth 2.131 MHz

Plot 4.2.1

### 4.3 Peak Power Spectral Density (PPSD) FCC15.247(d)

**Requirements for systems using digital modulation in the 5725-5850 MHz band:**

(d) For digitally modulated systems, the peak power spectral density conducted from the intentional radiator to the antenna shall not be greater than 8dBm in any 3 kHz band during any interval of continuous transmission.

**Test Conditions:** The antenna port of the EUT was connected to the input of a spectrum analyzer through an attenuator and:

- the START and STOP frequencies were set to the band edges of the maximum output passband
- RBW=3 kHz , VBW=100 kHz
- The highest level found in any 3 kHz band was recorded (after 100 sweeps of video averaging)

The measurements were done using the following power: 29 dBm (.794 Watt)

All the radio configurations have the spectral density lower than 8 dBm. The following table summarizes the data for each configuration.

<b>Radio Config.</b>	<b>Capac./Modul.</b>	<b>Transmit Output power, dBm</b>	<b>Measured PPSD, dBm</b>	<b>Plot #</b>
<b>MDR-8705u-8</b>	<b>8 DS1/128TCM</b>	<b>29</b>	<b>0.51</b>	<b>4.3.1</b>
<b>MDR-8705u-16</b>	<b>16 DS1/128TCM</b>	<b>29</b>	<b>-3.59</b>	<b>4.3.2</b>
<b>MDR-8705u-52</b>	<b>1 STS1/128TCM</b>	<b>29</b>	<b>-5.97</b>	<b>4.3.3</b>
<b>MDR-8705u-155</b>	<b>OC3/128TCM</b>	<b>29</b>	<b>-10.53</b>	<b>4.3.4</b>





**Model: MDR-8705u-52 (Capacity: 1 STS1, Modulation: 128TCM)**

Agilent 13:01:06 Apr 6, 2005

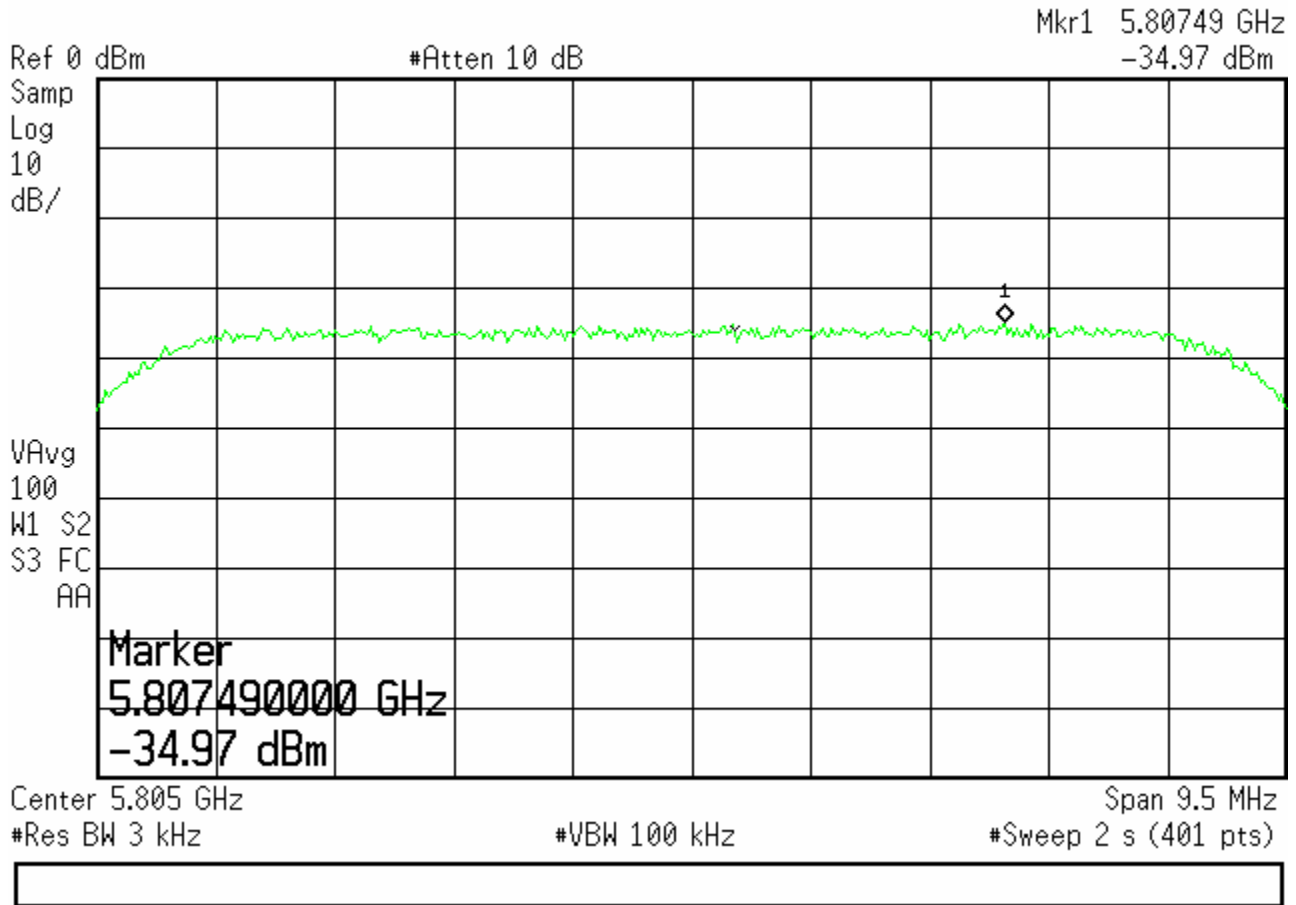

**Plot 4.3.3**

**The attenuation used in front of the Spectrum Analyzer was 29 dB and therefore:**

$$\text{PPSD} = 29 - 34.97 = -5.97 \text{ dBm}$$

**Model: MDR-8705u-155 (Capacity: OC3, Modulation: 128TCM)**

**Agilent** 11:59:26 May 12, 2005

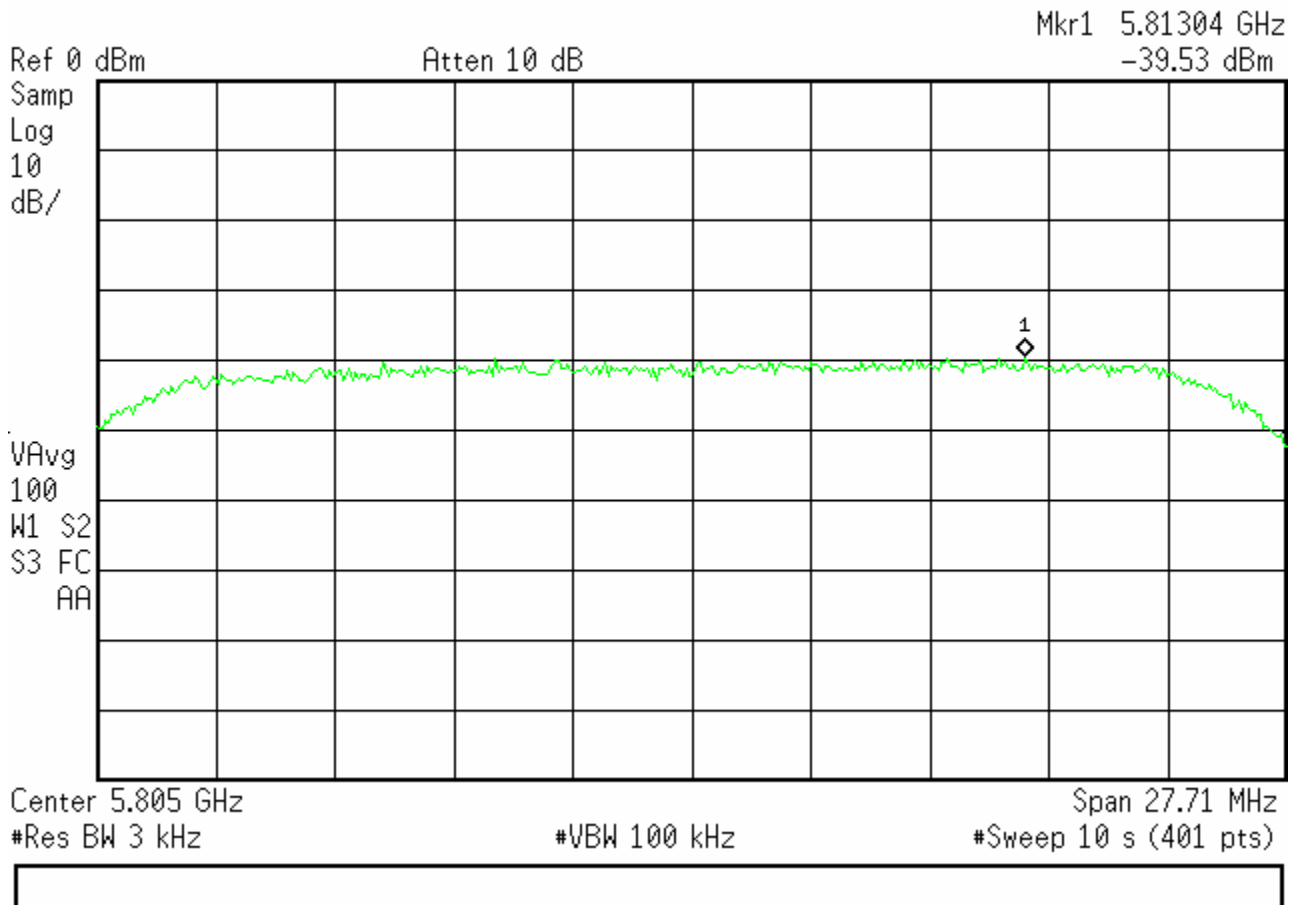

**Plot 4.3.4**

**The attenuation used in front of the Spectrum Analyzer was 31.4 dB and therefore:**

$$\text{PPSD} = 29.0 - 39.53 = -10.53 \text{ dBm}$$



## 4.4 Out of Band Conducted Emissions FCC 15.247(c)

### Requirements for systems using digital modulation in the 5725-5850 MHz band:

(c) In any 100 kHz bandwidth outside the frequency band in which the spread spectrum or digitally modulated intentional radiator is operating, the radio frequency power that is produced by the intentional radiator shall be at least 20 dB below that in the 100 kHz bandwidth within the band that contains the highest level of the desired power, based on either an RF conducted or a radiated measurement.

**Test Conditions:** The antenna port of the EUT was connected to the input of a spectrum analyzer and measurements were made between 1 MHz and 26 GHz on the radios configured from the lowest to the highest capacity (8 DS1 to OC3), output power (.794 Watt).

The results are shown in the following plots:

MDR-8705u-8	Plots 4.4.1.1 to 4.4.1.6
MDR-8705u-16	Plots 4.4.2.1 to 4.4.2.6
MDR-8705u-52	Plots 4.4.3.1 to 4.4.3.6
MDR-8705u-155	Plots 4.4.4.1 to 4.4.4.6

For the radio configurations there are no other emissions besides the transmitted signal.

4.4.1 Model: MDR-8705u-8 (Capacity: 8 DS1, Modulation: 128TCM)

Agilent 16:58:49 Apr 28, 2005

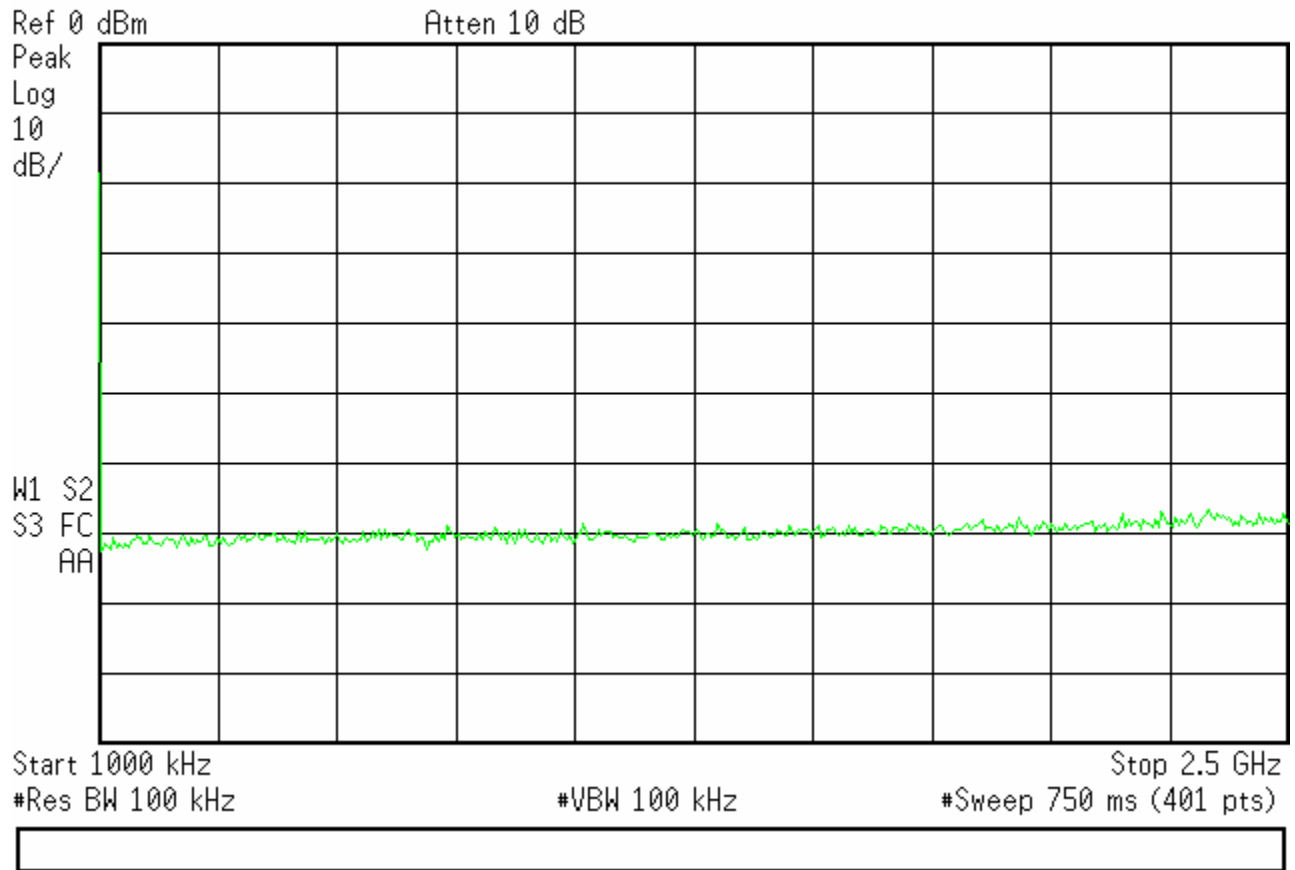

Plot 4.4.1.1





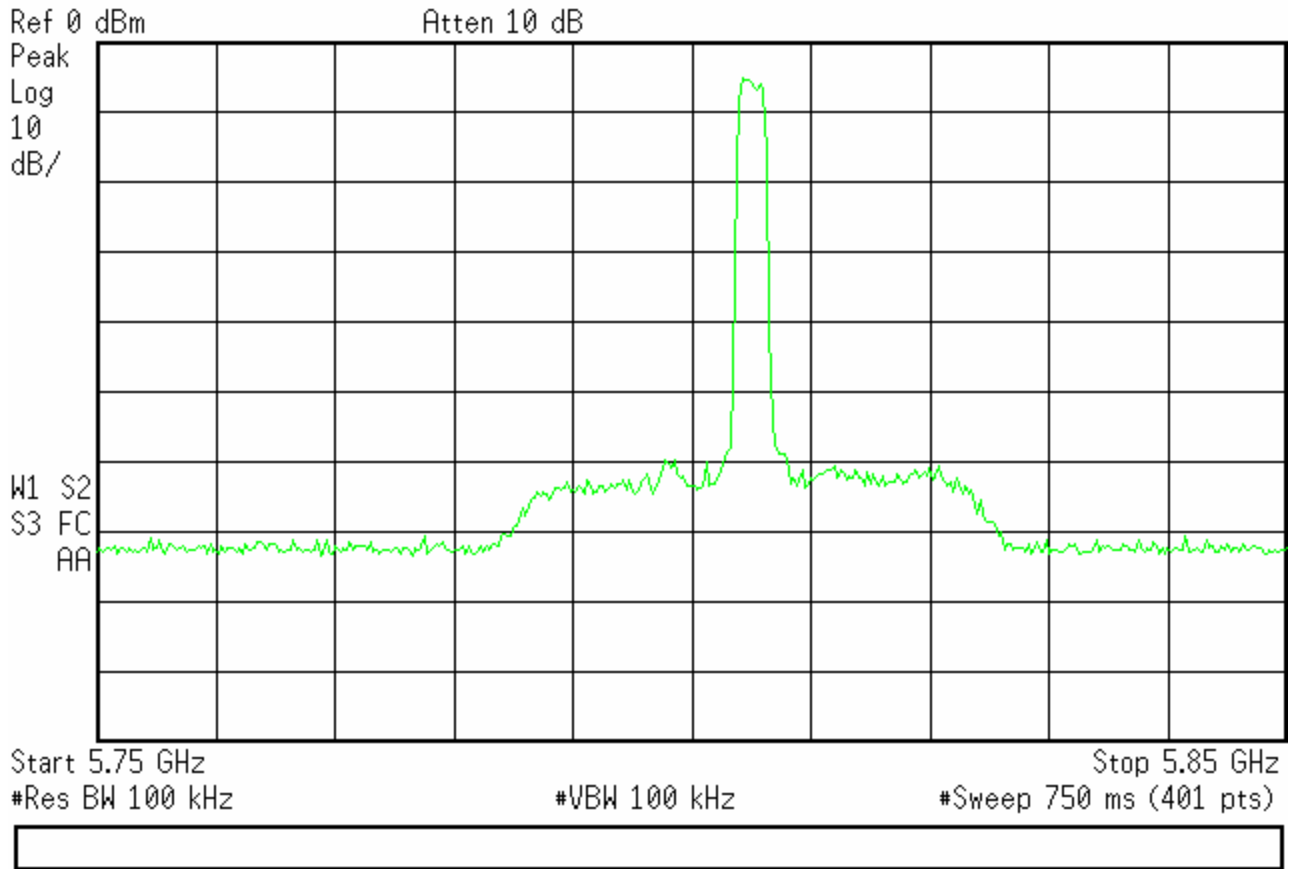

Plot 4.4.1.4

Note: This plot shows the transmit signal at 5805 MHz



#### 4.4.2 Model: MDR-8705u-16 (Capacity: 16 DS1, Modulation: 128TCM)

\* Agilent 16:07:35 Apr 28, 2005

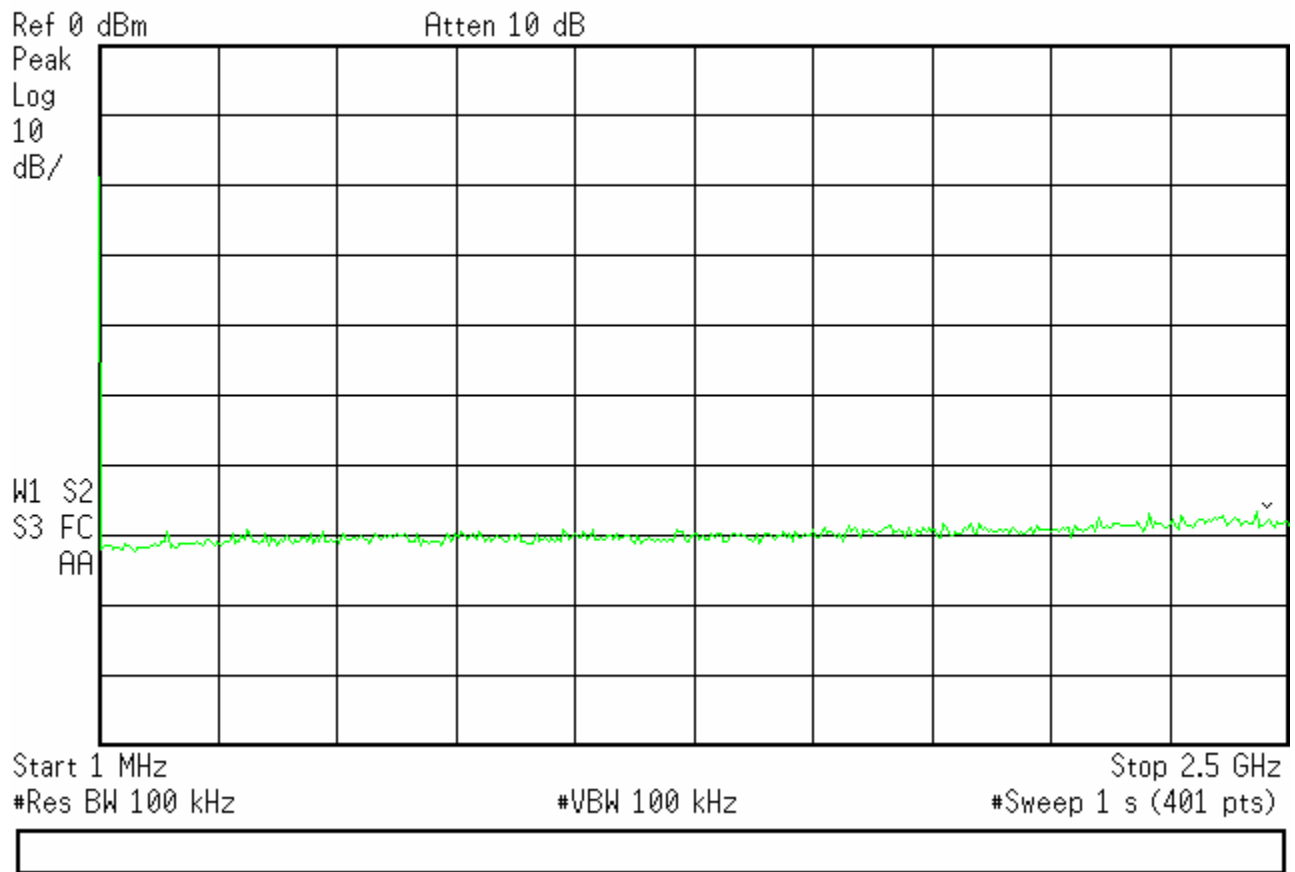

**Plot 4.4.2.1**







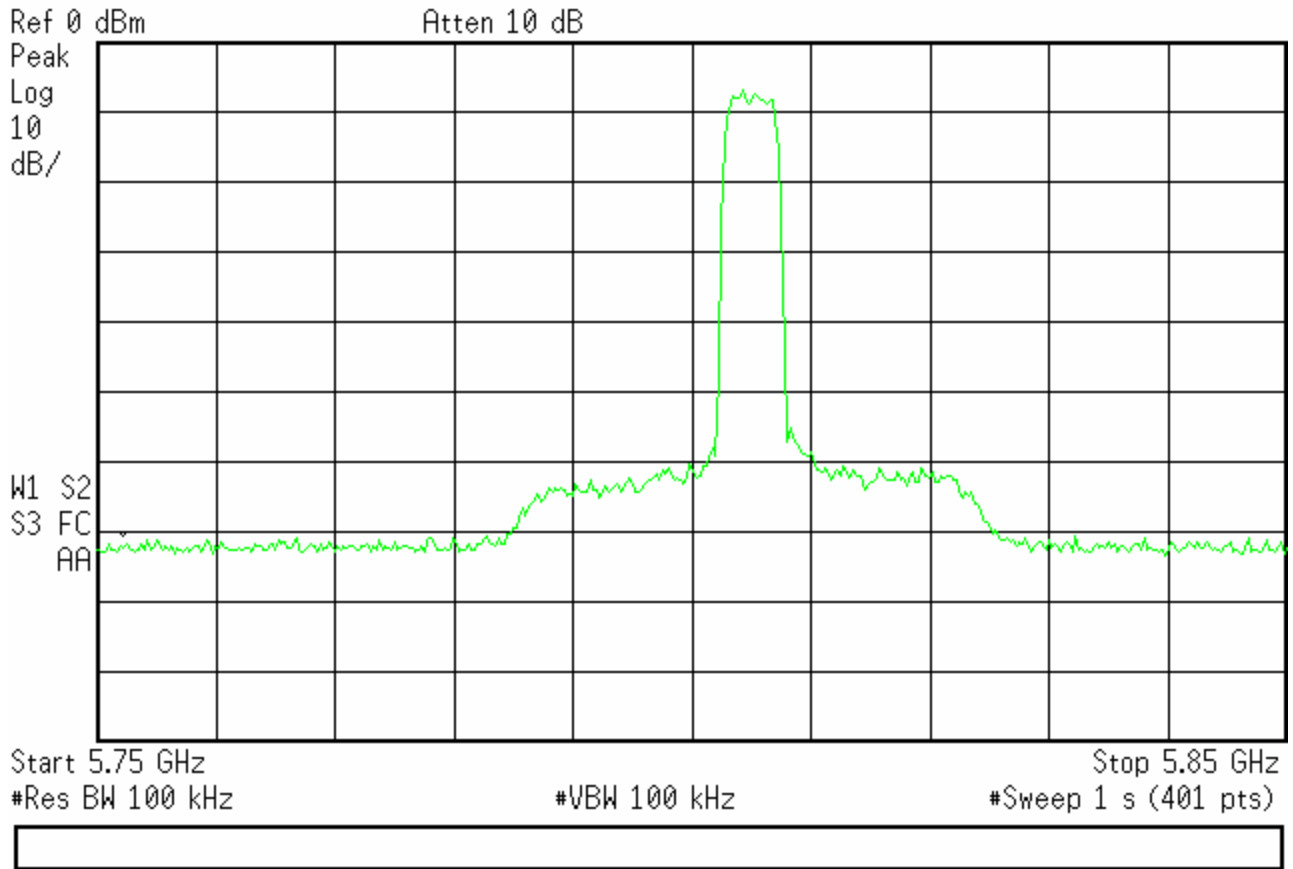

Plot 4.4.2.4

Note: This plot shows the transmit signal at 5805 MHz



### 4.4.3 Model: MDR-8705u-52 (Capacity: 1 STS1, Modulation: 128TCM)

\* Agilent 13:25:39 Apr 6, 2005

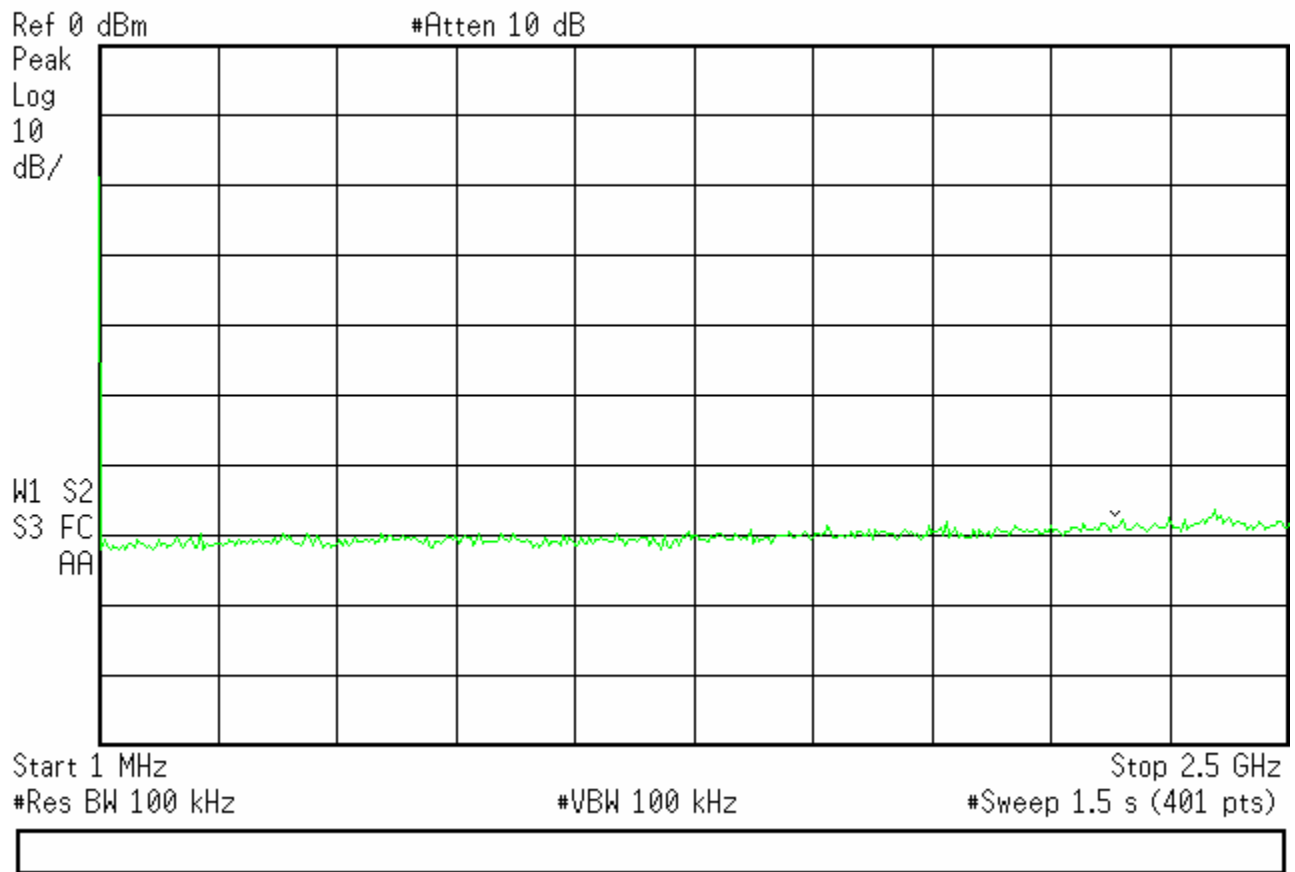

Plot 4.4.3.1

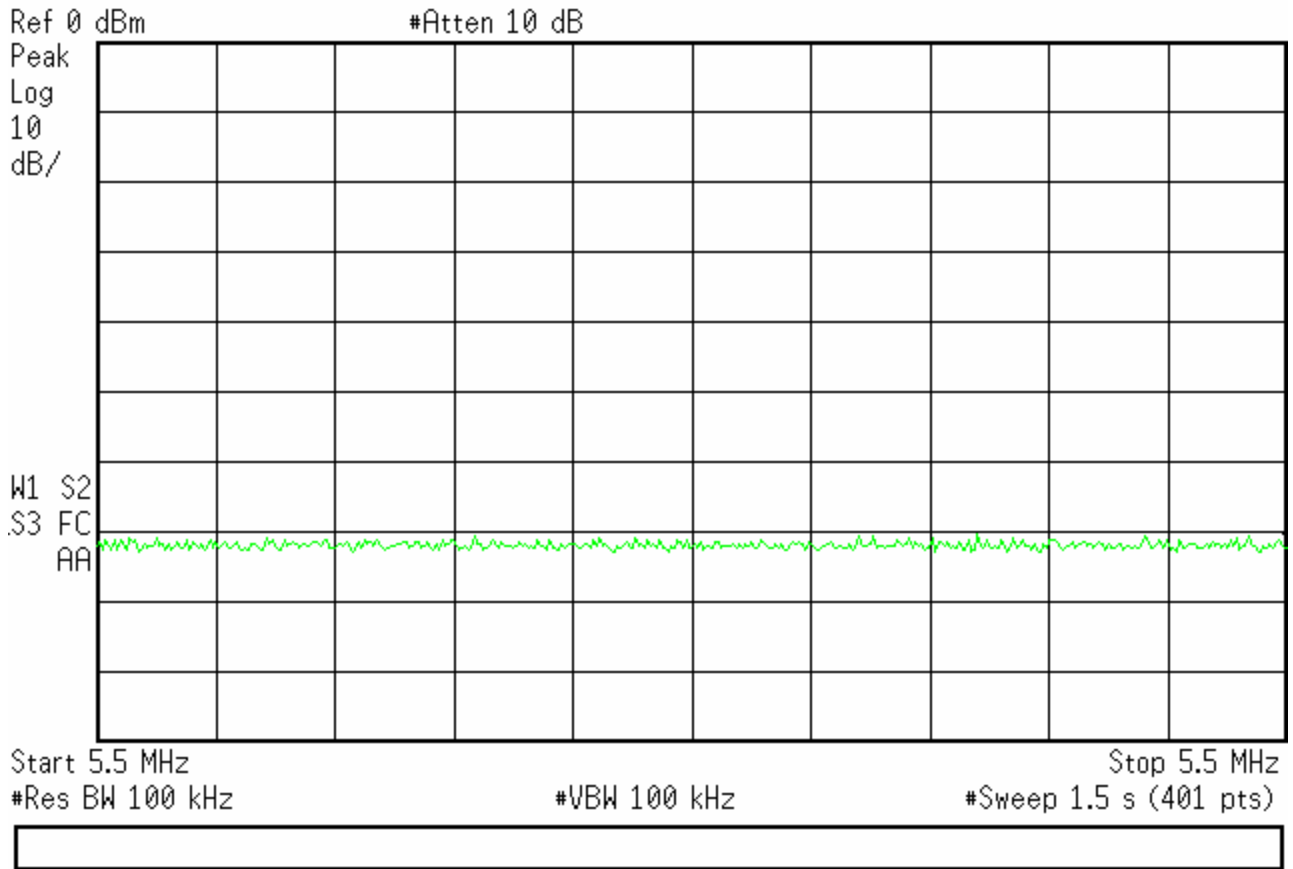

Plot 4.4.3.2

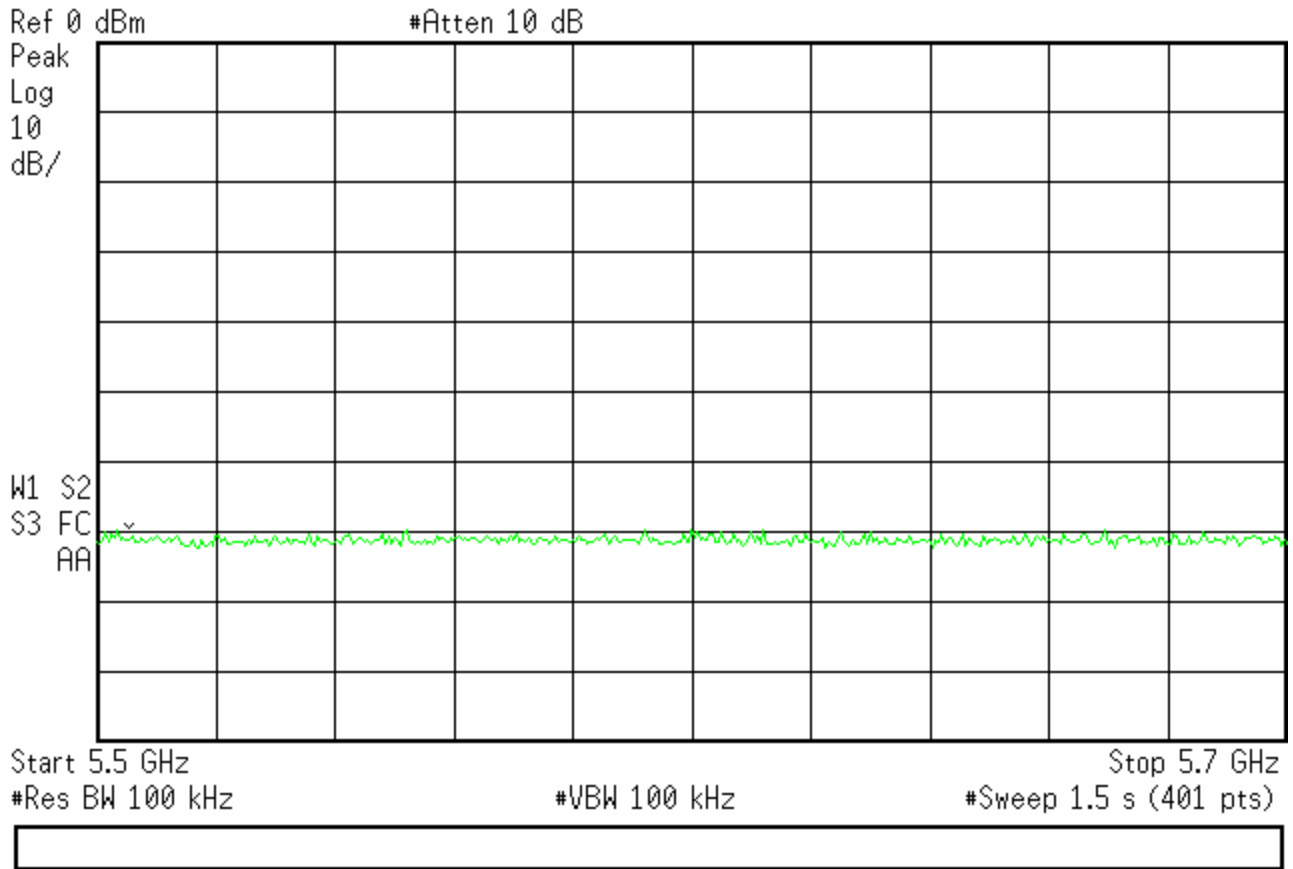

Plot 4.4.3.3

\* Agilent 13:28:25 Apr 6, 2005

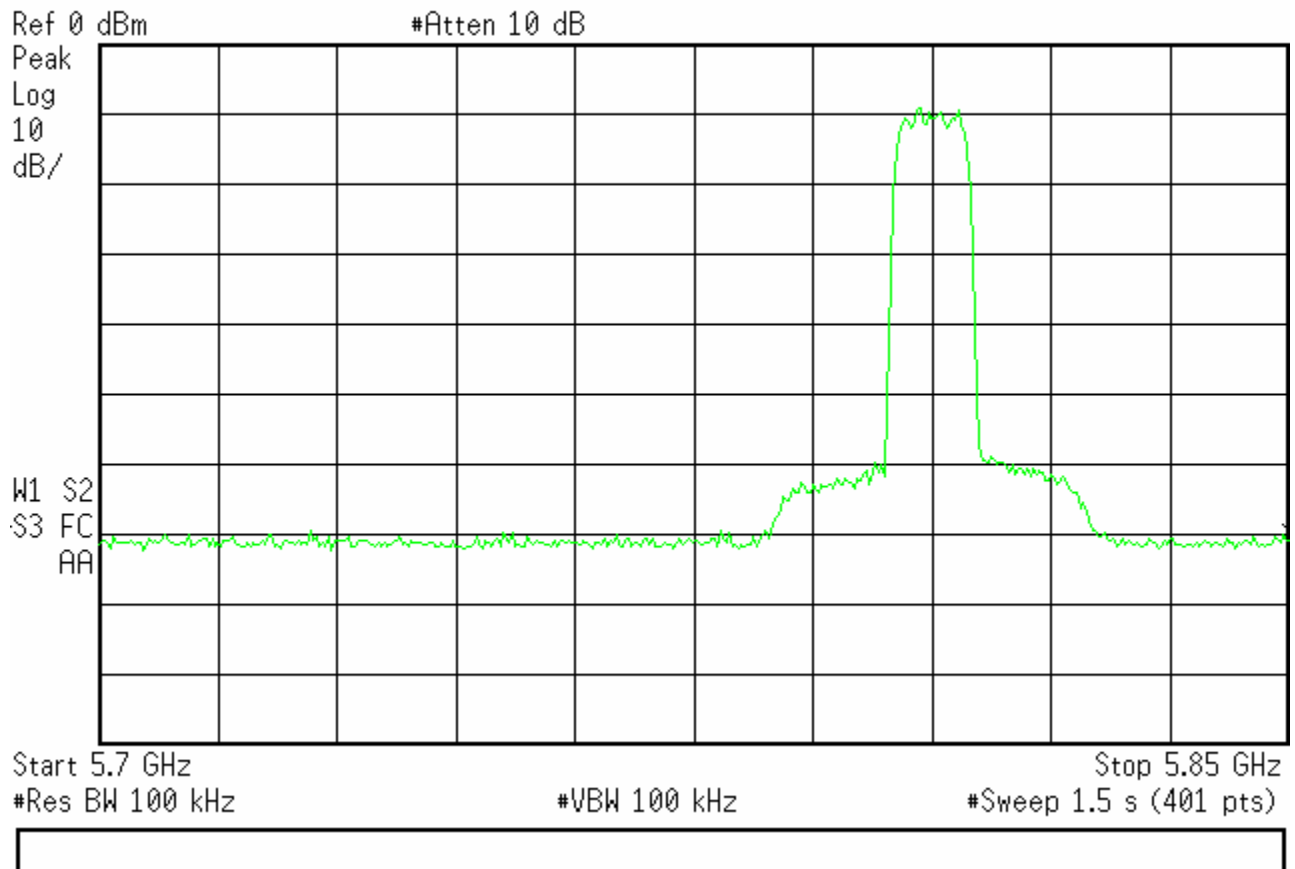

**Plot 4.4.3.4**

Note: This plot shows the transmit signal at 5805 MHz

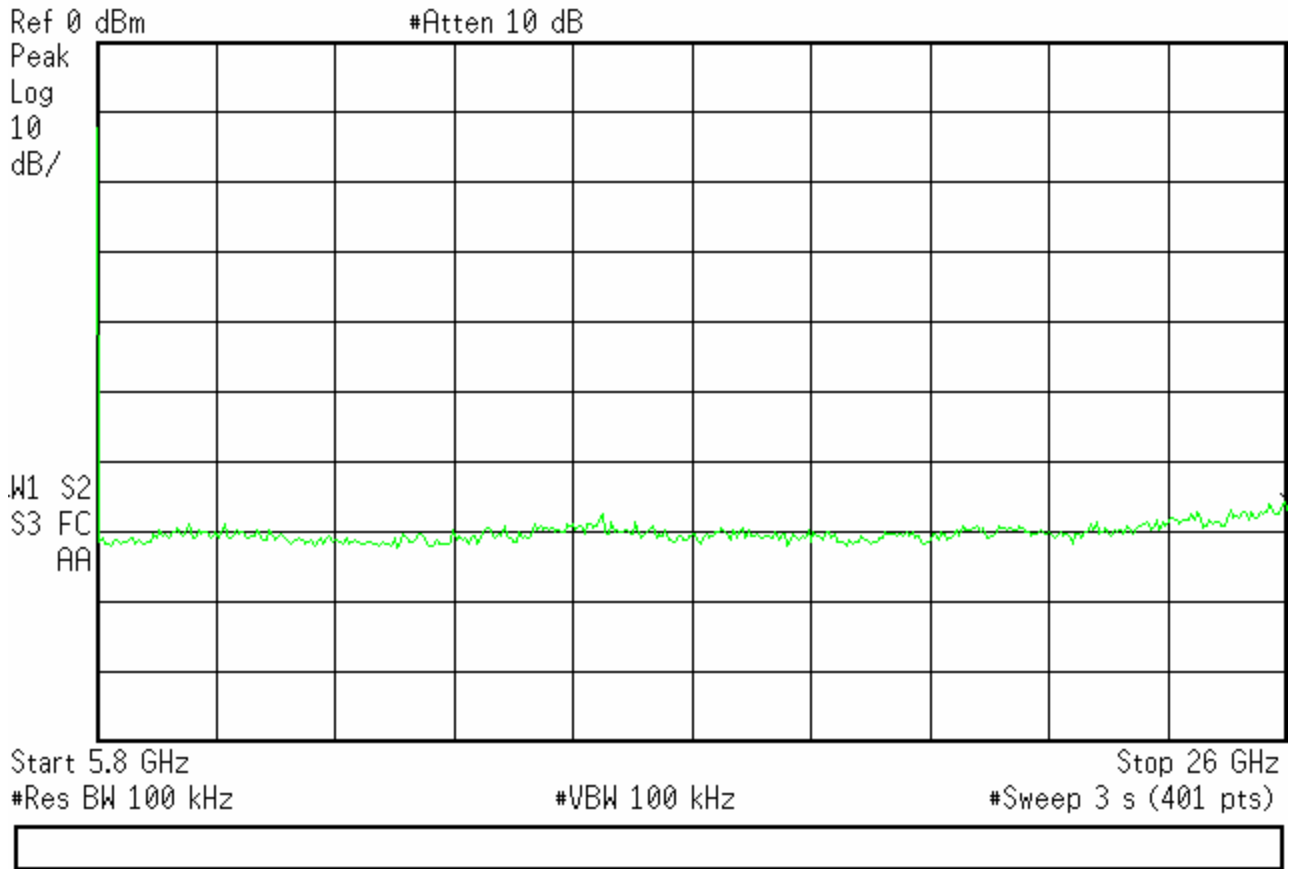

Plot 4.4.3.5



#### 4.4.4 Model: MDR-8705u-155 (Capacity: OC3, Modulation: 128TCM)

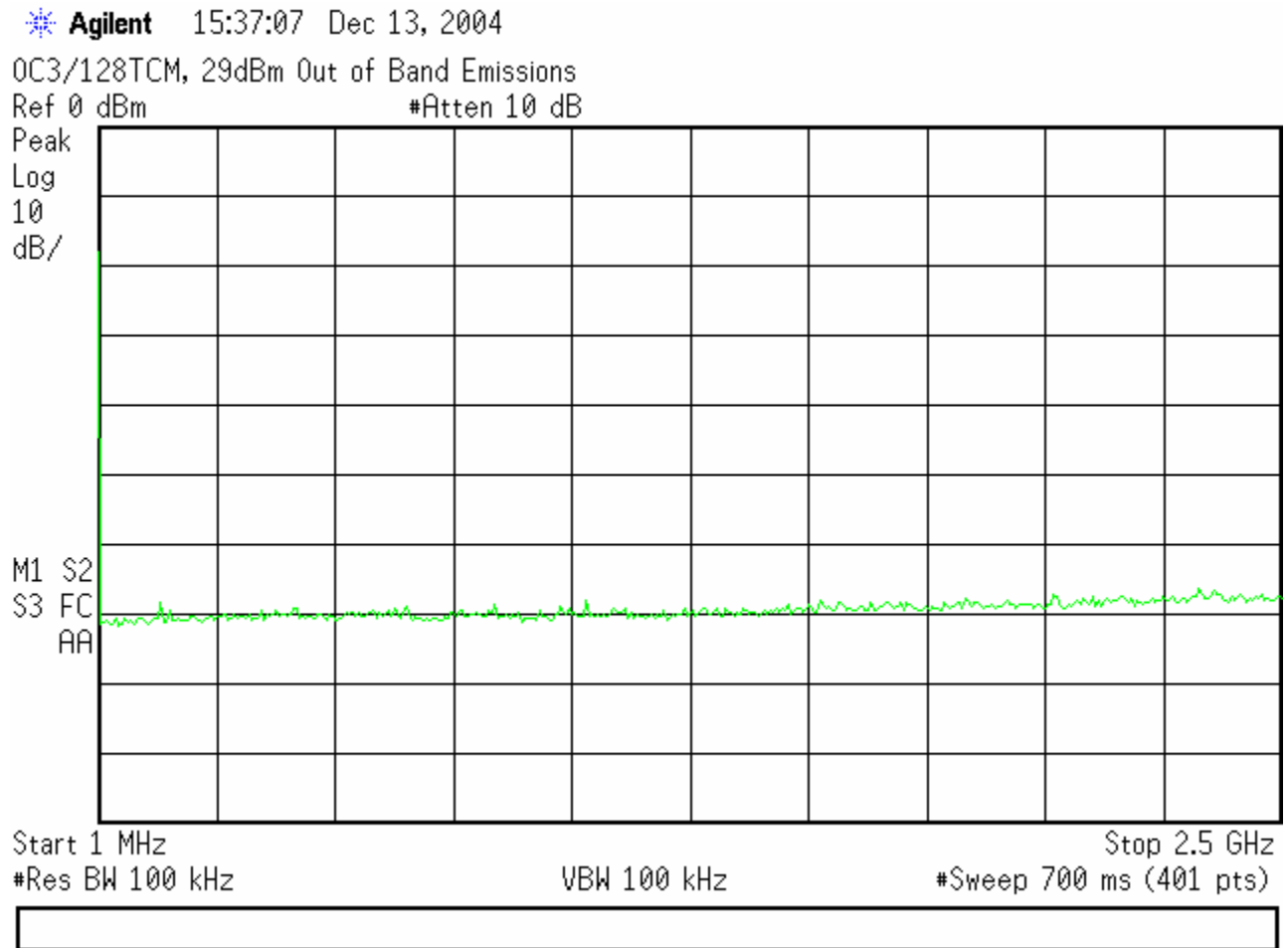

Plot 4.4.4.1

Agilent 15:36:02 Dec 13, 2004

OC3/128TCM, 29dBm Out of Band Emissions  
Ref 0 dBm #Atten 10 dB

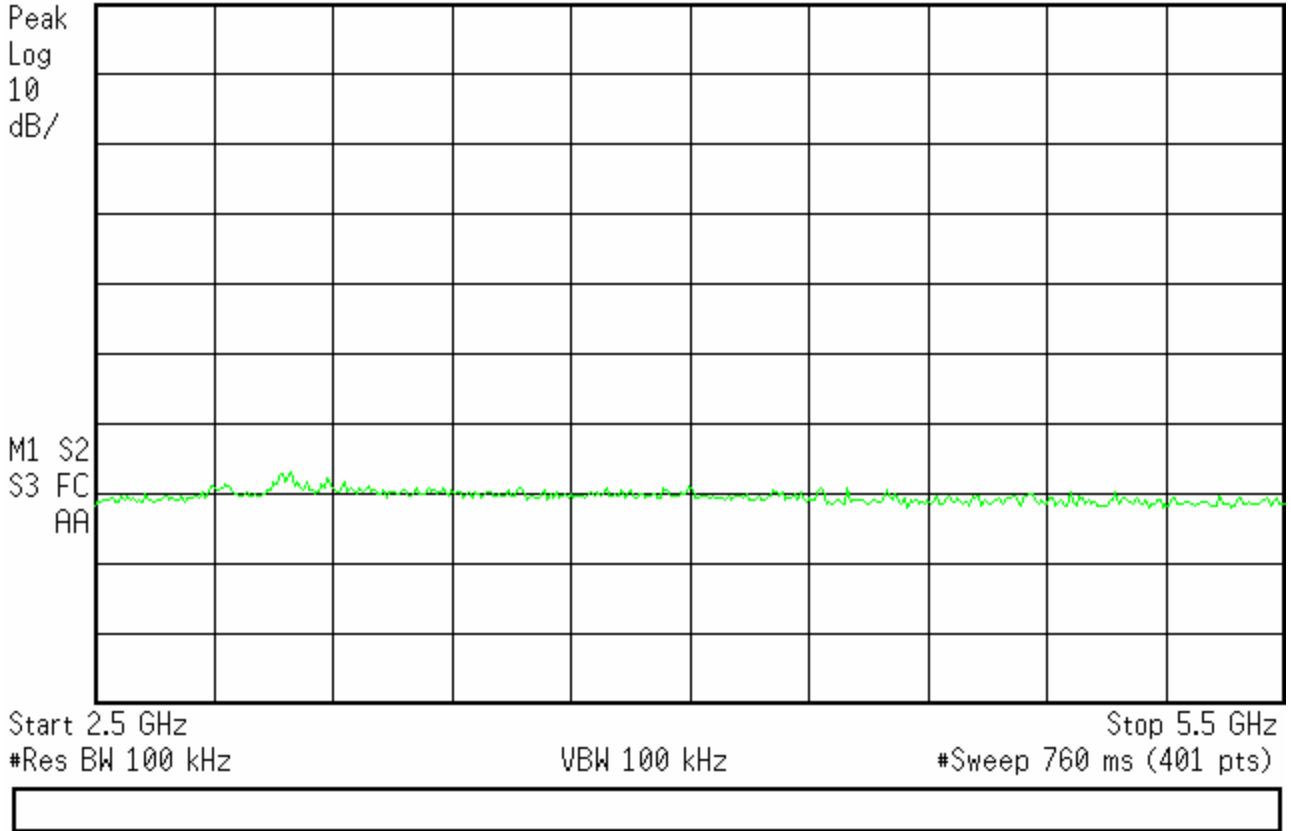

Plot 4.4.4.2

\* Agilent 15:41:52 Dec 13, 2004

OC3/128TCM, 29dBm Out of Band Emissions  
Ref 0 dBm #Atten 10 dB

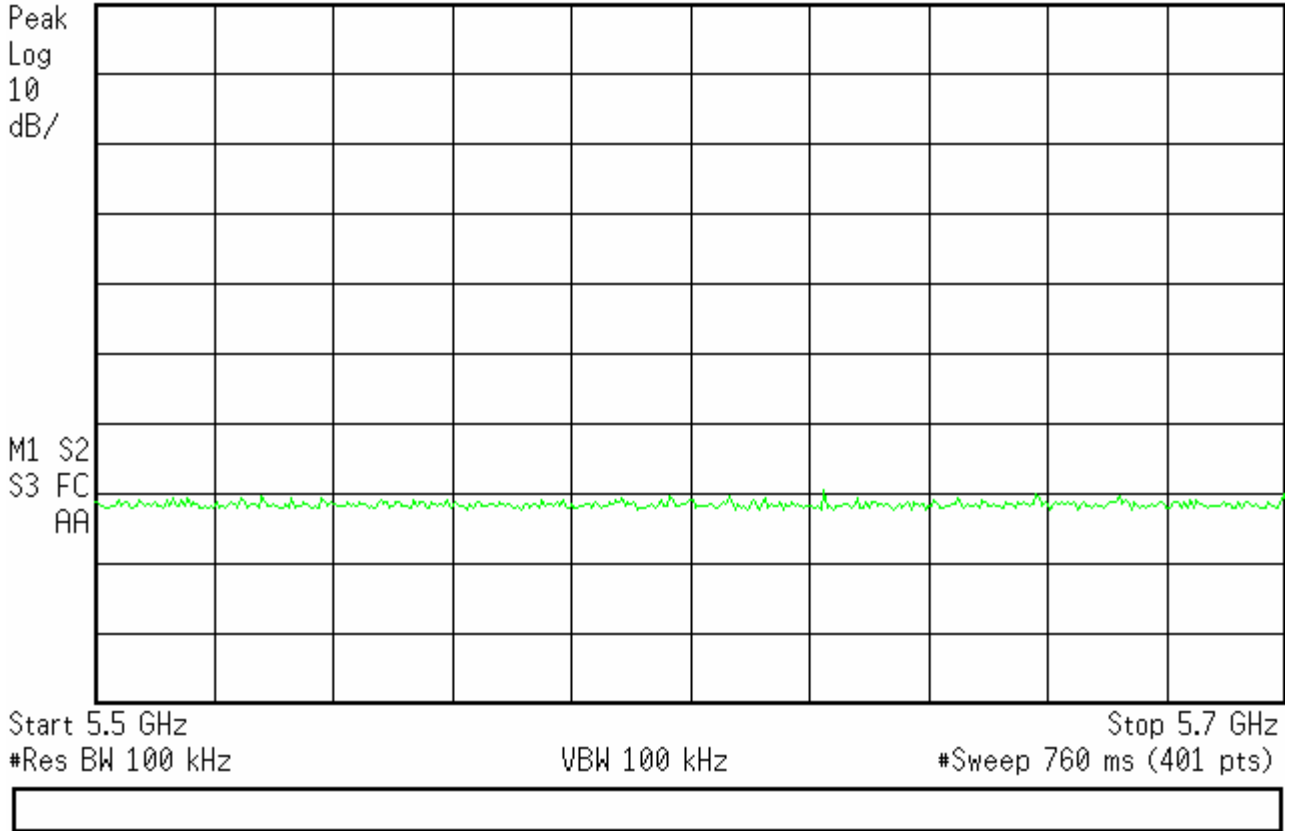

**Plot 4.4.4.3**

\* Agilent 15:43:18 Dec 13, 2004

OC3/128TCM, 29dBm Out of Band Emissions  
Ref 0 dBm #Atten 10 dB

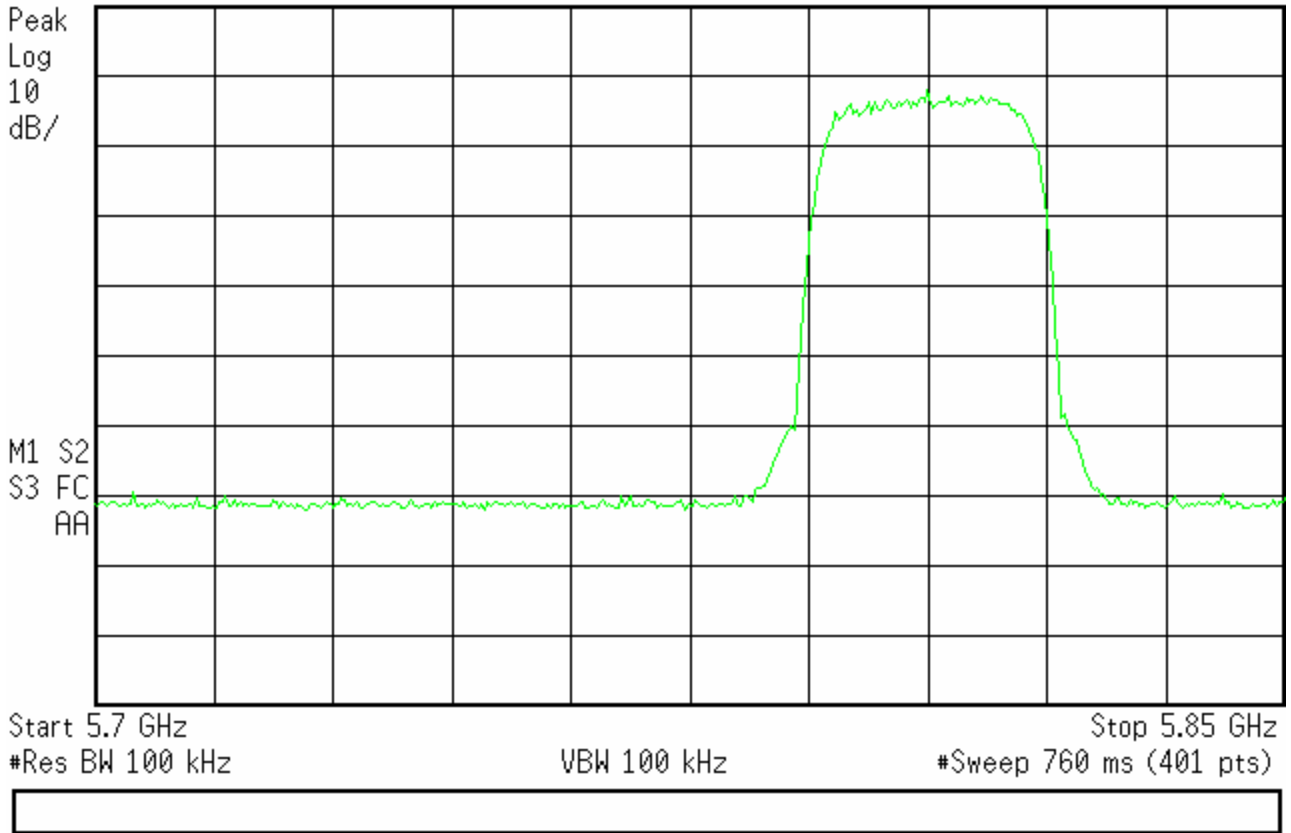

**Plot 4.4.4.4**

Note: This plot shows the transmit signal at 5805 MHz

Agilent 15:44:51 Dec 13, 2004

OC3/128TCM, 29dBm Out of Band Emissions  
Ref 0 dBm #Atten 10 dB

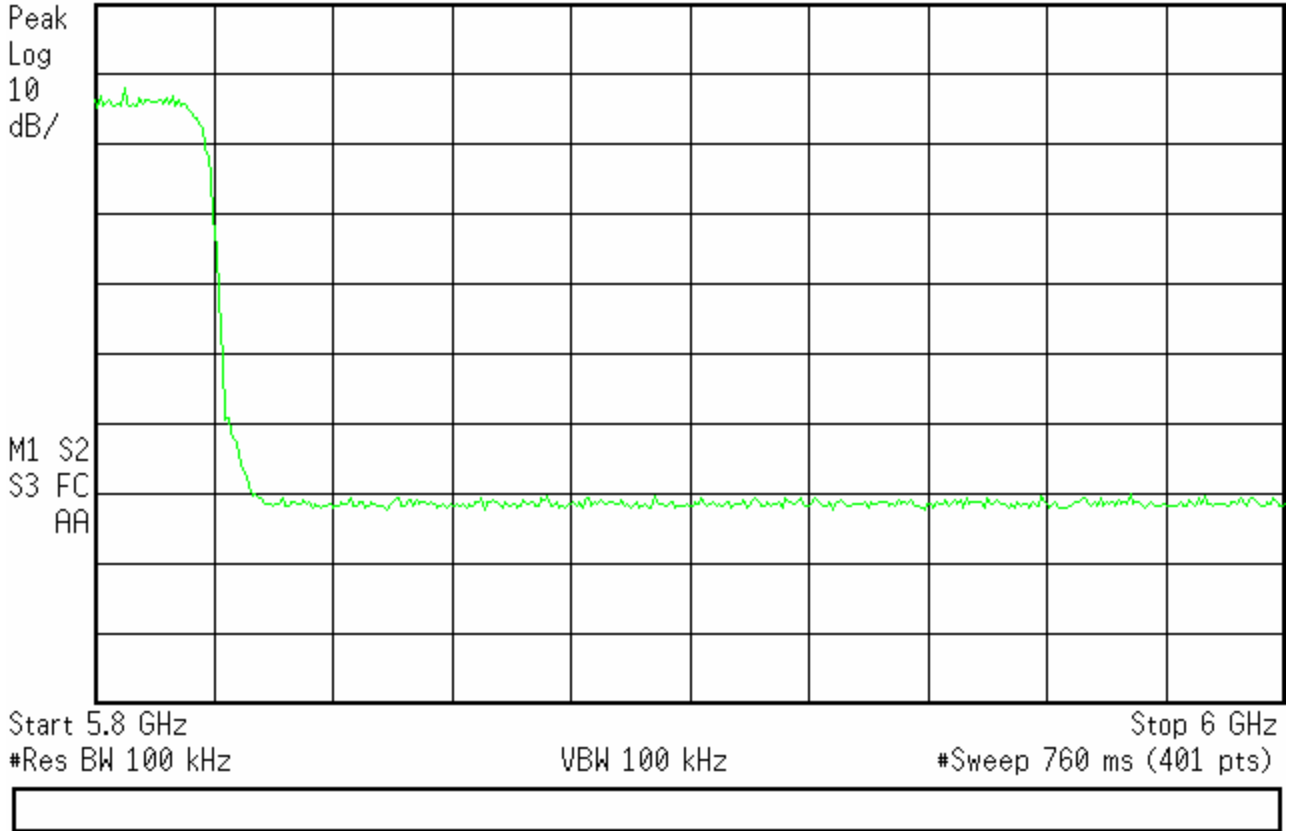

Plot 4.4.4.5

Agilent 15:45:57 Dec 13, 2004

OC3/128TCM, 29dBm Out of Band Emissions  
Ref 0 dBm #Atten 10 dB

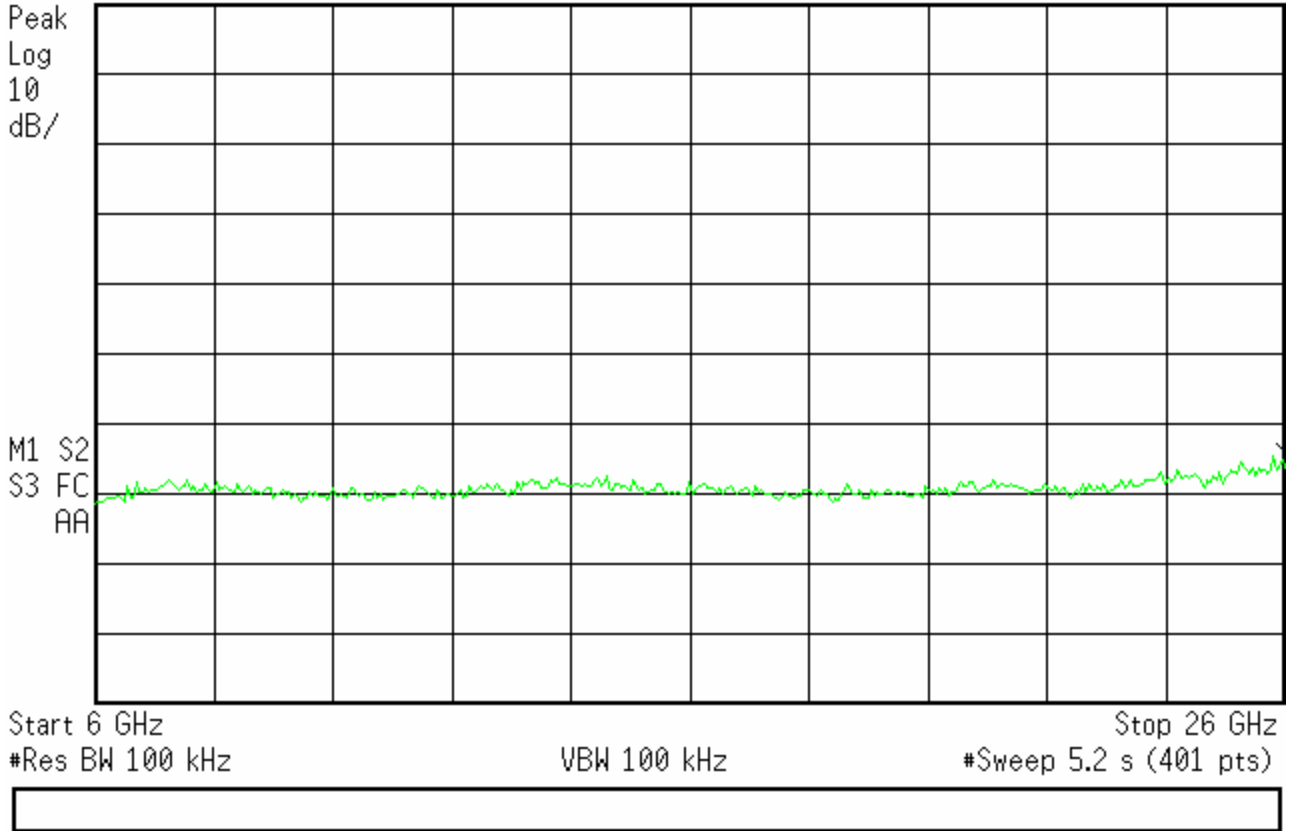

Plot 4.4.4.6

## **4.5 Out of Band Radiated Emissions FCC 15.247(c)**

### **Requirements for systems using digital modulation in the 5725-5850 MHz band:**

Out of band emissions which are close to or that exceed the 20 dB requirement described in the FCC 15.247 (c) should comply with the general radiation emission requirement.

**Test Conditions:** No emission found that violates the above requirement (see out of band emissions plots).

## **4.6 Radiated Emissions in Restricted Bands FCC 15.247(c)**

### **Requirements for systems using digital modulation in the 5725-5850 MHz band:**

(c) ... in addition radiated emissions which fall in the restricted bands, as defined in paragraph 15.205(a), must comply with the radiated emission limits specified in paragraph 15.209 (a).

**Test Conditions:** Radiated emissions checks were performed in the restricted bands as defined in paragraph 15.205(a).

No emission found that violates the FCC 15.209 limits

The data on the following table show the radiated emissions (if there is any) in the restricted bands.

**Uni-Band Radio Radiated Emissions FCC Part 15.209**

Frequency Band (MHz)	Spur Frequency (MHz)	Ant Pol	Corrected Reading dBuV (60dB Load Connected)	Corrected Reading dBuV (2Ft Parab. Antenna Connected)	Limit dBuV	Margin dBuV
37.5 - 38.25						
73 -74.6						
74.8 - 75.2						
108 - 121.94	121.9	V		38.3	43.5	-5.2
108 - 121.94	121.9	H		36.4	43.5	-7.1
108 - 121.94					43.5	-43.5
108 - 121.94					43.5	-43.5
123 - 138	133.53	V		35.7	43.5	-7.8
123 - 138	133.53	H	30.1	33.8	43.5	-9.7
123 - 138	134.936	V		32.1	43.5	-11.4
123 - 138	134.936	H	29.9	32	43.5	-11.5
149.9 - 150.05						
156.52475 - 156.52525						0
156.7 - 156.9						0
162.0125 - 167.17	164.7	V		38.8	43.5	-4.7
162.0125 - 167.17	162.13	H		36.3	43.5	-7.2
167.72 - 173.2						0
167.72 - 173.2						0
240 - 285						0
240 - 285						0
240 - 285						0
240 - 285						0
240 - 285						0
240 - 285						0
240 - 285						0
240 - 285						0
240 - 285						0
240 - 285						0
240 - 285						0
240 - 285						0
240 - 285						0
240 - 285						0
240 - 285						0
240 - 285						0
322 - 335.4						0
399.9 - 410						0
608 - 614						0
960 - 1240						0
960 - 1240						0



960 - 1240					0
960 - 1240					0
960 - 1240					0
960 - 1240					0
960 - 1240					0
1300 - 1427					0
1435 - 1626					0
1645.5 - 1646.5					0
1660 - 1710					0
1718.8 - 1722.2					0
2200 - 2300					0
2310 - 2390					0
2483.5 - 2500					0
2655 - 2900					0
2655 - 2900					0
3260 - 3267					0
3332 - 3339					0
3345.8 - 3358					0
3600 - 4400					0
3600 - 4400					0
4500 - 5250					0
5350 - 5460					0
7250 - 7750					0
8025 - 8500					0
9000 - 9200					0
9300 - 9500					0

Note:

All measurements were made at 3 meters

The corrected reading takes into account the antenna factor, cable losses and the gain of the amplifier used for the measurements.

The column "Spur Frequency" lists the emissions found in some of the restricted bands.

The Margin column shows how much the spur level is below the FCC15.209 limit.

For frequencies higher than 10 GHz no readings were above the noise floor of the test equipment.

## **4.7 Antenna Requirement**

The MDR-8X05u-XXX radios must be professionally installed and for that reason they are exempt from the antenna restrictions of the FCC Part 15.203.

The MDR-8X05u-XXX radios will be used for point -to- point communications only, as fixed, permanent or temporary links requiring the use of 2-10 foot parabolic antennas or 1 foot and 2 foot flat panels. The 1 foot flat panel must be installed at least 5 feet from all persons. These antennas have narrow beam widths and require a professional installer for alignment.

The maximum transmit power of the MDR-8X05u-XXX radio is 1 Watt (30 dBm) and it is adjusted in the factory during the final tests. However the output power can be adjusted to lower levels by professional installer during installation. The method of adjusting the output power is described in the manual written for use by professional trained installers.

This radio is sold without antenna and the customer chooses from commercially available antennas.