



APPLICATION FOR FCC CERTIFICATION

ALCATEL USA

Digitally Modulated Radio

MODEL	FCC ID
MDR-8505u-2	JF6-8505u-2
MDR-8505u-4	JF6-8505u-4
MDR-8505u-8	JF6-8505u-8
MDR-8505u-16	JF6-8505u-16
MDR-8605u-45	JF6-8605u-45

Number of Pages: 61

Date of Report: June 26, 2002

Table of Contents

1.0 Summary of tests	3
2.0 General Description	4
2.1 Standard Features	4
2.2 Naming Convention	7
2.3 System Configuration	8
2.4 Radio Configuration	8
2.5 Functional description	12
3.0 Test Methodology	14
3.1 Test Facility	14
3.1 List of Test Equipment	16
4.0 Measurements Results	18
4.1 Maximum Conducted Output Power	18
4.2 Minimum 6DB RF Bandwidth	19
4.3 Peak Power Spectral Density	21
4.4 Out of Band Conducted Emissions	27
4.4.1 MDR-8505u-2	28
4.4.2 MDR-8505u-4	34
4.4.3 MDR-8505u-8	40
4.4.4 MDR-8505u-16	46
4.4.4 MDR-8605u-45	52
4.5 Out of Band Radiated Emissions	58
4.6 Radiated Emissions in Restricted Bands	58
4.7 Antenna Requirement	61

1.0 Summary of FCC 15.247 Tests

Model: MDR-8505u-2
MDR-8505u-4
MDR-8505u-8
MDR-8505u-16
MDR-8605u-45

FCC ID: JF6-8505u-2
JF6-8505u-4
JF6-8505u-8
JF6-8505u-16
JF6-8605u-45

Test	FCC Reference	Results
Max. Output Power	15.247 (b) (3)	Pass
6db Bandwidth	15.247 (a) (2)	Pass
Peak Power Spectral Density	15.247 (d)	Pass
Out of Band Conducted Emissions	15.247 (c)	Pass
AC Conducted Emissions	15.207	Not required; battery operation only
Out of Band Radiated Emissions	15.247 (c)	N/A
Antenna requirement	15.203	Pass

Elec. Design Engineer: Theodore Timaru

Date: 06/26/02

RF Group Manager: Duane Mortensen

Date: 06/26/02

2.0 General Description

The MDR-8X05-XX is the MDR-8000/i/s/u version for the unlicensed frequency band: 5725-5850Mhz. It is the latest addition of the Alcatel family of digital microwave products.

The MDR–8000/i/s/u series Microwave Digital Radios (see figure 2–1) consists of:

- Solid–state, licensed, digital radios that provide transport for DS1, E1, and DS3 in 2, 6, 7, 8, 10, and 11 GHz RF frequency bands and OC3 in 6, 7, 8, 10, and 11 GHz RF frequency bands
- Solid–state, unlicensed digital radios that provide transport for DS1 and DS3 in the 5 GHz RF frequency band.

The following capacities and modulation schemes are available:

- MDR–8000 – 2, 4, 8, 12, or 16 North American Standard DS1 channels at either 32 or 128 TCM or 1 or 3 North American Standard DS3 channels with 1 or 3 wayside DS1 channels at 64 QAM
- MDR–8000i – 2, 4, 8, 12, or 16 CCITT E1 channels at either 32 or 128 TCM
- MDR–8000s – 3 North American Standard STS1 channels with 3 wayside DS1 channels at 128 TCM
- MDR–8000u– 2, 4, 8, or 16 North American Standard DS1 channels at 32 TCM or 1 North American Standard DS3 channel with 1 wayside DS1 channel at 16 or 64 QAM.

The radio fits into a standard 19 in. (483 mm) rack and occupies seven vertical rack increments. Up to four fully–equipped hot–standby radios can be mounted in a standard 7 ft rack. The radio is front accessible and can be mounted against a wall or back–to–back against other equipment.

2.1 STANDARD FEATURES

Standard features include:

- Frequency bands from 2 to 11 GHz

- Committee of European Post and Telegraph (CEPT)/Federal Communications Commission (FCC) applications
- DS1, E1, DS3, and OC3 Traffic capacities.

- International Telecommunications Union (ITU)/ETSI/FCC compliant
- Five configuration options
- Upstream management compatibility
- User-friendly Personal Computer (PC) monitor and control
- Automatic Transmitter Power Control (ATPC)
- Adaptive Time Domain Equalization (TDE)
- Extended Link Monitor Channel (ELMC)
- MCS-11/Telemetry Byte Oriented Serial (TBOS) Alarm/Control Interface
- Two independent PCM audio channels

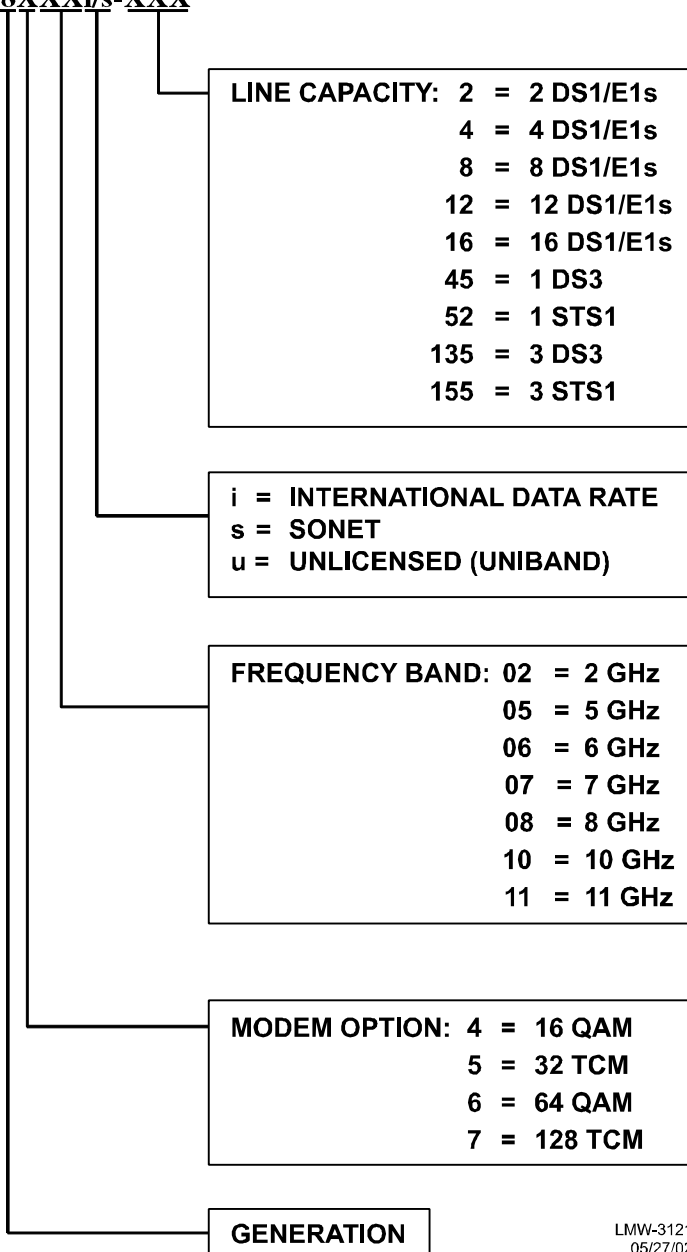

Figure 2-1 Typical MDR-8000/i/s/u Series Microwave Digital Radio

2.2 NAMING CONVENTION

The MDR-8000/i/s/u series radio naming conventions are as follows:

MDR-8XXXi/s-XXX



LMW-3121
05/27/02

2.3 SYSTEM CONFIGURATIONS

The MDR–8000/i/s radio can be provisioned as a terminal, synchronous repeater, ring terminal, or ring repeater.

2.4 RADIO CONFIGURATIONS

2.4.1 Basic Configurations

The MDR–8000/i/s/u supports the three basic configurations:

- Non–standby – available in all frequency bands – stand alone transmitter/receiver combination
- Hot–standby – available in all frequency bands – pair of transmitters and receivers, both pairs operating on the same set of go and return frequencies.
- Frequency diversity – available in all frequency bands except 2 GHz – pair of transmitters and receivers, each pair operating on a different set of go and return frequencies.

2.4.2 Ring

Non–standby radios are typically used in ring systems where the radios are protected by the ring architecture.

2.4.3 Space Diversity Add–On

Space diversity can be added to any of the three basic configurations and ring systems.

2.4.4 Optical 2 X 4 Configuration

Hot–standby and frequency diversity configuration are available with 2–fiber or 4–fiber optical interfaces.

2.5 FEATURES AND OPTIONS

Features and options for the MDR–8000/i/s/u series of microwave digital radios are described in the following paragraphs.

2.5.1 Primary Power

The MDR–8000/i/s/u series radios operate from 20.5 to 60 V dc primary power with positive or negative ground.

2.5.2 Transmit Power Level Options

The standard radio is provided without a power amplifier (PA) module for low-power applications. The optional PA module is available for high-power requirements. There are different levels for the different frequency bands. Refer to the electrical characteristics table in this section for specific levels.

2.5.3 Differential Absolute Delay Equalization (DADE)

DADEing adjusts the differential absolute delay between the main and diversity signals in a space diversity configuration. DADEing is an automatic function within the DS1/E1 and OC3 MDR-8000/i/s/u receivers, reducing the time required for initial turn-up and test.

2.5.4 Trellis Encoding and Time Domain Equalization (TDE)

Trellis encoding (DS1/E1/OC3) ensures that even with the most severe multipath, only the correct digital data is demodulated. TDE further reduces the disruptive effects of multipath distortion.

2.5.5 MCS-11 Alarm/Control Interface

MCS-11 is standard in the MDR-8000. The MDR-8000 can interface with any alarm system that is based on the MCS-11 protocol. Use with the TSM-2500 network management system to develop a central access point to monitor and control the transmission system

2.5.6 Foreign Alarm Interface

This provisioning option provides serial alarm/status reporting for the Telemetry Byte Oriented Serial (TBOS) protocol. A wire-wrap adapter is provided to mate to connector J305 on the backplane.

2.5.7 Relay Interface Option

The optional AE-27AF Relay Interface unit provides relay closure indications of radio alarms and status. The relay interface also provides up to 16 station alarm inputs and six relay closure control outputs.

2.5.8 Extended Link Monitor Channel

ELMC is standard and performance monitoring, alarm and status information, and remote controls are accessible through the ELMC channel, independent of network management interfaces.

Optional remote provisioning and downloading capability is provided via an ELMC option key that is mounted on the controller module.

2.5.9 Automatic Transmitter Power Control Provisioning Option

Automatic Transmitter Power Control (ATPC) is a standard feature that can be enabled or disabled using the USI provisioning screens. When ATPC is disabled, transmitter power is fixed at the recommended maximum level. When ATPC is enabled, transmitter power may be reduced up to 10 dB from the maximum power level when the far end RSL is above a minimum level. When ATPC is enabled with timeout, transmitter ATPC activity is limited to a maximum time without returning to minimum transmit power. After five minutes of activity, the transmit power is forced to minimum until the far end RSL returns to normal levels.

2.5.10 Service Channels Provisioning Options

The MDR-8000 provides a 256 kb/s auxiliary channel for servicing the radio. This is an overhead channel and is independent of the traffic channels. The 256 kb/s service channel contains four 64 kb/s service channels. Three of the four 64 kb/s channels (Service Channel 1, 2, and 3) can be provisioned on the USI for a specific use. Service channel 4 is dedicated to radio commands and ELMC. Service channel 4 is not provisionable. Only 16 kb/s out of the 64 kb/s in this channel are used.

2.5.11 Unlicensed Radio

The MDR-8X05u (unlicensed) radio provides fast deployment of service with microwave radio. No license and small antennas (no FCC requirements) allow immediate turnup. After the license is received, the unlicensed radio can be easily converted to the lower 6 GHz licensed band.

The MDR-8X05u radio operates in the 5725-5850 Information, Scientific, and Medical (ISM) band in accordance with FCC Part 15.247. This unlicensed radio, although operating in the same band as a spread spectrum radio, operates using narrower bandwidths than spread spectrum. Advantages and disadvantages of the unlicensed radio follow:

Advantages:

- Fast installation and turn up
- 2, 4, 8, 16 DS1 and 1 DS3 capacities
- Field convertible to lower 6 GHz licensed band
- Field expandable to higher capacities.
- Common network management with licensed radios.
- Common spares and training with licensed radios

Disadvantages:

- No interference protection

- Operating restrictions
- 5.725 to 5.850 GHz band
- XMT output power 1 Watt
- Performance could deteriorate due to interference as the frequency band becomes congested.

2.5.12 Modulation and Digital Filtering

Low Capacity Radios

Two Trellis Coded Modulation (TCM) choices (32 and 128 TCM) are available in the low-capacity radios. The 32 TCM provides maximum system gain for longer paths, higher availability, and smaller sized antennas. The 128 TCM provides maximum spectral efficiency for use at congested nodal sites requiring numerous paths or where only limited RF bandwidths are available. A simple capacity key change converts the radio from one type of modulation to the other, offering the user the maximum benefit depending on capacity, path length, and availability requirements. This flexibility also provides radio users the most alternatives in frequency congested areas.

A narrow transmitter spectrum with very little wasted out-of-band energy is characteristic of TCM. The resulting spectrums are easily coordinated into the most congested frequency bands because they don't interfere with existing users.

High Capacity Radios

The DS3 radio uses a 64 Quadrature Amplitude Modulation (QAM) scheme. The OC3 radio uses the 128 TCM modulation scheme.

High and Low Capacity Radios

The MDR-8000/i/s employs digital filtering in the transmitter to further reduce out-of-band emissions and digital filtering in the receiver to reject nearby interfering signals. Digital filtering also allows optimum filter partitioning between the transmitter and receiver to produce the greatest system gain attainable for a given modulation technique. Improved filter consistency, repeatability and reliability are additional benefits of digital filters that result in lower user cost by reducing maintenance and replacement part expenses.

Electrical Differences

The major differences between the radios within each RF band are the number and type of input signals that each radio will accept and the bandwidth efficiency. Table 1-1 summarizes the major electrical differences between these radios.

Table 1–1. MDR–8000/i/s/u Radio Types			
<i>RADIO TYPE</i>	<i>CAPACITY (MBPS)</i>	<i>MODULATION</i>	<i>RF BANDWIDTH REQUIREMENT</i>
MDR-85xx-2	2 X 1.544	32 TCM	1.25 MHz (1)
MDR-85xx-4	4 X 1.544	32 TCM	2.50 MHz (1)
MDR-85xx-8	8 X 1.544	32 TCM	3.75 MHz (1)
MDR-85xx-12	12 X 1.544	32 TCM	5.50 MHz (1)
MDR-85xx-16	16 X 1.544	32 TCM	7.50 MHz (1)
MDR-87xx-2	2 X 1.544	128 TCM	0.80 MHz (1)
MDR-87xx-4	4 X 1.544	128 TCM	1.25 MHz (1)
MDR-87xx-8	8 X 1.544	128 TCM	2.50 MHz (1)
MDR-87xx-12	12 X 1.544	128 TCM	3.75 MHz (1)
MDR-87xx-16	16 X 1.544	128 TCM	5.00 MHz (1)
MDR-85xxi-2	2 X 2.048	32 TCM	1.25 MHz (2)
MDR-85xxi-4	4 X 2.048	32 TCM	2.50 MHz (2)
MDR-85xxi-8	8 X 2.048	32 TCM	5.00 MHz (2)
MDR-85xxi-12	12 X 2.048	32 TCM	7.00 MHz (2)
MDR-85xxi-16	16 X 2.048	32 TCM	9.00 MHz (2)
MDR-87xxi-2	2 X 2.048	128 TCM	0.80 MHz (2)
MDR-87xxi-4	4 X 2.048	128 TCM	1.5 MHz (2)
MDR-87xxi-8	8 X 2.048	128 TCM	3.0 MHz (2)
MDR-87xxi-12	12 X 2.048	128 TCM	5.0 MHz (2)
MDR-87xxi-16	16 X 2.048	128 TCM	7.0 MHz (2)
MDR-86xx-45	1 X 44.736	64 QAM	10 MHz
MDR-86xx-135	3 X 44.736	64 QAM	30 MHz
MDR-87xx-52	1 X 51.840	128 TCM	10 MHz
MDR-87xx-155	3 X 51.840	128 TCM	30 MHz
<i>[1]</i> FCC channel bandwidth			
<i>[2]</i> 99% power bandwidth			

2.6 Functional Description

This section presents a short functional description of the MDR–8000 series radios. The descriptive information covers the radio main functions only.

Theory of operation, module description, turnup procedures and maintenance are located in the MDR-8000/i/s/u Instruction Book.

2.6.1 MDR–8000 Main Functions

See figure 1–1. In the transmit direction the MDR–8000 uses a modulation structure where the I and Q baseband signals modulate the in–phase and quadrature phase components of the transmitter.

The DS1/E1 I/O interface converts the format of the incoming DS1/E1 data streams to I,Q, data, and clock. The DS1/E1 I/O interface module uses the DS1/E1 signals to generate 32 or 128 trellis code amplitude modulated (TCM) baseband signals. The transmitter processes the TCM baseband signals to generate the modulated TCM RF signal. The RF signal is then amplified and applied directly to the antenna branching or further amplified by a solid–state amplifier (optional) and applied to the antenna branching.

The DS3 I/O interface converts the format of the incoming DS3 and Wayside (WS) DS1 data streams to I, Q, data, and clock. The I/O interface module uses the DS3 signals to generate 64 Quadrature Amplitude Modulated (QAM) baseband signals. The transmitter processes the QAM baseband signals to generate the modulated QAM RF signal. The RF signal is then amplified and applied directly to the antenna branching or further amplified by a solid–state amplifier (optional) and applied to the antenna branching.

In the receive direction, the MDR–8000 uses a demodulation conversion structure. The received TCM or QAM RF signal is fed into a filter followed by a receiver module. The receiver module directly converts the RF signal to I and Q baseband signals and provides all of the acquisition loops. The receiver also provides countermeasures to dynamic path distortions. Clock and digital data are extracted from the analog channels and passed on to the I/O interface. The digital data is processed by the I/O interface module and converted to a DS1/E1 or DS3 format.

The MDR–8000 consists of I/O, transmit, receive, control and monitor, and power distribution subsystems.

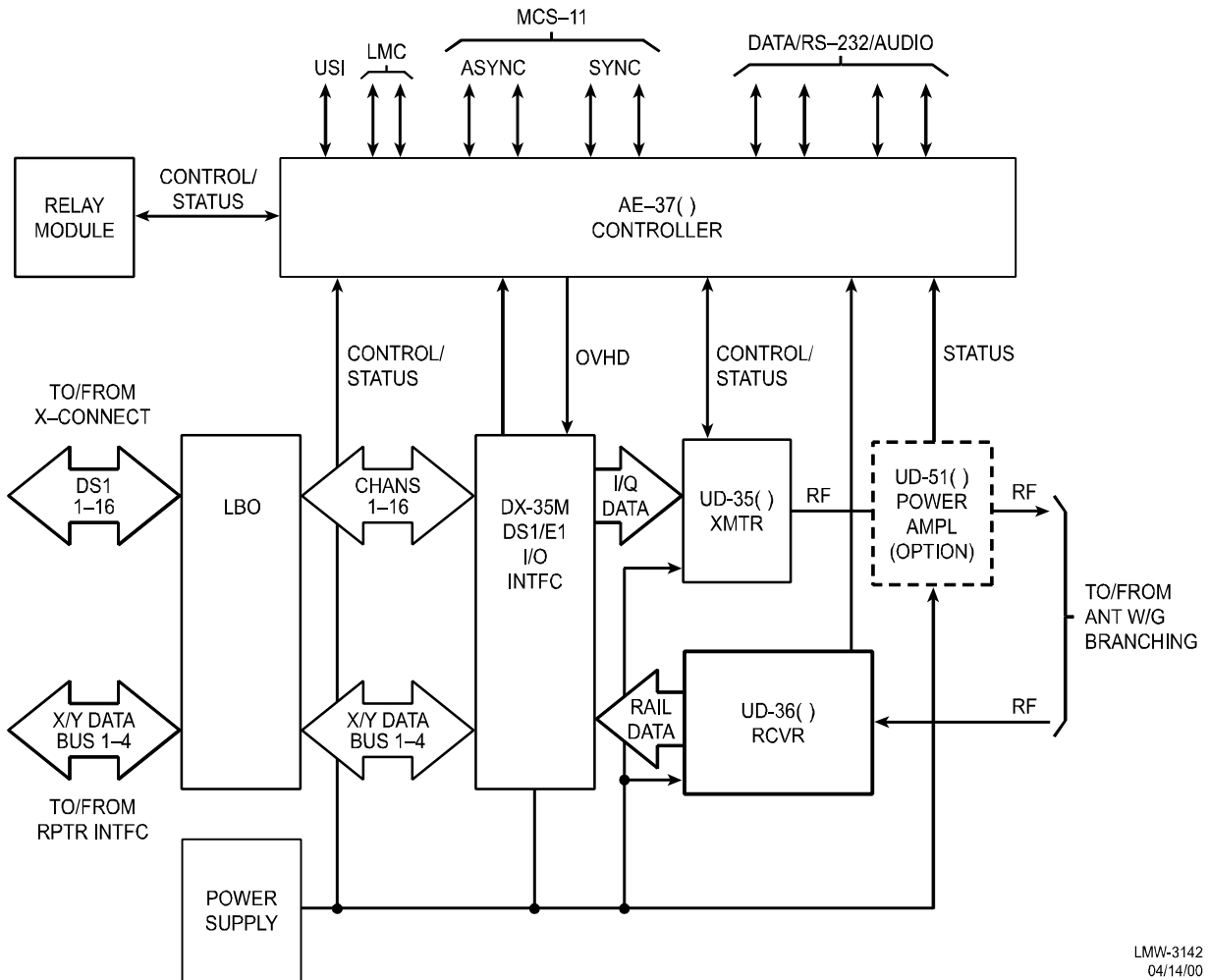

LMW-3142
04/14/00

DS1/E1 Non-Standby System Functional Block Diagram

Figure 2.6.1-DS1/E1 Non-Standby System Functional Block Diagram

3.0 Test Methodology

3.1 Test Facility

All the measurements were made in accordance with the procedures in part 2 of CFR 47 and were performed in the microwave lab of the Alcatel USA Wireless Transmission Division in Plano, Texas.

The radiated measurements were performed in the Alcatel USA Reliability Lab of the Transmission Network Division (Anna 3meter & 10meter Site), Plano, Texas.

3.2 EUT Setup

For conducted emission measurements, the equipment under test (EUT) was configured for testing as customer would normally use it:

- mounted in a 19in. wide by 7-ft. high aluminum rack
- connected to the DS1/DS3 test set
- shelf cover attached
- connected to antenna or power attenuator
- connected to a DC power supply

I/O cables were connected to the EUT and peripherals in the manner required for normal operation of the system.

During testing all cables and Rf connectors were checked for proper attachment and contact.

For radiated emission measurements, the EUT was placed on a wooden turntable in an anechoic chamber. The cables were properly attached and operational. The EUT was configured to transmit full power (30dbm).

Ambient Temperature and Humidity

The temperature during testing was within 18deg C to 30degC

The humidity was between 20% and 70%.

3.3 List of Test Equipment

ALCATEL USA, Wireless Transmission Division, Microwave Lab

Equipment	Mfg	Model #	Asset #	Serial	Cal date	Cal Due
Spectrum Analyzer	R S	FSEK	A34004	DE31261	06/09/01	06/30/02
Power Meter	HP	438A	A20834	2333A00 396	04/29/02	04/30/03
Power Head	HP	8481B	41366	1801A00 113	10/18/00	05/07/03
Freq. Counter	HP	5342A	A23537	2542A10 373	01/10/02	01/13/03
Data Test Set	Tel. Tec. Corp.	T-Bird 305	A47673	6842	05/08/02	11/30/03
Data Test Set	Tel. Tec. Corp.	T-Bird 211	A28253	7173	05/06/02	11/30/03

ALCATEL USA, Transmission Network Division, Quality Lab

Equipment	Mfg	Model #	Cal Due Date
Spectrum Analyzer	HP	HP8566B	02/29/04
Quasi-Peak Adapter	HP	HP85650A	03/31/03
RF Amplifier	Kalmus	0.003-1000Mhz	07/31/02
Rf Amplifier	1Ghz-12Ghz	Lab Built	N/A (Calibrated for every test)
Antenna	EMCO	Bi-Log Antenna 30-1200Mhz	03/31/03
Antenna	EMCO	Horn Antenna	03/31/03

4.0 Measurements Results

4.1 Maximum Conducted Output Power FCC 15.247(b)(3) and ET Docket No. 99-231

Requirements for systems using digital modulation in the 5725-5850Mhz band:

- (b) The maximum peak output power of the intentional radiator shall not exceed the following:
 - (3) for systems using digital modulation in 5725-5850Mhz band: 1Watt (30dbm).
 - (ii) Systems operating in the 5725-5850Mhz band that are used exclusively for fixed, point-to-point operations may employ transmitting antennas with directional gain greater than 6dbi without any corresponding reduction in transmit peak output power.

Test Conditions: The maximum conducted output power was checked directly on a radio configured at the highest power option (30dbm). The maximum power level was checked on two different channels at low end (5730Mhz) and high end (5845Mhz) of the unlicensed band.

The antenna port was connected directly to a power meter equipped with power head calibrated for the 5725-5850Mhz band.

Frequency Mhz	Output Power
Low End: 5730	30dbm(1Watt)
High End: 5845	30dbm(1Watt)

The lower power configurations (15 and 25dbm) will meet this requirement.

4.2 Minimum 6db RF Bandwidth, FCC Rule 15.247 (a)(2)

Requirements for systems using digital modulation in the 5725-5850Mhz band:

The minimum 6db bandwidth shall be at least 500khz

Test Conditions: The antenna port of the EUT was connected to the input of a spectrum analyzer and. The RES BW of the analyzer was set to 100khz and the spectrum analyzer center was set to the channel carrier frequency. The view button and DISPLAY line were used to catch the emission bandwidth. The measurement was performed on the worst case only which is a radio configured with the lowest capacity (2DS1, MDR-8505u-2).

This radio configuration has the narrowest RF spectrum and therefore the other radio configurations - 4DS1(MDR-8505u-4), 8DS1(MDR-8505u-8), 16DS1 (MDR-8505u-16) and 1DS3(MDR-8605u-45)- will comply with FCC 15.247(a)(2).

Radio Config.	Capac./Modul.	6db Bandwidth	Notes
MDR-8505u-2	2DS1/32TCM	835.42Khz	

The measurement is shown on plot 4.2.1



Ref Lvl 0 dBm
Marker 1 [T1] -18.13 dBm
5.72957094 GHz
RBW 100 kHz
RF Att 10 dB
VBW 100 kHz
Mixer -40 dBm
SWT 300 ms
Unit dBm

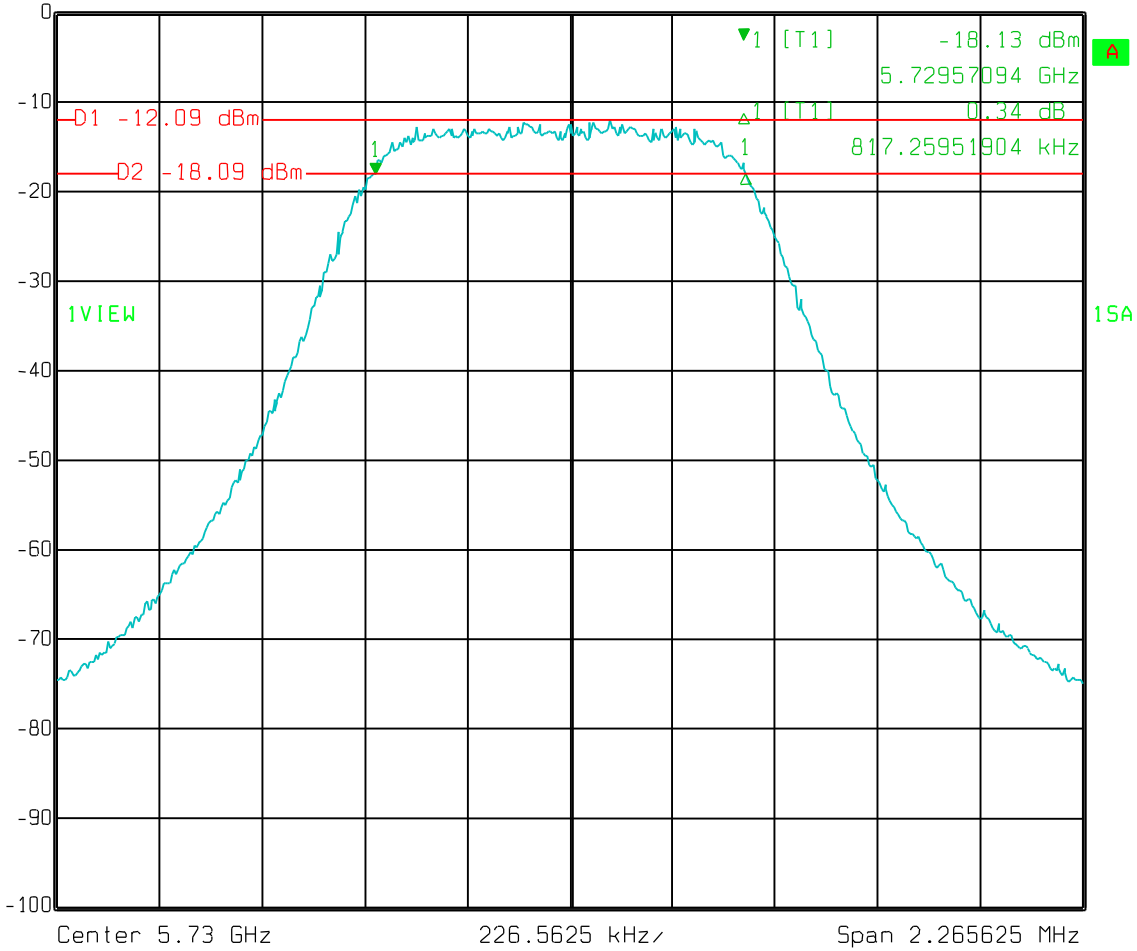

Title: MINIMUM 6db RF BANDWIDTH, 2DS1/32TCM UNII-BAND
Comment A: 5820 MHZ., 19.86 DB ATTENUATION
Date: 12.JUN.2002 13:02:14

Plot 4.2.1

4.3 Peak Power Spectral Density (PPSD) FCC15.247(d)

Requirements for systems using digital modulation in the 5725-5850Mhz band:

(d) For digitally modulated systems, the peak power spectral density conducted from the intentional radiator to the antenna shall not be greater than 8dbm in any 3khz band during any interval of continuous transmission.

Test Conditions: The antenna port of the EUT was connected to the input of a spectrum analyzer through an attenuator and:

- the START and STOP frequencies were set to the band edges of the maximum output passband
- RBW=3khz , VBW=100khz
- It was recorded the highest level found in any 3khz band (after 100 sweeps of video averaging)

The measurements were done for the all the capacity configurations using the maximum available power: 30dbm(1Watt)

All the radio configurations have the spectral density lower than 8dbm. The following table summarizes the data for each configuration.

Radio Config.	Capac./Modul.	Transmit Output power, dbm	Measured PPSD, dbm	Plot #
MDR-8505u-2	2DS1/32TCM	30	5.04	4.3.1
MDR-8505u-4	4DS1/32TCM	30	2.92	4.3.2
MDR-8505u-8	8DS1/32TCM	30	0.11	4.3.3
MDR-8505u-16	16DS1/32TCM	30	-3.07	4.3.4
MDR-8605u-45	1DS3/64QAM	30	-4.44	4.3.5

Model: MDR-8505u-2 (Capacity: 2DS1, Modulation: 32TCM)

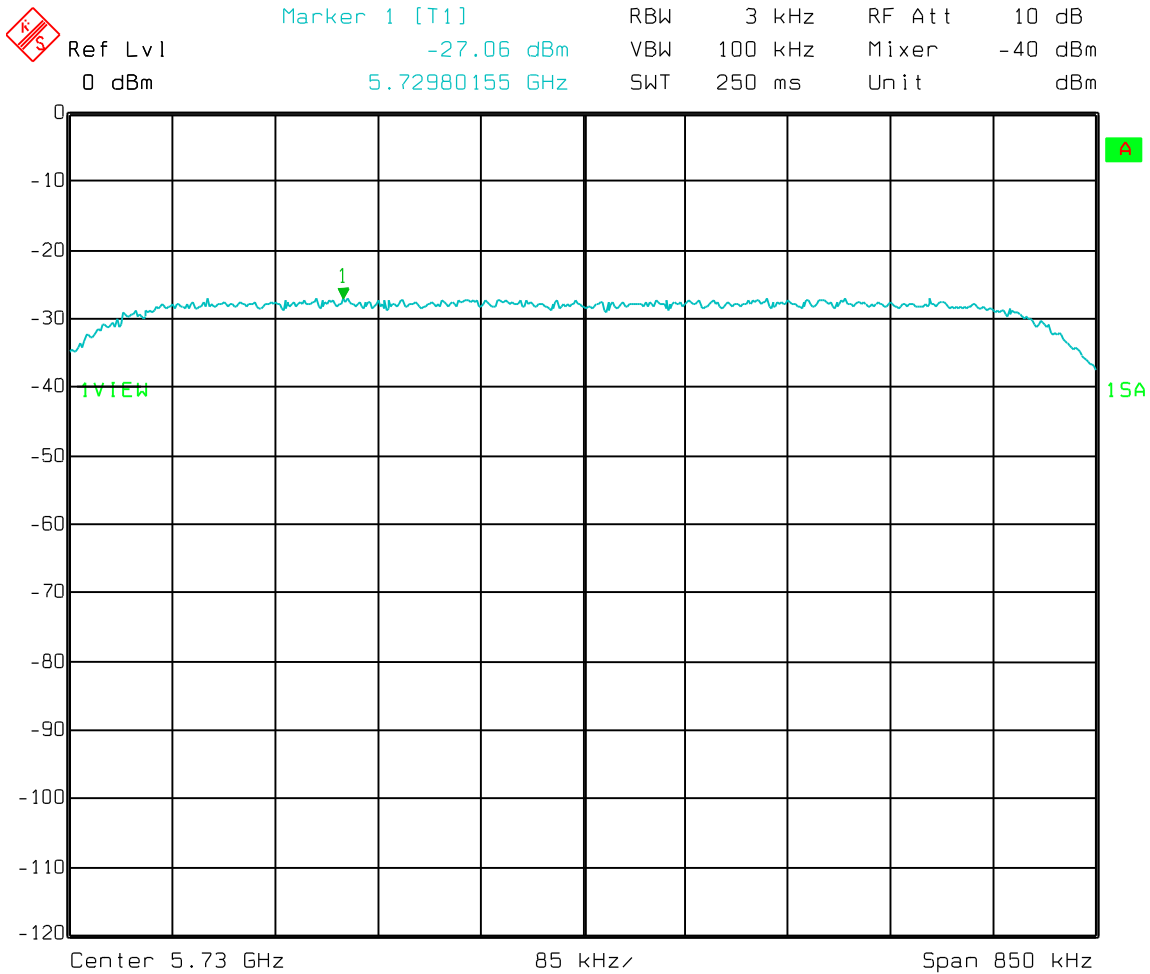

Title: PPSD2DS1/32TCM,30DBM
 Comment A: 5730 MHZ, 32.1 DB ATTENUATION
 Date: 24.JUN.2002 8:19:36

Plot 4.3.1

The attenuation used in front of the Spectrum Analyzer was 32.1db and therefore:

PPSD= 32.1-27.06= 5.04 dbm

Model: MDR-8505u-4 (Capacity: 4DS1, Modulation: 32TCM)

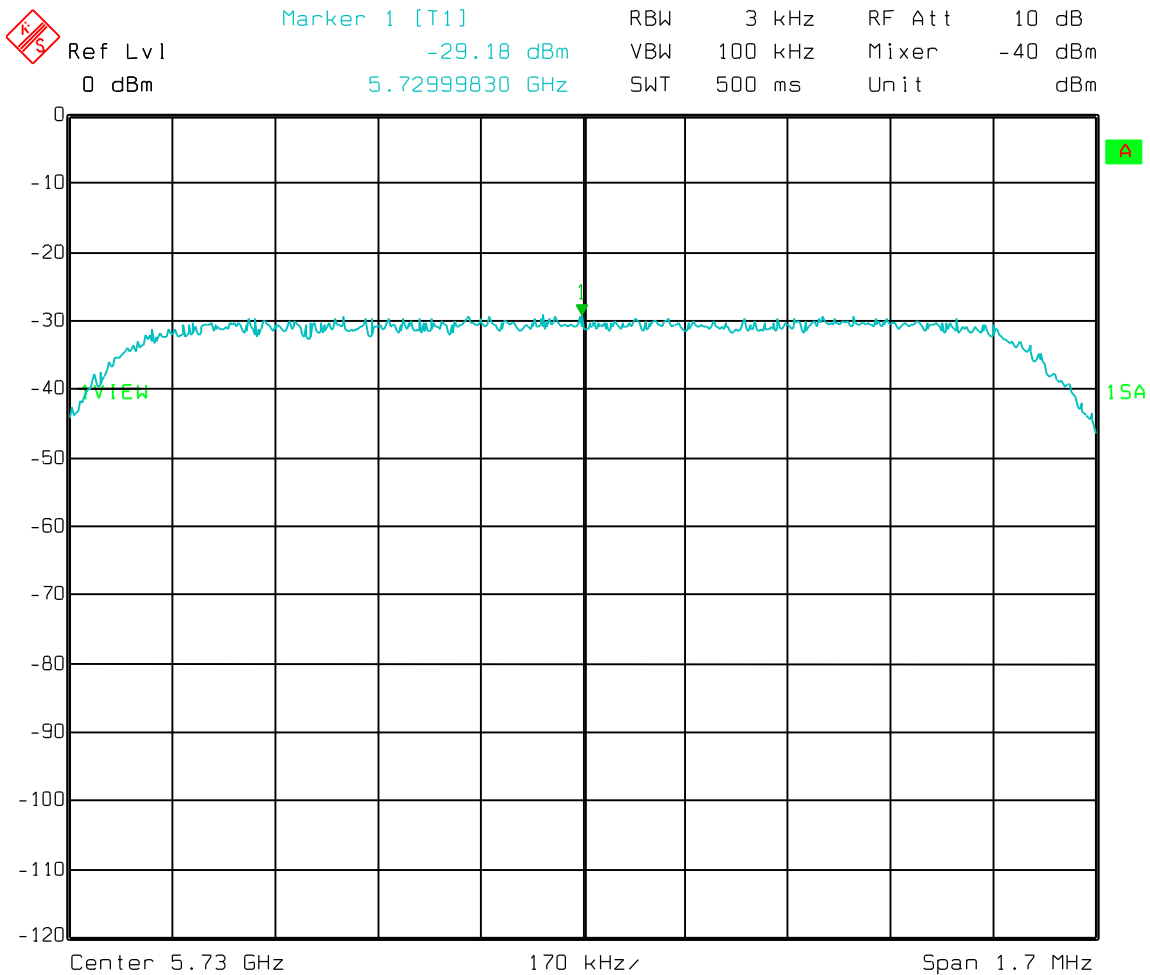

Title: PPSD4DS1/32TCM,30DBM
 Comment A: 5730 MHZ, 32.1 DB ATTENUATION
 Date: 24.JUN.2002 8:24:59

Plot 4.3.2

The attenuation used in front of the Spectrum Analyzer was 32.1dband therefore:

PPSD= 32.1-29.18= 2.92dbm

Model: MDR-8505u-8 (Capacity:8DS1, Modulation: 32TCM)

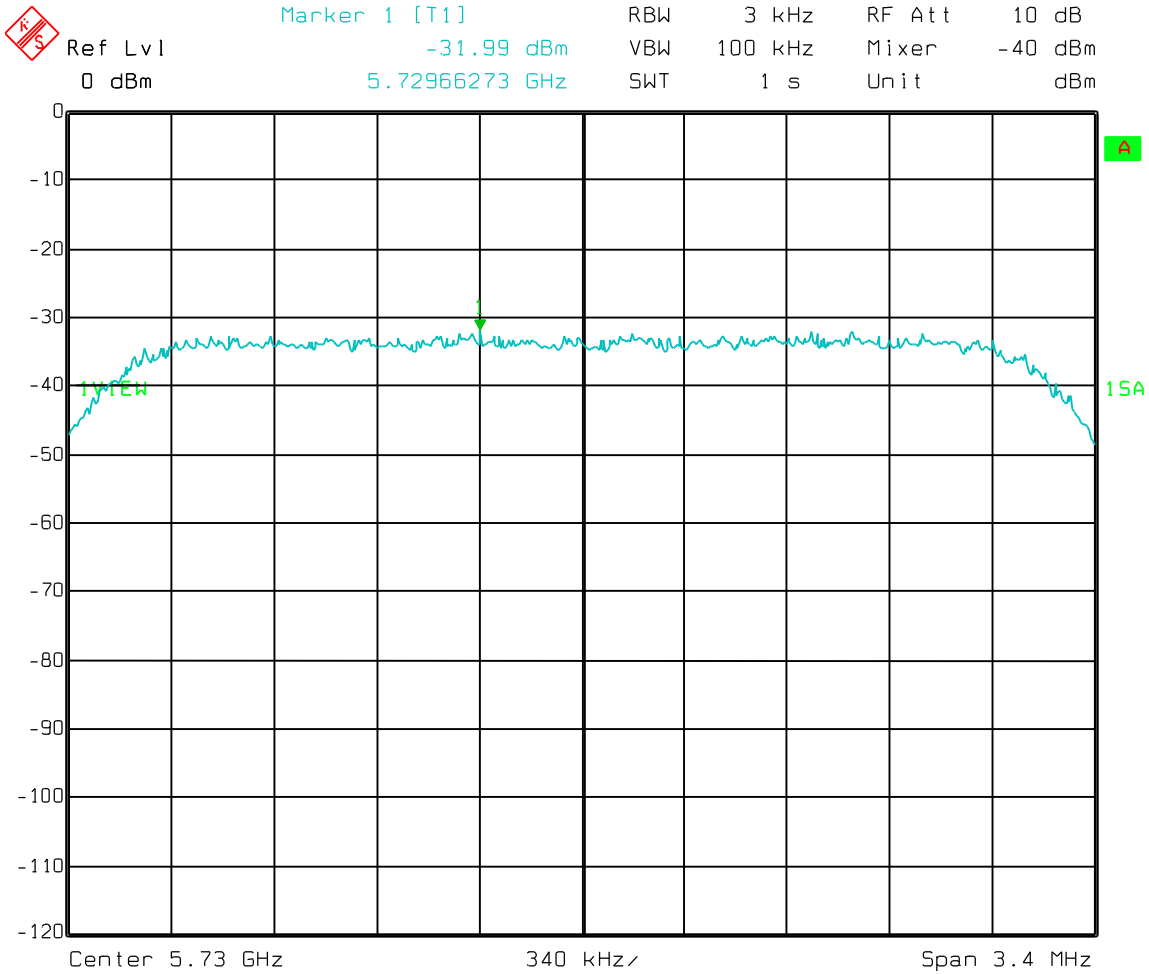

Title: PPSD8DS1/32TCM,30DBM
 Comment A: 5730 MHZ, 32.1 DB ATTENUATION
 Date: 24.JUN.2002 8:34:30

Plot 4.3.3

The attenuation used in front of the Spectrum Analyzer was 32.1db and therefore:

$$\text{PPSD} = 32.1 - 31.99 = 0.11 \text{ dbm}$$

Model: MDR-8505u-16 (Capacity:16DS1, Modulation: 32TCM)

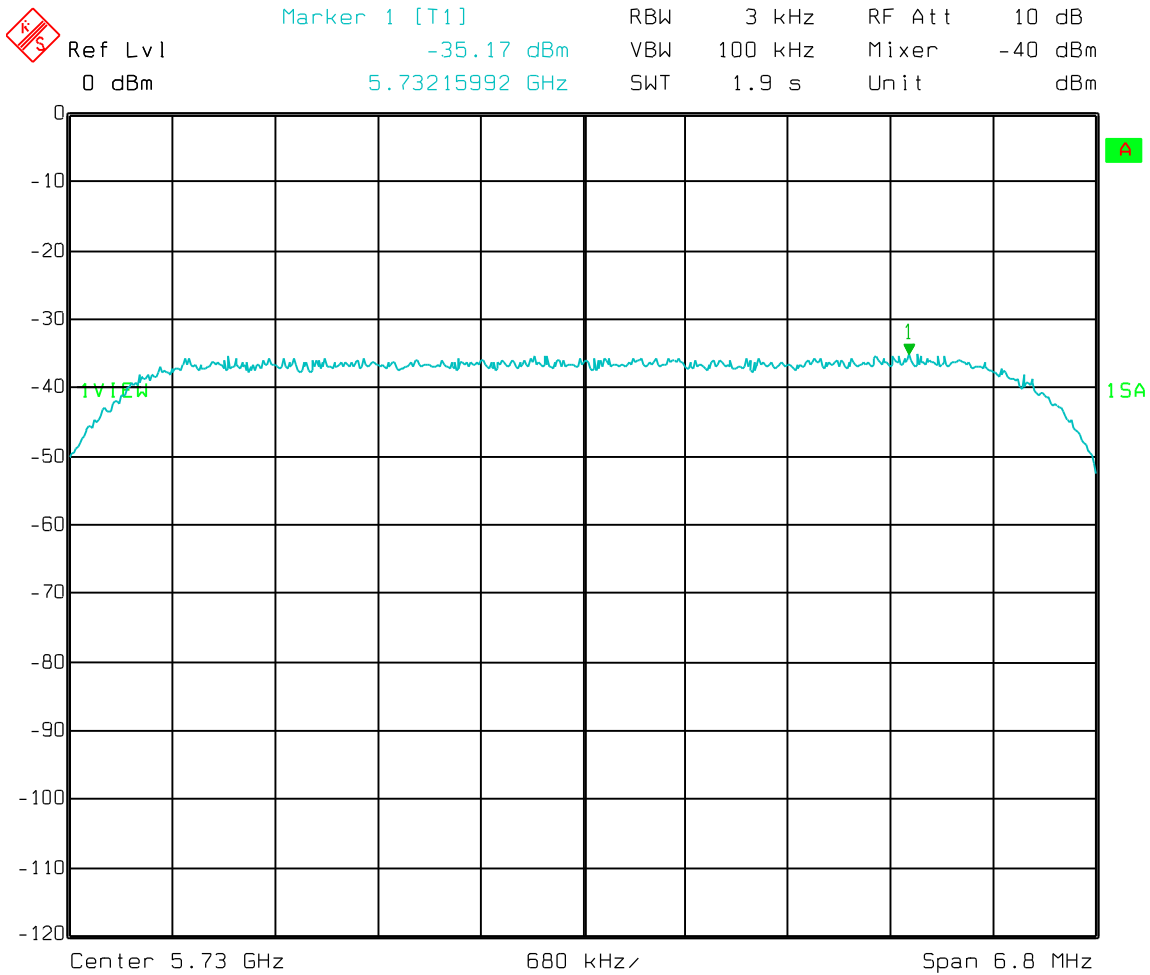

Title: PPSD16DS1/32TCM,30DBM
 Comment A: 5730 MHZ, 32.1 DB ATTENUATION
 Date: 24.JUN.2002 8:45:39

Plot 4.3.4

The attenuation used in front of the Spectrum Analyzer was 32.1db and therefore:

PPSD= 32.1-35.17= -3.07dbm

Model: MDR-8605u-45 (Capacity:1DS3, Modulation: 64QAM)

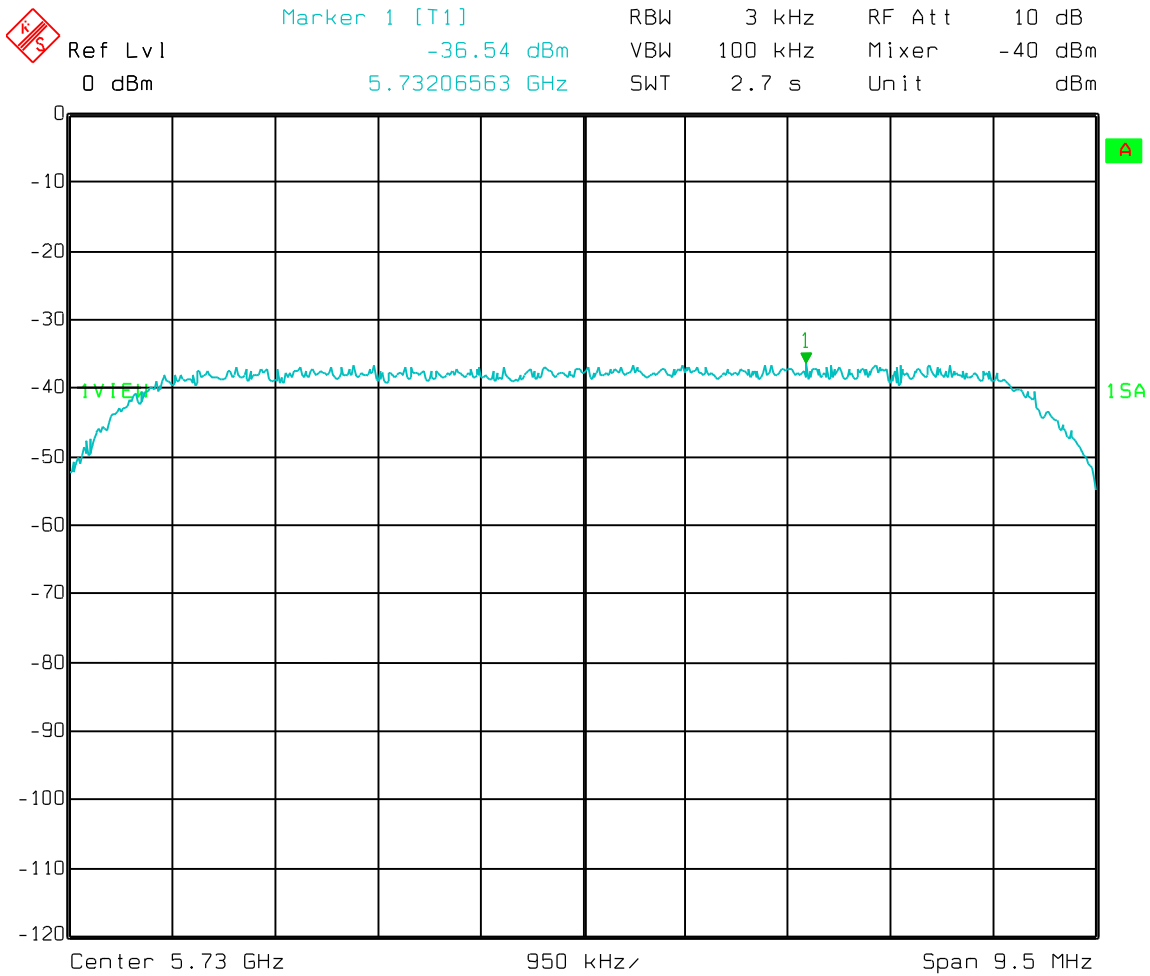

Title: PPSD1DS3/64QAM,30DBM
 Comment A: 5730 MHZ, 32.1 DB ATTENUATION
 Date: 26.JUN.2002 10:13:57

Plot 4.3.5

The attenuation used in front of the Spectrum Analyzer was 32.1db and therefore:

PPSD= 32.1-36.54=- 4.44dbm

4.4 Out of Band Conducted Emissions FCC 15.247(c)

Requirements for systems using digital modulation in the 5725-5850Mhz band:

(c) In any 100kHz bandwidth outside the frequency band in which the spread spectrum or digitally modulated intentional radiator is operating, the radio frequency power than is produced by the intentional radiator shall be at least 20db below that in the 100kHz bandwidth within the band that contains the highest level of the desired power, based on either an RF conducted or a radiated measurement.

Test Conditions: The antenna port of the EUT was connected to the input of a spectrum analyzer and measurements were made between 1Mhz and 40Ghz on radios configured from the lowest to the highest capacity (2DS1 to 1DS3 respectively), maximum output power (1Watt).

The results are shown in the following plots:

MDR-8505u-2	Plots 4.4.1.1 to 4.4.1.6
MDR-8505u-4	Plots 4.4.2.1 to 4.4.2.6
MDR-8505u-8	Plots 4.4.3.1 to 4.4.3.6
MDR-8505u-16	Plots 4.4.4.1 to 4.4.4.6
MDR-8605u-45	Plots 4.4.5.1 to 4.4.5.6

For all radio configurations there is no other emission beside the transmitted signal.

4.4.1 Model: MDR-8505u-2 (Capacity: 2DS1, Modulation: 32TCM)

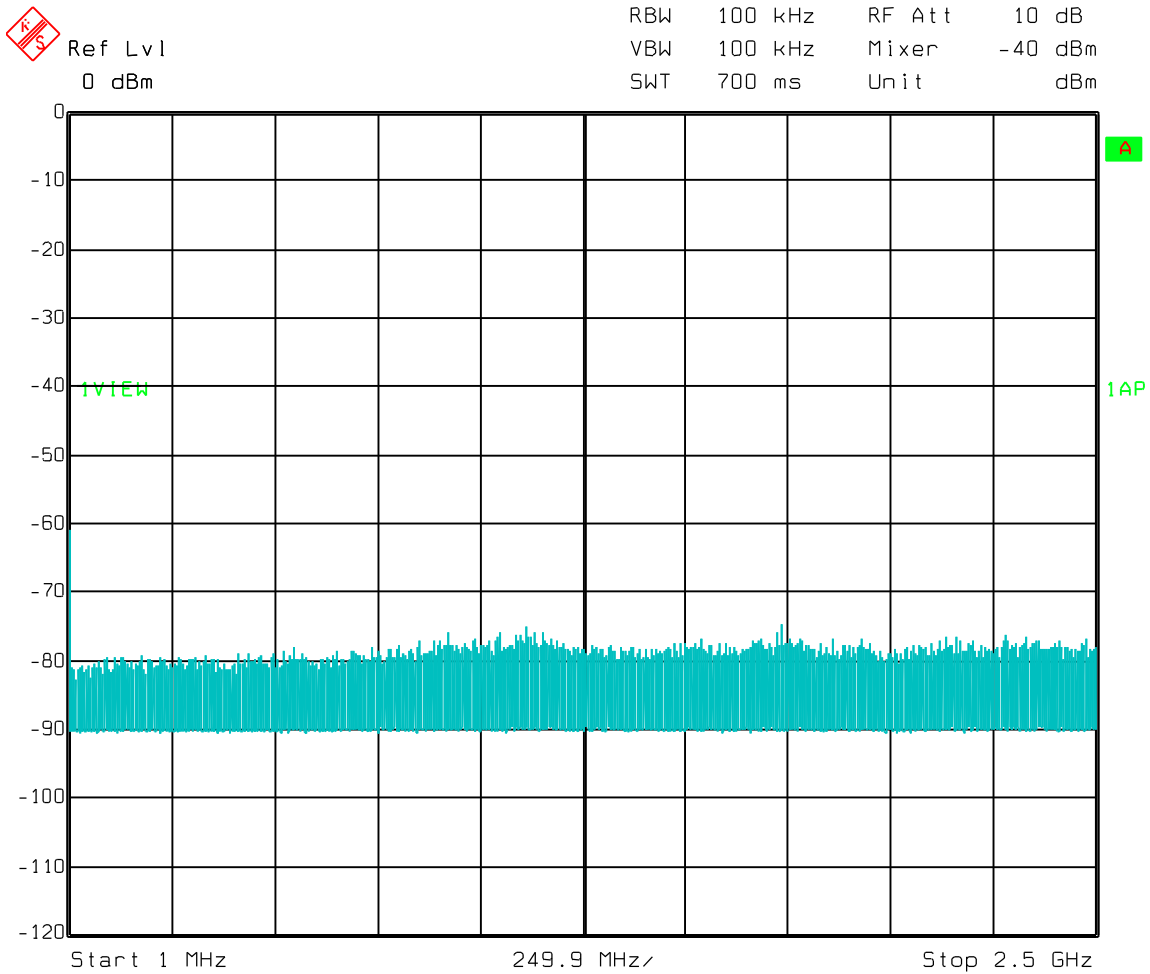

Title: 2DS1/32TCM,30DBM_OUT OF BAND EMISSIONS
 Comment A: 5730 MHZ
 Date: 24.JUN.2002 12:50:01

Plot 4.4.1.1



Ref Lvl
0 dBm

RBW	100 kHz	RF Att	10 dB
VBW	100 kHz	Mixer	-40 dBm
SWT	760 ms	Unit	dBm

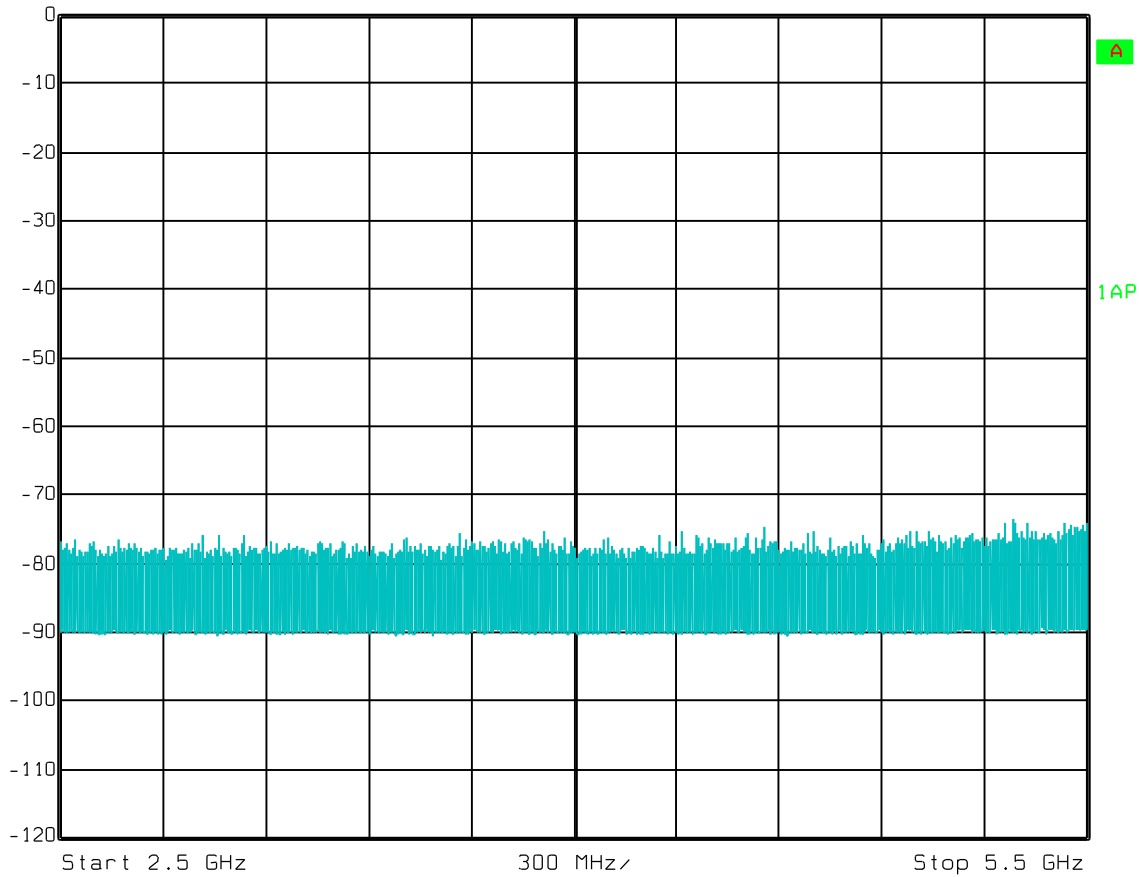

Title: 2DS1/32TCM,30DBM_OUT OF BAND EMISSIONS
Comment A: 5730 MHZ
Date: 24.JUN.2002 12:52:19

Plot 4.4.1.2



Ref Lvl
0 dBm

RBW	100 kHz	RF Att	10 dB
VBW	100 kHz	Mixer	-40 dBm
SWT	760 ms	Unit	dBm

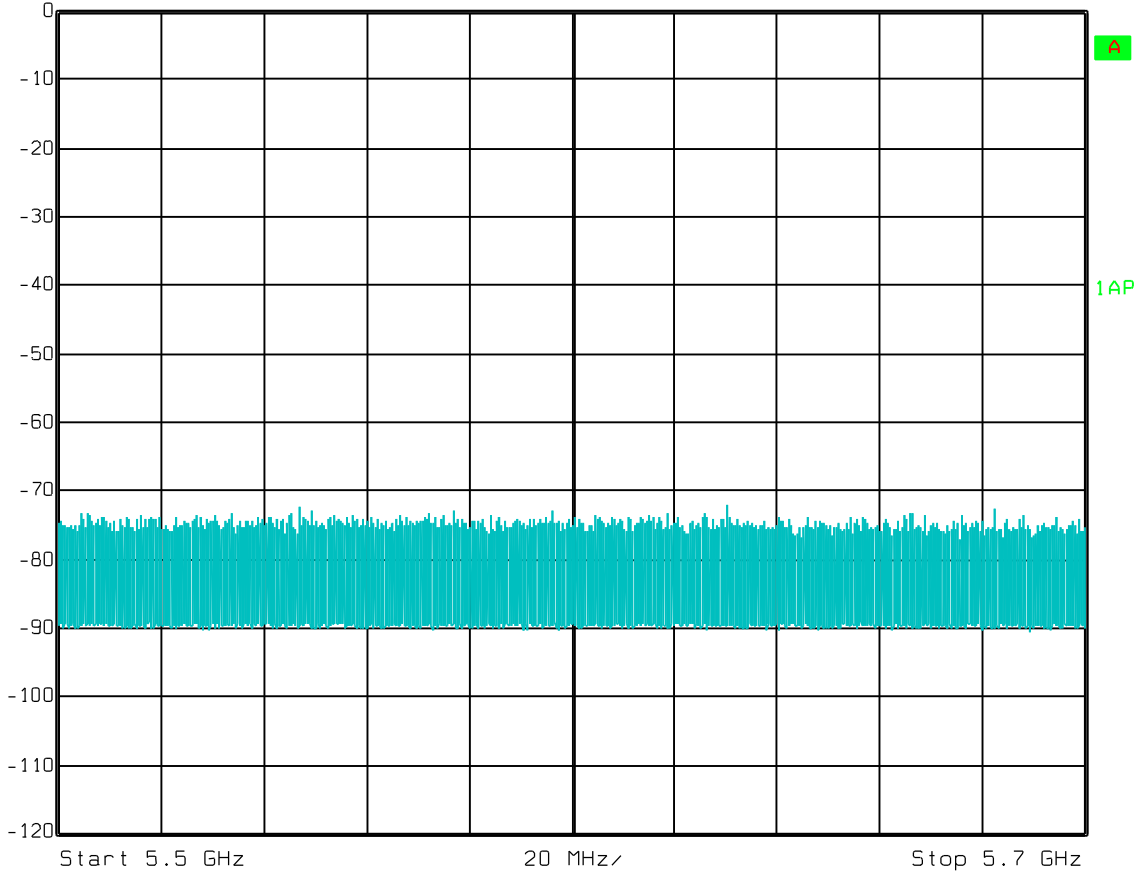

Title: 2DS1/32TCM,30DBM_OUT OF BAND EMISSIONS
Comment A: 5730 MHZ
Date: 24.JUN.2002 12:53:39

Plot 4.4.1.3



Ref Lvl
0 dBm

RBW	100 kHz	RF Att	10 dB
VBW	100 kHz	Mixer	-40 dBm
SWT	760 ms	Unit	dBm

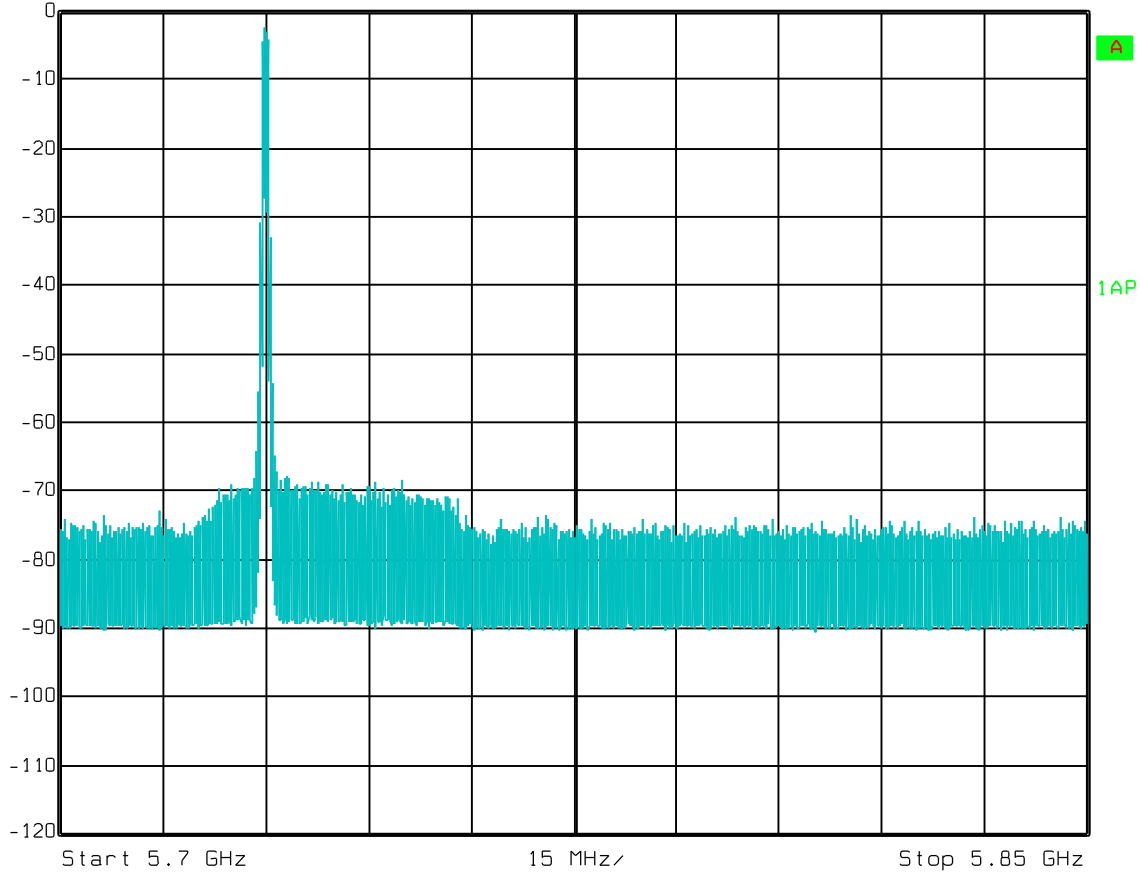

Title: 2DS1/32TCM,30DBM_OUT OF BAND EMISSIONS
Comment A: 5730 MHz
Date: 24.JUN.2002 12:55:03

Plot 4.4.1.4

Note: This plot shows the transmit signal at 5730Mhz



Ref Lvl
0 dBm

RBW	100 kHz	RF Att	10 dB
VBW	100 kHz	Mixer	-40 dBm
SWT	5.2 s	Unit	dBm

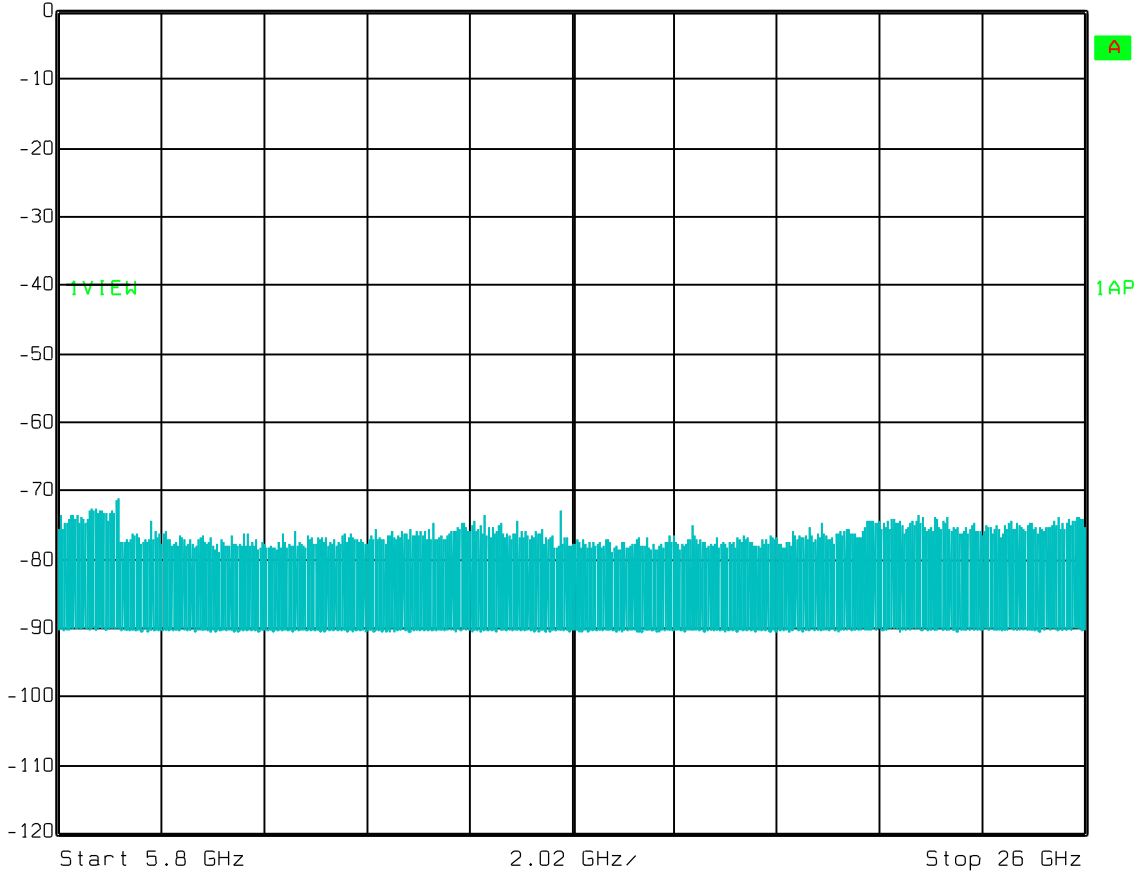

Title: 2DS1/32TCM,30DBM_OUT OF BAND EMISSIONS
Comment A: 5730 MHZ
Date: 24.JUN.2002 12:58:58

Plot 4.4.1.5



Ref Lvl
0 dBm

RBW	100 kHz	RF Att	10 dB
VBW	100 kHz	Mixer	-40 dBm
SWT	5.2 s	Unit	dBm

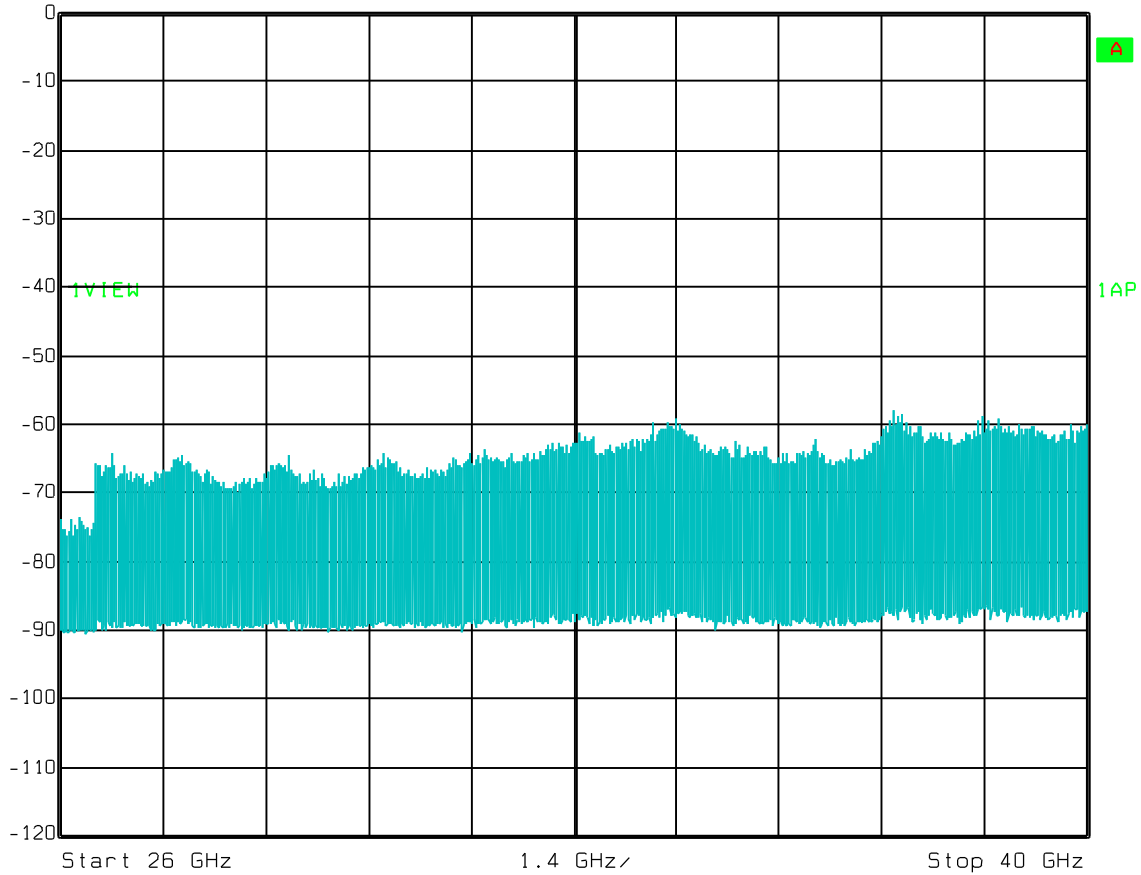

Title: 2DS1/32TCM,30DBM_OUT OF BAND EMISSIONS
Comment A: 5730 MHZ
Date: 24.JUN.2002 13:00:42

Plot 4.4.1.6

4.4.2 Model: MDR-8505u-4 (Capacity: 4DS1, Modulation: 32TCM)

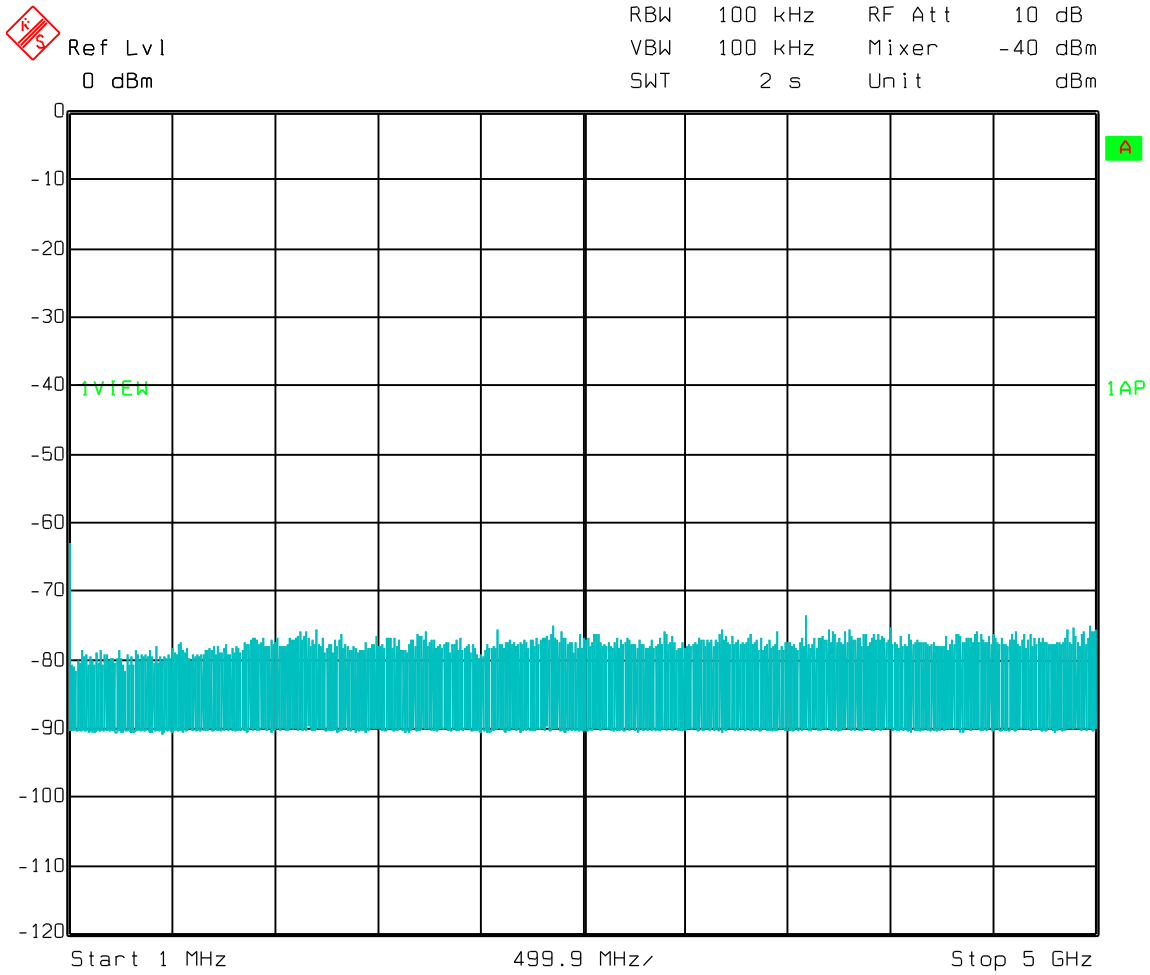

Title: 4DS1/32TCM,30DBM_OUT OF BAND EMISSIONS
Comment A: 5730 MHZ
Date: 25.JUN.2002 8:17:43

Plot 4.4.2.1



Ref Lvl
0 dBm

RBW 100 kHz RF Att 10 dB
VBW 100 kHz Mixer -40 dBm
SWT 2 s Unit dBm

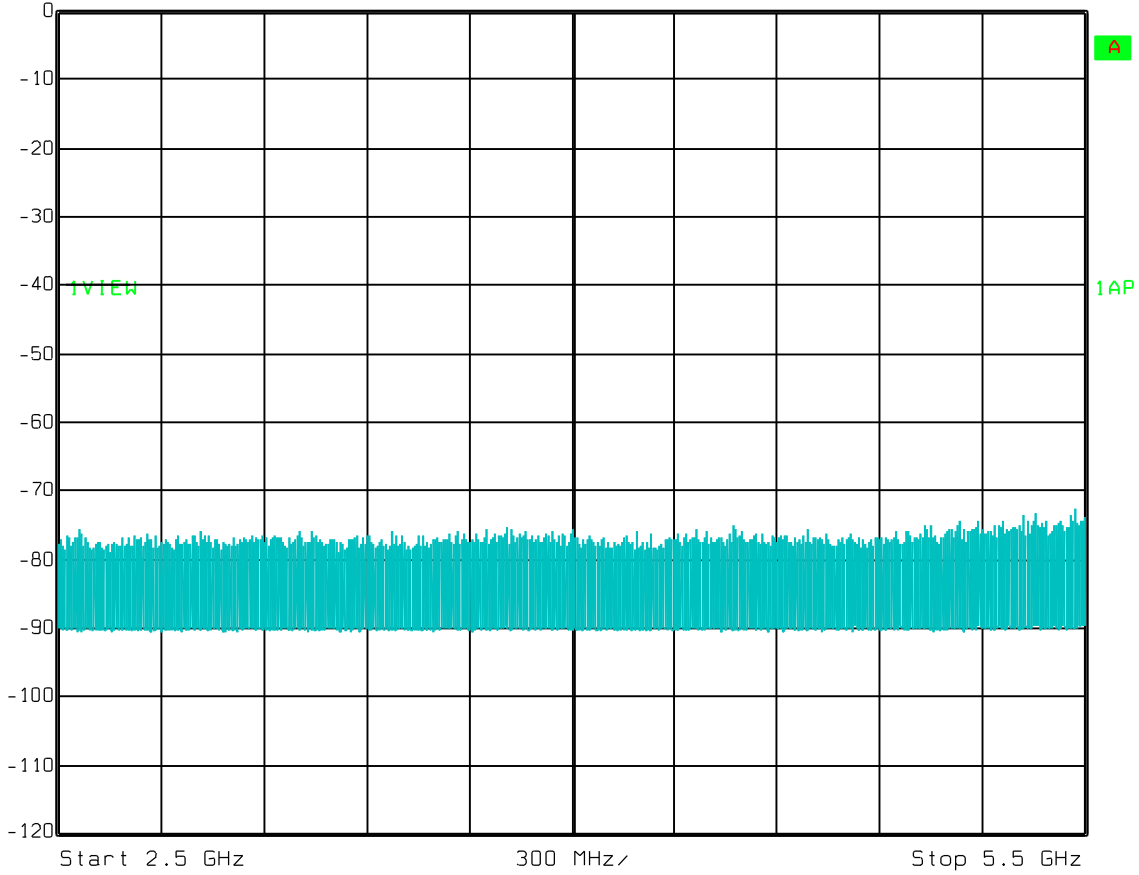

Title: 4DS1/32TCM,30DBM_OUT OF BAND EMISSIONS
Comment A: 5730 MHZ
Date: 25.JUN.2002 8:19:38

Plot 4.4.2.2



Ref Lvl
0 dBm

RBW	100 kHz	RF Att	10 dB
VBW	100 kHz	Mixer	-40 dBm
SWT	2 s	Unit	dBm

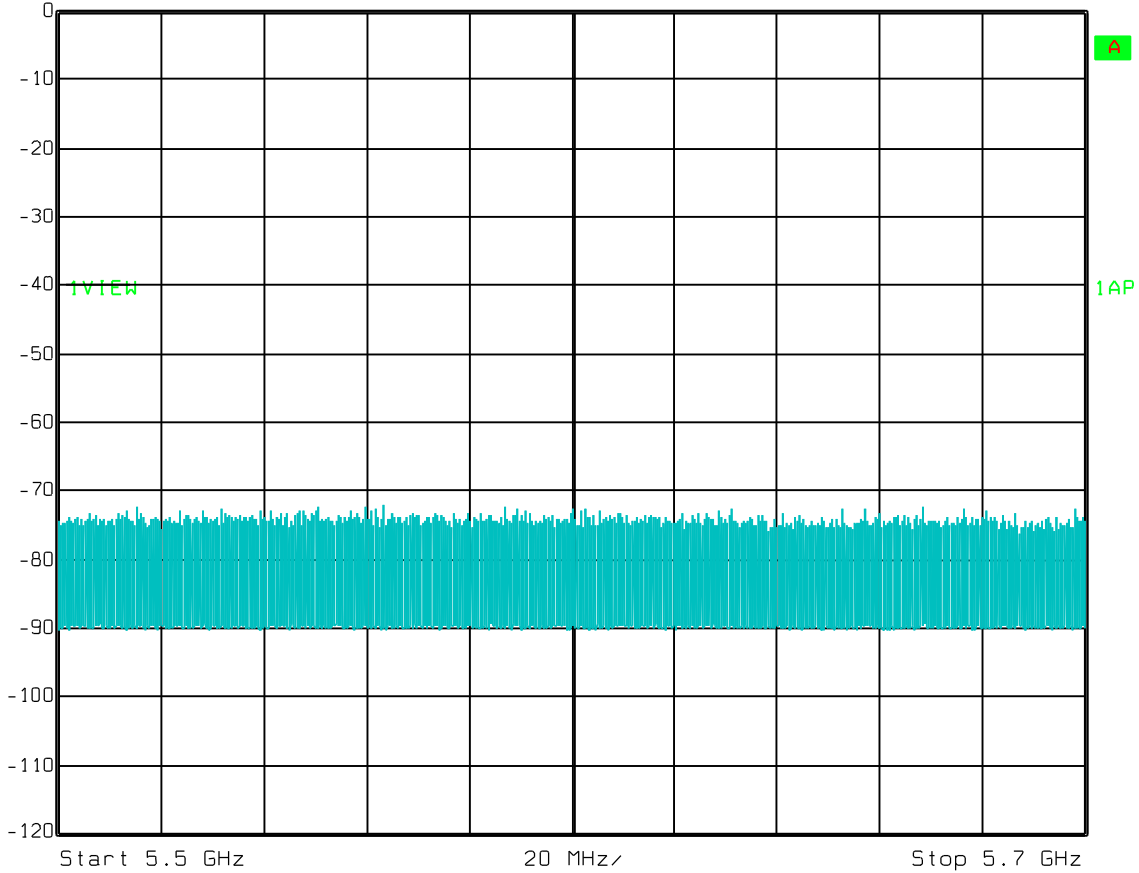

Title: 4DS1/32TCM,30DBM_OUT OF BAND EMISSIONS
Comment A: 5730 MHZ
Date: 25.JUN.2002 8:23:16

Plot 4.4.2.3



Ref Lvl
0 dBm

RBW 100 kHz RF Att 10 dB
VBW 100 kHz Mixer -40 dBm
SWT 2 s Unit dBm

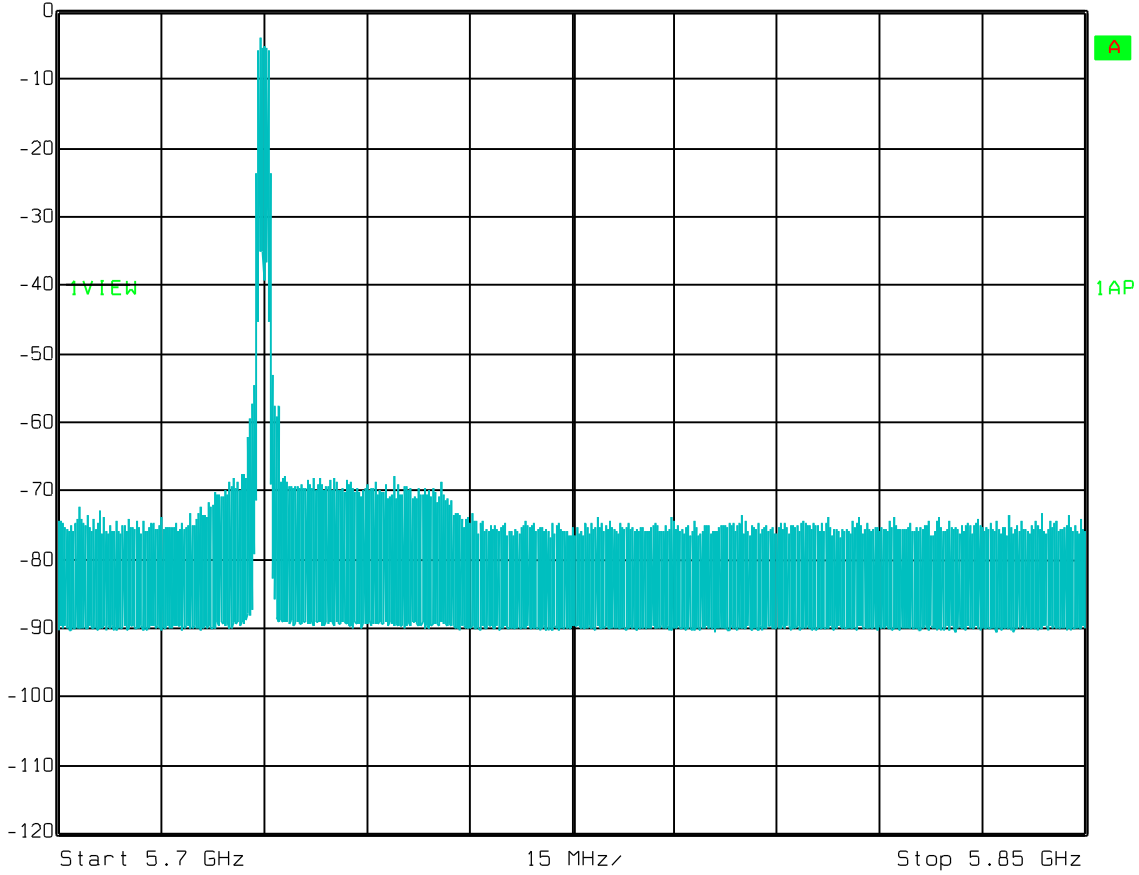

Title: 4DS1/32TCM,30DBM_OUT OF BAND EMISSIONS
Comment A: 5730 MHz
Date: 25.JUN.2002 8:24:58

Plot 4.4.2.4

Note: This plot shows the transmit signal at 5730MHz



Ref Lvl
0 dBm

RBW	100 kHz	RF Att	10 dB
VBW	100 kHz	Mixer	-40 dBm
SWT	5.6 s	Unit	dBm

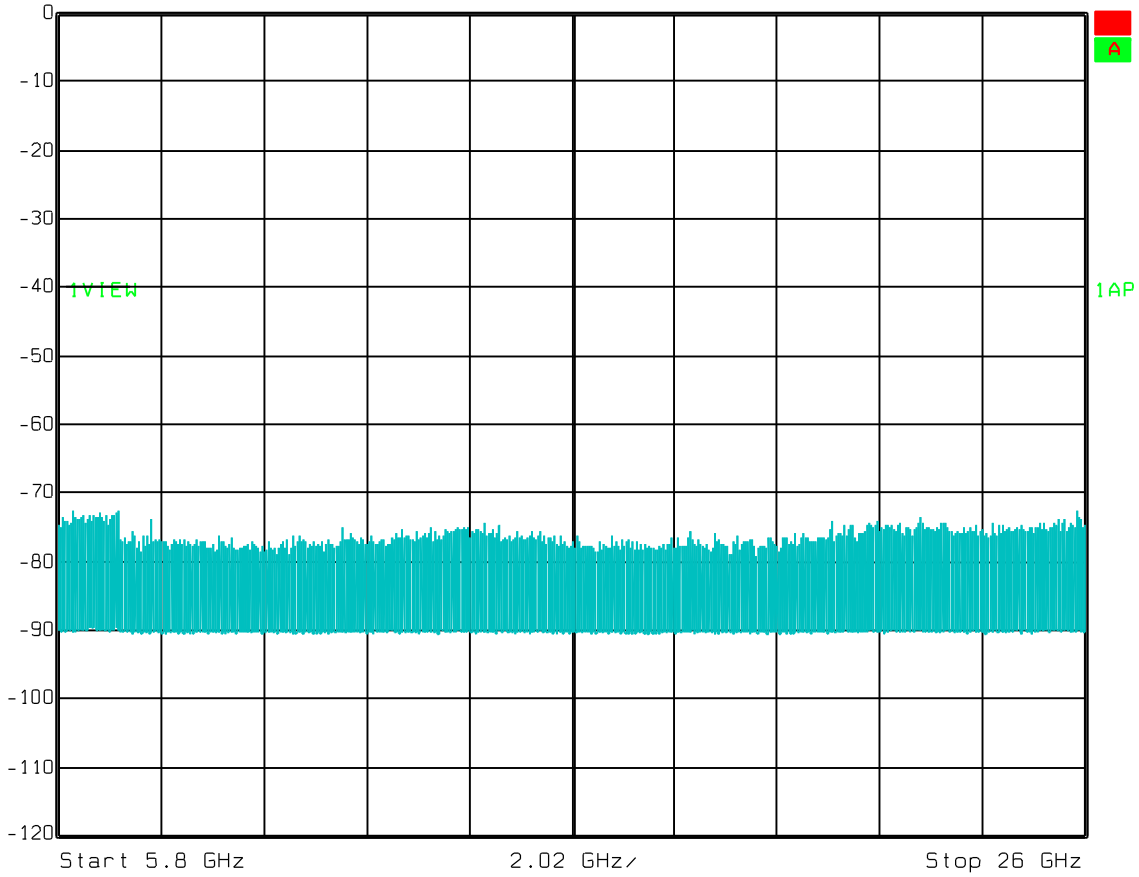

Title: 4DS1/32TCM,30DBM_OUT OF BAND EMISSIONS
Comment A: 5730 MHZ
Date: 25.JUN.2002 8:29:50

Plot 4.4.2.5

4.4.3 Model: MDR-8505u-8 (Capacity: 8DS1, Modulation: 32TCM)

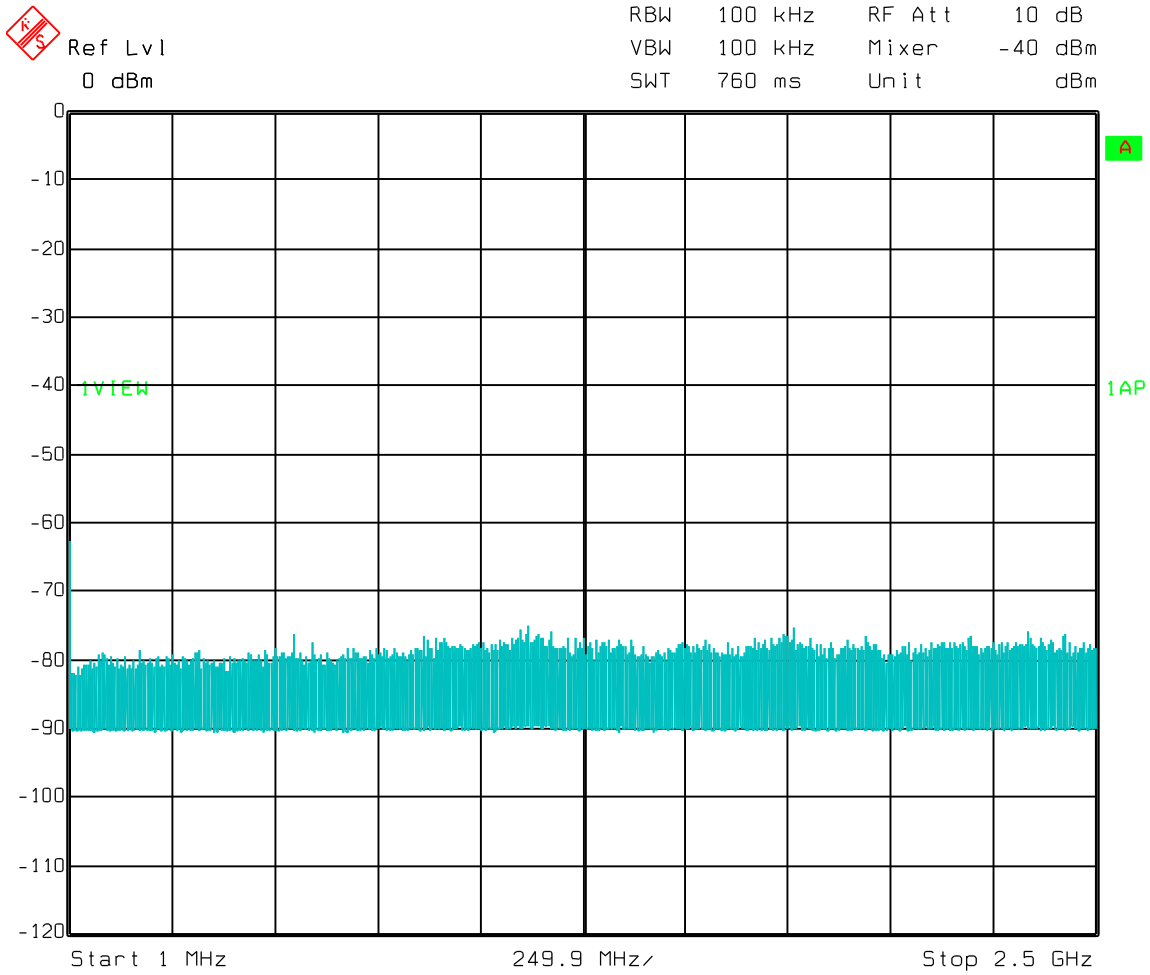

Title: 8DS1/32TCM,30DBM_OUT OF BAND EMISSIONS
Comment A: 5730 MHZ
Date: 25.JUN.2002 9:16:24

Plot 4.4.3.1



Ref Lvl
0 dBm

RBW	100 kHz	RF Att	10 dB
VBW	100 kHz	Mixer	-40 dBm
SWT	760 ms	Unit	dBm

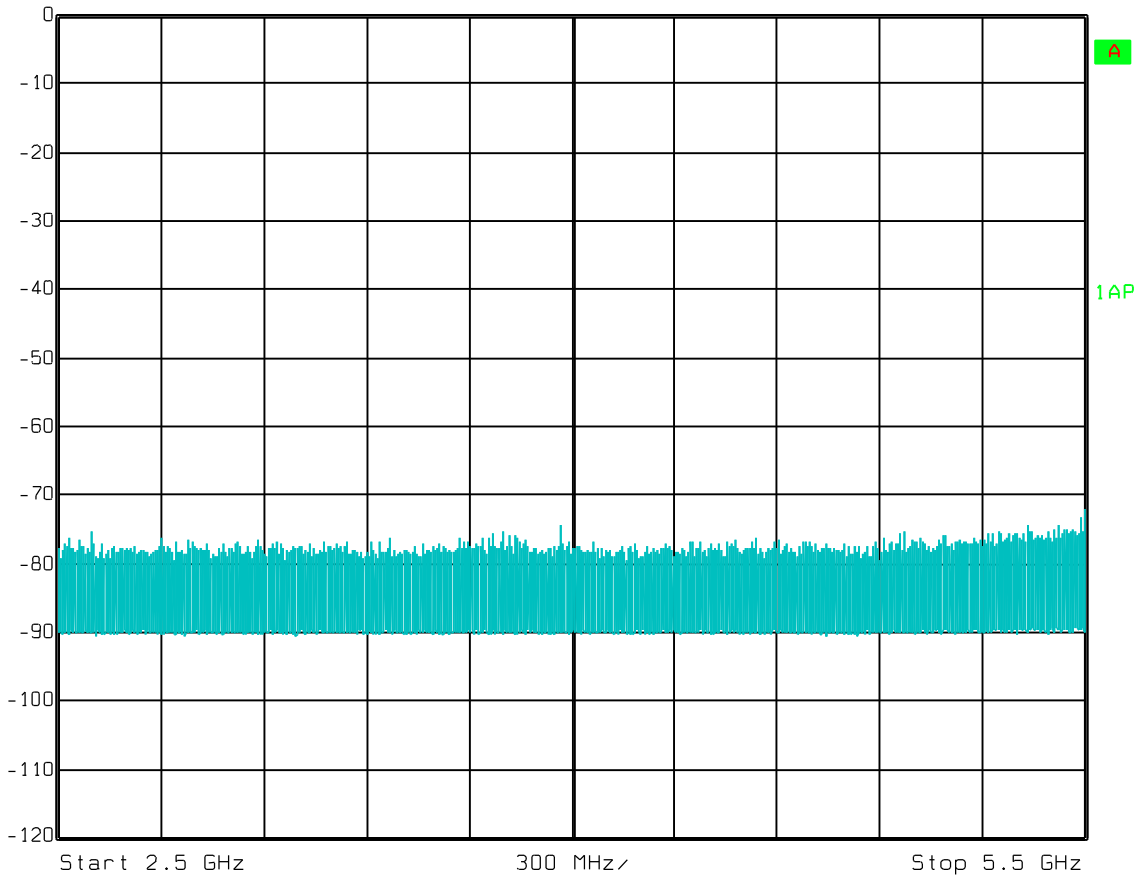

Title: BDS1/32TCM,300DBM_OUT OF BAND EMISSIONS
Comment A: 5730 MHZ
Date: 25.JUN.2002 9:17:35

Plot 4.4.3.2



Ref Lvl
0 dBm

RBW	100 kHz	RF Att	10 dB
VBW	100 kHz	Mixer	-40 dBm
SWT	760 ms	Unit	dBm

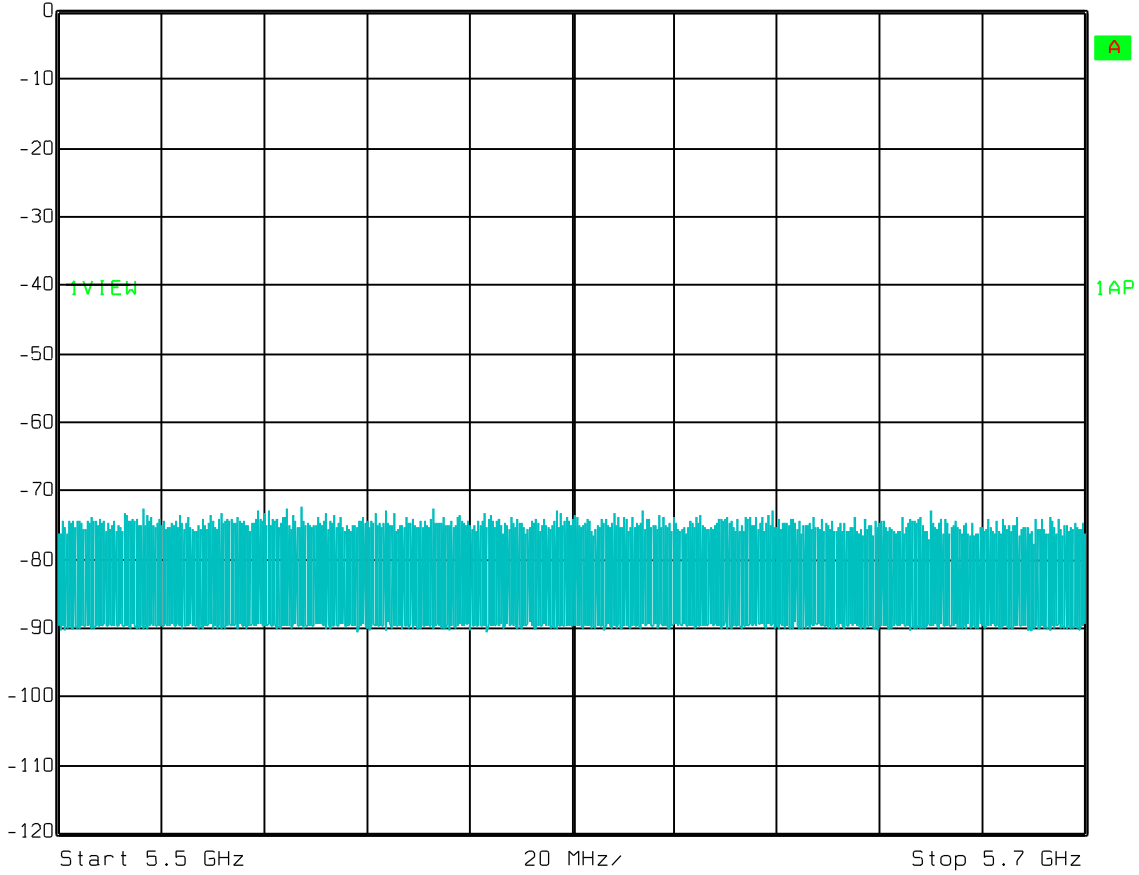

Title: BDS1/32TCM,30DBM_OUT OF BAND EMISSIONS
Comment A: 5730 MHZ
Date: 25.JUN.2002 9:19:33

Plot 4.4.3.3



Ref Lvl
0 dBm

RBW	100 kHz	RF Att	10 dB
VBW	100 kHz	Mixer	-40 dBm
SWT	760 ms	Unit	dBm

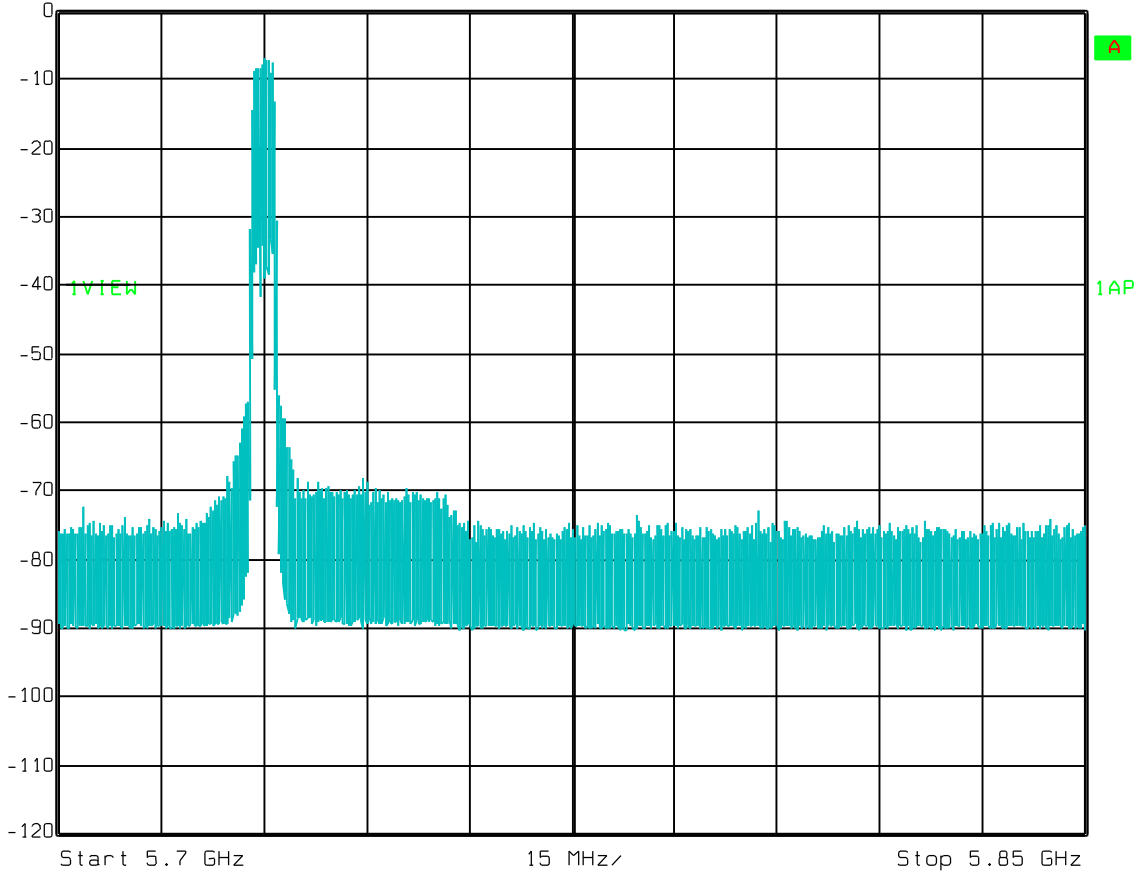

Title: BDS1/32TCM,30DBM_OUT OF BAND EMISSIONS
Comment A: 5730 MHZ
Date: 25.JUN.2002 9:20:39

Plot 4.4.3.4

Note: This plot shows the transmit signal at 5730Mhz



Ref Lvl
0 dBm

RBW	100 kHz	RF Att	10 dB
VBW	100 kHz	Mixer	-40 dBm
SWT	5.6 s	Unit	dBm

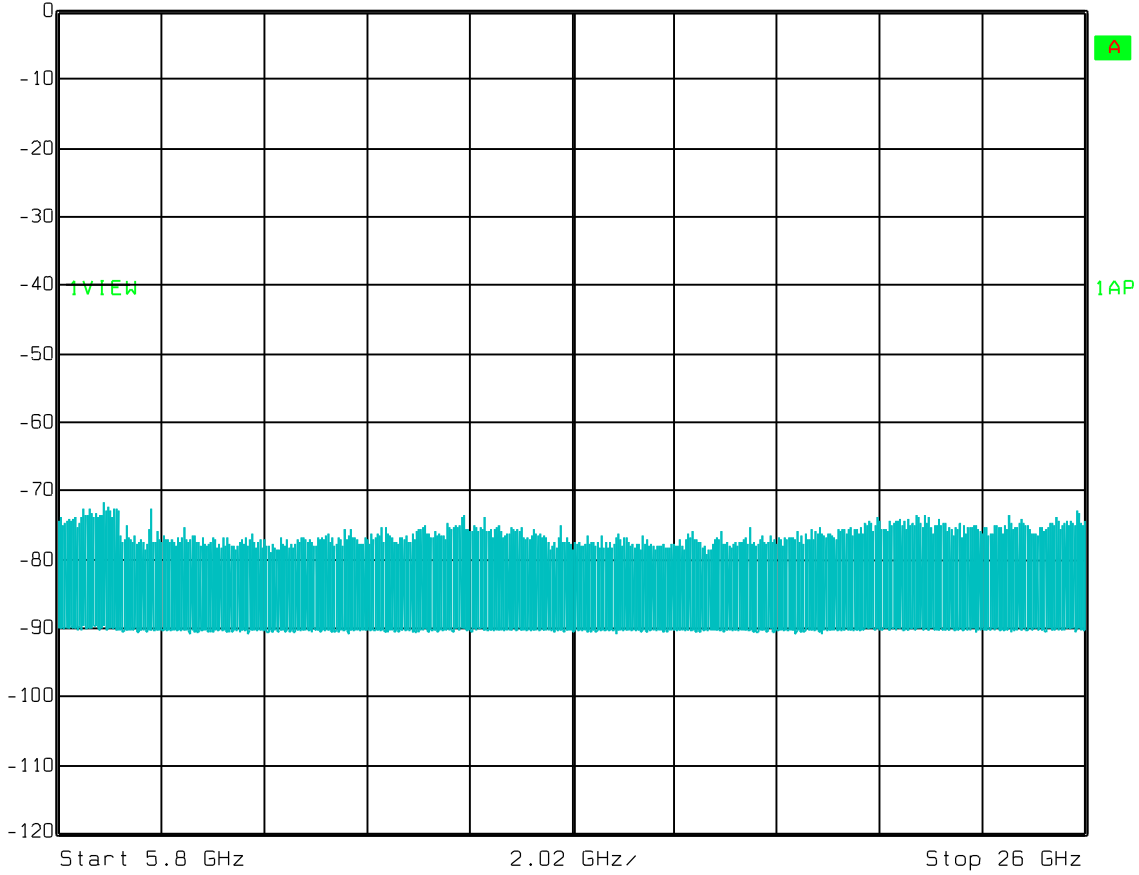

Title: BDS1/32TCM,30DBM_OUT OF BAND EMISSIONS
Comment A: 5730 MHZ
Date: 25.JUN.2002 9:22:12

Plot 4.4.3.5



Ref Lvl
0 dBm

RBW 100 kHz RF Att 10 dB
VBW 100 kHz Mixer -40 dBm
SWT 5.6 s Unit dBm

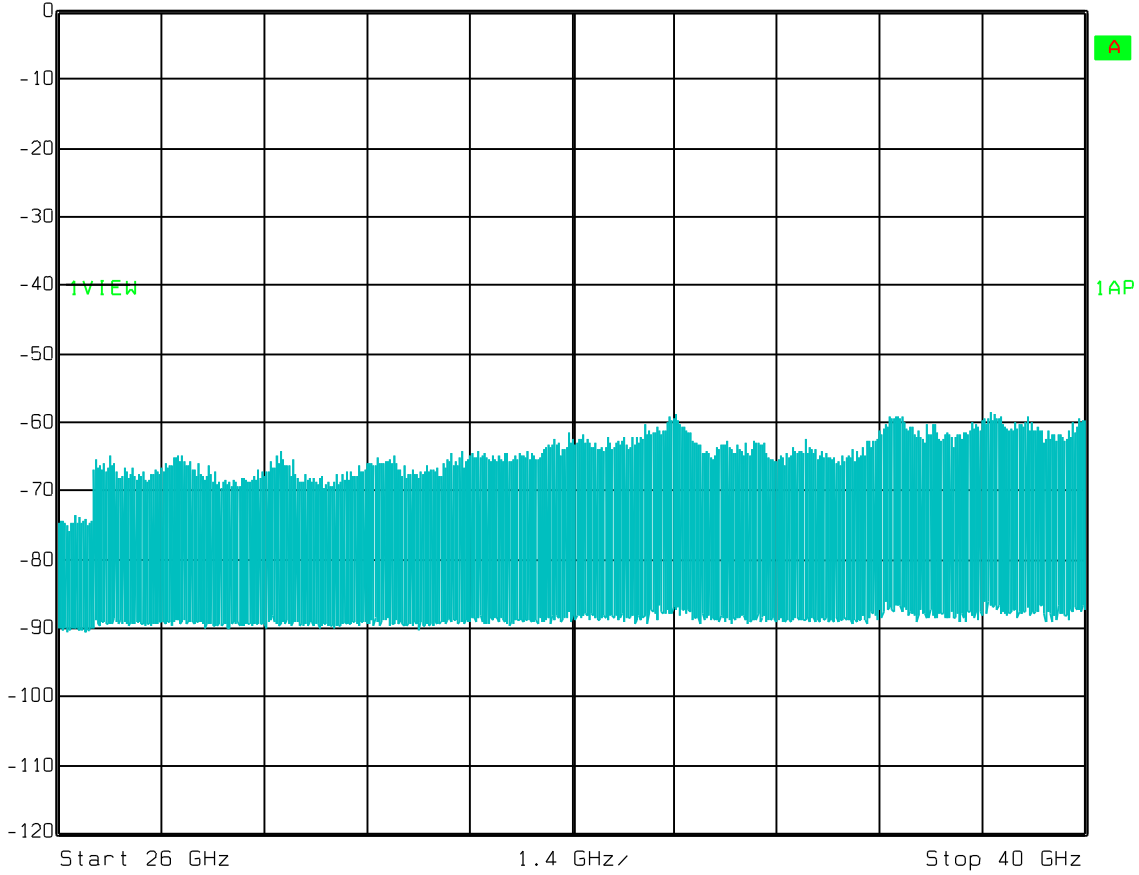

Title: BDS1/32TCM,30DBM_OUT OF BAND EMISSIONS
Comment A: 5730 MHZ
Date: 25.JUN.2002 9:24:42

Plot 4.4.3.6

4.4.3 Model: MDR-8505u-16 (Capacity: 16DS1, Modulation: 32TCM)

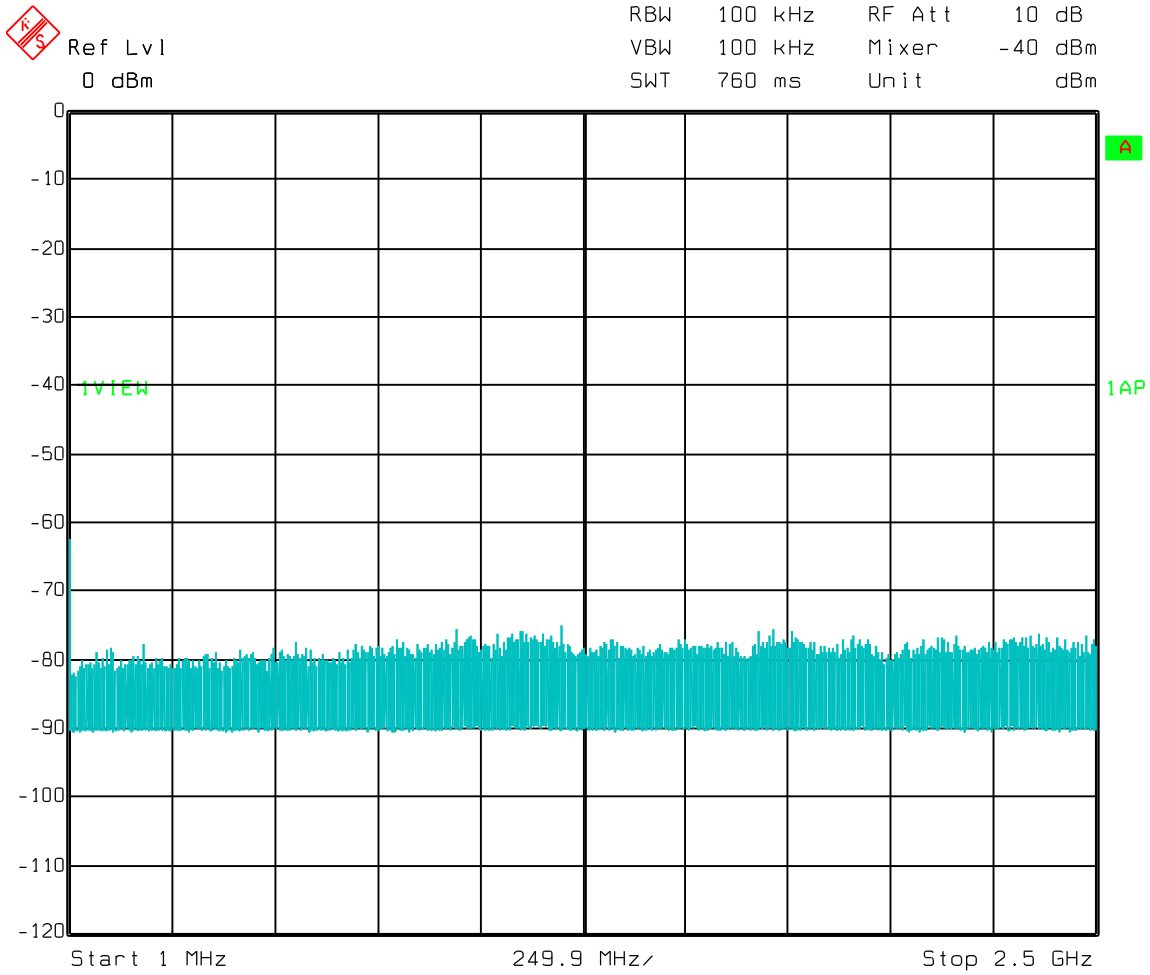

Title: 16DS1/32TCM,30DBM_OUT OF BAND EMISSIONS
Comment A: 5730 MHz
Date: 25.JUN.2002 9:29:42

Plot 4.4.4.1



Ref Lvl
0 dBm

RBW	100 kHz	RF Att	10 dB
VBW	100 kHz	Mixer	-40 dBm
SWT	760 ms	Unit	dBm

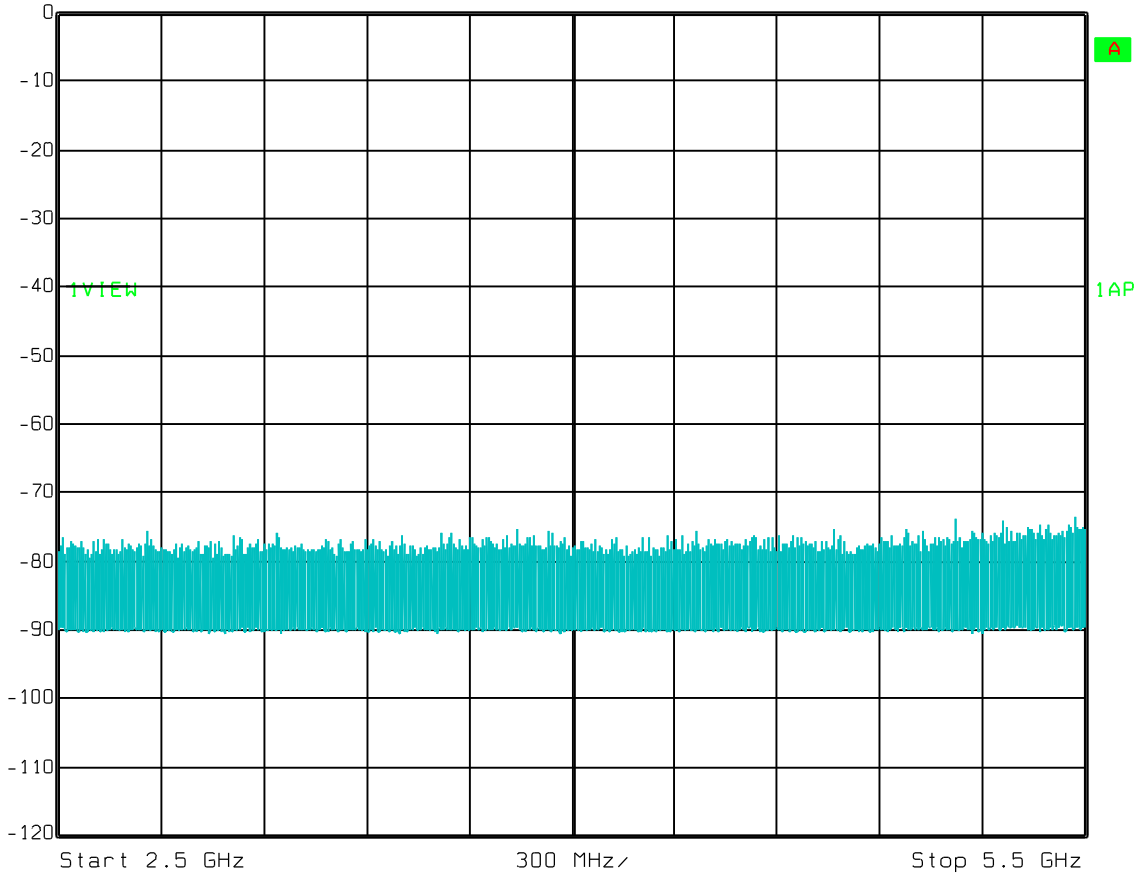

Title: 16DS1/32TCM,30DBM_OUT OF BAND EMISSIONS
Comment A: 5730 MHZ
Date: 25.JUN.2002 9:31:11

Plot 4.4.2



Ref Lvl
0 dBm

RBW	100 kHz	RF Att	10 dB
VBW	100 kHz	Mixer	-40 dBm
SWT	760 ms	Unit	dBm

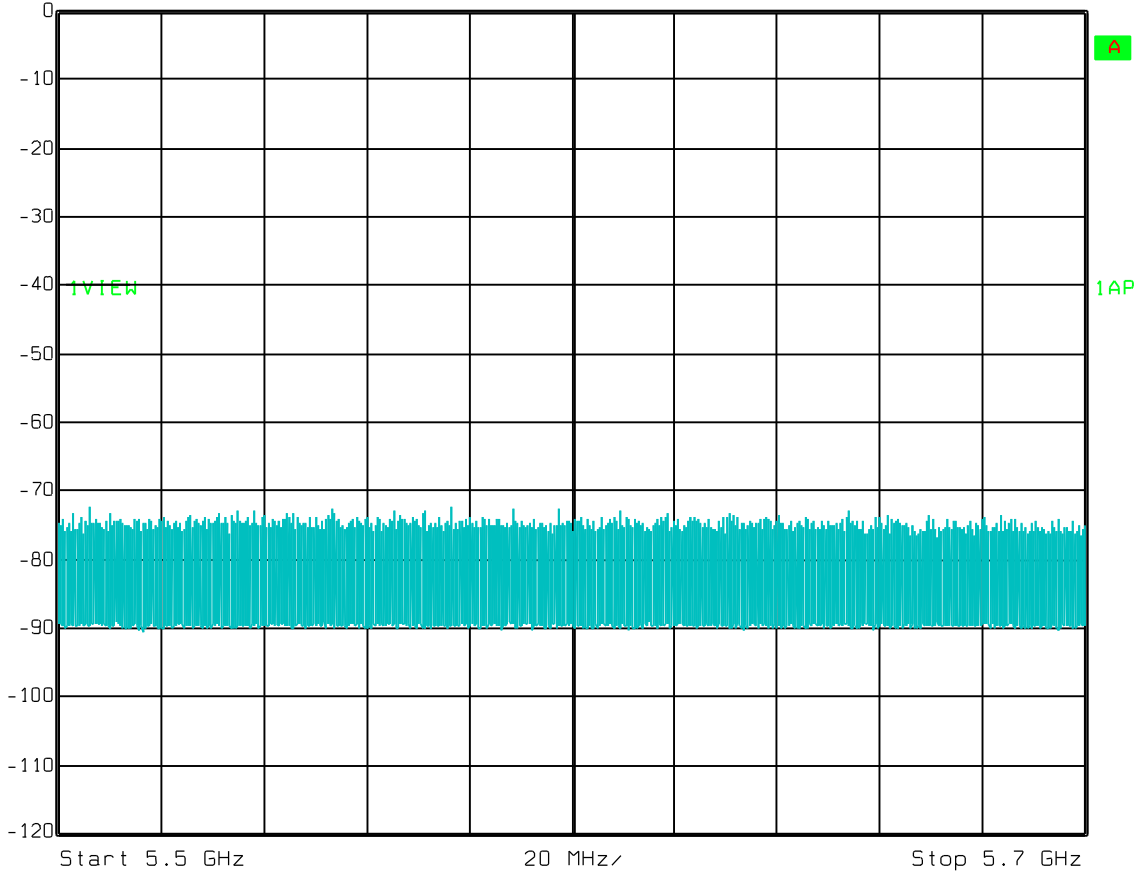

Title: 16DS1/32TCM,30DBM_OUT OF BAND EMISSIONS
Comment A: 5730 MHZ
Date: 25.JUN.2002 9:32:19

Plot 4.4.3



Ref Lvl
0 dBm

RBW	100 kHz	RF Att	10 dB
VBW	100 kHz	Mixer	-40 dBm
SWT	760 ms	Unit	dBm

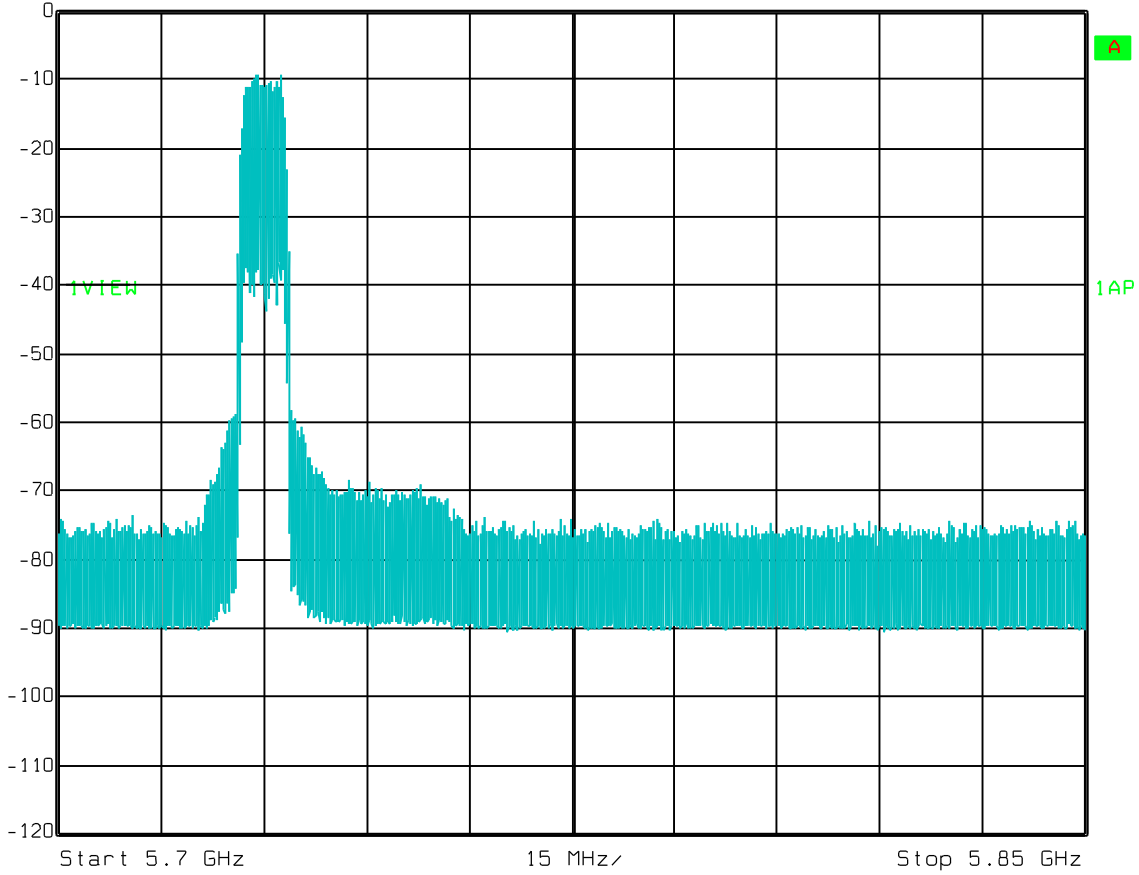

Title: 16DS1/32TCM,30DBM_OUT OF BAND EMISSIONS
Comment A: 5730 MHz
Date: 25.JUN.2002 9:41:47

Plot 4.4.4.4

Note: This plot shows the transmit signal at 5730Mhz



Ref Lvl
0 dBm

RBW	100 kHz	RF Att	10 dB
VBW	100 kHz	Mixer	-40 dBm
SWT	5.6 s	Unit	dBm

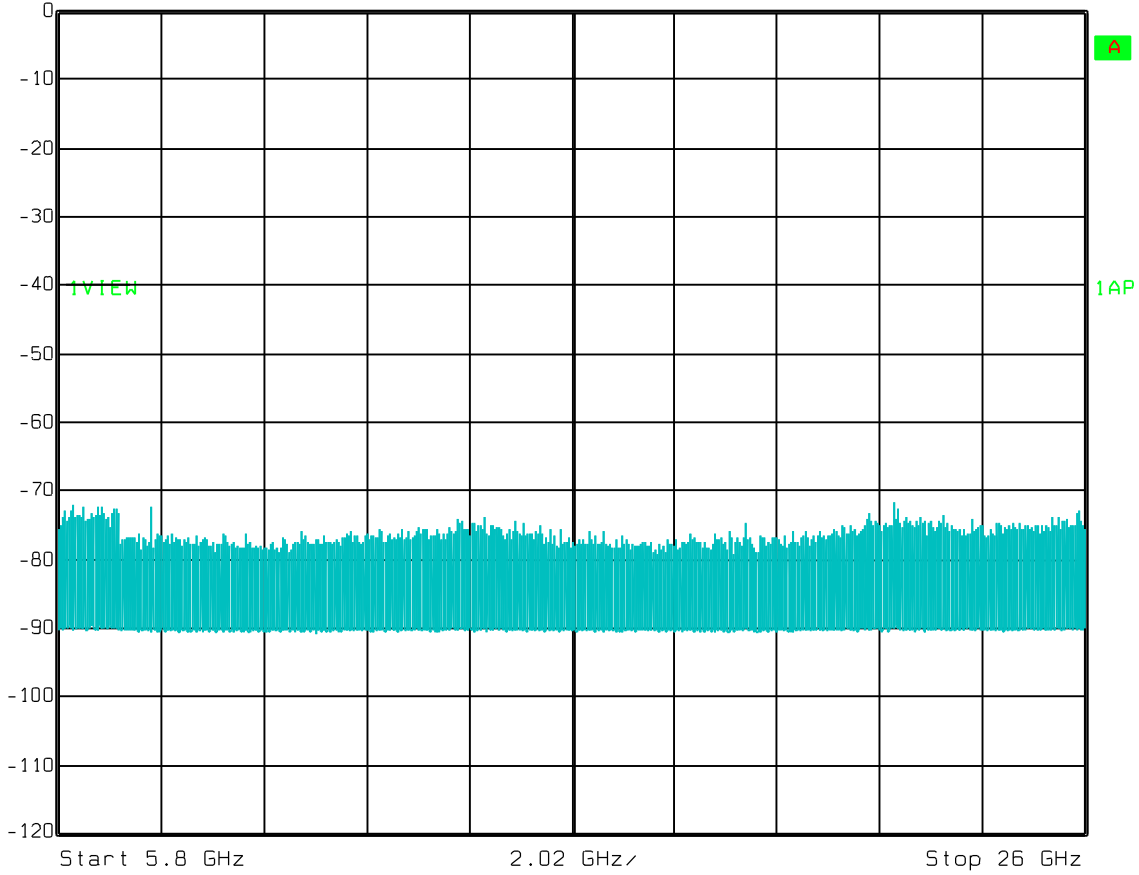

Title: 16DS1/32TCM,30DBM_OUT OF BAND EMISSIONS
Comment A: 5730 MHZ
Date: 25.JUN.2002 9:43:07

Plot 4.4.5



Ref Lvl
0 dBm

RBW 100 kHz RF Att 10 dB
VBW 100 kHz Mixer -40 dBm
SWT 5.6 s Unit dBm

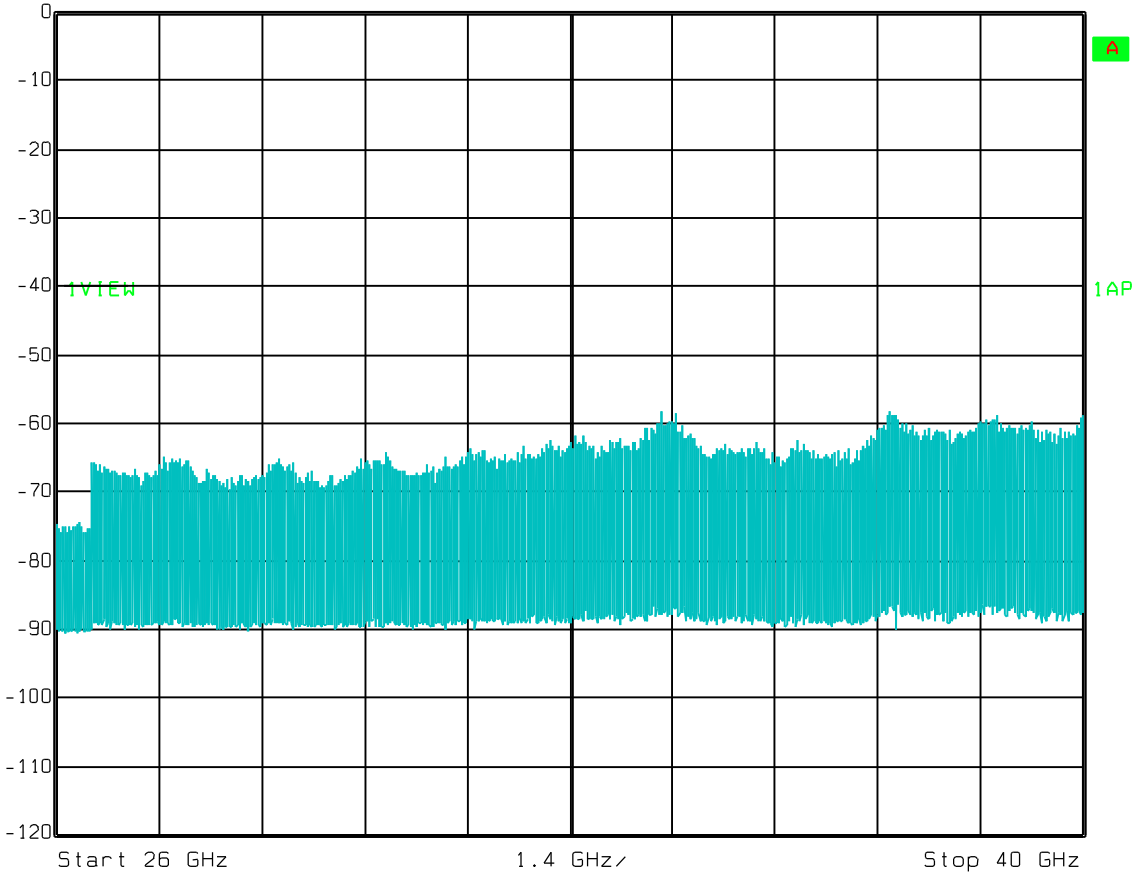

Title: 16DS1/32TCM,30DBM_OUT OF BAND EMISSIONS
Comment A: 5730 MHz
Date: 25.JUN.2002 9:44:13

Plot 4.4.6

4.4.5 Model: MDR-8605u-45 (Capacity: 1DS3, Modulation: 64QAM)

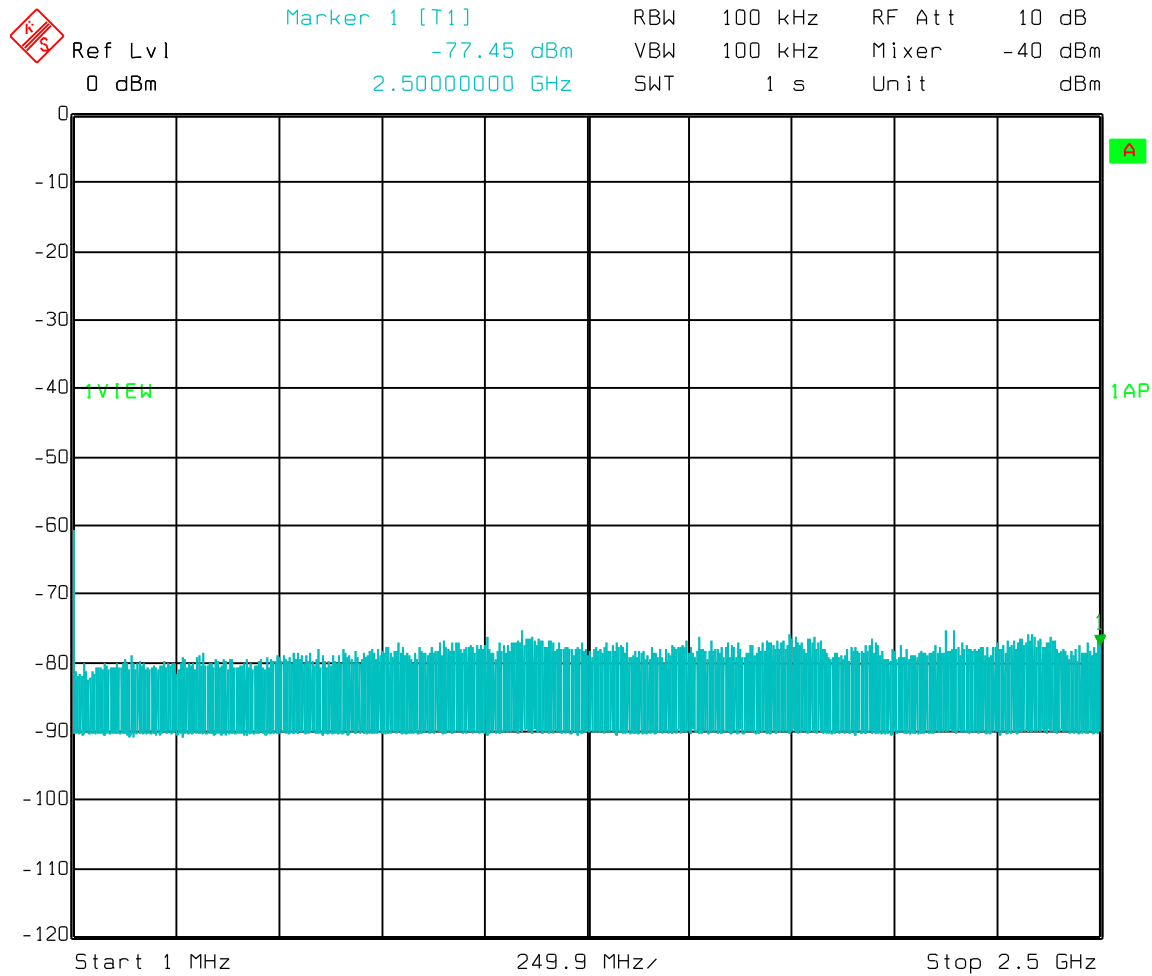

Title: 1DS3/64QAM,30DBM_OUT OF BAND EMISSIONS
 Comment A: 5730 MHZ
 Date: 24.JUN.2002 9:39:05

Plot 4.4.5.1



Ref Lvl 0 dBm
Marker 1 [T1] -78.03 dBm
2.50000000 GHz
RBW 100 kHz
RF Att 10 dB
VBW 100 kHz
Mixer -40 dBm
SWT 760 ms
Unit dBm

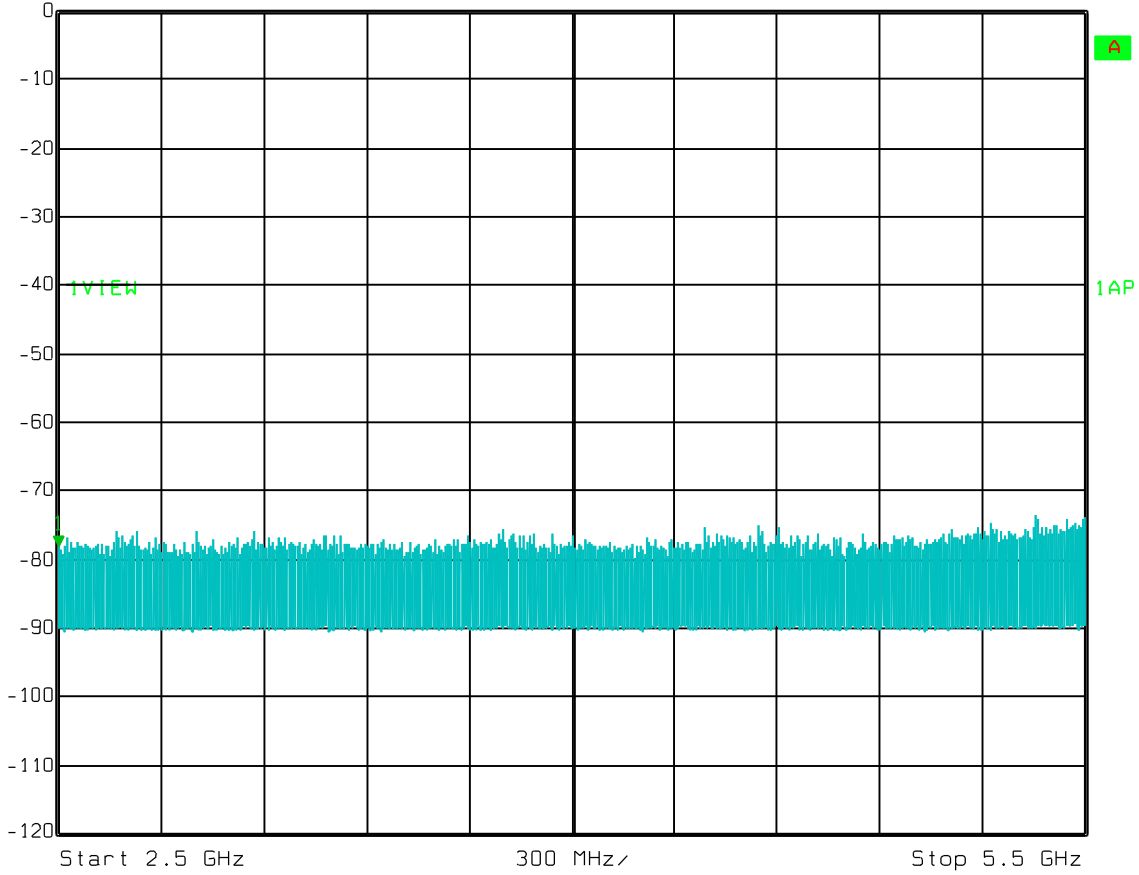

Title: 1D53/64QAM,30DBM_OUT OF BAND EMISSIONS
Comment A: 5730 MHz
Date: 24.JUN.2002 9:40:58

Plot 4.4.5.2



Ref Lvl
0 dBm

RBW	100 kHz	RF Att	10 dB
VBW	100 kHz	Mixer	-40 dBm
SWT	760 ms	Unit	dBm

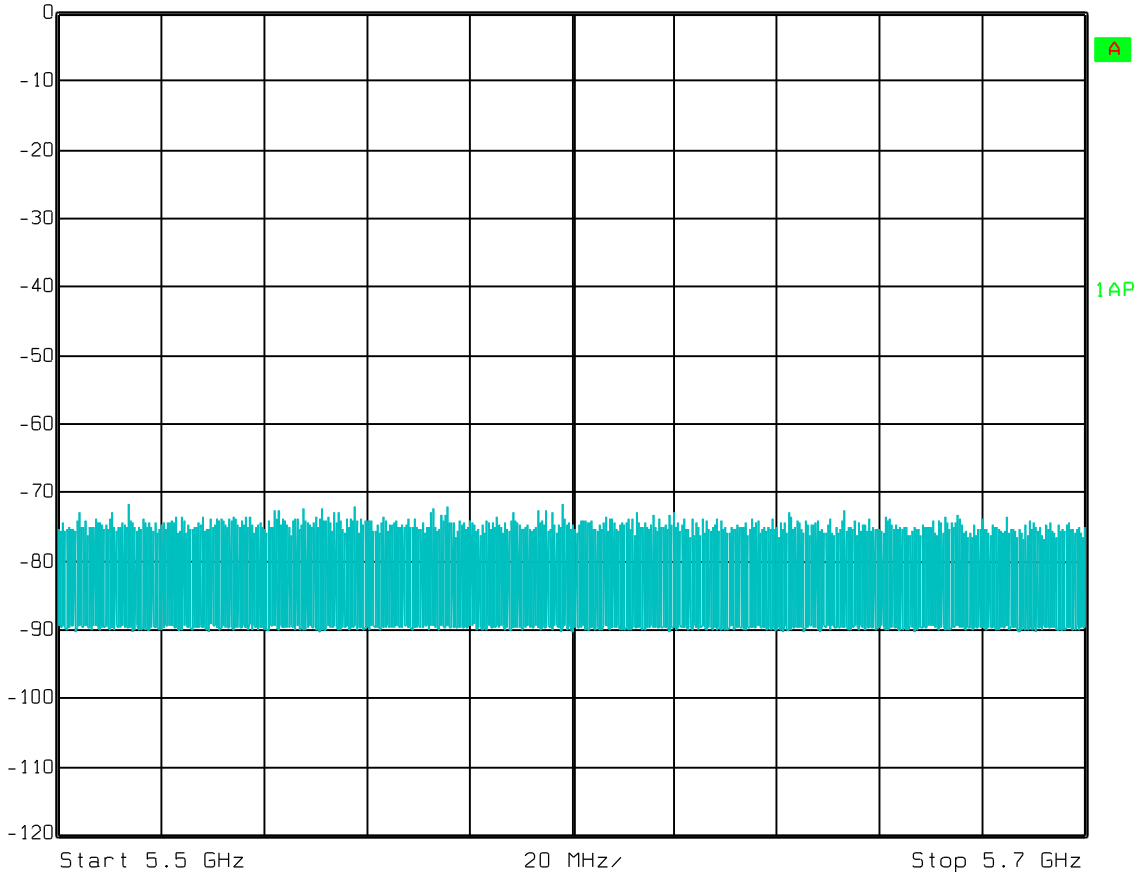

Title: 1053/64QAM,30DBM_OUT OF BAND EMISSIONS
Comment A: 5730 MHZ
Date: 24.JUN.2002 10:03:40

Plot 4.4.5.3



Ref Lvl
0 dBm

RBW	100 kHz	RF Att	10 dB
VBW	100 kHz	Mixer	-40 dBm
SWT	760 ms	Unit	dBm

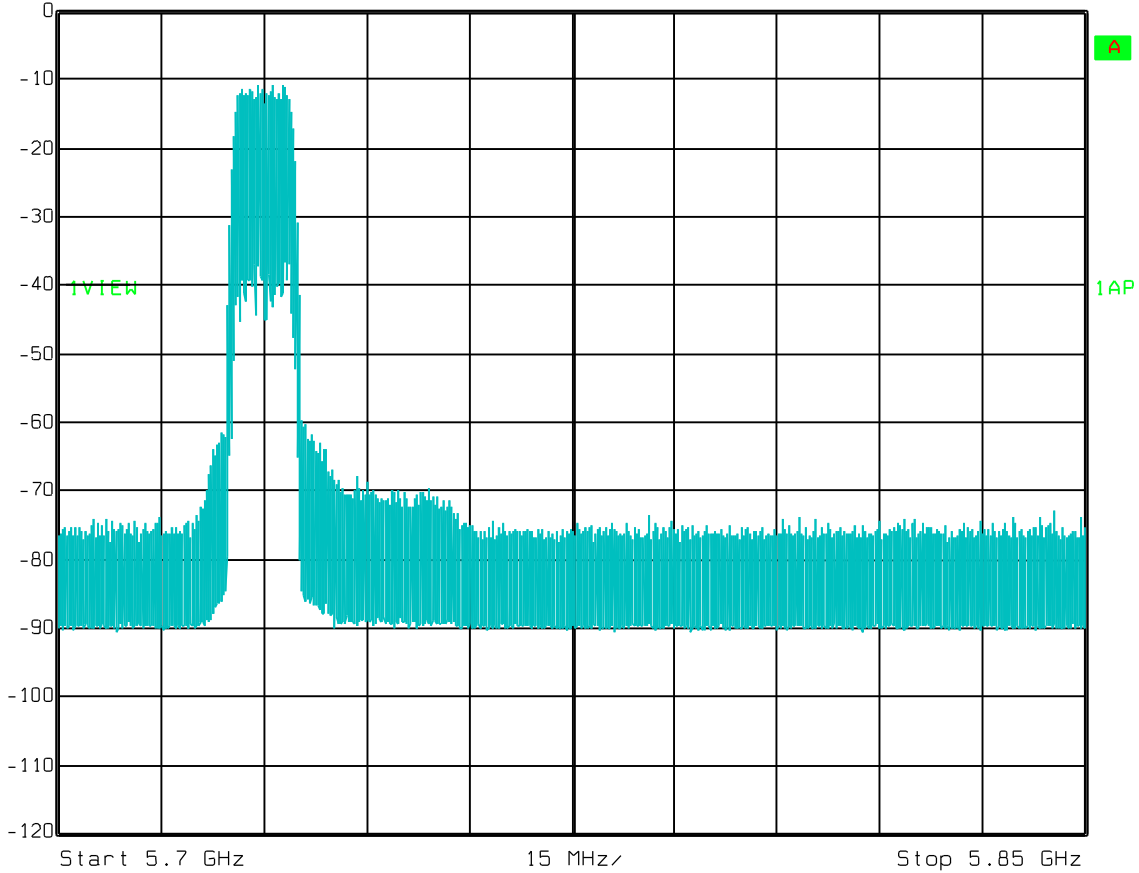

Title: 1D53/64QAM,30DBM_OUT OF BAND EMISSIONS
Comment A: 5730 MHZ
Date: 24.JUN.2002 10:05:21

Plot 4.4.5.4

Note: This plot shows the transmit signal at 5730Mhz



Ref Lvl
0 dBm

RBW 100 kHz RF Att 10 dB
VBW 100 kHz Mixer -40 dBm
SWT 10 s Unit dBm

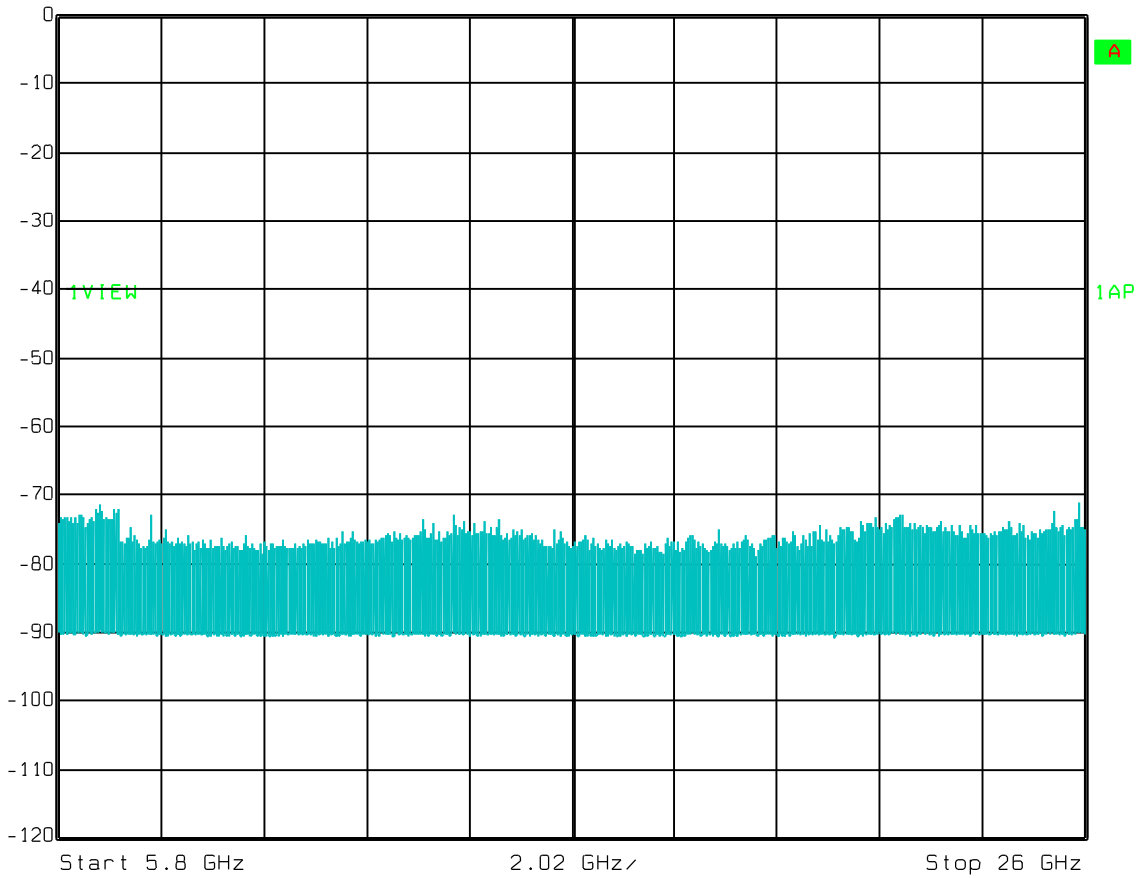

Title: 1DS3/64QAM,30DBM_OUT OF BAND EMISSIONS
Comment A: 5730 MHZ
Date: 24.JUN.2002 10:36:49

Plot 4.4.5.5



Ref Lvl
0 dBm

RBW	100 kHz	RF Att	10 dB
VBW	100 kHz	Mixer	-40 dBm
SWT	4 s	Unit	dBm

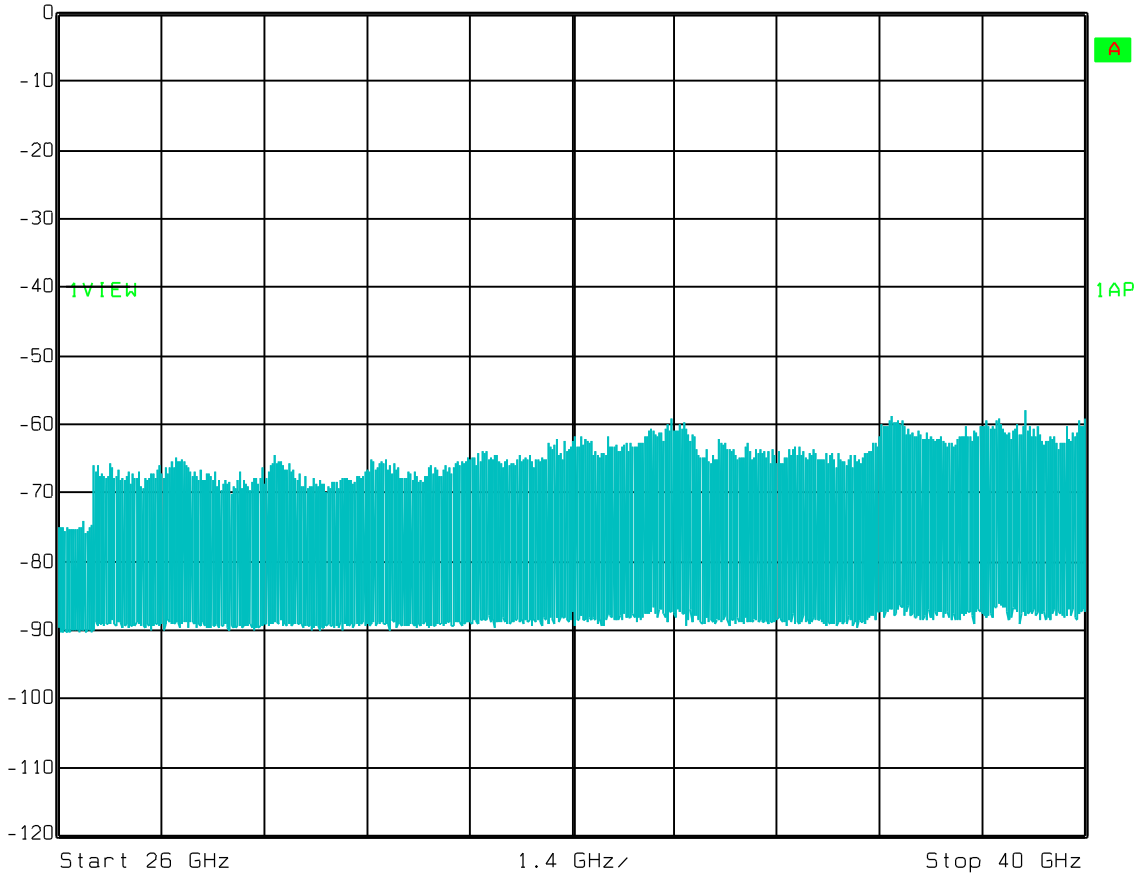

Title: 1D53/64QAM,30DBM_OUT OF BAND EMISSIONS
Comment A: 5730 MHZ
Date: 24.JUN.2002 10:38:39

Plot 4.4.5.6

4.5 Out of Band Radiated Emissions FCC 15.247(c)

Requirements for systems using digital modulation in the 5725-5850Mhz band:

Out of band emissions which are close to or that exceed the 20db requirement described in the FCC 15.247 (c) should comply with the general radiation emission requirement.

Test Conditions: No emission found that violates the above requirement (see out of band emissions plots).

4.6 Radiated Emissions in Restricted Bands FCC 15.247(c)

Requirements for systems using digital modulation in the 5725-5850Mhz band:

(c) ... in addition radiated emissions which fall in the restricted bands, as defined in paragraph 15.205(a), must comply with the radiated emission limits specified in paragraph 15.209 (a).

Test Conditions: Radiated emissions checks were performed in the restricted bands as defined in paragraph 15.205(a).

No emission found that violates the FCC 15.209 limits

The data on the following table show the radiated emissions (if there is any) in the restricted bands.

Radiated Emissions in Restricted Bands						
Frequency Band (MHz)	Spur Frequency (MHz)	Ant Pol	Corrected Reading dBuV/m	Limit dBuV/m	Margin db	
37.5 - 38.25						
73 -74.6						
74.8 - 75.2						
108 - 121.94						
123 - 138	125.14	H	32	43.5	11.5	
123 - 138	135.59	H	27.3	43.5	16.2	
149.9 - 150.05						
156.52475 - 156.52525						
156.7 - 156.9						
162.0125 - 167.17						
167.72 - 173.2	171.68	H	37.4	43.5	6.1	
167.72 - 173.2	171.68	V	29.9	43.5	13.6	
240 - 285	240.1	H	31.1	46	14.9	
240 - 285	240.1	V	35.1	46	10.9	
240 - 285	245.28	H	30.5	46	15.5	
240 - 285	250.12	H	33.4	46	12.6	
240 - 285	250.12	V	37.6	46	8.4	
240 - 285	280.31	H	38.4	46	7.6	
240 - 285	280.13	V	35.6	46	10.4	
322 - 335.4						
399.9 - 410						
608 - 614						
960 - 1240	980.91	H	50.5	54	3.5	
960 - 1240	980.91	V	50	54	4	
960 - 1240	1015.73	H	43.2	54	10.8	
960 - 1240	1015.73	V	43	54	11	
960 - 1240	1051	V	37	54	17	
960 - 1240	1191	V	37	54	17	
1300 - 1427						
1435 - 1626						
1645.5 - 1646.5						
1660 - 1710						
1718.8 - 1722.2						
2200 - 2300						
2310 - 2390						
2483.5 - 2500						
2655 - 2900	2692.98	H	44.7	54	9.3	

2655 - 2900	2692.98	V	41	54	13	
3260 - 3267						
3332 - 3339						
3345.8 - 3358						
3600 - 4400	3850.86	H	48.4	54	5.6	
3600 - 4400	3850.86	V	50.1	54	3.9	
4500 - 5250						
5350 - 5460						
7250 - 7750						
8025 - 8500						
9000 - 9200						
9300 - 9500						

Note:

All measurements were made at 3 meters

The corrected reading takes into account the antenna factor, cable losses and the gain of the amplifier used for the measurements.

The column "Spur Frequency" lists the emissions found in some of the restricted bands.

The Margin column shows how much the spur level is below the FCC15.209 limit.

For frequencies higher than 10Ghz no readings were above the noise floor of the test equipment.

4.7 Antenna Requirement

The MDR-8X05u-XX radios must be professionally installed and for that reason they are exempt from the antenna restrictions of the FCC Part 15.203.

The MDR-8X05u-XX radios will be used for point –to-point communications only, as fixed, permanent or temporary links requiring the use of directional antennas mounted outdoor, usually on a tower. These antennas have narrow beamwidths and require a professional installer for alignment.

The maximum transmit power of the MDR-8X05u-XX radio is 1Watt(30dbm) and it is adjusted in the factory during the final tests. However the output power can be adjusted to lower levels by professional installer during installation. The method of adjusting the output power is described in the manual written for use by professional trained installers.

This radio is sold without antenna and the customer chooses from commercially available antennas.