

- NOTES:
1. ALL ELECTRICAL SIGNAL NAMES AND COMPONENTS ARE LISTED IN THE CROSS REFERENCE TABLES.
 2. UNLESS OTHERWISE SPECIFIED:
ALL RESISTANCE VALUES ARE IN OHMS
ALL CAPACITANCE VALUES ARE IN MICROFARADS
ALL INDUCTANCE VALUES ARE IN MICROHENRIES
 3. INTEGRATED CIRCUIT TYPE NUMBERS SHOWN ARE THOSE NORMALLY EQUIPPED. EQUIVALENT TYPES MAY BE SUBSTITUTED AT TIME OF MANUFACTURE WITH APPROVAL OF ALCATEL COMPONENT APPLICATION ENGINEERING.

 CAUTION
ESS
UNIT CONTAINS ELECTROSTATIC SENSITIVE ITEMS.
MAINTAIN ANTISTATIC PROTECTION.

PBA_FAMILY=3EM11842
VAR_TABLE1=AAAA|ABAA
VAR_TABLE2=UNKNOWN
VAR_TABLE3=UNKNOWN
VAR_TABLE4=UNKNOWN
VAR_TABLE5=UNKNOWN
VAR_TABLE6=UNKNOWN
VAR_TABLE7=UNKNOWN
VAR_TABLE8=UNKNOWN
VAR_TABLE9=UNKNOWN
VAR_TABLE10=UNKNOWN

DRAWING
ABBREV=ALCATEL
TITLE=03146AF
LAST_MODIFIED=Thu Feb 5 13:41:01 2004

ED	REL DATE	04	020904	05	030214	06	040114
CHANGE NOTE		F43559		F43897		F44750	
APPRA AUTHO		Al Holland		Marc Schaefer		Marc Schaefer	
ORIGINATOR		David Cowan		Eric Pham		David Cowan	
ALCATEL		MDR-8000 DX-35M-()			SCHEMATIC I/O INTFC		
				3DH 03146 AFAA ECZZA			1/34

THIS TRANSFER OF COMMODITIES, TECHNOLOGY, OR SOFTWARE, IF FROM THE UNITED STATES, IS AN EXPORT IN ACCORDANCE WITH THE U.S. EXPORT ADMINISTRATION REGULATIONS. DIVERSION CONTRARY TO U.S. LAW PROHIBITED. THE EXPORT OR RE-EXPORT (FURTHER TRANSFER) OF SUCH COMMODITIES, TECHNOLOGY, SOFTWARE, OR PRODUCTS MADE FROM SUCH TECHNOLOGY IS PROHIBITED WITHOUT PROPER AUTHORIZATION(S) FROM THE U.S. DEPARTMENT OF COMMERCE OR OTHER APPROPRIATE U.S. GOVERNMENT AGENCY(S).

P101
A3A/B3A ON BACKPLANE

	E	D	C	B	A
25	A GND B GND	A GND B GND	A GND B GND	A GND B GND	A GND B GND
24	ATX2BCK BTX2BCK	A GND B GND	A GND B GND		
23	A GND B GND	A GND B GND	A GND B GND		
22	A TX I0 B TX I0	A TX I1 B TX I1	A GND B GND		
21	A GND B GND	A TX I2 B TX I2	A GND B GND		TDI
20	A TX I4 B TX I4	A TX I3 B TX I3	A GND B GND	TMS	XMT PRESENT
19	ATXBCLK BTXBCLK	A GND B GND	A GND B GND	A GND B GND	A GND B GND
18	A GND B GND	A TX Q0 B TX Q0	TCK		
17	A GND B GND	A GND B GND	A TX Q1 B TX Q1	TDO	
16	A TX Q4 B TX Q4	A TX Q3 B TX Q3	A TX Q2 B TX Q2		
15	A GND B GND	A GND B GND	A GND B GND	A GND B GND	A GND B GND

A3A INPUT/OUTPUT B3A

	E	D	C	B	A
11	F CLK 1	A GND B GND	F CLK 2	A GND B GND	FREQ CONTROL
10	A GND B GND	A GND B GND	A RX I4 B RX I4	A RX I5 B RX I5	A RX I6 B RX I6
9	PROV 1	A GND B GND	A RX I3 B RX I3	A GND B GND	A GND B GND
8	PROV 2	A GND B GND	A RX I2 B RX I2	A RX I1 B RX I1	A RX I0 B RX I0
7	PROV 3	A GND B GND	A GND B GND	A GND B GND	A GND B GND
6	PROV 4	A GND B GND	DX FRM LOSS	A GND B GND	ARXBTCK BRXBTCK
5	PROV 5	A GND B GND	A GND B GND	A GND B GND	ARXBDCK BRXBDCK
4	PROV 6	A GND B GND	A GND B GND	A GND B GND	A GND B GND
3	PROV 7	A GND B GND	A RX Q4 B RX Q4	A RX Q5 B RX Q5	A RX Q6 B RX Q6
2	FREQ 2	A GND B GND	A RX Q3 B RX Q3	A GND B GND	A GND B GND
1	PROV 8	A GND B GND	A RX Q2 B RX Q2	A RX Q1 B RX Q1	A RX Q0 B RX Q0

P102
A3B/B3B ON BACKPLANE

	E	D	C	B	A
25	A GND B GND		A GND B GND		A GND B GND
24	WEST SC 256 CLK	A GND B GND		A GND B GND	EAST SC 256 CLK
23	A GND B GND		A GND B GND		A GND B GND
22	WEST SC 64K CLK	A GND B GND	A/B RCVR ENABLE	A GND B GND	EAST SC 64K CLK
21	A GND B GND	WEST SC XMT DAT	A GND B GND	EAST SC XMT DAT	A GND B GND
20	WEST SC 16K CLK	A GND B GND	A/B I/O ENABLE	A GND B GND	EAST SC 16K CLK
19	A GND B GND	WEST SC XMT OH	A GND B GND	EAST SC XMT OH	A GND B GND
18	WEST SC 8K MARK	A GND B GND	XMT ONLINE	A GND B GND	EAST SC 8K MARK
17	A GND B GND	WEST SC RCVR DAT	A GND B GND	EAST SC RCVR DAT	A GND B GND
16	WEST SC 2K FRM	A GND B GND	AI/OIRQ BI/OIRQ	A GND B GND	EAST SC 2K FRM
15	A GND B GND		A GND B GND		A GND B GND

A3B INPUT/OUTPUT B3B

	E	D	C	B	A
11		A GND B GND		A GND B GND	
10	GD4	GD3	GD2	GD1	GD0
9	GD5	GD6	GD7	GR/W	LAMP T
8	GA5	GA6	GA7	GA8	GA9
7	GA4	GA3	GA2	GA1	GA0
6	A SCL B SCL	A SDA B SDA	GDSTB	A/B SEL	GDSR1
5	SEL 0	SEL 1	SEL 2	SEL 3	SERIAL TX/RX
4	A GND B GND	SER CLK A/B	SDAT TX	SDAT RX	A GND B GND
3		PS SHUT DOWN F	A OR B 12 TO 5	+5VCSRC OUT	+5VCSRC OUT
2		A OR B 12 TO 5	A OR B 12 TO 5	+5VCSRC IN	
1	A GND B GND	+12V PRECHRG	+12V PRECHRG	+5VCSRC IN	

P103
A3C/B3C ON LBO

	E	D	C	B	A
11	DS1 DX1T	RCVR X1DT	DS1 DX2T	RCVR Y1DT	DS1 DX3T
10	DS1 DX1R	RCVR X1DF	DS1 DX2R	RCVR Y1DF	DS1 DX3R
9	GND	GND	GND	GND	GND
8	RCVR X2DT	DS1 DX4T	RCVR Y2DT	DS1 DX5T	REC SNCT
7	RCVR X2DF	DS1 DX4R	RCVR Y2DF	DS1 DX5R	REC SNCF
6	DS1 DX6T	RCVR Y3DT	DS1 DX7T	RCVR X3DT	DS1 DX8T
5	DS1 DX6R	RCVR Y3DF	DS1 DX7R	RCVR X3DF	DS1 DX8R
4	GND	GND	LBO ID3	LBO ID2	LBO ID1
3	DS1 DX9T	RCVR Y4DT	DS1 D10T	RCVR X4DT	DS1 D11T
2	DS1 DX9R	RCVR Y4DF	DS1 D10R	RCVR X4DF	DS1 D11R
1	GND	GND	GND	GND	GND

E D C B A

P104
A3D/B3D ON LBO

	E	D	C	B	A
25	CHSY NC3B	DS1 D12T	CHSY NC2B	DS1 D13T	CHSY NC1B
24	CHSY NC3A	DS1 D12R	CHSY NC2A	DS1 D13R	CHSY NC1A
23	GND		AZCK	GND	GND
22	DS1 D14T	MX SYNC	DS1 D15T	CHSY NC4B	DS1 D16T
21	DS1 D14R	MX CLK	DS1 D15R	CHSY NC4A	DS1 D16R
20	DX DY2D	GND	DX DY1D	GND	GND
19	DX DX2D	GND	DX DX1D	RCV DISABL	RCV ONLINE
18	GND	GND	GND	TX DX CK F	IO DISABL
17	DX DY4D	GND	DX DY3D	TX DX CK T	IO ONLINE
16	DX DX4D	GND	DX DX3D	RX DX CK F	RX DX CK T
15	DS1 M16R	DX AIS INSERT	DS1 M15R		DS1 M14R
14	DS1 M16T	DX ALGN	DS1 M15T		DS1 M14T
13	GND	DX SYNC	DX CLK	GND	GND
12	DS1 M13R	MX MX4D	DS1 M12R	MX MX3D	DS1 M11R
11	DS1 M13T	MX MY4D	DS1 M12T	MX MX3D	DS1 M11T
10	MX MX2D	DS1 M10R	MX MX1D	DS1 MX9R	XMTR Y4DF
9	MX MY2D	DS1 M10T	MX MY1D	DS1 MX9T	XMTR Y4DT
8	GND	RPTR SYNF	RPTR SYNT	GND	GND
7	DS1 MX8R	XMTR Y3DF	DS1 MX7R	XMTR X4DF	DS1 MX6R
6	DS1 MX8T	XMTR Y3DT	DS1 MX7T	XMTR X4DT	DS1 MX6T
5	XMTR X3DF	DS1 MX5R	XMTR Y2DF	DS1 MX4R	XMTR X2DF
4	XMTR X3DT	DS1 MX5T	XMTR Y2DT	DS1 MX4T	XMTR X2DT
3	GND	GND	GND	GND	GND
2	DS1 MX3R	XMTR Y1DF	DS1 MX2R	XMTR X1DF	DS1 MX1R
1	DS1 MX3T	XMTR Y1DT	DS1 MX2T	XMTR X1DT	DS1 MX1T

E D C B A

DRAWING

ABBREV=ALCATEL
TITLE=03146AF
LAST_MODIFIED=Mon Dec 22 14:35:25 CST 2003

Backplane and LBO Pinout

ED	06			
ALCATEL			3DH 03146 AFAA ECZZA	2

THIS TRANSFER OF COMMODITIES, TECHNOLOGY OR SOFTWARE, IF FROM THE UNITED STATES, IS AN EXPORT IN ACCORDANCE WITH THE U.S. EXPORT ADMINISTRATION REGULATIONS. DIVERSION CONTRARY TO U.S. LAW PROHIBITED. THE EXPORT OR RE-EXPORT (FURTHER TRANSFER) OF SUCH COMMODITIES, TECHNOLOGY, SOFTWARE, OR PRODUCTS MADE FROM SUCH TECHNOLOGY IS PROHIBITED WITHOUT PROPER AUTHORIZATION(S) FROM THE U.S. DEPARTMENT OF COMMERCE OR OTHER APPROPRIATE U.S. GOVERNMENT AGENCY(S).

1AA 00014 0000 (9711) B - CONCEPT (PSD 13.6)

ALCATEL CONFIDENTIAL & PROPRIETARY INFORMATION. CONTAINS TRADE SECRET INFORMATION WHICH IS THE PROPERTY OF ALCATEL AND MUST NOT BE MADE AVAILABLE TO, OR COPIED OR USED BY ANYONE OUTSIDE ALCATEL WITHOUT ITS WRITTEN AUTHORIZATION.

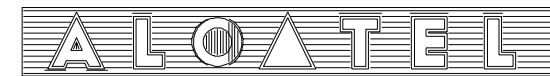
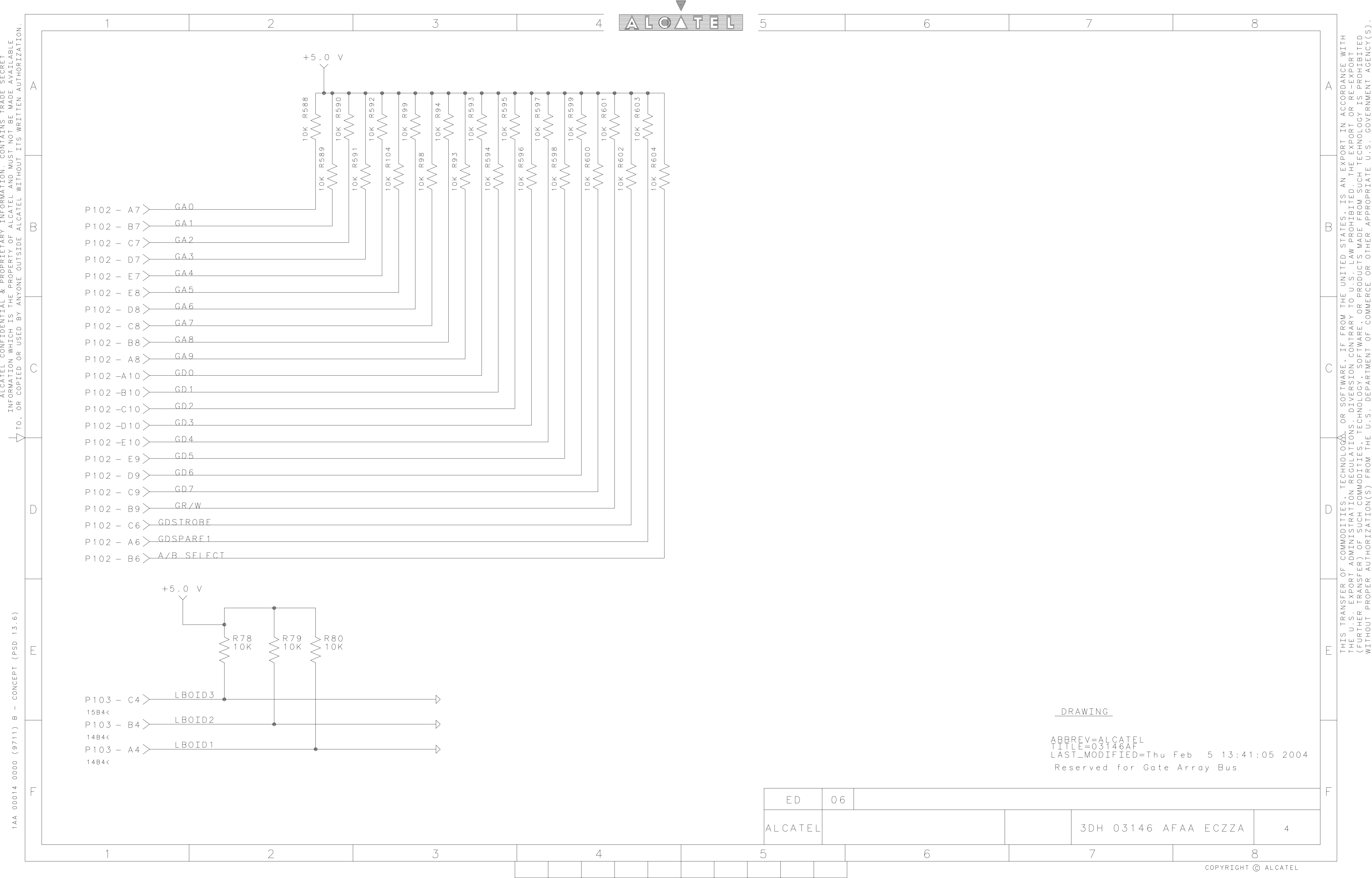

1AA 00014 0000 (9711) B - CONCEPT (PSD 13.6)

THIS TRANSFER OF COMMODITIES, TECHNOLOGY, OR SOFTWARE, IF FROM THE UNITED STATES, IS AN EXPORT IN ACCORDANCE WITH THE U.S. EXPORT ADMINISTRATION REGULATIONS. DIVERSION CONTRARY TO U.S. LAW PROHIBITED. THE EXPORT OR RE-EXPORT (FURTHER TRANSFER) OF SUCH COMMODITIES, TECHNOLOGY, SOFTWARE, OR PRODUCTS MADE FROM SUCH TECHNOLOGY IS PROHIBITED WITHOUT PROPER AUTHORIZATION(S) FROM THE U.S. DEPARTMENT OF COMMERCE OR OTHER APPROPRIATE U.S. GOVERNMENT AGENCY(S).

DRAWING
 ABBREV=ALCATEL
 TITLE=03146AF
 LAST_MODIFIED=Thu Feb 5 13:41:05 2004
 Reserved for Gate Array Bus

ED	06			
ALCATEL			3DH 03146 AFAA ECZZA	4

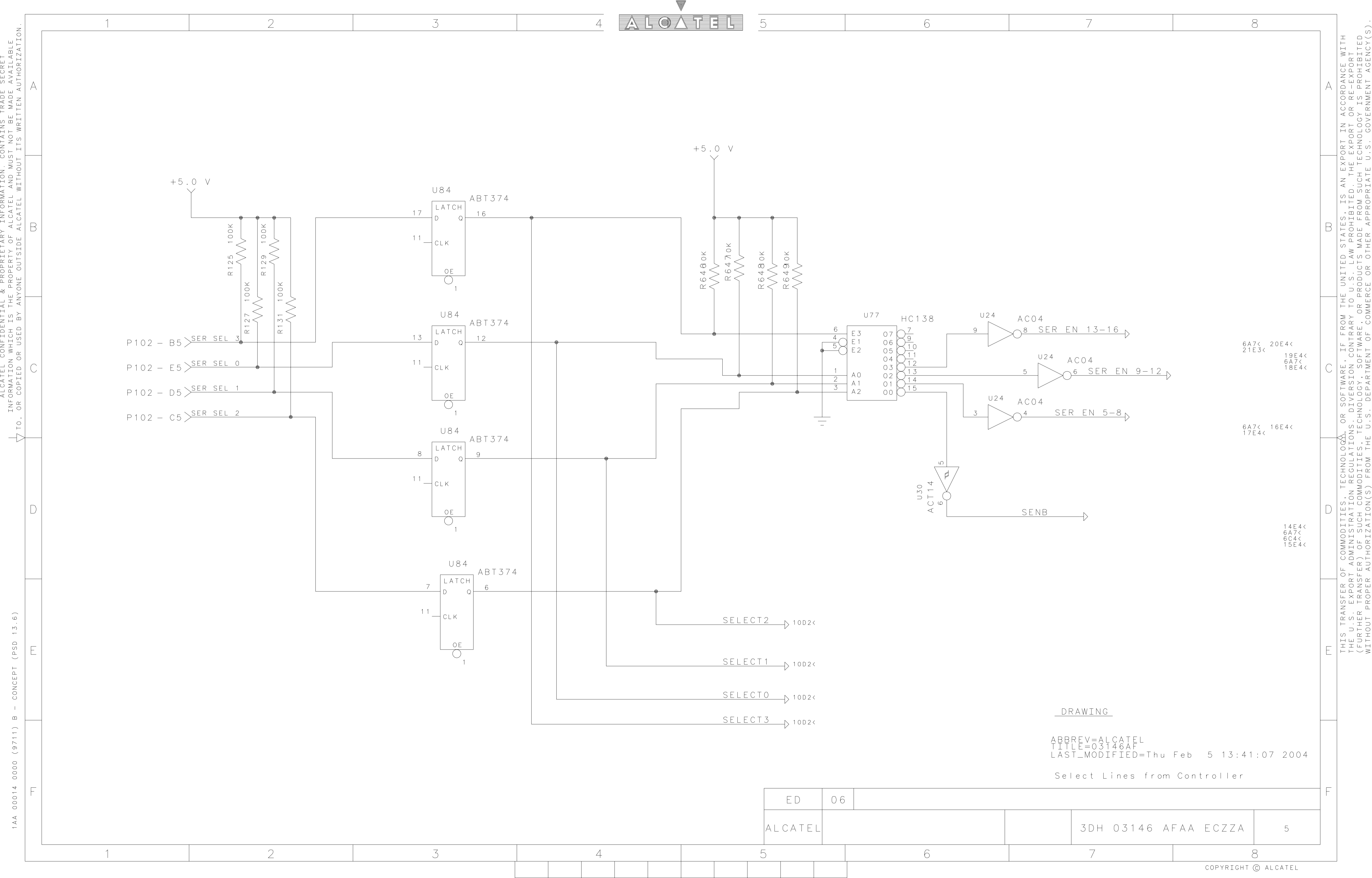

1AA 00014 0000 (9711) B - CONCEPT (PSD 13.6)
 ALCATTEL CONFIDENTIAL & PROPRIETARY INFORMATION. CONTAINS TRADE SECRET INFORMATION WHICH IS THE PROPERTY OF ALCATTEL AND MUST NOT BE MADE AVAILABLE TO, OR COPIED OR USED BY ANYONE OUTSIDE ALCATTEL WITHOUT ITS WRITTEN AUTHORIZATION.

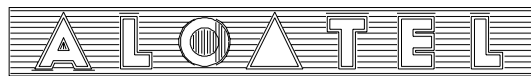

DRAWING
 ABBREV=ALCATEL
 TITLE=03146AF
 LAST_MODIFIED=Thu Feb 5 13:41:07 2004
 Select Lines from Controller

ED	06			
ALCATEL			3DH 03146 AFAA ECZZA	5

THIS TRANSFER OF COMMODITIES, TECHNOLOGY, OR SOFTWARE, IF FROM THE UNITED STATES, IS AN EXPORT IN ACCORDANCE WITH THE U.S. EXPORT ADMINISTRATION REGULATIONS. DIVERSION CONTRARY TO U.S. LAW PROHIBITED. THE EXPORT OR RE-EXPORT (FURTHER TRANSFER) OF SUCH COMMODITIES, TECHNOLOGY, SOFTWARE, OR PRODUCTS MADE FROM SUCH TECHNOLOGY IS PROHIBITED WITHOUT PROPER AUTHORIZATION(S) FROM THE U.S. DEPARTMENT OF COMMERCE OR OTHER APPROPRIATE U.S. GOVERNMENT AGENCY(S).

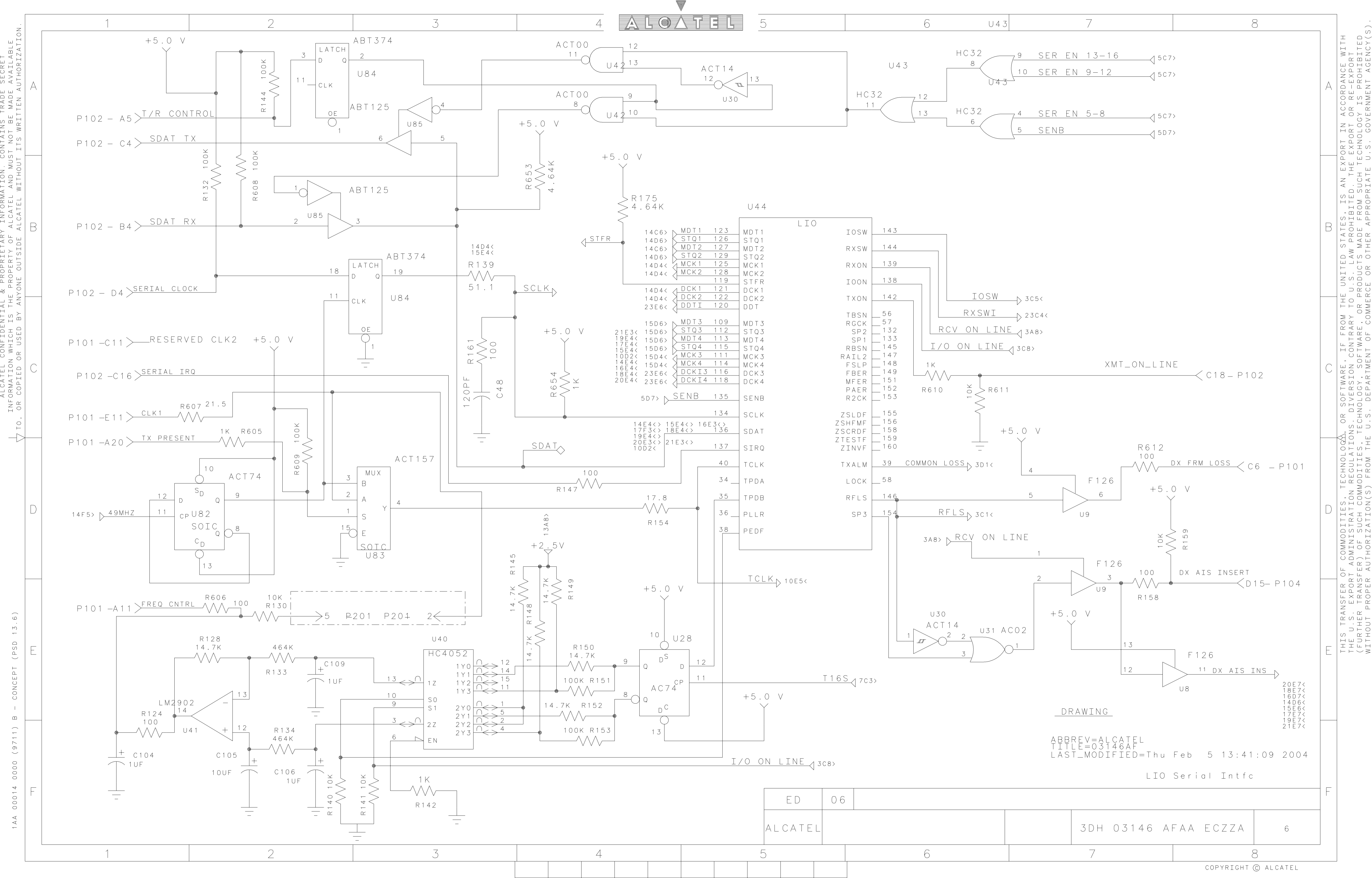

ABBREV=ALCATEL
 TITLE=03146AF
 LAST_MODIFIED=Thu Feb 5 13:41:09 2004

LIO Serial Intfc

ED	06			
ALCATEL			3DH 03146 AFAA ECZZA	6

1AA 00014 0000 (9711) B - CONCEPT (PSD 13.6)

THIS TRANSFER OF COMMODITIES, TECHNOLOGY, OR SOFTWARE, IF FROM THE UNITED STATES, IS AN EXPORT IN ACCORDANCE WITH THE U.S. EXPORT ADMINISTRATION REGULATIONS. DIVERSION CONTRARY TO U.S. LAW PROHIBITED. THE EXPORT OR RE-EXPORT (FURTHER TRANSFER) OF SUCH COMMODITIES, TECHNOLOGY, SOFTWARE, OR PRODUCTS MADE FROM SUCH TECHNOLOGY IS PROHIBITED WITHOUT PROPER AUTHORIZATION(S) FROM THE U.S. DEPARTMENT OF COMMERCE OR OTHER APPROPRIATE U.S. GOVERNMENT AGENCY(S).

14A 00014 0000 (9711) B - CONCEPT (PSD 13.6)

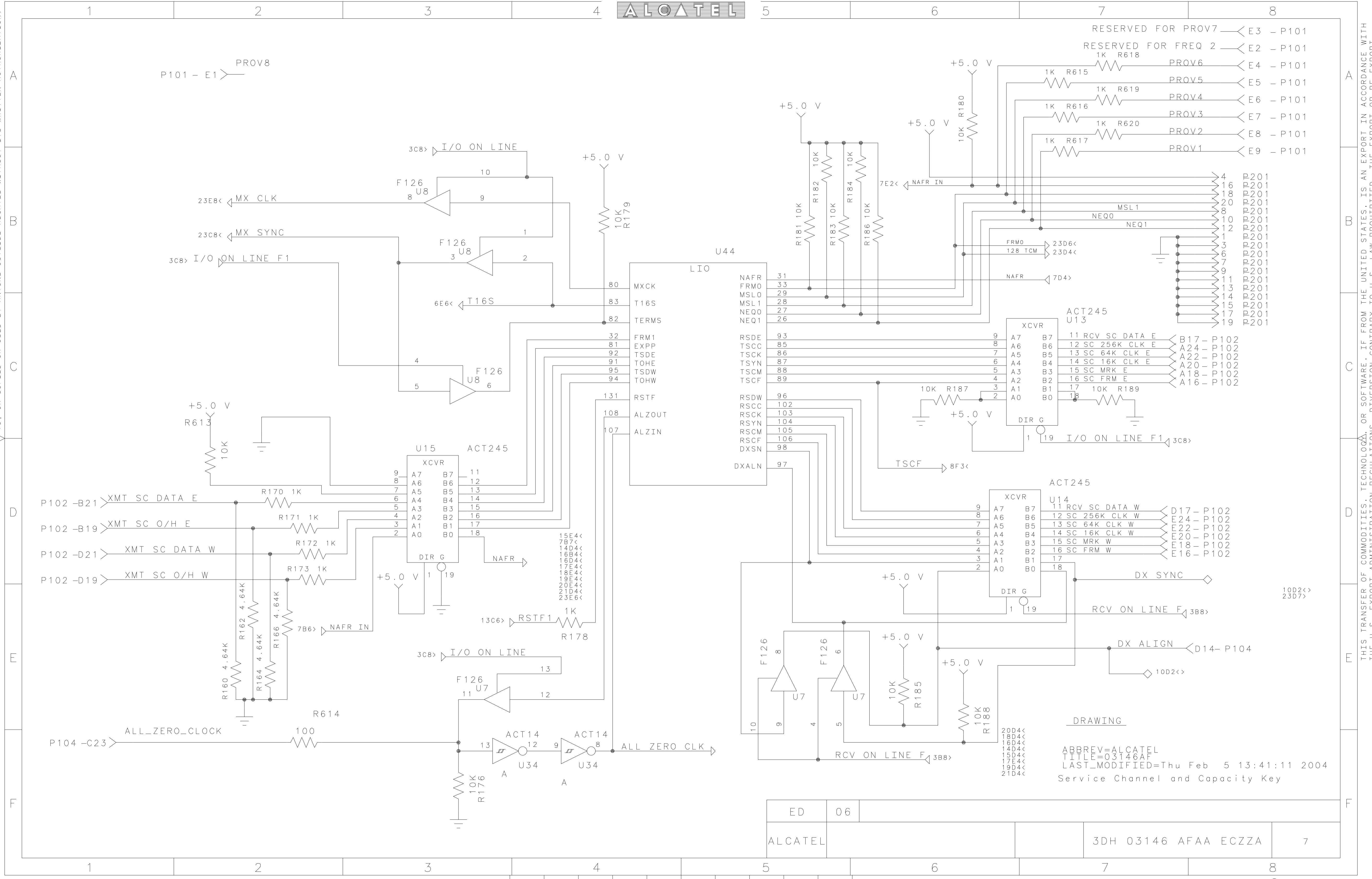

THIS TRANSFER OF COMMODITIES, TECHNOLOGY OR SOFTWARE, IF FROM THE UNITED STATES, IS AN EXPORT IN ACCORDANCE WITH THE U.S. EXPORT ADMINISTRATION REGULATIONS. DIVERSION CONTRARY TO U.S. LAW PROHIBITED. THE EXPORT OR RE-EXPORT (FURTHER TRANSFER) OF SUCH COMMODITIES, TECHNOLOGY, SOFTWARE, OR PRODUCTS MADE FROM SUCH TECHNOLOGY IS PROHIBITED WITHOUT PROPER AUTHORIZATION(S) FROM THE U.S. DEPARTMENT OF COMMERCE OR OTHER APPROPRIATE U.S. GOVERNMENT AGENCY(S).

ED	06			
ALCATEL			3DH 03146 AFAA ECZZA	7

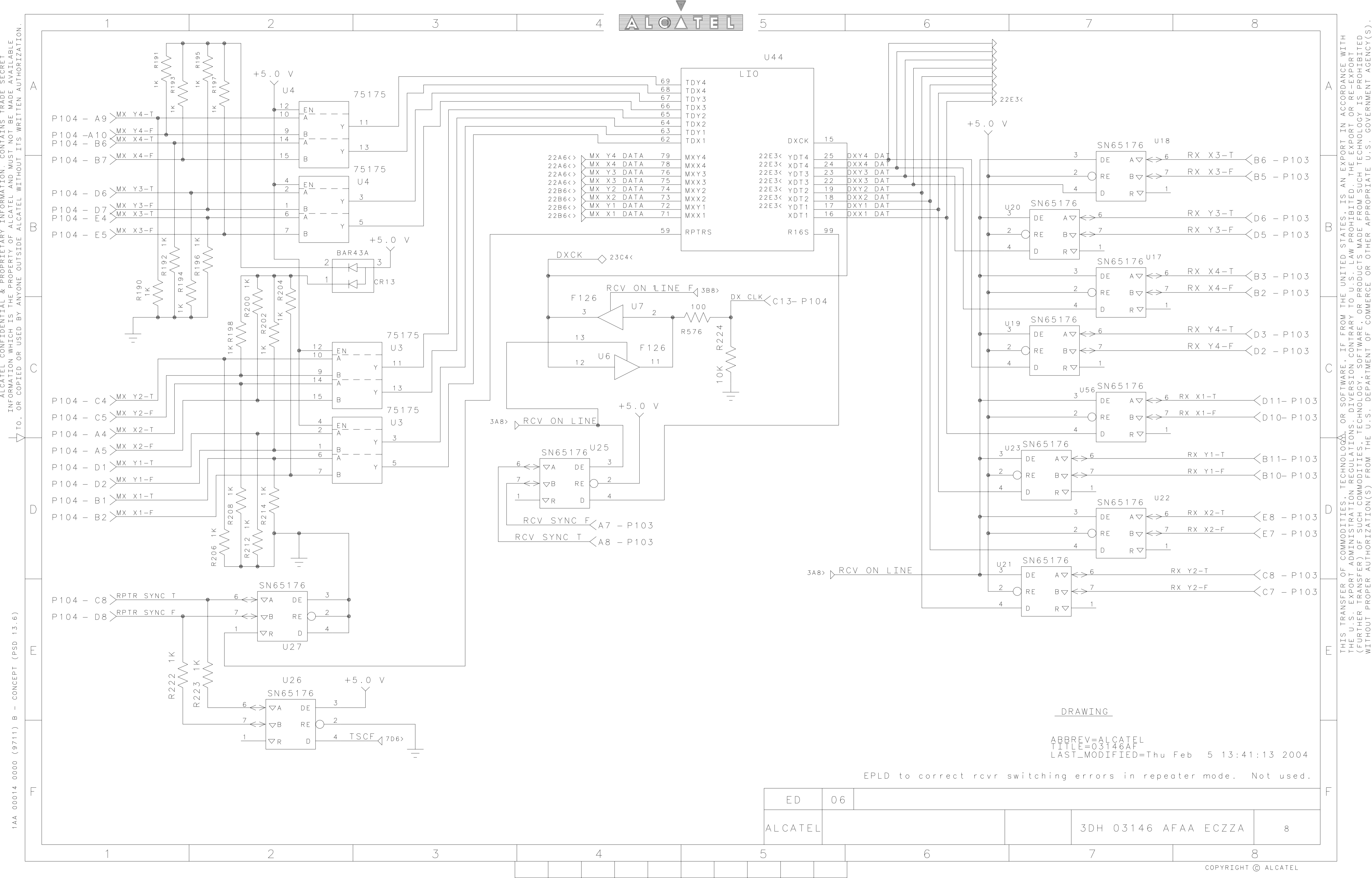

1AA 00014 0000 (9711) B - CONCEPT (PSD 13.6)
 ALCATEL CONFIDENTIAL & PROPRIETARY INFORMATION. CONTAINS TRADE SECRET INFORMATION WHICH IS THE PROPERTY OF ALCATEL AND MUST NOT BE MADE AVAILABLE TO, OR COPIED OR USED BY ANYONE OUTSIDE ALCATEL WITHOUT ITS WRITTEN AUTHORIZATION.

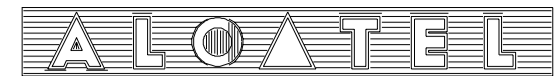

22A6<>	MX Y4 DATA	79	MXY4	22E3<	YDT4	25	DXY4 DAT
22A6<>	MX X4 DATA	78	MXX4	22E3<	XDT4	24	DX4 DAT
22A6<>	MX Y3 DATA	76	MXY3	22E3<	YDT3	23	DXY3 DAT
22A6<>	MX X3 DATA	75	MXX3	22E3<	XDT3	22	DX3 DAT
22B6<>	MX Y2 DATA	74	MXY2	22E3<	YDT2	19	DXY2 DAT
22B6<>	MX X2 DATA	73	MXX2	22E3<	XDT2	18	DX2 DAT
22B6<>	MX Y1 DATA	72	MXY1	22E3<	YDT1	17	DXY1 DAT
22B6<>	MX X1 DATA	71	MXX1	22E3<	XDT1	16	DX1 DAT
			RPTRS			99	R16S

DRAWING
 ABBREV=ALCATEL
 TITLE=03146AF
 LAST_MODIFIED=Thu Feb 5 13:41:13 2004

EPLD to correct rcvr switching errors in repeater mode. Not used.

ED	06			
ALCATEL		3DH 03146 AFAA ECZZA		8

THIS TRANSFER OF COMMODITIES, TECHNOLOGY, OR SOFTWARE, IF FROM THE UNITED STATES, IS AN EXPORT IN ACCORDANCE WITH THE U.S. EXPORT ADMINISTRATION REGULATIONS. DIVERSION CONTRARY TO U.S. LAW PROHIBITED. THE EXPORT OR RE-EXPORT (FURTHER TRANSFER) OF SUCH COMMODITIES, TECHNOLOGY, SOFTWARE, OR PRODUCTS MADE FROM SUCH TECHNOLOGY IS PROHIBITED WITHOUT PROPER AUTHORIZATION(S) FROM THE U.S. DEPARTMENT OF COMMERCE OR OTHER APPROPRIATE U.S. GOVERNMENT AGENCY(S).

1AA 00014 0000 (9711) B - CONCEPT (PSD 13.6)

1 2 3 4

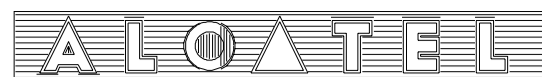

5 6 7 8

A

B

C

D

E

F

A

B

C

D

E

F

DRAWING

ABBREV=ALCATEL
TITLE=03146AF
LAST_MODIFIED=Mon Dec 22 14:35:27 CST 2003

EPLD to correct rcvr switching errors in repeater mode. Not used.

ED	06			
ALCATEL				3DH 03146 AFAA ECZZA
				9

1 2 3 4 5 6 7 8

THIS TRANSFER OF COMMODITIES, TECHNOLOGY, OR SOFTWARE, IF FROM THE UNITED STATES, IS AN EXPORT IN ACCORDANCE WITH THE U.S. EXPORT ADMINISTRATION REGULATIONS. DIVERSION CONTRARY TO U.S. LAW PROHIBITED. THE EXPORT OR RE-EXPORT (FURTHER TRANSFER) OF SUCH COMMODITIES, TECHNOLOGY, SOFTWARE, OR PRODUCTS MADE FROM SUCH TECHNOLOGY IS PROHIBITED WITHOUT PROPER AUTHORIZATION(S) FROM THE U.S. DEPARTMENT OF COMMERCE OR OTHER APPROPRIATE U.S. GOVERNMENT AGENCY(S).

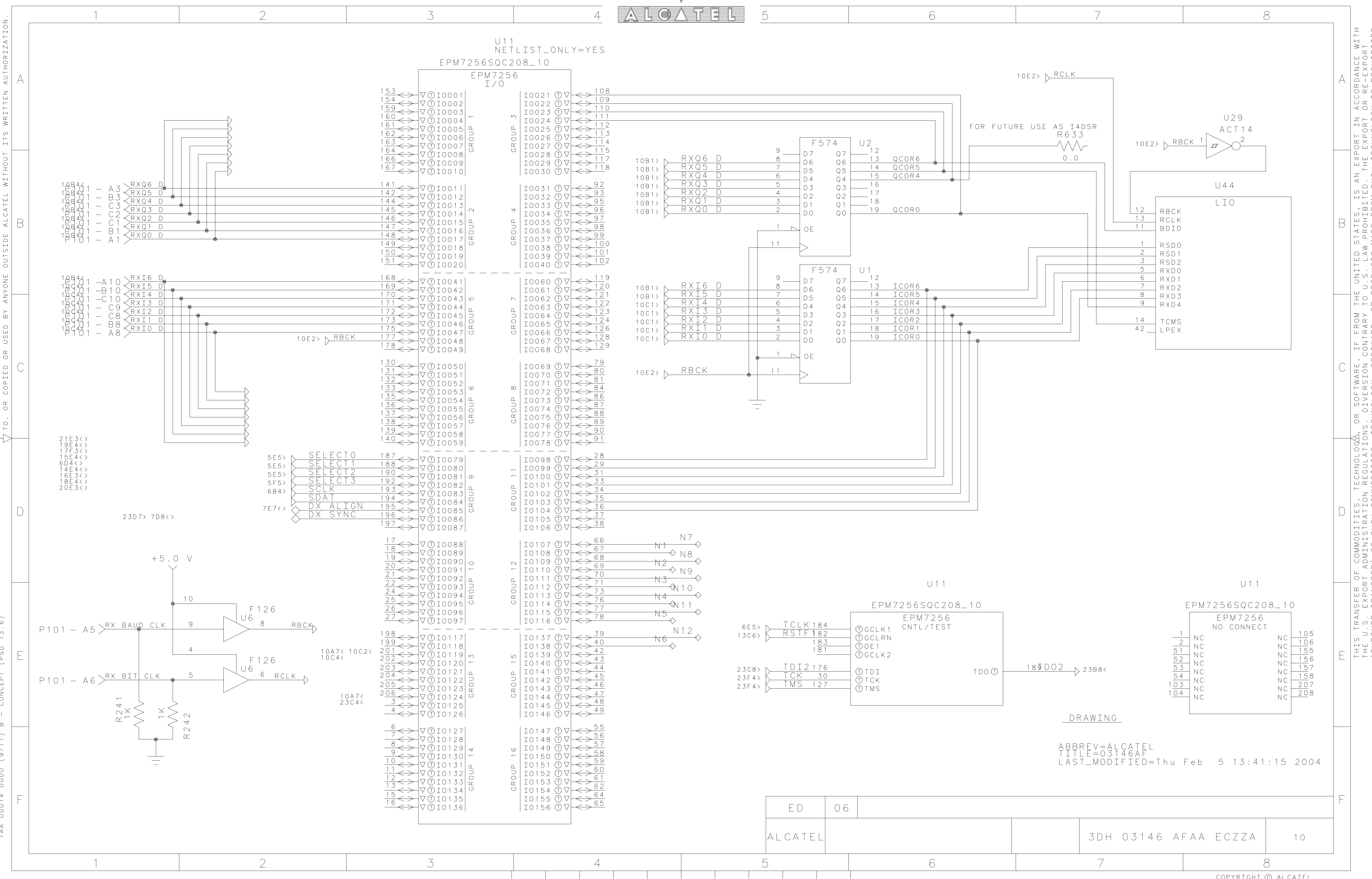

1AA 00014 0000 (9711) B - CONCEPT (PSD 13.6)

THIS TRANSFER OF COMMODITIES, TECHNOLOGY OR SOFTWARE, IF FROM THE UNITED STATES, IS AN EXPORT IN ACCORDANCE WITH THE U.S. EXPORT ADMINISTRATION REGULATIONS. DIVERSION CONTRARY TO U.S. LAW PROHIBITED. THE EXPORT OR RE-EXPORT (FURTHER TRANSFER) OF SUCH COMMODITIES, TECHNOLOGY, SOFTWARE, OR PRODUCTS MADE FROM SUCH TECHNOLOGY IS PROHIBITED WITHOUT PROPER AUTHORIZATION(S) FROM THE U.S. DEPARTMENT OF COMMERCE OR OTHER APPROPRIATE U.S. GOVERNMENT AGENCY(S).

ABBREV=ALCATEL
TITLE=03146AF
LAST_MODIFIED=Thu Feb 5 13:41:15 2004

ED	06			
ALCATEL		3DH 03146 AFAA ECZZA		10

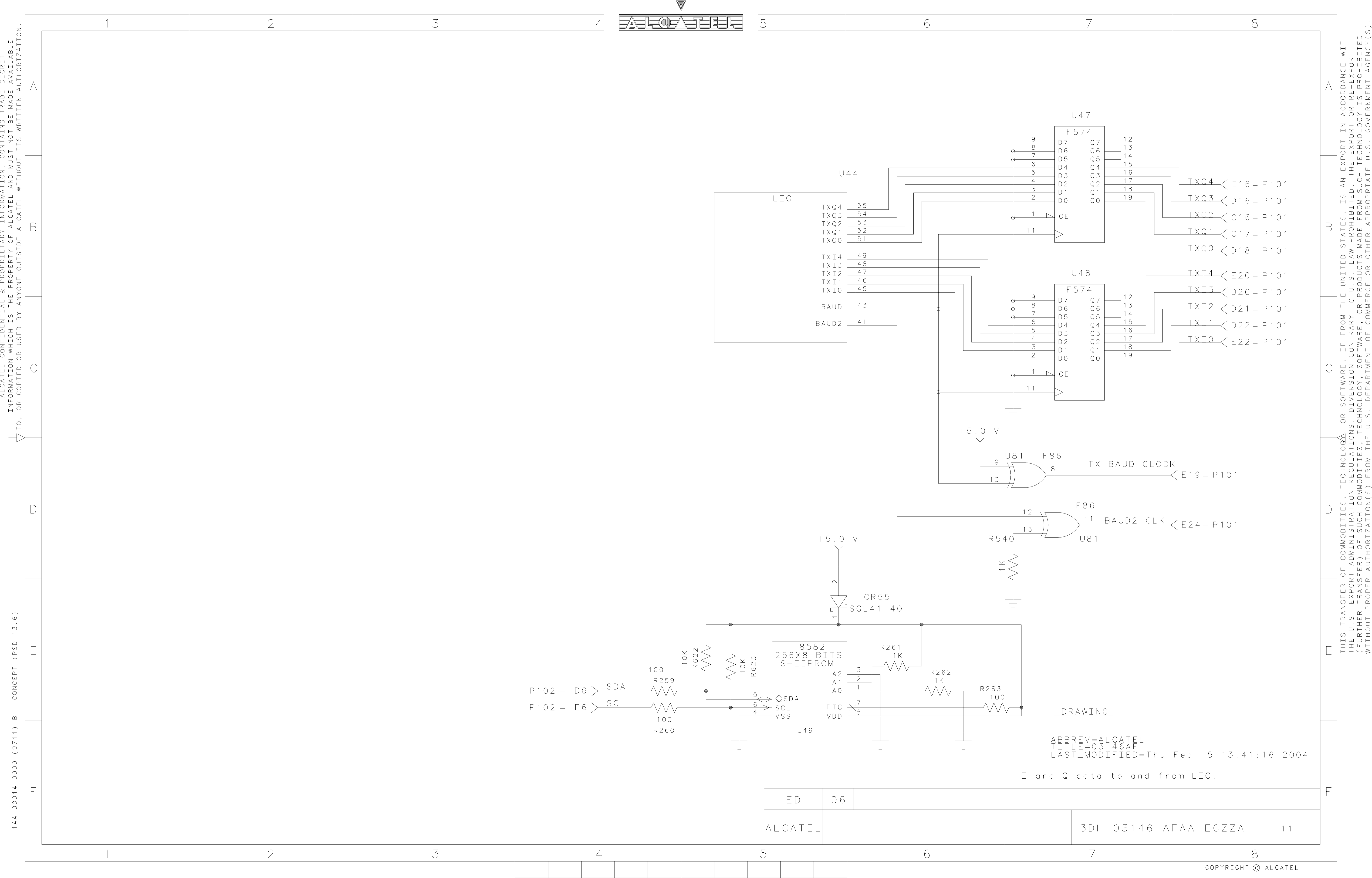

ABBREV=ALCATEL
 TITLE=03146AF
 LAST_MODIFIED=Thu Feb 5 13:41:16 2004

I and Q data to and from LIO.

ED	06			
ALCATEL			3DH 03146 AFAA ECZZA	11

1AA 00014 0000 (9711) B - CONCEPT (PSD 13.6)

THIS TRANSFER OF COMMODITIES, TECHNOLOGY, OR SOFTWARE, IF FROM THE UNITED STATES, IS AN EXPORT IN ACCORDANCE WITH THE U.S. EXPORT ADMINISTRATION REGULATIONS. DIVERSION CONTRARY TO U.S. LAW PROHIBITED. THE EXPORT OR RE-EXPORT (FURTHER TRANSFER) OF SUCH COMMODITIES, TECHNOLOGY, SOFTWARE, OR PRODUCTS MADE FROM SUCH TECHNOLOGY IS PROHIBITED WITHOUT PROPER AUTHORIZATION(S) FROM THE U.S. DEPARTMENT OF COMMERCE OR OTHER APPROPRIATE U.S. GOVERNMENT AGENCY(S).

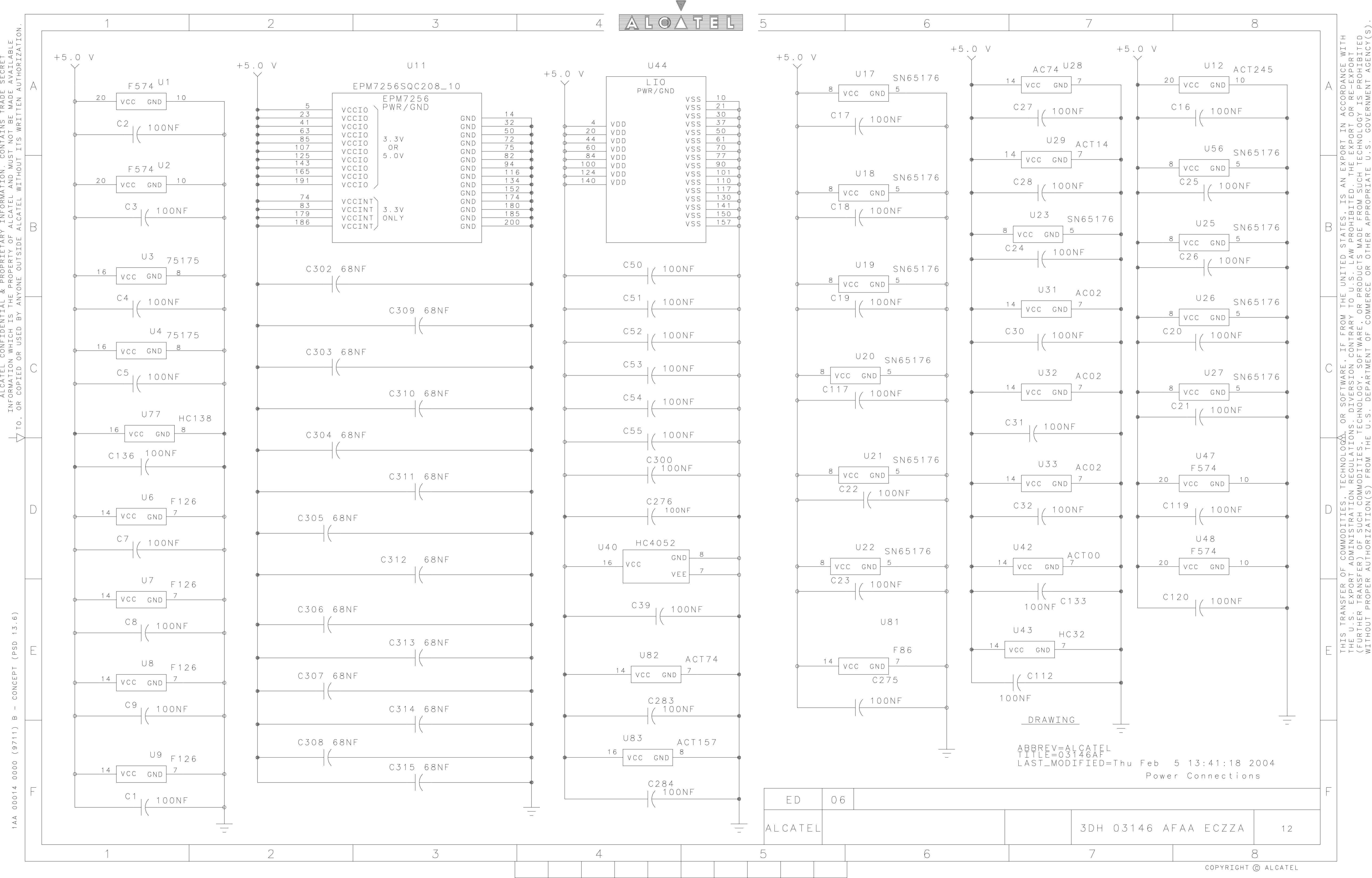

DRAWING
 ABBREV=ALCATEL
 TITLE=03146AF
 LAST_MODIFIED=Thu Feb 5 13:41:18 2004
 Power Connections

ED	06		
ALCATEL		3DH 03146 AFAA ECZZA	12

1AA 00014 0000 (9711) B - CONCEPT (PSD 13.6)

THIS TRANSFER OF COMMODITIES, TECHNOLOGY OR SOFTWARE, IF FROM THE UNITED STATES, IS AN EXPORT IN ACCORDANCE WITH THE U.S. EXPORT ADMINISTRATION REGULATIONS. DIVERSION CONTRARY TO U.S. LAW PROHIBITED. THE EXPORT OR RE-EXPORT (FURTHER TRANSFER) OF SUCH COMMODITIES, TECHNOLOGY, SOFTWARE, OR PRODUCTS MADE FROM SUCH TECHNOLOGY IS PROHIBITED WITHOUT PROPER AUTHORIZATION(S) FROM THE U.S. DEPARTMENT OF COMMERCE OR OTHER APPROPRIATE U.S. GOVERNMENT AGENCY(S).

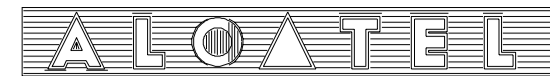
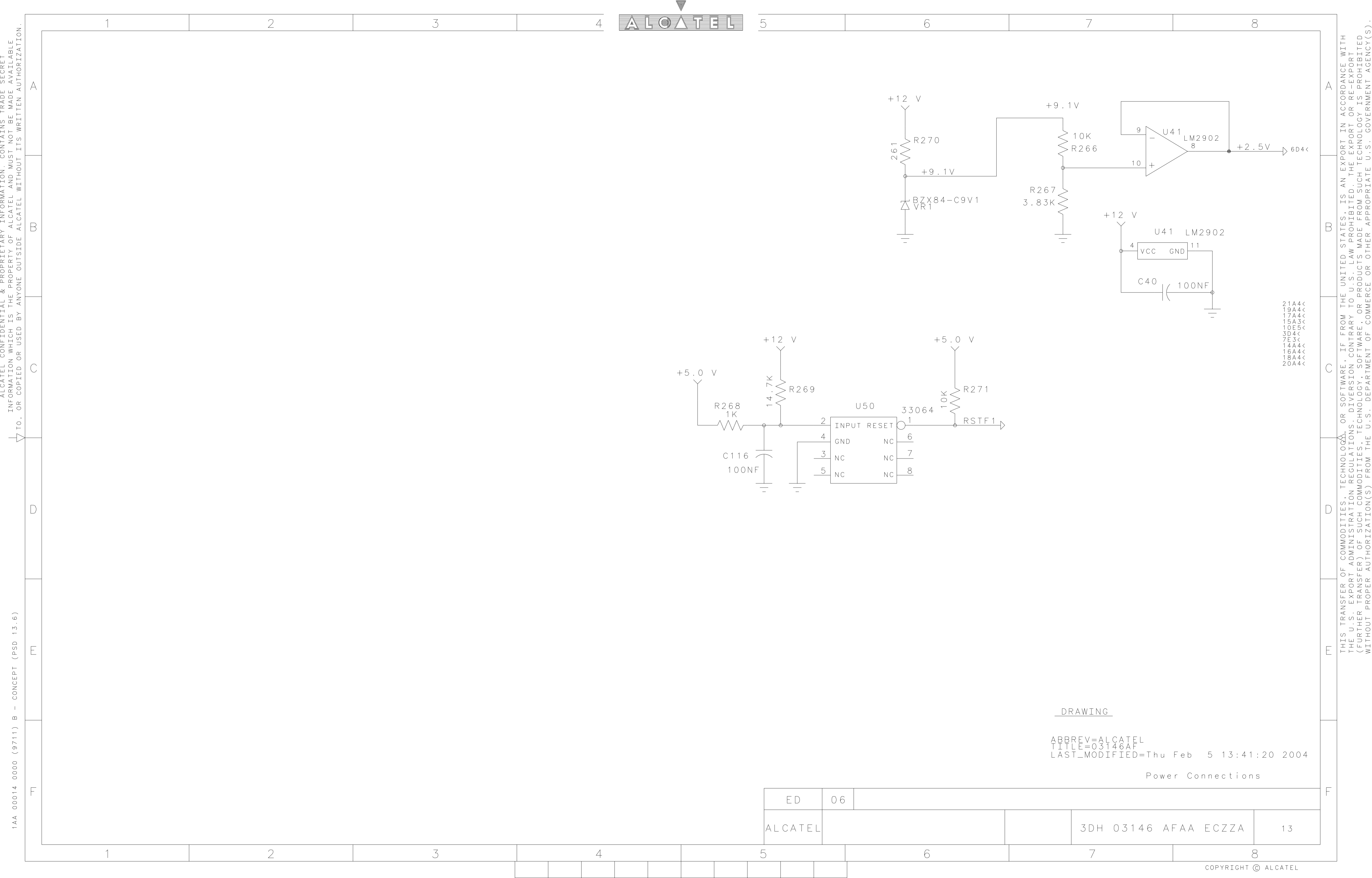

21A4<
19A4<
17A4<
15A3<
10E5<
3D4<
7E3<
14A4<
16A4<
18A4<
20A4<

DRAWING
ABBREV=ALCATEL
TITLE=03146AF
LAST_MODIFIED=Thu Feb 5 13:41:20 2004

Power Connections

ED	06			
ALCATEL			3DH 03146 AFAA ECZZA	13

1AA 00014 0000 (9711) B - CONCEPT (PSD 13.6)

ALCATEL CONFIDENTIAL & PROPRIETARY INFORMATION. CONTAINS TRADE SECRET INFORMATION WHICH IS THE PROPERTY OF ALCATEL AND MUST NOT BE MADE AVAILABLE TO, OR COPIED OR USED BY ANYONE OUTSIDE ALCATEL WITHOUT ITS WRITTEN AUTHORIZATION.

THIS TRANSFER OF COMMODITIES, TECHNOLOGY, OR SOFTWARE, IF FROM THE UNITED STATES, IS AN EXPORT IN ACCORDANCE WITH THE U.S. EXPORT ADMINISTRATION REGULATIONS. DIVERSION CONTRARY TO U.S. LAW PROHIBITED. THE EXPORT OR RE-EXPORT (FURTHER TRANSFER) OF SUCH COMMODITIES, TECHNOLOGY, SOFTWARE, OR PRODUCTS MADE FROM SUCH TECHNOLOGY IS PROHIBITED WITHOUT PROPER AUTHORIZATION(S) FROM THE U.S. DEPARTMENT OF COMMERCE OR OTHER APPROPRIATE U.S. GOVERNMENT AGENCY(S).

14A 00014 0000 (9711) B - CONCEPT (PSD 13.6)

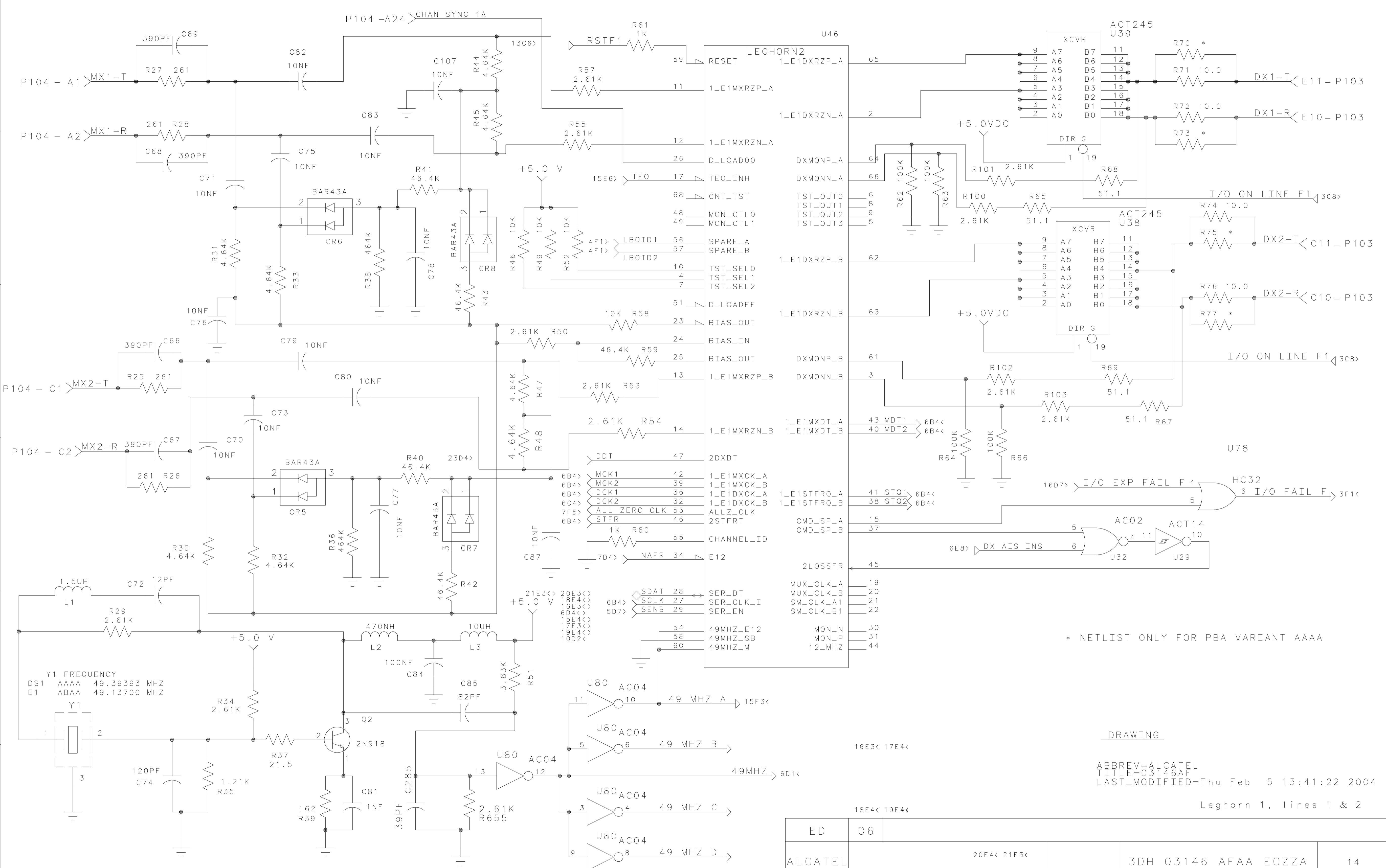

U46 LEGHORN2

RESET	65
1_E1MXRZP_A	11
1_E1DZRZP_A	2
1_E1MXRZN_A	12
D_LOAD00	26
DXMONP_A	64
DXMONN_A	66
TST_OUT0	6
TST_OUT1	8
TST_OUT2	9
TST_OUT3	5
1_E1DZRZP_B	62
1_E1DZRZB	63
DXMONP_B	61
DXMONN_B	3
1_E1MXDT_A	43
1_E1MXDT_B	40
2DXDT	47
1_E1MXCK_A	42
1_E1MXCK_B	39
1_E1DXCK_A	36
1_E1DXCK_B	32
ALLZ_CLK	53
2STFR	46
CHANNEL_ID	55
E12	34
SER_DT	28
SER_CLK_I	27
SER_EN	29
MON_N	30
MON_P	31
12_MHZ	44

* NETLIST ONLY FOR PBA VARIANT AAAA

DRAWING

ABBREV=ALCATEL
 TITLE=03146AF
 LAST_MODIFIED=Thu Feb 5 13:41:22 2004

Leghorn 1, lines 1 & 2

ED	06			
ALCATEL		20E4< 21E3<	3DH 03146 AFAA ECZZA	14

THIS TRANSFER OF COMMODITIES, TECHNOLOGY OR SOFTWARE, IF FROM THE UNITED STATES, IS AN EXPORT IN ACCORDANCE WITH THE U.S. EXPORT ADMINISTRATION REGULATIONS. DIVERSION CONTRARY TO U.S. LAW PROHIBITED. THE EXPORT OR RE-EXPORT (FURTHER TRANSFER) OF SUCH COMMODITIES, TECHNOLOGY, SOFTWARE, OR PRODUCTS MADE FROM SUCH TECHNOLOGY IS PROHIBITED WITHOUT PROPER AUTHORIZATION(S) FROM THE U.S. DEPARTMENT OF COMMERCE OR OTHER APPROPRIATE U.S. GOVERNMENT AGENCY(S).

1AA 00014 0000 (9711) B - CONCEPT (PSD 13.6)

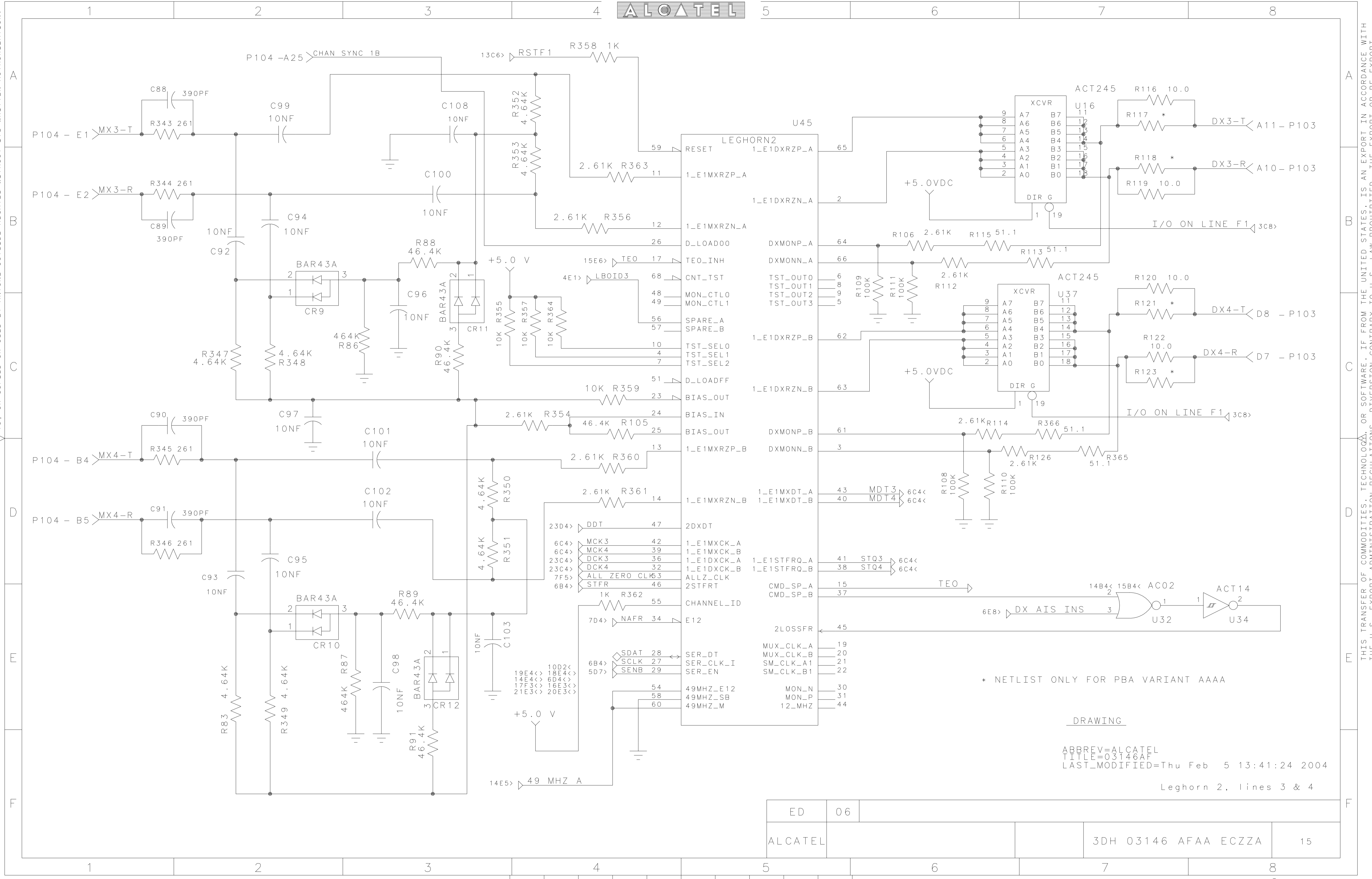

* NETLIST ONLY FOR PBA VARIANT AAAA

DRAWING

ABBREV=ALCATEL
TITLE=03146AF
LAST_MODIFIED=Thu Feb 5 13:41:24 2004

Leghorn 2, lines 3 & 4

ED	06		
ALCATEL		3DH 03146 AFAA ECZZA	15

THIS TRANSFER OF COMMODITIES, TECHNOLOGY OR SOFTWARE, IF FROM THE UNITED STATES, IS AN EXPORT IN ACCORDANCE WITH THE U.S. EXPORT ADMINISTRATION REGULATIONS. DIVERSION CONTRARY TO U.S. LAW PROHIBITED. THE EXPORT OR RE-EXPORT (FURTHER TRANSFER) OF SUCH COMMODITIES, TECHNOLOGY, SOFTWARE, OR PRODUCTS MADE FROM SUCH TECHNOLOGY IS PROHIBITED WITHOUT PROPER AUTHORIZATION(S) FROM THE U.S. DEPARTMENT OF COMMERCE OR OTHER APPROPRIATE U.S. GOVERNMENT AGENCY(S).

1AA 00014 0000 (9711) B - CONCEPT (PSD 13.6)

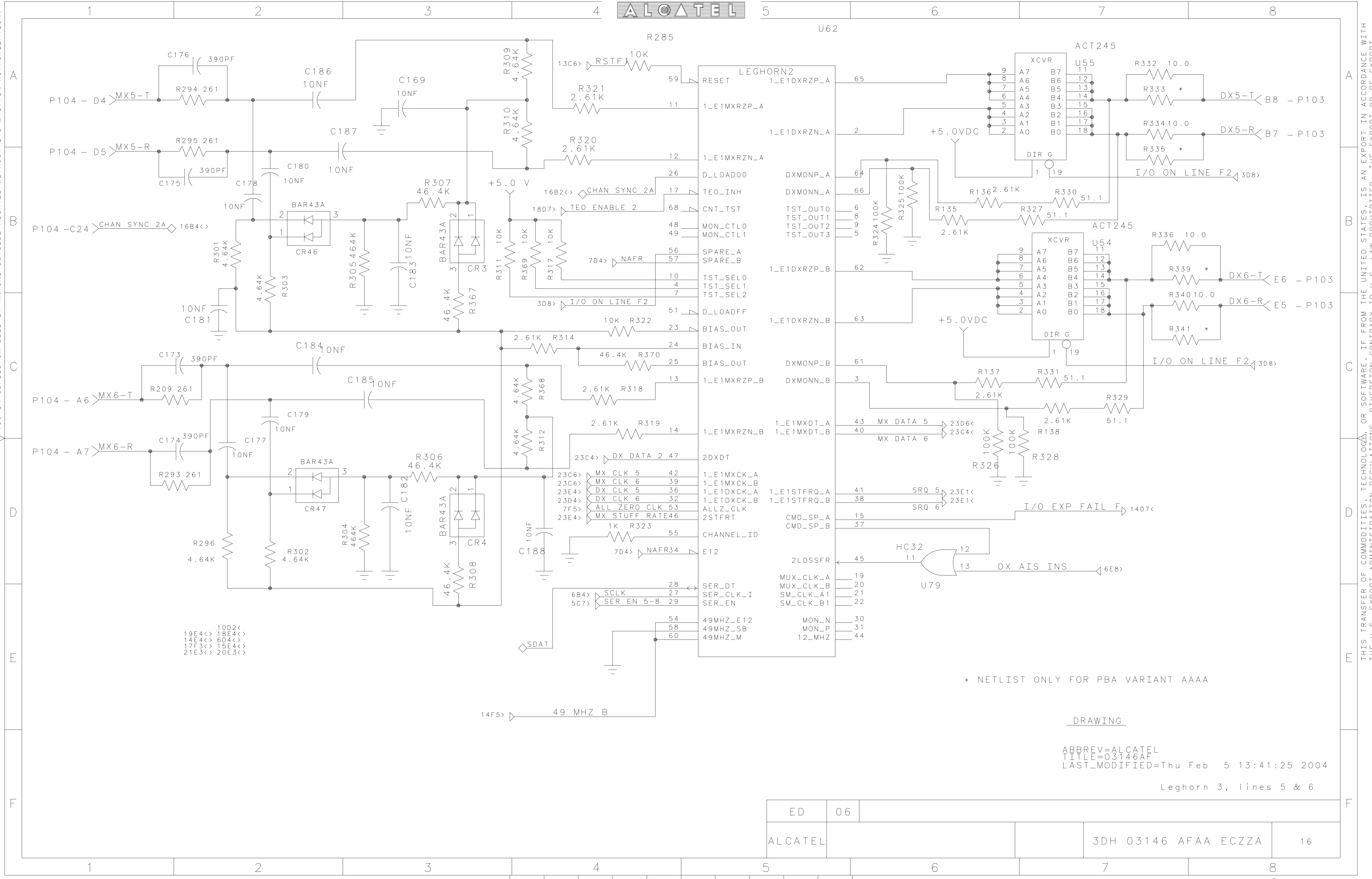

19E4<> 10D2<
 14E4<> 18E4<>
 17E3<> 6D4<>
 21E3<> 15E4<>
 20E3<>

* NETLIST ONLY FOR PBA VARIANT AAAA

DRAWING
 ABBREV=ALCATEL
 TITLE=03146AF
 LAST_MODIFIED=Thu Feb 5 13:41:25 2004
 Leghorn 3, lines 5 & 6

ED	06			
ALCATEL			3DH 03146 AFAA ECZZA	16

THIS TRANSFER OF COMMODITIES, TECHNOLOGY, OR SOFTWARE, IF FROM THE UNITED STATES, IS AN EXPORT IN ACCORDANCE WITH THE U.S. EXPORT ADMINISTRATION REGULATIONS. DIVERSION CONTRARY TO U.S. LAW PROHIBITED. THE EXPORT OR RE-EXPORT (FURTHER TRANSFER) OF SUCH COMMODITIES, TECHNOLOGY, SOFTWARE, OR PRODUCTS MADE FROM SUCH TECHNOLOGY IS PROHIBITED WITHOUT PROPER AUTHORIZATION(S) FROM THE U.S. DEPARTMENT OF COMMERCE OR OTHER APPROPRIATE U.S. GOVERNMENT AGENCY(S).