

# TEST REPORT

## CERTIFICATE OF CONFORMITY

**Standard:** 47 CFR FCC Part 15, Subpart C (Section 15.247)  
**Report No.:** RFBERD-WTW-P23120358-1  
**FCC ID:** JEH7748AX5  
**Product:** AX5  
**Brand:** NCR Voyix  
**Model No.:** 7748  
**Received Date:** 2023/12/15  
**Test Date:** 2023/12/25 ~ 2024/1/8  
**Issued Date:** 2024/2/1

**Applicant:** NCR Voyix Corporation  
**Address:** 864 Spring Street NW, Atlanta GA 30308, USA  
**Issued By:** Bureau Veritas Consumer Products Services (H.K.) Ltd., Taoyuan Branch  
Lin Kou Laboratories  
**Lab Address:** No. 47-2, 14th Ling, Chia Pau Vil., Lin Kou Dist., New Taipei City, Taiwan  
**Test Location:** No. 19, Hwa Ya 2nd Rd., Wen Hwa Vil., Kewi Shan Dist., Taoyuan City 33383, Taiwan  
**FCC Registration /** 788550 / TW0003  
**Designation Number:**

Approved by: \_\_\_\_\_

*Jeremy Lin*

, Date: \_\_\_\_\_

2024/2/1

Jeremy Lin / Project Engineer

This test report consists of 43 pages in total. It may be duplicated completely for legal use with the approval of the applicant. It should not be reproduced except in full, without the written approval of our laboratory. The test results in the report only apply to the tested sample. The test results in this report are traceable to the national or international standards.

Prepared by : Vera Huang / Specialist



This report is governed by, and incorporates by reference, the Conditions of Testing as posted at the date of issuance of this report at <http://www.bureauveritas.com/home/about-us/our-business/cps/about-us/terms-conditions/> and is intended for your exclusive use. Any copying or replication of this report to or for any other person or entity, or use of our name or trademark, is permitted only with our prior written permission. This report sets forth our findings solely with respect to the test samples identified herein. The results set forth in this report are not indicative or representative of the quality or characteristics of the lot from which a test sample was taken or any similar or identical product unless specifically and expressly noted. Our report includes all of the tests requested by you and the results thereof based upon the information that you provided to us. Measurement uncertainty is only provided upon request for accredited tests. Statements of conformity are based on simple acceptance criteria without taking measurement uncertainty into account, unless otherwise requested in writing. You have 60 days from date of issuance of this report to notify us of any material error or omission caused by our negligence or if you require measurement uncertainty; provided, however, that such notice shall be in writing and shall specifically address the issue you wish to raise. A failure to raise such issue within the prescribed time shall constitute your unqualified acceptance of the completeness of this report, the tests conducted and the correctness of the report contents.

## Table of Contents

<b>Release Control Record .....</b>	<b>4</b>
<b>1 Certificate.....</b>	<b>5</b>
<b>2 Summary of Test Results .....</b>	<b>6</b>
2.1 Measurement Uncertainty .....	6
2.2 Supplementary Information .....	6
<b>3 General Information .....</b>	<b>7</b>
3.1 General Description .....	7
3.2 Antenna Description of EUT .....	8
3.3 Channel List.....	8
3.4 Test Mode Applicability and Tested Channel Detail.....	8
3.5 Duty Cycle of Test Signal.....	9
3.6 Test Program Used and Operation Descriptions .....	10
3.7 Connection Diagram of EUT and Peripheral Devices .....	10
3.8 Configuration of Peripheral Devices and Cable Connections .....	10
<b>4 Test Instruments .....</b>	<b>11</b>
4.1 RF Output Power .....	11
4.2 Power Spectral Density .....	11
4.3 6 dB Bandwidth .....	11
4.4 Conducted Out of Band Emissions .....	11
4.5 AC Power Conducted Emissions .....	12
4.6 Unwanted Emissions below 1 GHz .....	13
4.7 Unwanted Emissions above 1 GHz.....	14
<b>5 Limits of Test Items.....</b>	<b>15</b>
5.1 RF Output Power .....	15
5.2 Power Spectral Density .....	15
5.3 6 dB Bandwidth .....	15
5.4 Conducted Out of Band Emissions .....	15
5.5 AC Power Conducted Emissions .....	15
5.6 Unwanted Emissions below 1 GHz .....	16
5.7 Unwanted Emissions above 1 GHz.....	16
<b>6 Test Arrangements.....</b>	<b>17</b>
6.1 RF Output Power .....	17
6.1.1 Test Setup .....	17
6.1.2 Test Procedure.....	17
6.2 Power Spectral Density .....	17
6.2.1 Test Setup .....	17
6.2.2 Test Procedure.....	17
6.3 6 dB Bandwidth .....	18
6.3.1 Test Setup .....	18
6.3.2 Test Procedure.....	18
6.4 Conducted Out of Band Emissions .....	18
6.4.1 Test Setup .....	18
6.4.2 Test Procedure.....	18
6.5 AC Power Conducted Emissions .....	19
6.5.1 Test Setup .....	19
6.5.2 Test Procedure.....	19
6.6 Unwanted Emissions below 1 GHz .....	20
6.6.1 Test Setup .....	20
6.6.2 Test Procedure.....	21
6.7 Unwanted Emissions above 1 GHz.....	22
6.7.1 Test Setup .....	22
6.7.2 Test Procedure.....	22
<b>7 Test Results of Test Item .....</b>	<b>23</b>



7.1	RF Output Power .....	23
7.2	Power Spectral Density .....	24
7.3	6 dB Bandwidth .....	25
7.4	Conducted Out of Band Emissions .....	26
7.5	AC Power Conducted Emissions .....	28
7.6	Unwanted Emissions below 1 GHz .....	30
7.7	Unwanted Emissions above 1 GHz.....	32
<b>8</b>	<b>Pictures of Test Arrangements .....</b>	<b>42</b>
<b>9</b>	<b>Information of the Testing Laboratories .....</b>	<b>43</b>



## Release Control Record

Issue No.	Description	Date Issued
RFBERD-WTW-P23120358-1	Original Release	2024/2/1

## 1 Certificate

**Product:** AX5

**Brand:** NCR Voyix

**Test Model:** 7748

**Sample Status:** Engineering sample

**Applicant:** NCR Voyix Corporation

**Test Date:** 2023/12/25 ~ 2024/1/8

**Standard:** 47 CFR FCC Part 15, Subpart C (Section 15.247)

**Measurement** ANSI C63.10-2013

**procedure:** KDB 558074 D01 15.247 Meas Guidance v05r02

The above equipment has been tested by **Bureau Veritas Consumer Products Services (H.K.) Ltd., Taoyuan Branch**, and found compliance with the requirement of the above standards. The test record, data evaluation & Equipment Under Test (EUT) configurations represented herein are true and accurate accounts of the measurements of the sample's RF characteristics under the conditions specified in this report.

## 2 Summary of Test Results

47 CFR FCC Part 15, Subpart C (Section 15.247)			
Standard / Clause	Test Item	Result	Remark
15.247(b)	RF Output Power	Pass	Meet the requirement of limit.
15.247(e)	Power Spectral Density	Pass	Meet the requirement of limit.
15.247(a)(2)	6 dB Bandwidth	Pass	Meet the requirement of limit.
15.247(d)	Conducted Out of Band Emissions	Pass	Meet the requirement of limit.
15.207	AC Power Conducted Emissions	Pass	Minimum passing margin is -7.14 dB at 0.43370 MHz
15.205 / 15.209 / 15.247(d)	Unwanted Emissions below 1 GHz	Pass	Minimum passing margin is -5.9 dB at 419.94 MHz
15.205 / 15.209 / 15.247(d)	Unwanted Emissions above 1 GHz	Pass	Minimum passing margin is -5.6 dB at 2483.50 MHz
15.203	Antenna Requirement	Pass	Antenna connector is ipex(MHF) not a standard connector.

Note: Determining compliance based on the results of the compliance measurement, not taking into account measurement instrumentation uncertainty.

### 2.1 Measurement Uncertainty

Where relevant, the following measurement uncertainty levels have been estimated for tests performed on the EUT as specified in CISPR 16-4-2:

Measurement	Specification	Expanded Uncertainty (k=2) (±)
RF Output Power	-	1.371 dB
Power Spectral Density	-	1.017 dB
6 dB Bandwidth	-	206.5 Hz
Conducted Out of Band Emissions	9 kHz ~ 40 GHz	2.79 dB
AC Power Conducted Emissions	9 kHz ~ 30 MHz	2.88 dB
Unwanted Emissions below 1 GHz	9 kHz ~ 30 MHz	2.44 dB
	30 MHz ~ 1 GHz	2.95 dB
Unwanted Emissions above 1 GHz	1 GHz ~ 18 GHz	2.26 dB
	18 GHz ~ 40 GHz	1.94 dB

The other instruments specified are routine verified to remain within the calibrated levels, no measurement uncertainty is required to be calculated.

### 2.2 Supplementary Information

There is not any deviation from the test standards for the test method, and no modifications required for compliance.

### 3 General Information

#### 3.1 General Description

Product	AX5
Brand	NCR Voyix
Test Model	7748
Status of EUT	Engineering sample
Power Supply Rating	Refer to Note as below
Modulation Type	GFSK
Modulation Technology	DTS
Transfer Rate	Up to 2 Mbps
Operating Frequency	2.402 GHz ~ 2.48 GHz
Number of Channel	40
Output Power	Bluetooth LE 1M: 1.832 mW (2.63 dBm) Bluetooth LE 2M: 1.923 mW (2.84 dBm)

Note:

1. The EUT uses following accessories.

CPU		
Brand	Model	
Qualcomm	QCS5430	
BT/WLAN Module		
Brand		
Qualcomm WCN6750		
AC Adapter		
Brand	Model	Specification
FSP	FSP150-A24C14	AC Input : 100-240V, 2A , 50-60Hz DC Output : 24V , 6.25A
Power cord		
Brand	Model	Signal Line
N/A	N/A	3m
Type C to Type C cable		
Brand	Model	
N/A	N/A	

2. The above EUT information is declared by manufacturer and for more detailed features description, please refer to the manufacturer's specifications or User's Manual.

### 3.2 Antenna Description of EUT

1. The antenna information is listed as below.

Ant. No.	RF Chain No.	Antenna Net Gain (dBi)	Frequency	Antenna Type	Connector Type
1	0	1.2	2400MHz	PIFA	ipex(MHF)
1	0	1.2	2450MHz	PIFA	ipex(MHF)
1	0	1.3	2500MHz	PIFA	ipex(MHF)
2	1	1.1	2400MHz	PIFA	ipex(MHF)
2	1	0.8	2450MHz	PIFA	ipex(MHF)
2	1	0.6	2500MHz	PIFA	ipex(MHF)

\* Only chain 1 support BT function.

\* Detail antenna specification please refer to antenna datasheet and/or antenna measurement report.

### 3.3 Channel List

40 channels are provided for BT-LE:

Channel	Frequency (MHz)	Channel	Frequency (MHz)	Channel	Frequency (MHz)	Channel	Frequency (MHz)
0	2402	10	2422	20	2442	30	2462
1	2404	11	2424	21	2444	31	2464
2	2406	12	2426	22	2446	32	2466
3	2408	13	2428	23	2448	33	2468
4	2410	14	2430	24	2450	34	2470
5	2412	15	2432	25	2452	35	2472
6	2414	16	2434	26	2454	36	2474
7	2416	17	2436	27	2456	37	2476
8	2418	18	2438	28	2458	38	2478
9	2420	19	2440	29	2460	39	2480

### 3.4 Test Mode Applicability and Tested Channel Detail

Pre-Scan:	The EUT is designed to be positioned on the X-axis only.
-----------	--

Following channel(s) was (were) selected for the final test as listed below:

Test Item	Mode	Tested Channel	Modulation	Data Rate Parameter
RF Output Power / Power Spectral Density	BT-LE 1M	0, 19, 39	GFSK	1Mb/s
	BT-LE 2M	0, 19, 39	GFSK	2Mb/s
6 dB Bandwidth / Conducted Out of Band Emissions	BT-LE 1M	0, 19, 39	GFSK	1Mb/s
	BT-LE 2M	0, 19, 39	GFSK	2Mb/s
AC Power Conducted Emissions	BT-LE 2M	19	GFSK	2Mb/s
Unwanted Emissions below 1 GHz	BT-LE 2M	19	GFSK	2Mb/s
Unwanted Emissions above 1 GHz	BT-LE 1M	0, 19, 39	GFSK	1Mb/s
	BT-LE 2M	0, 19, 39	GFSK	2Mb/s



### 3.5 Duty Cycle of Test Signal

**BT-LE 1M:** Duty cycle = 0.396 ms / 0.624 ms x 100% = 63.5%, duty factor = 10 \* log (1/Duty cycle) = 1.97 dB

**BT-LE 2M:** Duty cycle = 0.213 ms / 0.624 ms x 100% = 34.1%, duty factor = 10 \* log (1/Duty cycle) = 4.67 dB

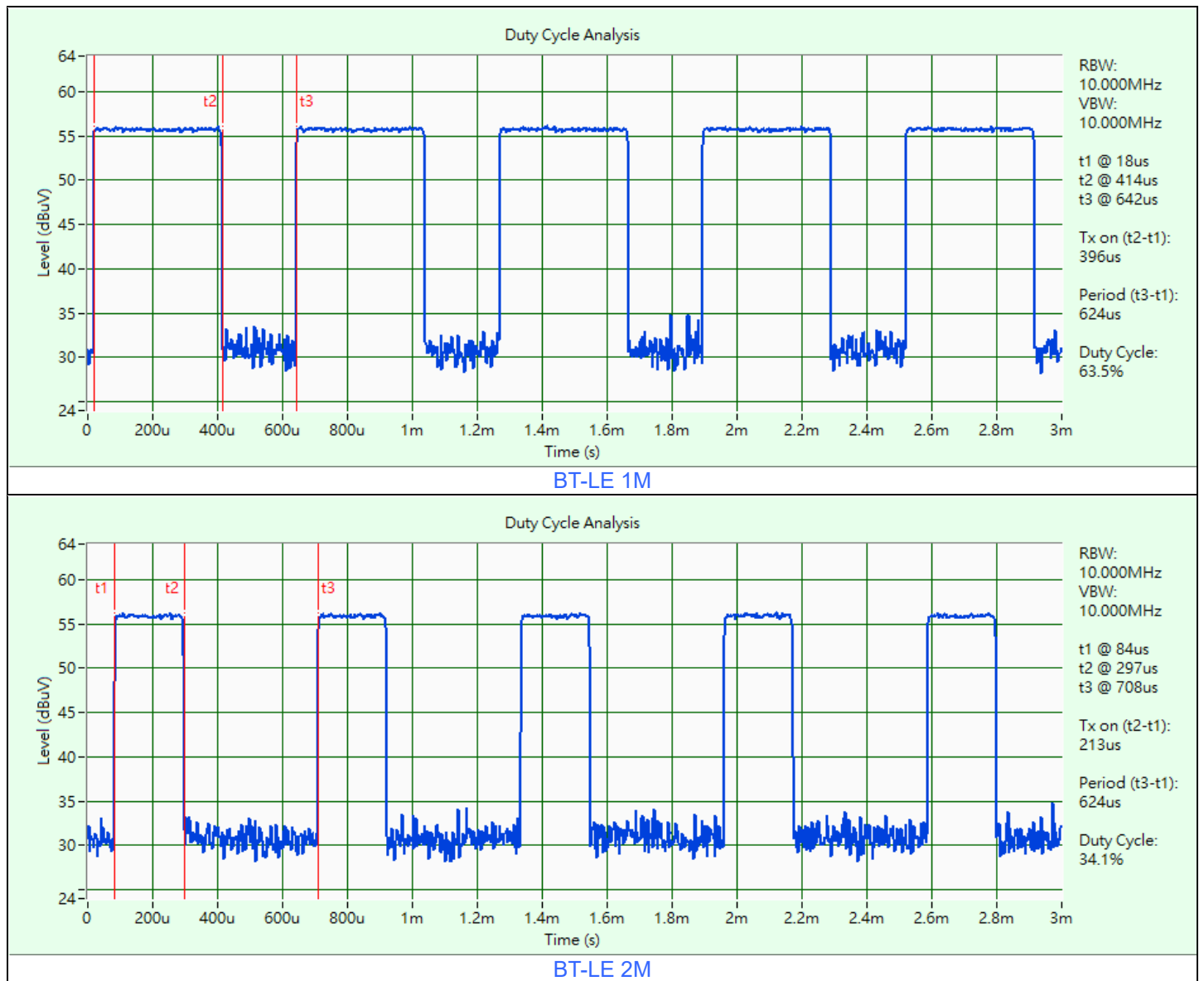

### 3.6 Test Program Used and Operation Descriptions

Controlling software QRCT\_4.0.209.0 has been activated to set the EUT under transmission condition continuously at specific channel frequency.

### 3.7 Connection Diagram of EUT and Peripheral Devices

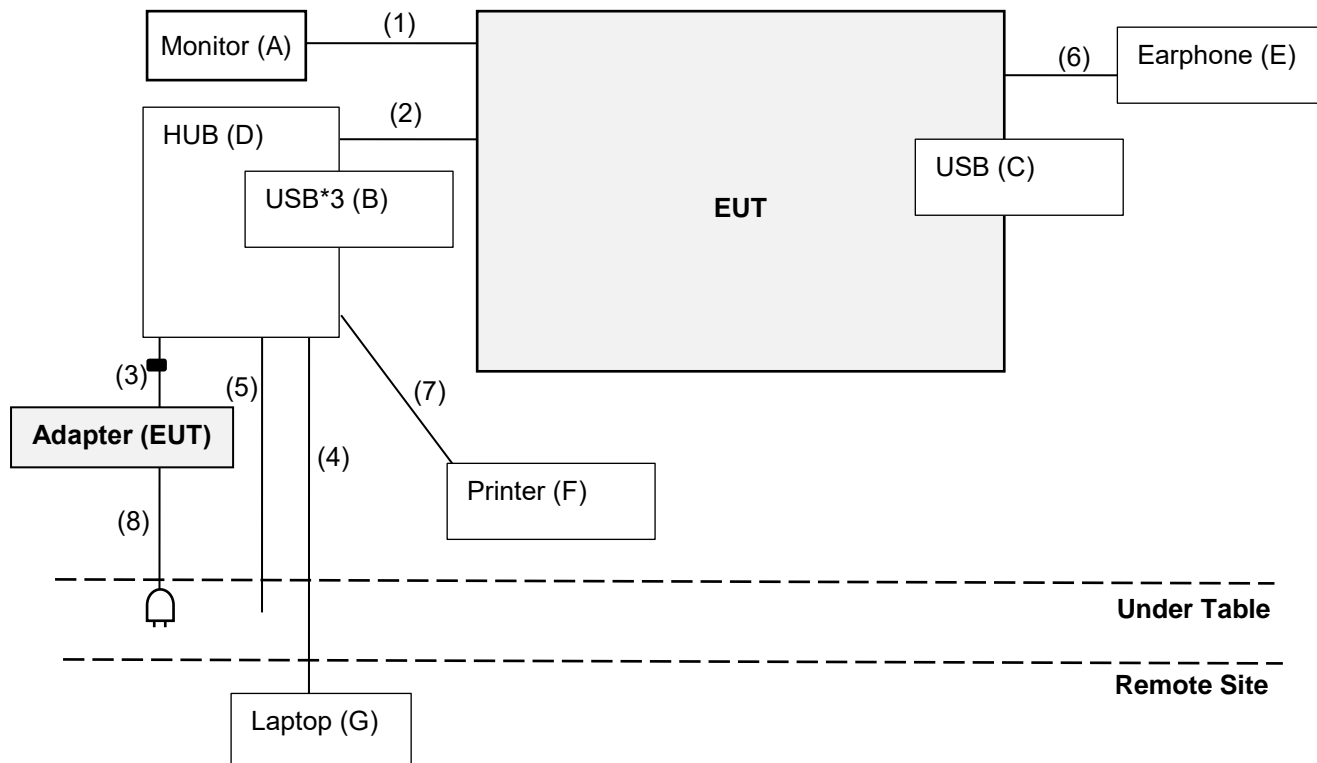

### 3.8 Configuration of Peripheral Devices and Cable Connections

ID	Product	Brand	Model No.	Serial No.	FCC ID	Remarks
A.	Monitor	NCR	1607-0000-9090	N/A	N/A	Supplied by applicant
B.	USB*3	SanDisk	SDDDC3-032G	N/A	N/A	Provided by Lab
C.	USB	SanDisk	SDDDC3-032G	N/A	N/A	Provided by Lab
D.	HUB	N/A	N/A	N/A	N/A	Supplied by applicant
E.	Earphone	APPLE	MB77PFEB	N/A	N/A	Provided by Lab
F.	Printer	NCR	N/A	N/A	N/A	Supplied by applicant
G.	Laptop	Lenovo	L440	R9-0GFJJK	N/A	Provided by Lab

No.	Cable Descriptions	Qty.	Length (m)	Shielded (Yes/ No)	Cores (Qty.)	Remark
1.	Type-C Cable	1	1.5	Yes	0	Supplied by applicant
2.	Type C to Type C cable	1	2	Yes	0	Accessory of EUT
3.	DC Cable	1	1.5	Y	1	Accessory of EUT
4.	RJ45 Cable	1	10	N	0	Provided by Lab
5.	RJ11 Cable	1	1.5	N	0	Supplied by applicant
6.	Audio Cable	1	1.2	N	0	Provided by Lab
7.	Type-B Cable	1	1	Yes	0	Supplied by applicant
8.	AC Cable	1	3	N	0	Supplied by applicant

## 4 Test Instruments

The calibration interval of the all test instruments are 12 months and the calibrations are traceable to NML/ROC and NIST/USA.

### 4.1 RF Output Power

Description Manufacturer	Model No.	Serial No.	Calibrated Date	Calibrated Until
Peak Power Analyzer Keysight	8990B	MY51000485	2023/1/19	2024/1/18
Wideband Power Sensor Keysight	N1923A	MY58020002	2023/1/18	2024/1/17
		MY58140009	2023/1/18	2024/1/17

Notes:

1. The test was performed in Oven room.
2. Tested Date: 2024/1/8

### 4.2 Power Spectral Density

Description Manufacturer	Model No.	Serial No.	Calibrated Date	Calibrated Until
Signal & Spectrum Analyzer R&S	FSV3044	101504	2023/6/5	2024/6/4
Software BV	ADT_RF Test Software V7.6.5.4	N/A	N/A	N/A

Notes:

1. The test was performed in Oven room.
2. Tested Date: 2024/1/8

### 4.3 6 dB Bandwidth

Refer to section 4.2 to get information of the instruments.

### 4.4 Conducted Out of Band Emissions

Refer to section 4.2 to get information of the instruments.

#### 4.5 AC Power Conducted Emissions

Description Manufacturer	Model No.	Serial No.	Calibrated Date	Calibrated Until
50 ohm terminal resistance HUBER+SUHNER	E1-011276	01	2023/2/1	2024/1/31
	E1-011312	10	2023/1/30	2024/1/29
	E1-011591	17	2023/2/1	2024/1/31
DC-LISN Schwarzbeck	NNBM 8126G	8126G-069	2023/11/7	2024/11/6
EMI Test Receiver R&S	ESR3	102783	2023/12/13	2024/12/12
Fixed Attenuator SGH	BNC10W10dB	PAD-COND2-01	2023/9/2	2024/9/1
LISN R&S	ESH2-Z5	100100	2023/3/7	2024/3/6
	ESH3-Z5	100312	2023/9/12	2024/9/11
RF Coaxial Cable Woken	5D-FB	Cable-cond2-01	2023/9/2	2024/9/1
Software BVADT	BVADT_Cond_ V7.3.7.4	N/A	N/A	N/A
V-LISN Schwarzbeck	NNBL 8226-2	8226-142	2023/8/31	2024/8/30

Notes:

1. The test was performed in HY - Conduction 2.
2. Tested Date: 2023/12/28

#### 4.6 Unwanted Emissions below 1 GHz

Description Manufacturer	Model No.	Serial No.	Calibrated Date	Calibrated Until
Antenna Tower & Turn Max-Full	MFA-440H	AT93021705	N/A	N/A
Bi_Log Antenna Schwarzbeck	VULB 9168	9168-472	2023/10/16	2024/10/15
EXA Signal Analyzer Agilent	N9010A	MY52220207	2023/1/3	2024/1/2
Loop Antenna Electro-Metrics	EM-6879	269	2023/9/23	2024/9/22
Loop Antenna TESEQ	HLA 6121	45745	2023/8/8	2024/8/7
MXE EMI Receiver Keysight	N9038A	MY55420137	2023/5/3	2024/5/2
Preamplifier EMCI	EMC 330H	980112	2023/9/27	2024/9/26
	EMC001340	980201	2023/9/27	2024/9/26
RF Coaxial Cable EMCI	5D-NM-BM	140903+140902	2023/1/7	2024/1/6
RF Coaxial Cable Woken	8D-FB	Cable-Ch10-01	2023/9/27	2024/9/26
Software BV ADT	ADT_Radiated_ V7.6.15.9.5	N/A	N/A	N/A
Turn Table Max-Full	MFT-201SS	N/A	N/A	N/A
Turn Table Controller Max-Full	MG-7802	N/A	N/A	N/A

Notes:

1. The test was performed in HY - 966 chamber 5.
2. Tested Date: 2023/12/27

#### 4.7 Unwanted Emissions above 1 GHz

Description Manufacturer	Model No.	Serial No.	Calibrated Date	Calibrated Until
Antenna Tower & Turn Max-Full	MFA-440H	AT93021705	N/A	N/A
Boresight antenna tower fixture BV	BAF-02	7	N/A	N/A
EXA Signal Analyzer Agilent	N9010A	MY52220207	2023/1/3	2024/1/2
Horn Antenna Schwarzbeck	BBHA 9120D	9120D-969	2023/11/12	2024/11/11
	BBHA 9170	148	2023/11/12	2024/11/11
MXE EMI Receiver Keysight	N9038A	MY55420137	2023/5/3	2024/5/2
Notch Filter Micro-Tronics	BRM17690	004	2023/1/11	2024/1/10
	BRM50716	060	2023/12/25	2024/12/24
Preamplifier EMCI	EMC 012645	980115	2023/9/27	2024/9/26
	EMC 184045	980116	2023/9/27	2024/9/26
RF Coaxial Cable EMCI	EMC102-KM-KM-600	150928	2023/7/8	2024/7/7
	EMC102-KM-KM-3000	150929	2023/7/8	2024/7/7
	EMC104-SM-SM- 8000+3000	171005	2023/9/27	2024/9/26
RF Coaxial Cable HUBER+SUHNER	SUCOFLEX 104	EMC104-SM-SM- 1000(140807)	2023/9/27	2024/9/26
Software BV ADT	ADT_Radiated_ V7.6.15.9.5	N/A	N/A	N/A
Turn Table Max-Full	MFT-201SS	N/A	N/A	N/A
Turn Table Controller Max-Full	MG-7802	N/A	N/A	N/A

Notes:

1. The test was performed in HY - 966 chamber 5.
2. Tested Date: 2023/12/25

## 5 Limits of Test Items

### 5.1 RF Output Power

For systems using digital modulation in the 2400–2483.5 MHz bands: 1 Watt (30 dBm)

### 5.2 Power Spectral Density

The Maximum of Power Spectral Density Measurement is 8 dBm in any 3 kHz.

### 5.3 6 dB Bandwidth

The minimum of 6 dB Bandwidth Measurement is 0.5 MHz.

### 5.4 Conducted Out of Band Emissions

Below 20 dB of the highest emission level of operating band (in 100 kHz Resolution Bandwidth).

### 5.5 AC Power Conducted Emissions

Frequency (MHz)	Conducted Limit (dBuV)	
	Quasi-peak	Average
0.15 - 0.5	66 - 56	56 - 46
0.50 - 5.0	56	46
5.0 - 30.0	60	50

Notes:

1. The lower limit shall apply at the transition frequencies.
2. The limit decreases in line with the logarithm of the frequency in the range of 0.15 to 0.50 MHz.

## 5.6 Unwanted Emissions below 1 GHz

Radiated emissions up to 1 GHz which fall in the restricted bands must comply with the radiated emission limits specified as below table. Other emissions shall be at least 20 dB below the highest level of the desired power:

Frequencies (MHz)	Field Strength (microvolts/meter)	Measurement Distance (meters)
0.009 ~ 0.490	2400/F(kHz)	300
0.490 ~ 1.705	24000/F(kHz)	30
1.705 ~ 30.0	30	30
30 ~ 88	100	3
88 ~ 216	150	3
216 ~ 960	200	3
Above 960	500	3

Notes:

1. The lower limit shall apply at the transition frequencies.
2. Emission level (dBuV/m) = 20 log Emission level (uV/m).

## 5.7 Unwanted Emissions above 1 GHz

Radiated emissions above 1 GHz which fall in the restricted bands must comply with the radiated emission limits specified as below table. Other emissions shall be at least 20 dB below the highest level of the desired power:

Frequencies (MHz)	Field Strength (microvolts/meter)	Measurement Distance (meters)
Above 960	500	3

Notes:

1. The lower limit shall apply at the transition frequencies.
2. Emission level (dBuV/m) = 20 log Emission level (uV/m).
3. For frequencies above 1000 MHz, the field strength limits are based on average detector, however, the peak field strength of any emission shall not exceed the maximum permitted average limits, specified above by more than 20 dB under any condition of modulation.



## 6 Test Arrangements

### 6.1 RF Output Power

#### 6.1.1 Test Setup

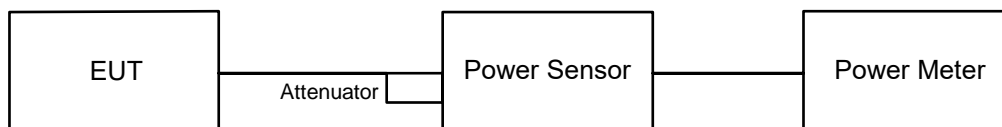

#### 6.1.2 Test Procedure

##### Peak Power:

A peak power sensor was used on the output port of the EUT. A power meter was used to read the response of the peak power sensor. Record the power level.

##### Average Power:

Average power sensor was used to perform output power measurement, trigger and gating function of wide band power meter is enabled to measure max output power of TX on burst. Duty factor is not added to measured value.

### 6.2 Power Spectral Density

#### 6.2.1 Test Setup

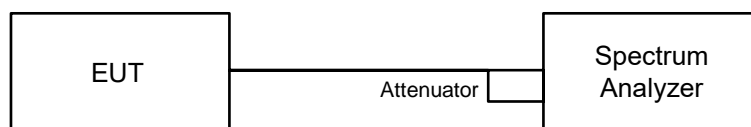

#### 6.2.2 Test Procedure

- a. Set analyzer center frequency to DTS channel center frequency.
- b. Set the span to 1.5 times the DTS bandwidth.
- c. Set the RBW to: 3 kHz.
- d. Set the VBW  $\geq 3 \times$  RBW.
- e. Detector = peak.
- f. Sweep time = auto couple.
- g. Trace mode = max hold.
- h. Allow trace to fully stabilize.
- i. Use the peak marker function to determine the maximum amplitude level within the RBW.

### 6.3 6 dB Bandwidth

#### 6.3.1 Test Setup

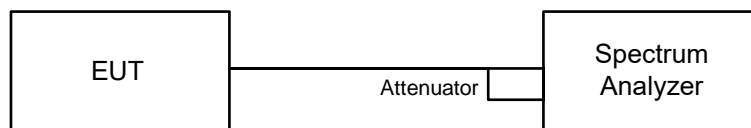

#### 6.3.2 Test Procedure

- a. Set resolution bandwidth (RBW) = 100 kHz.
- b. Set the video bandwidth (VBW)  $\geq 3 \times$  RBW, Detector = Peak.
- c. Trace mode = max hold.
- d. Sweep = auto couple.
- e. Measure the maximum width of the emission that is constrained by the frequencies associated with the two amplitude points (upper and lower) that are attenuated by 6 dB relative to the maximum level measured in the fundamental emission.

### 6.4 Conducted Out of Band Emissions

#### 6.4.1 Test Setup

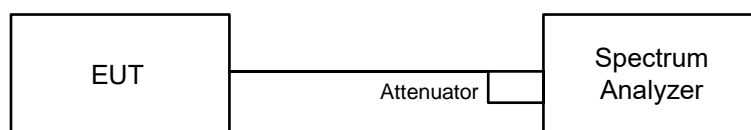

#### 6.4.2 Test Procedure

##### MEASUREMENT PROCEDURE REF

- a. Set the RBW = 100 kHz.
- b. Set the VBW  $\geq 300$  kHz.
- c. Detector = peak.
- d. Sweep time = auto couple.
- e. Trace mode = max hold.
- f. Allow trace to fully stabilize.
- g. Use the peak marker function to determine the maximum power level in any 100 kHz band segment within the fundamental EBW.

##### MEASUREMENT PROCEDURE OOB

- a. Set RBW = 100 kHz.
- b. Set VBW  $\geq 300$  kHz.
- c. Detector = peak.
- d. Sweep = auto couple.
- e. Trace Mode = max hold.
- f. Allow trace to fully stabilize.
- g. Use the peak marker function to determine the maximum amplitude level.

## 6.5 AC Power Conducted Emissions

### 6.5.1 Test Setup

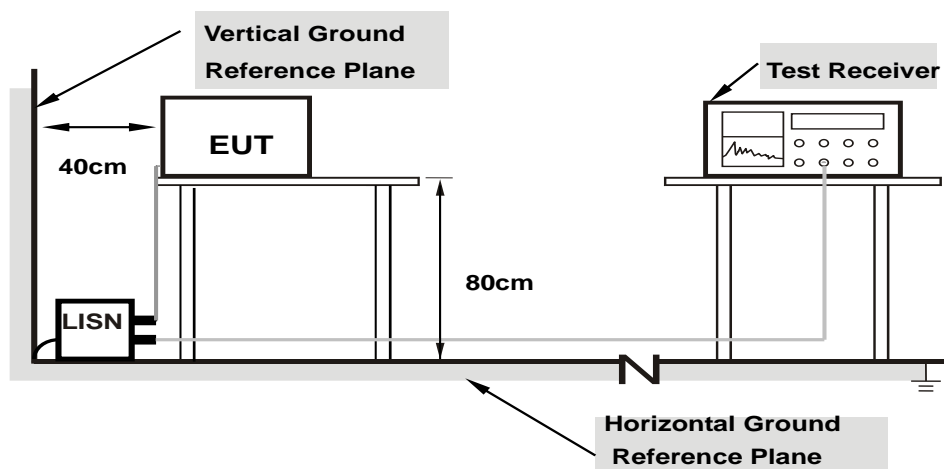

**Note: 1.Support units were connected to second LISN.**

For the actual test configuration, please refer to the attached file (Test Setup Photo).

### 6.5.2 Test Procedure

- The EUT was placed on a 0.8 meter to the top of table and placed 0.4 meters from the conducting wall of the shielded room with EUT being connected to the power mains through a line impedance stabilization network (LISN). Other support units were connected to the power mains through another LISN. The two LISNs provide 50 ohm/ 50 uH of coupling impedance for the measuring instrument.
- Both lines of the power mains connected to the EUT were checked for maximum conducted interference.
- The frequency range from 150 kHz to 30 MHz was searched. Emission levels under (Limit – 20 dB) was not recorded.

Note: The resolution bandwidth and video bandwidth of test receiver is 9 kHz for quasi-peak detection (QP) and average detection (AV) at frequency 0.15 MHz-30 MHz.

## 6.6 Unwanted Emissions below 1 GHz

### 6.6.1 Test Setup

#### For Radiated emission below 30 MHz

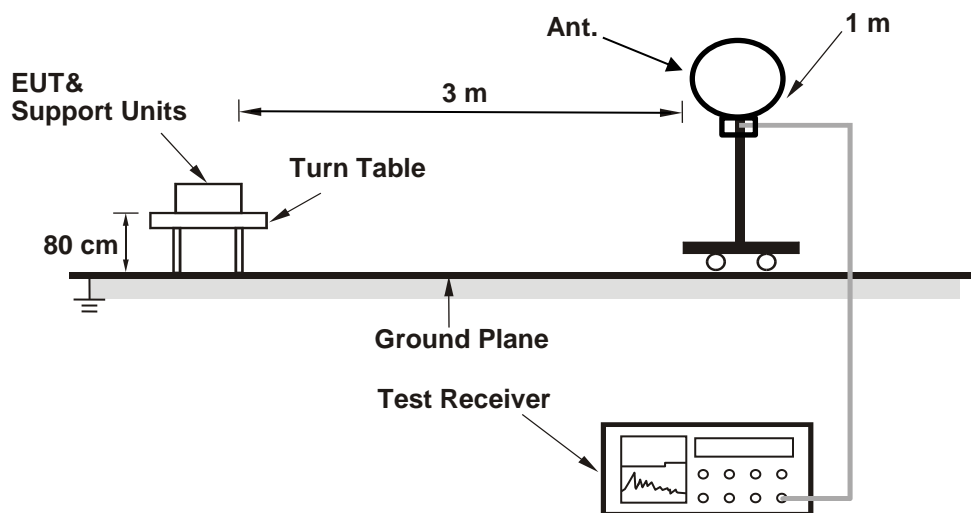

#### For Radiated emission above 30 MHz

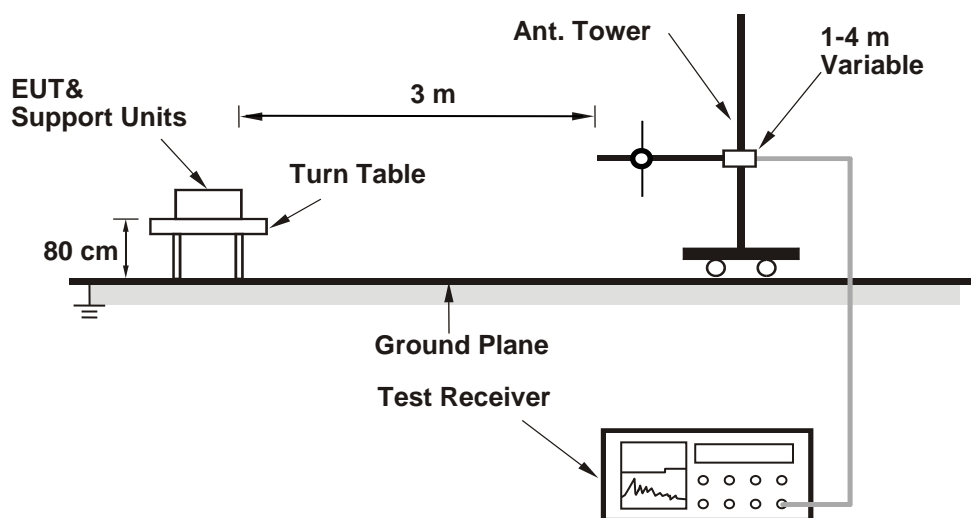

For the actual test configuration, please refer to the attached file (Test Setup Photo).

## 6.6.2 Test Procedure

### For Radiated emission below 30 MHz

- a. The EUT was placed on the top of a rotating table 0.8 meters above the ground at 3 meter chamber room for test. The table was rotated 360 degrees to determine the position of the highest radiation.
- b. The EUT was set 3 meters away from the interference-receiving antenna, which was mounted on the top of a variable-height antenna tower.
- c. Parallel, perpendicular, and ground-parallel orientations of the antenna are set to make the measurement.
- d. For each suspected emission, the EUT was arranged to its worst case and the rotatable table was turned from 0 degrees to 360 degrees to find the maximum reading.
- e. The test-receiver system was set to Quasi-Peak Detect Function and Specified Bandwidth with Maximum Hold Mode, except for the frequency band (9 kHz to 90 kHz and 110 kHz to 490 kHz) set to average detect function and peak detect function.

#### Notes:

1. The resolution bandwidth and video bandwidth of test receiver/spectrum analyzer is 200 Hz at frequency below 150 kHz.
2. The resolution bandwidth and video bandwidth of test receiver/spectrum analyzer is 9 kHz or 10 kHz at frequency (150 kHz to 30 MHz).
3. All modes of operation were investigated and the worst-case emissions are reported.

### For Radiated emission above 30 MHz

- a. The EUT was placed on the top of a rotating table 0.8 meters above the ground at 3 meter chamber room for test. The table was rotated 360 degrees to determine the position of the highest radiation.
- b. The EUT was set 3 meters away from the interference-receiving antenna, which was mounted on the top of a variable-height antenna tower.
- c. The height of antenna is varied from one meter to four meters above the ground to determine the maximum value of the field strength. Both horizontal and vertical polarizations of the antenna are set to make the measurement.
- d. For each suspected emission, the EUT was arranged to its worst case and then the antenna was tuned to heights from 1 meter to 4 meters and the rotatable table was turned from 0 degrees to 360 degrees to find the maximum reading.
- e. The test-receiver system was set to quasi-peak detect function and specified bandwidth with maximum hold mode when the test frequency is below 1 GHz.

#### Notes:

1. The resolution bandwidth and video bandwidth of test receiver/spectrum analyzer is 120 kHz for Quasi-peak detection (QP) at frequency below 1 GHz.
2. All modes of operation were investigated and the worst-case emissions are reported.

## 6.7 Unwanted Emissions above 1 GHz

### 6.7.1 Test Setup

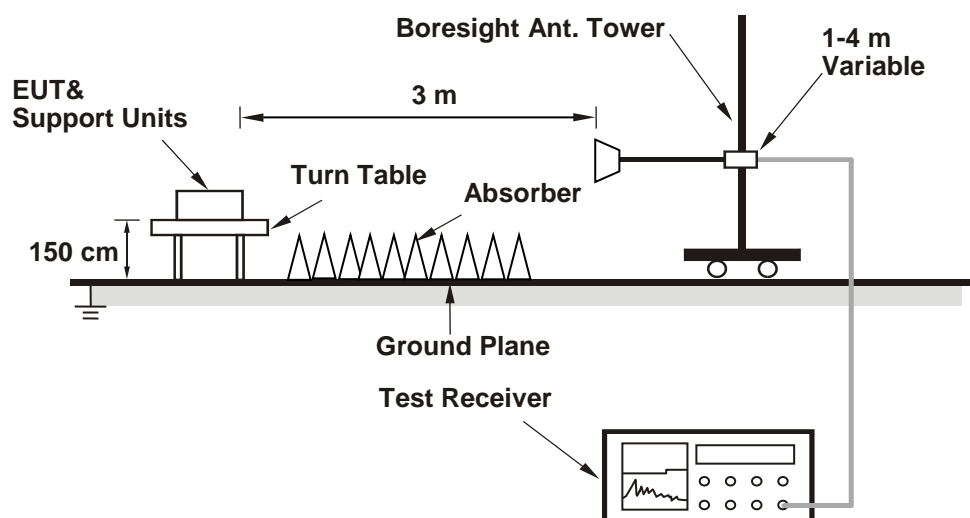

For the actual test configuration, please refer to the attached file (Test Setup Photo).

### 6.7.2 Test Procedure

- The EUT was placed on the top of a rotating table 1.5 meters above the ground at 3 meter chamber room for test. The table was rotated 360 degrees to determine the position of the highest radiation.
- The EUT was set 3 meters away from the interference-receiving antenna, which was mounted on the top of a variable-height antenna tower.
- The height of antenna is varied from one meter to four meters above the ground to determine the maximum value of the field strength. Both horizontal and vertical polarizations of the antenna are set to make the measurement.
- For each suspected emission, the EUT was arranged to its worst case and then the antenna was tuned to heights from 1 meter to 4 meters and the rotatable table was turned from 0 degrees to 360 degrees to find the maximum reading.
- The test-receiver/spectrum analyzer was set to peak and average detects function and specified bandwidth with maximum hold mode when the test frequency is above 1 GHz. If the peak reading value also meets average limit, measurement with the average detector is unnecessary.

#### Notes:

- The resolution bandwidth of test receiver/spectrum analyzer is 1 MHz and the video bandwidth is 3 MHz for Peak detection (PK) and Average detection (AV) at frequency above 1 GHz.
- For harmonic signal measurement, the resolution bandwidth of test receiver/spectrum analyzer is 1 MHz and the video bandwidth is  $\geq 1/T$  (Duty cycle  $< 98\%$ ) or 10 Hz (Duty cycle  $\geq 98\%$ ) for Average detection (AV) at frequency above 1 GHz.
- All modes of operation were investigated and the worst-case emissions are reported.

## 7 Test Results of Test Item

### 7.1 RF Output Power

Input Power:	120 Vac, 60 Hz	Environmental Conditions:	21°C, 69% RH	Tested By:	Tim Chen
--------------	----------------	---------------------------	--------------	------------	----------

#### For Peak Power

##### BT-LE 1M

Chan.	Chan. Freq. (MHz)	Peak Power (mW)	Peak Power (dBm)	Power Limit (dBm)	Test Result
0	2402	1.614	2.08	30	Pass
19	2440	<b>1.832</b>	<b>2.63</b>	30	Pass
39	2480	1.294	1.12	30	Pass

Note: The antenna gain is 1.1 dBi < 6 dBi, so the output power limit shall not be reduced.

##### BT-LE 2M

Chan.	Chan. Freq. (MHz)	Peak Power (mW)	Peak Power (dBm)	Power Limit (dBm)	Test Result
0	2402	1.694	2.29	30	Pass
19	2440	<b>1.923</b>	<b>2.84</b>	30	Pass
39	2480	1.365	1.35	30	Pass

Note: The antenna gain is 1.1 dBi < 6 dBi, so the output power limit shall not be reduced.

#### For Average Power

##### BT-LE 1M

Chan.	Chan. Freq. (MHz)	Average Power (mW)	Average Power (dBm)
0	2402	1.538	1.87
19	2440	1.746	2.42
39	2480	1.216	0.85

##### BT-LE 2M

Chan.	Chan. Freq. (MHz)	Average Power (mW)	Average Power (dBm)
0	2402	1.489	1.73
19	2440	1.687	2.27
39	2480	1.191	0.76

## 7.2 Power Spectral Density

Input Power:	120 Vac, 60 Hz	Environmental Conditions:	21°C, 69% RH	Tested By:	Tim Chen
--------------	----------------	---------------------------	--------------	------------	----------

### BT-LE 1M

Chan.	Chan. Freq. (MHz)	PSD (dBm/3kHz)	PSD Limit (dBm/3kHz)	Test Result
0	2402	-13.28	8	Pass
19	2440	-12.22	8	Pass
39	2480	-13.76	8	Pass

Note: The antenna gain is 1.1 dBi < 6 dBi, so the power density limit shall not be reduced.

### BT-LE 2M

Chan.	Chan. Freq. (MHz)	PSD (dBm/3kHz)	PSD Limit (dBm/3kHz)	Test Result
0	2402	-16.05	8	Pass
19	2440	-15.01	8	Pass
39	2480	-16.52	8	Pass

Note: The antenna gain is 1.1 dBi < 6 dBi, so the power density limit shall not be reduced.

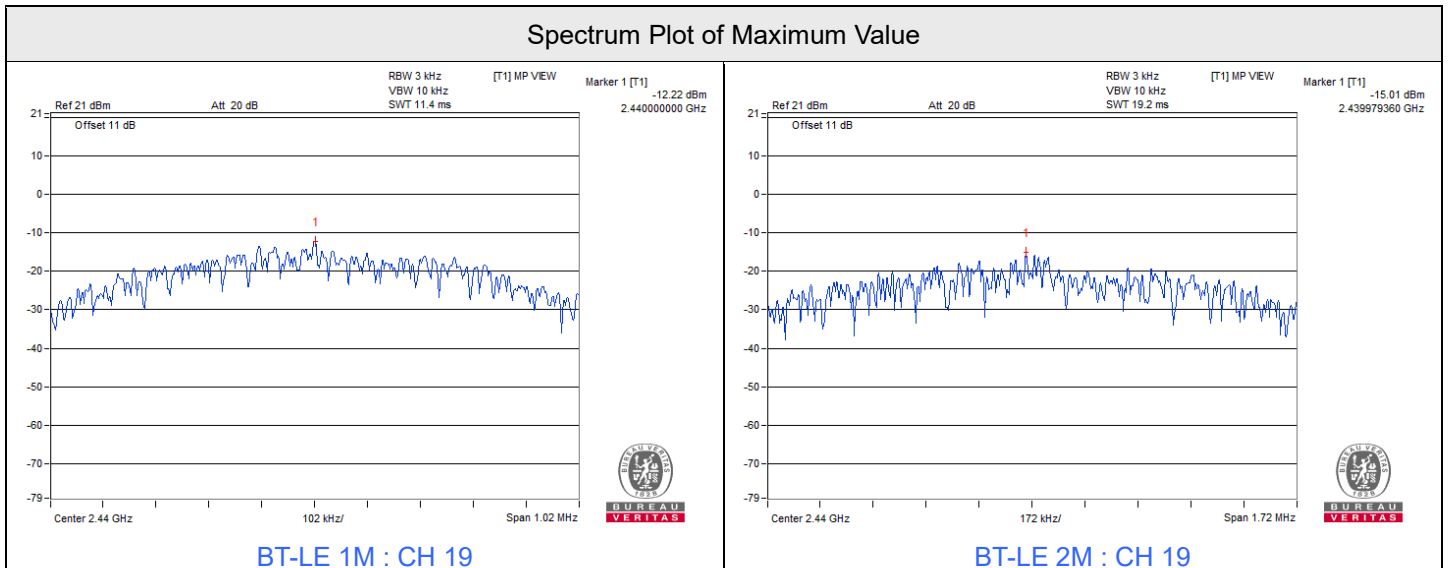



### 7.3 6 dB Bandwidth

Input Power:	120 Vac, 60 Hz	Environmental Conditions:	21°C, 69% RH	Tested By:	Tim Chen
--------------	----------------	---------------------------	--------------	------------	----------

#### BT-LE 1M

Channel	Frequency (MHz)	6 dB Bandwidth (MHz)	Minimum Limit (MHz)	Test Result
0	2402	0.68	0.5	Pass
19	2440	0.68	0.5	Pass
39	2480	0.67	0.5	Pass

#### BT-LE 2M

Channel	Frequency (MHz)	6 dB Bandwidth (MHz)	Minimum Limit (MHz)	Test Result
0	2402	1.15	0.5	Pass
19	2440	1.15	0.5	Pass
39	2480	1.15	0.5	Pass

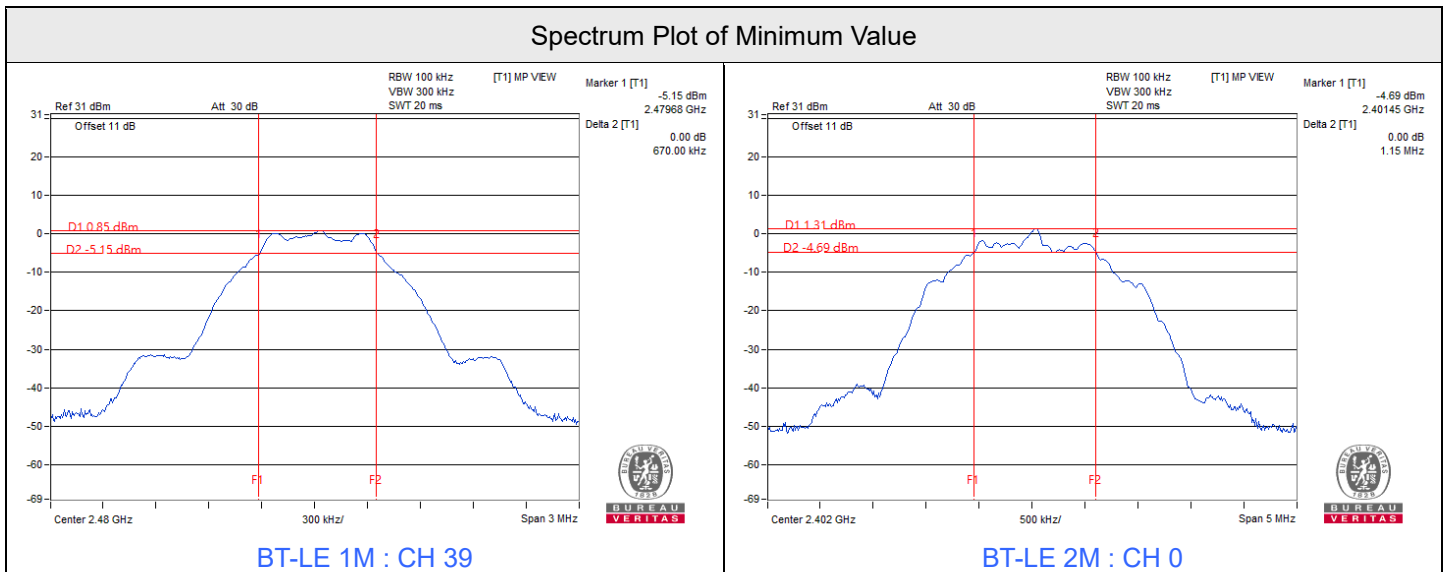



### 7.4 Conducted Out of Band Emissions

Input Power:	120 Vac, 60 Hz	Environmental Conditions:	21°C, 69% RH	Tested By:	Tim Chen
--------------	----------------	---------------------------	--------------	------------	----------

#### BT-LE 1M





BT-LE 2M

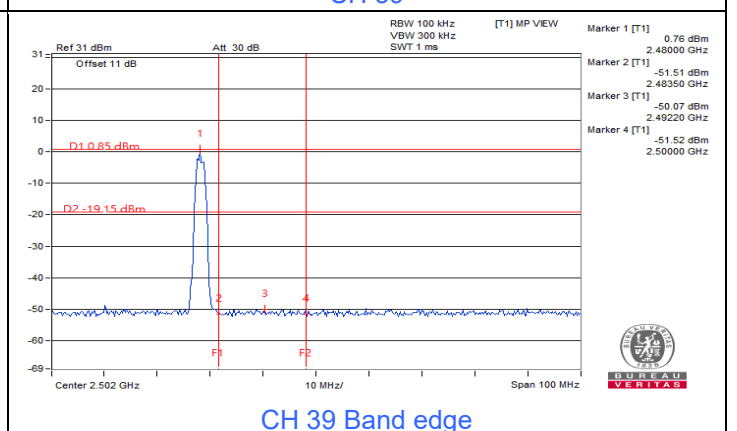
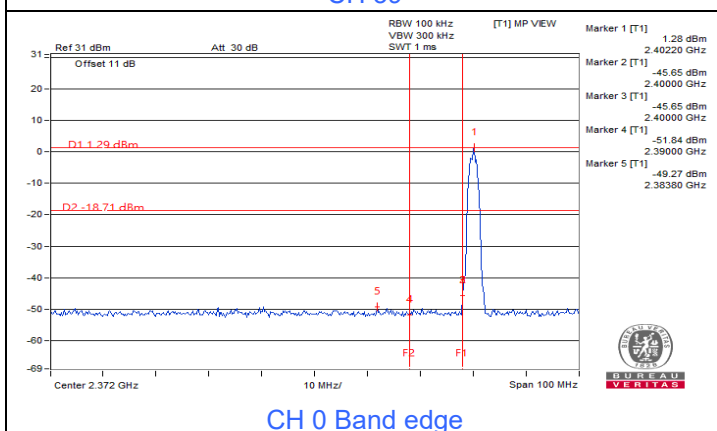
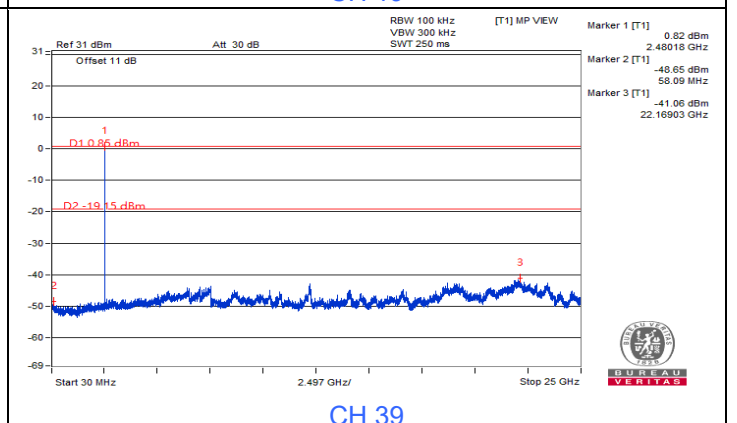
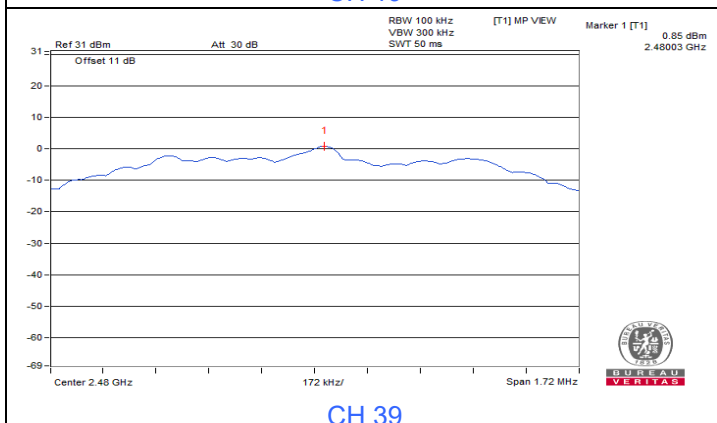
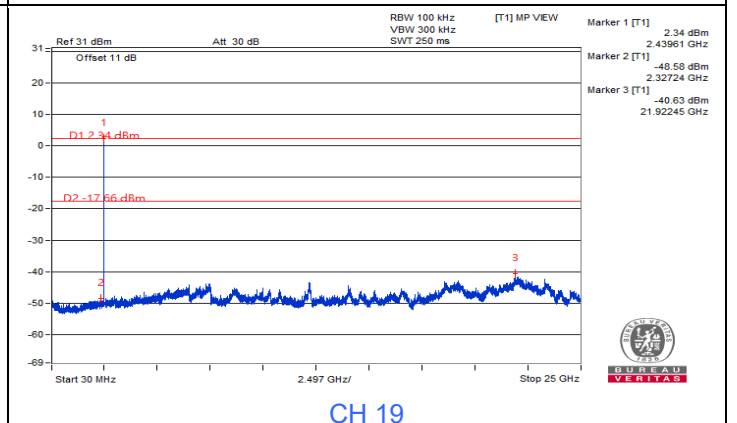
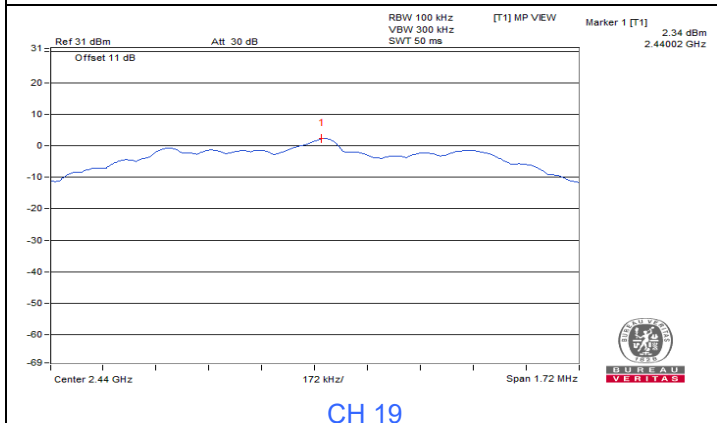
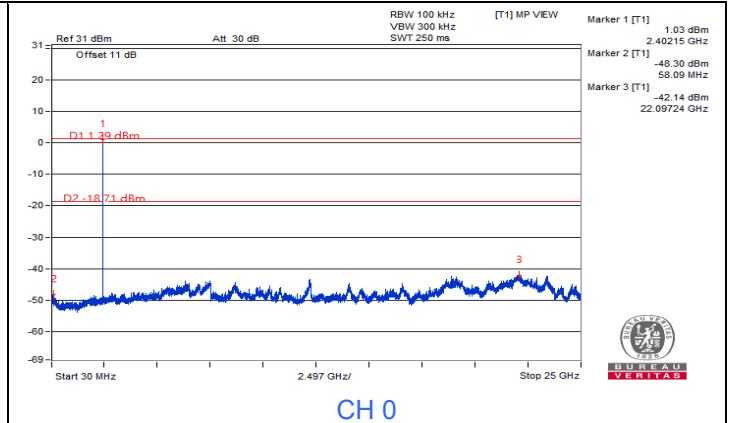
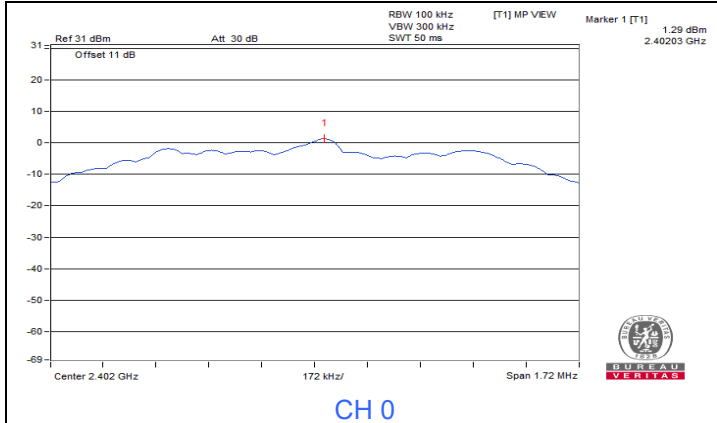

## 7.5 AC Power Conducted Emissions

RF Mode	BT-LE 2M	Channel	CH 19 : 2440 MHz
Frequency Range	150 kHz ~ 30 MHz	Detector Function & Resolution Bandwidth	Quasi-Peak (QP) / Average (AV), 9 kHz
Input Power	120 Vac, 60 Hz	Environmental Conditions	22°C, 64% RH
Tested By	Vincent Chen		

Phase Of Power : Line (L)										
No	Frequency (MHz)	Correction Factor (dB)	Reading Value (dBuV)		Emission Level (dBuV)		Limit (dBuV)		Margin (dB)	
			Q.P.	AV.	Q.P.	AV.	Q.P.	AV.	Q.P.	AV.
1	0.15400	10.32	30.44	20.33	40.76	30.65	65.78	55.78	-25.02	-25.13
2	0.43400	10.42	28.55	22.70	38.97	33.12	57.18	47.18	-18.21	-14.06
3	1.92600	10.42	25.67	14.53	36.09	24.95	56.00	46.00	-19.91	-21.05
4	3.80200	10.51	30.11	18.96	40.62	29.47	56.00	46.00	-15.38	-16.53
5	6.29800	10.54	26.90	16.89	37.44	27.43	60.00	50.00	-22.56	-22.57
6	12.70200	10.62	23.34	12.39	33.96	23.01	60.00	50.00	-26.04	-26.99

### Remarks:

1. Q.P. and AV. are abbreviations of quasi-peak and average individually.
2. The emission levels of other frequencies were very low against the limit.
3. Margin value = Emission level – Limit value
4. Correction factor = Insertion loss + Cable loss
5. Emission Level = Correction Factor + Reading Value

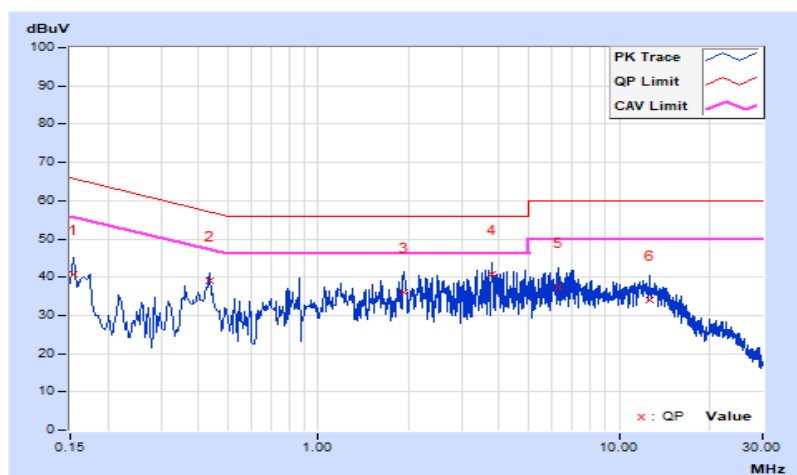

RF Mode	BT-LE 2M	Channel	CH 19 : 2440 MHz
Frequency Range	150 kHz ~ 30 MHz	Detector Function & Resolution Bandwidth	Quasi-Peak (QP) / Average (AV), 9 kHz
Input Power	120 Vac, 60 Hz	Environmental Conditions	22°C, 64% RH
Tested By	Vincent Chen		

Phase Of Power : Neutral (N)										
No	Frequency (MHz)	Correction Factor (dB)	Reading Value (dBuV)		Emission Level (dBuV)		Limit (dBuV)		Margin (dB)	
			Q.P.	AV.	Q.P.	AV.	Q.P.	AV.	Q.P.	AV.
1	0.16600	10.34	38.16	33.40	48.50	43.74	65.16	55.16	-16.66	-11.42
2	0.35800	10.42	35.58	28.04	46.00	38.46	58.77	48.77	-12.77	-10.31
<b>3</b>	<b>0.43370</b>	<b>10.44</b>	<b>35.20</b>	<b>29.60</b>	<b>45.64</b>	<b>40.04</b>	<b>57.18</b>	<b>47.18</b>	<b>-11.54</b>	<b>-7.14</b>
4	3.69000	10.53	28.38	17.55	38.91	28.08	56.00	46.00	-17.09	-17.92
5	5.21800	10.57	27.06	15.97	37.63	26.54	60.00	50.00	-22.37	-23.46
6	12.81400	10.73	23.78	12.33	34.51	23.06	60.00	50.00	-25.49	-26.94

Remarks:

1. Q.P. and AV. are abbreviations of quasi-peak and average individually.
2. The emission levels of other frequencies were very low against the limit.
3. Margin value = Emission level – Limit value
4. Correction factor = Insertion loss + Cable loss
5. Emission Level = Correction Factor + Reading Value

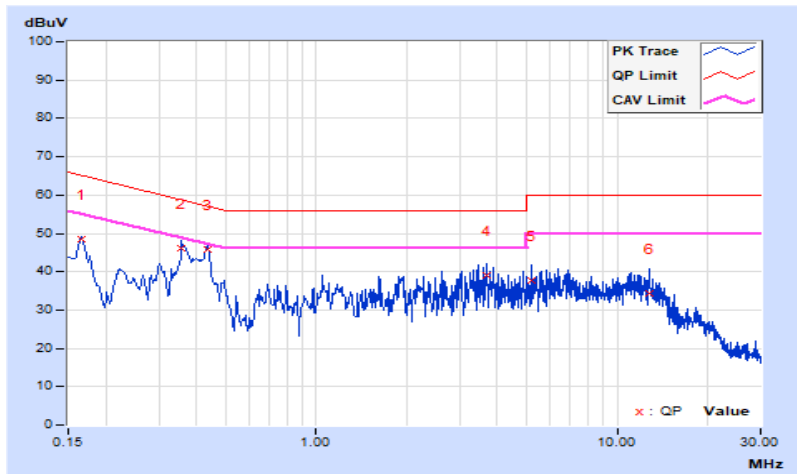

## 7.6 Unwanted Emissions below 1 GHz

RF Mode	BT-LE 2M	Channel	CH 19 : 2440 MHz
Frequency Range	30 MHz ~ 1 GHz	Detector Function & Bandwidth	QP: RB=120kHz, DET=Quasi-Peak
Input Power	120 Vac, 60 Hz	Environmental Conditions	24°C, 78% RH
Tested By	Vincent Chen		

Antenna Polarity & Test Distance : Horizontal at 3 m								
No	Frequency (MHz)	Emission Level (dBuV/m)	Limit (dBuV/m)	Margin (dB)	Antenna Height (m)	Table Angle (Degree)	Raw Value (dBuV)	Correction Factor (dB/m)
1	78.50	30.7 QP	40.0	-9.3	1.00 H	357	47.7	-17.0
2	144.46	36.2 QP	43.5	-7.3	2.00 H	238	49.0	-12.8
3	299.66	39.1 QP	46.0	-6.9	1.00 H	55	51.2	-12.1
<b>4</b>	<b>419.94</b>	<b>40.1 QP</b>	<b>46.0</b>	<b>-5.9</b>	<b>2.00 H</b>	<b>334</b>	<b>49.2</b>	<b>-9.1</b>
5	647.89	39.2 QP	46.0	-6.8	1.00 H	260	43.3	-4.1
6	734.22	37.2 QP	46.0	-8.8	1.50 H	213	39.2	-2.0

### Remarks:

1. Emission Level(dBuV/m) = Raw Value(dBuV) + Correction Factor(dB/m)
2. Correction Factor(dB/m) = Antenna Factor(dB/m) + Cable Factor(dB) – Pre-Amplifier Factor(dB)
3. Margin value = Emission Level – Limit value
4. The other emission levels were very low against the limit of frequency range 30 MHz ~ 1 GHz.
5. The frequency range 9 kHz ~ 30 MHz: all emissions are more than 20 dB below the limit, therefore do not be recorded in this report.

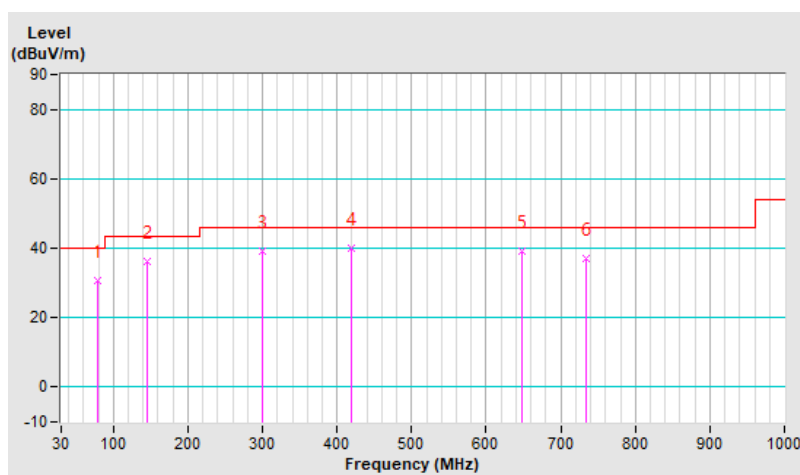

RF Mode	BT-LE 2M	Channel	CH 19 : 2440 MHz
Frequency Range	30 MHz ~ 1 GHz	Detector Function & Bandwidth	QP: RB=120kHz, DET=Quasi-Peak
Input Power	120 Vac, 60 Hz	Environmental Conditions	24°C, 78% RH
Tested By	Vincent Chen		

Antenna Polarity & Test Distance : Vertical at 3 m								
No	Frequency (MHz)	Emission Level (dBuV/m)	Limit (dBuV/m)	Margin (dB)	Antenna Height (m)	Table Angle (Degree)	Raw Value (dBuV)	Correction Factor (dB/m)
1	53.28	33.7 QP	40.0	-6.3	1.00 V	348	46.2	-12.5
2	144.46	37.0 QP	43.5	-6.5	1.00 V	60	49.8	-12.8
3	359.80	39.7 QP	46.0	-6.3	1.50 V	209	50.5	-10.8
4	576.11	39.0 QP	46.0	-7.0	1.00 V	184	44.6	-5.6
5	792.42	36.0 QP	46.0	-10.0	2.00 V	244	37.0	-1.0
6	902.03	38.3 QP	46.0	-7.7	1.50 V	176	39.0	-0.7

Remarks:

1. Emission Level(dBuV/m) = Raw Value(dBuV) + Correction Factor(dB/m)
2. Correction Factor(dB/m) = Antenna Factor(dB/m) + Cable Factor(dB) – Pre-Amplifier Factor(dB)
3. Margin value = Emission Level – Limit value
4. The other emission levels were very low against the limit of frequency range 30 MHz ~ 1 GHz.
5. The frequency range 9 kHz ~ 30 MHz: all emissions are more than 20 dB below the limit, therefore do not be recorded in this report.

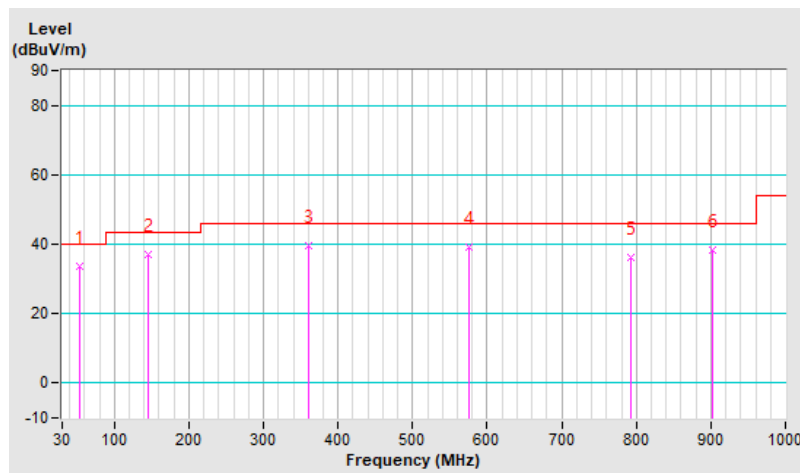

## 7.7 Unwanted Emissions above 1 GHz

RF Mode	BT-LE 1M	Channel	CH 0 : 2402 MHz
Frequency Range	1 GHz ~ 25 GHz	Detector Function & Bandwidth	PK: RB=1 MHz, VB=3 MHz, DET=Peak AV: RB=1 MHz, VB=3 kHz, DET=Peak
Input Power	120 Vac, 60 Hz	Environmental Conditions	23°C, 66.2% RH
Tested By	Vincent Chen		

Antenna Polarity & Test Distance : Horizontal at 3 m								
No	Frequency (MHz)	Emission Level (dBuV/m)	Limit (dBuV/m)	Margin (dB)	Antenna Height (m)	Table Angle (Degree)	Raw Value (dBuV)	Correction Factor (dB/m)
1	2390.00	59.9 PK	74.0	-14.1	1.58 H	220	25.1	34.8
2	2390.00	46.6 AV	54.0	-7.4	1.58 H	220	11.8	34.8
3	*2402.00	93.1 PK			1.56 H	216	58.4	34.7
4	*2402.00	92.1 AV			1.56 H	216	57.4	34.7
5	4804.00	52.6 PK	74.0	-21.4	1.65 H	298	43.5	9.1
6	4804.00	40.3 AV	54.0	-13.7	1.65 H	298	31.2	9.1
Antenna Polarity & Test Distance : Vertical at 3 m								
No	Frequency (MHz)	Emission Level (dBuV/m)	Limit (dBuV/m)	Margin (dB)	Antenna Height (m)	Table Angle (Degree)	Raw Value (dBuV)	Correction Factor (dB/m)
1	2390.00	60.2 PK	74.0	-13.8	1.51 V	169	25.4	34.8
2	2390.00	46.8 AV	54.0	-7.2	1.51 V	169	12.0	34.8
3	*2402.00	95.0 PK			1.54 V	178	60.3	34.7
4	*2402.00	94.1 AV			1.54 V	178	59.4	34.7
5	4804.00	54.0 PK	74.0	-20.0	2.34 V	110	44.9	9.1
6	4804.00	40.8 AV	54.0	-13.2	2.34 V	110	31.7	9.1

### Remarks:

1. Emission Level(dBuV/m) = Raw Value(dBuV) + Correction Factor(dB/m)
2. Correction Factor(dB/m) = Antenna Factor(dB/m) + Cable Factor(dB) – Pre-Amplifier Factor(dB)
3. Margin value = Emission Level – Limit value
4. The other emission levels were very low against the limit.
5. " \* ": Fundamental frequency, the limit was restricted at the RF Output Power.





RF Mode	BT-LE 1M	Channel	CH 19 : 2440 MHz
Frequency Range	1 GHz ~ 25 GHz	Detector Function & Bandwidth	PK: RB=1 MHz, VB=3 MHz, DET=Peak AV: RB=1 MHz, VB=3 kHz, DET=Peak
Input Power	120 Vac, 60 Hz	Environmental Conditions	23°C, 66.2% RH
Tested By	Vincent Chen		

Antenna Polarity & Test Distance : Horizontal at 3 m

No	Frequency (MHz)	Emission Level (dBuV/m)	Limit (dBuV/m)	Margin (dB)	Antenna Height (m)	Table Angle (Degree)	Raw Value (dBuV)	Correction Factor (dB/m)
1	*2440.00	96.1 PK			1.51 H	214	61.3	34.8
2	*2440.00	95.2 AV			1.51 H	214	60.4	34.8
3	4880.00	52.8 PK	74.0	-21.2	2.30 H	177	43.3	9.5
4	4880.00	40.7 AV	54.0	-13.3	2.30 H	177	31.2	9.5

Antenna Polarity & Test Distance : Vertical at 3 m

No	Frequency (MHz)	Emission Level (dBuV/m)	Limit (dBuV/m)	Margin (dB)	Antenna Height (m)	Table Angle (Degree)	Raw Value (dBuV)	Correction Factor (dB/m)
1	*2440.00	96.3 PK			1.59 V	357	61.5	34.8
2	*2440.00	95.4 AV			1.59 V	357	60.6	34.8
3	4880.00	53.4 PK	74.0	-20.6	2.05 V	143	43.9	9.5
4	4880.00	41.2 AV	54.0	-12.8	2.05 V	143	31.7	9.5

Remarks:

1. Emission Level(dBuV/m) = Raw Value(dBuV) + Correction Factor(dB/m)
2. Correction Factor(dB/m) = Antenna Factor(dB/m) + Cable Factor(dB) – Pre-Amplifier Factor(dB)
3. Margin value = Emission Level – Limit value
4. The other emission levels were very low against the limit.
5. " \* " : Fundamental frequency, the limit was restricted at the RF Output Power.



RF Mode	BT-LE 1M	Channel	CH 39 : 2480 MHz
Frequency Range	1 GHz ~ 25 GHz	Detector Function & Bandwidth	PK: RB=1 MHz, VB=3 MHz, DET=Peak AV: RB=1 MHz, VB=3 kHz, DET=Peak
Input Power	120 Vac, 60 Hz	Environmental Conditions	23°C, 66.2% RH
Tested By	Vincent Chen		

Antenna Polarity & Test Distance : Horizontal at 3 m								
No	Frequency (MHz)	Emission Level (dBuV/m)	Limit (dBuV/m)	Margin (dB)	Antenna Height (m)	Table Angle (Degree)	Raw Value (dBuV)	Correction Factor (dB/m)
1	*2480.00	94.9 PK			1.45 H	218	59.9	35.0
2	*2480.00	93.7 AV			1.45 H	218	58.7	35.0
3	2483.50	59.5 PK	74.0	-14.5	1.35 H	241	24.5	35.0
4	2483.50	47.8 AV	54.0	-6.2	1.35 H	241	12.8	35.0
5	4960.00	52.9 PK	74.0	-21.1	2.27 H	100	43.5	9.4
6	4960.00	40.6 AV	54.0	-13.4	2.27 H	100	31.2	9.4
Antenna Polarity & Test Distance : Vertical at 3 m								
No	Frequency (MHz)	Emission Level (dBuV/m)	Limit (dBuV/m)	Margin (dB)	Antenna Height (m)	Table Angle (Degree)	Raw Value (dBuV)	Correction Factor (dB/m)
1	*2480.00	95.1 PK			1.41 V	2	60.1	35.0
2	*2480.00	93.8 AV			1.41 V	2	58.8	35.0
3	2483.50	59.8 PK	74.0	-14.2	1.48 V	15	24.8	35.0
4	2483.50	48.2 AV	54.0	-5.8	1.48 V	15	13.2	35.0
5	4960.00	53.2 PK	74.0	-20.8	2.74 V	163	43.8	9.4
6	4960.00	41.1 AV	54.0	-12.9	2.74 V	163	31.7	9.4

Remarks:

1. Emission Level(dBuV/m) = Raw Value(dBuV) + Correction Factor(dB/m)
2. Correction Factor(dB/m) = Antenna Factor(dB/m) + Cable Factor(dB) – Pre-Amplifier Factor(dB)
3. Margin value = Emission Level – Limit value
4. The other emission levels were very low against the limit.
5. " \* ": Fundamental frequency, the limit was restricted at the RF Output Power.



RF Mode	BT-LE 2M	Channel	CH 0 : 2402 MHz
Frequency Range	1 GHz ~ 25 GHz	Detector Function & Bandwidth	PK: RB=1 MHz, VB=3 MHz, DET=Peak AV: RB=1 MHz, VB=5.1 kHz, DET=Peak
Input Power	120 Vac, 60 Hz	Environmental Conditions	23°C, 66.2% RH
Tested By	Vincent Chen		

Antenna Polarity & Test Distance : Horizontal at 3 m								
No	Frequency (MHz)	Emission Level (dBuV/m)	Limit (dBuV/m)	Margin (dB)	Antenna Height (m)	Table Angle (Degree)	Raw Value (dBuV)	Correction Factor (dB/m)
1	2390.00	59.5 PK	74.0	-14.5	1.73 H	238	24.7	34.8
2	2390.00	47.3 AV	54.0	-6.7	1.73 H	238	12.5	34.8
3	*2402.00	93.8 PK			1.81 H	221	59.1	34.7
4	*2402.00	90.9 AV			1.81 H	221	56.2	34.7
5	4804.00	52.6 PK	74.0	-21.4	2.34 H	183	43.5	9.1
6	4804.00	40.9 AV	54.0	-13.1	2.34 H	183	31.8	9.1
Antenna Polarity & Test Distance : Vertical at 3 m								
No	Frequency (MHz)	Emission Level (dBuV/m)	Limit (dBuV/m)	Margin (dB)	Antenna Height (m)	Table Angle (Degree)	Raw Value (dBuV)	Correction Factor (dB/m)
1	2390.00	59.7 PK	74.0	-14.3	1.42 V	173	24.9	34.8
2	2390.00	47.4 AV	54.0	-6.6	1.42 V	173	12.6	34.8
3	*2402.00	95.7 PK			1.51 V	180	61.0	34.7
4	*2402.00	92.8 AV			1.51 V	180	58.1	34.7
5	4804.00	52.9 PK	74.0	-21.1	2.20 V	269	43.8	9.1
6	4804.00	41.5 AV	54.0	-12.5	2.20 V	269	32.4	9.1

Remarks:

1. Emission Level(dBuV/m) = Raw Value(dBuV) + Correction Factor(dB/m)
2. Correction Factor(dB/m) = Antenna Factor(dB/m) + Cable Factor(dB) – Pre-Amplifier Factor(dB)
3. Margin value = Emission Level – Limit value
4. The other emission levels were very low against the limit.
5. " \* ": Fundamental frequency, the limit was restricted at the RF Output Power.



RF Mode	BT-LE 2M	Channel	CH 19 : 2440 MHz
Frequency Range	1 GHz ~ 25 GHz	Detector Function & Bandwidth	PK: RB=1 MHz, VB=3 MHz, DET=Peak AV: RB=1 MHz, VB=5.1 kHz, DET=Peak
Input Power	120 Vac, 60 Hz	Environmental Conditions	23°C, 66.2% RH
Tested By	Vincent Chen		

Antenna Polarity & Test Distance : Horizontal at 3 m

No	Frequency (MHz)	Emission Level (dBuV/m)	Limit (dBuV/m)	Margin (dB)	Antenna Height (m)	Table Angle (Degree)	Raw Value (dBuV)	Correction Factor (dB/m)
1	*2440.00	96.7 PK			1.56 H	214	61.9	34.8
2	*2440.00	93.9 AV			1.56 H	214	59.1	34.8
3	4880.00	53.3 PK	74.0	-20.7	2.07 H	119	43.8	9.5
4	4880.00	41.2 AV	54.0	-12.8	2.07 H	119	31.7	9.5

Antenna Polarity & Test Distance : Vertical at 3 m

No	Frequency (MHz)	Emission Level (dBuV/m)	Limit (dBuV/m)	Margin (dB)	Antenna Height (m)	Table Angle (Degree)	Raw Value (dBuV)	Correction Factor (dB/m)
1	*2440.00	96.8 PK			1.40 V	0	62.0	34.8
2	*2440.00	94.0 AV			1.40 V	0	59.2	34.8
3	4880.00	53.7 PK	74.0	-20.3	1.73 V	221	44.2	9.5
4	4880.00	41.5 AV	54.0	-12.5	1.73 V	221	32.0	9.5

Remarks:

1. Emission Level(dBuV/m) = Raw Value(dBuV) + Correction Factor(dB/m)
2. Correction Factor(dB/m) = Antenna Factor(dB/m) + Cable Factor(dB) – Pre-Amplifier Factor(dB)
3. Margin value = Emission Level – Limit value
4. The other emission levels were very low against the limit.
5. " \* " : Fundamental frequency, the limit was restricted at the RF Output Power.



RF Mode	BT-LE 2M	Channel	CH 39 : 2480 MHz
Frequency Range	1 GHz ~ 25 GHz	Detector Function & Bandwidth	PK: RB=1 MHz, VB=3 MHz, DET=Peak AV: RB=1 MHz, VB=5.1 kHz, DET=Peak
Input Power	120 Vac, 60 Hz	Environmental Conditions	23°C, 66.2% RH
Tested By	Vincent Chen		

Antenna Polarity & Test Distance : Horizontal at 3 m

No	Frequency (MHz)	Emission Level (dBuV/m)	Limit (dBuV/m)	Margin (dB)	Antenna Height (m)	Table Angle (Degree)	Raw Value (dBuV)	Correction Factor (dB/m)
1	*2480.00	95.1 PK			1.59 H	217	60.1	35.0
2	*2480.00	92.3 AV			1.59 H	217	57.3	35.0
3	2483.50	59.7 PK	74.0	-14.3	1.50 H	186	24.7	35.0
4	2483.50	48.1 AV	54.0	-5.9	1.50 H	186	13.1	35.0
5	4960.00	52.8 PK	74.0	-21.2	2.03 H	128	43.4	9.4
6	4960.00	40.9 AV	54.0	-13.1	2.03 H	128	31.5	9.4

Antenna Polarity & Test Distance : Vertical at 3 m

No	Frequency (MHz)	Emission Level (dBuV/m)	Limit (dBuV/m)	Margin (dB)	Antenna Height (m)	Table Angle (Degree)	Raw Value (dBuV)	Correction Factor (dB/m)
1	*2480.00	95.4 PK			1.38 V	0	60.4	35.0
2	*2480.00	92.5 AV			1.38 V	0	57.5	35.0
3	2483.50	59.9 PK	74.0	-14.1	1.32 V	11	24.9	35.0
<b>4</b>	<b>2483.50</b>	<b>48.4 AV</b>	<b>54.0</b>	<b>-5.6</b>	<b>1.32 V</b>	<b>11</b>	<b>13.4</b>	<b>35.0</b>
5	4960.00	53.3 PK	74.0	-20.7	2.33 V	179	43.9	9.4
6	4960.00	41.1 AV	54.0	-12.9	2.33 V	179	31.7	9.4

Remarks:

1. Emission Level(dBuV/m) = Raw Value(dBuV) + Correction Factor(dB/m)
2. Correction Factor(dB/m) = Antenna Factor(dB/m) + Cable Factor(dB) – Pre-Amplifier Factor(dB)
3. Margin value = Emission Level – Limit value
4. The other emission levels were very low against the limit.
5. " \* ": Fundamental frequency, the limit was restricted at the RF Output Power.

### Plot of Band Edge

Frequency Range	2.31 GHz ~ 2.412 GHz	Detector Function & Bandwidth	PK: RB=1 MHz, VB=3 MHz, DET=Peak AV: RB=1 MHz, VB=3 kHz, DET=Peak
-----------------	----------------------	-------------------------------	--

#### BT-LE 1M Channel 0

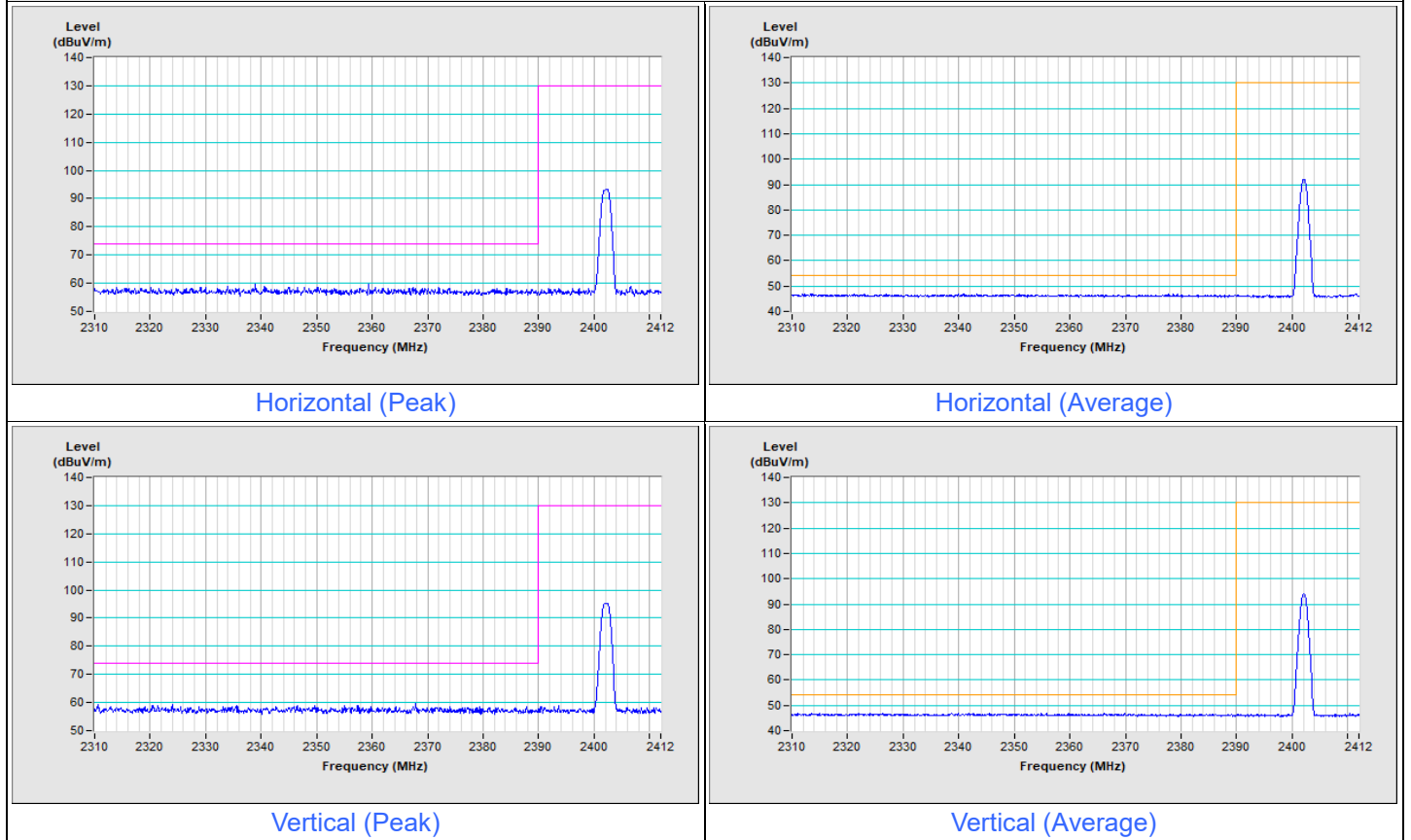

Frequency Range	2.462 GHz ~ 2.5 GHz	Detector Function & Bandwidth	PK: RB=1 MHz, VB=3 MHz, DET=Peak AV: RB=1 MHz, VB=3 kHz, DET=Peak
-----------------	---------------------	-------------------------------	--

BT-LE 1M Channel 39

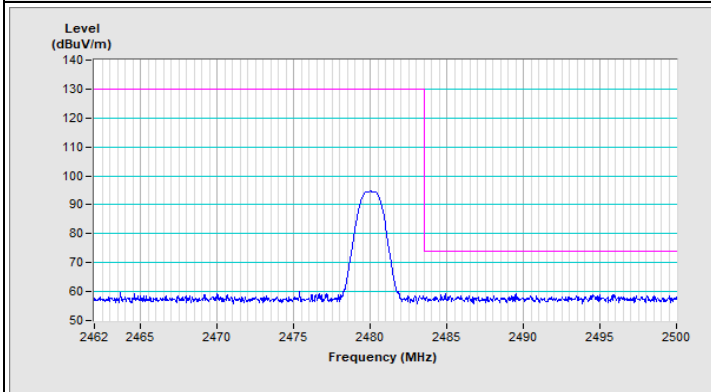

Horizontal (Peak)

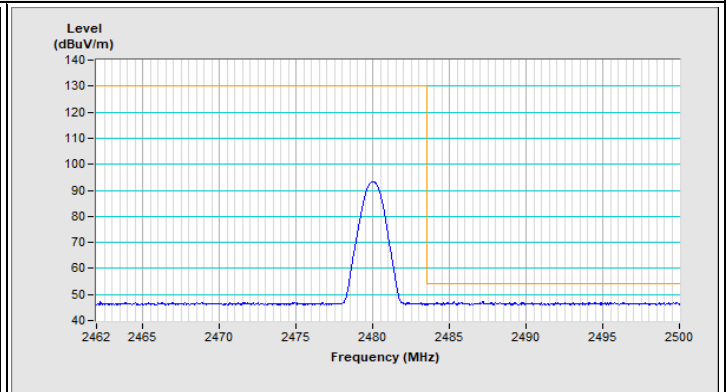

Horizontal (Average)

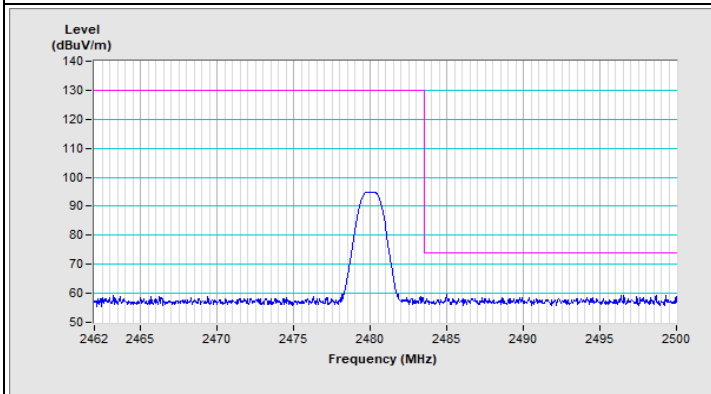

Vertical (Peak)

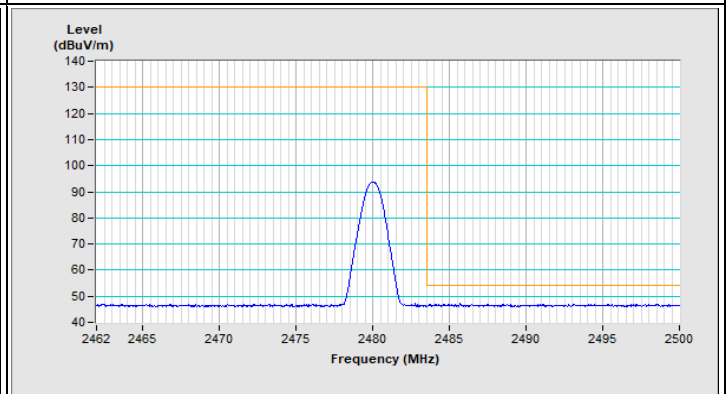

Vertical (Average)

Frequency Range	2.31 GHz ~ 2.412 GHz	Detector Function & Bandwidth	PK: RB=1 MHz, VB=3 MHz, DET=Peak AV: RB=1 MHz, VB=5.1 kHz, DET=Peak
-----------------	----------------------	-------------------------------	--

BT-LE 2M Channel 0

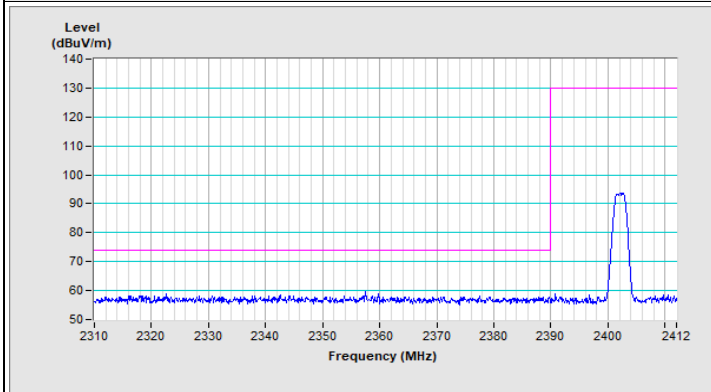

Horizontal (Peak)

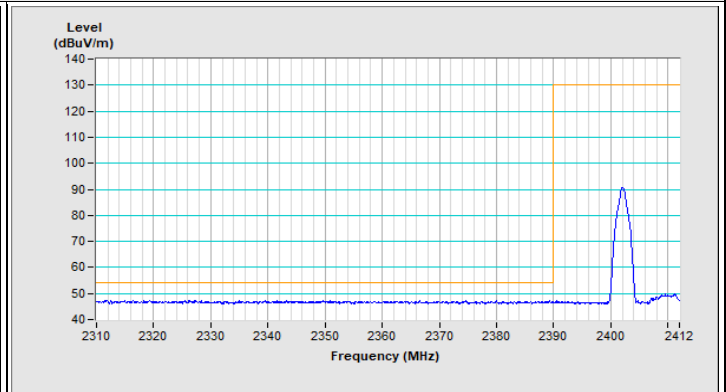

Horizontal (Average)

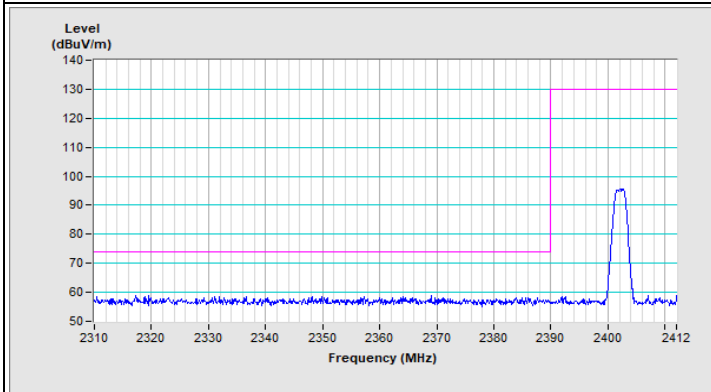

Vertical (Peak)

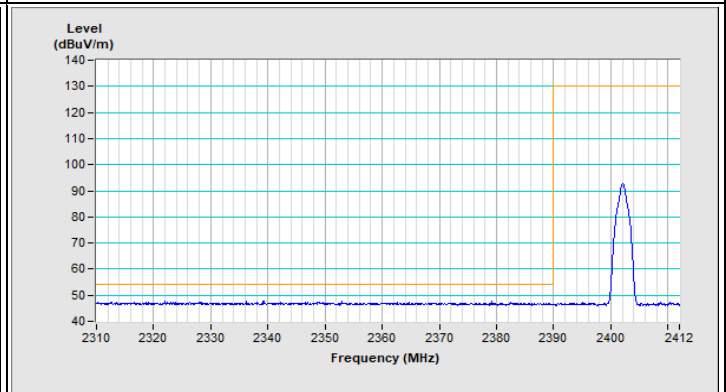

Vertical (Average)



Frequency Range	2.462 GHz ~ 2.5 GHz	Detector Function & Bandwidth	PK: RB=1 MHz, VB=3 MHz, DET=Peak AV: RB=1 MHz, VB=5.1 kHz, DET=Peak
-----------------	---------------------	-------------------------------	--

BT-LE 2M Channel 39

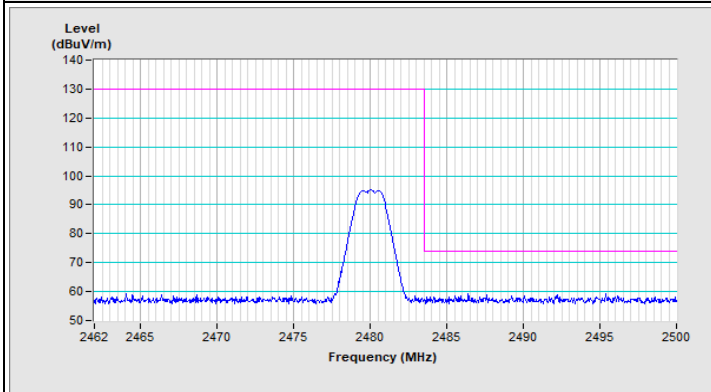

Horizontal (Peak)

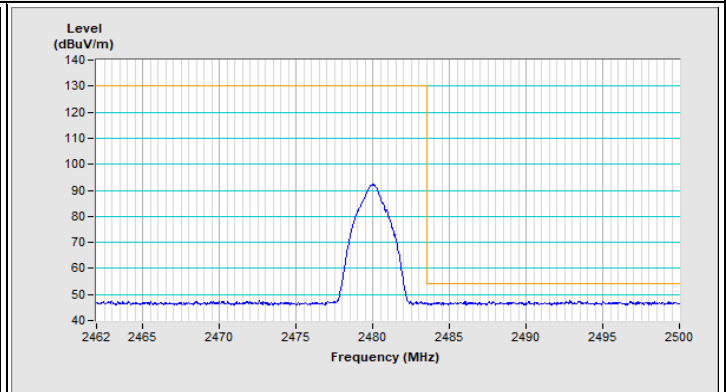

Horizontal (Average)

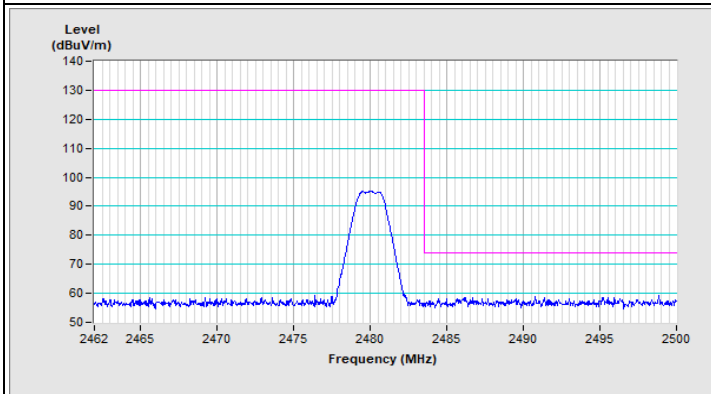

Vertical (Peak)

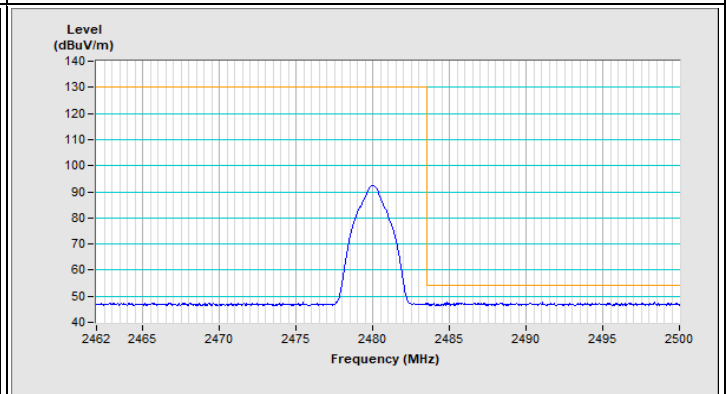

Vertical (Average)

## 8 Pictures of Test Arrangements

Please refer to the attached file (Test Setup Photo)

## 9 Information of the Testing Laboratories

We, Bureau Veritas Consumer Products Services (H.K.) Ltd., Taoyuan Branch, were founded in 1988 to provide our best service in EMC, Radio, Telecom and Safety consultation. Our laboratories are FCC recognized accredited test firms and accredited according to ISO/IEC 17025.

If you have any comments, please feel free to contact us at the following:

**Lin Kou EMC/RF Lab**

Tel: 886-2-26052180

Fax: 886-2-26051924

**Hsin Chu EMC/RF/Telecom Lab**

Tel: 886-3-6668565

Fax: 886-3-6668323

**Hwa Ya EMC/RF/Safety Lab**

Tel: 886-3-3183232

Fax: 886-3-3270892

**Email:** [service.adt@bureauveritas.com](mailto:service.adt@bureauveritas.com)

**Web Site:** <http://ee.bureauveritas.com.tw>

The address and road map of all our labs can be found in our web site also.

--- END ---