

# FCC Test Report

**Equipment** : 7777-01XX  
**Brand Name** : Orderman  
**Model No.** : 7777-01XX  
**Marketing Name** : NCR Orderman7 +  
**FCC ID** : JEH-7777-01XX  
**Standard** : 47 CFR FCC Part 15.247  
**Operating Band** : 2400 MHz – 2483.5 MHz  
**FCC Classification** : DTS  
**Applicant** : NCR Corporation  
**Address** : 2651 Satellite Blvd. Duluth, GA 30096 USA  
**Manufacturer** : Universal Global Scientific Industrial Co., Ltd.  
**Address** : 141, Lane 351, Sec.1, Taiping Road,  
Tsaotuen, Nantou 54261, Taiwan

The product sample received on Nov. 5, 2014 and completely tested on Dec. 1, 2014. We, SPORTON, would like to declare that the tested sample has been evaluated in accordance with the procedures given in ANSI C63.10-2009 and shown compliance with the applicable technical standards.

The test results in this report apply exclusively to the tested model / sample. Without written approval of SPORTON INTERNATIONAL INC., the test report shall not be reproduced except in full.

Reviewed by:



Vic Hsiao / Supervisor





## Table of Contents

<b>1</b>	<b>GENERAL DESCRIPTION .....</b>	<b>5</b>
1.1	Information.....	5
1.2	Accessories and Support Equipment.....	7
1.3	Testing Applied Standards .....	7
1.4	Testing Location Information.....	7
1.5	Measurement Uncertainty .....	8
<b>2</b>	<b>TEST CONFIGURATION OF EUT .....</b>	<b>9</b>
2.1	The Worst Case Modulation Configuration .....	9
2.2	The Worst Case Power Setting Parameter .....	9
2.3	The Worst Case Measurement Configuration.....	10
2.4	Test Setup Diagram .....	11
<b>3</b>	<b>TRANSMITTER TEST RESULT .....</b>	<b>14</b>
3.1	AC Power-line Conducted Emissions .....	14
3.2	6dB Bandwidth .....	17
3.3	RF Output Power.....	19
3.4	Power Spectral Density .....	21
3.5	Transmitter Bandedge Emissions .....	23
3.6	Transmitter Unwanted Emissions.....	26
<b>4</b>	<b>TEST EQUIPMENT AND CALIBRATION DATA .....</b>	<b>39</b>

### APPENDIX A. TEST PHOTOS

### APPENDIX B. PHOTOGRAPHS OF EUT



### Summary of Test Result

Conformance Test Specifications					
Report Clause	Ref. Std. Clause	Description	Measured	Limit	Result
1.1.2	15.203	Antenna Requirement	Antenna connector mechanism complied	FCC 15.203	Complied
3.1	15.207	AC Power-line Conducted Emissions	[dBuV]: 0.4040020MHz 42.01 (Margin 15.76dB) - QP 37.02 (Margin 10.75dB) - AV	FCC 15.207	Complied
3.2	15.247(a)	6dB Bandwidth	LE: 700kHz	≥500kHz	Complied
3.3	15.247(b)	RF Output Power (Maximum Peak Conducted Output Power)	Power [dBm] LE: 1.44	Power [dBm] LE:30	Complied
3.4	15.247(e)	Power Spectral Density	PSD [dBm/100kHz] LE: -15.00	PSD [dBm/3kHz]: 8	Complied
3.5	15.247(d)	Transmitter Bandedge Emissions	Restricted Bands [dBuV/m at 3m]: 2493.12MHz 56.78 (Margin 17.22dB) - PK 45.11 (Margin 8.89dB) - AV	Non-Restricted Bands: > 20 dBc Restricted Bands: FCC 15.209	Complied
3.6	15.247(d)	Transmitter Unwanted Emissions	Restricted Bands [dBuV/m at 3m]: 57.16MHz 34.69 (Margin 5.31dB) - PK	Non-Restricted Bands: > 20 dBc Restricted Bands: FCC 15.209	Complied



# 1 General Description

## 1.1 Information

### 1.1.1 RF General Information

RF General Information					
Frequency Range (MHz)	Bluetooth Version	Ch. Frequency (MHz)	Channel Number	RF Output Power (dBm)	Co-location
2400-2483.5	v4.0 LE	2402-2480	0-39 [40]	1.44	Yes
<p>Note 1: Bluetooth LE (Low Energy) using GFSK modulation for DTS digital modulation.</p> <p>Note 2: RF output power specifies that Maximum Peak Conducted Output Power.</p> <p>Note 4: Co-location, Co-location is generally defined as simultaneously transmitting (co-transmitting) antennas within 20 cm of each other. (i.e., EUT has simultaneously co-transmitting that operating NFC+OSR+RFID+BT)</p>					

### 1.1.2 Antenna Information

Antenna Category	
<input checked="" type="checkbox"/>	Integral antenna (antenna permanently attached)
<input type="checkbox"/>	Temporary RF connector provided
<input checked="" type="checkbox"/>	No temporary RF connector provided Transmit chains bypass antenna and soldered temporary RF connector provided for connected measurement. In case of conducted measurements the transmitter shall be connected to the measuring equipment via a suitable attenuator and correct for all losses in the RF path.

Antenna General Information		
Ant. Cat.	Ant. Type	Gain (dBi)
Integral	PIFA	1.10



1.1.3 Type of EUT

Identify EUT	
EUT Serial Number	N/A
Presentation of Equipment	<input checked="" type="checkbox"/> Production ; <input type="checkbox"/> Pre-Production ; <input type="checkbox"/> Prototype
Type of EUT	
<input checked="" type="checkbox"/>	Stand-alone
<input type="checkbox"/>	Combined (EUT where the radio part is fully integrated within another device) Combined Equipment – Brand Name / Model No.: ...
<input type="checkbox"/>	Plug-in radio (EUT intended for a variety of host systems) Host System – Brand Name / Model No.: ...
<input type="checkbox"/>	Other:

1.1.4 Test Signal Duty Cycle

Operated Mode for Worst Duty Cycle	
<input checked="" type="checkbox"/> Operated test mode for worst duty cycle	
Test Signal Duty Cycle (x)	Power Duty Factor [dB] – (10 log 1/x)
<input checked="" type="checkbox"/> 72.10% - test mode single channel – LE	1.42

1.1.5 EUT Operational Condition

<b>Supply Voltage</b>	<input type="checkbox"/> AC mains	<input checked="" type="checkbox"/> DC	-	-
<b>Type of DC Source</b>	<input type="checkbox"/> Internal DC supply	<input checked="" type="checkbox"/> External DC Service Station	<input checked="" type="checkbox"/> From Li-ion Battery	

## 1.2 Accessories and Support Equipment

Accessories Information				
Li-ion Battery	Brand Name	NCR	Model Name	7777-0105-8801
	Power Rating	3.7V  3150mAh		
LCD Panel	Brand Name	LG Display	Model Name	LH500WX1-SD03
Camera	Brand Name	Ability	Model Name	BD56A555
WiFi Module	Brand Name	USI	Model Name	WM-BAN-BM-07_S
OSR Module	Brand Name	TI	Model Name	CC1125
RFID Module	Brand Name	Melexis	Model Name	MLX90109
NFC Module	Brand Name	NXP	Model Name	PN547

Reminder: Regarding to more detail and other information, please refer to user manual.

Support Equipment - AC Conduction and Radiated Emission				
No.	Equipment	Brand Name	Model Name	FCC ID
1	Service Station (Provide by customer)	Orderman	7779-0201-8801	-
2	Debug Board (Provide by customer)	-	-	-
3	Adapter	Meanwell	GSM36U12-P5L	-

## 1.3 Testing Applied Standards

According to the specifications of the manufacturer, the EUT must comply with the requirements of the following standards:

- ◆ 47 CFR FCC Part 15
- ◆ ANSI C63.10-2009
- ◆ FCC KDB 558074 D01 v03r02
- ◆ FCC KDB 662911 v02r01

## 1.4 Testing Location Information

Testing Location							
<input checked="" type="checkbox"/>	HWA YA	ADD	:	No. 52, Hwa Ya 1 <sup>st</sup> Rd., Hwa Ya Technology Park, Kwei-Shan Hsiang, Tao Yuan Hsien, Taiwan, R.O.C.			
		TEL	:	886-3-327-3456	FAX	:	886-3-327-0973
<b>Test Site Registration Number: FCC 636805</b>							
<b>Test Condition</b>		<b>Test Site No.</b>		<b>Test Engineer</b>		<b>Test Environment</b>	
AC Conduction		CO04-HY		Zeus		22°C / 52%	
RF Conducted		TH01-HY		Ian		22.9°C / 68%	
Radiated Emission		03CH03-HY		Allen		24°C / 57%	

## 1.5 Measurement Uncertainty

ISO/IEC 17025 requires that an estimate of the measurement uncertainties associated with the emissions test results be included in the report. The measurement uncertainties given below are based on a 95% confidence level (based on a coverage factor (k=2))

Measurement Uncertainty		
Test Item		Uncertainty
AC power-line conducted emissions		±2.3 dB
Emission bandwidth, 6dB bandwidth		±1.4 %
RF output power, conducted		±0.6 dB
Power density, conducted		±0.8 dB
Unwanted emissions, conducted	30 – 1000 MHz	±0.5 dB
	1 – 18 GHz	±0.7 dB
	18 – 40 GHz	±0.8 dB
	40 – 200 GHz	N/A
All emissions, radiated	30 – 1000 MHz	±2.6 dB
	1 – 18 GHz	±3.6 dB
	18 – 40 GHz	±3.8 dB
	40 – 200 GHz	N/A
Temperature		±0.8 °C
Humidity		±3 %
DC and low frequency voltages		±3 %
Time		±1.4 %
Duty Cycle		±1.4 %





## 2 Test Configuration of EUT

### 2.1 The Worst Case Modulation Configuration

Worst Modulation Used for Conformance Testing			
Bluetooth Version	Transmit Chains (N <sub>TX</sub> )	Data Rate	Modulation Mode
LE	1	1 Mbps	LE-1Mbps

Note 1: Bluetooth LE (Low Energy) using GFSK modulation for DTS digital modulation.  
Note 2: Modulation modes consist below configuration:  
DSSS LE-1Mbps: GFSK (1Mbps)



### 2.2 The Worst Case Power Setting Parameter

The Worst Case Power Setting Parameter			
Test Software Version	LE TX Test		
Modulation Mode	2402 MHz	2440 MHz	2480 MHz
LE-1Mbps	Default	Default	Default

### 2.3 The Worst Case Measurement Configuration

The Worst Case Mode for Following Conformance Tests	
<b>Tests Item</b>	AC power-line conducted emissions
<b>Condition</b>	AC power-line conducted measurement for line and neutral Test Voltage: 120Vac / 60Hz
<b>Operating Mode</b>	Operating Mode Description
	1. EUT with Service Station Charge Mode

The Worst Case Mode for Following Conformance Tests	
<b>Tests Item</b>	RF Output Power, Power Spectral Density, 6 dB Bandwidth
<b>Test Condition</b>	Conducted measurement at transmit chains
<b>Modulation Mode</b>	LE-1Mbps

The Worst Case Mode for Following Conformance Tests			
<b>Tests Item</b>		Transmitter Radiated Bandedge Emissions Transmitter Radiated Unwanted Emissions	
<b>Test Condition</b>		Radiated measurement	
<b>User Position</b>		<input type="checkbox"/> EUT will be placed in fixed position.	
<b>X Plane</b>	<b>Y Plane</b>	<b>Z Plane</b>	<input type="checkbox"/> EUT will be placed in mobile position and operating multiple positions.
			<input checked="" type="checkbox"/> EUT will be a hand-held or body-worn battery-powered devices and operating multiple positions. EUT shall be performed three orthogonal planes. The worst planes is Y.
<b>Operating Mode (Blow 1GHz)</b>		Operating Mode Description	
		1. EUT with Service Station Charge Mode	
		2. EUT with AC power via Debug Board Transmitter	
<b>Operating Mode (Above 1GHz)</b>		2. EUT with AC power via Debug Board Transmitter	
<b>Modulation Mode</b>		LE-1Mbps	

Note: The RF Function will be off when the EUT charge with Service Station.

## 2.4 Test Setup Diagram

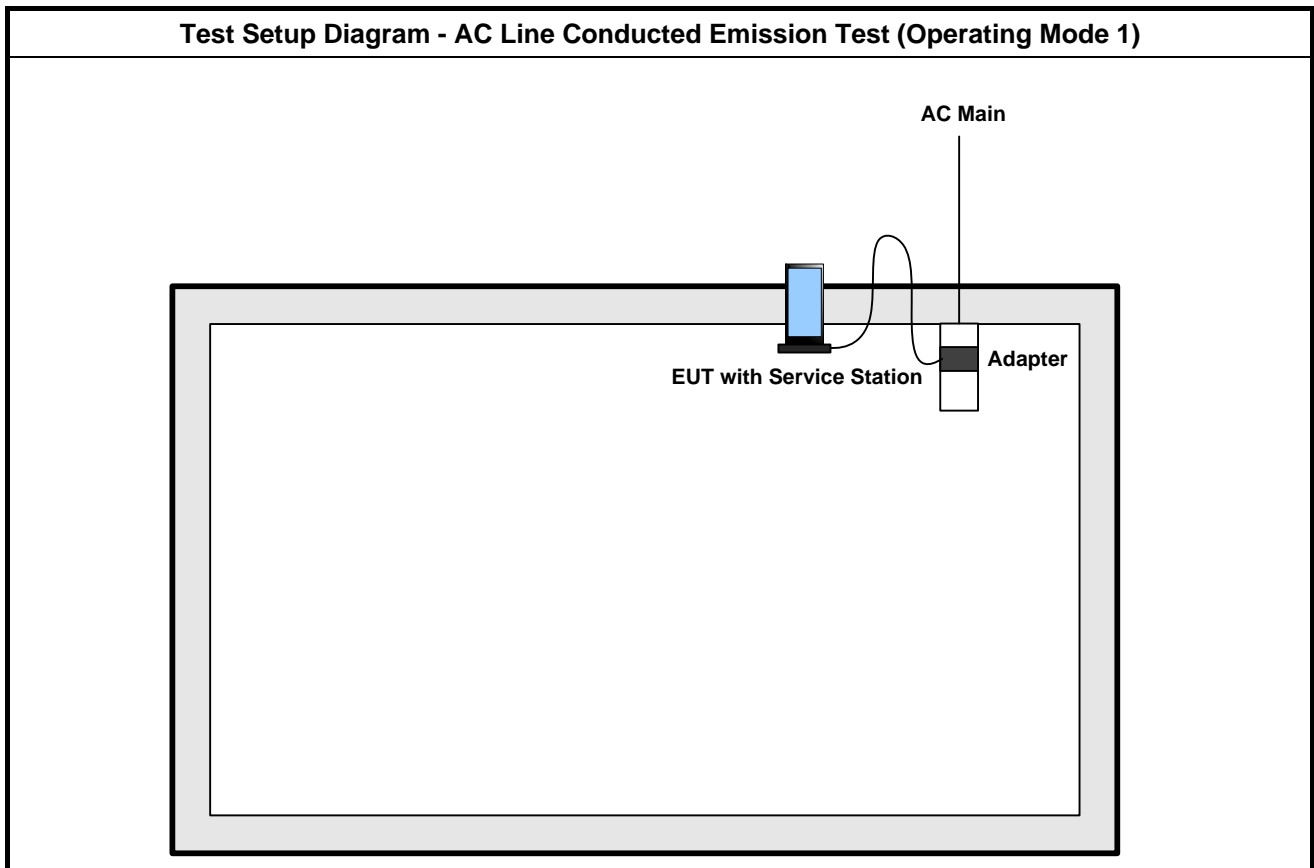

Test Setup Diagram - Radiated Test Below 1GHz (Operating Mode 1)

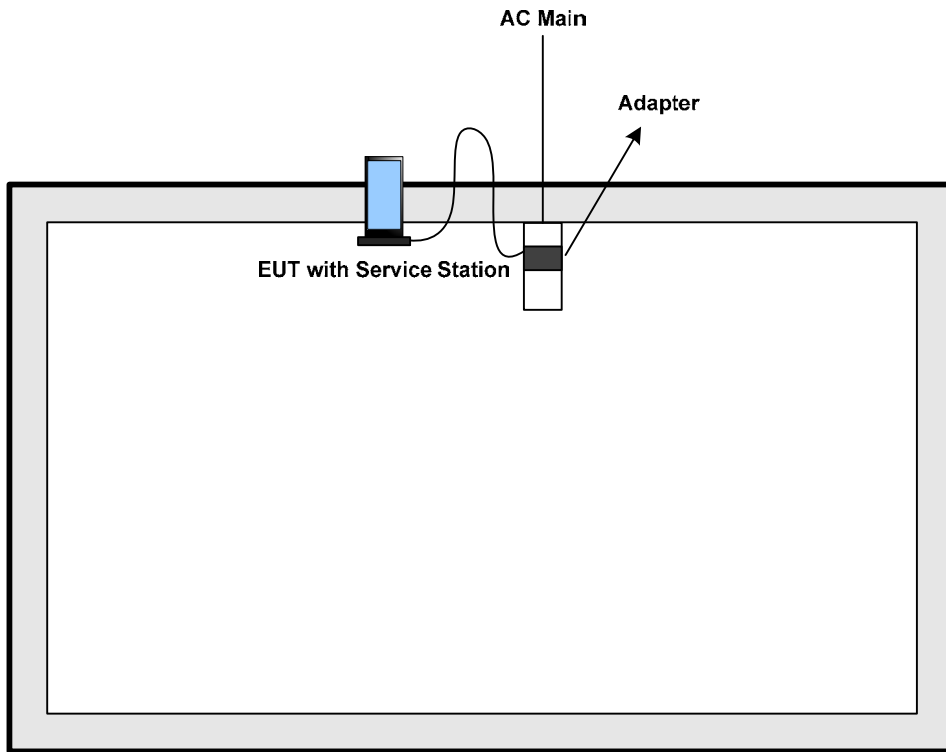

Test Setup Diagram - Radiated Test Below 1GHz (Operating Mode 2)

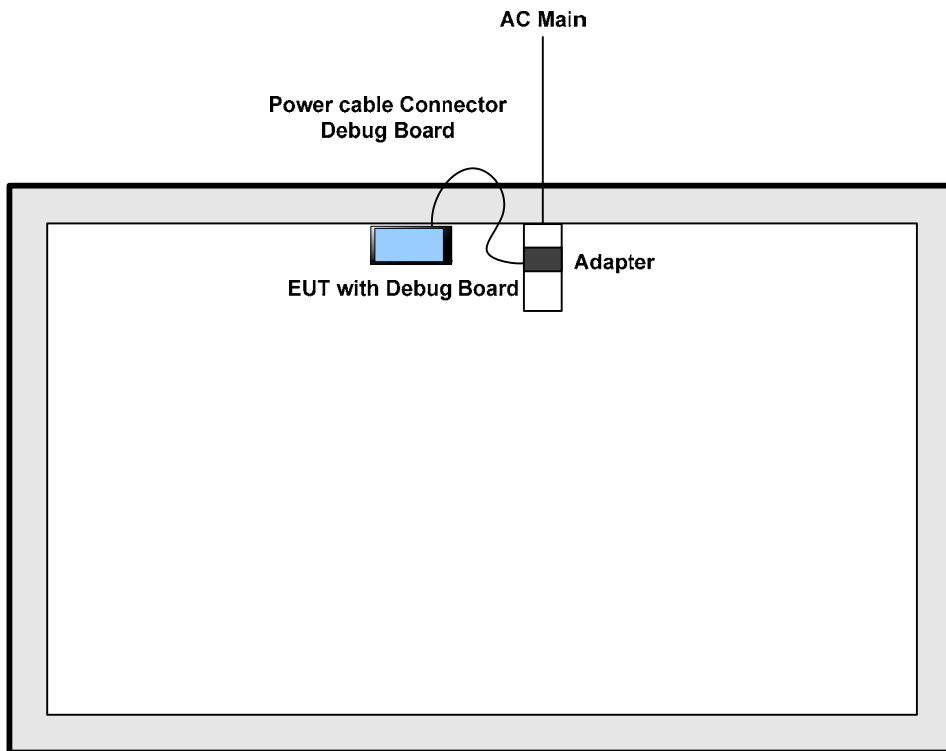

Test Setup Diagram - Radiated Test Above 1GHz (Operating Mode 2)

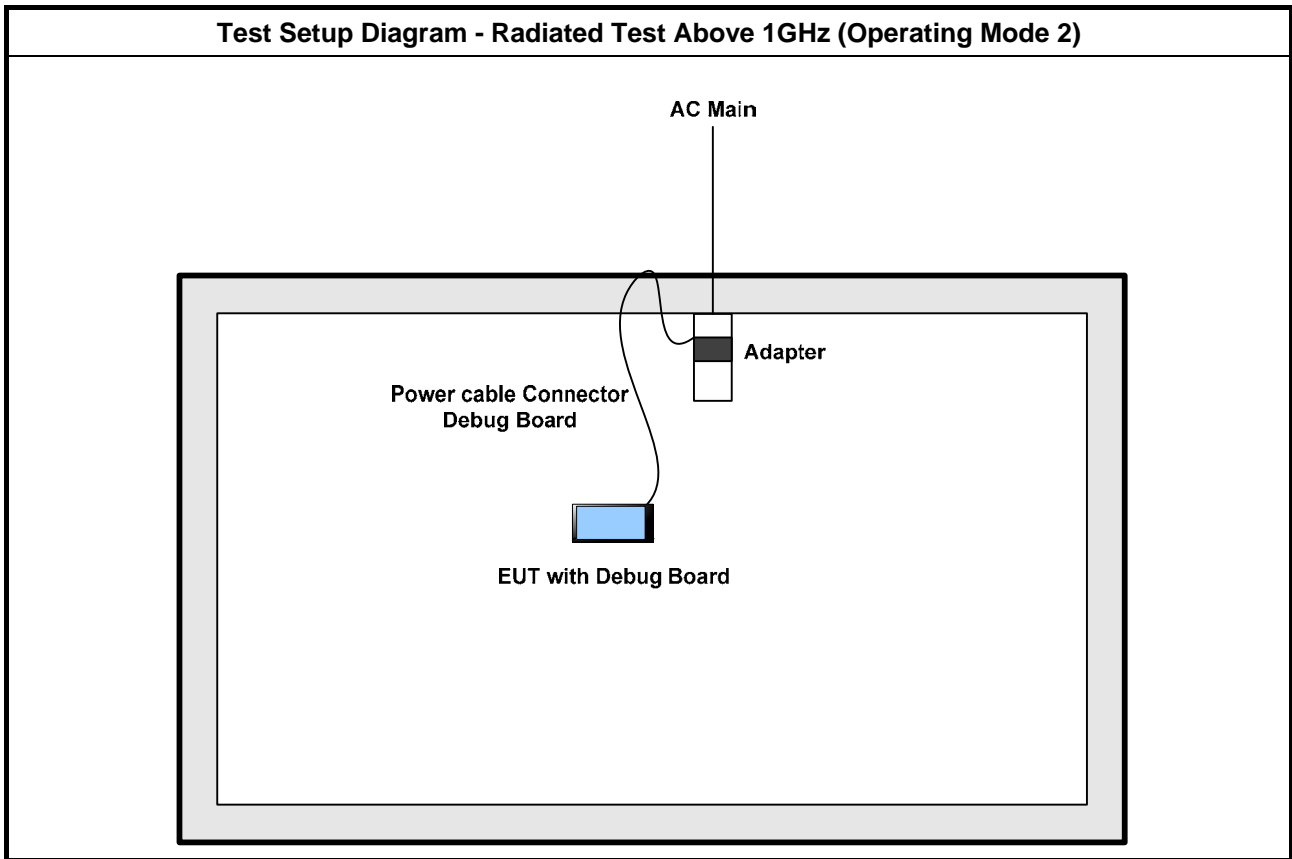

### 3 Transmitter Test Result

#### 3.1 AC Power-line Conducted Emissions

##### 3.1.1 AC Power-line Conducted Emissions Limit

AC Power-line Conducted Emissions Limit		
Frequency Emission (MHz)	Quasi-Peak	Average
0.15-0.5	66 - 56 *	56 - 46 *
0.5-5	56	46
5-30	60	50

Note 1: \* Decreases with the logarithm of the frequency.

##### 3.1.2 Measuring Instruments

Refer a test equipment and calibration data table in this test report.

##### 3.1.3 Test Procedures

Test Method
<input checked="" type="checkbox"/> Refer as ANSI C63.10-2009, clause 6.2 for AC power-line conducted emissions.

##### 3.1.4 Test Setup

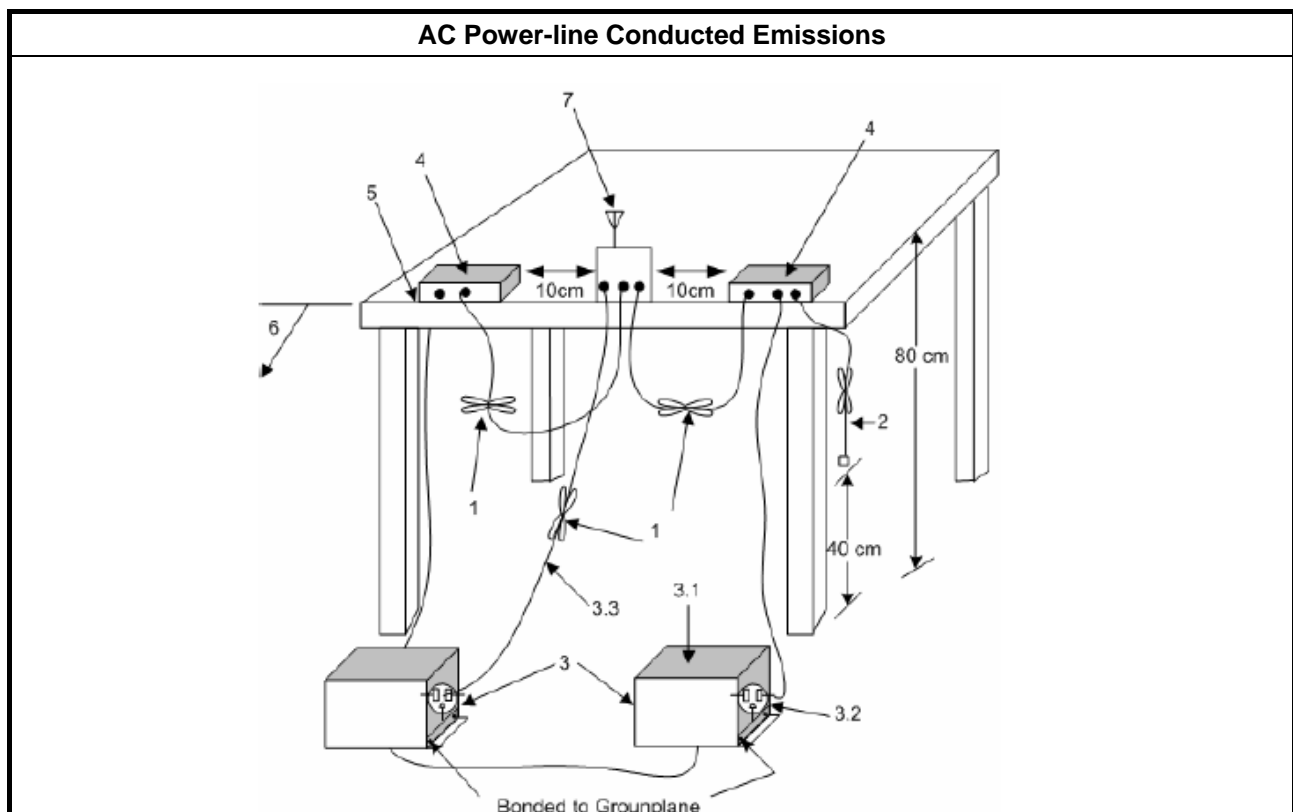

### 3.1.5 Test Result of AC Power-line Conducted Emissions

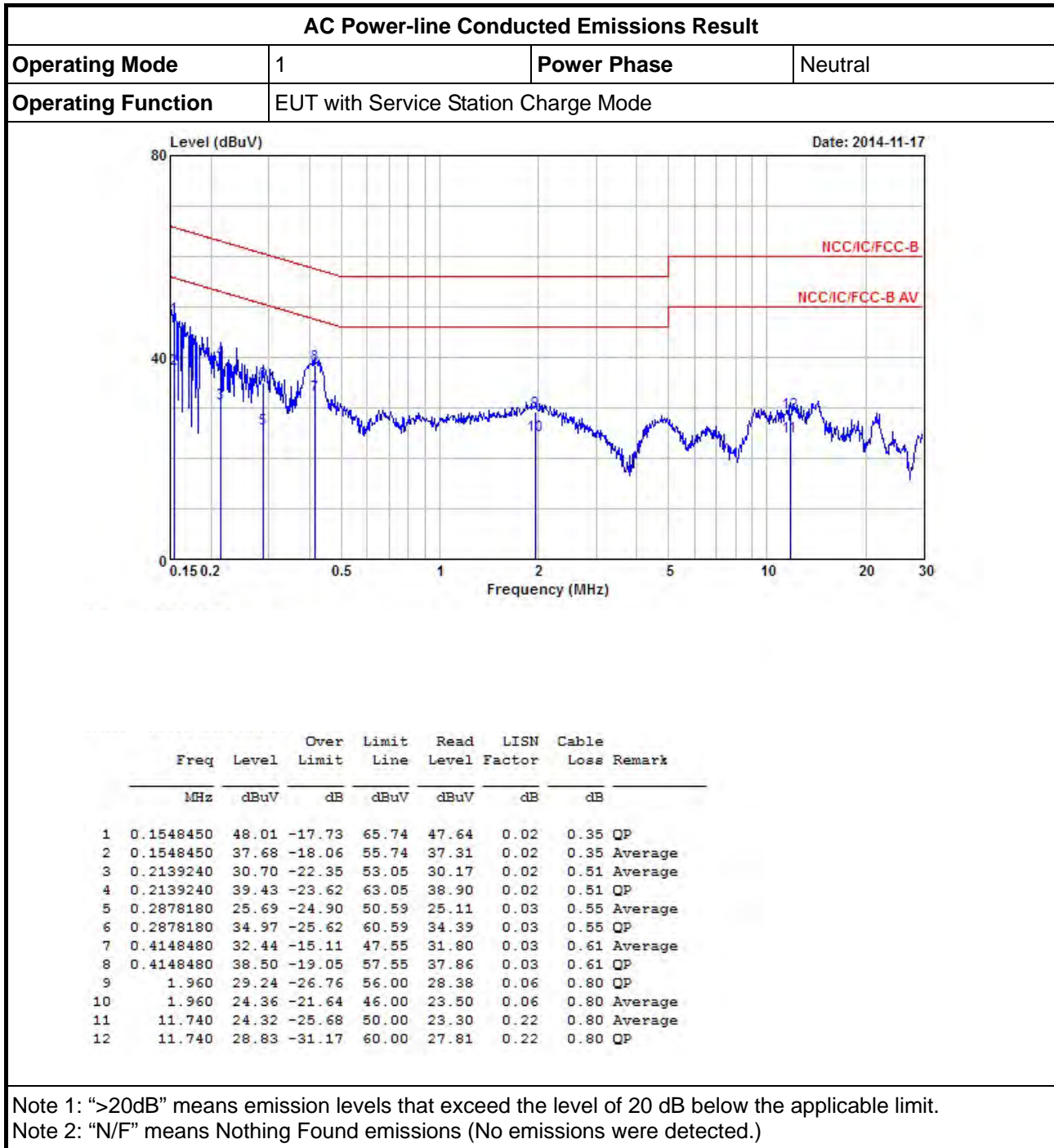

AC Power-line Conducted Emissions Result

Operating Mode	1	Power Phase	Line
Operating Function	EUT with Service Station Charge Mode		

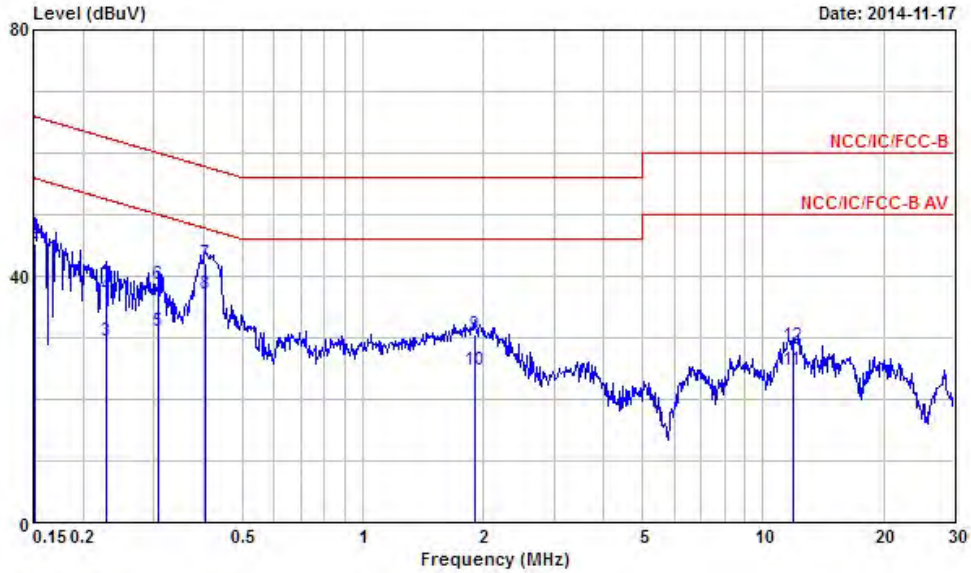

	Freq	Level	Over	Limit	Read	LISN	Cable	Remark
	MHz	dBuV	Limit	Line	Level	Factor	Loss	
			dB	dBuV	dBuV	dB	dB	
1	0.1515980	34.40	-21.51	55.91	34.03	0.03	0.34	Average
2	0.1515980	45.23	-20.68	65.91	44.86	0.03	0.34	QP
3	0.2279670	29.58	-22.94	52.52	29.03	0.03	0.52	Average
4	0.2279670	36.95	-25.57	62.52	36.40	0.03	0.52	QP
5	0.3083410	30.93	-19.09	50.02	30.34	0.03	0.56	Average
6	0.3083410	38.55	-21.47	60.02	37.96	0.03	0.56	QP
7	0.4040020	42.01	-15.76	57.77	41.38	0.03	0.60	QP
8	0.4040020	37.02	-10.75	47.77	36.39	0.03	0.60	Average
9	1.900	30.65	-25.35	56.00	29.78	0.07	0.80	QP
10	1.900	24.61	-21.39	46.00	23.74	0.07	0.80	Average
11	11.870	24.65	-25.35	50.00	23.63	0.22	0.80	Average
12	11.870	28.81	-31.19	60.00	27.79	0.22	0.80	QP

Note 1: ">20dB" means emission levels that exceed the level of 20 dB below the applicable limit.  
 Note 2: "N/F" means Nothing Found emissions (No emissions were detected.)



### 3.2 6dB Bandwidth

#### 3.2.1 6dB Bandwidth Limit

6dB Bandwidth Limit	
Systems using digital modulation techniques:	
<input checked="" type="checkbox"/>	6 dB bandwidth $\geq$ 500 kHz.

#### 3.2.2 Measuring Instruments

Refer a test equipment and calibration data table in this test report.

#### 3.2.3 Test Procedures

Test Method	
<input checked="" type="checkbox"/>	For the emission bandwidth shall be measured using one of the options below:
<input checked="" type="checkbox"/>	Refer as FCC KDB 558074 D01 v03r02, clause 8.1 Option 1 for 6 dB bandwidth measurement.
<input type="checkbox"/>	Refer as FCC KDB 558074 D01 v03r02, clause 8.2 Option 2 for 6 dB bandwidth measurement.
<input type="checkbox"/>	Refer as ANSI C63.10, clause 6.9.1 for occupied bandwidth testing.
<input checked="" type="checkbox"/>	For conducted measurement.
<input checked="" type="checkbox"/>	The EUT supports single transmit chain and measurements performed on this transmit chain.
<input type="checkbox"/>	The EUT supports diversity transmitting and the results on transmit chain port 1 is the worst case.

#### 3.2.4 Test Setup

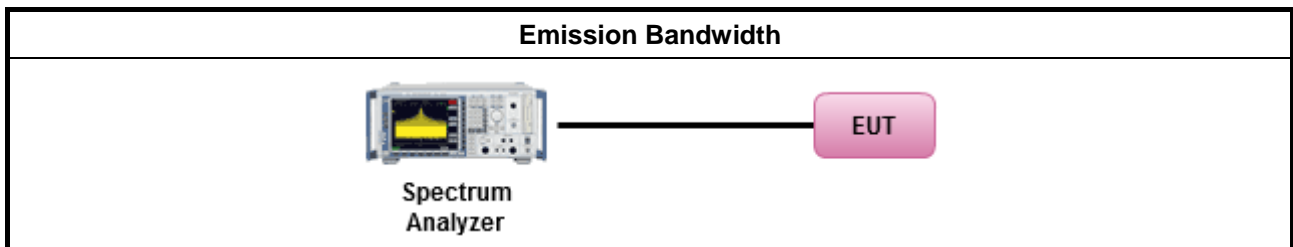



3.2.5 Test Result of Emission Bandwidth

Emission Bandwidth Result			
Modulation Mode	Freq. (MHz)	99% Bandwidth (kHz)	6dB Bandwidth (kHz)
LE-1Mbps	2402	1036.9820	740.0000
LE-1Mbps	2440	1041.9790	700.0000
LE-1Mbps	2480	1016.9920	710.0000
Limit		N/A	≥500 kHz
Result		Complied	

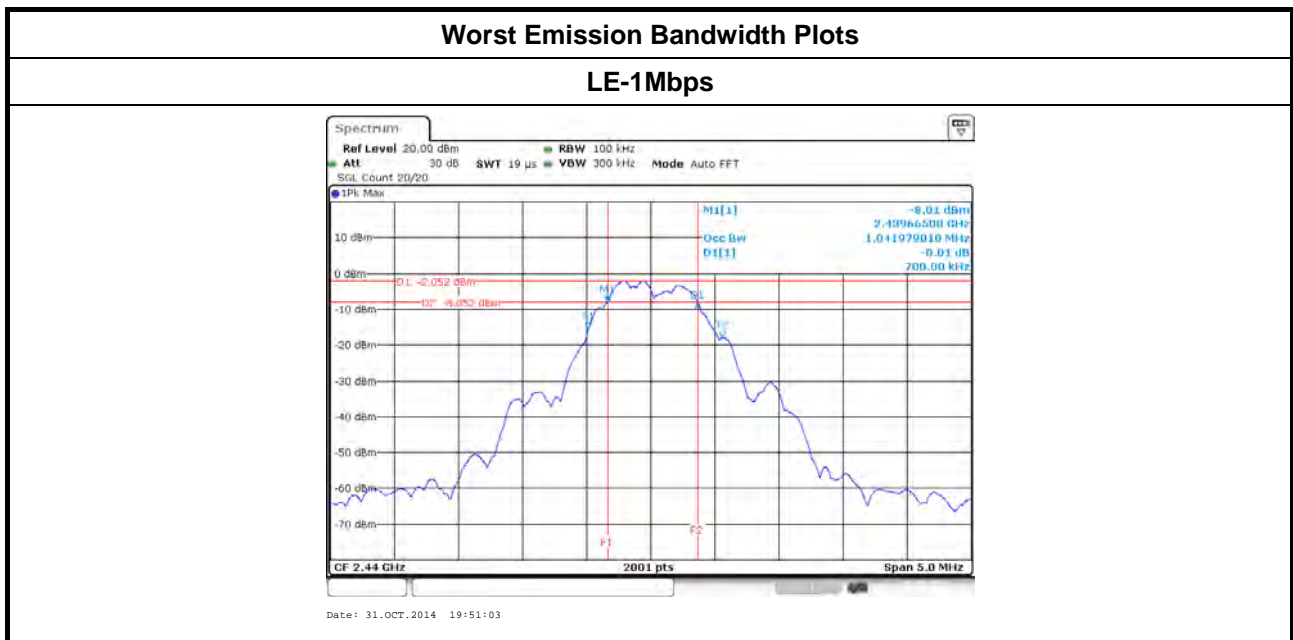

### 3.3 RF Output Power

#### 3.3.1 RF Output Power Limit

RF Output Power Limit for Digital Modulation Systems	
<b>Maximum Peak Conducted Output Power or Maximum Conducted Output Power Limit</b>	
<input checked="" type="checkbox"/> 2400-2483.5 MHz Band:	
<input checked="" type="checkbox"/>	If $G_{TX} \leq 6$ dBi, then $P_{Out} \leq 30$ dBm (1 W)
<input type="checkbox"/>	Point-to-multipoint systems (P2M): If $G_{TX} > 6$ dBi, then $P_{Out} = 30 - (G_{TX} - 6)$ dBm
<b>e.i.r.p. Power Limit:</b>	
<input checked="" type="checkbox"/> 2400-2483.5 MHz Band	
<input checked="" type="checkbox"/>	Point-to-multipoint systems (P2M): $P_{eirp} \leq 36$ dBm (4 W)
$P_{Out}$ = maximum peak conducted output power or maximum conducted output power in dBm, $G_{TX}$ = the maximum transmitting antenna directional gain in dBi. $P_{eirp}$ = e.i.r.p. Power in dBm.	

#### 3.3.2 Measuring Instruments

Refer a test equipment and calibration data table in this test report.

#### 3.3.3 Test Procedures

Test Method	
<input checked="" type="checkbox"/> Maximum Peak Conducted Output Power	
<input checked="" type="checkbox"/>	Refer as ANSI C63.10, clause 6.10.2.1 a) for peak power meter.
<input type="checkbox"/>	Refer as ANSI C63.10, clause 6.10.2.1 a) for spectrum analyzer - (RBW $\geq$ EBW).
<input checked="" type="checkbox"/> For conducted measurement.	
<input checked="" type="checkbox"/>	The EUT supports single transmit chain and measurements performed on this transmit chain.
<input type="checkbox"/>	The EUT supports diversity transmitting and the results on transmit chain port 1 is the worst case.

#### 3.3.4 Test Setup

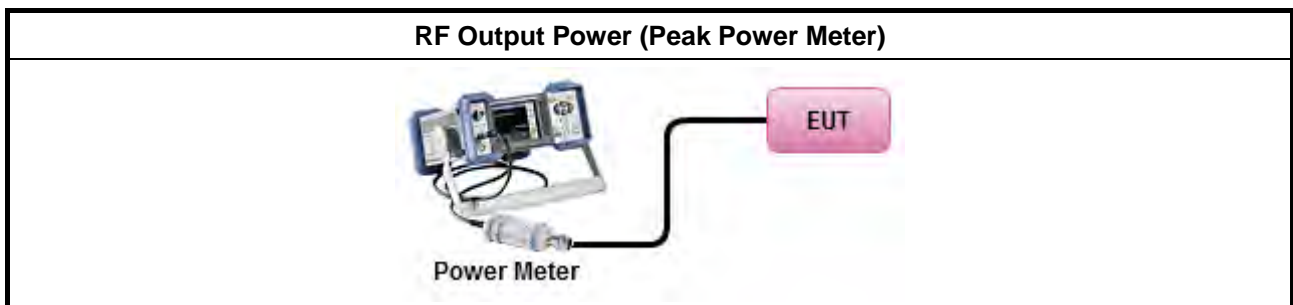



3.3.5 Test Result of Maximum Peak Conducted Output Power

Maximum Peak Conducted Output Power Result						
Condition		RF Output Power (dBm)				
Modulation Mode	Freq. (MHz)	RF Output Power	Power Limit	Antenna Gain (dBi)	EIRP Power	EIRP Limit
LE-1Mbps	2402	0.96	30	1.10	2.06	36
LE-1Mbps	2440	1.44	30	1.10	2.54	36
LE-1Mbps	2480	-0.79	30	1.10	0.31	36
Result		Complied				

3.3.6 Test Result of Maximum Average Conducted Output Power

Maximum Average Conducted Output Power Result						
Condition		RF Output Power (dBm)				
Modulation Mode	Freq. (MHz)	Average Power	Duty Factor (dB)	RF Output Power	Antenna Gain (dBi)	EIRP Power
LE-1Mbps	2402	-1.25	1.42	0.17	1.10	1.27
LE-1Mbps	2440	-0.74	1.42	0.68	1.10	1.78
LE-1Mbps	2480	-2.99	1.42	-1.57	1.10	-0.47
Result		Complied				

### 3.4 Power Spectral Density

#### 3.4.1 Power Spectral Density Limit

Power Spectral Density Limit
<input checked="" type="checkbox"/> Power Spectral Density (PSD) $\leq$ 8 dBm/3kHz

#### 3.4.2 Measuring Instruments

Refer a test equipment and calibration data table in this test report.

#### 3.4.3 Test Procedures

Test Method
<input checked="" type="checkbox"/> Peak power spectral density procedures that the same method as used to determine the conducted output power. If maximum peak conducted output power was measured to demonstrate compliance to the output power limit, then the peak PSD procedure below (Method PKPSD) shall be used. If maximum conducted output power was measured to demonstrate compliance to the output power limit, then one of the average PSD procedures shall be used, as applicable based on the following criteria (the peak PSD procedure is also an acceptable option).
<input checked="" type="checkbox"/> Refer as FCC KDB 558074 D01 v03r02, clause 10.2 Method PKPSD (RBW=3-100kHz;detector=peak)..
[duty cycle $\geq$ 98% or external video / power trigger]
<input type="checkbox"/> Refer as FCC KDB 558074 D01 v03r02, clause 10.3 Method AVGPS-1 (spectral trace averaging).
<input type="checkbox"/> Refer as FCC KDB 558074 D01 v03r02, clause 10.4 Method AVGPS-1 Alt. (slow sweep speed)
duty cycle $<$ 98% and average over on/off periods with duty factor
<input checked="" type="checkbox"/> Refer as FCC KDB 558074 D01 v03r02, clause 10.5 Method AVGPS-2 (spectral trace averaging).
<input type="checkbox"/> Refer as FCC KDB 558074 D01 v03r02, clause 10.6 Method AVGPS-2 Alt. (slow sweep speed)
<input checked="" type="checkbox"/> For conducted measurement.
<input checked="" type="checkbox"/> The EUT supports single transmit chain and measurements performed on this transmit chain.
<input type="checkbox"/> The EUT supports diversity transmitting and the results on transmit chain port 1 is the worst case.

#### 3.4.4 Test Setup

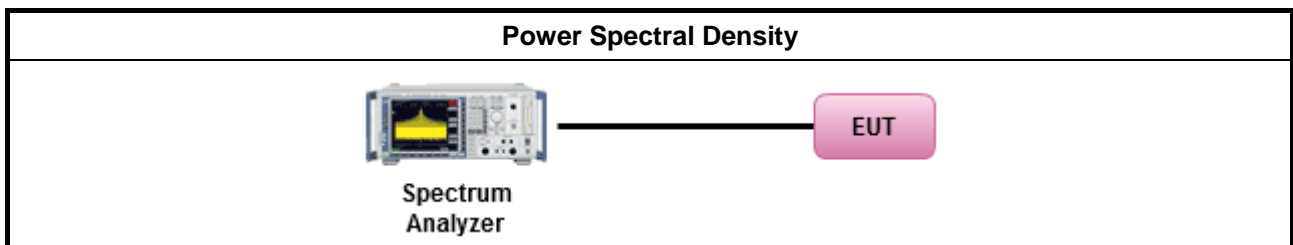

3.4.5 Test Result of Power Spectral Density

Power Spectral Density Result			
Modulation Mode	Freq. (MHz)	PSD (dBm/100kHz)	PSD Limit (dBm/3kHz)
LE-1Mbps	2402	-15.63	8
LE-1Mbps	2440	-15.00	8
LE-1Mbps	2480	-17.61	8
<b>Result</b>		<b>Complied</b>	

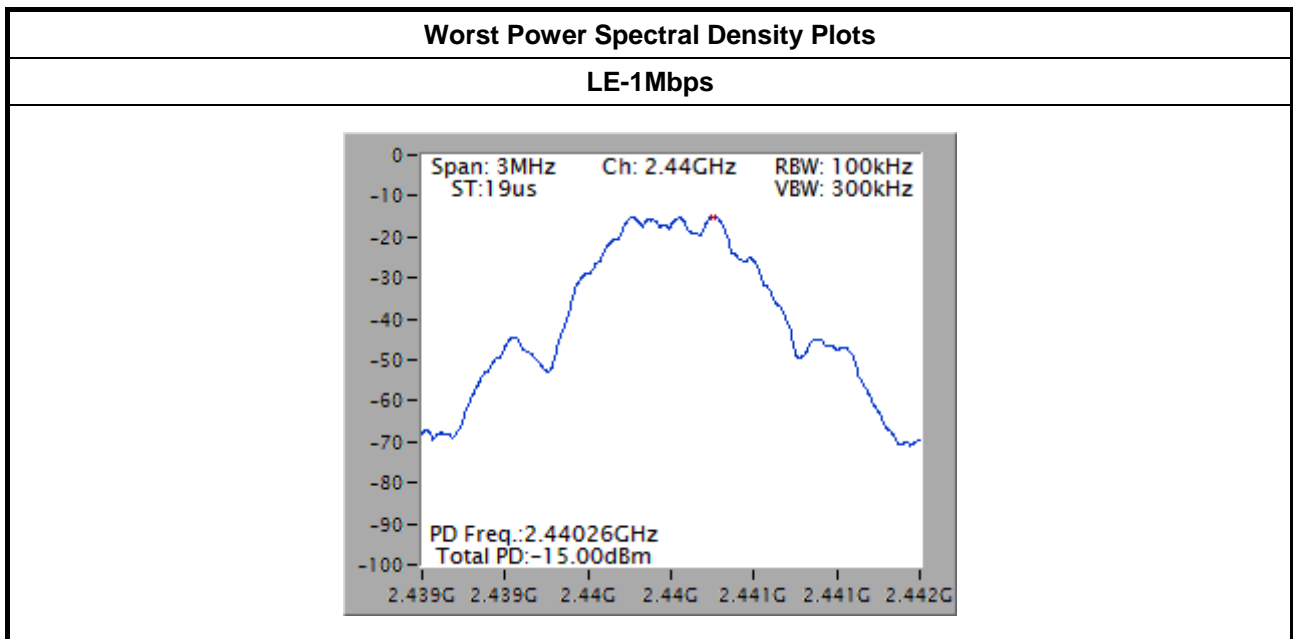

### 3.5 Transmitter Bandedge Emissions

#### 3.5.1 Transmitter Radiated Bandedge Emissions Limit

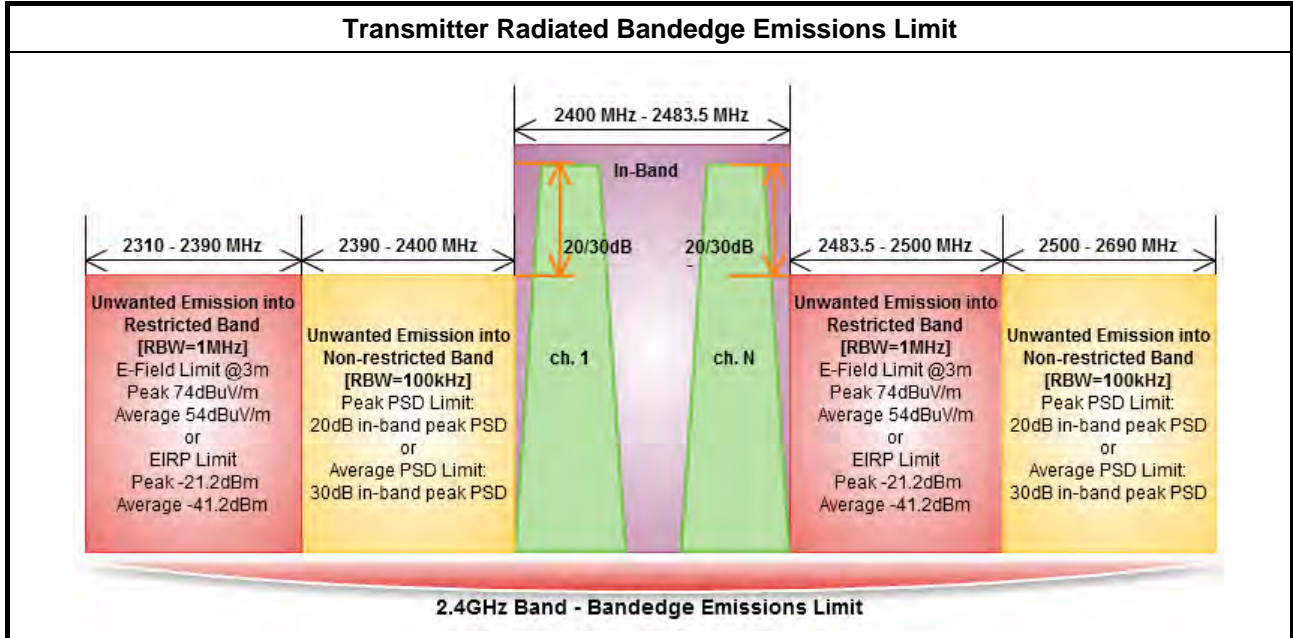

#### 3.5.2 Measuring Instruments

Refer a test equipment and calibration data table in this test report.



3.5.3 Test Procedures

Test Method	
<input checked="" type="checkbox"/>	The average emission levels shall be measured in [duty cycle $\geq$ 98 or duty factor].
<input checked="" type="checkbox"/>	Refer as ANSI C63.10, clause 6.9.2.2 bandedge testing shall be performed at the lowest frequency channel and highest frequency channel within the allowed operating band.
<input checked="" type="checkbox"/>	For the transmitter unwanted emissions shall be measured using following options below:
<input checked="" type="checkbox"/>	Refer as FCC KDB 558074 D01 v03r02, clause 11 for unwanted emissions into non-restricted bands.
<input checked="" type="checkbox"/>	Refer as FCC KDB 558074 D01 v03r02, clause 12 for unwanted emissions into restricted bands.
<input type="checkbox"/>	Refer as FCC KDB 558074 D01 v03r02, clause 12.2.5.1 Option 1 (trace averaging for duty cycle $\geq$ 98%)
<input type="checkbox"/>	Refer as FCC KDB 558074 D01 v03r02, clause 12.2.5.2 Option 2 (trace averaging + duty factor).
<input checked="" type="checkbox"/>	Refer as FCC KDB 558074 D01 v03r02, clause 12.2.5.3 Option 3 (Reduced VBW $\geq$ 1/T).
<input type="checkbox"/>	Refer as ANSI C63.10, clause 4.2.3.2.3 (Reduced VBW). VBW $\geq$ 1/T, where T is pulse time.
<input type="checkbox"/>	Refer as ANSI C63.10, clause 4.2.3.2.4 average value of pulsed emissions.
<input checked="" type="checkbox"/>	Refer as FCC KDB 558074 D01 v03r02, clause 11.3 and 12.2.4 measurement procedure peak limit.
<input checked="" type="checkbox"/>	For the transmitter bandedge emissions shall be measured using following options below:
<input type="checkbox"/>	Refer as FCC KDB 558074 D01 v03r02, clause 13.3 for narrower resolution bandwidth (100kHz) using the band power and summing the spectral levels (i.e., 1 MHz).
<input checked="" type="checkbox"/>	Refer as ANSI C63.10, clause 6.9.2 for band-edge testing.
<input type="checkbox"/>	Refer as ANSI C63.10, clause 6.9.3 for marker-delta method for band-edge measurements.
<input checked="" type="checkbox"/>	For radiated measurement, refer as FCC KDB 558074 D01 v03r02, clause 12.2.7 and ANSI C63.10, clause 6.6. Test distance is 3m.
<input type="checkbox"/>	For conducted measurement, refer as FCC KDB 558074 D01 v03r02, clause 12.2.2.



### 3.5.4 Test Setup

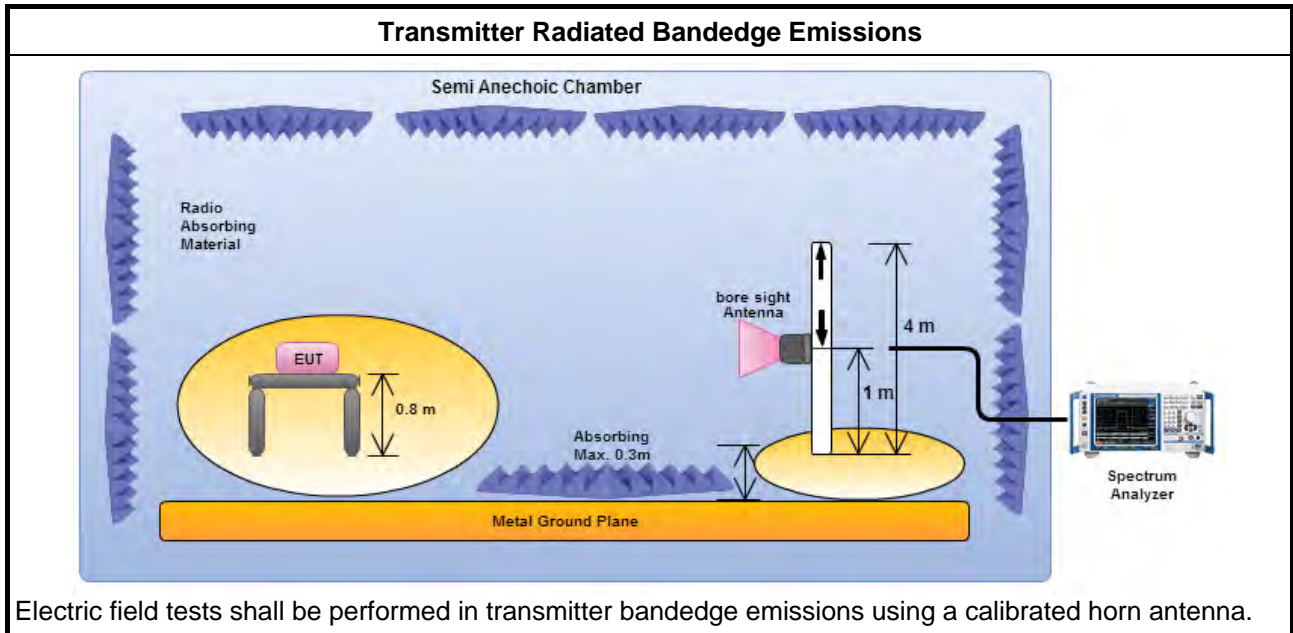

### 3.5.5 Transmitter Radiated Bandedge Emissions

2400-2483.5MHz Transmitter Radiated Bandedge Emissions (Non-restricted Band)								
Modulation	N <sub>TX</sub>	Test Freq. (MHz)	In-band PSD [i] (dBuV/m)	Freq. (MHz)	Out-band PSD [o] (dBuV/m)	[i] – [o] (dB)	Limit (dB)	Pol.
LE-1Mbps	1	2402	93.64	3690.78	60.04	33.60	20	H
LE-1Mbps	1	2480	88.03	2533.44	60.67	27.36	20	H

Note 1: Measurement worst emissions of receive antenna polarization.  
 Note 2: RBW was set to be 100kHz and VBW was 300kHz.

2400-2483.5MHz Transmitter Radiated Bandedge Emissions (Restricted Band)										
Modulation Mode	N <sub>TX</sub>	Freq. (MHz)	Measure Distance (m)	Freq. (MHz) PK	Level (dBuV/m) PK	Limit (dBuV/m) PK	Freq. (MHz) AV	Level (dBuV/m) AV	Limit (dBuV/m) AV	Pol.
LE-1Mbps	1	2402	3	2318.16	56.74	74	2367.12	44.79	54	H
LE-1Mbps	1	2480	3	2499.68	56.78	74	2493.12	45.11	54	H

Note 1: Measurement worst emissions of receive antenna polarization.  
 Note 2: Average emission setting: RBW=1MHz; VBW ≥ 1/T, where T is "Pulse On Time", e.g., LE VBW ≥ 1/625us, VBW=3kHz.

### 3.6 Transmitter Unwanted Emissions

#### 3.6.1 Transmitter Radiated Unwanted Emissions Limit

Restricted Band Emissions Limit			
Frequency Range (MHz)	Field Strength (uV/m)	Field Strength (dBuV/m)	Measure Distance (m)
0.009~0.490	2400/F(kHz)	48.5 - 13.8	300
0.490~1.705	24000/F(kHz)	33.8 - 23	30
1.705~30.0	30	29	30
30~88	100	40	3
88~216	150	43.5	3
216~960	200	46	3
Above 960	500	54	3

Note 1: Test distance for frequencies at or above 30 MHz, measurements may be performed at a distance other than the limit distance provided they are not performed in the near field and the emissions to be measured can be detected by the measurement equipment. When performing measurements at a distance other than that specified, the results shall be extrapolated to the specified distance using an extrapolation factor of 20 dB/decade (inverse of linear distance for field-strength measurements, inverse of linear distance-squared for power-density measurements).

Note 2: Test distance for frequencies at below 30 MHz, measurements may be performed at a distance closer than the EUT limit distance; however, an attempt should be made to avoid making measurements in the near field. When performing measurements below 30 MHz at a closer distance than the limit distance, the results shall be extrapolated to the specified distance by either making measurements at a minimum of two or more distances on at least one radial to determine the proper extrapolation factor or by using the square of an inverse linear distance extrapolation factor (40 dB/decade). The test report shall specify the extrapolation method used to determine compliance of the EUT.

Un-restricted Band Emissions Limit	
RF output power procedure	Limit (dB)
Peak output power procedure	20
Average output power procedure	30

Note 1: If the peak output power procedure is used to measure the fundamental emission power to demonstrate compliance to requirements, then the peak conducted output power measured within any 100 kHz outside the authorized frequency band shall be attenuated by at least 20 dB relative to the maximum measured in-band peak PSD level.

Note 2: If the average output power procedure is used to measure the fundamental emission power to demonstrate compliance to requirements, then the power in any 100 kHz outside of the authorized frequency band shall be attenuated by at least 30 dB relative to the maximum measured in-band average PSD level.

#### 3.6.2 Measuring Instruments

Refer a test equipment and calibration data table in this test report.



3.6.3 Test Procedures

Test Method	
<input checked="" type="checkbox"/>	Measurements may be performed at a distance other than the limit distance provided they are not performed in the near field and the emissions to be measured can be detected by the measurement equipment. When performing measurements at a distance other than that specified, the results shall be extrapolated to the specified distance using an extrapolation factor of 20 dB/decade (inverse of linear distance for field-strength measurements, inverse of linear distance-squared for power-density measurements).
<input type="checkbox"/>	Measurements in the frequency range 10 GHz - 18GHz are typically made at a closer distance 1m, because the instrumentation noise floor is typically close to the radiated emission limit.
<input type="checkbox"/>	Measurements in the frequency range above 18 GHz - 25GHz are typically made at a closer distance 0.5m, because the instrumentation noise floor is typically close to the radiated emission limit.
<input checked="" type="checkbox"/>	The average emission levels shall be measured in [duty cycle $\geq$ 98 or duty factor].
<input checked="" type="checkbox"/>	For the transmitter unwanted emissions shall be measured using following options below:
<input checked="" type="checkbox"/>	Refer as FCC KDB 558074 D01 v03r02, clause 11 for unwanted emissions into non-restricted bands.
<input checked="" type="checkbox"/>	Refer as FCC KDB 558074 D01 v03r02, clause 12 for unwanted emissions into restricted bands.
<input type="checkbox"/>	Refer as FCC KDB 558074 D01 v03r02, clause 12.2.5.1 Option 1 (trace averaging for duty cycle $\geq$ 98%)
<input type="checkbox"/>	Refer as FCC KDB 558074 D01 v03r02, clause 12.2.5.2 Option 2 (trace averaging + duty factor).
<input checked="" type="checkbox"/>	Refer as FCC KDB 558074 D01 v03r02, clause 12.2.5.3 Option 3 (Reduced VBW $\geq$ 1/T).
<input type="checkbox"/>	Refer as ANSI C63.10, clause 4.2.3.2.3 (Reduced VBW). VBW $\geq$ 1/T, where T is pulse time.
<input type="checkbox"/>	Refer as ANSI C63.10, clause 4.2.3.2.4 average value of pulsed emissions.
<input checked="" type="checkbox"/>	Refer as FCC KDB 558074 D01 v03r02, clause 11.3 and 12.2.4 measurement procedure peak limit.
<input checked="" type="checkbox"/>	Refer as FCC KDB 558074 D01 v03r02, clause 12.2.3 measurement procedure Quasi-Peak limit.
<input checked="" type="checkbox"/>	For radiated measurement, refer as FCC KDB 558074 D01 v03r02, clause 12.2.7.
<input checked="" type="checkbox"/>	Refer as ANSI C63.10, clause 6.4 for radiated emissions below 30 MHz and test distance is 3m.
<input checked="" type="checkbox"/>	Refer as ANSI C63.10, clause 6.5 for radiated emissions 30 MHz to 1 GHz and test distance is 3m.
<input checked="" type="checkbox"/>	Refer as ANSI C63.10, clause 6.6 for radiated emissions above 1 GHz and test distance is 3m.
<input type="checkbox"/>	For conducted and cabinet radiation measurement, refer as FCC KDB 558074 D01 v03r02, clause 12.2.2.

### 3.6.4 Test Setup

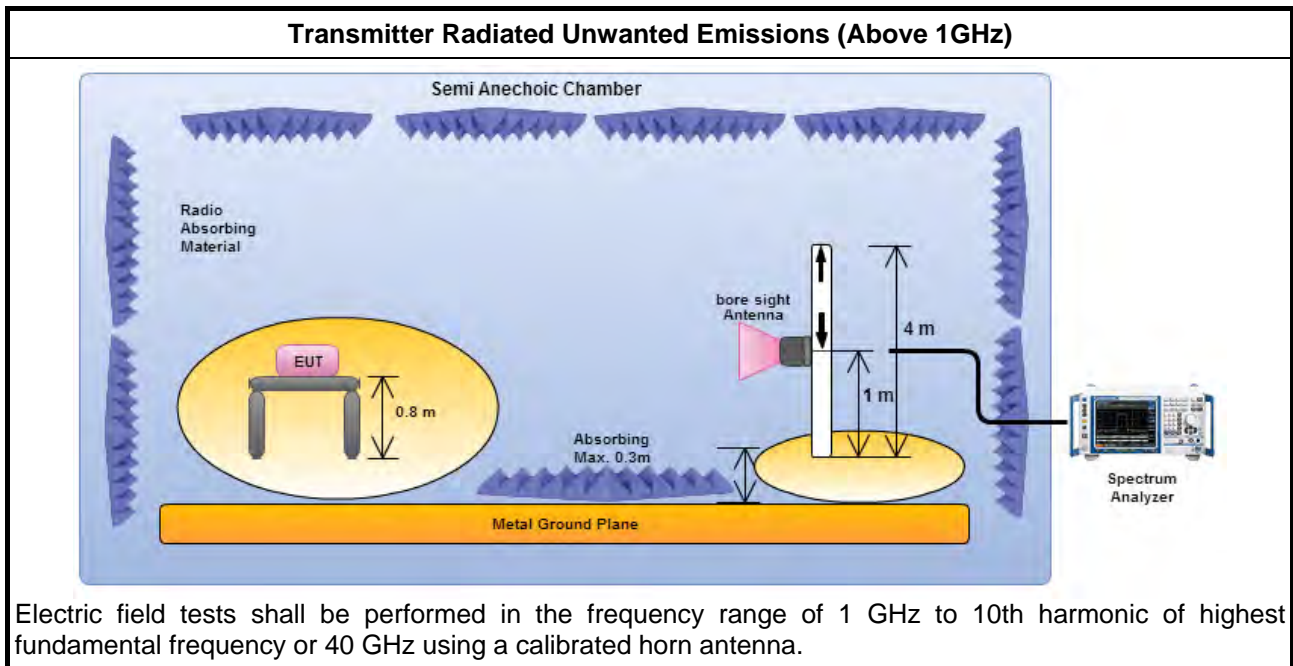
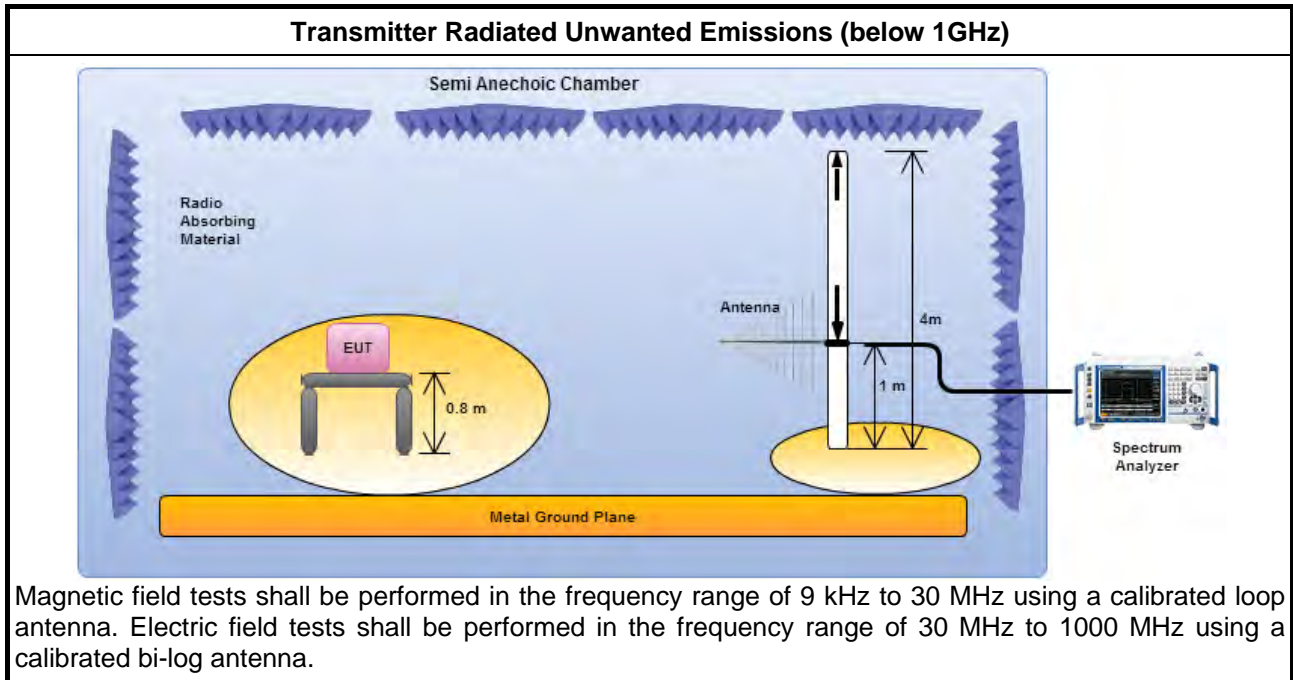

### 3.6.5 Transmitter Radiated Unwanted Emissions (Below 30MHz)

All amplitude of spurious emissions that are attenuated by more than 20 dB below the permissible value has no need to be reported.



3.6.6 Transmitter Radiated Unwanted Emissions (Below 1GHz)

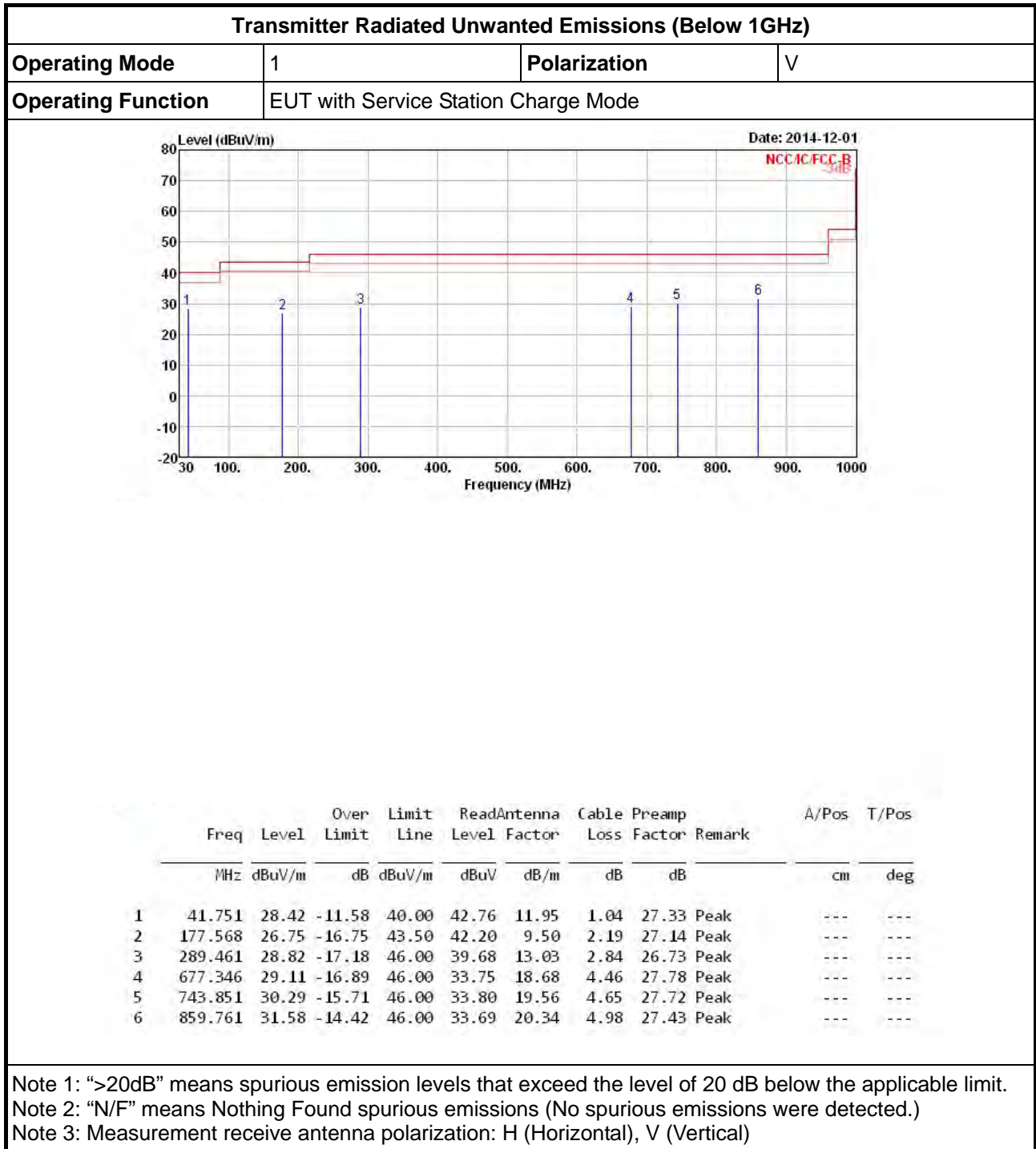



Transmitter Radiated Unwanted Emissions (Below 1GHz)

Operating Mode	1	Polarization	H
Operating Function	EUT with Service Station Charge Mode		

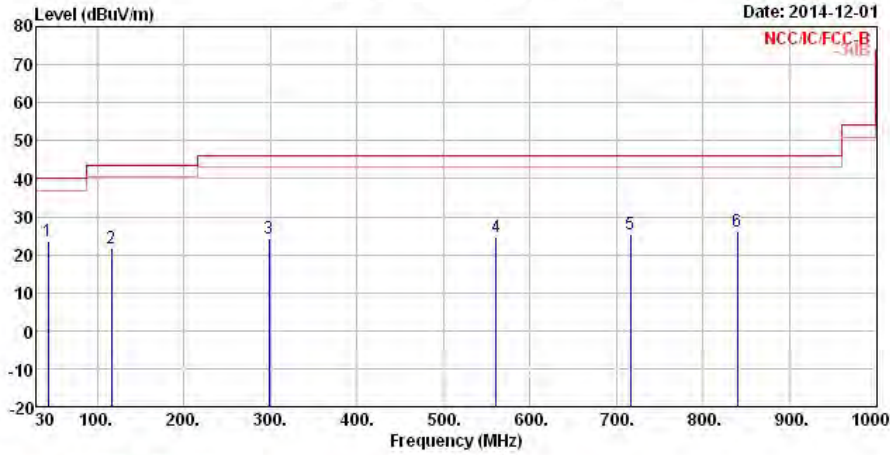

	Freq	Level	Over Limit	Limit Line	ReadAntenna Level	Antenna Factor	Cable Loss	Preamplifier Factor	Remark	A/Pos	T/Pos
	MHz	dBuV/m	dB	dBuV/m	dBuV	dB/m	dB	dB		cm	deg
1	43.421	23.62	-16.38	40.00	39.08	10.82	1.06	27.34	Peak	---	---
2	116.253	21.69	-21.81	43.50	34.97	12.15	1.75	27.18	Peak	---	---
3	298.150	24.26	-21.74	46.00	34.87	13.19	2.89	26.69	Peak	---	---
4	561.238	24.75	-21.25	46.00	30.31	18.31	3.97	27.84	Peak	---	---
5	715.853	25.37	-20.63	46.00	29.44	19.10	4.59	27.76	Peak	---	---
6	839.457	26.12	-19.88	46.00	28.49	20.19	4.93	27.49	Peak	---	---

Note 1: ">20dB" means spurious emission levels that exceed the level of 20 dB below the applicable limit.  
 Note 2: "N/F" means Nothing Found spurious emissions (No spurious emissions were detected.)  
 Note 3: Measurement receive antenna polarization: H (Horizontal), V (Vertical)



Transmitter Radiated Unwanted Emissions											
Operating Mode	2			Polarization	V						
Operating Function	EUT with AC power via Debug Board Transmitter										
<div style="text-align: right;">Date: 2014-11-07</div>											
	Freq	Level	Over Limit	Limit Line	ReadAntenna Level	Antenna Factor	Cable Loss	Preamp Factor	Remark	A/Pos	T/Pos
	MHz	dBuV/m	dB	dBuV/m	dBuV	dB/m	dB	dB		cm	deg
1	57.160	34.69	-5.31	40.00	53.97	6.93	1.21	27.42	Peak	---	---
2	84.320	32.32	-7.68	40.00	50.32	7.83	1.50	27.33	Peak	---	---
3	243.400	23.11	-22.89	46.00	35.39	12.09	2.57	26.94	Peak	---	---
4	778.840	25.87	-20.13	46.00	28.93	19.79	4.81	27.66	Peak	---	---
5	856.440	27.30	-18.70	46.00	29.46	20.32	4.96	27.44	Peak	---	---
6	943.740	27.65	-18.35	46.00	28.88	20.81	5.31	27.35	Peak	---	---
<p>Note 1: "&gt;20dB" means spurious emission levels that exceed the level of 20 dB below the applicable limit.            Note 2: "N/F" means Nothing Found spurious emissions (No spurious emissions were detected.)            Note 3: Measurement receive antenna polarization: H (Horizontal), V (Vertical).            Note 4: No level of unwanted emissions exceeds the level of the fundamental emission.</p>											



Transmitter Radiated Unwanted Emissions											
Operating Mode	2					Polarization	H				
Operating Function	EUT with AC power via Debug Board Transmitter										
<div style="text-align: right;">Date: 2014-11-07</div> <p>The graph displays the radiated unwanted emissions. The y-axis represents Level in dBuV/m, ranging from -20 to 80. The x-axis represents Frequency in MHz, ranging from 30 to 1000. A red stepped line indicates the NCC AC FCC B limit, which is approximately 40 dBuV/m from 30 MHz to 100 MHz, 45 dBuV/m from 100 MHz to 300 MHz, and 55 dBuV/m from 300 MHz to 1000 MHz. Six peaks are identified and labeled 1 through 6, with their corresponding data listed in the table below.</p>											
	Freq	Level	Over Limit	Limit Line	ReadAntenna Level	Antenna Factor	Cable Loss	Preamp Factor	Remark	A/Pos	T/Pos
	MHz	dBuV/m	dB	dBuV/m	dBuV	dB/m	dB	dB		cm	deg
1	70.740	20.04	-19.96	40.00	39.40	6.72	1.35	27.43	Peak	---	---
2	212.360	22.56	-20.94	43.50	37.76	9.48	2.40	27.08	Peak	---	---
3	295.780	27.56	-18.44	46.00	38.22	13.16	2.88	26.70	Peak	---	---
4	802.120	25.79	-20.21	46.00	28.81	19.68	4.92	27.62	Peak	---	---
5	871.960	26.44	-19.56	46.00	28.24	20.54	5.04	27.38	Peak	---	---
6	943.740	27.40	-18.60	46.00	28.63	20.81	5.31	27.35	Peak	---	---
<p>Note 1: "&gt;20dB" means spurious emission levels that exceed the level of 20 dB below the applicable limit.            Note 2: "N/F" means Nothing Found spurious emissions (No spurious emissions were detected.)            Note 3: Measurement receive antenna polarization: H (Horizontal), V (Vertical).            Note 4: No level of unwanted emissions exceeds the level of the fundamental emission.</p>											





3.6.7 Transmitter Radiated Unwanted Emissions - (Above 1GHz WORST-CASE DATA)

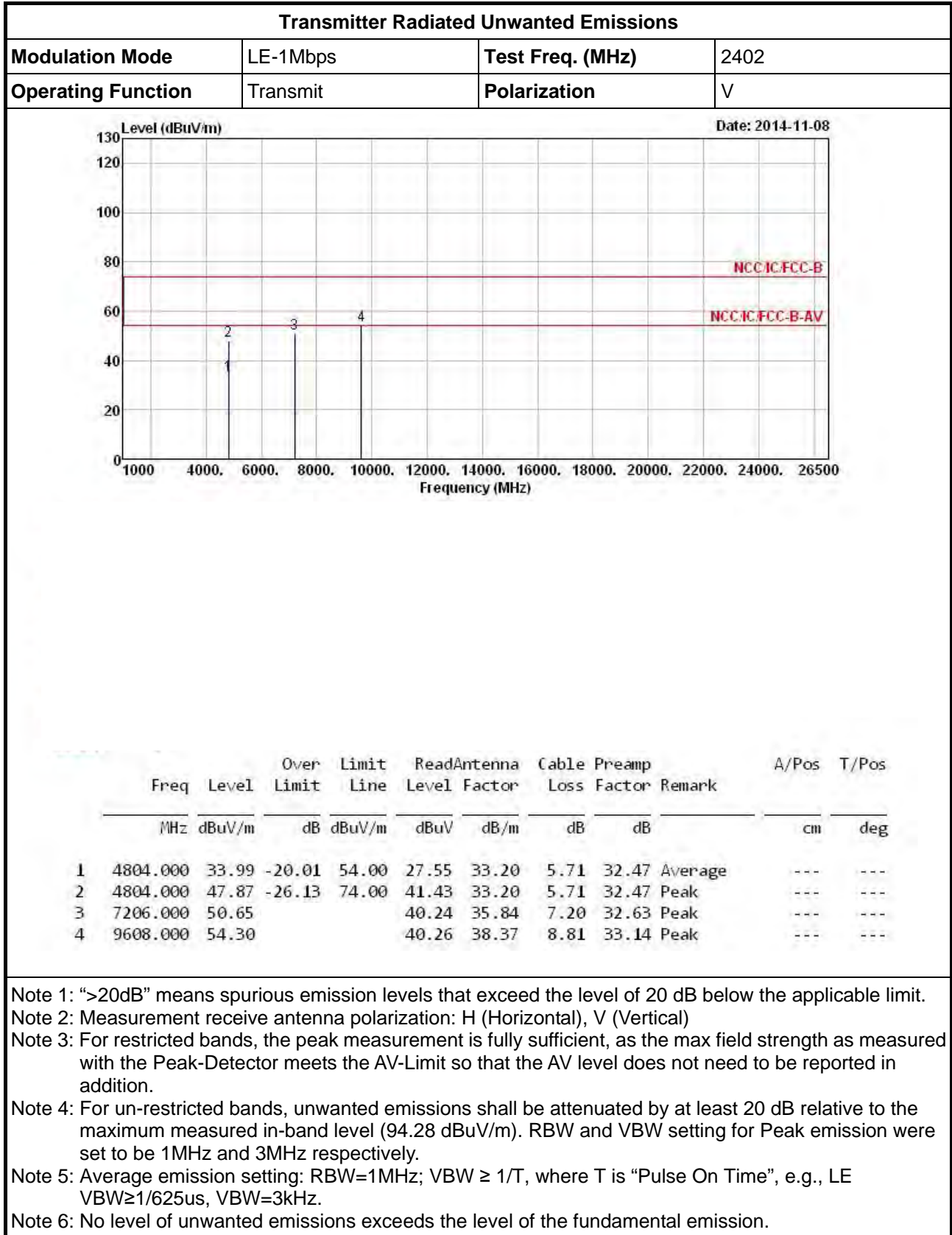



Transmitter Radiated Unwanted Emissions

Modulation Mode	LE-1Mbps	Test Freq. (MHz)	2402
Operating Function	Transmit	Polarization	H

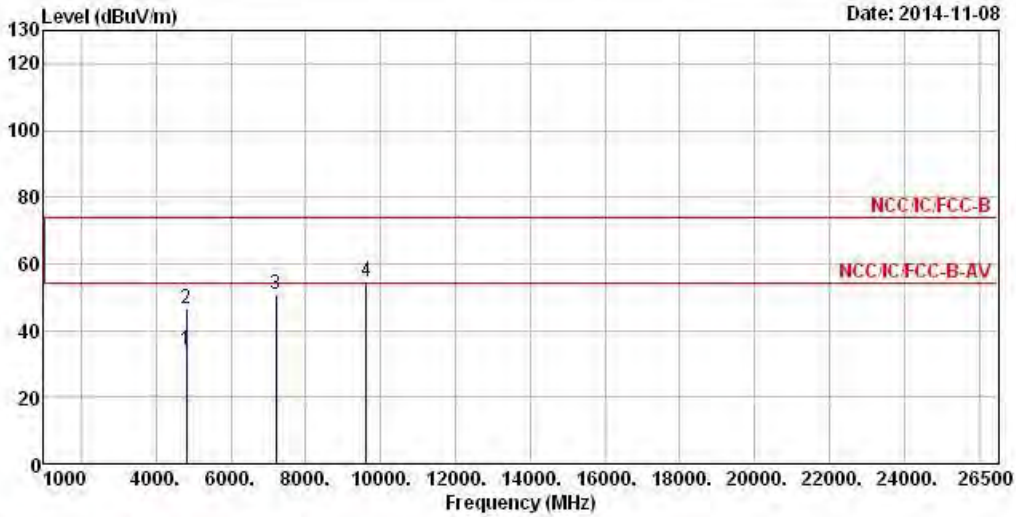

	Freq	Level	Over Limit	Limit Line	ReadAntenna Level	Antenna Factor	Cable Loss	Preamp Factor	Remark	A/Pos	T/Pos
	MHz	dBuV/m	dB	dBuV/m	dBuV	dB/m	dB	dB		cm	deg
1	4804.000	33.92	-20.08	54.00	27.48	33.20	5.71	32.47	Average	---	---
2	4804.000	46.58	-27.42	74.00	40.14	33.20	5.71	32.47	Peak	---	---
3	7206.000	50.81			40.40	35.84	7.20	32.63	Peak	---	---
4	9608.000	54.68			40.64	38.37	8.81	33.14	Peak	---	---

- Note 1: ">20dB" means spurious emission levels that exceed the level of 20 dB below the applicable limit.
- Note 2: Measurement receive antenna polarization: H (Horizontal), V (Vertical)
- Note 3: For restricted bands, the peak measurement is fully sufficient, as the max field strength as measured with the Peak-Detector meets the AV-Limit so that the AV level does not need to be reported in addition.
- Note 4: For un-restricted bands, unwanted emissions shall be attenuated by at least 20 dB relative to the maximum measured in-band level (94.28 dBuV/m). RBW and VBW setting for Peak emission were set to be 1MHz and 3MHz respectively.
- Note 5: Average emission setting: RBW=1MHz; VBW ≥ 1/T, where T is "Pulse On Time", e.g., LE VBW ≥ 1/625us, VBW=3kHz.
- Note 6: No level of unwanted emissions exceeds the level of the fundamental emission.



Transmitter Radiated Unwanted Emissions

Modulation Mode	LE-1Mbps	Test Freq. (MHz)	2440
Operating Function	Transmit	Polarization	V

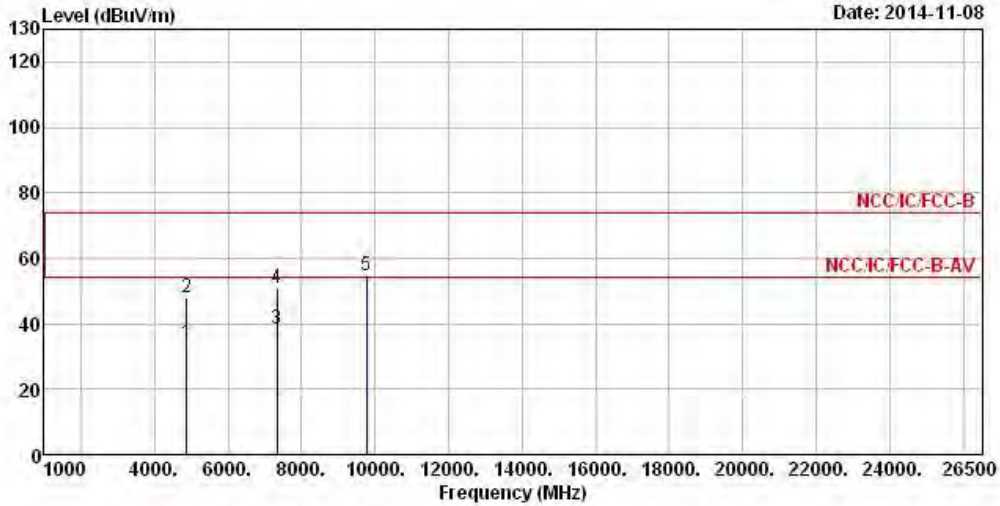

	Freq	Level	Over-Limit	Limit Line	ReadAntenna Level	Antenna Factor	Cable Loss	Preamp Factor	Remark	A/Pos	T/Pos
	MHz	dBuV/m	dB	dBuV/m	dBuV	dB/m	dB	dB		cm	deg
1	4880.000	34.29	-19.71	54.00	27.71	33.31	5.72	32.45	Average	---	---
2	4880.000	47.96	-26.04	74.00	41.38	33.31	5.72	32.45	Peak	---	---
3	7320.000	38.41	-15.59	54.00	27.65	36.15	7.28	32.67	Average	---	---
4	7320.000	50.77	-23.23	74.00	40.01	36.15	7.28	32.67	Peak	---	---
5	9760.000	54.59			40.35	38.61	8.76	33.13	Peak	---	---

- Note 1: ">20dB" means spurious emission levels that exceed the level of 20 dB below the applicable limit.
- Note 2: Measurement receive antenna polarization: H (Horizontal), V (Vertical)
- Note 3: For restricted bands, the peak measurement is fully sufficient, as the max field strength as measured with the Peak-Detector meets the AV-Limit so that the AV level does not need to be reported in addition.
- Note 4: For un-restricted bands, unwanted emissions shall be attenuated by at least 20 dB relative to the maximum measured in-band level (93.71 dBuV/m). RBW and VBW setting for Peak emission were set to be 1MHz and 3MHz respectively.
- Note 5: Average emission setting: RBW=1MHz; VBW ≥ 1/T, where T is "Pulse On Time", e.g., LE VBW≥1/625us, VBW=3kHz.
- Note 6: No level of unwanted emissions exceeds the level of the fundamental emission.



**Transmitter Radiated Unwanted Emissions**

<b>Modulation Mode</b>	LE-1Mbps	<b>Test Freq. (MHz)</b>	2440
<b>Operating Function</b>	Transmit	<b>Polarization</b>	H

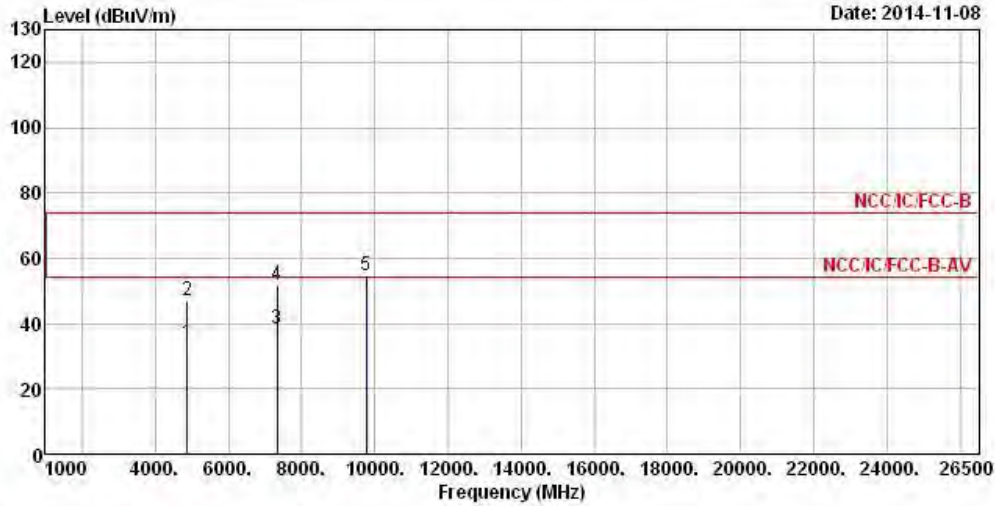

	Freq	Level	Over Limit	Limit Line	ReadAntenna Level	Antenna Factor	Cable Loss	Preamplifier Factor	Remark	A/Pos	T/Pos
	MHz	dBuV/m	dB	dBuV/m	dBuV	dB/m	dB	dB		cm	deg
1	4880.000	34.00	-20.00	54.00	27.42	33.31	5.72	32.45	Average	---	---
2	4880.000	47.04	-26.96	74.00	40.46	33.31	5.72	32.45	Peak	---	---
3	7320.000	38.50	-15.50	54.00	27.74	36.15	7.28	32.67	Average	---	---
4	7320.000	51.59	-22.41	74.00	40.83	36.15	7.28	32.67	Peak	---	---
5	9760.000	54.65			40.41	38.61	8.76	33.13	Peak	---	---

- Note 1: ">20dB" means spurious emission levels that exceed the level of 20 dB below the applicable limit.
- Note 2: Measurement receive antenna polarization: H (Horizontal), V (Vertical)
- Note 3: For restricted bands, the peak measurement is fully sufficient, as the max field strength as measured with the Peak-Detector meets the AV-Limit so that the AV level does not need to be reported in addition.
- Note 4: For un-restricted bands, unwanted emissions shall be attenuated by at least 20 dB relative to the maximum measured in-band level (93.71 dBuV/m). RBW and VBW setting for Peak emission were set to be 1MHz and 3MHz respectively.
- Note 5: Average emission setting: RBW=1MHz; VBW ≥ 1/T, where T is "Pulse On Time", e.g., LE VBW≥1/625us, VBW=3kHz.
- Note 6: No level of unwanted emissions exceeds the level of the fundamental emission.

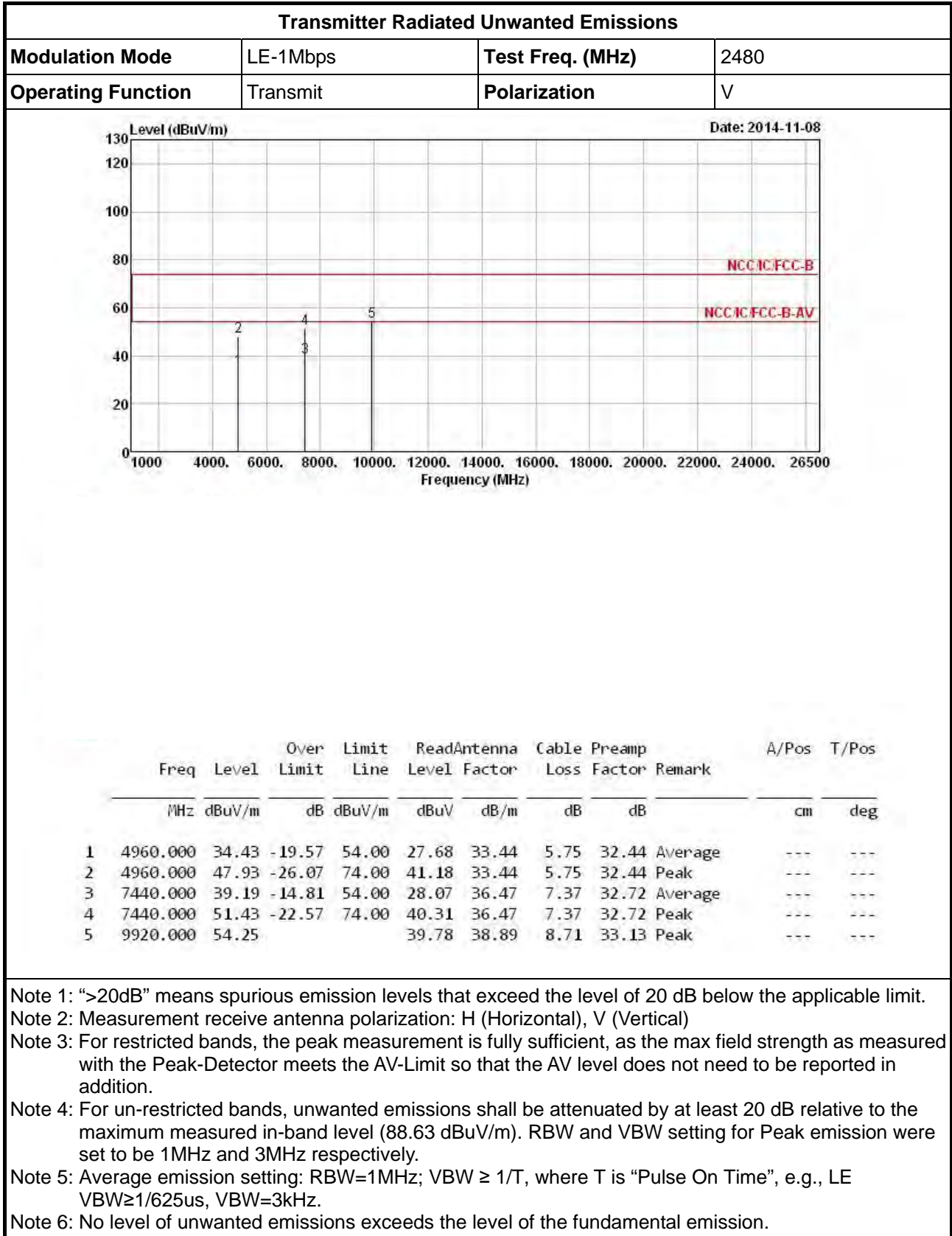



Transmitter Radiated Unwanted Emissions

Modulation Mode	LE-1Mbps	Test Freq. (MHz)	2480
Operating Function	Transmit	Polarization	H

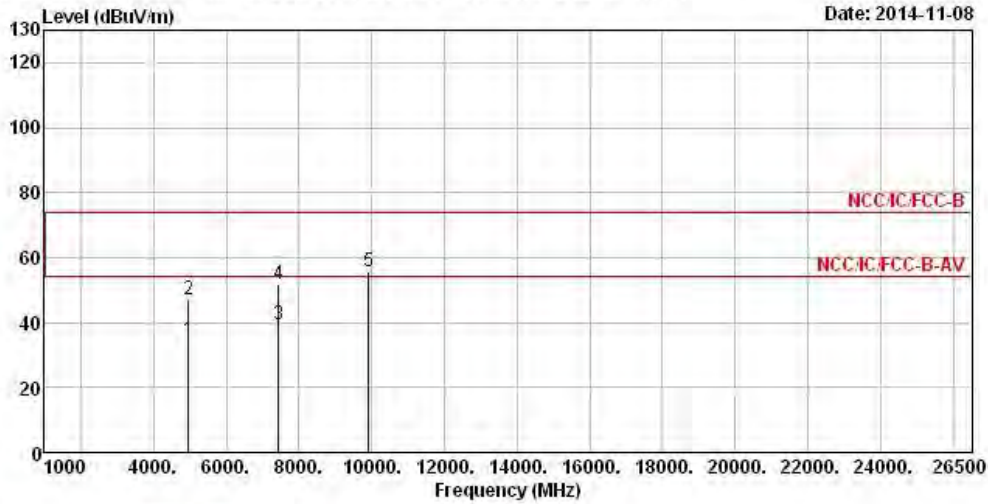

	Freq	Level	Over Limit	Limit Line	ReadAntenna Level	Cable Factor	Preamp Loss	Remark	A/Pos	T/Pos
	MHz	dBuV/m	dB	dBuV/m	dBuV	dB/m	dB		cm	deg
1	4960.000	34.53	-19.47	54.00	27.78	33.44	5.75	Average	---	---
2	4960.000	46.82	-27.18	74.00	40.07	33.44	5.75	Peak	---	---
3	7440.000	39.27	-14.73	54.00	28.15	36.47	7.37	Average	---	---
4	7440.000	51.94	-22.06	74.00	40.82	36.47	7.37	Peak	---	---
5	9920.000	55.41			40.94	38.89	8.71	Peak	---	---

- Note 1: ">20dB" means spurious emission levels that exceed the level of 20 dB below the applicable limit.
- Note 2: Measurement receive antenna polarization: H (Horizontal), V (Vertical)
- Note 3: For restricted bands, the peak measurement is fully sufficient, as the max field strength as measured with the Peak-Detector meets the AV-Limit so that the AV level does not need to be reported in addition.
- Note 4: For un-restricted bands, unwanted emissions shall be attenuated by at least 20 dB relative to the maximum measured in-band level (88.63 dBuV/m). RBW and VBW setting for Peak emission were set to be 1MHz and 3MHz respectively.
- Note 5: Average emission setting: RBW=1MHz; VBW ≥ 1/T, where T is "Pulse On Time", e.g., LE VBW≥1/625us, VBW=3kHz.
- Note 6: No level of unwanted emissions exceeds the level of the fundamental emission.



## 4 Test Equipment and Calibration Data

Instrument	Manufacturer	Model No.	Serial No.	Characteristics	Calibration Date	Remark
EMC Receiver	R&S	ESCS 30	100174	9kHz ~ 2.75GHz	Apr. 14, 2014	AC Conduction
LISN	SCHWARZBECK MESS-ELEKTRONIK	NSLK 8127	8127-477	9kHz ~ 30MHz	Jan. 22, 2014	AC Conduction
RF Cable-CON	HUBER+SUHNER	RG213/U	07611832020001	9kHz ~ 30MHz	Oct. 31, 2014	AC Conduction
EMI Filter	LINDGREN	LRE-2030	2651	< 450 Hz	N/A	AC Conduction
BT Station	R&S	CBT	100959	N/A	Mar. 10, 2014	AC Conduction

Note: Calibration Interval of instruments listed above is one year.

Instrument	Manufacturer	Model No.	Serial No.	Characteristics	Calibration Date	Remark
Spectrum Analyzer	R&S	FSV 40	101013	9KHz~40GHz	Jan. 25, 2014	RF Conducted
AC Power Source	G.W	APS-9102	EL920581	AC 0V ~ 300V	Jul. 15, 2014	RF Conducted
Signal Generator	R&S	SMR40	100116	10MHz ~ 40GHz	Jul. 31, 2014	RF Conducted
Power Sensor	Anritsu	MA2411B	0917017	300MHz ~ 40GHz	Jan. 28, 2014	RF Conducted
Power Meter	Anritsu	ML2495A	0949003	300MHz ~ 40GHz	Jan. 28, 2014	RF Conducted
RF Cable-2m	HUBER+SUHNER	SUCOFLEX_104	SN 345675/4	30MHz ~ 26.5GHz	Dec. 02, 2013	RF Conducted

Note: Calibration Interval of instruments listed above is one year.

Instrument	Manufacturer	Model No.	Serial No.	Characteristics	Calibration Date	Remark
3m Semi Anechoic Chamber	SIDT FRANKONIA	SAC-3M	03CH03-HY	30MHz ~ 1GHz 3m	Nov. 30, 2013 Nov. 29, 2014 (Update)	Radiation
Amplifier	HP	8447D	2944A08033	10kHz ~ 1.3GHz	May 05, 2014	Radiation
Amplifier	Agilent	8449B	3008A02120	1GHz ~ 26.5GHz	Sep. 01, 2014	Radiation
Spectrum	R&S	FSP40	100004	9kHz ~ 40GHz	Mar. 27, 2014	Radiation
Bilog Antenna	SCHAFFNER	CBL 6112D	22237	30MHz ~ 1GHz	Sep. 20, 2014	Radiation
Horn Antenna	ETS · LINDGREN	3115	6741	1GHz ~ 18GHz	Jun. 11, 2014	Radiation
Horn Antenna	SCHWARZBECK	BBHA9170	BBHA9170154	15GHz ~ 40GHz	Jan. 10, 2014	Radiation
RF Cable-R03m	Jye Bao	RG142	CB021	9kHz ~ 1GHz	Nov. 16, 2013	Radiation
RF Cable-high	SUHNER	SUCOFLEX 106	03CH03-HY	1GHz ~ 40GHz	Dec. 11, 2013	Radiation
Turn Table	EM Electronics	EM Electronics	060615	0 ~ 360 degree	N/A	Radiation
Antenna Mast	MF	MF-7802	MF780208179	1 ~ 4 m	N/A	Radiation

Note: Calibration Interval of instruments listed above is one year.

Instrument	Manufacturer	Model No.	Serial No.	Characteristics	Calibration Date	Remark
Loop Antenna	TESEQ	HLA 6120	31244	9kHz ~ 30MHz	Dec. 02, 2012	Radiation

Note: Calibration Interval of instruments listed above is two year.