

FCC Test Report

Equipment : 7777-01XX
Brand Name : Orderman
Model No. : 7777-01XX
Marketing Name : NCR Orderman7 +
FCC ID : JEH-7777-01XX
Standard : 47 CFR FCC Part 15.247
Operating Band : 2400 MHz – 2483.5 MHz
FCC Classification : DSS
Applicant : NCR Corporation
Address : 2651 Satellite Blvd. Duluth, GA 30096 USA
Manufacturer : Universal Global Scientific Industrial Co., Ltd.
Address : 141, Lane 351, Sec.1, Taiping Road,
Tsaotuen, Nantou 54261, Taiwan

The product sample received on Nov. 5, 2014 and completely tested on Dec. 1, 2014. We, SPORTON, would like to declare that the tested sample has been evaluated in accordance with the procedures given in ANSI C63.10-2009 and shown compliance with the applicable technical standards.

The test results in this report apply exclusively to the tested model / sample. Without written approval of SPORTON INTERNATIONAL INC., the test report shall not be reproduced except in full.

Reviewed by:

Vic Hsiao / Supervisor





Table of Contents

- 1 GENERAL DESCRIPTION5**
- 1.1 Information.....5
- 1.2 Accessories and Support Equipment7
- 1.3 Testing Applied Standards7
- 1.4 Testing Location Information7
- 1.5 Measurement Uncertainty8
- 2 TEST CONFIGURATION OF EUT9**
- 2.1 The Worst Case Modulation Configuration9
- 2.2 The Worst Case Power Setting Parameter9
- 2.3 The Worst Case Measurement Configuration10
- 2.4 Test Setup Diagram 11
- 3 TRANSMITTER TEST RESULT14**
- 3.1 AC Power-line Conducted Emissions 14
- 3.2 20dB Bandwidth and Carrier Frequency Separation 17
- 3.3 Number of Hopping Frequencies 19
- 3.4 Time of Occupancy (Dwell Time)21
- 3.5 RF Output Power.....23
- 3.6 Transmitter Radiated Bandedge Emissions26
- 3.7 Transmitter Radiated Unwanted Emissions29
- 4 TEST EQUIPMENT AND CALIBRATION DATA42**

APPENDIX A. TEST PHOTOS

APPENDIX B. PHOTOGRAPHS OF EUT



Summary of Test Result

| Conformance Test Specifications | | | | | |
|---------------------------------|------------------|---|---|---|----------|
| Report Clause | Ref. Std. Clause | Description | Measured | Limit | Result |
| 1.1.2 | 15.203 | Antenna Requirement | Antenna connector mechanism complied | FCC 15.203 | Complied |
| 3.1 | 15.207 | AC Power-line Conducted Emissions | [dBuV]: 0.4040020MHz 42.01 (Margin 15.76dB) - QP 37.02 (Margin 10.75dB) - AV | FCC 15.207 | Complied |
| 3.2 | 15.247(a) | 20dB Bandwidth | EDR: 1.3242MHz | N/A | Complied |
| 3.2 | 15.247(a) | Carrier Frequency Separation (ChS) | EDR: 1.0029MHz | ChS \geq BW _{20dB} x2/3. | Complied |
| 3.3 | 15.247(a) | Number of Hopping Frequencies (N) | Max: 79 Min: 15 | N \geq 15 | Complied |
| 3.4 | 15.247(a) | Time of Occupancy (Dwell Time) | EDR: 0.314sec | 0.4 s within 0.4 x N | Complied |
| 3.5 | 15.247(b) | RF Output Power (Maximum Peak Conducted Output Power) | Power [dBm] BR: 0.55 EDR: 3.45 | Power [dBm] BR:21 EDR:21 | Complied |
| 3.6 | 15.247(c) | Transmitter Radiated Bandedge Emissions | Restricted Bands [dBuV/m at 3m]: 2483.52MHz 56.55 (Margin 17.45dB) - PK 44.15 (Margin 9.85dB) - AV | Non-Restricted Bands: > 20 dBc Restricted Bands: FCC 15.209 | Complied |
| 3.7 | 15.247(c) | Transmitter Radiated Unwanted Emissions | Restricted Bands [dBuV/m at 3m]:31.940MHz 36.49 (Margin 3.51dB) - QP | Non-Restricted Bands: > 20 dBc Restricted Bands: FCC 15.209 | Complied |

1 General Description

1.1 Information

1.1.1 RF General Information

| RF General Information | | | | | |
|---|----------------|---------------------|----------------|-----------------------|-------------|
| Frequency Range (MHz) | Bluetooth Mode | Ch. Frequency (MHz) | Channel Number | RF Output Power (dBm) | Co-location |
| 2400-2483.5 | BR / EDR | 2402-2480 | 0-78 [79] | 3.45 | Yes |
| <p>Note 1: Bluetooth BR uses a GFSK (1Mbps).</p> <p>Note 2: Bluetooth EDR uses a combination of $\pi/4$-DQPSK (2Mbps) and 8DPSK (3Mbps).</p> <p>Note 3: RF output power specifies that Maximum Peak Conducted Output Power.</p> <p>Note 4: Co-location, Co-location is generally defined as simultaneously transmitting (co-transmitting) antennas within 20 cm of each other. (i.e., EUT has simultaneously co-transmitting that operating NFC+OSR+RFID+BT)</p> | | | | | |

1.1.2 Antenna Information

| Antenna Category | |
|-------------------------------------|---|
| <input checked="" type="checkbox"/> | Integral antenna (antenna permanently attached) |
| <input type="checkbox"/> | Temporary RF connector provided |
| <input checked="" type="checkbox"/> | No temporary RF connector provided Transmit chains bypass antenna and soldered temporary RF connector provided for connected measurement. In case of conducted measurements the transmitter shall be connected to the measuring equipment via a suitable attenuator and correct for all losses in the RF path. |

| Antenna General Information | | |
|-----------------------------|-----------|------------|
| Ant. Cat. | Ant. Type | Gain (dBi) |
| Integral | PIFA | 1.10 |



1.1.3 Type of EUT

| Identify EUT | |
|-------------------------------------|---|
| EUT Serial Number | N/A |
| Presentation of Equipment | <input checked="" type="checkbox"/> Production ; <input type="checkbox"/> Pre-Production ; <input type="checkbox"/> Prototype |
| Type of EUT | |
| <input checked="" type="checkbox"/> | Stand-alone |
| <input type="checkbox"/> | Combined (EUT where the radio part is fully integrated within another device) Combined Equipment - Brand Name / Model No.: |
| <input type="checkbox"/> | Plug-in radio (EUT intended for a variety of host systems) Host System - Brand Name / Model No.: |
| <input type="checkbox"/> | Other: |

1.1.4 Test Signal Duty Cycle

| Operated Mode for Worst Duty Cycle | |
|--|---------------------------------------|
| <input checked="" type="checkbox"/> Operated test mode for worst duty cycle | |
| Test Signal Duty Cycle (x) | Power Duty Factor [dB] – (10 log 1/x) |
| <input checked="" type="checkbox"/> 78.40% - test mode single channel-DH5 | 1.06 |
| Bluetooth ACL packets can be 1, 3, or 5 time slots. The DH1 packet can cover a single time slot. The DH3 packet can cover up to 3 time slots. The DH5 packet can cover up to 5 time slots. Operate DH5 at maximum dwell time and maximum duty cycle. | |

1.1.5 EUT Operational Condition

| | | | |
|-------------------|---|---|---|
| Supply Voltage | <input type="checkbox"/> AC mains | <input checked="" type="checkbox"/> DC | - |
| Type of DC Source | <input type="checkbox"/> Internal DC supply | <input checked="" type="checkbox"/> External DC Service Station | <input checked="" type="checkbox"/> From Li-ion Battery |

1.2 Accessories and Support Equipment

| Accessories Information | | | | |
|-------------------------|--------------|--|------------|----------------|
| Li-ion Battery | Brand Name | NCR | Model Name | 7777-0105-8801 |
| | Power Rating | 3.7V  3150mAh | | |
| LCD Panel | Brand Name | LG Display | Model Name | LH500WX1-SD03 |
| Camera | Brand Name | Ability | Model Name | BD56A555 |
| WiFi Module | Brand Name | USI | Model Name | WM-BAN-BM-07_S |
| OSR Module | Brand Name | TI | Model Name | CC1125 |
| RFID Module | Brand Name | Melexis | Model Name | MLX90109 |
| NFC Module | Brand Name | NXP | Model Name | PN547 |

Reminder: Regarding to more detail and other information, please refer to user manual.

| Support Equipment - AC Conduction and Radiated Emission | | | | |
|---|--|------------|----------------|--------|
| No. | Equipment | Brand Name | Model Name | FCC ID |
| 1 | Service Station (Provide by customer) | Orderman | 7779-0201-8801 | - |
| 2 | Debug Board (Provide by customer) | - | - | - |
| 3 | Adapter | Meanwell | GSM36U12-P5L | - |
| 4 | BT Station | R&S | CBT | - |

1.3 Testing Applied Standards

According to the specifications of the manufacturer, the EUT must comply with the requirements of the following standards:

- ◆ 47 CFR FCC Part 15
- ◆ ANSI C63.10-2009
- ◆ FCC Public Notice DA 00-705

1.4 Testing Location Information

| Testing Location | | | | |
|--|-----------------------|----------------------|--|-------------------------|
| <input checked="" type="checkbox"/> | HWA YA | ADD | : No. 52, Hwa Ya 1 st Rd., Hwa Ya Technology Park, Kwei-Shan Hsiang, Tao Yuan Hsien, Taiwan, R.O.C. | |
| | | TEL | : 886-3-327-3456 | FAX : 886-3-327-0973 |
| Test Site Registration Number: FCC 636805 | | | | |
| | Test Condition | Test Site No. | Test Engineer | Test Environment |
| | AC Conduction | CO04-HY | Zeus | 22°C / 52% |
| | RF Conducted | TH01-HY | Ian | 22.9°C / 68% |
| | Radiated Emission | 03CH03-HY | Allen | 24°C / 57% |

1.5 Measurement Uncertainty

ISO/IEC 17025 requires that an estimate of the measurement uncertainties associated with the emissions test results be included in the report. The measurement uncertainties given below are based on a 95% confidence level (based on a coverage factor (k=2))

| Measurement Uncertainty | | |
|-----------------------------------|---------------|-------------|
| Test Item | | Uncertainty |
| AC power-line conducted emissions | | ±2.3 dB |
| Emission bandwidth, 6dB bandwidth | | ±1.4 % |
| RF output power, conducted | | ±0.6 dB |
| Power density, conducted | | ±0.8 dB |
| Unwanted emissions, conducted | 9 – 150 kHz | ±0.4 dB |
| | 0.15 – 30 MHz | ±0.4 dB |
| | 30 – 1000 MHz | ±0.5 dB |
| | 1 – 18 GHz | ±0.7 dB |
| | 18 – 40 GHz | ±0.8 dB |
| | 40 – 200 GHz | N/A |
| All emissions, radiated | 9 – 150 kHz | ±2.5 dB |
| | 0.15 – 30 MHz | ±2.3 dB |
| | 30 – 1000 MHz | ±2.6 dB |
| | 1 – 18 GHz | ±3.6 dB |
| | 18 – 40 GHz | ±3.8 dB |
| | 40 – 200 GHz | N/A |
| Temperature | | ±0.8 °C |
| Humidity | | ±3 % |
| DC and low frequency voltages | | ±3 % |
| Time | | ±1.4 % |
| Duty Cycle | | ±1.4 % |

2 Test Configuration of EUT

2.1 The Worst Case Modulation Configuration

| Worst Modulation Used for Conformance Testing | | | | | |
|--|------------------------------------|-----------|-----------------|-----------------------|------------|
| Bluetooth Mode | Transmit Chains (N _{TX}) | Data Rate | Modulation Mode | RF Output Power (dBm) | Worst Mode |
| BR | 1 | 1 Mbps | BR-1Mbps | 0.55 | EDR-3Mbps |
| EDR | 1 | 3 Mbps | EDR-3Mbps | 3.45 | |
| Note 1: Bluetooth BR uses a combination of GFSK (1Mbps). Note 2: Bluetooth EDR uses a combination of $\pi/4$ -DQPSK (2Mbps) and 8DPSK (3Mbps). Note 3: Modulation modes consist below configuration: FHSS BR-1Mbps: GFSK (1Mbps), EDR-2Mbps: $\pi/4$ -DQPSK (2Mbps), EDR-3Mbps: 8DPSK(3Mbps) Note 4: RF output power specifies that Maximum Peak Conducted Output Power. | | | | | |



2.2 The Worst Case Power Setting Parameter

| The Worst Case Power Setting Parameter | | | |
|--|----------|----------|----------|
| Test Software Version | CBT 32 | | |
| Modulation Mode | 2402 MHz | 2441 MHz | 2480 MHz |
| BR-1Mbps | Default | Default | Default |
| EDR-2Mbps | Default | Default | Default |
| EDR-3Mbps | Default | Default | Default |

2.3 The Worst Case Measurement Configuration

| The Worst Case Mode for Following Conformance Tests | |
|---|---|
| Tests Item | AC power-line conducted emissions |
| Condition | AC power-line conducted measurement for line and neutral Test Voltage: 120Vac / 60Hz |
| Operating Mode | Operating Mode Description |
| | 1. EUT with Service Station Charge Mode |

| The Worst Case Mode for Following Conformance Tests | |
|---|--|
| Tests Item | RF Output Power, 20dB Bandwidth, Carrier Frequency Separation (ChS) Number of Hopping Frequencies (N), Time of Occupancy (Dwell Time) |
| Test Condition | Conducted measurement at transmit chains |
| Modulation Mode | BR-1Mbps, EDR-3Mbps |

| The Worst Case Mode for Following Conformance Tests | | | |
|---|---|--|---|
| Tests Item | | Transmitter Radiated Bandedge Emissions Transmitter Radiated Unwanted Emissions | |
| Test Condition | | Radiated measurement | |
| User Position | | <input type="checkbox"/> EUT will be placed in fixed position. | |
| X Plane | Y Plane | Z Plane | <input type="checkbox"/> EUT will be placed in mobile position and operating multiple positions. |
|  |  |  | <input checked="" type="checkbox"/> EUT will be a hand-held or body-worn battery-powered devices and operating multiple positions. EUT shall be performed three orthogonal planes. The worst planes is Y. |
| Operating Mode (Blow 1GHz) | | Operating Mode Description | |
| | | 1. EUT with Service Station Charge Mode | |
| | | 2. EUT with AC power via Debug Board Transmitter | |
| Operating Mode (Above 1GHz) | | 2. EUT with AC power via Debug Board Transmitter | |
| Modulation Mode | | Transmitter Radiated Bandedge Emissions: BR-1Mbps · EDR-2Mbps · EDR-3Mbps Transmitter Radiated Unwanted Emissions: For test mode BR-1Mbps, EDR-2Mbps and EDR-3Mbps of the transmitter were assess for pretest. The worst case was EDR-3Mbps and recorded in this test report. | |

Note: The RF Function will be off when the EUT charge with Service Station.

2.4 Test Setup Diagram

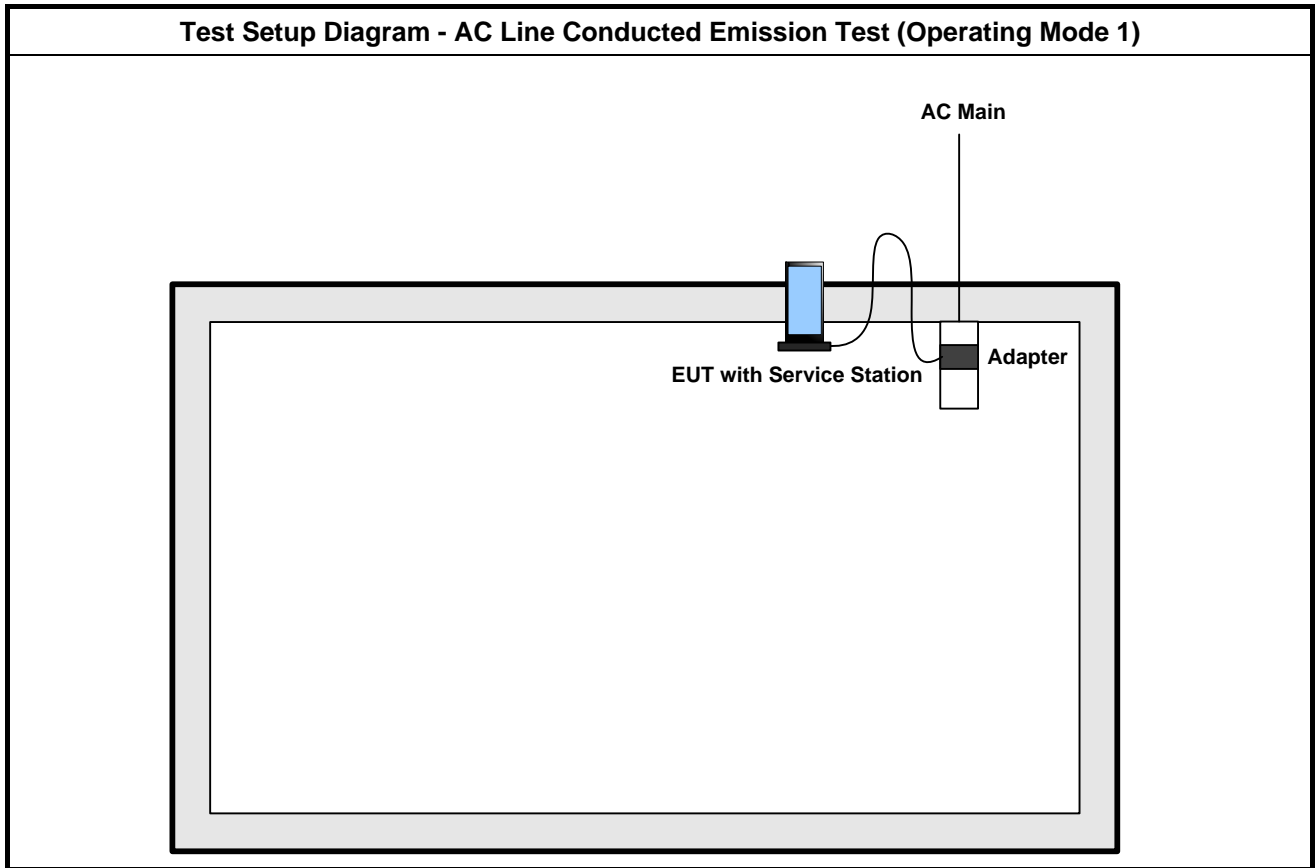

Test Setup Diagram - Radiated Test Below 1GHz (Operating Mode 1)

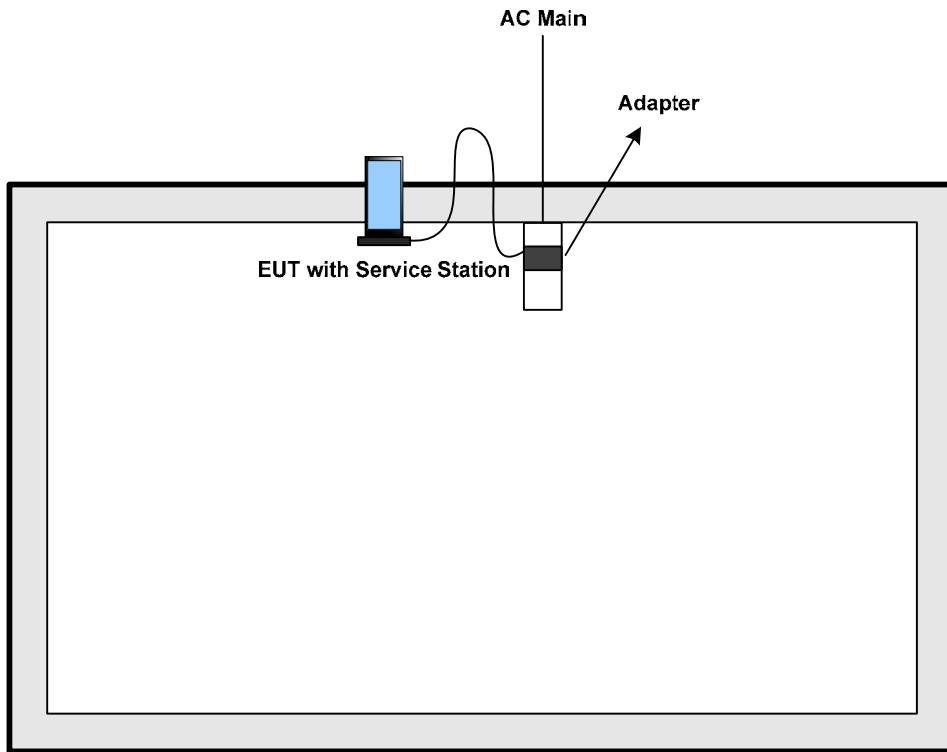

Test Setup Diagram - Radiated Test Below 1GHz (Operating Mode 2)

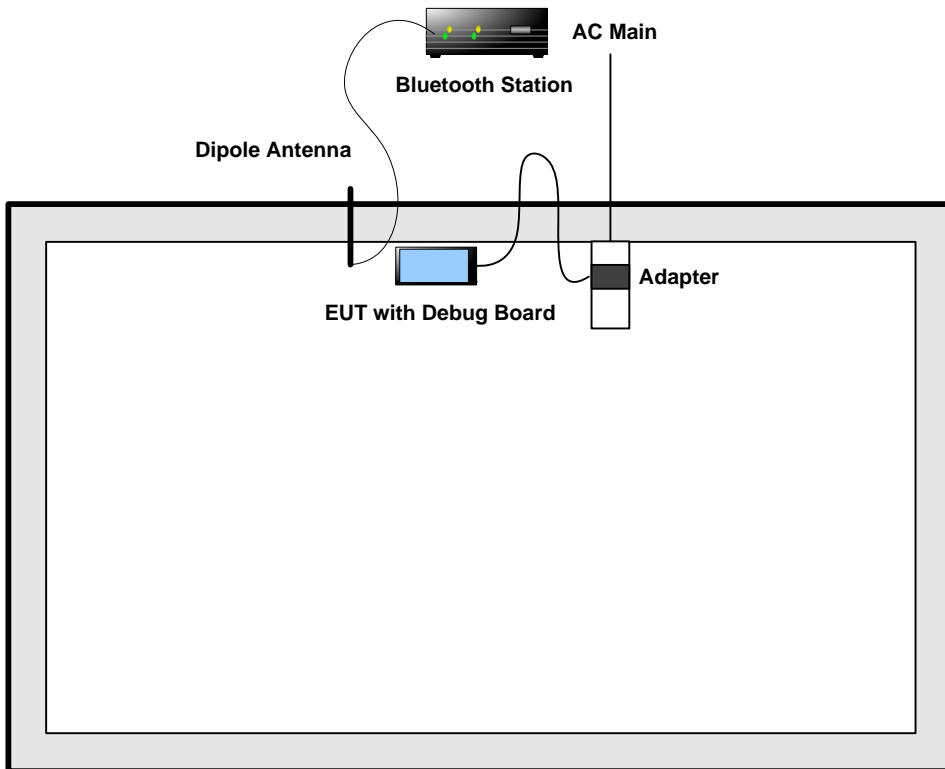

Test Setup Diagram - Radiated Test Above 1GHz (Operating Mode 2)

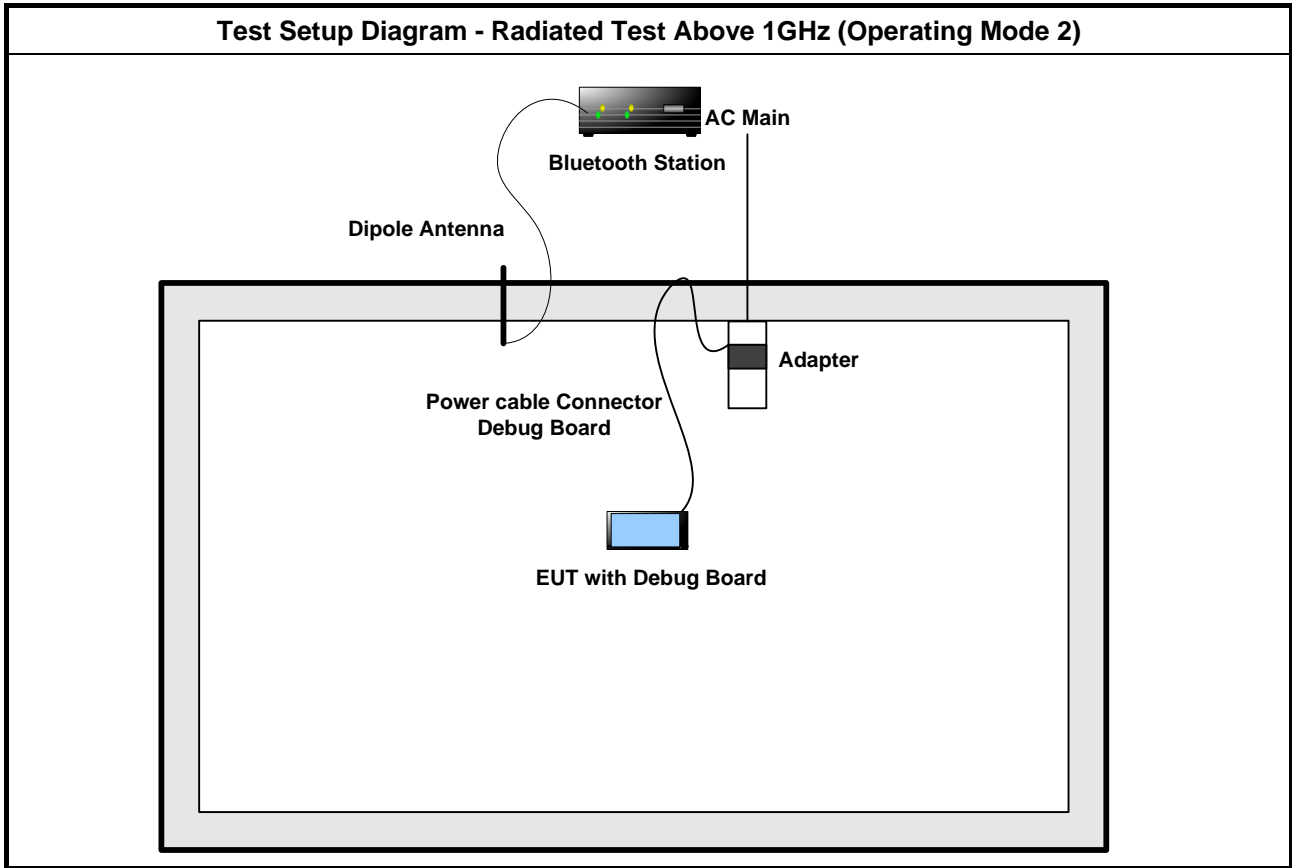

3 Transmitter Test Result

3.1 AC Power-line Conducted Emissions

3.1.1 AC Power-line Conducted Emissions Limit

| AC Power-line Conducted Emissions Limit | | |
|---|------------|-----------|
| Frequency Emission (MHz) | Quasi-Peak | Average |
| 0.15-0.5 | 66 - 56 * | 56 - 46 * |
| 0.5-5 | 56 | 46 |
| 5-30 | 60 | 50 |

Note 1: * Decreases with the logarithm of the frequency.

3.1.2 Measuring Instruments

Refer a test equipment and calibration data table in this test report.

3.1.3 Test Procedures

| Test Method |
|--|
| <input checked="" type="checkbox"/> Refer as ANSI C63.10-2009, clause 6.2 for AC power-line conducted emissions. |

3.1.4 Test Setup

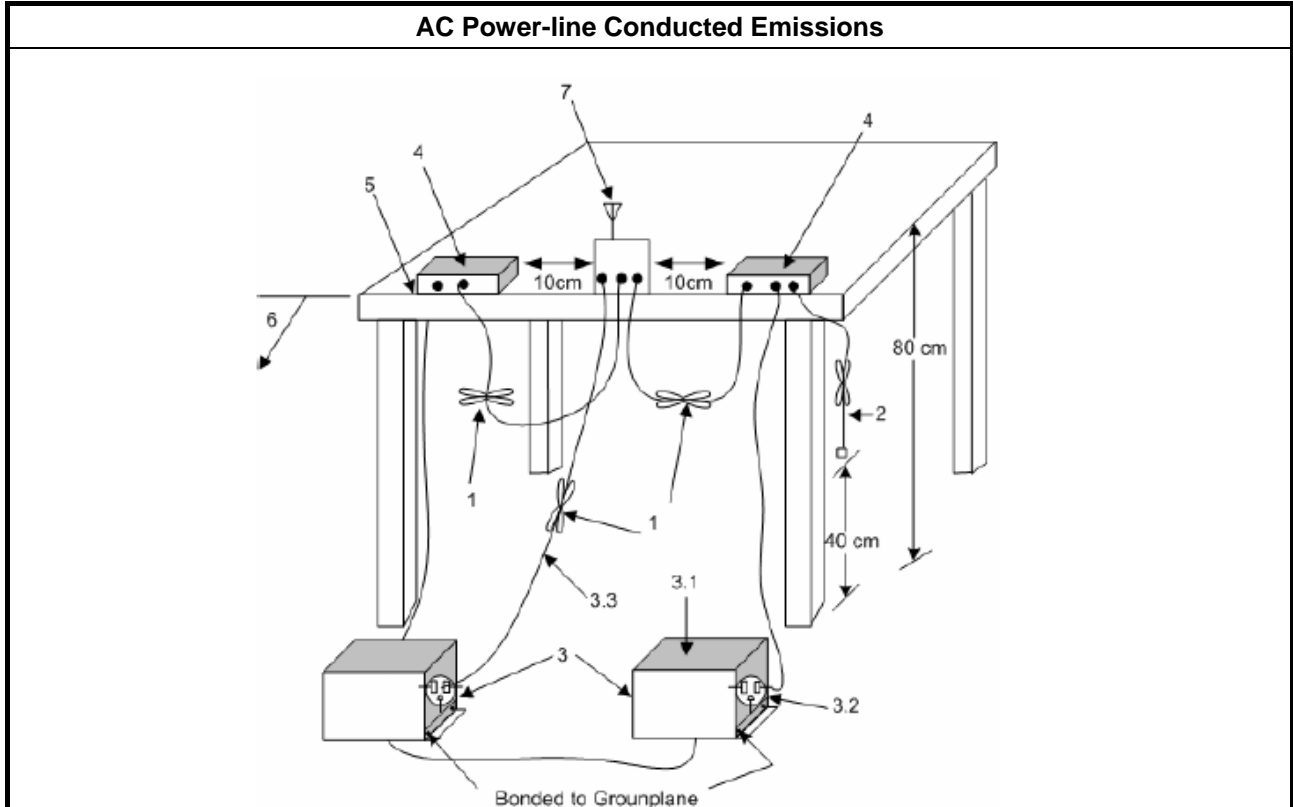

3.1.5 Test Result of AC Power-line Conducted Emissions

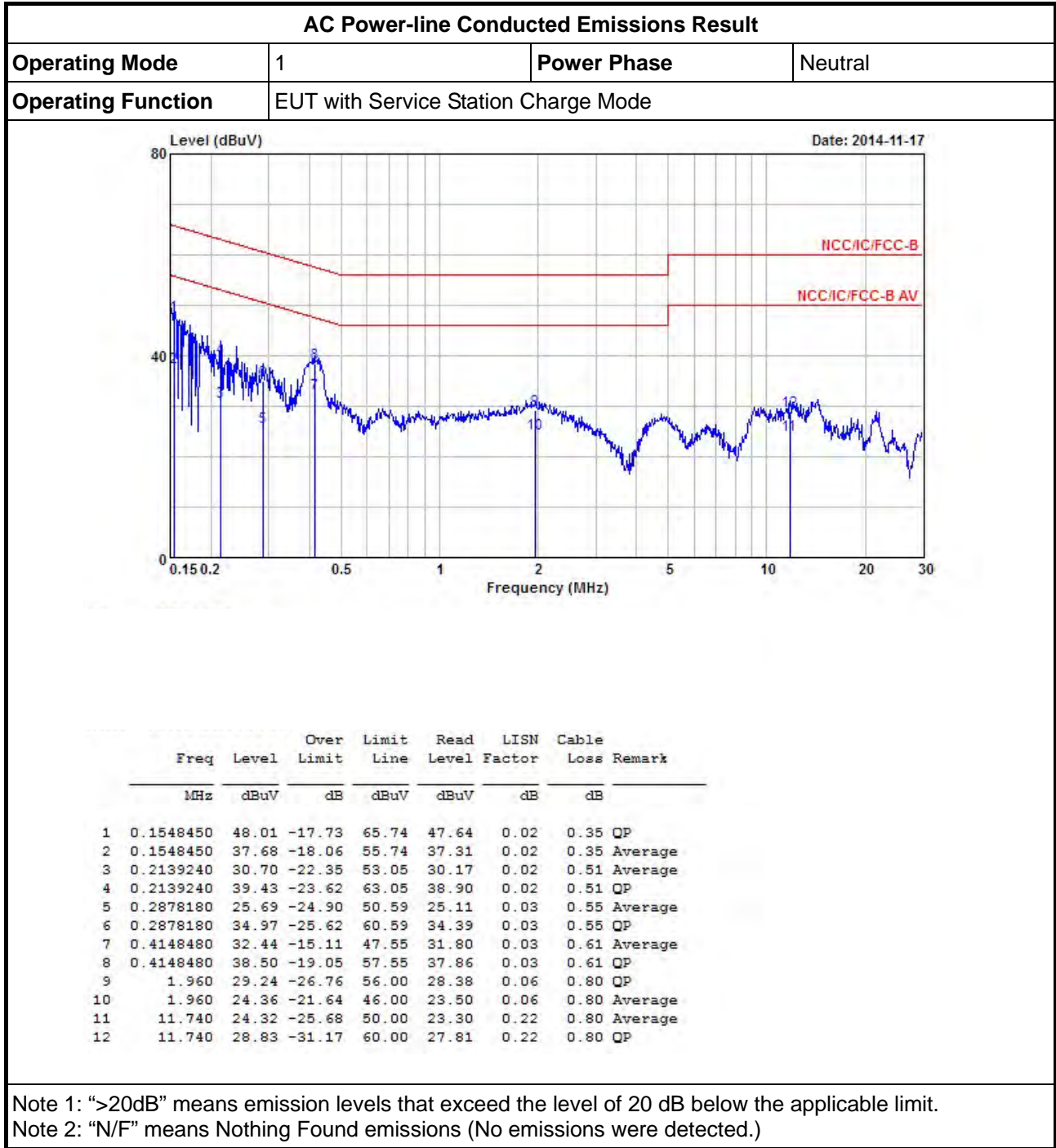

AC Power-line Conducted Emissions Result

| | | | |
|--------------------|--------------------------------------|-------------|------|
| Operating Mode | 1 | Power Phase | Line |
| Operating Function | EUT with Service Station Charge Mode | | |

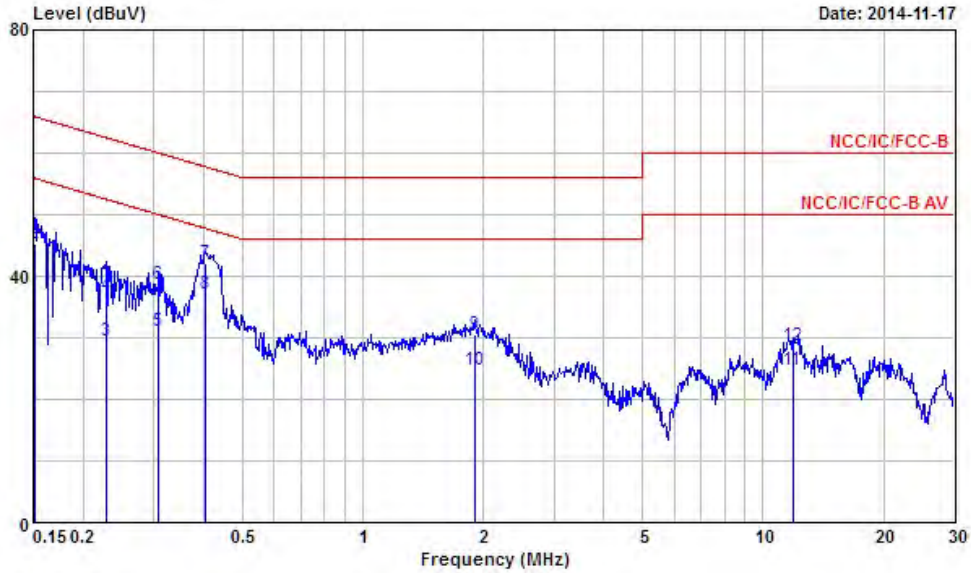

| | Freq | Level | Over | Limit | Read | LISN | Cable | Remark |
|----|-----------|-------|--------|-------|-------|------|-------|---------|
| | MHz | dBuV | dB | dBuV | dBuV | dB | dB | |
| 1 | 0.1515980 | 34.40 | -21.51 | 55.91 | 34.03 | 0.03 | 0.34 | Average |
| 2 | 0.1515980 | 45.23 | -20.68 | 65.91 | 44.86 | 0.03 | 0.34 | QP |
| 3 | 0.2279670 | 29.58 | -22.94 | 52.52 | 29.03 | 0.03 | 0.52 | Average |
| 4 | 0.2279670 | 36.95 | -25.57 | 62.52 | 36.40 | 0.03 | 0.52 | QP |
| 5 | 0.3083410 | 30.93 | -19.09 | 50.02 | 30.34 | 0.03 | 0.56 | Average |
| 6 | 0.3083410 | 38.55 | -21.47 | 60.02 | 37.96 | 0.03 | 0.56 | QP |
| 7 | 0.4040020 | 42.01 | -15.76 | 57.77 | 41.38 | 0.03 | 0.60 | QP |
| 8 | 0.4040020 | 37.02 | -10.75 | 47.77 | 36.39 | 0.03 | 0.60 | Average |
| 9 | 1.900 | 30.65 | -25.35 | 56.00 | 29.78 | 0.07 | 0.80 | QP |
| 10 | 1.900 | 24.61 | -21.39 | 46.00 | 23.74 | 0.07 | 0.80 | Average |
| 11 | 11.870 | 24.65 | -25.35 | 50.00 | 23.63 | 0.22 | 0.80 | Average |
| 12 | 11.870 | 28.81 | -31.19 | 60.00 | 27.79 | 0.22 | 0.80 | QP |

Note 1: ">20dB" means emission levels that exceed the level of 20 dB below the applicable limit.
 Note 2: "N/F" means Nothing Found emissions (No emissions were detected.)

3.2 20dB Bandwidth and Carrier Frequency Separation

3.2.1 20dB Bandwidth and Carrier Frequency Separation Limit

| 20dB Bandwidth and Carrier Frequency Separation Limit for Frequency Hopping Systems | |
|---|---|
| <input checked="" type="checkbox"/> | 2400-2483.5 MHz Band: |
| <input type="checkbox"/> | $N \geq 75$ and $ChS \geq MAX$ (20 dB bandwidth, 25 kHz). |
| <input checked="" type="checkbox"/> | $N \geq 15$ and $ChS \geq MAX$ (20 dB bandwidth x 2/3, 25 kHz). |
| N: Number of Hopping Frequencies; ChS: Hopping Channel Separation | |

3.2.2 Measuring Instruments

Refer a test equipment and calibration data table in this test report.

3.2.3 Test Procedures

| Test Method | |
|-------------------------------------|---|
| <input checked="" type="checkbox"/> | Refer as ANSI C63.10, clause 6.9.1 for 20 dB bandwidth measurement. |
| <input checked="" type="checkbox"/> | Refer as ANSI C63.10, clause 7.7.2 for carrier frequency separation measurement. |
| <input checked="" type="checkbox"/> | For conducted measurement. |
| <input checked="" type="checkbox"/> | The EUT supports single transmit chain and measurements performed on this transmit chain. |
| <input type="checkbox"/> | The EUT supports diversity transmitting and the results on transmit chain port 1 is the worst case. |

3.2.4 Test Setup

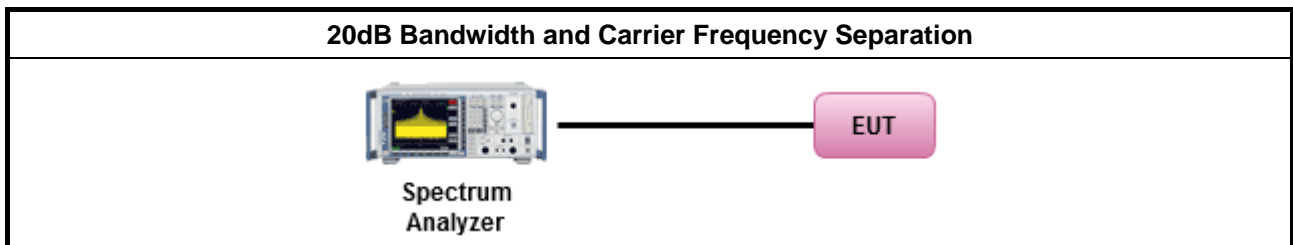



3.2.5 Test Result of 20dB Bandwidth and Carrier Frequency Separation

| 20dB Bandwidth and Carrier Frequency Separation Result | | | | | |
|--|-------------|----------------------|---------------------|--------------------------|---------------------------------|
| Modulation Mode | Freq. (MHz) | 20dB Bandwidth (MHz) | 99% Bandwidth (MHz) | Channel Separation (MHz) | Channel Separation Limits (MHz) |
| BR-1Mbps | 2402 | 1.0159 | 0.9030 | 1.0029 | 0.6773 |
| BR-1Mbps | 2441 | 1.0203 | 0.9117 | 1.0029 | 0.6802 |
| BR-1Mbps | 2480 | 1.0203 | 0.9073 | 1.0029 | 0.6802 |
| EDR-3Mbps | 2402 | 1.3155 | 1.1939 | 1.0029 | 0.8770 |
| EDR-3Mbps | 2441 | 1.3198 | 1.2026 | 1.0029 | 0.8799 |
| EDR-3Mbps | 2480 | 1.3242 | 1.2026 | 1.0029 | 0.8828 |
| Result | | Complied | | | |

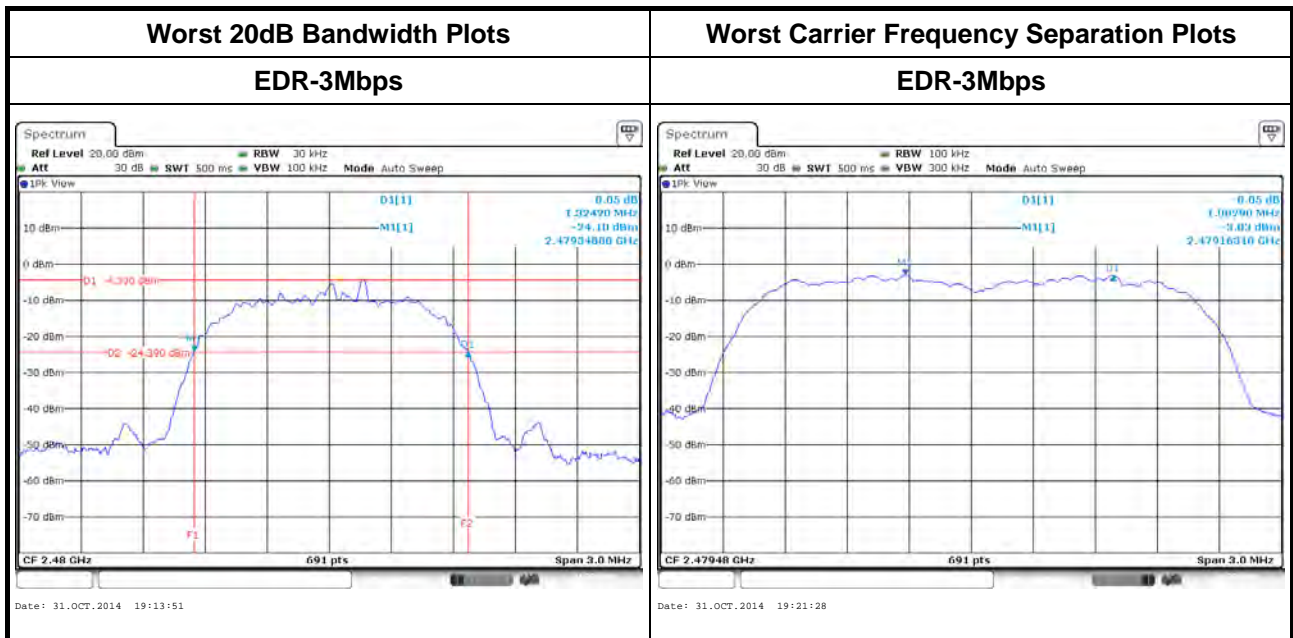

3.3 Number of Hopping Frequencies

3.3.1 Number of Hopping Frequencies Limit

| Number of Hopping Frequencies Limit for Frequency Hopping Systems | |
|---|---|
| <input checked="" type="checkbox"/> | 2400-2483.5 MHz Band: |
| <input type="checkbox"/> | $N \geq 75$ and ChS \geq MAX (20 dB bandwidth, 25 kHz). |
| <input checked="" type="checkbox"/> | $N \geq 15$ and ChS \geq MAX (20 dB bandwidth x 2/3, 25 kHz). |
| N: Number of Hopping Frequencies; ChS: Hopping Channel Separation | |

3.3.2 Measuring Instruments

Refer a test equipment and calibration data table in this test report.

3.3.3 Test Procedures

| Test Method | |
|-------------------------------------|---|
| <input checked="" type="checkbox"/> | Refer as ANSI C63.10, clause 7.7.3 for number of hopping frequencies measurement. |
| <input checked="" type="checkbox"/> | For conducted measurement. |
| <input checked="" type="checkbox"/> | The EUT supports single transmit chain and measurements performed on this transmit chain. |
| <input type="checkbox"/> | The EUT supports diversity transmitting and the results on transmit chain port 1 is the worst case. |

3.3.4 Test Setup

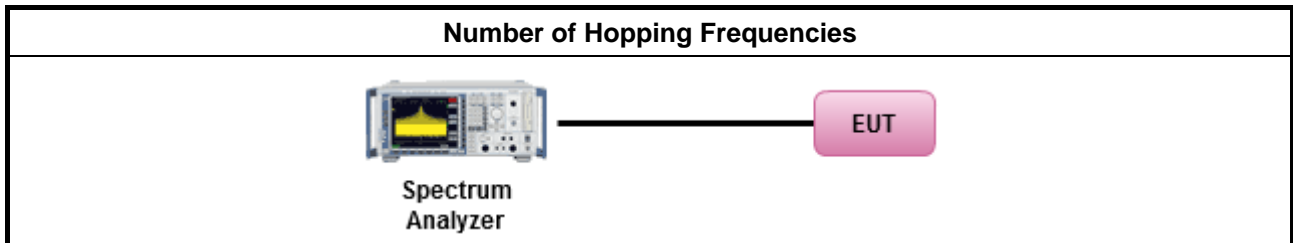

3.3.5 Test Result of Number of Hopping Frequencies

| Number of Hopping Frequencies Result | | | |
|--------------------------------------|-----------------|----------------------------|-------------------------------|
| Modulation Mode | Freq. (MHz) | Hopping Channel Number (N) | Hopping Channel Number Limits |
| BR-1Mbps | 2402-2480 | 79 | 15 |
| EDR-3Mbps | 2402-2480 | 79 | 15 |
| Result | Complied | | |

Number of Hopping Frequencies Plots

BR-1Mbps

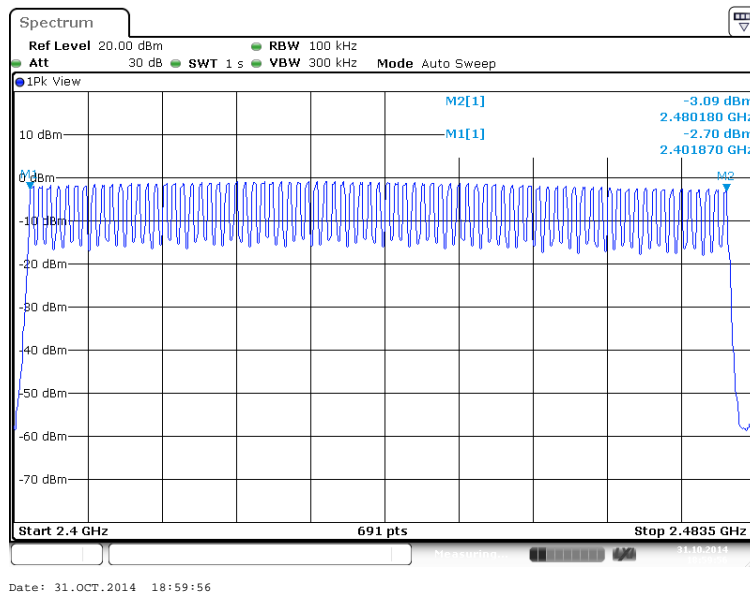

EDR-3Mbps

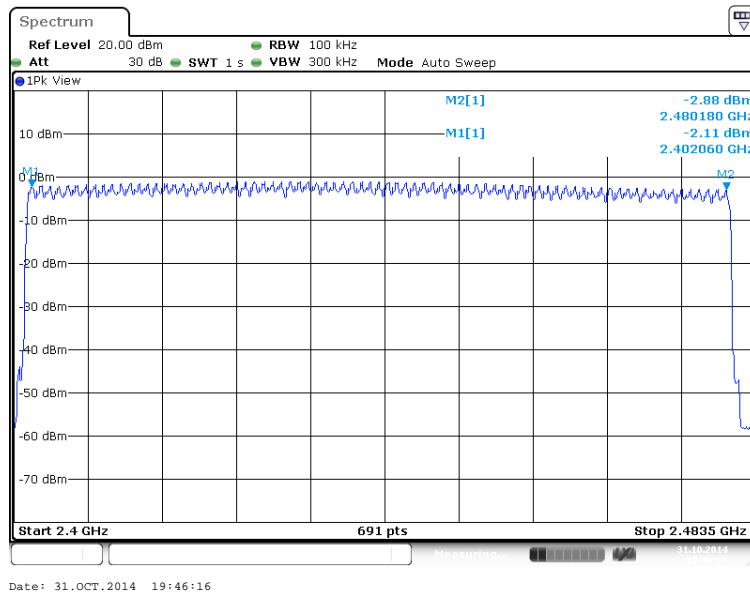

3.4 Time of Occupancy (Dwell Time)

3.4.1 Time of Occupancy (Dwell Time) Limit

| Time of Occupancy (Dwell Time) Limit for Frequency Hopping Systems |
|--|
| <input checked="" type="checkbox"/> 2400-2483.5 MHz Band: Dwell time ≤ 0.4 second within $0.4 \times N$ |
| N: Number of Hopping Frequencies |

3.4.2 Measuring Instruments

Refer a test equipment and calibration data table in this test report.

3.4.3 Test Procedures

| Test Method |
|--|
| <input checked="" type="checkbox"/> Refer as ANSI C63.10, clause 7.7.4 for dwell time measurement. |
| <input checked="" type="checkbox"/> Bluetooth ACL packets can be 1, 3, or 5 time slots. Following as dwell time. Operate DH5 at maximum dwell time and maximum duty cycle. |
| <input checked="" type="checkbox"/> The DH1 packet can cover a single time slot. A maximum length packet has duration of 1 time slots. The hopping rate is 1600 hops/second so the maximum dwell time is $1/1600$ seconds, or 0.625ms. DH1 Packet permit maximum $1600 / 79 / 2 = 10.12$ hops per second in each channel (1 time slot RX, 1 time slot TX). So, the dwell time is the time duration of the pulse times $10.12 \times 31.6 = 320$ within 31.6 seconds. |
| <input checked="" type="checkbox"/> The DH3 packet can cover up to 3 time slots. A maximum length packet has duration of 3 time slots. The hopping rate is 1600 hops/second so the maximum dwell time is $3/1600$ seconds, or 1.875ms. DH3 Packet permit maximum $1600 / 79 / 4 = 5.06$ hops per second in each channel (3 time slots TX, 1 time slot RX). So, the dwell time is the time duration of the pulse times $5.06 \times 31.6 = 160$ within 31.6 seconds. |
| <input checked="" type="checkbox"/> The DH5 packet can cover up to 5 time slots. Operate DH5 at maximum dwell time and maximum duty cycle. A maximum length packet has duration of 5 time slots. The hopping rate is 1600 hops/second so the maximum dwell time is $5/1600$ seconds, or 3.125ms. DH5 Packet permit maximum $1600 / 79 / 6 = 3.37$ hops per second in each channel (5 time slots TX, 1 time slot RX). So, the dwell time is the time duration of the pulse times $3.37 \times 31.6 = 106.6$ within 31.6 seconds |
| <input checked="" type="checkbox"/> For conducted measurement. |
| <input checked="" type="checkbox"/> The EUT supports single transmit chain and measurements performed on this transmit chain. |
| <input type="checkbox"/> The EUT supports diversity transmitting and the results on transmit chain port 1 is the worst case. |

3.4.4 Test Setup

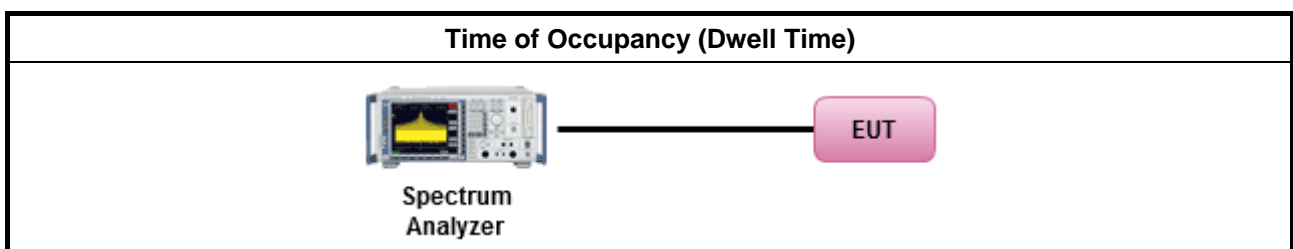

3.4.5 Test Result of Time of Occupancy (Dwell Time)

| Time of Occupancy (Dwell Time) Result | | | | | |
|---------------------------------------|-------------|-------------------------|-------------------------------------|---------------------------------------|-----------------------|
| Modulation Mode | Freq. (MHz) | Pulse Time per Hop (ms) | Number of Pulse in [0.4 x N sec] | Dwell Time in [0.4 x N sec] (s) | Dwell Time Limits (s) |
| BR-1Mbps | 2402 | 2.94 | 106.7 | 0.314 | 0.4 |
| EDR-3Mbps | 2402 | 2.94 | 106.7 | 0.314 | 0.4 |
| Result | | Complied | | | |

Bluetooth ACL packets can be 1, 3, or 5 time slots. The DH1 packet can cover a single time slot. The DH3 packet can cover up to 3 time slots. The DH5 packet can cover up to 5 time slots. Operate DH5 at maximum dwell time and maximum duty cycle. A maximum length packet has duration of 5 time slots. The hopping rate is 1600 hops/second so the maximum dwell time is 5/1600 seconds, or 3.125ms.

Worst Pulse Time per Hop Plots

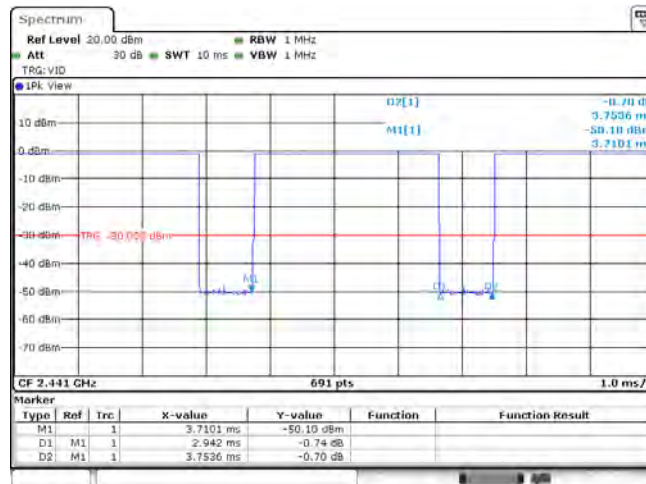

Date: 31.OCT.2014 18:37:07



3.5 RF Output Power

3.5.1 RF Output Power Limit

| RF Output Power Limit for Frequency Hopping Systems | |
|--|---|
| Maximum Peak Conducted Output Power Limit | |
| <input checked="" type="checkbox"/> 2400-2483.5 MHz Band: | |
| <input type="checkbox"/> | For Hopping Channel: $N \geq 75$ |
| <input type="checkbox"/> | If $G_{TX} \leq 6$ dBi, then $P_{Out} \leq 30$ dBm (1 W) |
| <input type="checkbox"/> | If $G_{TX} > 6$ dBi, then $P_{Out} = 30 - (G_{TX} - 6)$ dBm |
| <input checked="" type="checkbox"/> | For Hopping Channel: $N \geq 15$ |
| <input checked="" type="checkbox"/> | If $G_{TX} \leq 6$ dBi, then $P_{Out} \leq 21$ dBm (0.125 W) |
| <input type="checkbox"/> | If $G_{TX} > 6$ dBi, then $P_{Out} = 21 - (G_{TX} - 6)$ dBm |
| e.i.r.p. Power Limit: | |
| <input checked="" type="checkbox"/> 2400-2483.5 MHz Band: | |
| <input type="checkbox"/> | For Hopping Channel: $N \geq 75 - P_{eirp} \leq 36$ dBm (4 W) |
| <input checked="" type="checkbox"/> | For Hopping Channel: $N \geq 15 - P_{eirp} \leq 27$ dBm (0.5 W) |
| G_{TX} = the maximum transmitting antenna directional gain in dBi. P_{eirp} = e.i.r.p. Power in dBm. N : Number of Hopping Frequencies ChS : Hopping Channel Separation | |

3.5.2 Measuring Instruments

Refer a test equipment and calibration data table in this test report.

3.5.3 Test Procedures

| Test Method | |
|-------------------------------------|---|
| <input checked="" type="checkbox"/> | Maximum Peak Conducted Output Power |
| <input type="checkbox"/> | Refer as FCC DA 00-0705, spectrum analyzer for peak power. |
| <input checked="" type="checkbox"/> | Refer as FCC DA 00-0705, peak power meter for peak power. |
| <input type="checkbox"/> | Refer as ANSI C63.10, clause 6.10.2.1 a) for peak power meter. |
| <input type="checkbox"/> | Refer as ANSI C63.10, clause 6.10.2.1 a) for spectrum analyzer - (RBW \geq EBW). |
| <input checked="" type="checkbox"/> | For conducted measurement. |
| <input checked="" type="checkbox"/> | The EUT supports single transmit chain and measurements performed on this transmit chain. |
| <input type="checkbox"/> | The EUT supports diversity transmitting and the results on transmit chain port 1 is the worst case. |

3.5.4 Test Setup

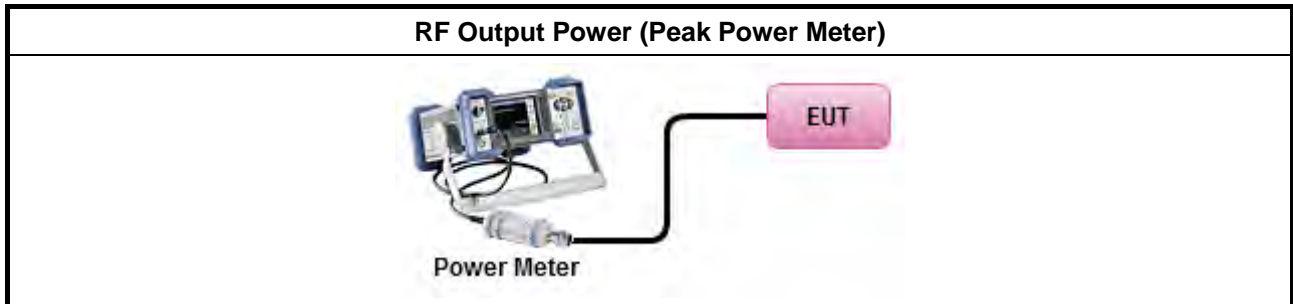

3.5.5 Test Result of Maximum Peak Conducted Output Power

| Maximum Peak Conducted Output Power Result | | | | | | |
|--|-------------|-----------------------|-------------|--------------------|------------|------------|
| Condition | | RF Output Power (dBm) | | | | |
| Modulation Mode | Freq. (MHz) | RF Output Power | Power Limit | Antenna Gain (dBi) | EIRP Power | EIRP Limit |
| BR-1Mbps | 2402 | -0.61 | 21 | 1.10 | 0.49 | 27 |
| BR-1Mbps | 2441 | 0.55 | 21 | 1.10 | 1.65 | 27 |
| BR-1Mbps | 2480 | -0.95 | 21 | 1.10 | 0.15 | 27 |
| EDR-3Mbps | 2402 | 2.28 | 21 | 1.10 | 3.38 | 27 |
| EDR-3Mbps | 2441 | 3.45 | 21 | 1.10 | 4.55 | 27 |
| EDR-3Mbps | 2480 | 2.01 | 21 | 1.10 | 3.11 | 27 |
| Result | | Complied | | | | |

3.5.6 Test Result of Maximum Average Conducted Output Power

| Maximum Average Conducted Output Power Result | | | | | | |
|---|-------------|-----------------------|------------------|-----------------|--------------------|------------|
| Condition | | RF Output Power (dBm) | | | | |
| Modulation Mode | Freq. (MHz) | Average Power | Duty Factor (dB) | RF Output Power | Antenna Gain (dBi) | EIRP Power |
| BR-1Mbps | 2402 | -1.79 | 1.06 | -0.73 | 1.10 | 0.37 |
| BR-1Mbps | 2441 | -0.65 | 1.06 | 0.41 | 1.10 | 1.51 |
| BR-1Mbps | 2480 | -2.18 | 1.06 | -1.12 | 1.10 | -0.02 |
| EDR-3Mbps | 2402 | -1.87 | 1.06 | -0.81 | 1.10 | 0.29 |
| EDR-3Mbps | 2441 | -0.71 | 1.06 | 0.35 | 1.10 | 1.45 |
| EDR-3Mbps | 2480 | -2.21 | 1.06 | -1.15 | 1.10 | -0.05 |
| Result | | Complied | | | | |

3.6 Transmitter Radiated Bandedge Emissions

3.6.1 Transmitter Radiated Bandedge Emissions Limit

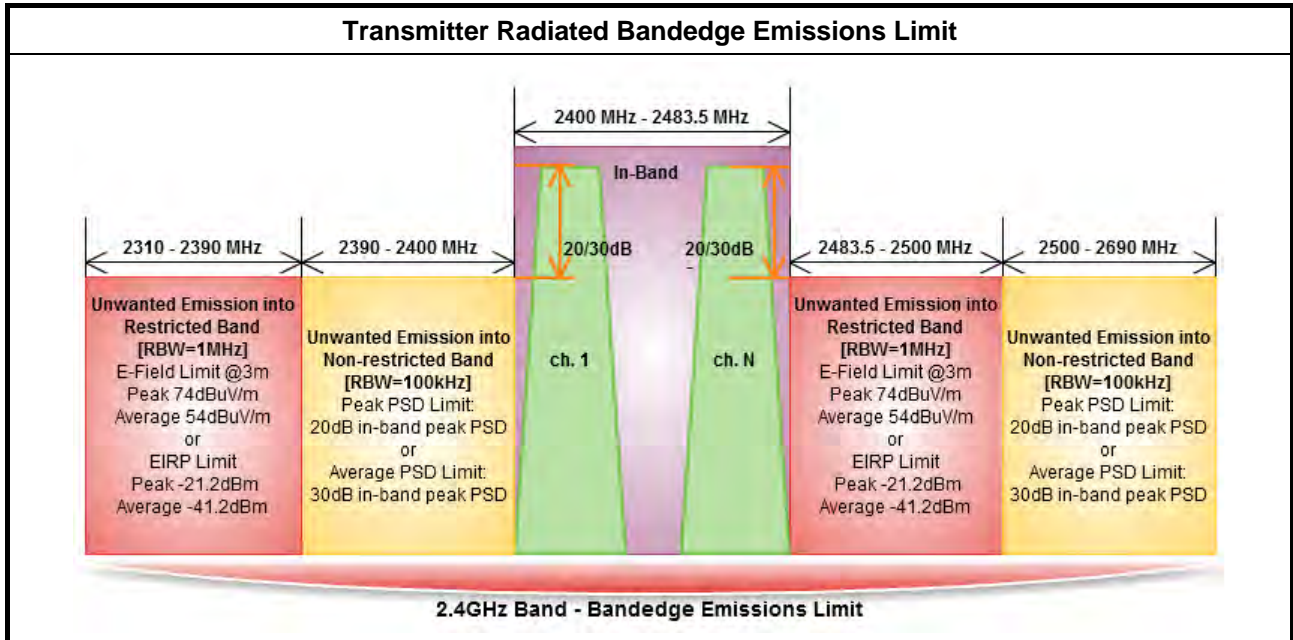

3.6.2 Measuring Instruments

Refer a test equipment and calibration data table in this test report.

3.6.3 Test Procedures

| Test Method – General Information | |
|-------------------------------------|--|
| <input checked="" type="checkbox"/> | The average emission levels shall be measured in [duty cycle \geq 98 or duty factor]. |
| <input checked="" type="checkbox"/> | Refer as ANSI C63.10, clause 6.9.2.2 bandedge testing shall be performed at the lowest frequency channel and highest frequency channel within the allowed operating band. |
| <input checked="" type="checkbox"/> | For the transmitter unwanted emissions shall be measured using following options below: |
| <input checked="" type="checkbox"/> | For unwanted emissions into non-restricted bands. Peak conducted output power measured within any 100 kHz outside the authorized frequency band shall be attenuated by at least 20 dB relative to the maximum measured in-band peak PSD level. |
| <input checked="" type="checkbox"/> | For unwanted emissions into restricted bands. |
| <input checked="" type="checkbox"/> | Refer as ANSI C63.10, clause 4.2.3.2.3 (Reduced VBW). $VBW \geq 1/T$, where T is pulse time. |
| <input type="checkbox"/> | Refer as ANSI C63.10, clause 4.2.3.2.4 average value of pulsed emissions. |
| <input checked="" type="checkbox"/> | Refer as ANSI C63.10, clause 4.2.3.2.2 measurement procedure peak limit. |
| <input checked="" type="checkbox"/> | For the transmitter bandedge emissions shall be measured using following options below: |
| <input checked="" type="checkbox"/> | Refer as ANSI C63.10, clause 6.9.2 for band-edge testing. |
| <input type="checkbox"/> | Refer as ANSI C63.10, clause 6.9.3 for marker-delta method for band-edge measurements. |
| <input checked="" type="checkbox"/> | Refer as ANSI C63.10, clause 7.7.9 for band-edge testing into non-restricted bands. |
| <input checked="" type="checkbox"/> | Refer as ANSI C63.10, clause 6.6 for radiated emissions and test distance is 3m. |

3.6.4 Test Setup

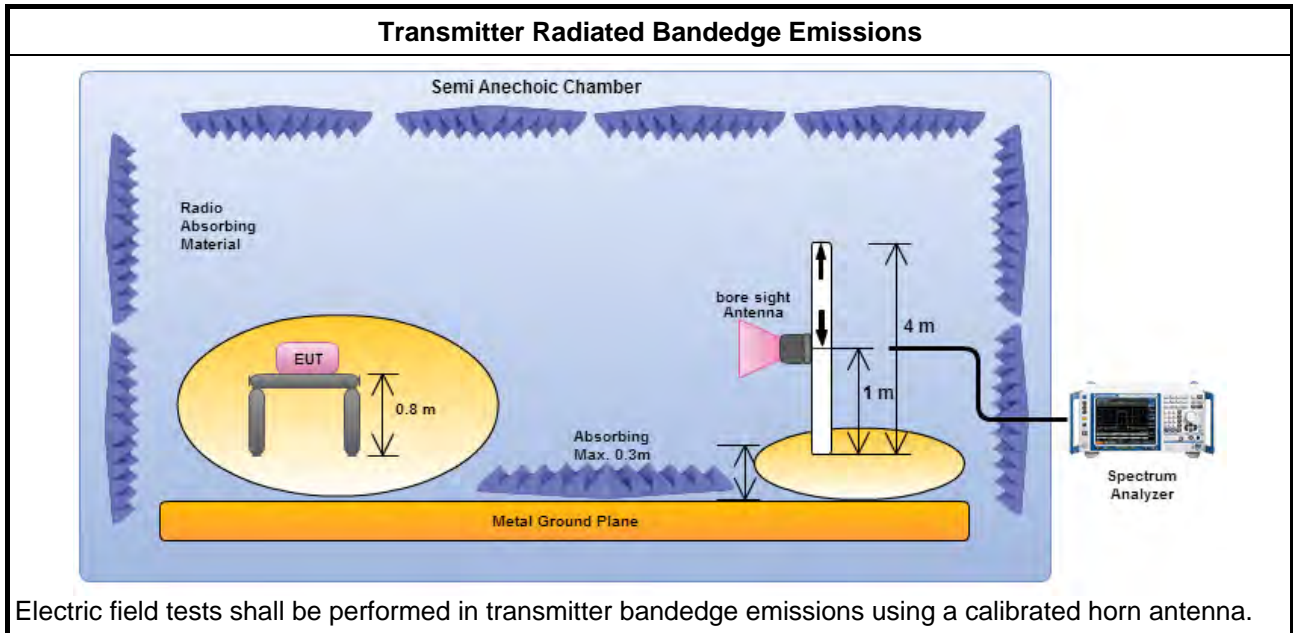



3.6.5 Test Result of Transmitter Radiated Bandedge Emissions

| Transmitter Radiated Bandedge Emissions (Non-restricted Band) | | | | | | | | |
|---|-----------------|------------------|--------------------------|-------------|---------------------------|----------------|------------|------|
| Modulation | N _{TX} | Test Freq. (MHz) | In-band PSD [i] (dBuV/m) | Freq. (MHz) | Out-band PSD [o] (dBuV/m) | [i] – [o] (dB) | Limit (dB) | Pol. |
| BR-1Mbps | 1 | 2402 | 92.90 | 2392.62 | 59.60 | 33.30 | 20 | H |
| BR -1Mbps | 1 | 2480 | 89.15 | 2529.44 | 60.78 | 28.37 | 20 | H |
| EDR-2Mbps | 1 | 2402 | 91.95 | 2393.02 | 59.86 | 32.09 | 20 | H |
| EDR-2Mbps | 1 | 2480 | 89.02 | 2518.24 | 61.76 | 27.26 | 20 | H |
| EDR-3Mbps | 1 | 2402 | 93.09 | 2396.49 | 61.53 | 31.56 | 20 | H |
| EDR-3Mbps | 1 | 2480 | 88.65 | 2508.48 | 60.97 | 27.68 | 20 | H |

Note 1: Measurement worst emissions of receive antenna polarization.
 Note 2: RBW was set to be 100kHz and VBW was 300kHz.

| Transmitter Radiated Bandedge Emissions (Restricted Band) | | | | | | | | | | |
|---|-----------------|-------------|----------------------|----------------|-------------------|-------------------|----------------|-------------------|-------------------|------|
| Modulation Mode | N _{TX} | Freq. (MHz) | Measure Distance (m) | Freq. (MHz) PK | Level (dBuV/m) PK | Limit (dBuV/m) PK | Freq. (MHz) AV | Level (dBuV/m) AV | Limit (dBuV/m) AV | Pol. |
| BR-1Mbps | 1 | 2402 | 3 | 2367.52 | 56.50 | 74 | 2316.32 | 43.81 | 54 | H |
| BR -1Mbps | 1 | 2480 | 3 | 2499.52 | 56.76 | 74 | 2483.52 | 44.12 | 54 | H |
| EDR-2Mbps | 1 | 2402 | 3 | 2317.34 | 56.38 | 74 | 2311.42 | 43.81 | 54 | H |
| EDR-2Mbps | 1 | 2480 | 3 | 2497.92 | 56.55 | 74 | 2483.52 | 44.15 | 54 | H |
| EDR-3Mbps | 1 | 2402 | 3 | 2322.85 | 56.90 | 74 | 2311.22 | 43.79 | 54 | H |
| EDR-3Mbps | 1 | 2480 | 3 | 2492.80 | 56.79 | 74 | 2483.52 | 44.10 | 54 | H |

Note 1: Measurement worst emissions of receive antenna polarization.
 Note 2: Average emission setting: RBW=1MHz; VBW ≥ 1/T, where T is “Pulse On Time”, e.g., DH5 VBW≥1/3.125ms, VBW=1kHz

3.7 Transmitter Radiated Unwanted Emissions

3.7.1 Transmitter Radiated Unwanted Emissions Limit

| Restricted Band Emissions Limit | | | |
|---------------------------------|-----------------------|-------------------------|----------------------|
| Frequency Range (MHz) | Field Strength (uV/m) | Field Strength (dBuV/m) | Measure Distance (m) |
| 0.009~0.490 | 2400/F(kHz) | 48.5 - 13.8 | 300 |
| 0.490~1.705 | 24000/F(kHz) | 33.8 - 23 | 30 |
| 1.705~30.0 | 30 | 29 | 30 |
| 30~88 | 100 | 40 | 3 |
| 88~216 | 150 | 43.5 | 3 |
| 216~960 | 200 | 46 | 3 |
| Above 960 | 500 | 54 | 3 |

Note 1: Test distance for frequencies at or above 30 MHz, measurements may be performed at a distance other than the limit distance provided they are not performed in the near field and the emissions to be measured can be detected by the measurement equipment. When performing measurements at a distance other than that specified, the results shall be extrapolated to the specified distance using an extrapolation factor of 20 dB/decade (inverse of linear distance for field-strength measurements, inverse of linear distance-squared for power-density measurements).

Note 2: Test distance for frequencies at below 30 MHz, measurements may be performed at a distance closer than the EUT limit distance; however, an attempt should be made to avoid making measurements in the near field. When performing measurements below 30 MHz at a closer distance than the limit distance, the results shall be extrapolated to the specified distance by either making measurements at a minimum of two or more distances on at least one radial to determine the proper extrapolation factor or by using the square of an inverse linear distance extrapolation factor (40 dB/decade). The test report shall specify the extrapolation method used to determine compliance of the EUT.

| Un-restricted Band Emissions Limit | |
|------------------------------------|------------|
| RF output power procedure | Limit (dB) |
| Peak output power procedure | 20 |
| Average output power procedure | 30 |

Note 1: If the peak output power procedure is used to measure the fundamental emission power to demonstrate compliance to requirements, then the peak conducted output power measured within any 100 kHz outside the authorized frequency band shall be attenuated by at least 20 dB relative to the maximum measured in-band peak PSD level.

Note 2: If the average output power procedure is used to measure the fundamental emission power to demonstrate compliance to requirements, then the power in any 100 kHz outside of the authorized frequency band shall be attenuated by at least 30 dB relative to the maximum measured in-band average PSD level.

3.7.2 Measuring Instruments

Refer a test equipment and calibration data table in this test report.



3.7.3 Test Procedures

| Test Method – General Information | |
|-------------------------------------|---|
| <input checked="" type="checkbox"/> | Measurements may be performed at a distance other than the limit distance provided they are not performed in the near field and the emissions to be measured can be detected by the measurement equipment. When performing measurements at a distance other than that specified, the results shall be extrapolated to the specified distance using an extrapolation factor of 20 dB/decade (inverse of linear distance for field-strength measurements, inverse of linear distance-squared for power-density measurements). |
| <input checked="" type="checkbox"/> | The average emission levels shall be measured in [duty cycle \geq 98 or duty factor]. |
| <input checked="" type="checkbox"/> | For the transmitter unwanted emissions shall be measured using following options below: |
| <input checked="" type="checkbox"/> | Refer as FCC DA 00-0705, for spurious radiated emissions. The dwell time per channel of the hopping signal is less than 100 ms, then the reading obtained with the 10 Hz VBW may be further adjusted by a “duty cycle correction factor”, derived from $20\log(\text{dwell time}/100 \text{ ms})$ |
| <input checked="" type="checkbox"/> | For unwanted emissions into non-restricted bands. Peak conducted output power measured within any 100 kHz outside the authorized frequency band shall be attenuated by at least 20 dB relative to the maximum measured in-band peak PSD level. |
| <input checked="" type="checkbox"/> | For unwanted emissions into restricted bands. |
| <input checked="" type="checkbox"/> | Refer as ANSI C63.10, clause 4.2.3.2.3 (Reduced VBW). $\text{VBW} \geq 1/T$, where T is pulse time. |
| <input type="checkbox"/> | Refer as ANSI C63.10, clause 4.2.3.2.4 average value of pulsed emissions. |
| <input checked="" type="checkbox"/> | Refer as ANSI C63.10, clause 4.2.3.2.2 measurement procedure peak limit. |
| <input checked="" type="checkbox"/> | For radiated measurement. |
| <input checked="" type="checkbox"/> | Refer as ANSI C63.10, clause 6.4 for radiated emissions below 30 MHz and test distance is 3m. |
| <input checked="" type="checkbox"/> | Refer as ANSI C63.10, clause 6.5 for radiated emissions 30 MHz to 1 GHz and test distance is 3m. |
| <input checked="" type="checkbox"/> | Refer as ANSI C63.10, clause 6.6 for radiated emissions above 1 GHz and test distance is 3m. |
| <input checked="" type="checkbox"/> | The any unwanted emissions level shall not exceed the fundamental emission level. |
| <input checked="" type="checkbox"/> | All amplitude of spurious emissions that are attenuated by more than 20 dB below the permissible value has no need to be reported. |

3.7.4 Test Setup

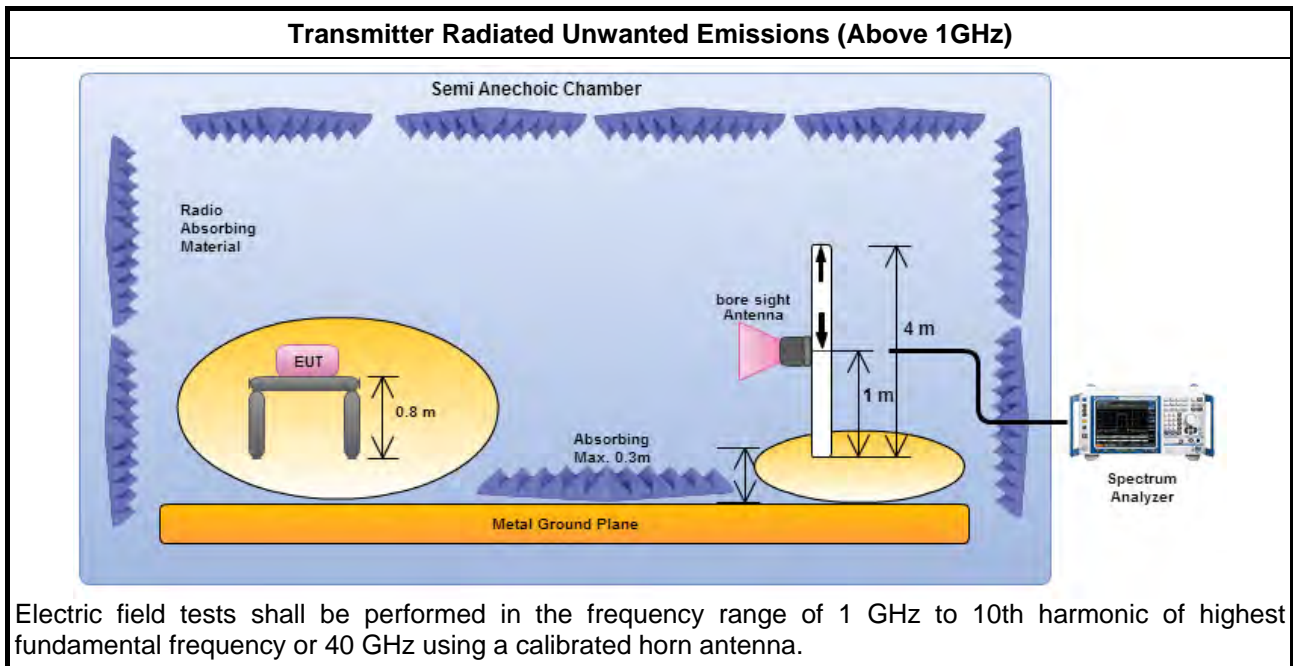
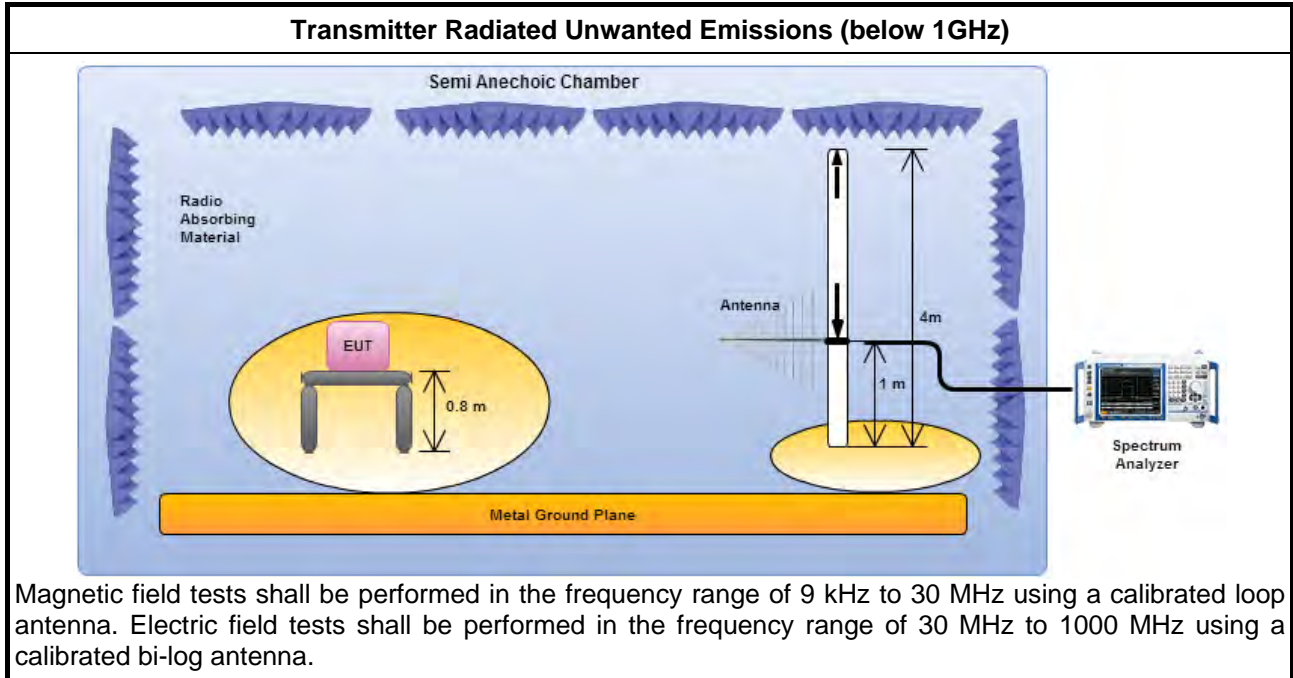

3.7.5 Transmitter Radiated Unwanted Emissions (Below 30MHz)

All amplitude of spurious emissions that are attenuated by more than 20 dB below the permissible value has no need to be reported.



3.7.6 Transmitter Radiated Unwanted Emissions (Below 1GHz)

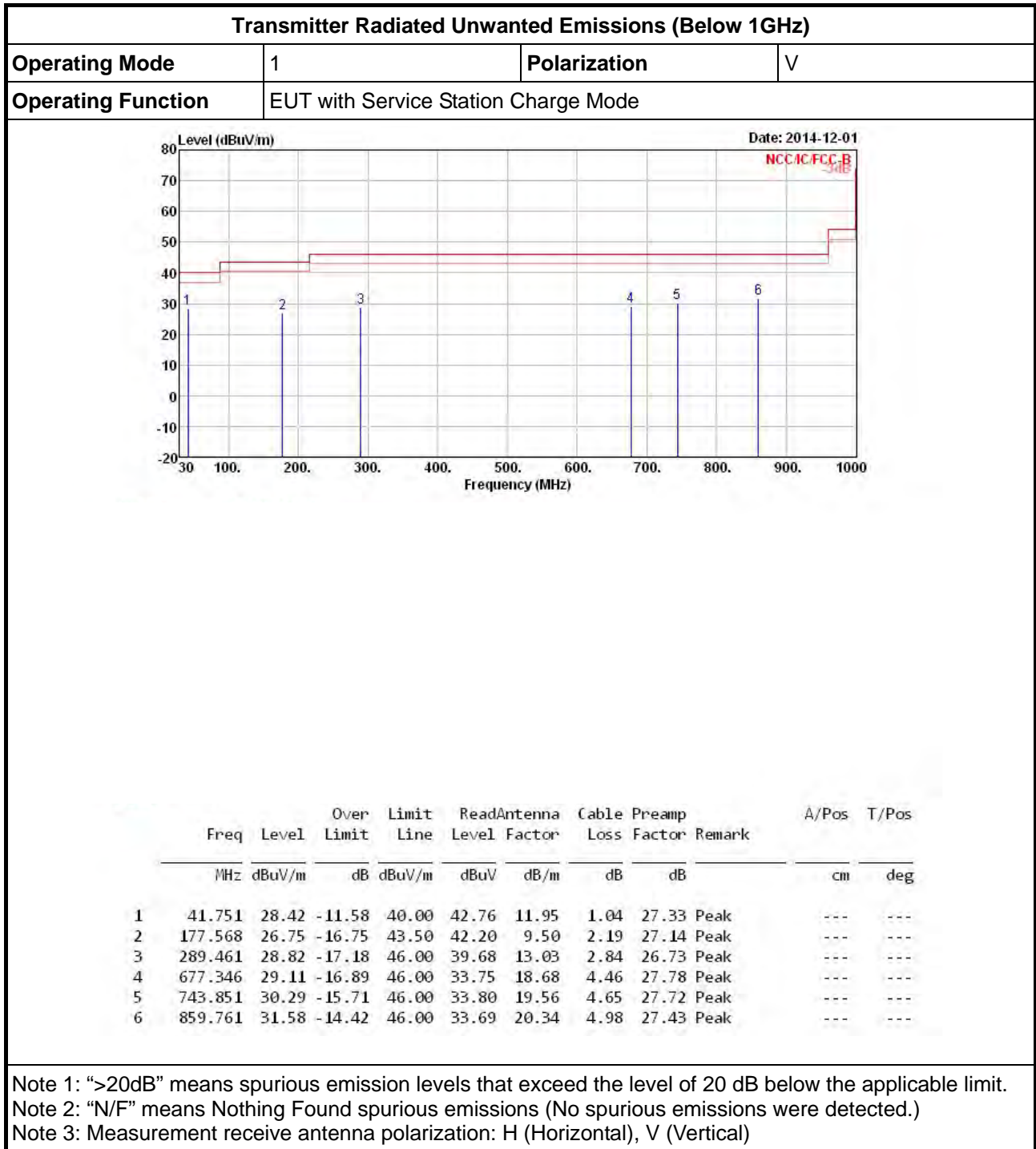

Transmitter Radiated Unwanted Emissions (Below 1GHz)

| | | | |
|--------------------|--------------------------------------|--------------|---|
| Operating Mode | 1 | Polarization | H |
| Operating Function | EUT with Service Station Charge Mode | | |

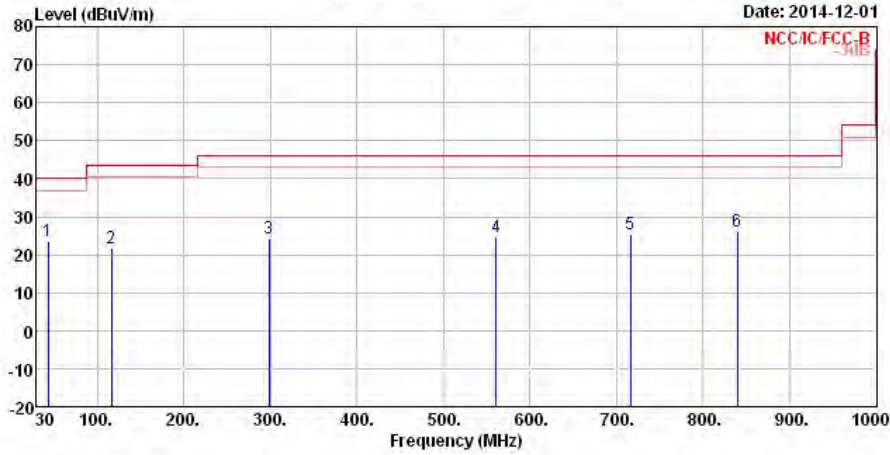

| | Freq | Level | Over Limit | Limit Line | ReadAntenna Level | Antenna Factor | Cable Loss | Preamplifier Factor | Remark | A/Pos | T/Pos |
|---|---------|--------|------------|------------|-------------------|----------------|------------|---------------------|--------|-------|-------|
| | MHz | dBuV/m | dB | dBuV/m | dBuV | dB/m | dB | dB | | cm | deg |
| 1 | 43.421 | 23.62 | -16.38 | 40.00 | 39.08 | 10.82 | 1.06 | 27.34 | Peak | --- | --- |
| 2 | 116.253 | 21.69 | -21.81 | 43.50 | 34.97 | 12.15 | 1.75 | 27.18 | Peak | --- | --- |
| 3 | 298.150 | 24.26 | -21.74 | 46.00 | 34.87 | 13.19 | 2.89 | 26.69 | Peak | --- | --- |
| 4 | 561.238 | 24.75 | -21.25 | 46.00 | 30.31 | 18.31 | 3.97 | 27.84 | Peak | --- | --- |
| 5 | 715.853 | 25.37 | -20.63 | 46.00 | 29.44 | 19.10 | 4.59 | 27.76 | Peak | --- | --- |
| 6 | 839.457 | 26.12 | -19.88 | 46.00 | 28.49 | 20.19 | 4.93 | 27.49 | Peak | --- | --- |

Note 1: ">20dB" means spurious emission levels that exceed the level of 20 dB below the applicable limit.
 Note 2: "N/F" means Nothing Found spurious emissions (No spurious emissions were detected.)
 Note 3: Measurement receive antenna polarization: H (Horizontal), V (Vertical)



Transmitter Radiated Unwanted Emissions (Below 1GHz)

| | | | |
|--------------------|---|--------------|---|
| Operating Mode | 2 | Polarization | V |
| Operating Function | EUT with AC power via Debug Board Transmitter | | |

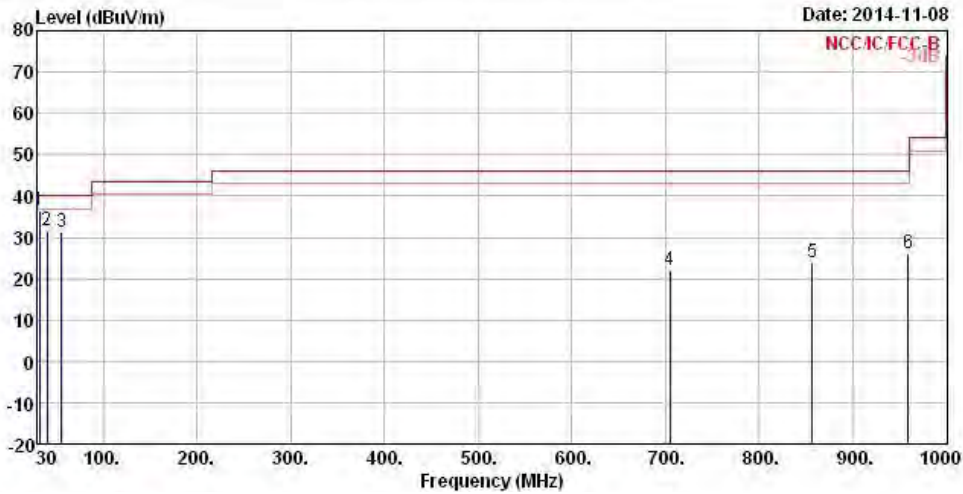

| | Freq | Level | Over Limit | Limit Line | ReadAntenna Level | Antenna Factor | Cable Loss | Preamp Factor | Remark | A/Pos | T/Pos |
|---|---------|--------|------------|------------|-------------------|----------------|------------|---------------|--------|-------|-------|
| | MHz | dBuV/m | dB | dBuV/m | dBuV | dB/m | dB | dB | | cm | deg |
| 1 | 31.940 | 36.49 | -3.51 | 40.00 | 45.21 | 17.76 | 0.87 | 27.35 | QP | --- | --- |
| 2 | 39.700 | 31.50 | -8.50 | 40.00 | 44.70 | 13.08 | 1.02 | 27.30 | Peak | --- | --- |
| 3 | 55.220 | 31.35 | -8.65 | 40.00 | 50.60 | 6.93 | 1.18 | 27.36 | Peak | --- | --- |
| 4 | 705.120 | 22.16 | -23.84 | 46.00 | 26.48 | 18.89 | 4.57 | 27.78 | Peak | --- | --- |
| 5 | 856.440 | 23.84 | -22.16 | 46.00 | 26.00 | 20.32 | 4.96 | 27.44 | Peak | --- | --- |
| 6 | 959.260 | 26.26 | -19.74 | 46.00 | 27.03 | 21.24 | 5.36 | 27.37 | Peak | --- | --- |

Note 1: ">20dB" means spurious emission levels that exceed the level of 20 dB below the applicable limit.
 Note 2: "N/F" means Nothing Found spurious emissions (No spurious emissions were detected.)
 Note 3: Measurement receive antenna polarization: H (Horizontal), V (Vertical)



Transmitter Radiated Unwanted Emissions (Below 1GHz)

| | | | |
|--------------------|---|--------------|---|
| Operating Mode | 2 | Polarization | H |
| Operating Function | EUT with AC power via Debug Board Transmitter | | |

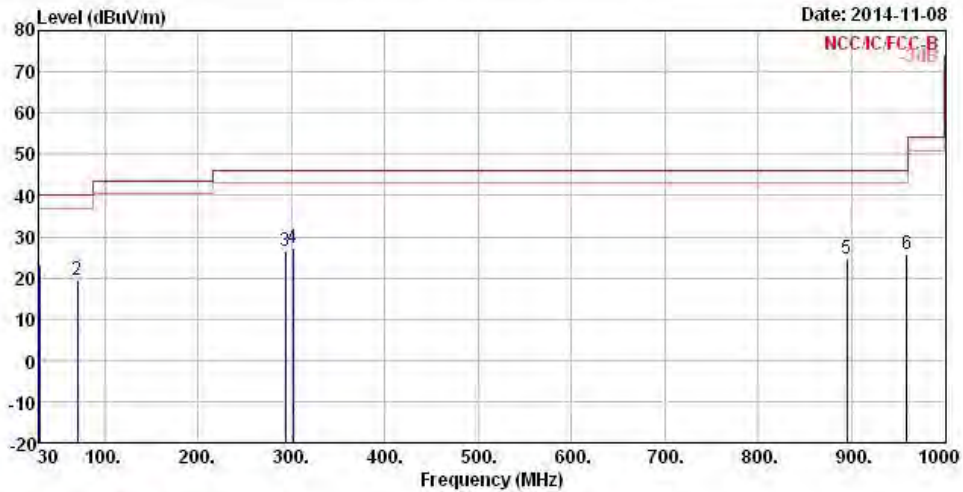

| | Freq | Level | Over Limit | Limit Line | ReadAntenna Level | Antenna Factor | Cable Loss | Preamp Factor | Remark | A/Pos | T/Pos |
|---|---------|--------|------------|------------|-------------------|----------------|------------|---------------|--------|-------|-------|
| | MHz | dBuV/m | dB | dBuV/m | dBuV | dB/m | dB | dB | | cm | deg |
| 1 | 30.000 | 23.21 | -16.79 | 40.00 | 30.93 | 18.85 | 0.82 | 27.39 | Peak | --- | --- |
| 2 | 70.740 | 19.57 | -20.43 | 40.00 | 38.93 | 6.72 | 1.35 | 27.43 | Peak | --- | --- |
| 3 | 293.840 | 26.39 | -19.61 | 46.00 | 37.11 | 13.12 | 2.87 | 26.71 | Peak | --- | --- |
| 4 | 301.600 | 27.09 | -18.91 | 46.00 | 37.60 | 13.27 | 2.91 | 26.69 | Peak | --- | --- |
| 5 | 895.240 | 24.51 | -21.49 | 46.00 | 26.18 | 20.47 | 5.16 | 27.30 | Peak | --- | --- |
| 6 | 959.260 | 25.61 | -20.39 | 46.00 | 26.38 | 21.24 | 5.36 | 27.37 | Peak | --- | --- |

Note 1: ">20dB" means spurious emission levels that exceed the level of 20 dB below the applicable limit.
 Note 2: "N/F" means Nothing Found spurious emissions (No spurious emissions were detected.)
 Note 3: Measurement receive antenna polarization: H (Horizontal), V (Vertical)



3.7.7 Transmitter Radiated Unwanted Emissions - (Above 1GHz WORST-CASE DATA)

| Transmitter Radiated Unwanted Emissions (Above 1GHz) | | | |
|--|-----------|------------------|------|
| Modulation Mode | EDR-3Mbps | Test Freq. (MHz) | 2402 |
| Operating Function | Transmit | Polarization | V |

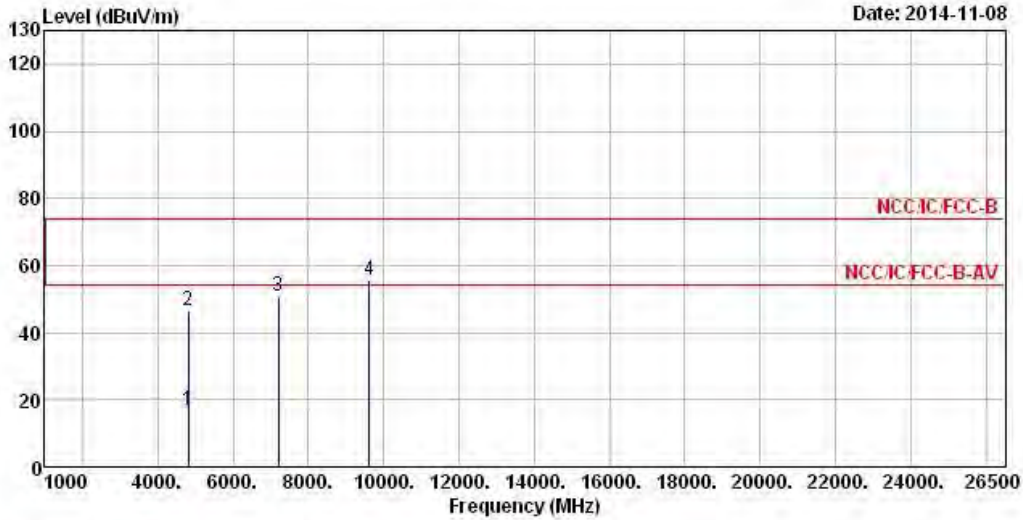

| | Freq | Level | Over Limit | Limit Line | ReadAntenna Level | Antenna Factor | Cable Loss | Preamp Factor | Remark | A/Pos | T/Pos |
|---|----------|--------|------------|------------|-------------------|----------------|------------|---------------|---------|-------|-------|
| | MHz | dBuV/m | dB | dBuV/m | dBuV | dB/m | dB | dB | | cm | deg |
| 1 | 4804.000 | 16.62 | -37.38 | 54.00 | 10.18 | 33.20 | 5.71 | 32.47 | Average | --- | --- |
| 2 | 4804.000 | 46.72 | -27.28 | 74.00 | 40.28 | 33.20 | 5.71 | 32.47 | Peak | --- | --- |
| 3 | 7206.000 | 51.05 | ----- | ----- | 40.64 | 35.84 | 7.20 | 32.63 | Peak | --- | --- |
| 4 | 9608.000 | 55.72 | ----- | ----- | 41.68 | 38.37 | 8.81 | 33.14 | Peak | --- | --- |

- Note 1: ">20dB" means spurious emission levels that exceed the level of 20 dB below the applicable limit.
- Note 2: Measurement receive antenna polarization: H (Horizontal), V (Vertical)
- Note 3: For restricted bands, the peak measurement is fully sufficient, as the max field strength as measured with the Peak-Detector meets the AV-Limit so that the AV level does not need to be reported in addition.
- Note 4: For un-restricted bands, unwanted emissions shall be attenuated by at least 20 dB relative to the maximum measured in-band level (95.02 dBuV/m). RBW and VBW setting for Peak emission were set to be 1MHz and 3MHz respectively.
- Note 5: Average emission setting: RBW=1MHz; VBW ≥ 1/T, where T is "Pulse On Time", e.g., DH5 VBW≥1/3.125ms, VBW=1kHz.



Transmitter Radiated Unwanted Emissions (Above 1GHz)

| | | | |
|--------------------|-----------|------------------|------|
| Modulation Mode | EDR-3Mbps | Test Freq. (MHz) | 2402 |
| Operating Function | Transmit | Polarization | H |

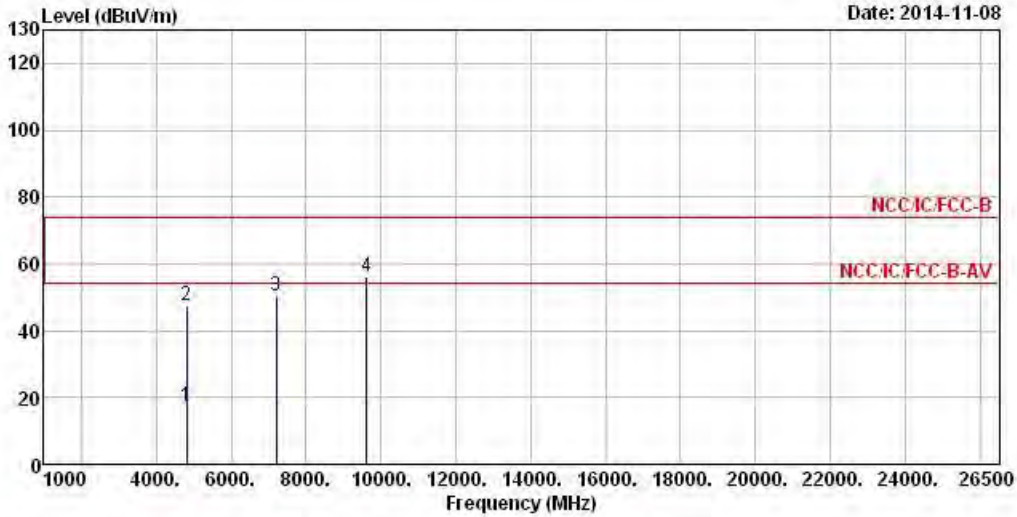

| | Freq | Level | Over Limit | Limit Line | ReadAntenna Level | Antenna Factor | Cable Loss | Preamp Factor | Remark | A/Pos | T/Pos |
|---|----------|--------|------------|------------|-------------------|----------------|------------|---------------|---------|-------|-------|
| | MHz | dBuV/m | dB | dBuV/m | dBuV | dB/m | dB | dB | | cm | deg |
| 1 | 4804.000 | 17.18 | -36.82 | 54.00 | 10.74 | 33.20 | 5.71 | 32.47 | Average | --- | --- |
| 2 | 4804.000 | 47.28 | -26.72 | 74.00 | 40.84 | 33.20 | 5.71 | 32.47 | Peak | --- | --- |
| 3 | 7206.000 | 50.41 | | | 40.00 | 35.84 | 7.20 | 32.63 | Peak | --- | --- |
| 4 | 9608.000 | 55.93 | | | 41.89 | 38.37 | 8.81 | 33.14 | Peak | --- | --- |

- Note 1: ">20dB" means spurious emission levels that exceed the level of 20 dB below the applicable limit.
- Note 2: Measurement receive antenna polarization: H (Horizontal), V (Vertical)
- Note 3: For restricted bands, the peak measurement is fully sufficient, as the max field strength as measured with the Peak-Detector meets the AV-Limit so that the AV level does not need to be reported in addition.
- Note 4: For un-restricted bands, unwanted emissions shall be attenuated by at least 20 dB relative to the maximum measured in-band level (95.02 dBuV/m). RBW and VBW setting for Peak emission were set to be 1MHz and 3MHz respectively.
- Note 5: Average emission setting: RBW=1MHz; VBW ≥ 1/T, where T is "Pulse On Time", e.g., DH5 VBW≥1/3.125ms, VBW=1kHz.



Transmitter Radiated Unwanted Emissions (Above 1GHz)

| | | | |
|--------------------|-----------|------------------|------|
| Modulation Mode | EDR-3Mbps | Test Freq. (MHz) | 2441 |
| Operating Function | Transmit | Polarization | V |

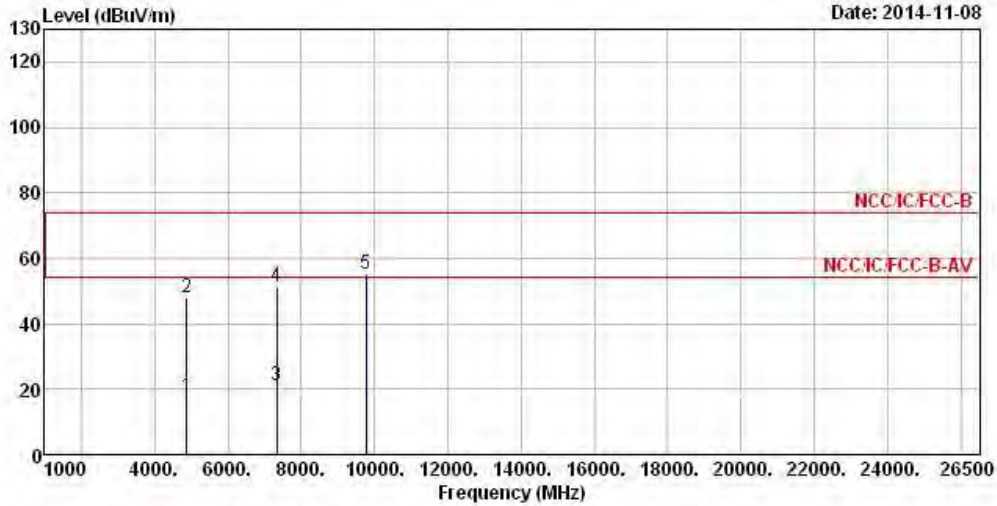

| | Freq | Level | Over-Limit | Limit Line | ReadAntenna Level | Antenna Factor | Cable Loss | Preamp Factor | Remark | A/Pos | T/Pos |
|---|----------|--------|------------|------------|-------------------|----------------|------------|---------------|---------|-------|-------|
| | MHz | dBuV/m | dB | dBuV/m | dBuV | dB/m | dB | dB | | cm | deg |
| 1 | 4882.000 | 17.89 | -36.11 | 54.00 | 11.30 | 33.31 | 5.73 | 32.45 | Average | --- | --- |
| 2 | 4882.000 | 47.99 | -26.01 | 74.00 | 41.40 | 33.31 | 5.73 | 32.45 | Peak | --- | --- |
| 3 | 7323.000 | 21.11 | -32.89 | 54.00 | 10.36 | 36.15 | 7.28 | 32.68 | Average | --- | --- |
| 4 | 7323.000 | 51.21 | -22.79 | 74.00 | 40.46 | 36.15 | 7.28 | 32.68 | Peak | --- | --- |
| 5 | 9764.000 | 55.36 | | | 41.09 | 38.64 | 8.76 | 33.13 | Peak | --- | --- |

- Note 1: ">20dB" means spurious emission levels that exceed the level of 20 dB below the applicable limit.
- Note 2: Measurement receive antenna polarization: H (Horizontal), V (Vertical)
- Note 3: For restricted bands, the peak measurement is fully sufficient, as the max field strength as measured with the Peak-Detector meets the AV-Limit so that the AV level does not need to be reported in addition.
- Note 4: For un-restricted bands, unwanted emissions shall be attenuated by at least 20 dB relative to the maximum measured in-band level (94.44 dBuV/m). RBW and VBW setting for Peak emission were set to be 1MHz and 3MHz respectively.
- Note 5: Average emission setting: RBW=1MHz; VBW ≥ 1/T, where T is "Pulse On Time", e.g., DH5 VBW≥1/3.125ms, VBW=1kHz.



Transmitter Radiated Unwanted Emissions (Above 1GHz)

| | | | |
|--------------------|-----------|------------------|------|
| Modulation Mode | EDR-3Mbps | Test Freq. (MHz) | 2441 |
| Operating Function | Transmit | Polarization | H |

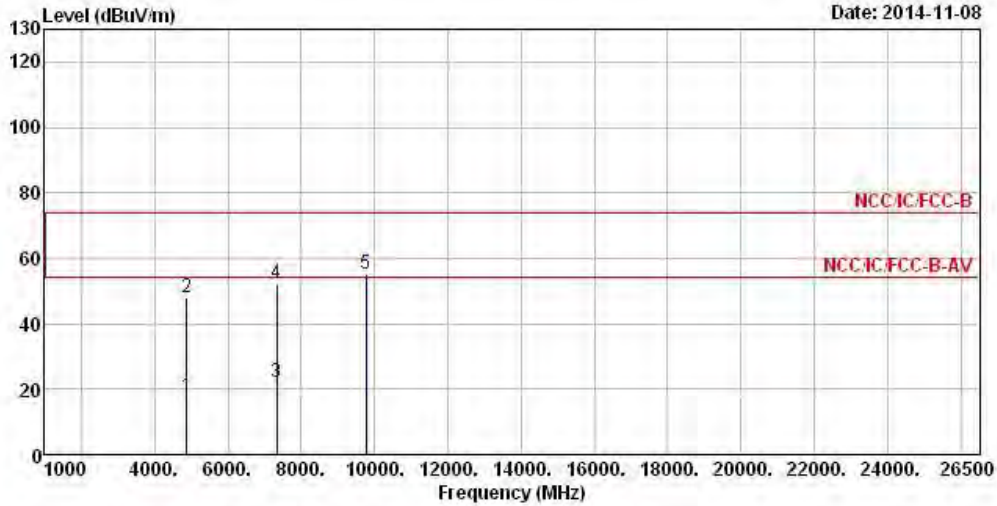

| | Freq | Level | Over-Limit | Limit Line | ReadAntenna Level | Antenna Factor | Cable Loss | Preamplifier | Remark | A/Pos | T/Pos |
|---|----------|--------|------------|------------|-------------------|----------------|------------|--------------|---------|-------|-------|
| | MHz | dBuV/m | dB | dBuV/m | dBuV | dB/m | dB | dB | | cm | deg |
| 1 | 4882.000 | 17.67 | -36.33 | 54.00 | 11.08 | 33.31 | 5.73 | 32.45 | Average | --- | --- |
| 2 | 4882.000 | 47.77 | -26.23 | 74.00 | 41.18 | 33.31 | 5.73 | 32.45 | Peak | --- | --- |
| 3 | 7323.000 | 22.29 | -31.71 | 54.00 | 11.54 | 36.15 | 7.28 | 32.68 | Average | --- | --- |
| 4 | 7323.000 | 52.39 | -21.61 | 74.00 | 41.64 | 36.15 | 7.28 | 32.68 | Peak | --- | --- |
| 5 | 9764.000 | 55.36 | | | 41.09 | 38.64 | 8.76 | 33.13 | Peak | --- | --- |

- Note 1: ">20dB" means spurious emission levels that exceed the level of 20 dB below the applicable limit.
- Note 2: Measurement receive antenna polarization: H (Horizontal), V (Vertical)
- Note 3: For restricted bands, the peak measurement is fully sufficient, as the max field strength as measured with the Peak-Detector meets the AV-Limit so that the AV level does not need to be reported in addition.
- Note 4: For un-restricted bands, unwanted emissions shall be attenuated by at least 20 dB relative to the maximum measured in-band level (94.44 dBuV/m). RBW and VBW setting for Peak emission were set to be 1MHz and 3MHz respectively.
- Note 5: Average emission setting: RBW=1MHz; VBW ≥ 1/T, where T is "Pulse On Time", e.g., DH5 VBW≥1/3.125ms, VBW=1kHz.



| Transmitter Radiated Unwanted Emissions (Above 1GHz) | | | |
|--|-----------|------------------|------|
| Modulation Mode | EDR-3Mbps | Test Freq. (MHz) | 2480 |
| Operating Function | Transmit | Polarization | V |

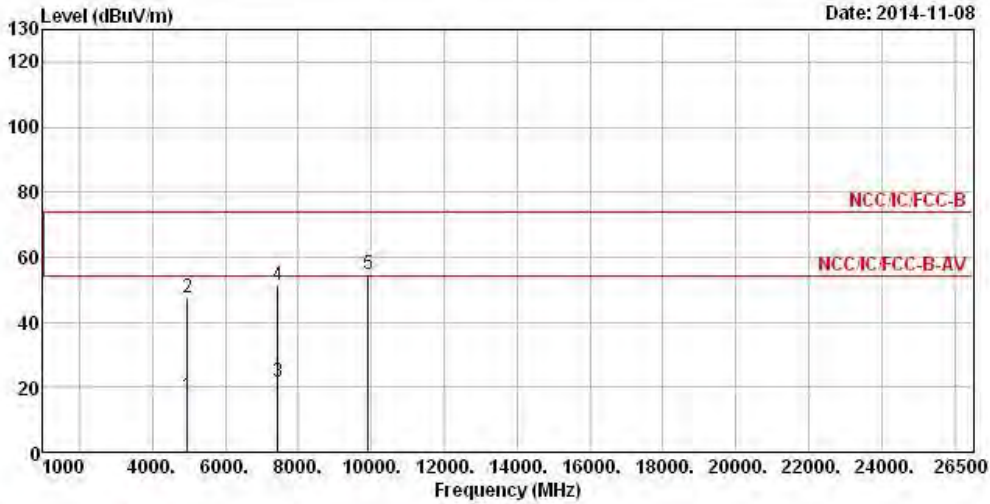

| | Freq | Level | Over Limit | Limit Line | ReadAntenna Level | Antenna Factor | Cable Loss | Preamp Factor | Remark | A/Pos | T/Pos |
|---|----------|--------|------------|------------|-------------------|----------------|------------|---------------|---------|-------|-------|
| | MHz | dBuV/m | dB | dBuV/m | dBuV | dB/m | dB | dB | | cm | deg |
| 1 | 4960.000 | 17.41 | -36.59 | 54.00 | 10.66 | 33.44 | 5.75 | 32.44 | Average | --- | --- |
| 2 | 4960.000 | 47.51 | -26.49 | 74.00 | 40.76 | 33.44 | 5.75 | 32.44 | Peak | --- | --- |
| 3 | 7440.000 | 21.36 | -32.64 | 54.00 | 10.24 | 36.47 | 7.37 | 32.72 | Average | --- | --- |
| 4 | 7440.000 | 51.46 | -22.54 | 74.00 | 40.34 | 36.47 | 7.37 | 32.72 | Peak | --- | --- |
| 5 | 9920.000 | 54.74 | | | 40.27 | 38.89 | 8.71 | 33.13 | Peak | --- | --- |

- Note 1: ">20dB" means spurious emission levels that exceed the level of 20 dB below the applicable limit.
 Note 2: Measurement receive antenna polarization: H (Horizontal), V (Vertical)
 Note 3: For restricted bands, the peak measurement is fully sufficient, as the max field strength as measured with the Peak-Detector meets the AV-Limit so that the AV level does not need to be reported in addition.
 Note 4: For un-restricted bands, unwanted emissions shall be attenuated by at least 20 dB relative to the maximum measured in-band level (90.41 dBuV/m). RBW and VBW setting for Peak emission were set to be 1MHz and 3MHz respectively.
 Note 5: Average emission setting: RBW=1MHz; VBW ≥ 1/T, where T is "Pulse On Time", e.g., DH5 VBW≥1/3.125ms, VBW=1kHz.



Transmitter Radiated Unwanted Emissions (Above 1GHz)

| | | | |
|--------------------|-----------|------------------|------|
| Modulation Mode | EDR-3Mbps | Test Freq. (MHz) | 2480 |
| Operating Function | Transmit | Polarization | H |

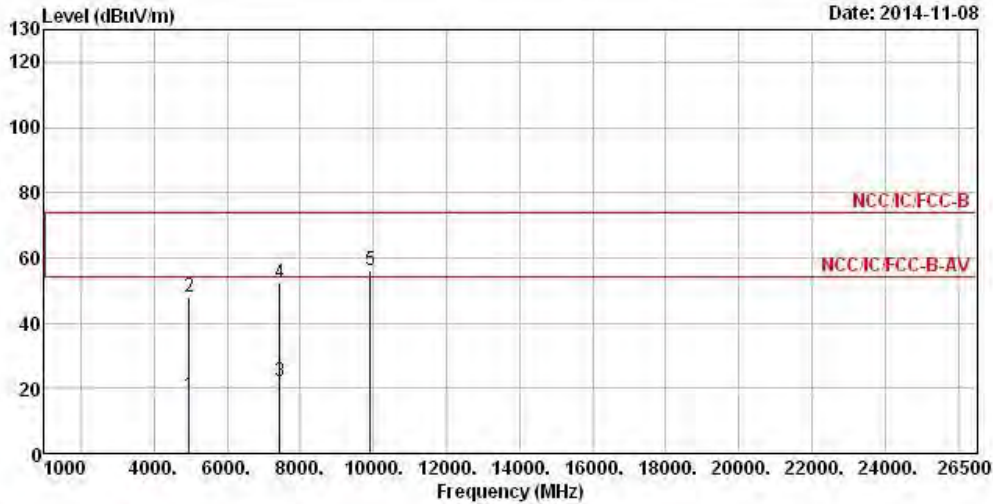

| | Freq | Level | Over Limit | Limit Line | ReadAntenna Level | Antenna Factor | Cable Loss | Preamp Factor | Remark | A/Pos | T/Pos |
|---|----------|--------|------------|------------|-------------------|----------------|------------|---------------|---------|-------|-------|
| | MHz | dBuV/m | dB | dBuV/m | dBuV | dB/m | dB | dB | | cm | deg |
| 1 | 4960.000 | 17.95 | -36.05 | 54.00 | 11.20 | 33.44 | 5.75 | 32.44 | Average | --- | --- |
| 2 | 4960.000 | 48.05 | -25.95 | 74.00 | 41.30 | 33.44 | 5.75 | 32.44 | Peak | --- | --- |
| 3 | 7440.000 | 22.21 | -31.79 | 54.00 | 11.09 | 36.47 | 7.37 | 32.72 | Average | --- | --- |
| 4 | 7440.000 | 52.31 | -21.69 | 74.00 | 41.19 | 36.47 | 7.37 | 32.72 | Peak | --- | --- |
| 5 | 9920.000 | 56.17 | | | 41.70 | 38.89 | 8.71 | 33.13 | Peak | --- | --- |

- Note 1: ">20dB" means spurious emission levels that exceed the level of 20 dB below the applicable limit.
- Note 2: Measurement receive antenna polarization: H (Horizontal), V (Vertical)
- Note 3: For restricted bands, the peak measurement is fully sufficient, as the max field strength as measured with the Peak-Detector meets the AV-Limit so that the AV level does not need to be reported in addition.
- Note 4: For un-restricted bands, unwanted emissions shall be attenuated by at least 20 dB relative to the maximum measured in-band level (90.41 dBuV/m). RBW and VBW setting for Peak emission were set to be 1MHz and 3MHz respectively.
- Note 5: Average emission setting: RBW=1MHz; VBW ≥ 1/T, where T is "Pulse On Time", e.g., DH5 VBW≥1/3.125ms, VBW=1kHz.



4 Test Equipment and Calibration Data

| Instrument | Manufacturer | Model No. | Serial No. | Characteristics | Calibration Date | Remark |
|--------------|--------------------------------|-----------|----------------|-----------------|------------------|---------------|
| EMC Receiver | R&S | ESCS 30 | 100174 | 9kHz ~ 2.75GHz | Apr. 14, 2014 | AC Conduction |
| LISN | SCHWARZBECK MESS-ELEKTRONIK | NSLK 8127 | 8127-477 | 9kHz ~ 30MHz | Jan. 22, 2014 | AC Conduction |
| RF Cable-CON | HUBER+SUHNER | RG213/U | 07611832020001 | 9kHz ~ 30MHz | Oct. 31, 2014 | AC Conduction |
| EMI Filter | LINDGREN | LRE-2030 | 2651 | < 450 Hz | N/A | AC Conduction |
| BT Station | R&S | CBT | 100959 | N/A | Mar. 10, 2014 | AC Conduction |

Note: Calibration Interval of instruments listed above is one year.

| Instrument | Manufacturer | Model No. | Serial No. | Characteristics | Calibration Date | Remark |
|-------------------|--------------|--------------|-------------|-----------------|------------------|--------------|
| Spectrum Analyzer | R&S | FSV 40 | 101013 | 9KHz~40GHz | Jan. 25, 2014 | RF Conducted |
| AC Power Source | G.W | APS-9102 | EL920581 | AC 0V ~ 300V | Jul. 15, 2014 | RF Conducted |
| Signal Generator | R&S | SMR40 | 100116 | 10MHz ~ 40GHz | Jul. 31, 2014 | RF Conducted |
| Power Sensor | Anritsu | MA2411B | 0917017 | 300MHz ~ 40GHz | Jan. 28, 2014 | RF Conducted |
| Power Meter | Anritsu | ML2495A | 0949003 | 300MHz ~ 40GHz | Jan. 28, 2014 | RF Conducted |
| RF Cable-2m | HUBER+SUHNER | SUCOFLEX_104 | SN 345675/4 | 30MHz ~ 26.5GHz | Dec. 02, 2013 | RF Conducted |
| BT Station | R&S | CBT | 100959 | N/A | Mar. 10, 2014 | RF Conducted |

Note: Calibration Interval of instruments listed above is one year.

| Instrument | Manufacturer | Model No. | Serial No. | Characteristics | Calibration Date | Remark |
|--------------------------|----------------|----------------|-------------|--------------------|--|-----------|
| 3m Semi Anechoic Chamber | SIDT FRANKONIA | SAC-3M | 03CH03-HY | 30MHz ~ 1GHz 3m | Nov. 30, 2013 Nov. 29, 2014 (Update) | Radiation |
| Amplifier | HP | 8447D | 2944A08033 | 10kHz ~ 1.3GHz | May 05, 2014 | Radiation |
| Amplifier | Agilent | 8449B | 3008A02120 | 1GHz ~ 26.5GHz | Sep. 01, 2014 | Radiation |
| Spectrum | R&S | FSP40 | 100004 | 9kHz ~ 40GHz | Mar. 27, 2014 | Radiation |
| Bilog Antenna | SCHAFFNER | CBL 6112D | 22237 | 30MHz ~ 1GHz | Sep. 20, 2014 | Radiation |
| Horn Antenna | ETS · LINDGREN | 3115 | 6741 | 1GHz ~ 18GHz | Jun. 11, 2014 | Radiation |
| Horn Antenna | SCHWARZBECK | BBHA9170 | BBHA9170154 | 15GHz ~ 40GHz | Jan. 10, 2014 | Radiation |
| RF Cable-R03m | Jye Bao | RG142 | CB021 | 9kHz ~ 1GHz | Nov. 16, 2013 | Radiation |
| RF Cable-high | SUHNER | SUCOFLEX 106 | 03CH03-HY | 1GHz ~ 40GHz | Dec. 11, 2013 | Radiation |
| Turn Table | EM Electronics | EM Electronics | 060615 | 0 ~ 360 degree | N/A | Radiation |
| Antenna Mast | MF | MF-7802 | MF780208179 | 1 ~ 4 m | N/A | Radiation |

Note: Calibration Interval of instruments listed above is one year.

| Instrument | Manufacturer | Model No. | Serial No. | Characteristics | Calibration Date | Remark |
|--------------|--------------|-----------|------------|-----------------|------------------|-----------|
| Loop Antenna | TESEQ | HLA 6120 | 31244 | 9kHz ~ 30MHz | Dec. 02, 2012 | Radiation |

Note: Calibration Interval of instruments listed above is two year.