

UHF BAND

WIRELESS MICROPHONE SYSTEM

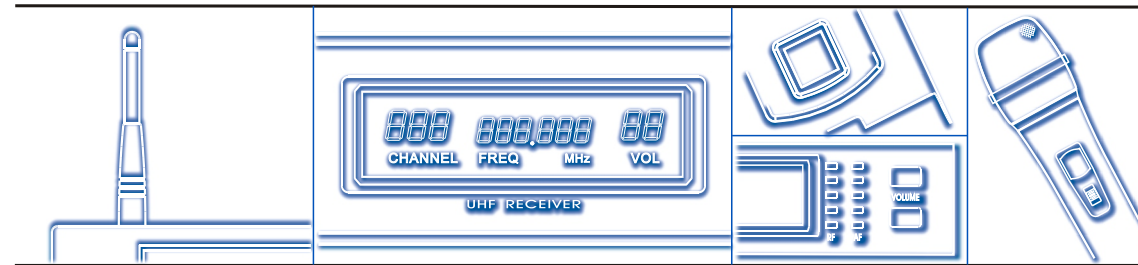

WIRELESS MICROPHONE SYSTEM

Table of Contents	Page
1. Introduction	1
2. Safety	1
3. Environment	1
4. Wireless Note	1
5. Product Description	2
5.1 Receiver	
5.1.1 True-diversity type	
5.1.2 Switching-diversity type	
5.2 Handheld Microphone	
5.3 Bodypack Transmitter	
6. Basic Connections	8
7. Setting Up	10
7.1 Connecting the receiver to power	
7.2 Connecting the receiver to an audio mixer or an amplifier	
7.3 Inserting batteries into the handheld / bodypack transmitter	
7.4 Setting up the handheld transmitter	
7.5 Setting up the bodypack transmitter	
8. Trouble-shooting	11
9. System Feature	12
10. System Specification	12

WIRELESS NOTE

FCC Statement

This device complies with part 15 of the FCC rules. Operation is subject to the following two conditions: (1) This device may not cause harmful interference and (2) This device must accept any interference received, including interference that may cause undesired operation.

Notice : The changes or modifications not expressly approved by the party responsible for compliance could void the user's authority to operate the equipment.

IMPORTANT NOTE: To comply with the FCC RF exposure compliance requirements, no change to the antenna or the device is permitted. Any change to the antenna or the device could result in the device exceeding the RF exposure requirements and void user's authority to operate the device.

1. Introduction

Thank you for purchasing our product. This wireless microphone system operates in UHF band frequency with synthesizer controlled. The system with 700 selectable frequencies via Phase Locked Loop (PLL) circuitry makes it easy to choose non-interfered channels. Please read this instruction manual carefully before operating the system. This manual covers the function and operation of the wireless microphone system.

2. Safety

- Do not spill liquid on the appliance and do not drop it on a hard concrete floor.
- Do not place the appliance near heat sources such as radiators, amplifier, or etc.
- Do not expose it to direct sunlight, extremely dust, excessive moisture, or vibration.
- Take out the battery from transmitter, if the appliance has been not used for a longer period. This will avoid the damage resulting from a defective leaking battery.

3. Environment

- Do not throw used batteries into a fire or garbage bin with domestic rubbish. Be sure to dispose of used batteries in accordance with local waste disposal rules.
- When disposing the equipment, remove the batteries, separate the case, circuit boards, and cables, and dispose of all components in accordance with local waste disposal rules.

4. Wireless Note

- Before setting up, make sure that the transmitter and receiver are tuned to the same frequency.
- Do not use two transmitters in the same frequency.
- When two or above transmitters are operated simultaneously, please arrange at least with 10-channel spaces between each channels.
- Use good quality batteries to avoid the damage resulting from a defective leaking battery.
- Push the volume button on the receiver to adjust receiver output level to match input level requirements of an audio mixer or an amplifier.
- To avoid interference, do not put the receiver too near metal object and avoid obstructions between transmitter and receiver.
- Avoid the interference from TV, radio, other wireless appliances and etc.

PRODUCT DESCRIPTION

5. Product Description**5.1 Receivers**

The receivers are used with our 700 selectable channels transmitters. The receiver operates in UHF band frequency with PLL synthesized control. Powered by 12V DC.

5.1.1 True-diversity type

Single channel, 1/2 rack

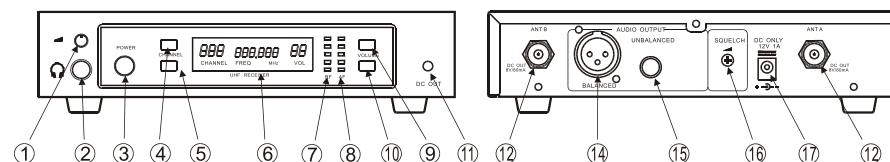

Single channel, full rack

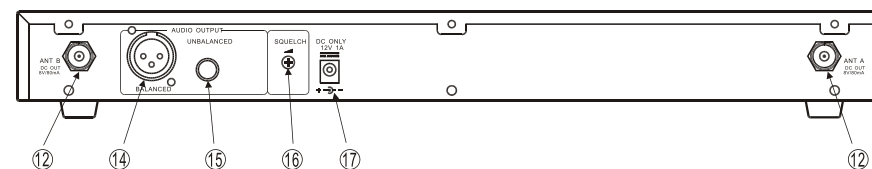
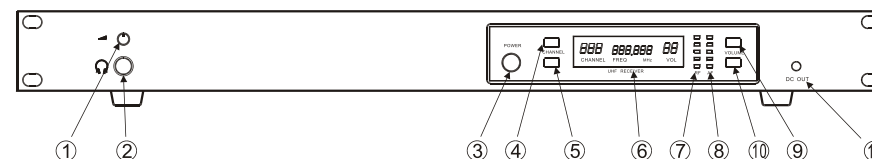

Dual channel, full rack

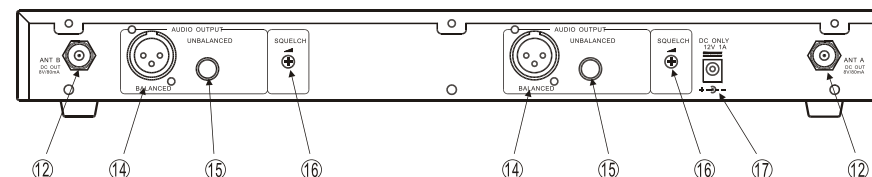
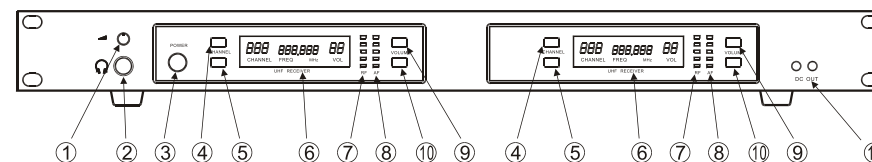

PRODUCT DESCRIPTION

PRODUCT DESCRIPTION

5.1.2 Switching-diversity type

Single channel, 1/2 rack, fixed antennas

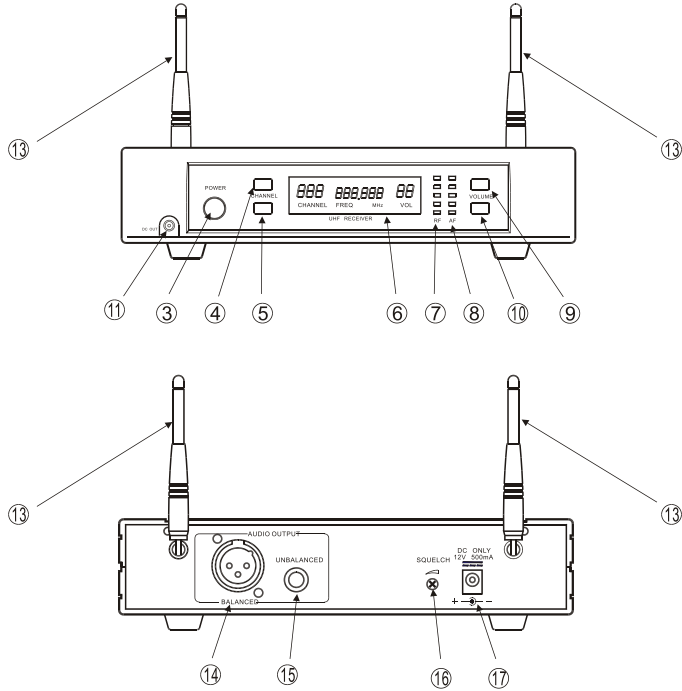

Single channel, 1/2 rack, detachable antennas

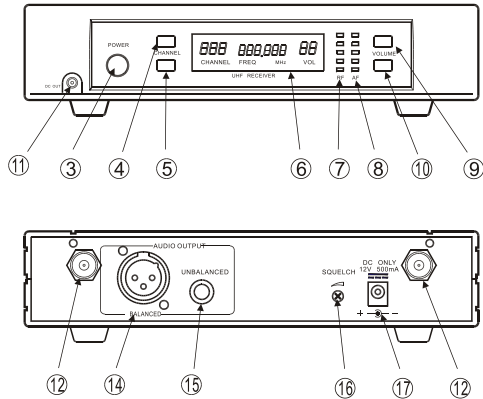

1. **Headphone Monitor Volume Control:** Rotate this knob to control headphone volume level.
2. **Headphone Input Connector:** Plug headphone into this 6.3 ϕ connector to monitor receiver audio.
3. **Power:** Pushes the receiver on and off.
4. **Channel + Button:** Press this button to change channel forward.
5. **Channel - Button:** Press this button to change channel backward.
6. **Programmable Display:** Displays channel number, frequency and volume level.
7. **RF Level Indicators:** Five LEDs per RF antenna channel glow to indicate RF signal strength. The more LEDs that glow, the stronger the received signal. If none of these LEDs glow, no signal is being received.
8. **AF Level Indicators:** Five LEDs glow to indicate audio signal strength. Green indicates normal operation. RED indicates approaching overload condition.
9. **Volume + Button:** Press this button to increase the receiver output level to match the input sensitivity of an audio mixer or an amplifier. .
10. **Volume - Button:** Press this button to decrease the receiver output level to match the input sensitivity of an audio mixer or an amplifier.
11. **DC Out:** Connect the supplied cable to the receiver and the microphone, and it takes around 10 hours to charge.
12. **Antenna Input Connector:** TNC-type connectors provide connection to the supplied antennas or to coaxial cable used with an antenna divider, antenna boosters or remote antennas.
13. **Antenna:** Fixed-length UHF antenna permanently mounted on rear panel.
14. **Balanced Output:** 3-pin XLR connector provides balanced low-impedance output
15. **Unbalanced Output:** 6.3 ϕ phone jack provides unbalanced low-impedance output
16. **Squelch:** The squelch adjusts the output level to suppress the noise. The higher squelch control, the lower the sensitivity of the receiver and decrease the service area of the system. Set the squelch to minimum before turning the receiver on.
17. **DC IN:** Input connector for the supplied AC adapter.