

FCC PART 74 TEST REPORT

for

Wireless Microphone System

Model No.: UF-16

FCC ID: JEBUF-16HE

of

Applicant: MASCOT ELECTRIC CO., LTD

**Address: No.85, Changxing 1st St., Rende Dist., Tainan City 71741,
Taiwan (R.O.C.)**

Tested and Prepared

by

Worldwide Testing Services (Taiwan) Co., Ltd.

FCC Registration No.: 930600

Industry Canada filed test laboratory Reg. No. IC 5679A-1, IC 5107A

A2LA Accredited No.: 2732.01



Report No.: W6M21409-14515-C-1

6F, NO. 58, LANE 188, RUEY-KUANG RD., NEIHU TAIPEI 114, TAIWAN, R.O.C.
TEL: 886-2-66068877 FAX: 886-2-66068879 E-mail: wts@wts-lab.com



Registration number: W6M21409-14515-C-1
FCC ID: JEBUF-16HE

TABLE OF CONTENTS

1	GENERAL INFORMATION.....	3
1.1	NOTES.....	3
1.2	TESTING LABORATORY	4
1.2.1	Location	4
1.2.2	Details of accreditation status	4
1.3	DETAILS OF APPROVAL HOLDER.....	5
1.4	APPLICATION DETAILS	5
1.5	GENERAL INFORMATION OF TEST ITEM	5
1.6	TEST STANDARDS.....	6
2	TECHNICAL TEST	7
2.1	SUMMARY OF TEST RESULTS	7
2.2	TEST ENVIRONMENT	7
2.3	TEST EQUIPMENT LIST	8
2.4	GENERAL TEST PROCEDURE	10
3	TEST RESULTS (ENCLOSURE)	11
4	RF POWER OUTPUT (CONDUCTED) , FCC 2.1046 (A) ; 74.861 (E)	12
4.1	TEST PROCEDURE.....	12
4.2	TEST RESULTS	12
5	RADIATED POWER.....	13
5.1	TEST PROCEDURE	13
5.2	TEST RESULTS	14
6	MODULATION DEVIATION , FCC 2.1047 (B) ; 74.861(E).....	26
6.1	TEST PROCEDURE.....	26
6.2	TEST RESULTS	26
7	AUDIO FREQUENCY RESPONSE , FCC 2.1047 (A).....	27
7.1	TEST PROCEDURE.....	27
7.2	TEST RESULTS	27
8	OCCUPIED BANDWIDTH/EMISSION MASK, FCC 2.1049 (C) ; 74.861 (E)(5)	28
8.1	TEST PROCEDURE.....	28
8.2	TEST RESULTS	28
8.3	LIMIT	28
9	SPURIOUS EMISSIONS AT ANTENNA TERMINALS FCC2.1051 ; 74.861 (E)	29
9.1	TEST PROCEDURE.....	29
9.2	TEST RESULTS	29
9.3	LIMIT	29



Worldwide Testing Services(Taiwan) Co., Ltd.

Registration number: W6M21409-14515-C-1

FCC ID: JEBUF-16HE

10	RADIATED SPURIOUS EMISSION , FCC 2.1053 ; 74.861 (E)	30
10.1	TEST PROCEDURE.....	30
10.2	TEST RESULTS	30
10.3	EXPLANATION OF TEST RESULT.....	78
10.4	LIMITS	78
11	LINE CONDUCTED EMISSION , FCC 15.207	79
11.1	TEST PROCEDURE.....	79
11.2	TEST RESULTS	79
12	FREQUENCY STABILITY VS. TEMPERATURE , FCC 2.1055 , 74.861 (E)	80
12.1	TEST PROCEDURE.....	80
12.2	TEST RESULTS	80
13	FREQUENCY STABILITY VS. VOLTAGE , FCC 2.1055 (D) ; 74.861 (E)	83
13.1	TEST PROCEDURE.....	83
13.2	TEST RESULTS	83
APPENDIX	84



Worldwide Testing Services(Taiwan) Co., Ltd.

Registration number: W6M21409-14515-C-1
FCC ID: JEBUF-16HE

1 General Information

1.1 Notes

The purpose of conformity testing is to increase the probability of adherence to the essential requirements or conformity specifications, as appropriate.

The complexity of the technical specifications, however, means that full and thorough testing is impractical for both technical and economic reasons.

Furthermore, there is no guarantee that a test sample which has passed all the relevant tests conforms to a specification.

Neither is there any guarantee that such a test sample will interwork with other genuinely open systems. The existence of the tests nevertheless provides the confidence that the test sample possesses the qualities as maintained and that its performance generally conforms to representative cases of communications equipment.

The test results of this test report relate exclusively to the item tested as specified in 1.5.

The test report may only be reproduced or published in full.

Reproduction or publication of extracts from the report requires the prior written approval of the Worldwide Testing Services (Taiwan) Co., Ltd.

Tester:

December 05, 2014 Mark Cheng 

Date WTS-Lab. Name Signature

Technical responsibility for area of testing:

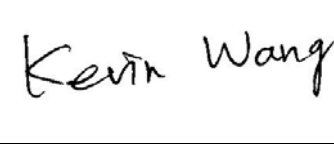
December 05, 2014 Kevin Wang 

Date WTS Name Signature



Worldwide Testing Services(Taiwan) Co., Ltd.

Registration number: W6M21409-14515-C-1
FCC ID: JEBUF-16HE

1.2 Testing laboratory

1.2.1 Location

OATS

No.5-1, Lishui, Shuang Sing Village,
Wanli Dist., New Taipei City 207,
Taiwan (R.O.C.)

3 meter semi-anechoic chamber

No.35, Aly. 21, Ln. 228, Ankang Rd., Neihu Dist., Taipei City 114, Taiwan (R.O.C.)

TEL:886-2-6613-0228

FAX:886-2-2791-5046

Company

Worldwide Testing Services(Taiwan) Co., Ltd.

6F, NO. 58, LANE 188, RUEY-KUANG RD.

NEIHU, TAIPEI 114, TAIWAN R.O.C.

Tel : 886-2-66068877

Fax : 886-2-66068879

1.2.2 Details of accreditation status

Accredited testing laboratory

A2LA accredited number: 2732.01

FCC filed test laboratory Reg. No. 930600

Industry Canada filed test laboratory Reg. No. IC 5679A-1, IC 5107A



Test location, where different from Worldwide Testing Services (Taiwan) Co., Ltd. :

Name: ./.

Accredited number: ./.

Street: ./.

Town: ./.

Country: ./.

Telephone: ./.

Fax: ./.

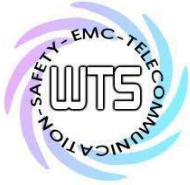

Worldwide Testing Services(Taiwan) Co., Ltd.

Registration number: W6M21409-14515-C-1

FCC ID: JEBUF-16HE

1.3 Details of approval holder

Name: MASCOT ELECTRIC CO., LTD
Street: No.85, Changxing 1st St., Rende Dist.,
Town: Tainan City 71741,
Country: Taiwan (R.O.C.)
Telephone: 886-6-2710171
Fax: 886-6-2710808

1.4 Application details

Date of receipt of test sample: September 30, 2014
Date of test: from October 01, 2014 to December 03, 2014

1.5 General information of Test item

Type of test item: Wireless Microphone System
Model Number: UF-16
Brand Name: MASCOT
Multi-listing model number: ./.
Photos: see Appendix

Technical data

Frequency band :

Frequency(MHz)	TV Band	Used Band
26.100-26.480	<input type="checkbox"/>	<input type="checkbox"/>
54.000-72.000	<input type="checkbox"/>	<input type="checkbox"/>
76.000-88.000	<input type="checkbox"/>	<input type="checkbox"/>
161.625-161.775	<input type="checkbox"/>	<input type="checkbox"/>
174.000-216.000	<input type="checkbox"/>	<input type="checkbox"/>
450.000-451.000	<input type="checkbox"/>	<input type="checkbox"/>
455.000-456.000	<input type="checkbox"/>	<input type="checkbox"/>
470.000-488.000	<input type="checkbox"/>	<input type="checkbox"/>
488.000-494.000	<input type="checkbox"/>	<input type="checkbox"/>
494.000-608.000	<input checked="" type="checkbox"/>	<input checked="" type="checkbox"/>
614.000-698.000	<input checked="" type="checkbox"/>	<input checked="" type="checkbox"/>
944.000-952.000	<input type="checkbox"/>	<input type="checkbox"/>

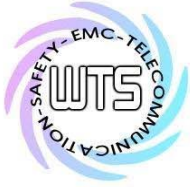

Worldwide Testing Services(Taiwan) Co., Ltd.

Registration number: W6M21409-14515-C-1
FCC ID: JEBUF-16HE

Frequency (ch 1): 520.125 MHz
Frequency (ch 2): 544.125 MHz
Frequency (ch 3): 607.225 MHz
Frequency (ch 4): 615.025 MHz
Frequency (ch 5): 629.825 MHz
Frequency (ch 6): 697.125 MHz

Antenna Type: Helical Antenna

Power supply: Battery 1.5 VDC *2

Operation modes: Simplex

Additional information: The EUT is the portable device. So the EUT was tested on three different axes. The EUT uses the frequency range that are more than 10 MHz, so that was tested on low, middle, and high three different frequencies.

Manufacturer: (if different from approval holder)

Name: ./.
Street: ./.
Town: ./.
Country: ./.

1.6 Test standards

Technical standard: FCC Part 74 Subpart H , section 74.861 (2013-10)

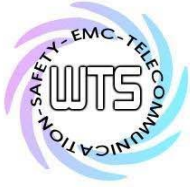

Registration number: W6M21409-14515-C-1

FCC ID: JEBUF-16HE

2 Technical test

2.1 Summary of test results

No deviations from the technical specification(s) were ascertained in the course of the tests performed.

or

The deviations as specified in 3 were ascertained in the course of the tests performed.

2.2 Test environment

Temperature: 23 °C

Relative humidity content: 20 ... 75 %

Air pressure: 86-103 KPa

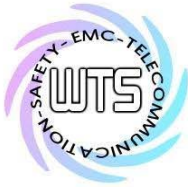

Worldwide Testing Services(Taiwan) Co., Ltd.

Registration number: W6M21409-14515-C-1

FCC ID: JEBUF-16HE

2.3 Test Equipment List

No.	Test equipment	Type	Serial No.	Manufacturer	Cal. Date	Next Cal. Date
ETSTW-CE 001	EMI TEST RECEIVER	ESHS10	842121/013	R&S	2014/9/2	2015/9/1
ETSTW-CE 003	AC POWER SOURCE	APS-9102	D161137	GW	Function Test	
ETSTW-CE 008	HF-EICHLLEITUNG RF STEP ATTENUATOR 139dB DPSP	334.6010.02	844581/024	R&S	Function Test	
ETSTW-CE 009	TEMP.&HUMIDITY CHAMBER	GTH-225-40-1P-U	MAA0305-009	GIANT FORCE	2014/7/8	2015/7/7
ETSTW-CE 016	TWO-LINE V-NETWORK	ENV216	100050	R&S	2014/10/13	2015/10/12
ETSTW-RE 004	EMI TEST RECEIVER	ESI 40	832427/004	R&S	2014/9/2	2015/9/1
ETSTW-RE 005	EMI TEST RECEIVER	ESVS10	843207/020	R&S	2014/9/2	2015/9/1
ETSTW-RE 012	TUNABLE BANDREJECT FILTER	D.C 0309	146	K&L	Function Test	
ETSTW-RE 013	TUNABLE BANDREJECT FILTER	D.C 0336	397	K&L	Function Test	
ETSTW-RE 018	MICROWAVE HORN ANTENNA	AT4560	27212	AR	2014/10/15	2015/10/14
ETSTW-RE 027	Passive Loop Antenna	6512	00034563	ETS-Lindgren	2014/7/01	2015/6/30
ETSTW-RE 030	Double-Ridged Guide Horn Antenna	3117	00035224	ETS-Lindgren	2014/2/25	2015/2/24
ETSTW-RE 045	ESA-E SERIES SPECTRUM ANALYZER	E4404B	MY45111242	Agilent	Pre-test Use	
ETSTW-RE 049	TRILOG Super Broadband test Antenna	VULB 9160	9160-3185	Schwarzbeck	2014/2/18	2015/2/17
ETSTW-RE 050	Attenuator 10dB	50HF-010-1	None	JFW	2014/3/3	2015/3/2
ETSTW-RE 051	Attenuator 6dB	50HF-006-1	None	JFW	2014/3/3	2015/3/2
ETSTW-RE 053	Attenuator 3dB	50HF-003-1	None	JFW	2014/3/3	2015/3/2
ETSTW-RE 055	SPECTRUM ANALYZER	FSU 26	200074	R&S	2014/6/05	2015/6/04
ETSTW-RE 060	Attenuator 30dB	5015-30	F651012z-01	ATM	2014/3/3	2015/3/2
ETSTW-RE 062	Amplifier Module	CHC 2	None	KMIC	2014/11/26	2015/11/25
ETSTW-RE 064	Bluetooth Test Set	MT8852B-042	6K00005709	Anritsu	Function Test	
ETSTW-RE 069	Double-Ridged Guide Horn Antenna	3117	00069377	ETS-Lindgren	Function Test	
ETSTW-RE 072	CELL SITE TEST SET	8921A	3339A00375	HP	2014/10/9	2015/10/8
ETSTW-RE 088	SOLID STATE AMPLIFIER	KMA180265A01	99057	KMIC	2014/9/22	2015/9/21
ETSTW-RE 099	DC Block	50DB-007-1	None	JFW	2014/3/3	2015/3/2
ETSTW-RE 106	Humidity Temperature Meter	TES-1366	091011113	TES	2014/11/7	2015/11/6
ETSTW-RE 111	TRILOG Super Broadband test Antenna	VULB 9160	9160-3309	Schwarz beck	2013/12/27	2014/12/26
ETSTW-RE 112	AC POWER SOURCE	TFC-1005	None	T-Power	Function test	
ETSTW-RE 115	2.4GHz Notch Filter	N0124411	473874	MICROWAVE CIRCUITS	2014/1/10	2015/1/09
ETSTW-RE 120	RF Player	MP9200	MP9210-111022	ADIVIC	Function test	
ETSTW-RE 122	SIGNAL GENERATOR	SMF100A	102149	R&S	2014/6/11	2015/6/10
ETSTW-RE 125	5GHz Notch filter	5NSL11-5200/E221.3-O/O	1	K&L Microwave	2014/8/12	2015/8/11

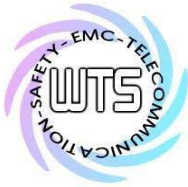

Worldwide Testing Services(Taiwan) Co., Ltd.

Registration number: W6M21409-14515-C-1

FCC ID: JEBUF-16HE

ETSTW-RE 126	5GHz Notch filter	5NSL11-5800/E221.3-O/O	1	K&L Microwave	2014/8/12	2015/8/11
ETSTW-RE 127	RF Switch Box	RFS-01	None	WTS	2014/3/3	2015/3/2
ETSTW-RE 128	5.3GHz Notch filter	N0153001	SN487233	Microwave Circuits	2014/8/12	2015/8/11
ETSTW-RE 129	5.5GHz Notch filter	N0555984	SN487234	Microwave Circuits	2014/8/12	2015/8/11
ETSTW-RE 130	Handheld RF Spectrum Analyzer	N9340A	CN0147000204	Agilent	Pre-test Use	
ETSTW-GSM 002	Universal Radio Communication Tester	CMU 200	109439	R&S	2014/10/20	2015/10/19
ETSTW-GSM 019	Band Reject Filter	WRCTF824/849-822/851-40 /12+9SS	3	WI	2014/1/10	2015/1/09
ETSTW-GSM 020	Band Reject Filter	WRCD1747/1748-1743/1752-32/5SS	1	WI	2014/1/10	2015/1/09
ETSTW-GSM 021	Band Reject Filter	WRCD1879.5/1880.5-1875.5/1884.5-32/5SS	3	WI	2014/1/10	2015/1/09
ETSTW-GSM 022	Band Reject Filter	WRCT901.9/903.1-904.25-50/8SS	1	WI	2014/1/10	2015/1/09
ETSTW-GSM 023	Power Divider	4901.19.A	None	SUHNER	2014/9/17	2015/9/16
ETSTW-Cable 010	BNC Cable	5 M BNC Cable	None	JYE BAO CO.,LTD.	2014/10/15	2015/10/14
ETSTW-Cable 011	BNC Cable	BNC Cable 1	None	JYE BAO CO.,LTD.	Pre-test Use NCR	
ETSTW-Cable 012	N TYPE To SMA Cable	Cable 012	None	JYE BAO CO.,LTD.	2014/10/15	2015/10/14
ETSTW-Cable 016	BNC Cable	Switch Box	B Cable 1	Schwarz beck	2014/2/27	2015/2/26
ETSTW-Cable 017	BNC Cable	X Cable	B Cable 2	Schwarz beck	2014/2/27	2015/2/26
ETSTW-Cable 018	BNC Cable	Y Cable	B Cable 3	Schwarz beck	2014/2/27	2015/2/26
ETSTW-Cable 019	BNC Cable	Z Cable	B Cable 4	Schwarz beck	2014/2/27	2015/2/26
ETSTW-Cable 022	N TYPE Cable	5006	0002	JYE BAO CO.,LTD.	2014/2/19	2015/2/18
ETSTW-Cable 026	Microwave Cable	SUCOFLEX 104	279075	HUBER+SUHNER	2014/3/3	2015/3/2
ETSTW-Cable 027	Microwave Cable	SUCOFLEX 104	279083	HUBER+SUHNER	2014/3/3	2015/3/2
ETSTW-Cable 028	Microwave Cable	FA147A0015M2020	30064-2	UTIFLEX	2014/9/22	2015/9/21
ETSTW-Cable 029	Microwave Cable	FA147A0015M2020	30064-3	UTIFLEX	2014/9/22	2015/9/21
ETSTW-Cable 030	Microwave Cable	SUCOFLEX 104 (S_Cable 9)	279067	HUBER+SUHNER	2014/3/3	2015/3/2
ETSTW-Cable 031	Microwave Cable	SUCOFLEX 104 (S_Cable 10)	238092	HUBER+SUHNER	2014/11/26	2015/11/25
ETSTW-Cable 043	Microwave Cable	SUCOFLEX 104	317576	HUBER+SUHNER	2014/11/26	2015/11/25
ETSTW-Cable 047	Microwave Cable	SUCOFLEX 104	325518	HUBER+SUHNER	2014/11/26	2015/11/25
ETSTW-Cable 053	N TYPE To SMA Cable	RG142	None	JYE BAO CO.,LTD.	2014/2/19	2015/2/18
ETSTW-Cable 058	Microwave Cable	SUCOFLEX 104	none	HUBER+SUHNER	2014/2/19	2015/2/18
WTSTW-SW 002	EMI TEST SOFTWARE	EZ EMC	None	Farad	Version ETS-03A1	



Registration number: W6M21409-14515-C-1
FCC ID: JEBUF-16HE

2.4 General Test Procedure

POWER LINE CONDUCTED INTERFERENCE: The procedure used was ANSI STANDARD C63.4-2014 5.2 using a 50 μ H LISN (if necessary). Both lines were observed. The bandwidth of the spectrum analyzer was 10 kHz with an appropriate sweep speed.

RADIATION INTERFERENCE: The test procedure used was according to ANSI STANDARD C63.4-2014 6.4 employing a spectrum analyzer. For investigated frequency is equal to or below 1GHz, the RBW and VBW of the spectrum analyzer was 100 kHz and 100 kHz respectively with an appropriate sweep speed. For investigated frequency is above 1GHz, both of RBW and VBW of the spectrum analyzer were 1 MHz with an appropriate sweep speed. The analyzer was calibrated in dB above a microvolt at the output of the antenna. The ambient temperature of the UUT was 23°C with a humidity of 40 %.

The table used for radiated measurements is capable of continuous rotation. The spectrum was scanned from 30 MHz to the frequency specified as follows:

- (1) If the intentional radiator operates below 10 GHz: to the tenth harmonic of the highest fundamental frequency or to 40 GHz, whichever is lower.
- (2) If the intentional radiator operates at or above 10 GHz and below 30 GHz: to the fifth harmonic of the highest fundamental frequency or to 100 GHz, whichever is lower.
- (3) If the intentional radiator operates at or above 30 GHz: to the fifth harmonic of the highest fundamental frequency or to 200 GHz, whichever is lower, unless specified otherwise elsewhere in the rules.
- (4) If the intentional radiator contains a digital device, regardless of whether this digital device controls the functions of the intentional radiator or the digital device is used for additional control or function purposes other than to enable the operation of the intentional radiator, the frequency range shall be investigated up to the range specified in paragraphs (a)(1)-(a)(3) of this section or the range applicable to the digital device, as shown in paragraph (b)(1) of this Section, whichever is the higher frequency range of investigation.

For hand-held devices, a exploratory test was performed with three (3) orthogonal planes to determine the highest emissions.

Measurements were made by at the registered open field test site located at The Registration Number:

When an emission was found, the table was rotated to produce the maximum signal strength. At this point, the antenna was raised and lowered from 1m to 4m. The antenna was placed in both the horizontal and vertical planes.

ANSI STANDARD C63.4-2014 10.2.7: Any measurements that utilize special test software shall be indicated and referenced in the test report. During testing, test software 'EZ EMC' was used for setting up different operation modes.



Worldwide Testing Services(Taiwan) Co., Ltd.

Registration number: W6M21409-14515-C-1
 FCC ID: JEBUF-16HE

3 Test results (enclosure)

Test case	Para. Number	Required	Test passed	Test failed
RF Power Output	2.1046 (a); 74.861 (e)(1)	<input checked="" type="checkbox"/>	<input checked="" type="checkbox"/>	<input type="checkbox"/>
Modulation Deviation	2.1047 (b); 74.861 (e)(2)	<input checked="" type="checkbox"/>	<input checked="" type="checkbox"/>	<input type="checkbox"/>
Audio Frequency Response	2.1047 (a)	<input checked="" type="checkbox"/>	<input checked="" type="checkbox"/>	<input type="checkbox"/>
Occupied Bandwidth / Emission Mask	2.1049 (c)(1); 74.861 (e)(5)	<input checked="" type="checkbox"/>	<input checked="" type="checkbox"/>	<input type="checkbox"/>
Spurious Emissions at Antenna Terminals	2.1051 74.861(e)(6)	<input type="checkbox"/>	<input type="checkbox"/>	<input type="checkbox"/>
Radiated Spurious Emission	2.1053 74.861(e)(6)	<input checked="" type="checkbox"/>	<input checked="" type="checkbox"/>	<input type="checkbox"/>
Line Conducted Emissions	15.207	<input type="checkbox"/>	<input type="checkbox"/>	<input type="checkbox"/>
Frequency Stability vs. Temperature	2.1055 (b); 74.861(e)(4)	<input checked="" type="checkbox"/>	<input checked="" type="checkbox"/>	<input type="checkbox"/>
Frequency Stability vs. Voltage	2.1055 (a)(1); 74.861 (e)(4)	<input checked="" type="checkbox"/>	<input checked="" type="checkbox"/>	<input type="checkbox"/>

The following is intentionally left blank.



Registration number: W6M21409-14515-C-1
 FCC ID: JEBUF-16HE

4 RF Power Output (conducted) , FCC 2.1046 (a) ; 74.861 (e)

4.1 Test procedure

This transmitter output was connected to a calibrated coaxial attenuator, the other end of which was connected to a spectrum analyzer. Transmitter output was derived with the spectrum analyzer in dBm. The power output at the transmitter antenna port was determined by assign the value of the attenuator to the spectrum analyzer reading.

An HP power meter was also used to measure the RF power.

Tests were performed with an un-modulated carrier at three frequencies (low , middle and high channels) and on all power levels , which can be set-up on the transmitters.

4.2 Test Results

Frequency Channel	Peak Output Power (dBm)
520.125 MHz	--
544.125 MHz	--
607.225 MHz	--
615.025 MHz	--
629.825 MHz	--
697.125 MHz	--

Limits:

LPAS operating in TV bands	
Frequency [MHz]	Conducted output power [mW]
54 – 72 76 – 88 174 - 216	50 (17 dBm)
470 – 608 614 - 698	250 (24 dBm)

LPAS operating in other than TV bands	
Conducted power [W]	1

Test equipment used: ETSTW-RE 055, ETSTW-RE 050

Explanation :This test is not required.



Registration number: W6M21409-14515-C-1
FCC ID: JEBUF-16HE

5 Radiated Power

5.1 Test Procedure

The EUT was positioned on a non-conductive turntable, 0.8m above the ground on an open test site. The radiated emission at the fundamental frequency was measured at 3m distance with a test antenna and spectrum analyzer.

Worst case emission was recorded with the rotation of the turntable and the raising and lowering of the test antenna.

Substitution RF power Measurement at WTS Taiwan

General :

The applied substitution method follows ANSI/TIA/EIA-603, ANSI/TIA/EIA-102.CAAA or the appropriate ETSI rules respectively.

The actual signal generated by the EUT can be determined by means of a substitution measurement in which a known signal source replaces the device to be measured.

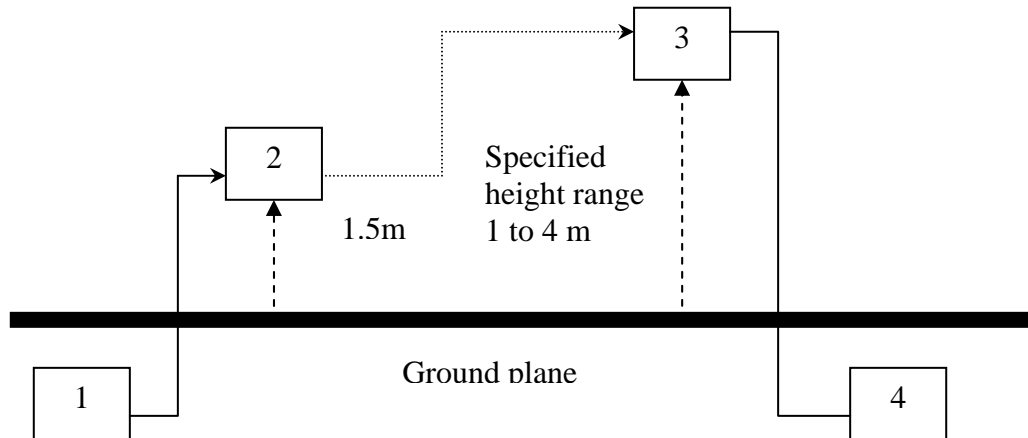

- 1) Signal generator ;
- 2) Substitution antenna ;
- 3) Test antenna ;
- 4) Spectrum analyzer or selective voltmeter.

The substitution antenna replaces the transmitter antenna at the same position and in vertical polarization. The frequency of the signal generator shall be adjusted to the measurement frequency.

The test antenna shall be raised or lowered, if necessary, to ensure that the maximum signal is still received. The input signal to the substitution antenna shall be adjusted in level until an equal or a known related level to that detected from the transmitter is obtained in the measurement receiver.

If a fully anechoic chamber is used as test site in order to provide free space conditions there is no need to change the height of the antenna.

The measurement will be repeated in horizontal position.

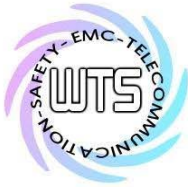

Registration number: W6M21409-14515-C-1
 FCC ID: JEBUF-16HE

Calibration :

In order to make this kind of measurement more effective and to avoid subjective measurement faults ETS has installed automatic computer controlled measurement procedures.

With the above described substitution method a test site is calibrated over the full frequency range which is used in suitable frequency steps. For a certain power level on the substitution antenna the received power over the whole frequency range is documented. All necessary antenna gains, cable losses, filter losses and amplifications of preamplifiers are taken in consideration. The summary of this calibration measurement performs a transducer factor that is related to the considered test site and a certain measurement distance. Differences of the radiated power levels of different test samples are determined by internal attenuation of measurement receiver . The proper function of such test site will be maintained by short term plausibility checks and periodical re-calibration.

Testing :

Now the test sample will be putted on the table at the defined position and the radiated power will be receiver and documented by the measurement receiver.

On test sites with ground plane the measurement antenna will be lowered and raised to maximum values at significant frequencies.

For peak power measurements the sample is turned by the turntable over 360 degree in order to find the direction with the maximum radiation or to document the max reading with the MAXHOLD function during the rotation.

5.2 Test results

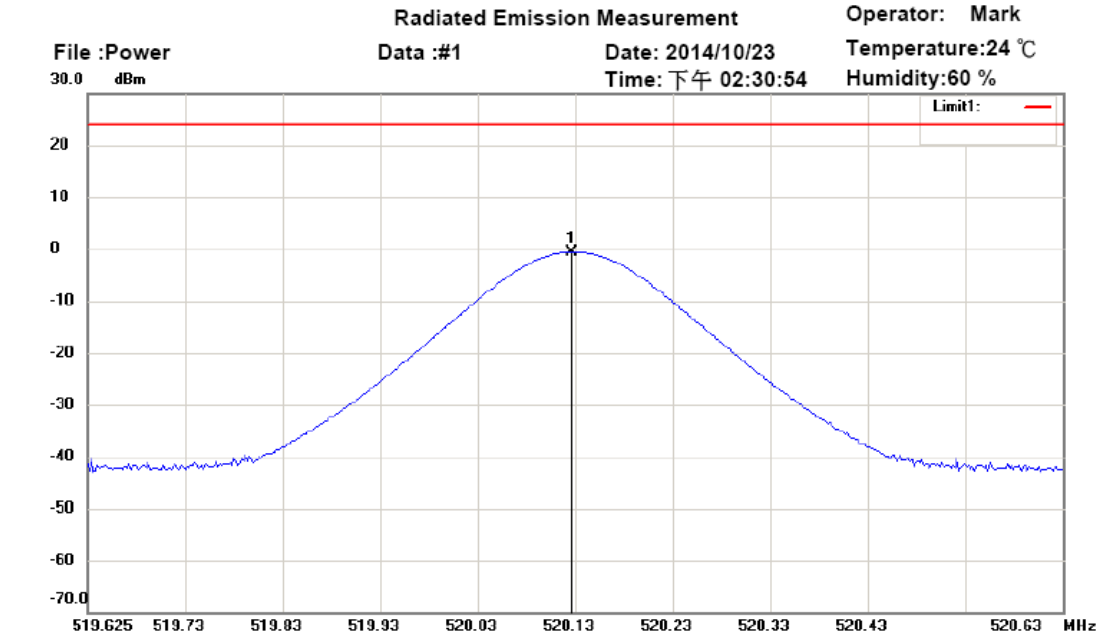

Site : Chamber

Condition : FCC 74.861 power(470-608 and 614-806)

EUT : W6M21409-14515

M/N: UF-16

Test Mode : 520.125MHz

Note :

Polarization: *Horizontal*

Power : 3V d.c.

Distance: 3m

Mk.	Frequency (MHz)	Reading (dBm)	Detector	Corr. factor (dB)	Result (dBm)	Limit (dBm)	Ant.Pos (cm)	Tab.Pos (deg.)	Margin (dB)	Comment
*	520.1220	-27.40	peak	26.84	-0.56	24.00	150	50	-24.56	



Worldwide Testing Services(Taiwan) Co., Ltd.

Registration number: W6M21409-14515-C-1
 FCC ID: JEBUF-16HE

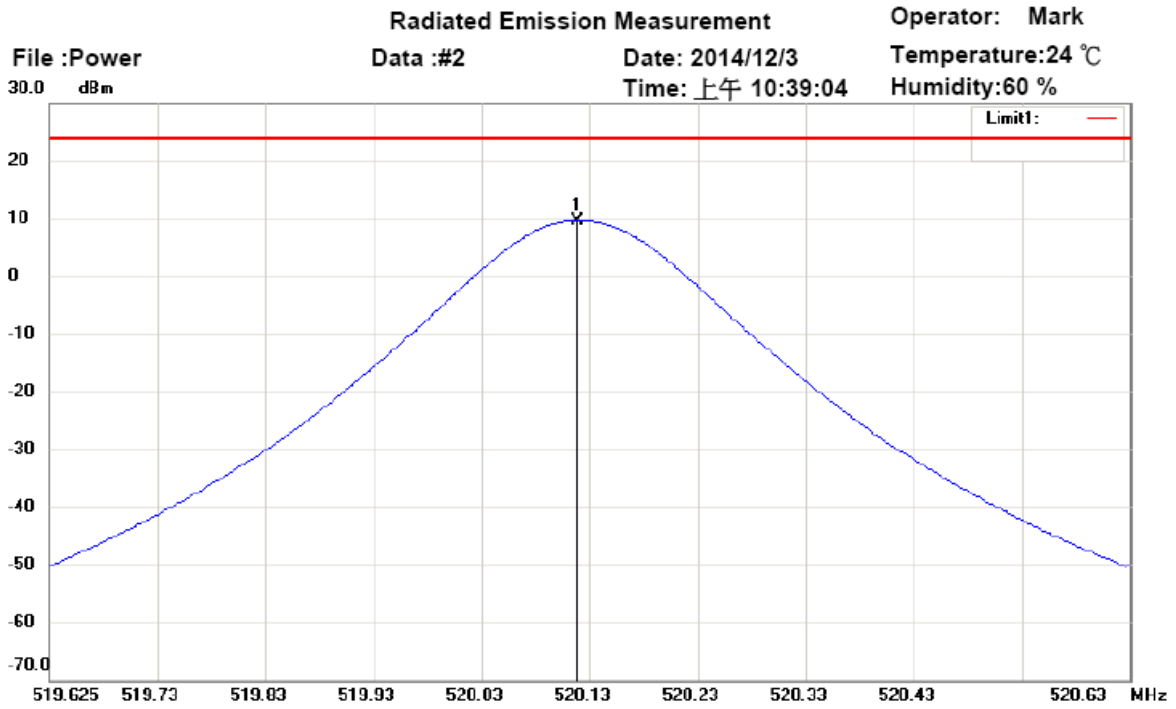

Site : Chamber

Condition : FCC 74.861 power(470-608 and 614-806)

EUT : W6M21409-14515

M/N: UF-16

Test Mode : 520.125MHz

Note :

Polarization: **Vertical**

Power : 3V d.c.

Distance: 3m

Mk.	Frequency (MHz)	Reading (dBm)	Detector	Corr. factor (dB)	Result (dBm)	Limit (dBm)	Ant.Pos (cm)	Tab.Pos (deg.)	Margin (dB)	Comment
*	520.1140	-19.96	peak	29.66	9.70	24.00	150	140	-14.30	



Worldwide Testing Services(Taiwan) Co., Ltd.

Registration number: W6M21409-14515-C-1
 FCC ID: JEBUF-16HE

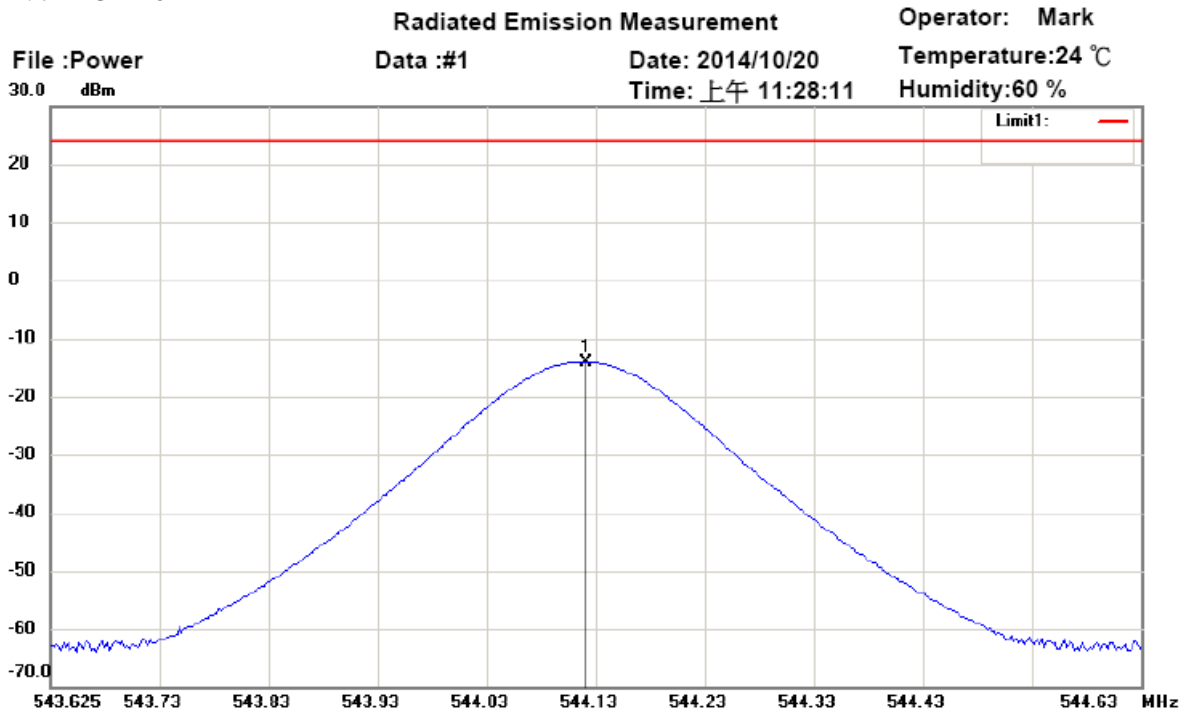

Site : Chamber

Condition : FCC 74.861 power(470-608 and 614-698)

EUT : W6M21409-14515

M/N: UF-16

Test Mode : 544.125MHz

Note :

Polarization: *Horizontal*

Power : 3V d.c.

Distance: 3m

Mk.	Frequency (MHz)	Reading (dBm)	Detector	Corr. factor (dB)	Result (dBm)	Limit (dBm)	Ant.Pos (cm)	Tab.Pos (deg.)	Margin (dB)	Comment
*	544.1160	-40.64	peak	26.58	-14.06	24.00	150	180	-38.06	



Worldwide Testing Services(Taiwan) Co., Ltd.

Registration number: W6M21409-14515-C-1
 FCC ID: JEBUF-16HE

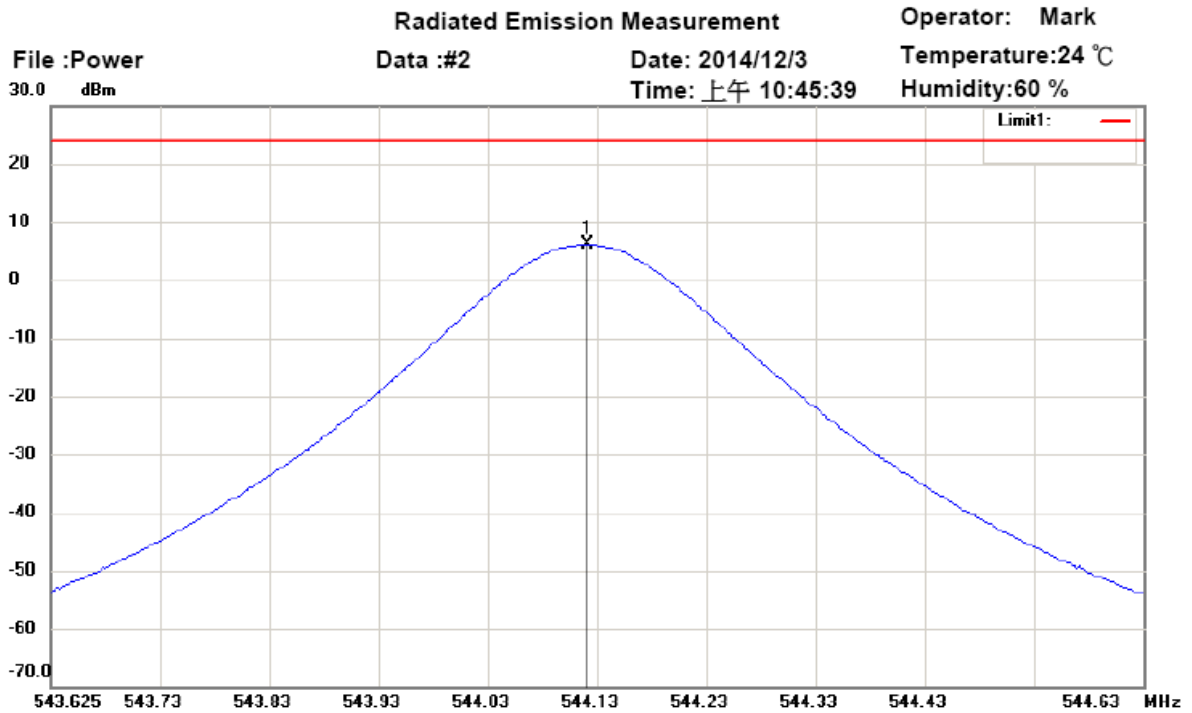

Site : Chamber
 Condition : FCC 74.861 power(470-608 and 614-806) Polarization: **Vertical**
 EUT : W6M21409-14515 Power : 3V d.c.
 M/N: UF-16 Distance: 3m
 Test Mode : 544.125MHz
 Note :

Mk.	Frequency (MHz)	Reading (dBm)	Detector	Corr. factor (dB)	Result (dBm)	Limit (dBm)	Ant.Pos (cm)	Tab.Pos (deg.)	Margin (dB)	Comment
*	544.1160	-23.38	peak	29.44	6.06	24.00	150	70	-17.94	



Worldwide Testing Services(Taiwan) Co., Ltd.

Registration number: W6M21409-14515-C-1
 FCC ID: JEBUF-16HE

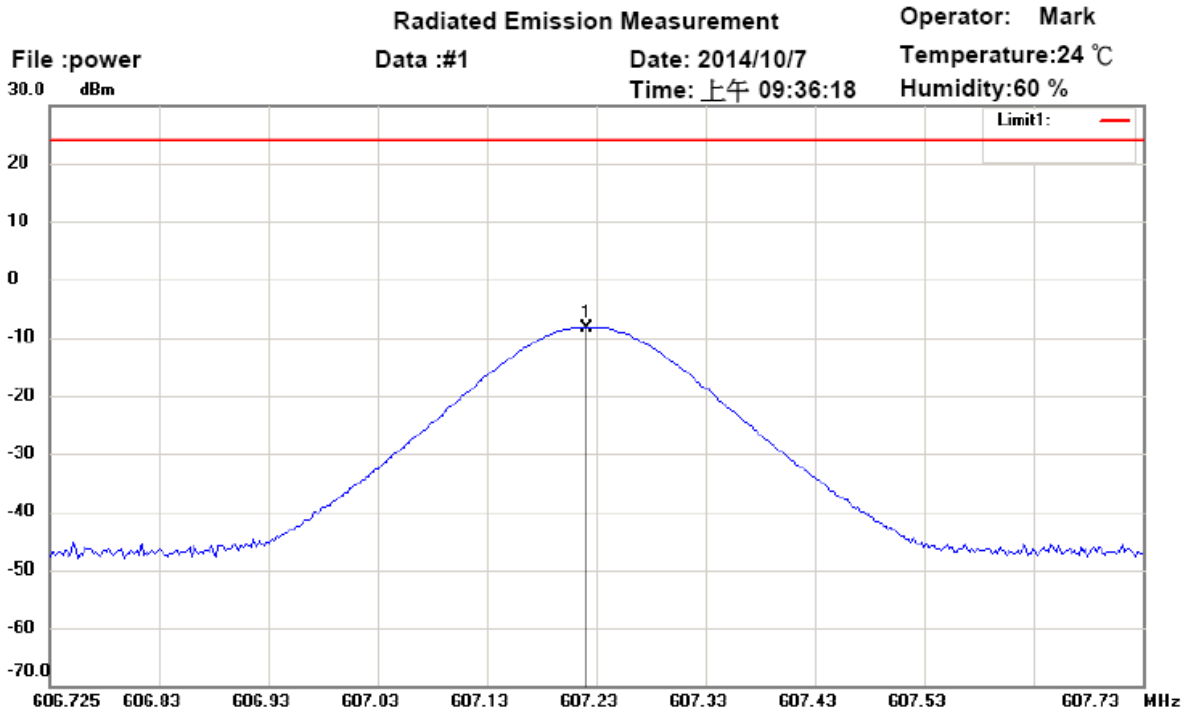

Site : Chamber
 Condition : FCC 74.861 power(470-608 and 614-698)
 EUT : W6M21409-14515
 M/N: UF-16
 Test Mode : 607.225MHz

Polarization: *Horizontal*
 Power : 3V d.c.
 Distance: 3m

Note :

Mk.	Frequency (MHz)	Reading (dBm)	Detector	Corr. factor (dB)	Result (dBm)	Limit (dBm)	Ant.Pos (cm)	Tab.Pos (deg.)	Margin (dB)	Comment
*	607.2160	-39.97	peak	31.71	-8.26	24.00	150	20	-32.26	



Worldwide Testing Services(Taiwan) Co., Ltd.

Registration number: W6M21409-14515-C-1
 FCC ID: JEBUF-16HE

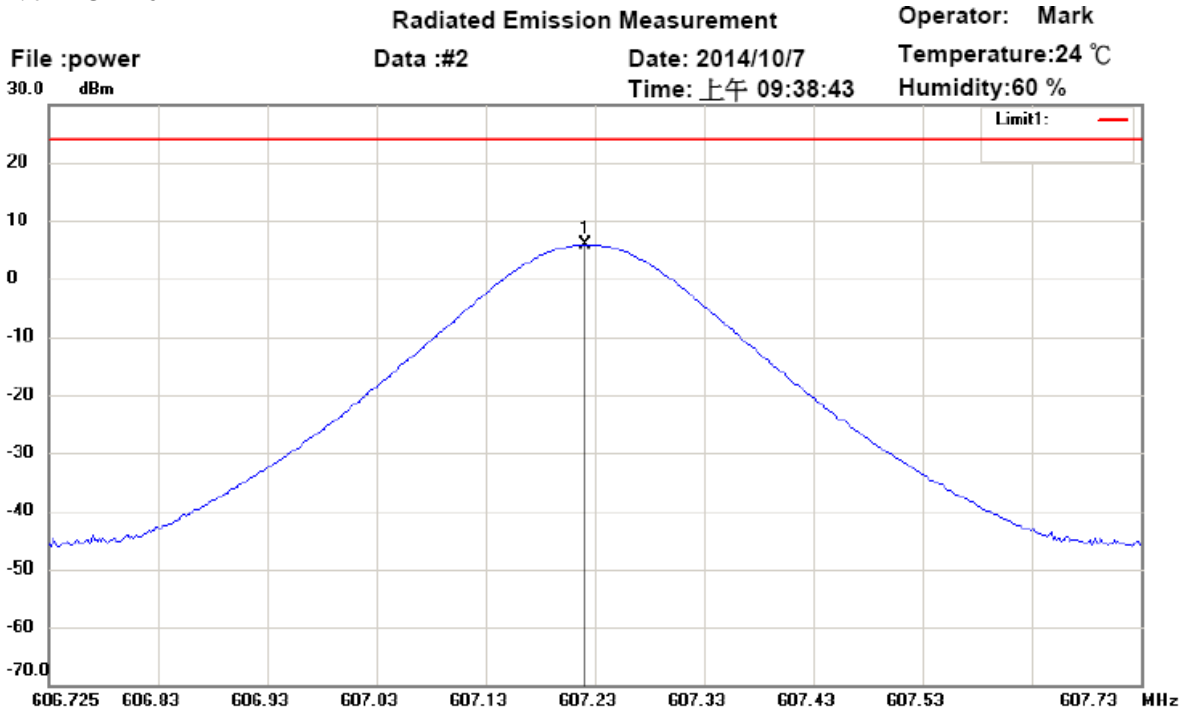

Site : Chamber

Condition : FCC 74.861 power(470-608 and 614-698)

EUT : W6M21409-14515

M/N: UF-16

Test Mode : 607.225MHz

Note :

Polarization: **Vertical**

Power : 3V d.c.

Distance: 3m

Mk.	Frequency (MHz)	Reading (dBm)	Detector	Corr. factor (dB)	Result (dBm)	Limit (dBm)	Ant.Pos (cm)	Tab.Pos (deg.)	Margin (dB)	Comment
*	607.2160	-25.94	peak	31.80	5.86	24.00	150	170	-18.14	



Worldwide Testing Services(Taiwan) Co., Ltd.

Registration number: W6M21409-14515-C-1
 FCC ID: JEBUF-16HE

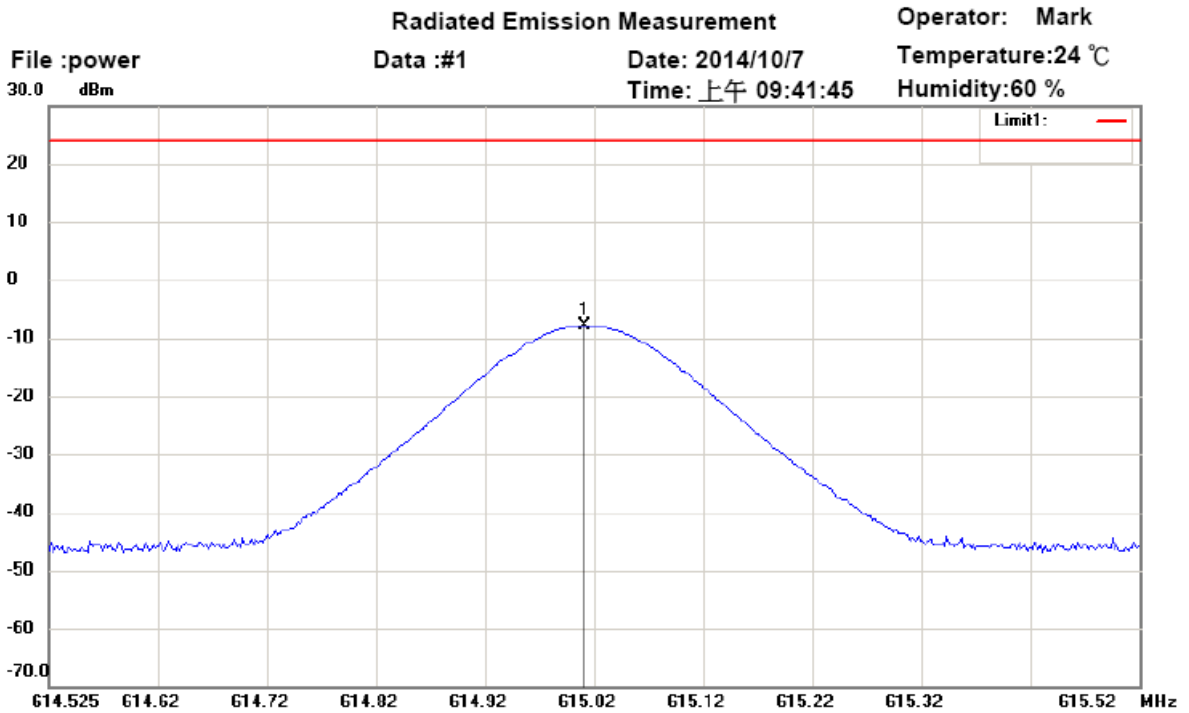

Site : Chamber
 Condition : FCC 74.861 power(470-608 and 614-698) Polarization: *Horizontal*
 EUT : W6M21409-14515 Power : 3V d.c.
 M/N: UF-16 Distance: 3m
 Test Mode : 615.025MHz
 Note :

Mk.	Frequency (MHz)	Reading (dBm)	Detector	Corr. factor (dB)	Result (dBm)	Limit (dBm)	Ant.Pos (cm)	Tab.Pos (deg.)	Margin (dB)	Comment
*	615.0160	-40.27	peak	32.32	-7.95	24.00	150	50	-31.95	



Worldwide Testing Services(Taiwan) Co., Ltd.

Registration number: W6M21409-14515-C-1
 FCC ID: JEBUF-16HE

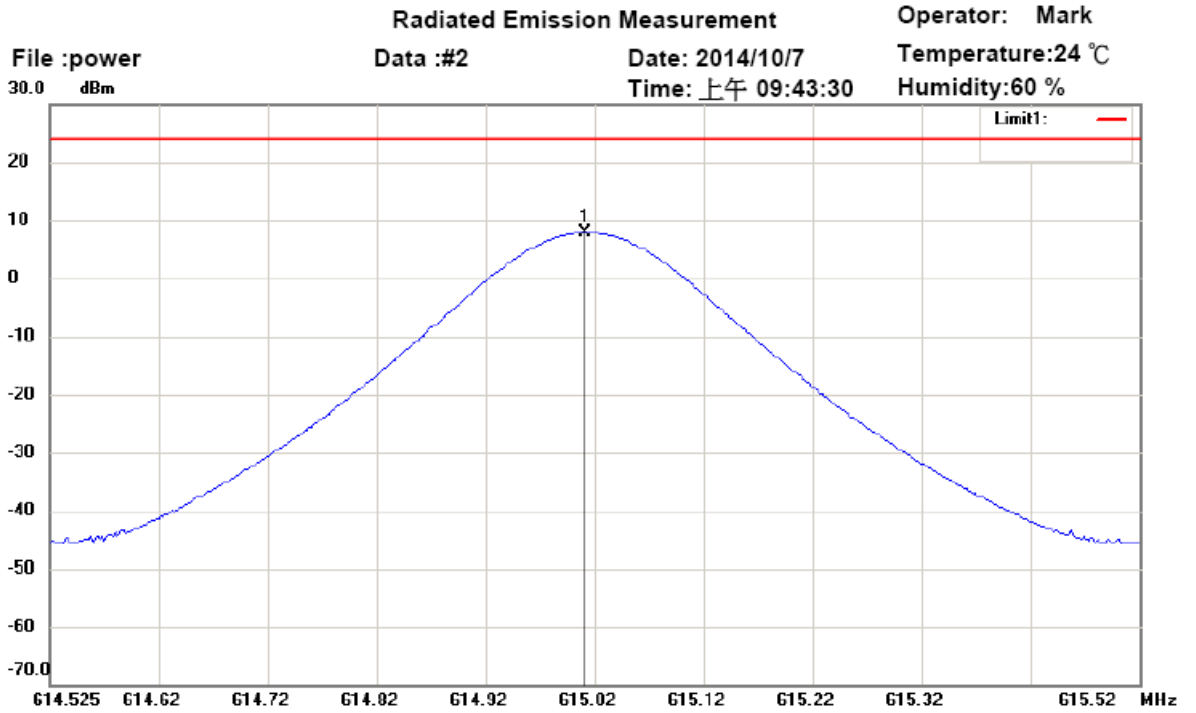

Site : Chamber
 Condition : FCC 74.861 power(470-608 and 614-698) Polarization: **Vertical**
 EUT : W6M21409-14515 Power : 3V d.c.
 M/N: UF-16 Distance: 3m
 Test Mode : 615.025MHz
 Note :

Mk.	Frequency (MHz)	Reading (dBm)	Detector	Corr. factor (dB)	Result (dBm)	Limit (dBm)	Ant.Pos (cm)	Tab.Pos (deg.)	Margin (dB)	Comment
*	615.0160	-23.99	peak	31.84	7.85	24.00	150	100	-16.15	



Worldwide Testing Services(Taiwan) Co., Ltd.

Registration number: W6M21409-14515-C-1
 FCC ID: JEBUF-16HE

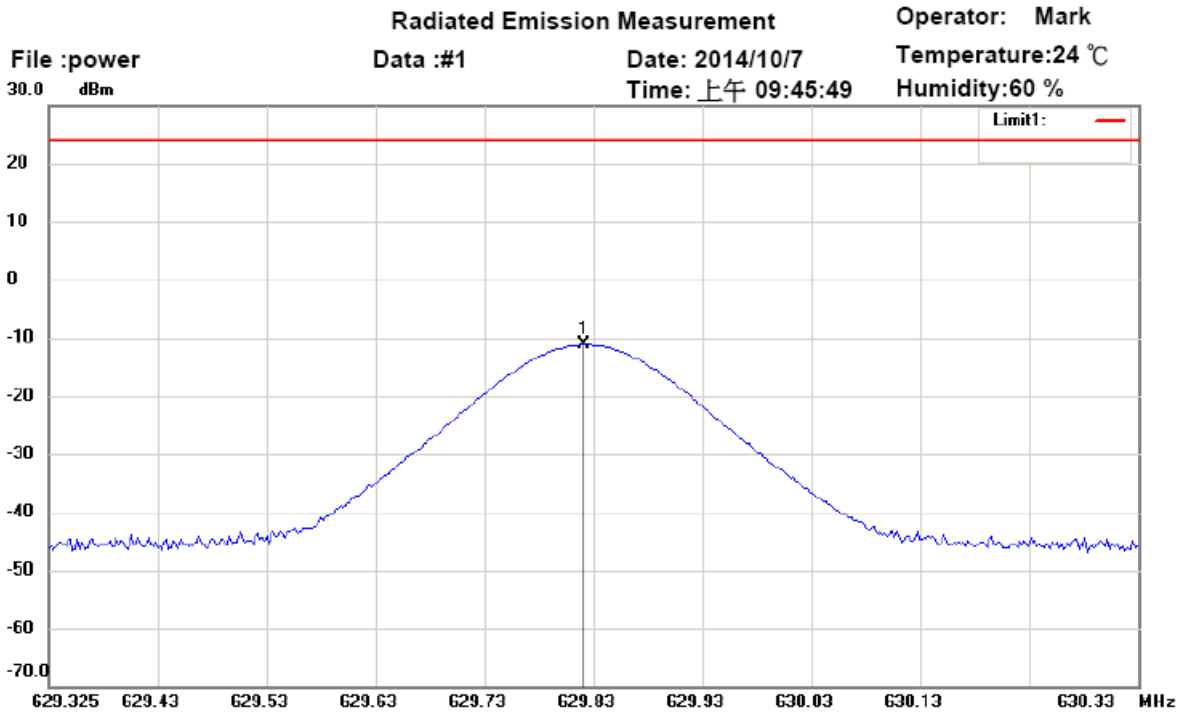

Site : Chamber
 Condition : FCC 74.861 power(470-608 and 614-698)
 EUT : W6M21409-14515
 M/N: UF-16
 Test Mode : 629.825MHz

Polarization: *Horizontal*
 Power : 3V d.c.
 Distance: 3m

Note :

Mk.	Frequency (MHz)	Reading (dBm)	Detector	Corr. factor (dB)	Result (dBm)	Limit (dBm)	Ant.Pos (cm)	Tab.Pos (deg.)	Margin (dB)	Comment
*	629.8160	-44.71	peak	33.48	-11.23	24.00	150	20	-35.23	



Worldwide Testing Services(Taiwan) Co., Ltd.

Registration number: W6M21409-14515-C-1
 FCC ID: JEBUF-16HE

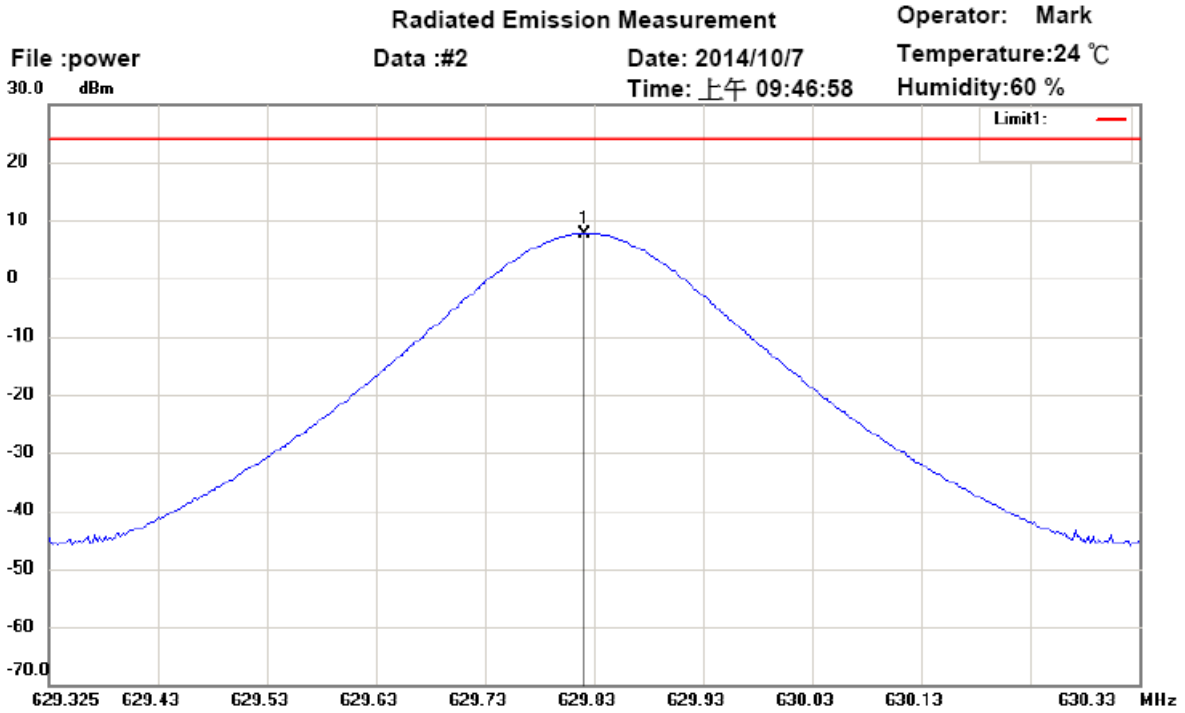

Site : Chamber
 Condition : FCC 74.861 power(470-608 and 614-698)
 EUT : W6M21409-14515
 M/N: UF-16
 Test Mode : 629.825MHz
 Note :

Polarization: **Vertical**
 Power : 3V d.c.
 Distance: 3m

Mk.	Frequency (MHz)	Reading (dBm)	Detector	Corr. factor (dB)	Result (dBm)	Limit (dBm)	Ant.Pos (cm)	Tab.Pos (deg.)	Margin (dB)	Comment
*	629.8160	-24.29	peak	31.92	7.63	24.00	150	180	-16.37	



Worldwide Testing Services(Taiwan) Co., Ltd.

Registration number: W6M21409-14515-C-1
 FCC ID: JEBUF-16HE

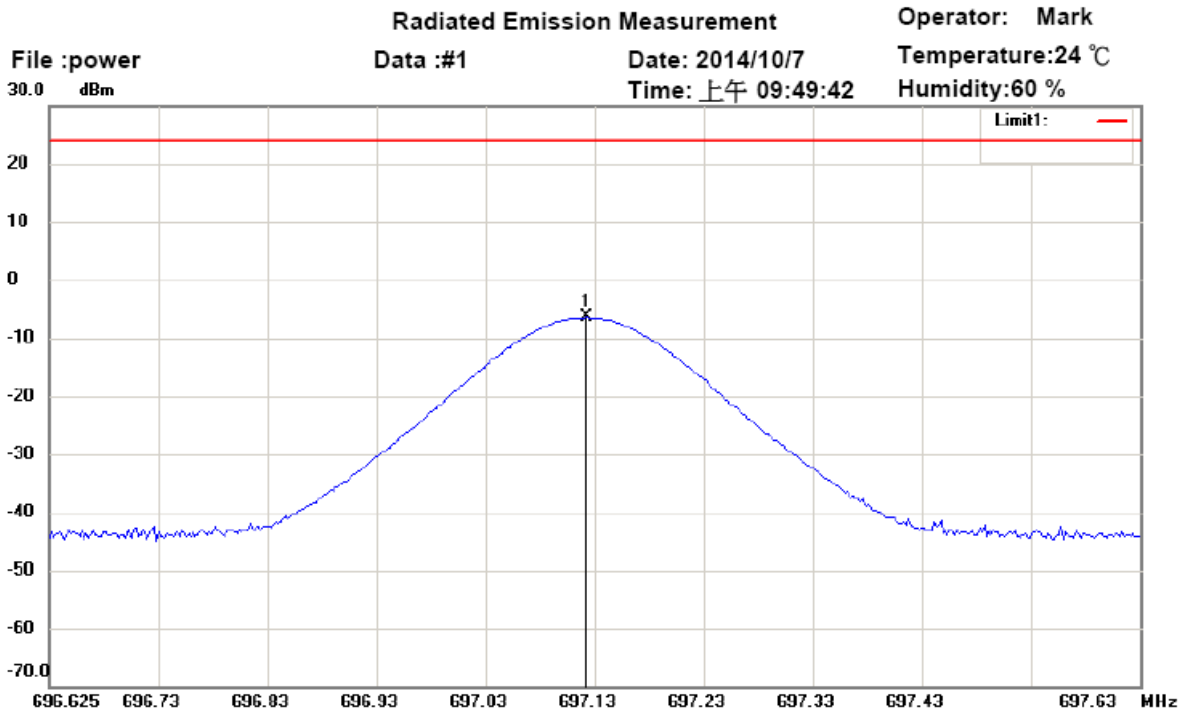

Site : Chamber
 Condition : FCC 74.861 power(470-608 and 614-698) Polarization: *Horizontal*
 EUT : W6M21409-14515 Power : 3V d.c.
 M/N: UF-16 Distance: 3m
 Test Mode : 697.125MHz
 Note :

Mk.	Frequency (MHz)	Reading (dBm)	Detector	Corr. factor (dB)	Result (dBm)	Limit (dBm)	Ant.Pos (cm)	Tab.Pos (deg.)	Margin (dB)	Comment
*	697.1180	-41.04	peak	34.58	-6.46	24.00	150	20	-30.46	

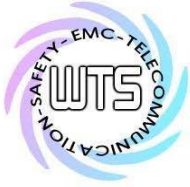

Worldwide Testing Services(Taiwan) Co., Ltd.

Registration number: W6M21409-14515-C-1
 FCC ID: JEBUF-16HE

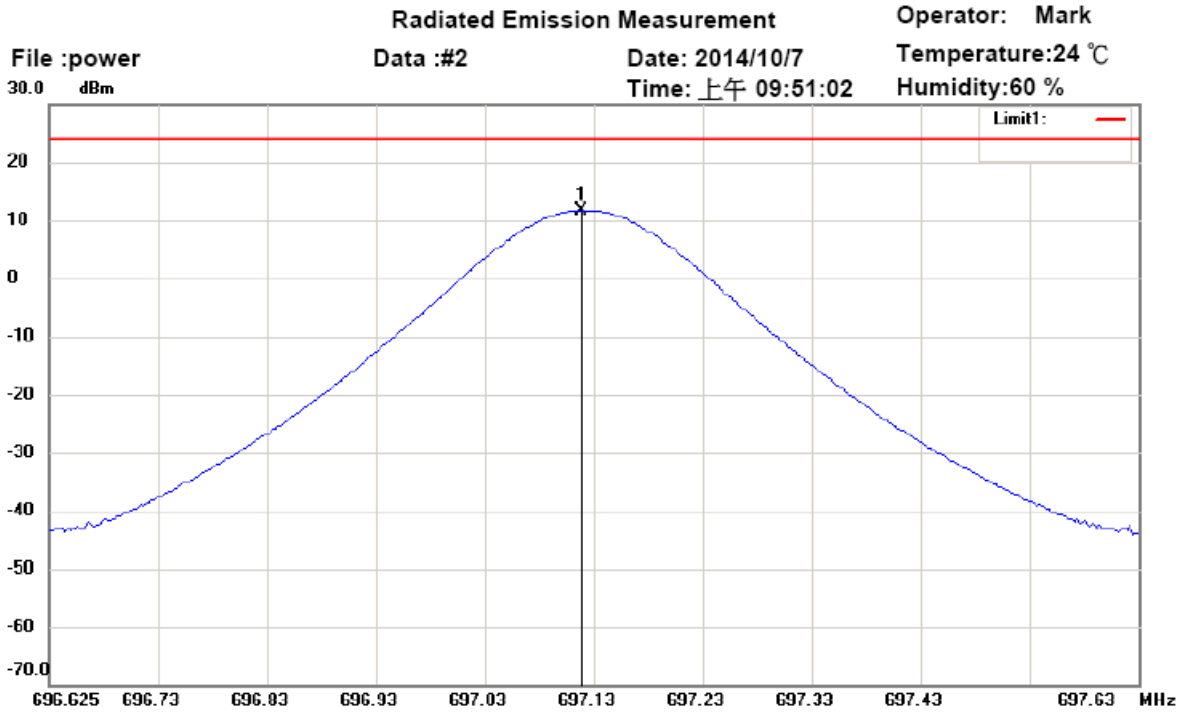

Site : Chamber
 Condition : FCC 74.861 power(470-608 and 614-698) Polarization: **Vertical**
 EUT : W6M21409-14515 Power : 3V d.c.
 M/N: UF-16 Distance: 3m
 Test Mode : 697.125MHz
 Note :

Mk.	Frequency (MHz)	Reading (dBm)	Detector	Corr. factor (dB)	Result (dBm)	Limit (dBm)	Ant.Pos (cm)	Tab.Pos (deg.)	Margin (dB)	Comment
*	697.1140	-22.40	peak	34.13	11.73	24.00	150	300	-12.27	

Test equipment used: ETSTW-RE 004, ETSTW-RE 122, ETSTW-RE 042, ETSTW-RE 043



Registration number: W6M21409-14515-C-1

FCC ID: JEBUF-16HE

6 Modulation Deviation , FCC 2.1047 (b) ; 74.861(e)

6.1 Test procedure

Modulation limiting is the transmitter circuit's ability to limit the transmitter from producing deviations in excess of rated system deviation.

The audio signal generator is connected to the audio input of the EUT with its full rating.

The modulation response is measured at certain modulation frequencies, related to 1000Hz reference signal. Tests are performed for positive and negative modulation.

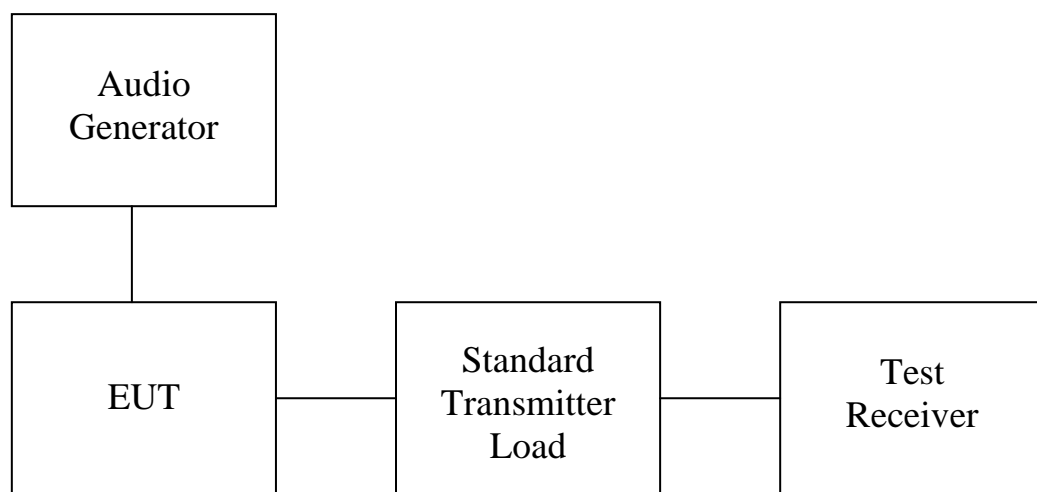

6.2 Test results

Explanation: Please see attached diagrams as appendix.

Limits : ± 75 kHz

Test equipment used: ETSTW-RE 072, ETSTW-RE 055, ETSTW-RE 050



Registration number: W6M21409-14515-C-1

FCC ID: JEBUF-16HE

7 Audio frequency response , FCC 2.1047 (a)

7.1 Test procedure

The audio frequency response is the degree of closeness to which the frequency deviation of the transmitter follows a prescribed characteristic.

The frequency response of the audio modulation part is measured over a frequency range of 100 Hz to 5000 Hz.

For 1000 Hz tone reference signal the audio generator level is adjusted to get 20% of the rated system deviation.

The deviations obtained over the frequency range from 100 Hz to 5000 Hz are recorded and compared with the reference deviation as follows :

$$\text{Audio Frequency Response} = 20 \log [\text{DEV}_{\text{Freq}} / \text{DEV}_{\text{ref}}].$$

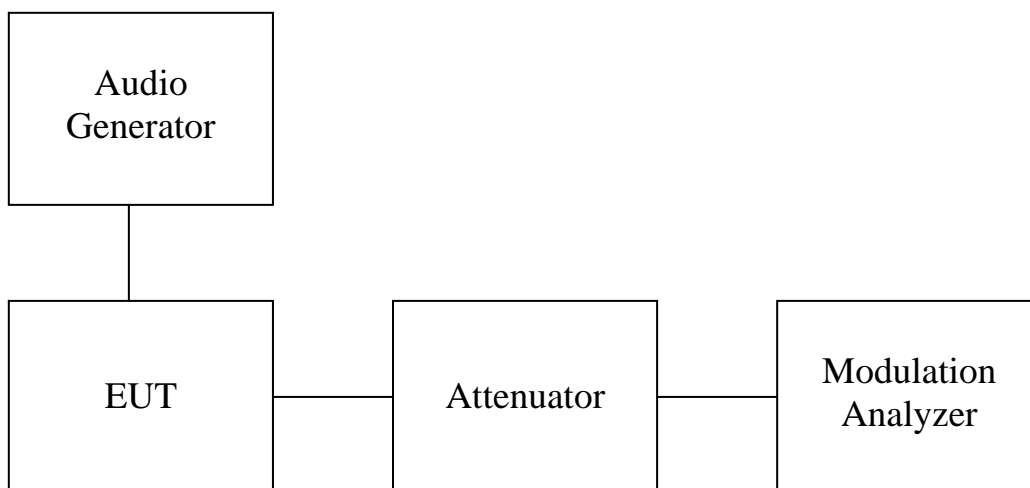

7.2 Test results

Explanation: Please see attached diagrams as appendix.

Test equipment used: ETSTW-RE 072

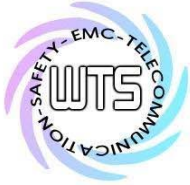

Worldwide Testing Services(Taiwan) Co., Ltd.

Registration number: W6M21409-14515-C-1

FCC ID: JEBUF-16HE

8 Occupied Bandwidth/Emission Mask, FCC 2.1049 (c) ; 74.861 (e)(5)

The occupied bandwidth, that is the frequency bandwidth such that, below its lower and above its upper frequency limits, the mean powers radiated are each equal to 0.5 percent of the total mean power. Near the carrier an Emission Mask is defined by the standard.

8.1 Test procedure

The RF output of the transceiver was connected to the input of the spectrum analyzer through sufficient attenuation.

Occupied Bandwidth was measured with a occupied bandwidth function of the analyzer.

The near the carrier emissions are measured by normal power measurement function of the analyzer.

8.2 Test Results

1000 Hz Modulation

Occupied Channel Bandwidth (kHz)	
520.125 MHz	67.708333333
544.125 MHz	67.307692308
607.225 MHz	67.307692308
615.025 MHz	67.708333333
629.825 MHz	67.708333333
697.125 MHz	67.708333333

2500 Hz Modulation

Occupied Channel Bandwidth (kHz)	
520.125 MHz	86.137820513
544.125 MHz	84.535256410
607.225 MHz	86.939102564
615.025 MHz	86.939102564
629.825 MHz	87.339743590
697.125 MHz	88.942307692

Explanation : Please see attached diagram as appendix .

8.3 Limit

The operating bandwidth shall not exceed 200 kHz.

Test equipment used: ETSTW-RE 055 , ETSTW-RE 072, ETSTW-RE 050

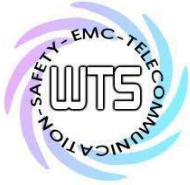

Registration number: W6M21409-14515-C-1

FCC ID: JEBUF-16HE

9 Spurious Emissions at Antenna Terminals FCC2.1051 ; 74.861 (e)

9.1 Test procedure

This transmitter output was connected to a calibrated coaxial attenuator, the other end of which was connected to a spectrum analyzer. Transmitter output was derived with the spectrum analyzer in dBm.

The Spurious Emissions at Antenna Terminals was measured by the spectrum analyzer with a suitable notch filter and high-pass filter.

Tests were performed with an un-modulated carrier at three frequencies (low , middle and high channels) and on all power levels , which can be set-up on the transmitters.

9.2 Test Results

Summary table with conducted data of the test plots for Carrier Test Frequency

Frequency Marker Indication [MHz]	Indication Power Level [dBm]	Compliance Limit [dBm]	Margin
--	--	--	--
--	--	--	--

9.3 Limit

Compliance with § 74.861 requires that any emission be attenuated below the transmitter power at least $43 + 10 \log_{10} P$ (P = transmitter power in Watts).

The compliance limit was calculated as an example per the following table :

Maximum transmitter output power	11.73 dBm
Required attenuation	$43 + 10 \log_{10} 0.01489 \text{ W} = 24.73 \text{ dB}$
Maximum transmitter output power <u>Required attenuation</u>	11.73 dBm <u>24.73 dB</u>
Compliance limit	-13 dBm

Test equipment used: ETSTW-RE 055, ETSTW-RE 050

Explanation : This test is not applicable.

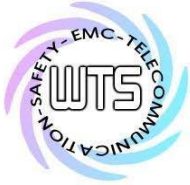

Registration number: W6M21409-14515-C-1

FCC ID: JEBUF-16HE

10 Radiated Spurious Emission , FCC 2.1053 ; 74.861 (e)

10.1 Test procedure

The EUT was positioned on a non-conductive turntable , 0.8m above the ground plane.

The radiated emission at the fundamental frequency was measured at 3 m distance with a test antenna and spectrum analyzer.

Worst case emission was recorded with the rotation of the turntable and the raising and lowering of the test antenna.

ERP was measured using a substitution method. The EUT was replaced by reference antenna connected to a signal generator.

The test of spurious radiated emission have been carried out with the ESK-Software from Rode & Schwarz. The measurements below 1GHz were performed with a measurement bandwidth of 100kHz, above 1GHz with a bandwidth of 1 MHz.

Spurious emission limits near the carrier are defined by a emission mask. This measurements are done in conducted mode.

10.2 Test Results

The measurements of the spurious emission at the upper , center and lower channel.

The measurement diagrams show that all significant spurs are well below the limit line.

Summary table with radiated data of the test plots for Carrier Test Frequency

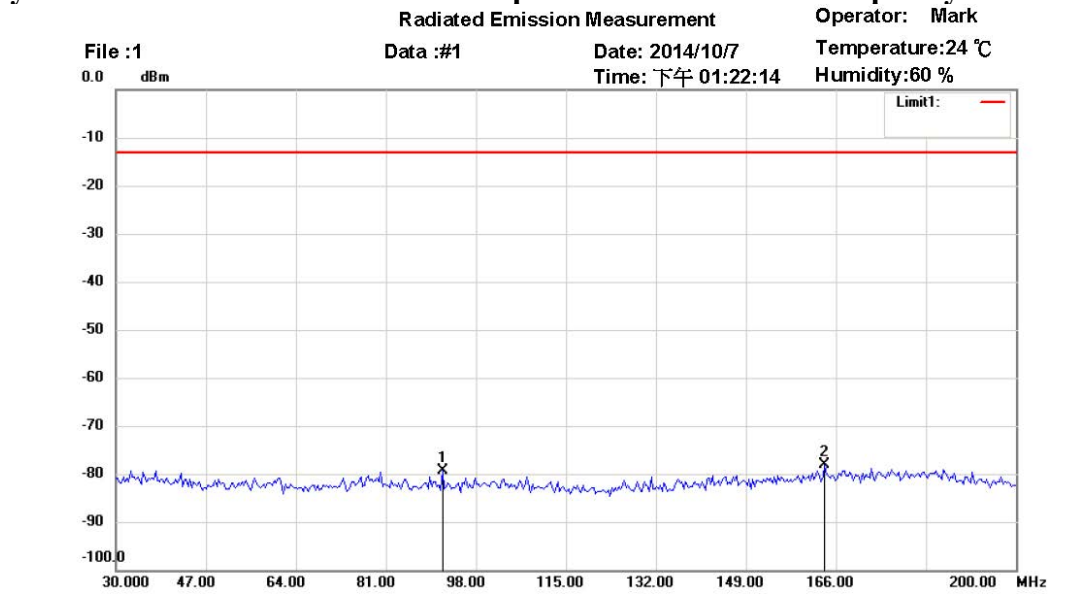

Site : Chamber
Condition : FCC 74.861 spurious emission
EUT : W6M21409-14515
M/N: UF-16
Test Mode : 502.125MHz
Polarization: *Horizontal*
Power : 3V d.c.
Distance: 3m
Note :

Mk.	Frequency (MHz)	Reading (dBm)	Detector	Corr. factor (dB)	Result (dBm)	Limit (dBm)	Ant.Pos (cm)	Tab.Pos (deg.)	Margin (dB)	Comment
	91.6633	-102.23	peak	22.96	-79.27	-13.00	150	100	-66.27	
*	163.8878	-102.92	peak	24.68	-78.24	-13.00	150	250	-65.24	

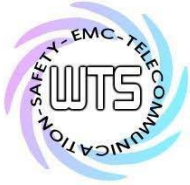

Worldwide Testing Services(Taiwan) Co., Ltd.

Registration number: W6M21409-14515-C-1
 FCC ID: JEBUF-16HE

Radiated Emission Measurement

Operator: Mark

File :1

Data :#2

Date: 2014/10/7

Temperature:24 °C

Time: 下午 01:27:49

Humidity:60 %

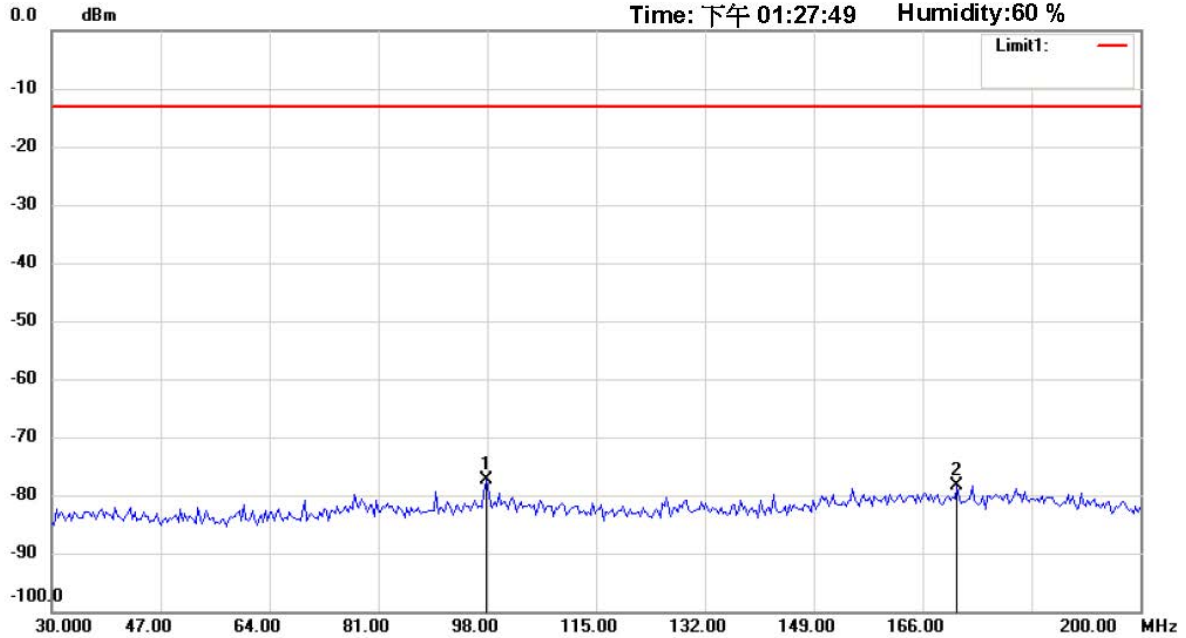

Site : Chamber

Condition : FCC 74.861 spurious emission

Polarization: *Vertical*

EUT : W6M21409-14515

Power : 3V d.c.

M/N: UF-16

Distance: 3m

Test Mode : 502.125MHz

Note :

Mk.	Frequency (MHz)	Reading (dBm)	Detector	Corr. factor (dB)	Result (dBm)	Limit (dBm)	Ant.Pos (cm)	Tab.Pos (deg.)	Margin (dB)	Comment
*	97.7956	-101.59	peak	24.31	-77.28	-13.00	150	100	-64.28	
	171.3828	-103.61	peak	25.34	-78.27	-13.00	150	210	-65.27	



Worldwide Testing Services(Taiwan) Co., Ltd.

Registration number: W6M21409-14515-C-1
 FCC ID: JEBUF-16HE

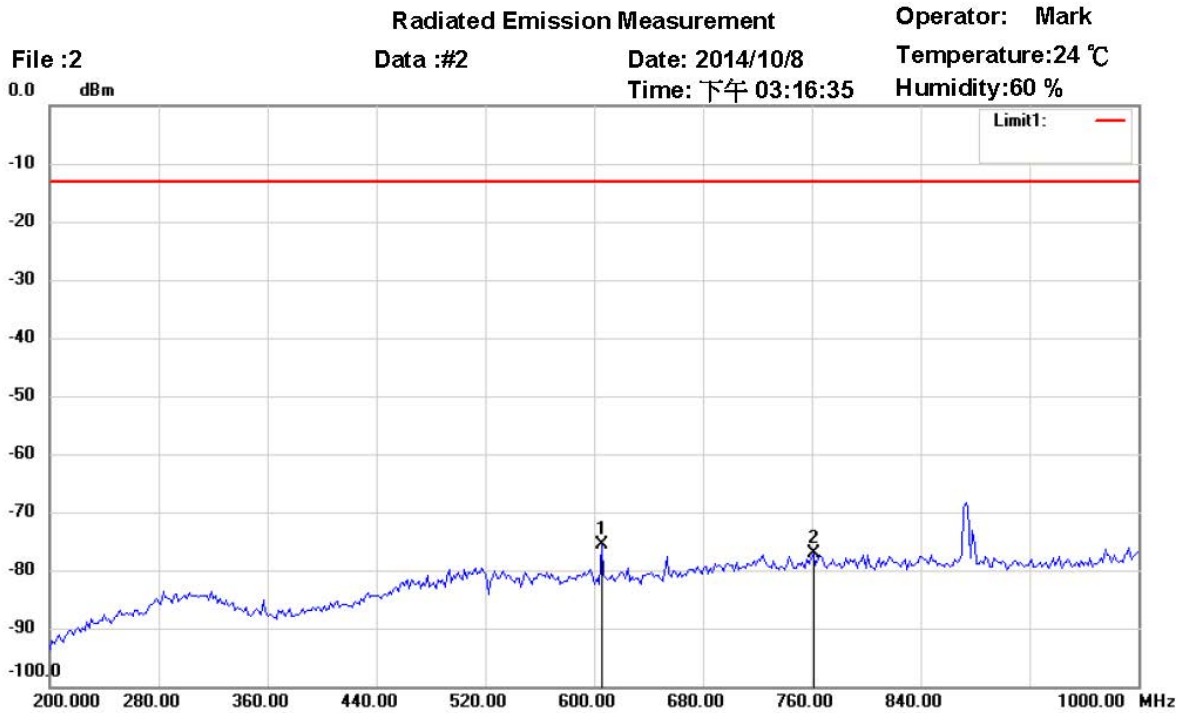

Site : Chamber
 Condition : FCC 74.861 spurious emission
 EUT : W6M21409-14515
 M/N: UF-16
 Test Mode : 520.125MHz
 Note :

Polarization: *Vertical*
 Power : 3V d.c.
 Distance: 3m

Mk.	Frequency (MHz)	Reading (dBm)	Detector	Corr. factor (dB)	Result (dBm)	Limit (dBm)	Ant.Pos (cm)	Tab.Pos (deg.)	Margin (dB)	Comment
*	605.6112	-72.06	peak	-3.68	-75.74	-13.00	150	70	-62.74	
	761.1221	-75.78	peak	-1.36	-77.14	-13.00	150	150	-64.14	



Worldwide Testing Services(Taiwan) Co., Ltd.

Registration number: W6M21409-14515-C-1
 FCC ID: JEBUF-16HE

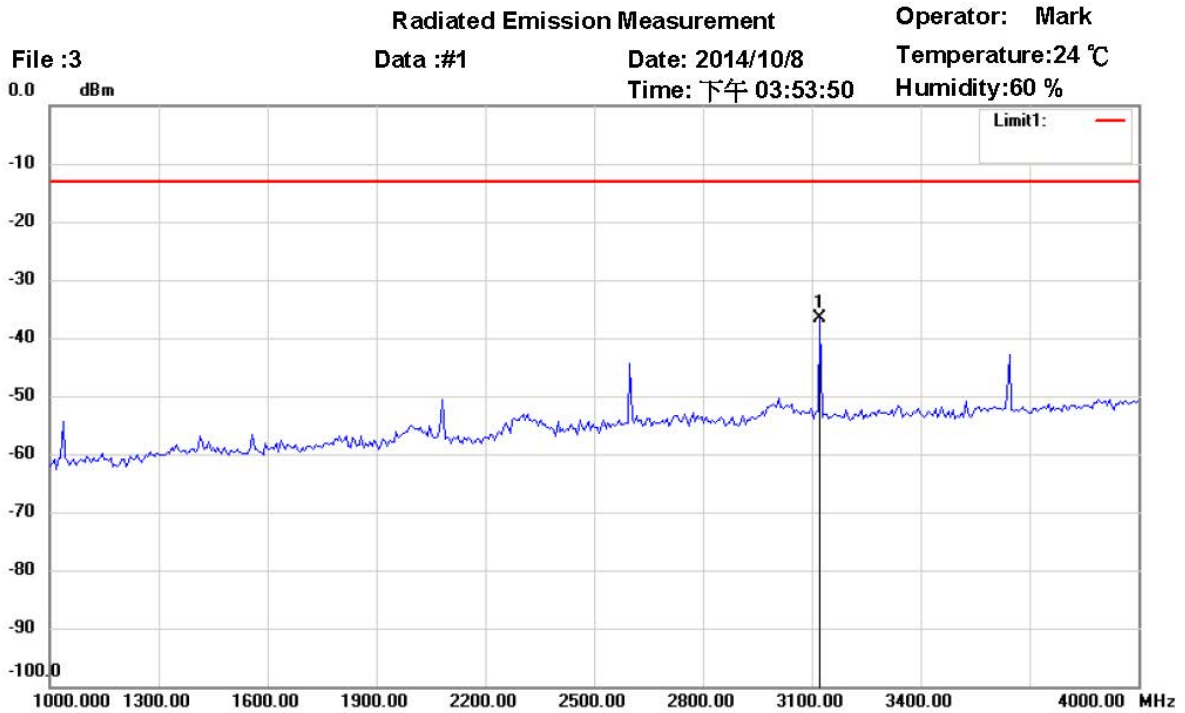

Site : Chamber
 Condition : FCC 74.861 spurious emission
 EUT : W6M21409-14515
 M/N: UF-16
 Test Mode : 520.125MHz
 Note :

Polarization: *Horizontal*
 Power : 3V d.c.
 Distance: 3m

Mk.	Frequency (MHz)	Reading (dBm)	Detector	Corr. factor (dB)	Result (dBm)	Limit (dBm)	Ant.Pos (cm)	Tab.Pos (deg.)	Margin (dB)	Comment
*	3122.244	-45.72	peak	9.17	-36.55	-13.00	150	110	-23.55	

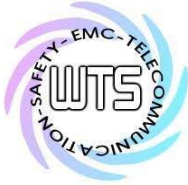

Worldwide Testing Services(Taiwan) Co., Ltd.

Registration number: W6M21409-14515-C-1
 FCC ID: JEBUF-16HE

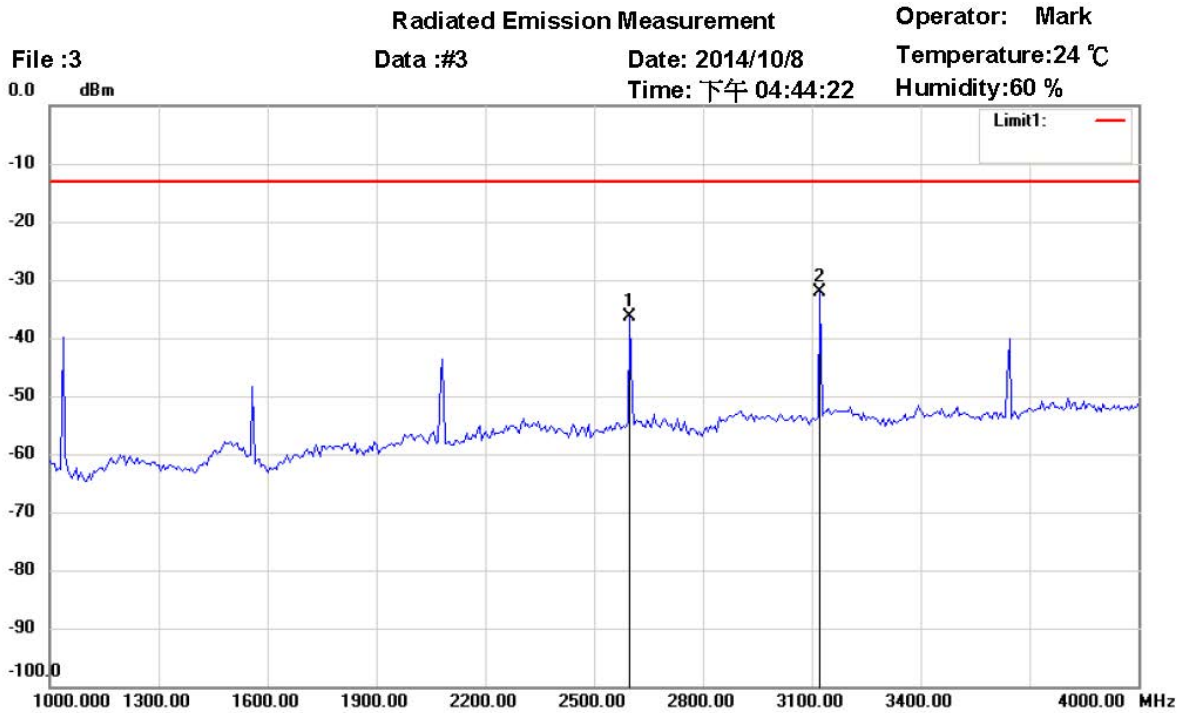

Site : Chamber
 Condition : FCC 74.861 spurious emission
 EUT : W6M21409-14515
 M/N: UF-16
 Test Mode : 520.125MHz
 Note :

Polarization: *Vertical*
 Power : 3V d.c.
 Distance: 3m

Mk.	Frequency (MHz)	Reading (dBm)	Detector	Corr. factor (dB)	Result (dBm)	Limit (dBm)	Ant.Pos (cm)	Tab.Pos (deg.)	Margin (dB)	Comment
	2599.198	-44.59	peak	8.34	-36.25	-13.00	150	140	-23.25	
*	3122.244	-41.52	peak	9.44	-32.08	-13.00	150	210	-19.08	

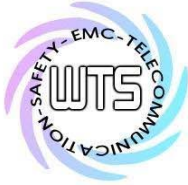

Worldwide Testing Services(Taiwan) Co., Ltd.

Registration number: W6M21409-14515-C-1
 FCC ID: JEBUF-16HE

Radiated Emission Measurement

Operator: Mark

File :3

Data :#2

Date: 2014/10/8

Temperature:24 °C

Time: 下午 04:43:21

Humidity:60 %

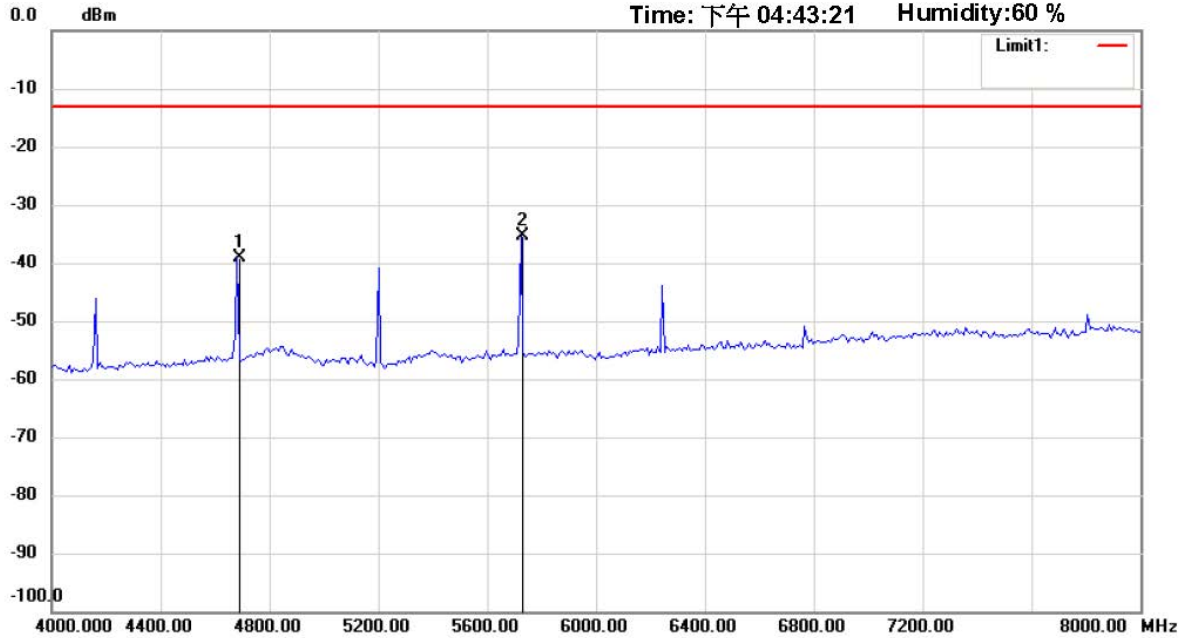

Site : Chamber

Condition : FCC 74.861 spurious emission

Polarization: *Horizontal*

EUT : W6M21409-14515

Power : 3V d.c.

M/N: UF-16

Distance: 3m

Test Mode : 520.125MHz

Note :

Mk.	Frequency (MHz)	Reading (dBm)	Detector	Corr. factor (dB)	Result (dBm)	Limit (dBm)	Ant.Pos (cm)	Tab.Pos (deg.)	Margin (dB)	Comment
	4681.363	-48.99	peak	9.80	-39.19	-13.00	150	250	-26.19	
*	5723.447	-47.46	peak	11.99	-35.47	-13.00	150	170	-22.47	

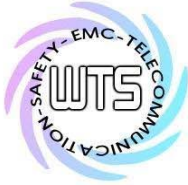

Worldwide Testing Services(Taiwan) Co., Ltd.

Registration number: W6M21409-14515-C-1
 FCC ID: JEBUF-16HE

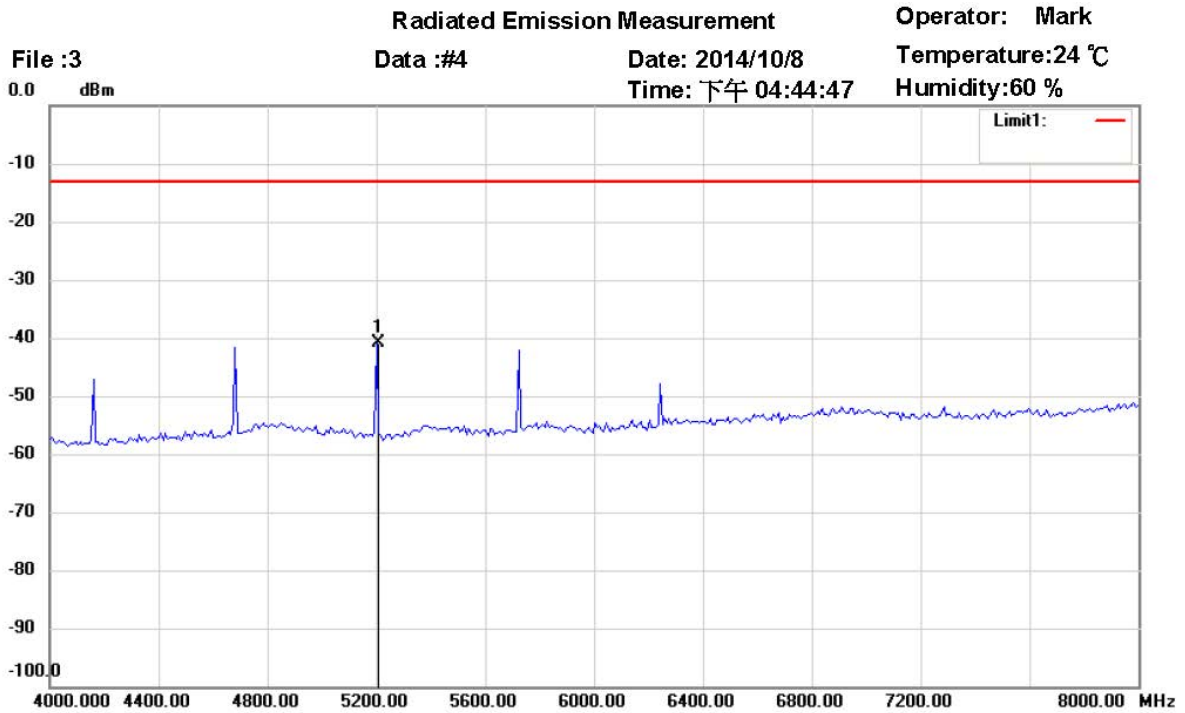

Site : Chamber
 Condition : FCC 74.861 spurious emission Polarization: *Vertical*
 EUT : W6M21409-14515 Power : 3V d.c.
 M/N: UF-16 Distance: 3m
 Test Mode : 520.125MHz
 Note :

Mk.	Frequency (MHz)	Reading (dBm)	Detector	Corr. factor (dB)	Result (dBm)	Limit (dBm)	Ant.Pos (cm)	Tab.Pos (deg.)	Margin (dB)	Comment
*	5202.405	-52.10	peak	11.19	-40.91	-13.00	150	230	-27.91	

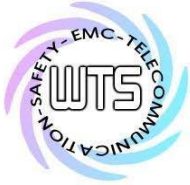

Worldwide Testing Services(Taiwan) Co., Ltd.

Registration number: W6M21409-14515-C-1
 FCC ID: JEBUF-16HE

Radiated Emission Measurement

Operator: Mark

File :1

Data :#1

Date: 2014/10/7

Temperature:24 °C

Time: 下午 01:22:47

Humidity:60 %

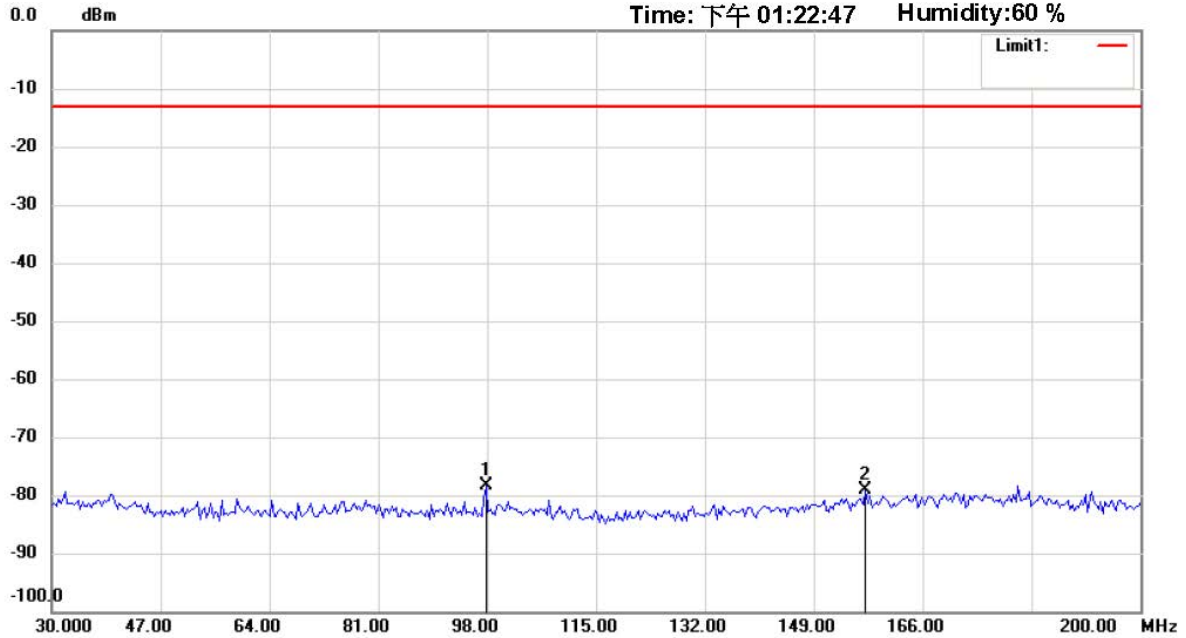

Site : Chamber

Condition : FCC 74.861 spurious emission

Polarization: *Horizontal*

EUT : W6M21409-14515

Power : 3V d.c.

M/N: UF-16

Distance: 3m

Test Mode : 544.125MHz

Note :

Mk.	Frequency (MHz)	Reading (dBm)	Detector	Corr. factor (dB)	Result (dBm)	Limit (dBm)	Ant.Pos (cm)	Tab.Pos (deg.)	Margin (dB)	Comment
*	97.7956	-101.75	peak	23.28	-78.47	-13.00	150	120	-65.47	
	157.0741	-103.63	peak	24.39	-79.24	-13.00	150	250	-66.24	

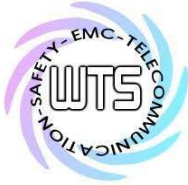

Worldwide Testing Services(Taiwan) Co., Ltd.

Registration number: W6M21409-14515-C-1
 FCC ID: JEBUF-16HE

Radiated Emission Measurement

Operator: Mark

File :1

Data :#2

Date: 2014/10/7

Temperature:24 °C

Time: 下午 01:27:29

Humidity:60 %

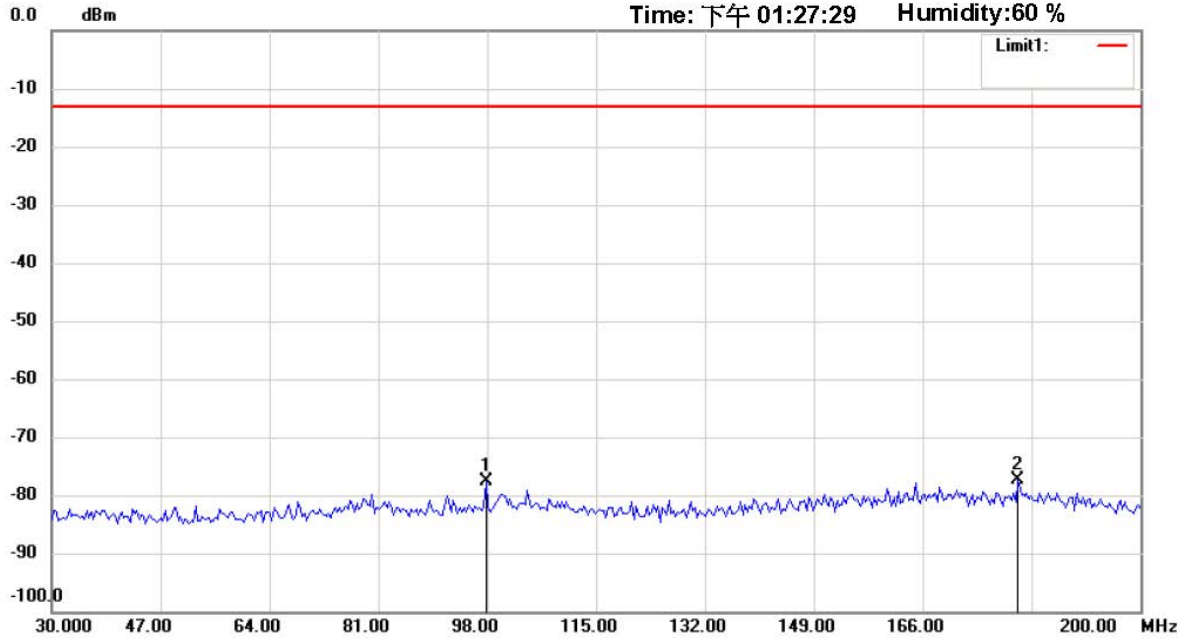

Site : Chamber

Condition : FCC 74.861 spurious emission

Polarization: *Vertical*

EUT : W6M21409-14515

Power : 3V d.c.

M/N: UF-16

Distance: 3m

Test Mode : 544.125MHz

Note :

Mk.	Frequency (MHz)	Reading (dBm)	Detector	Corr. factor (dB)	Result (dBm)	Limit (dBm)	Ant.Pos (cm)	Tab.Pos (deg.)	Margin (dB)	Comment
	97.7956	-101.97	peak	24.31	-77.66	-13.00	150	100	-64.66	
*	180.9218	-102.57	peak	25.31	-77.26	-13.00	150	20	-64.26	

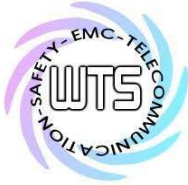

Worldwide Testing Services(Taiwan) Co., Ltd.

Registration number: W6M21409-14515-C-1
 FCC ID: JEBUF-16HE

Radiated Emission Measurement

Operator: Mark

File :2

Data :#1

Date: 2014/10/8

Temperature:24 °C

Time: 下午 03:42:30

Humidity:60 %

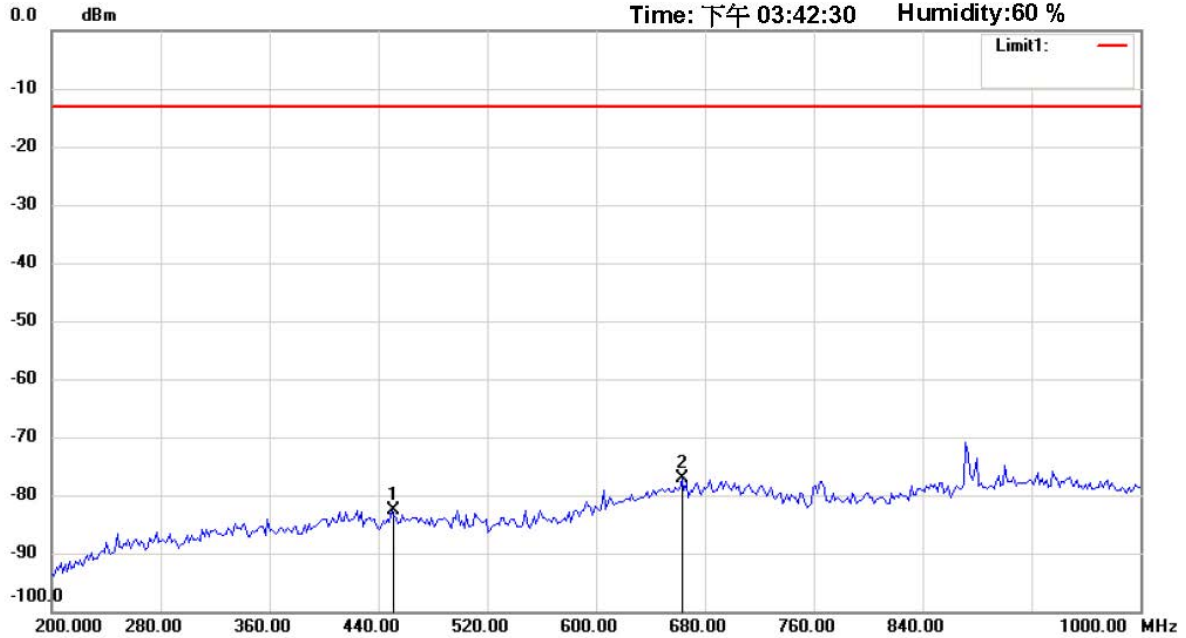

Site : Chamber

Condition : FCC 74.861 spurious emission

Polarization: *Horizontal*

EUT : W6M21409-14515

Power : 3V d.c.

M/N: UF-16

Distance: 3m

Test Mode : 544.125MHz

Note :

Mk.	Frequency (MHz)	Reading (dBm)	Detector	Corr. factor (dB)	Result (dBm)	Limit (dBm)	Ant.Pos (cm)	Tab.Pos (deg.)	Margin (dB)	Comment
	450.1003	-75.58	peak	-7.14	-82.72	-13.00	150	10	-69.72	
*	663.3267	-76.77	peak	-0.43	-77.20	-13.00	150	170	-64.20	



Worldwide Testing Services(Taiwan) Co., Ltd.

Registration number: W6M21409-14515-C-1
 FCC ID: JEBUF-16HE

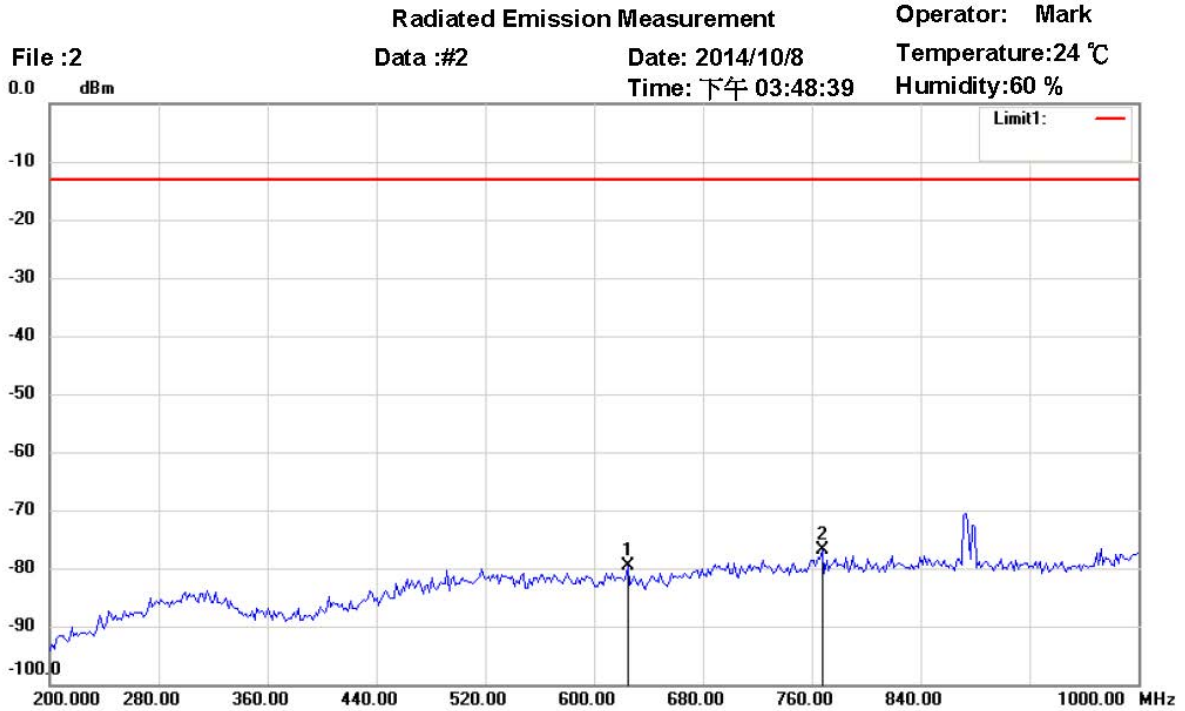

Site : Chamber
 Condition : FCC 74.861 spurious emission
 EUT : W6M21409-14515
 M/N: UF-16
 Test Mode : 544.125MHz
 Note :

Polarization: *Vertical*
 Power : 3V d.c.
 Distance: 3m

Mk.	Frequency (MHz)	Reading (dBm)	Detector	Corr. factor (dB)	Result (dBm)	Limit (dBm)	Ant.Pos (cm)	Tab.Pos (deg.)	Margin (dB)	Comment
	624.8497	-76.09	peak	-3.41	-79.50	-13.00	150	170	-66.50	
*	767.5351	-75.56	peak	-1.30	-76.86	-13.00	150	210	-63.86	



Worldwide Testing Services(Taiwan) Co., Ltd.

Registration number: W6M21409-14515-C-1
 FCC ID: JEBUF-16HE

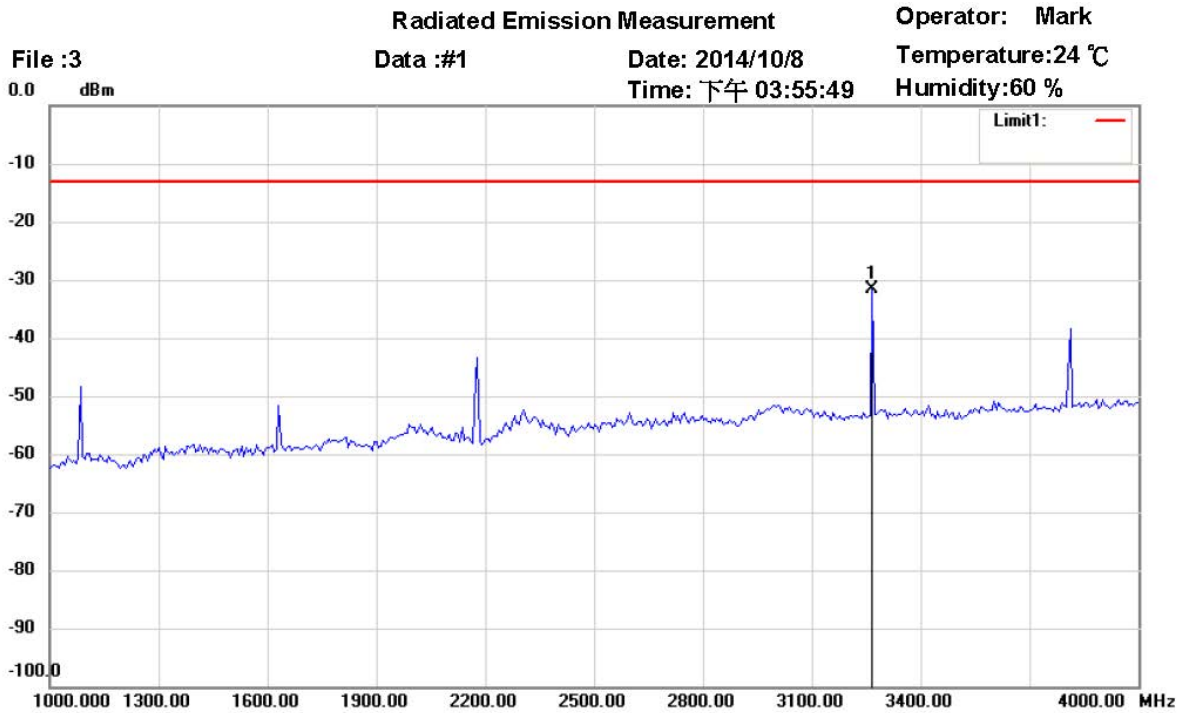

Site : Chamber
 Condition : FCC 74.861 spurious emission
 EUT : W6M21409-14515
 M/N: UF-16
 Test Mode : 544.125MHz

Polarization: *Horizontal*
 Power : 3V d.c.
 Distance: 3m

Note :

Mk.	Frequency (MHz)	Reading (dBm)	Detector	Corr. factor (dB)	Result (dBm)	Limit (dBm)	Ant.Pos (cm)	Tab.Pos (deg.)	Margin (dB)	Comment
*	3266.533	-40.84	peak	9.33	-31.51	-13.00	150	40	-18.51	

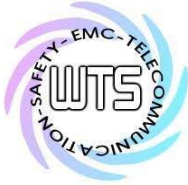

Worldwide Testing Services(Taiwan) Co., Ltd.

Registration number: W6M21409-14515-C-1
 FCC ID: JEBUF-16HE

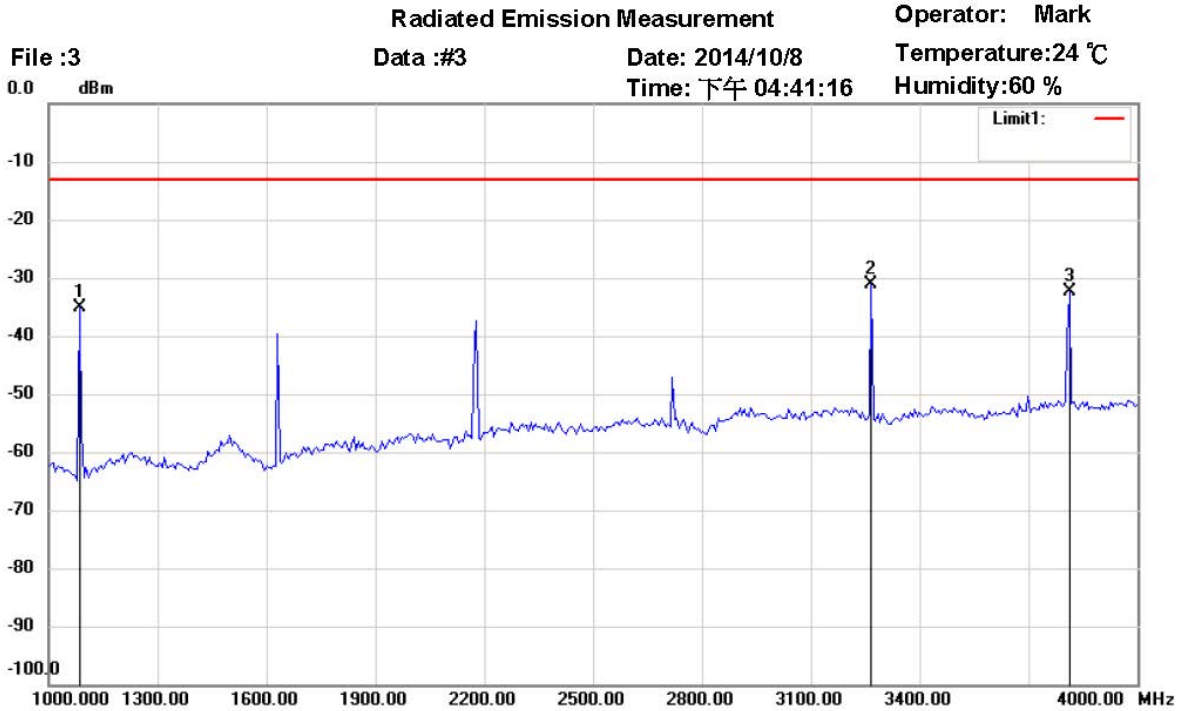

Site : Chamber
 Condition : FCC 74.861 spurious emission Polarization: *Vertical*
 EUT : W6M21409-14515 Power : 3V d.c.
 M/N: UF-16 Distance: 3m
 Test Mode : 544.125MHz
 Note :

Mk.	Frequency (MHz)	Reading (dBm)	Detector	Corr. factor (dB)	Result (dBm)	Limit (dBm)	Ant.Pos (cm)	Tab.Pos (deg.)	Margin (dB)	Comment
	1084.168	-34.34	peak	-0.74	-35.08	-13.00	150	220	-22.08	
*	3266.533	-40.26	peak	9.09	-31.17	-13.00	150	180	-18.17	
	3813.627	-44.46	peak	12.11	-32.35	-13.00	150	210	-19.35	



Worldwide Testing Services(Taiwan) Co., Ltd.

Registration number: W6M21409-14515-C-1
 FCC ID: JEBUF-16HE

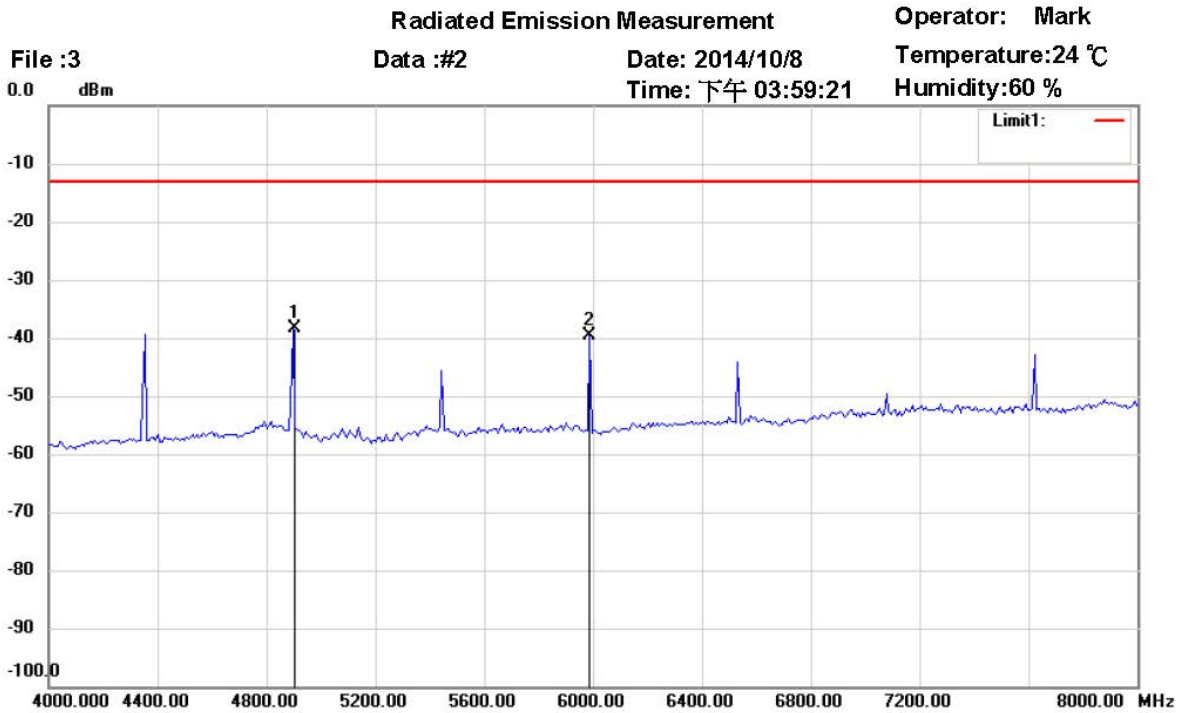

Site : Chamber
 Condition : FCC 74.861 spurious emission Polarization: *Horizontal*
 EUT : W6M21409-14515 Power : 3V d.c.
 M/N: UF-16 Distance: 3m
 Test Mode : 544.125MHz
 Note :

Mk.	Frequency (MHz)	Reading (dBm)	Detector	Corr. factor (dB)	Result (dBm)	Limit (dBm)	Ant.Pos (cm)	Tab.Pos (deg.)	Margin (dB)	Comment
*	4897.796	-49.44	peak	11.17	-38.27	-13.00	150	100	-25.27	
	5987.976	-52.46	peak	12.83	-39.63	-13.00	150	250	-26.63	

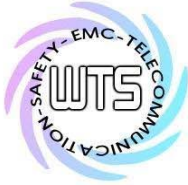

Worldwide Testing Services(Taiwan) Co., Ltd.

Registration number: W6M21409-14515-C-1
 FCC ID: JEBUF-16HE

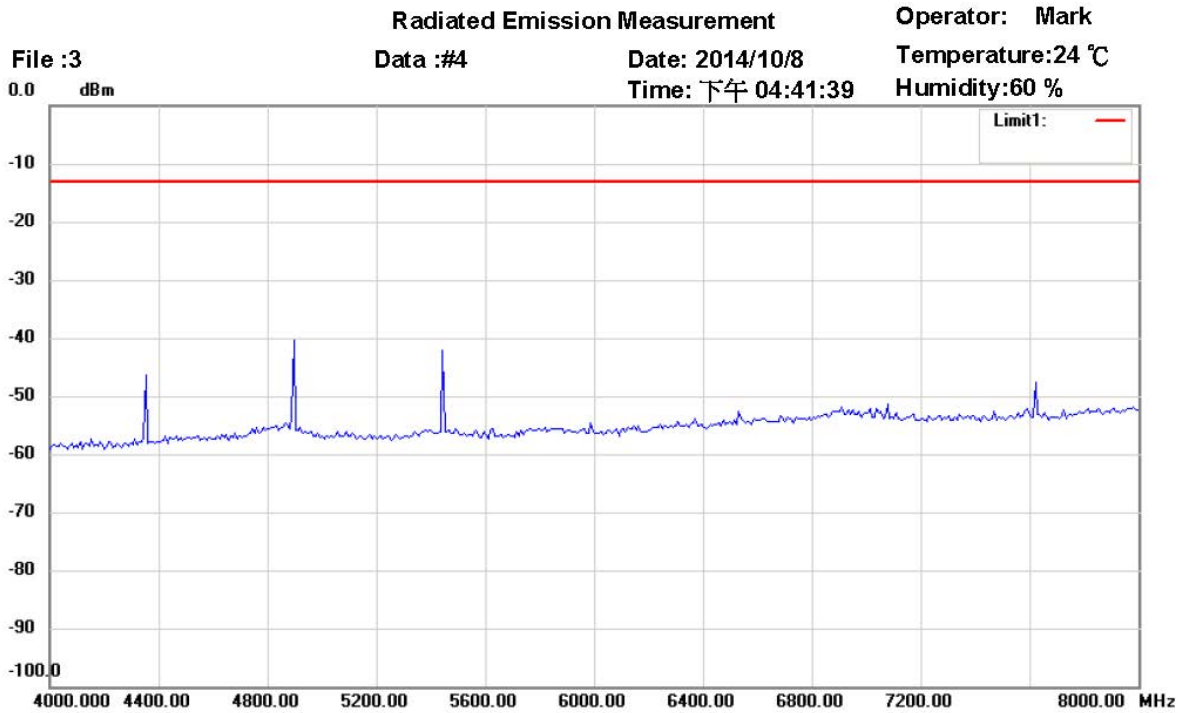

Site : Chamber
 Condition : FCC 74.861 spurious emission
 EUT : W6M21409-14515
 M/N: UF-16
 Test Mode : 544.125MHz
 Note :

Polarization: *Vertical*
 Power : 3V d.c.
 Distance: 3m

Mk.	Frequency (MHz)	Reading (dBm)	Detector	Corr. factor (dB)	Result (dBm)	Limit (dBm)	Ant.Pos (cm)	Tab.Pos (deg.)	Margin (dB)	Comment
-----	-----------------	---------------	----------	-------------------	--------------	-------------	--------------	----------------	-------------	---------

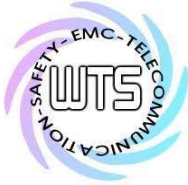

Worldwide Testing Services(Taiwan) Co., Ltd.

Registration number: W6M21409-14515-C-1
 FCC ID: JEBUF-16HE

Radiated Emission Measurement

Operator: Mark

File :1

Data :#1

Date: 2014/10/7

Temperature:24 °C

Time: 下午 01:23:29

Humidity:60 %

0.0 dBm

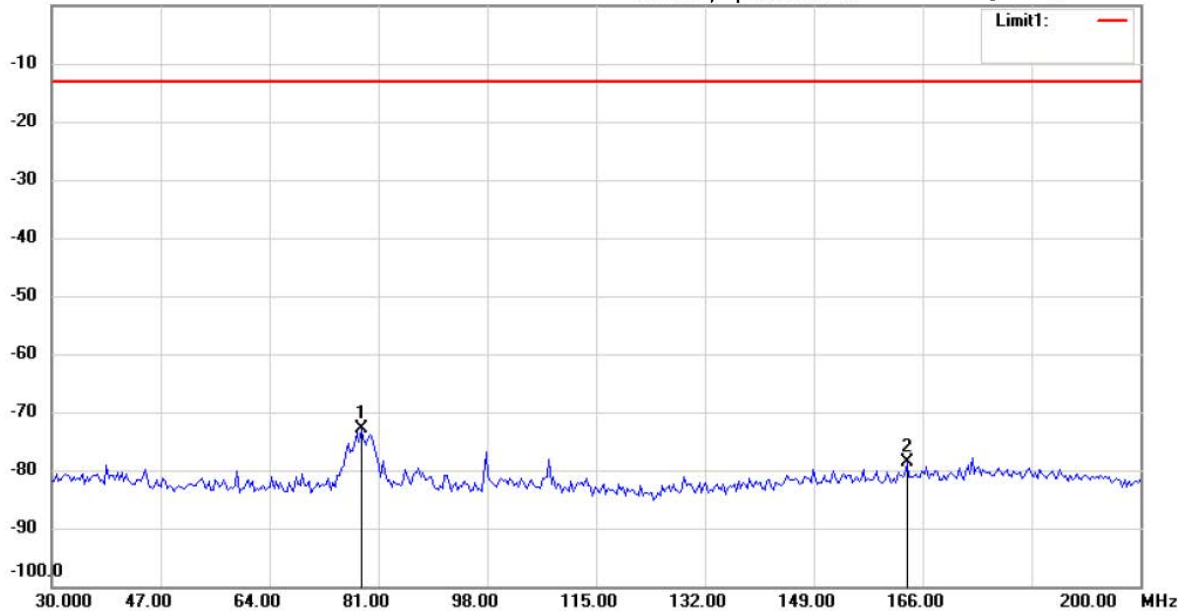

Site : Chamber

Condition : FCC 74.861 spurious emission

Polarization: *Horizontal*

EUT : W6M21409-14515

Power : 3V d.c.

M/N: UF-16

Distance: 3m

Test Mode : 607.225MHz

Note :

Mk.	Frequency (MHz)	Reading (dBm)	Detector	Corr. factor (dB)	Result (dBm)	Limit (dBm)	Ant.Pos (cm)	Tab.Pos (deg.)	Margin (dB)	Comment
*	78.3768	-97.03	peak	24.04	-72.99	-13.00	150	180	-59.99	
	163.5471	-103.23	peak	24.67	-78.56	-13.00	150	210	-65.56	

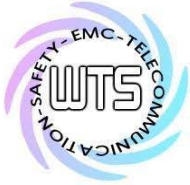

Worldwide Testing Services(Taiwan) Co., Ltd.

Registration number: W6M21409-14515-C-1
 FCC ID: JEBUF-16HE

Radiated Emission Measurement

Operator: Mark

File :1

Data :#2

Date: 2014/10/7

Temperature:24 °C

Time: 下午 01:27:09

Humidity:60 %

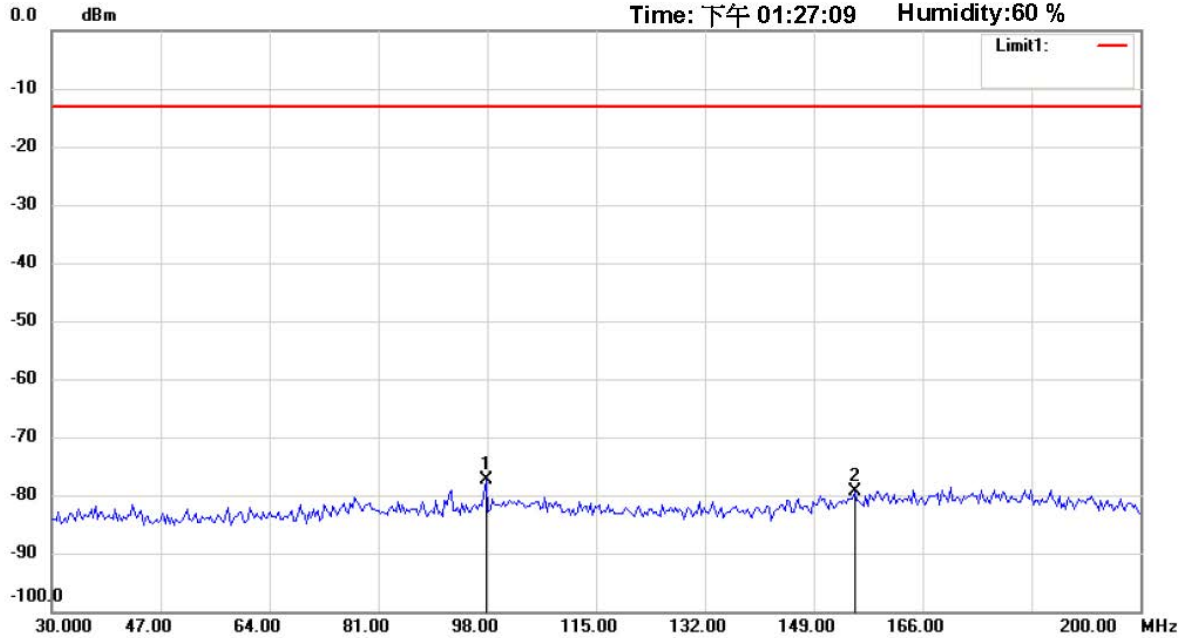

Site : Chamber

Condition : FCC 74.861 spurious emission

Polarization: *Vertical*

EUT : W6M21409-14515

Power : 3V d.c.

M/N: UF-16

Distance: 3m

Test Mode : 607.225MHz

Note :

Mk.	Frequency (MHz)	Reading (dBm)	Detector	Corr. factor (dB)	Result (dBm)	Limit (dBm)	Ant.Pos (cm)	Tab.Pos (deg.)	Margin (dB)	Comment
*	97.7956	-101.69	peak	24.31	-77.38	-13.00	150	100	-64.38	
	155.3707	-104.25	peak	24.87	-79.38	-13.00	150	200	-66.38	

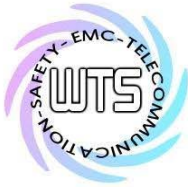

Worldwide Testing Services(Taiwan) Co., Ltd.

Registration number: W6M21409-14515-C-1
 FCC ID: JEBUF-16HE

Radiated Emission Measurement

Operator: Mark

File :2

Data :#1

Date: 2014/10/8

Temperature:24 °C

Time: 下午 03:43:06

Humidity:60 %

0.0 dBm

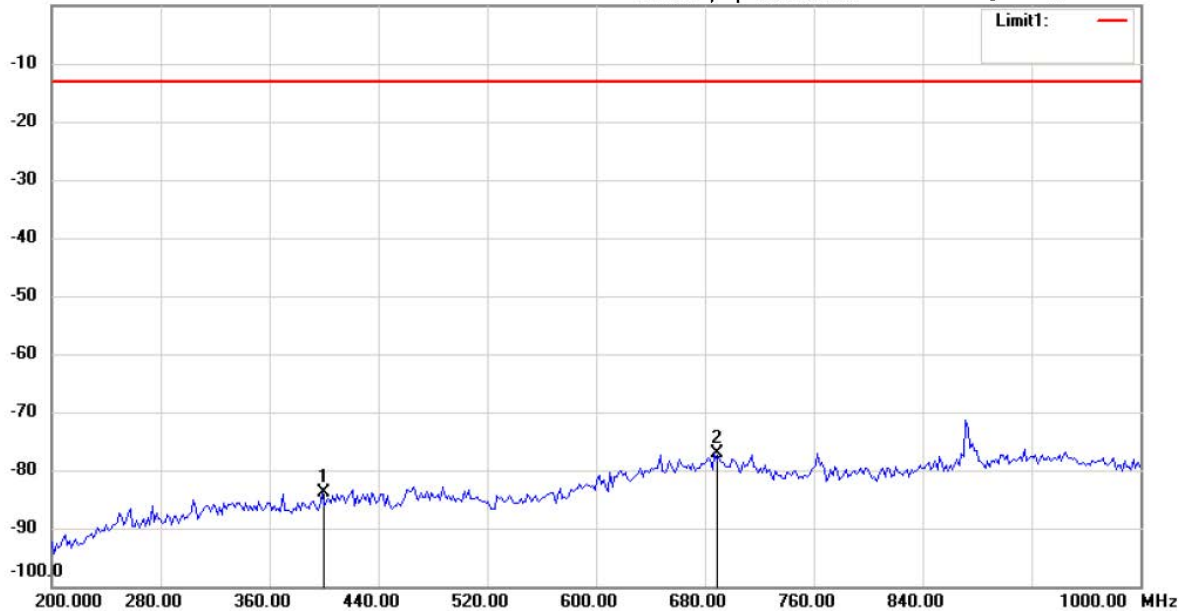

Site : Chamber

Condition : FCC 74.861 spurious emission

Polarization: *Horizontal*

EUT : W6M21409-14515

Power : 3V d.c.

M/N: UF-16

Distance: 3m

Test Mode : 607.225MHz

Note :

Mk.	Frequency (MHz)	Reading (dBm)	Detector	Corr. factor (dB)	Result (dBm)	Limit (dBm)	Ant.Pos (cm)	Tab.Pos (deg.)	Margin (dB)	Comment
	398.7977	-76.29	peak	-7.66	-83.95	-13.00	150	40	-70.95	
*	687.3748	-76.90	peak	-0.21	-77.11	-13.00	150	140	-64.11	



Worldwide Testing Services(Taiwan) Co., Ltd.

Registration number: W6M21409-14515-C-1
 FCC ID: JEBUF-16HE

Radiated Emission Measurement

Operator: Mark

File :2

Data :#2

Date: 2014/10/8

Temperature:24 °C

0.0 dBm

Time: 下午 03:48:07

Humidity:60 %

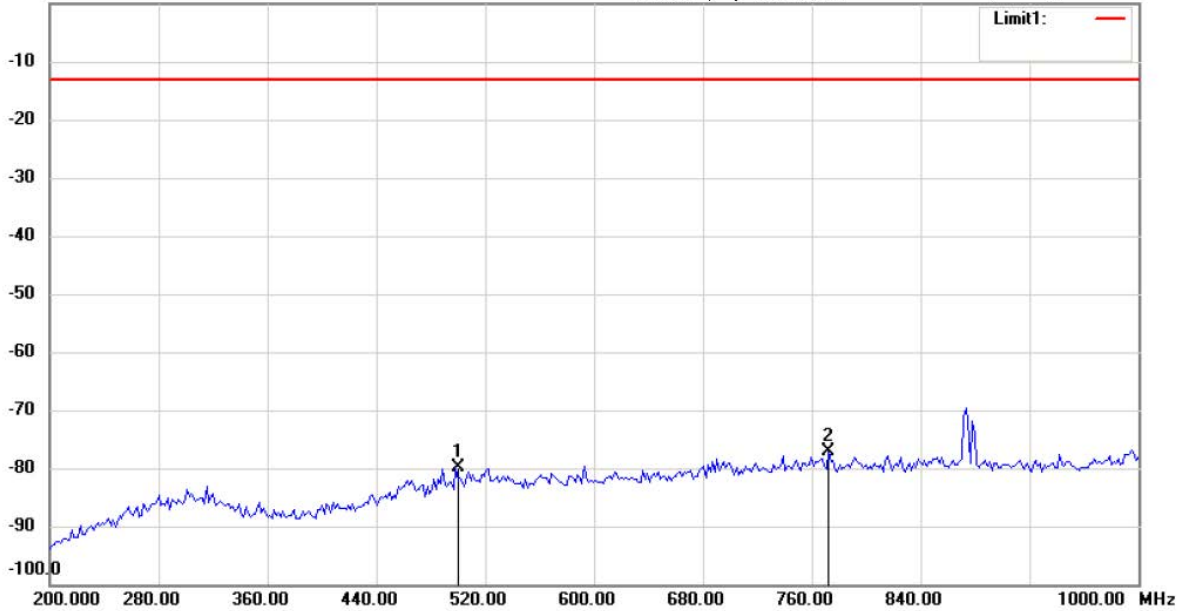

Site : Chamber

Condition : FCC 74.861 spurious emission

Polarization: *Vertical*

EUT : W6M21409-14515

Power : 3V d.c.

M/N: UF-16

Distance: 3m

Test Mode : 607.225MHz

Note :

Mk.	Frequency (MHz)	Reading (dBm)	Detector	Corr. factor (dB)	Result (dBm)	Limit (dBm)	Ant.Pos (cm)	Tab.Pos (deg.)	Margin (dB)	Comment
	498.1965	-74.52	peak	-5.28	-79.80	-13.00	150	270	-66.80	
*	772.3447	-75.97	peak	-1.26	-77.23	-13.00	150	50	-64.23	



Worldwide Testing Services(Taiwan) Co., Ltd.

Registration number: W6M21409-14515-C-1
 FCC ID: JEBUF-16HE

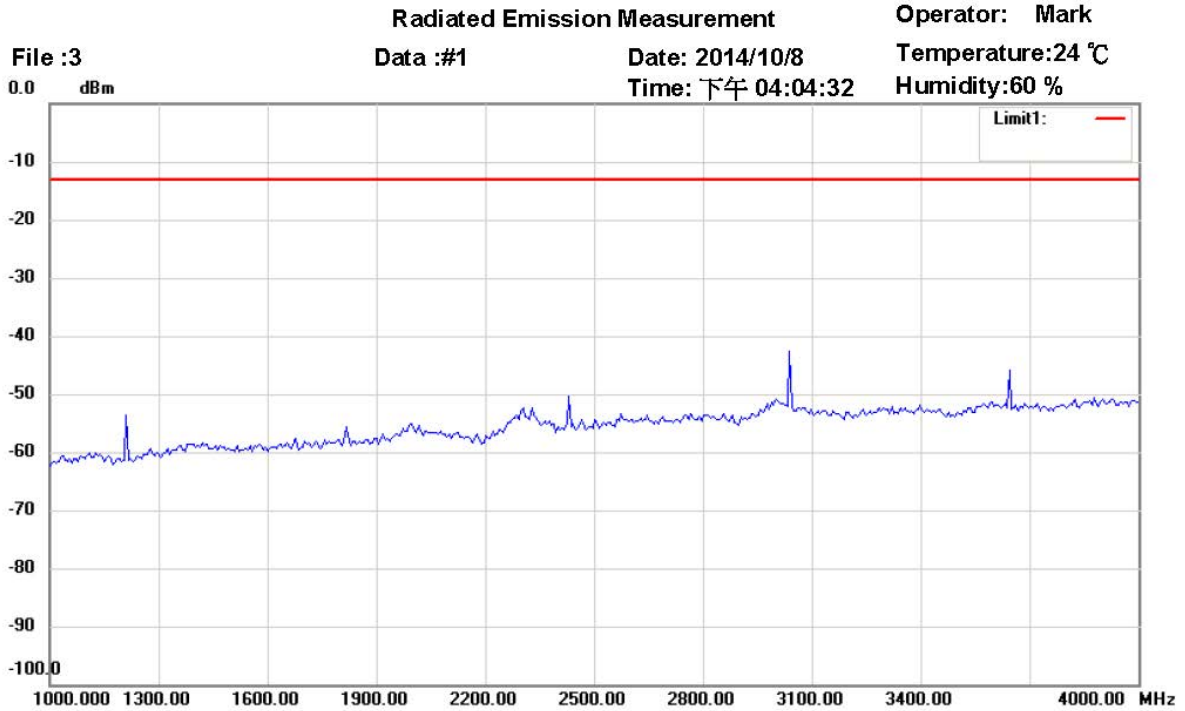

Site : Chamber
 Condition : FCC 74.861 spurious emission
 EUT : W6M21409-14515
 M/N: UF-16
 Test Mode : 607.225MHz
 Note :

Polarization: *Horizontal*
 Power : 3V d.c.
 Distance: 3m

Mk.	Frequency (MHz)	Reading (dBm)	Detector	Corr. factor (dB)	Result (dBm)	Limit (dBm)	Ant.Pos (cm)	Tab.Pos (deg.)	Margin (dB)	Comment
-----	-----------------	---------------	----------	-------------------	--------------	-------------	--------------	----------------	-------------	---------

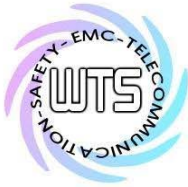

Worldwide Testing Services(Taiwan) Co., Ltd.

Registration number: W6M21409-14515-C-1
 FCC ID: JEBUF-16HE

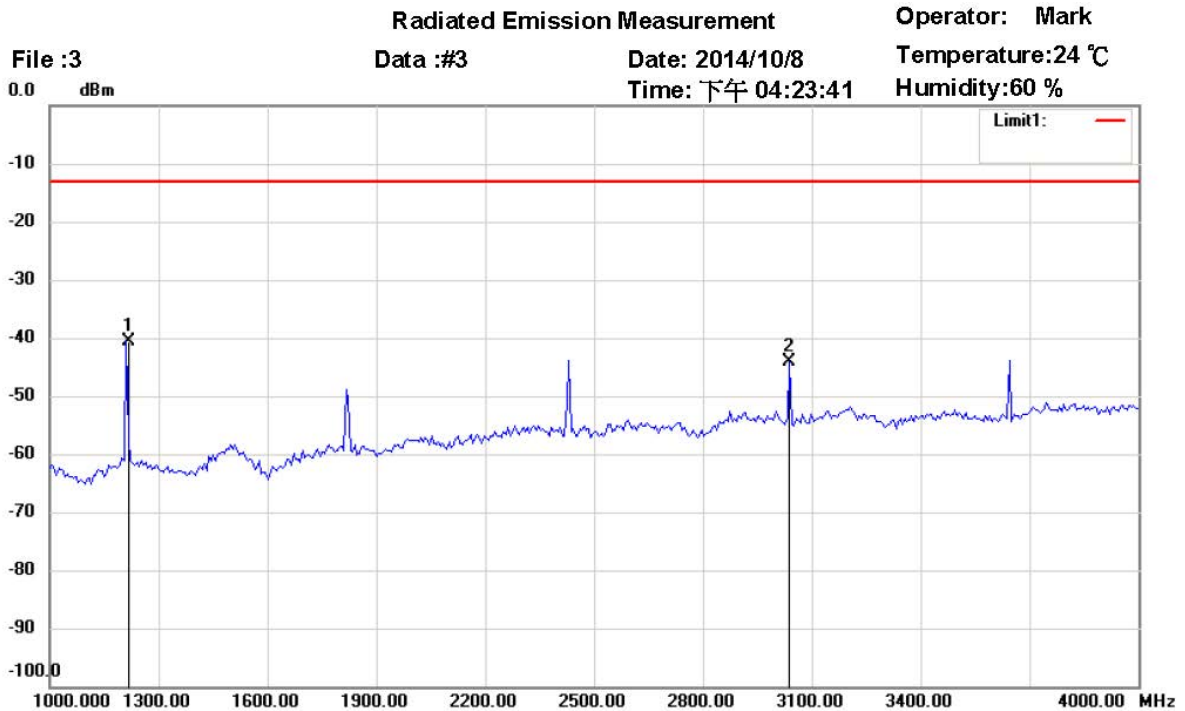

Site : Chamber
 Condition : FCC 74.861 spurious emission
 EUT : W6M21409-14515
 M/N: UF-16
 Test Mode : 607.225MHz
 Note :

Polarization: *Vertical*
 Power : 3V d.c.
 Distance: 3m

Mk.	Frequency (MHz)	Reading (dBm)	Detector	Corr. factor (dB)	Result (dBm)	Limit (dBm)	Ant.Pos (cm)	Tab.Pos (deg.)	Margin (dB)	Comment
*	1210.421	-43.19	peak	2.47	-40.72	-13.00	150	150	-27.72	
	3038.076	-53.38	peak	9.17	-44.21	-13.00	150	250	-31.21	

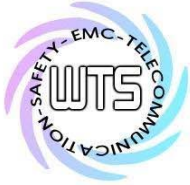

Worldwide Testing Services(Taiwan) Co., Ltd.

Registration number: W6M21409-14515-C-1
 FCC ID: JEBUF-16HE

Radiated Emission Measurement

Operator: Mark

File :3

Data :#2

Date: 2014/10/8

Temperature:24 °C

Time: 下午 04:05:42

Humidity:60 %

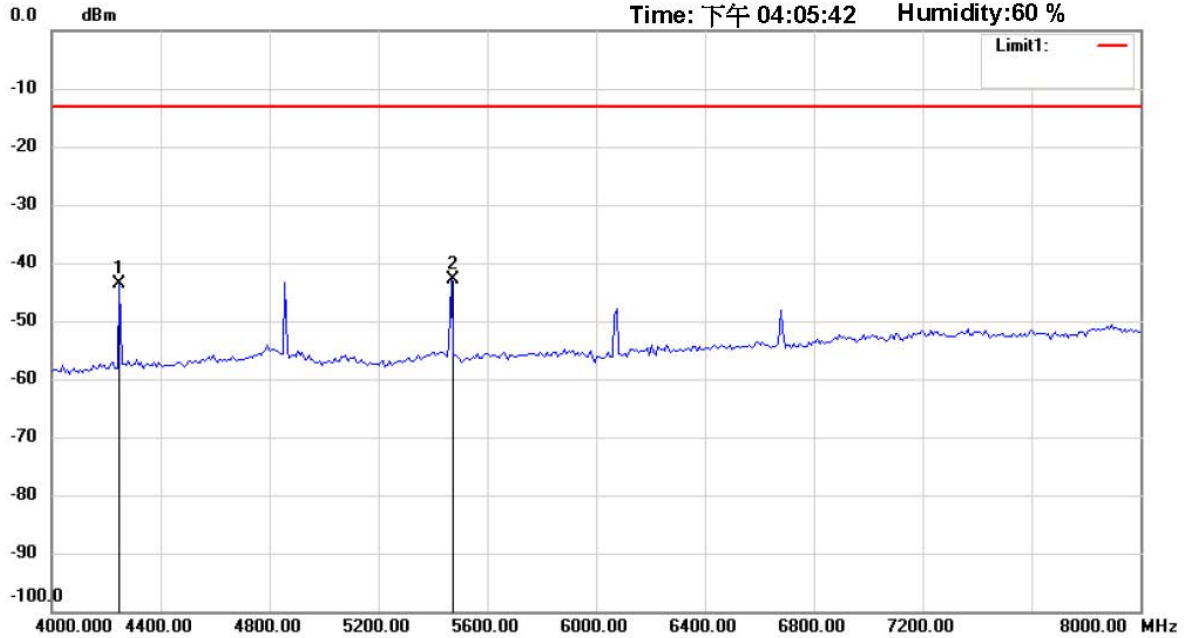

Site : Chamber

Condition : FCC 74.861 spurious emission

Polarization: *Horizontal*

EUT : W6M21409-14515

Power : 3V d.c.

M/N: UF-16

Distance: 3m

Test Mode : 607.225MHz

Note :

Mk.	Frequency (MHz)	Reading (dBm)	Detector	Corr. factor (dB)	Result (dBm)	Limit (dBm)	Ant.Pos (cm)	Tab.Pos (deg.)	Margin (dB)	Comment
	4248.497	-52.99	peak	9.27	-43.72	-13.00	150	100	-30.72	
*	5466.934	-55.18	peak	12.36	-42.82	-13.00	150	250	-29.82	

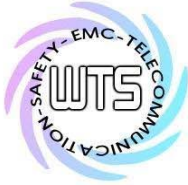

Worldwide Testing Services(Taiwan) Co., Ltd.

Registration number: W6M21409-14515-C-1
 FCC ID: JEBUF-16HE

Radiated Emission Measurement

Operator: Mark

File :3

Data :#4

Date: 2014/10/8

Temperature:24 °C

Time: 下午 04:38:35

Humidity:60 %

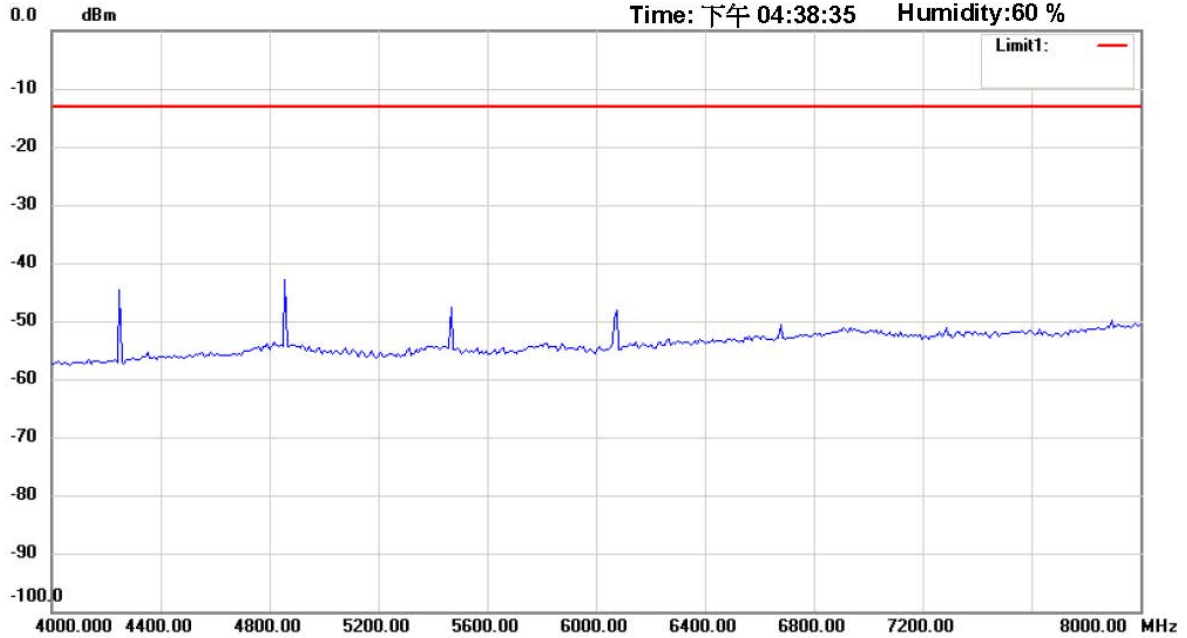

Site : Chamber

Condition : FCC 74.861 spurious emission

Polarization: *Vertical*

EUT : W6M21409-14515

Power : 3V d.c.

M/N: UF-16

Distance: 3m

Test Mode : 607.225MHz

Note :

Mk.	Frequency (MHz)	Reading (dBm)	Detector	Corr. factor (dB)	Result (dBm)	Limit (dBm)	Ant.Pos (cm)	Tab.Pos (deg.)	Margin (dB)	Comment
-----	-----------------	---------------	----------	-------------------	--------------	-------------	--------------	----------------	-------------	---------

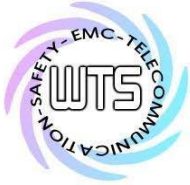

Worldwide Testing Services(Taiwan) Co., Ltd.

Registration number: W6M21409-14515-C-1
 FCC ID: JEBUF-16HE

Radiated Emission Measurement

Operator: Mark

File :1

Data :#1

Date: 2014/10/7

Temperature:24 °C

Time: 下午 01:24:14

Humidity:60 %

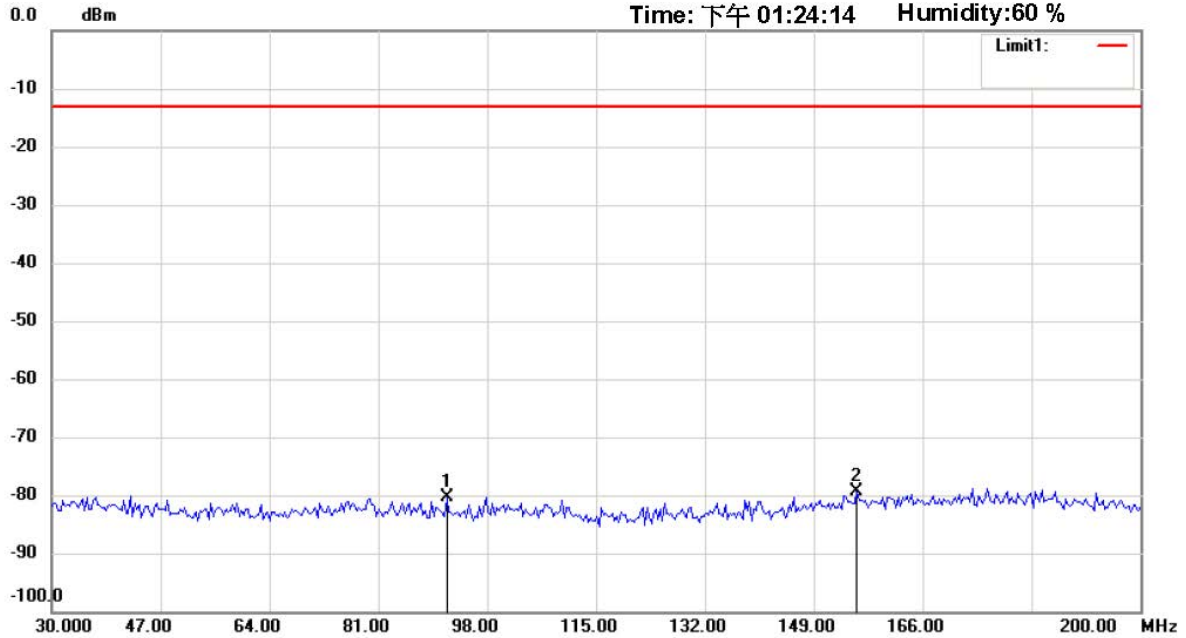

Site : Chamber

Condition : FCC 74.861 spurious emission

Polarization: *Horizontal*

EUT : W6M21409-14515

Power : 3V d.c.

M/N: UF-16

Distance: 3m

Test Mode : 615.025MHz

Note :

Mk.	Frequency (MHz)	Reading (dBm)	Detector	Corr. factor (dB)	Result (dBm)	Limit (dBm)	Ant.Pos (cm)	Tab.Pos (deg.)	Margin (dB)	Comment
	91.6633	-103.24	peak	22.96	-80.28	-13.00	150	120	-67.28	
*	155.7114	-103.74	peak	24.29	-79.45	-13.00	150	100	-66.45	

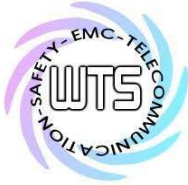

Worldwide Testing Services(Taiwan) Co., Ltd.

Registration number: W6M21409-14515-C-1
 FCC ID: JEBUF-16HE

Radiated Emission Measurement

Operator: Mark

File :1

Data :#2

Date: 2014/10/7

Temperature:24 °C

Time: 下午 01:26:42

Humidity:60 %

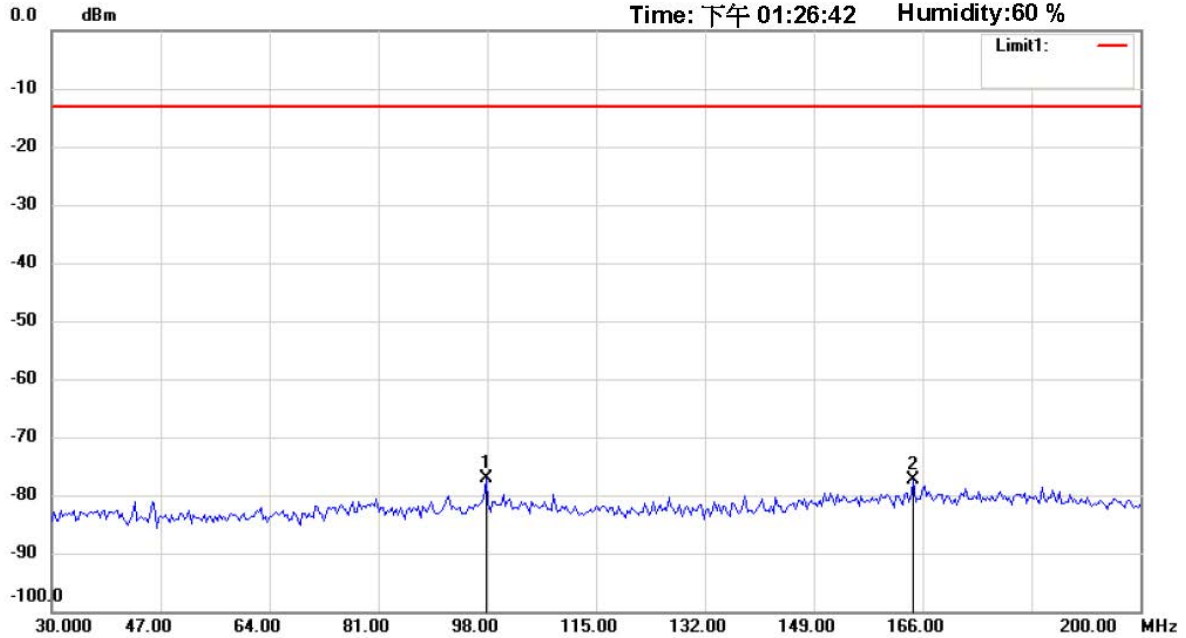

Site : Chamber

Condition : FCC 74.861 spurious emission

Polarization: *Vertical*

EUT : W6M21409-14515

Power : 3V d.c.

M/N: UF-16

Distance: 3m

Test Mode : 615.025MHz

Note :

Mk.	Frequency (MHz)	Reading (dBm)	Detector	Corr. factor (dB)	Result (dBm)	Limit (dBm)	Ant.Pos (cm)	Tab.Pos (deg.)	Margin (dB)	Comment
*	97.7956	-101.35	peak	24.31	-77.04	-13.00	150	100	-64.04	
	164.5691	-102.57	peak	25.29	-77.28	-13.00	150	200	-64.28	

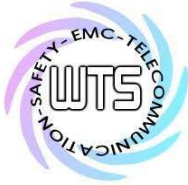

Worldwide Testing Services(Taiwan) Co., Ltd.

Registration number: W6M21409-14515-C-1
 FCC ID: JEBUF-16HE

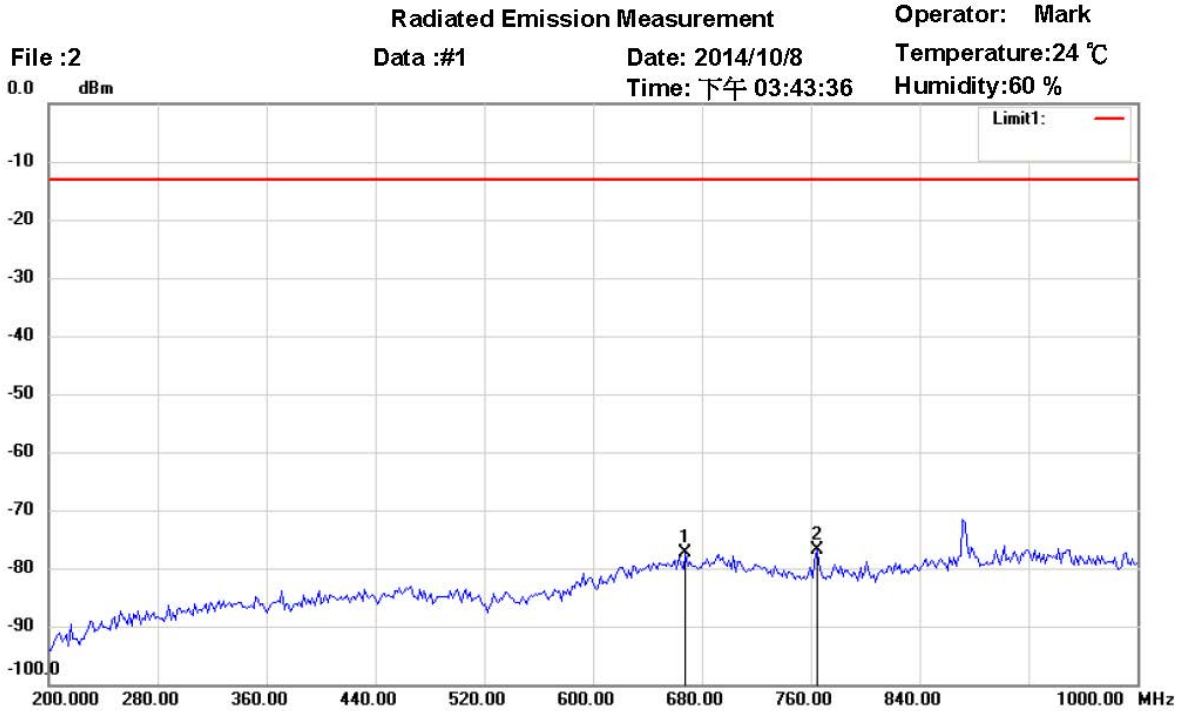

Site : Chamber
 Condition : FCC 74.861 spurious emission
 EUT : W6M21409-14515
 M/N: UF-16
 Test Mode : 615.025MHz
 Note :

Polarization: *Horizontal*
 Power : 3V d.c.
 Distance: 3m

Mk.	Frequency (MHz)	Reading (dBm)	Detector	Corr. factor (dB)	Result (dBm)	Limit (dBm)	Ant.Pos (cm)	Tab.Pos (deg.)	Margin (dB)	Comment
	668.1362	-76.97	peak	-0.38	-77.35	-13.00	150	150	-64.35	
*	764.3287	-74.05	peak	-2.70	-76.75	-13.00	150	210	-63.75	



Worldwide Testing Services(Taiwan) Co., Ltd.

Registration number: W6M21409-14515-C-1
 FCC ID: JEBUF-16HE

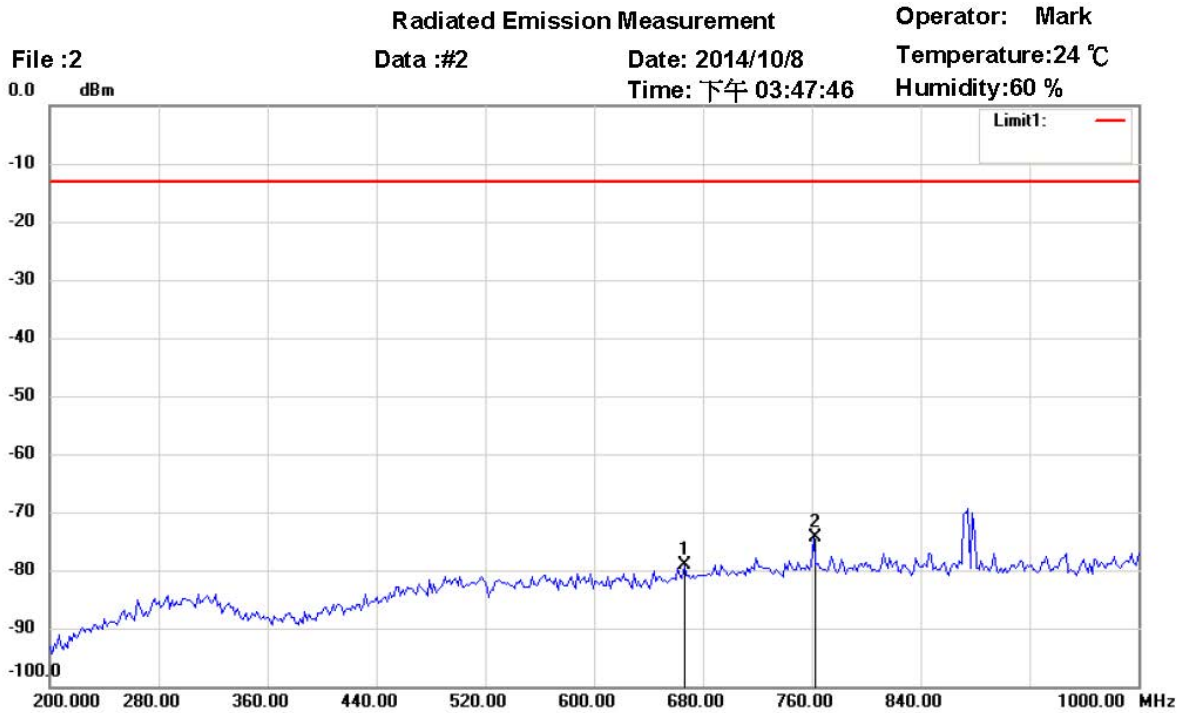

Site : Chamber
 Condition : FCC 74.861 spurious emission
 EUT : W6M21409-14515
 M/N: UF-16
 Test Mode : 615.025MHz
 Note :

Polarization: *Vertical*
 Power : 3V d.c.
 Distance: 3m

Mk.	Frequency (MHz)	Reading (dBm)	Detector	Corr. factor (dB)	Result (dBm)	Limit (dBm)	Ant.Pos (cm)	Tab.Pos (deg.)	Margin (dB)	Comment
	666.5331	-76.74	peak	-2.49	-79.23	-13.00	150	10	-66.23	
*	761.1223	-73.09	peak	-1.36	-74.45	-13.00	150	210	-61.45	



Worldwide Testing Services(Taiwan) Co., Ltd.

Registration number: W6M21409-14515-C-1
 FCC ID: JEBUF-16HE

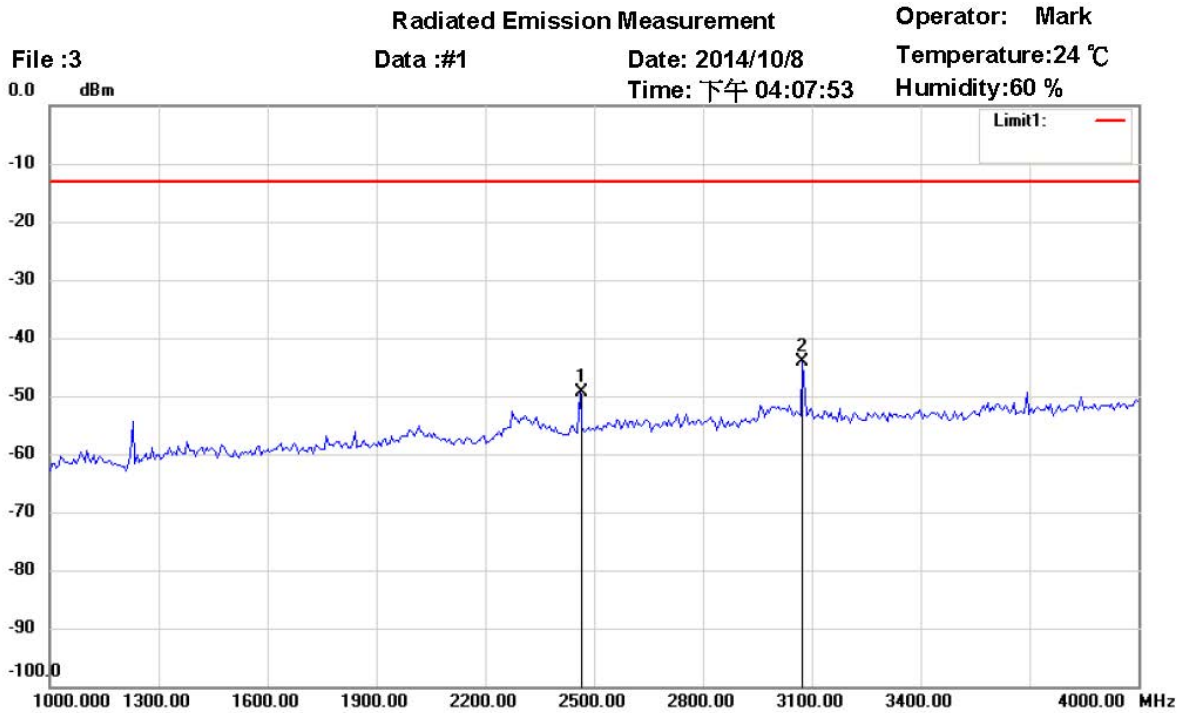

Site : Chamber
 Condition : FCC 74.861 spurious emission
 EUT : W6M21409-14515
 M/N: UF-16
 Test Mode : 615.025MHz
 Note :

Polarization: *Horizontal*
 Power : 3V d.c.
 Distance: 3m

Mk.	Frequency (MHz)	Reading (dBm)	Detector	Corr. factor (dB)	Result (dBm)	Limit (dBm)	Ant.Pos (cm)	Tab.Pos (deg.)	Margin (dB)	Comment
	2460.922	-55.70	peak	6.33	-49.37	-13.00	150	170	-36.37	
*	3074.148	-53.71	peak	9.67	-44.04	-13.00	150	270	-31.04	



Worldwide Testing Services(Taiwan) Co., Ltd.

Registration number: W6M21409-14515-C-1
 FCC ID: JEBUF-16HE

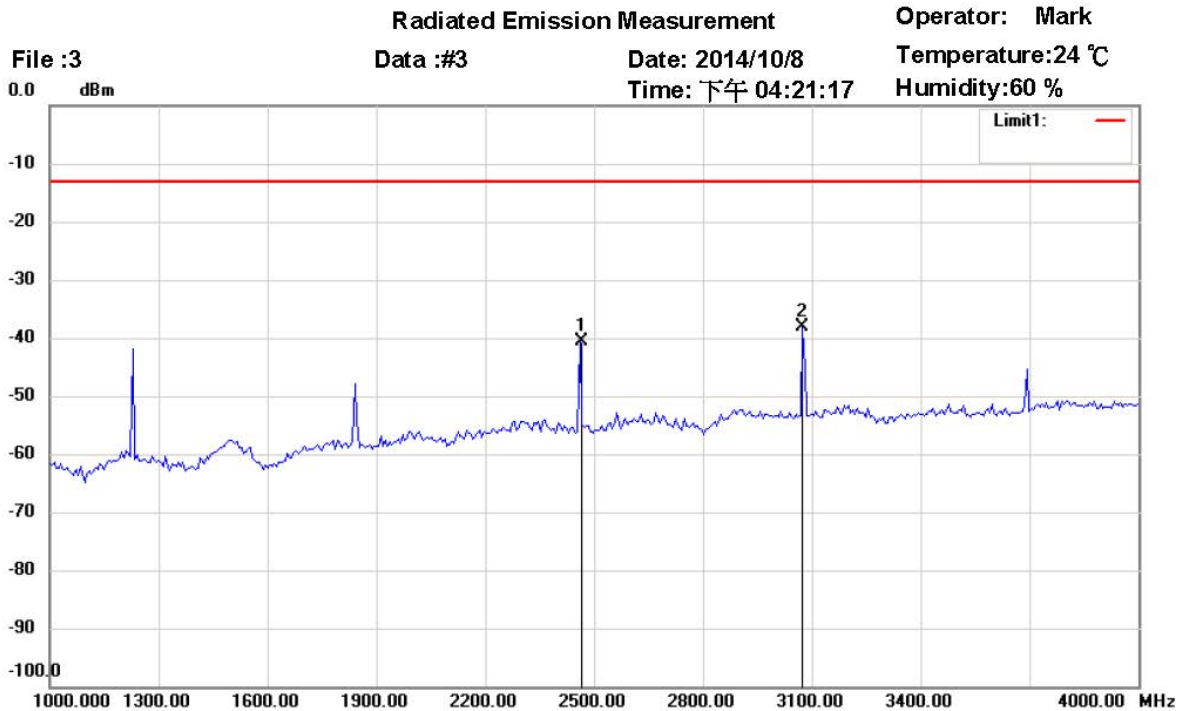

Site : Chamber

Condition : FCC 74.861 spurious emission

EUT : W6M21409-14515

M/N: UF-16

Test Mode : 615.025MHz

Note :

Polarization: *Vertical*

Power : 3V d.c.

Distance: 3m

Mk.	Frequency (MHz)	Reading (dBm)	Detector	Corr. factor (dB)	Result (dBm)	Limit (dBm)	Ant.Pos (cm)	Tab.Pos (deg.)	Margin (dB)	Comment
	2460.922	-47.02	peak	6.42	-40.60	-13.00	150	120	-27.60	
*	3074.148	-47.21	peak	9.17	-38.04	-13.00	150	160	-25.04	