

RISCO

RW232M GSM 5 Band Internal Antenna adding 3dB Attenuator

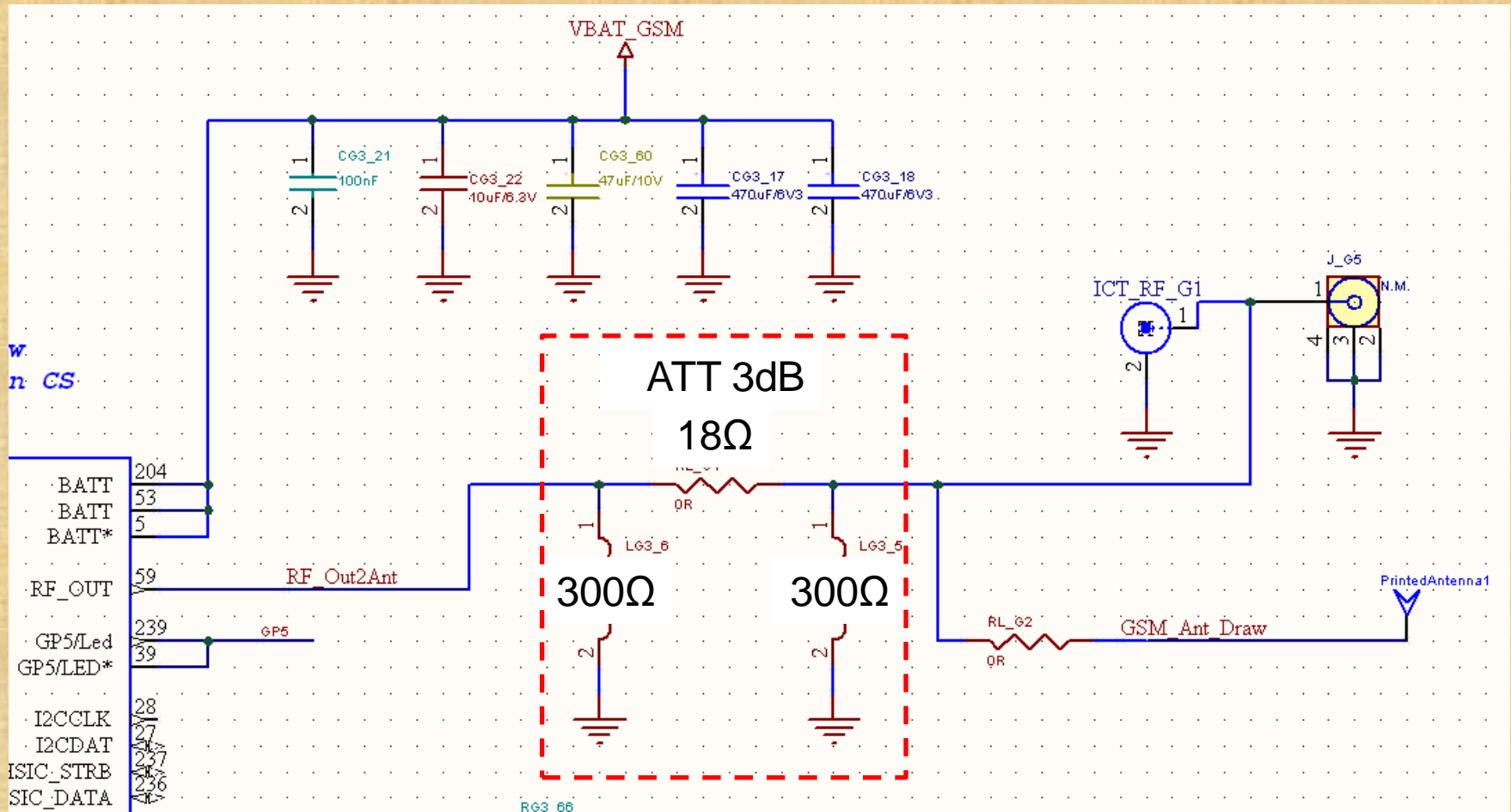

RISCO

RW232M GSM 5 Band Internal Antenna Specification

Internal 5 Band Printed Antenna Specification

Radio Type	GSM
Radio Band	850/900/1800/1900/2170
Frequency (MHz)	824-960, 1710-2170
Low Band Peak Gain max. (dBi)	- 1.25
High Band Peak Gain max. (dBi)	+ 1.98
Polarization	LV & LH
Radiation Pattern	Omni Directional
Antenna Type	Monopole Printed Antenna

RISCO

GSM Antenna Network Analyzer Measurements Return Loss

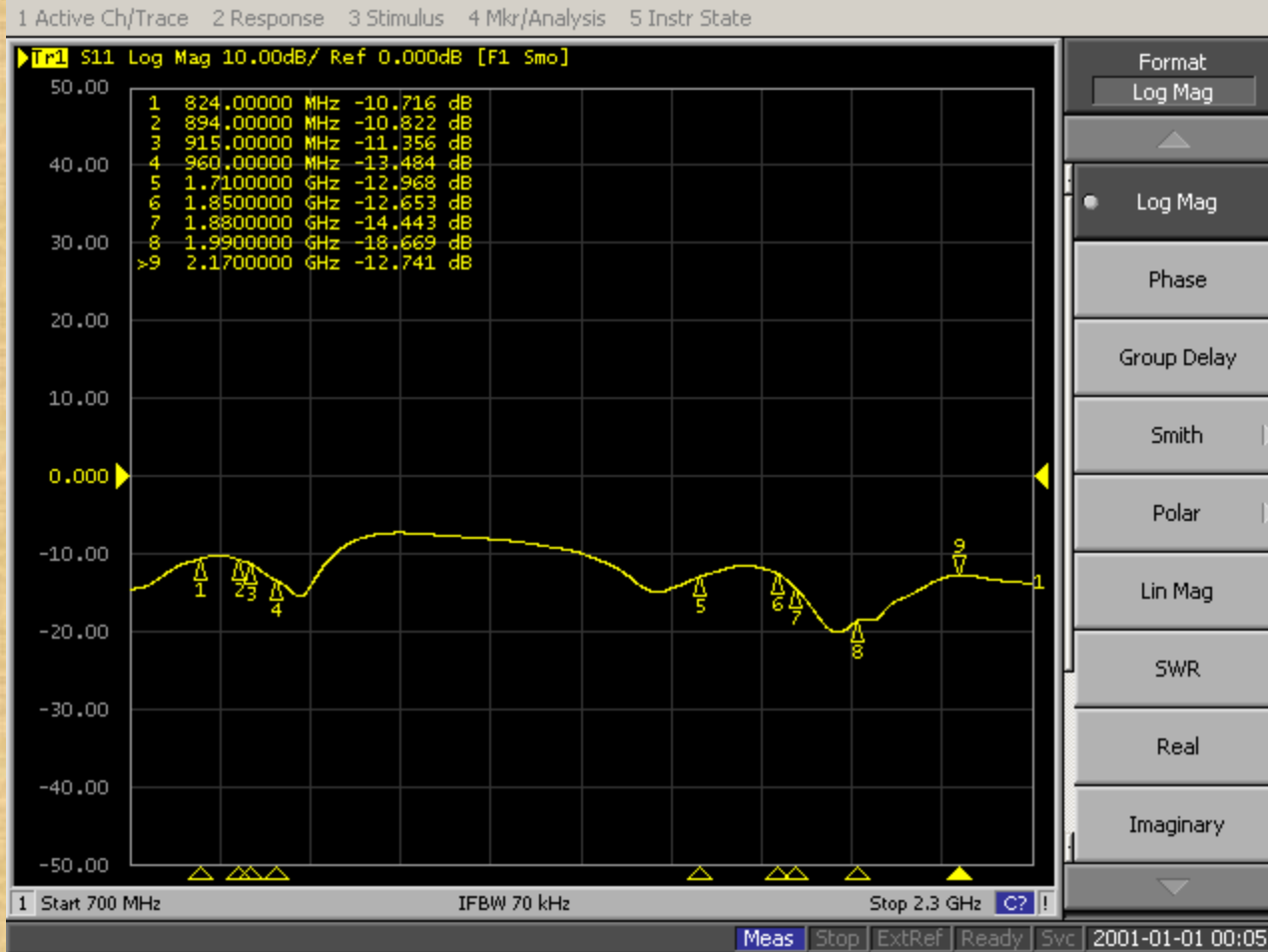

RISCO

GSM Antenna Network Analyzer Measurements VSWR

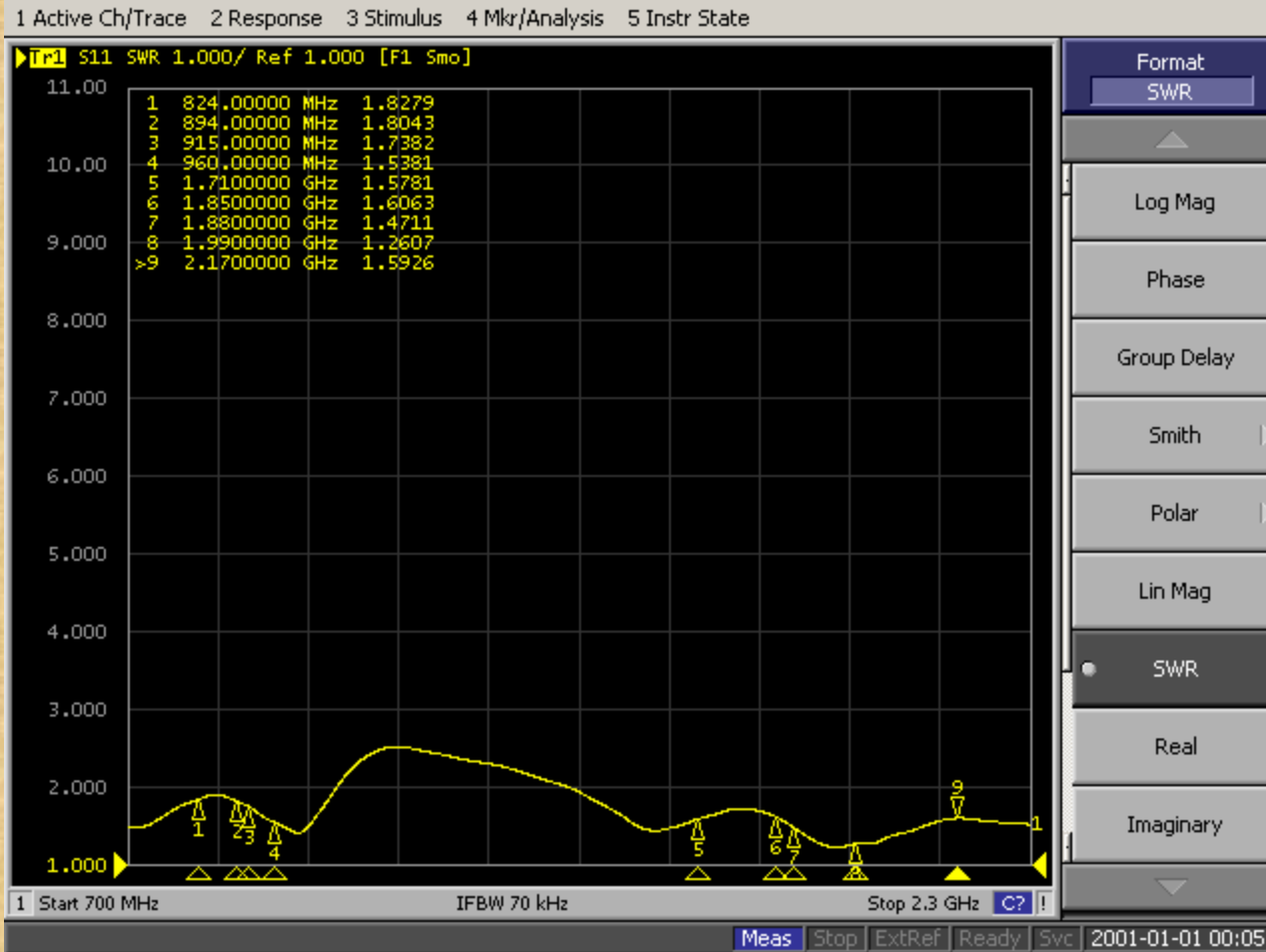

RISCO

GSM Antenna Network Analyzer Measurements Smith Chart

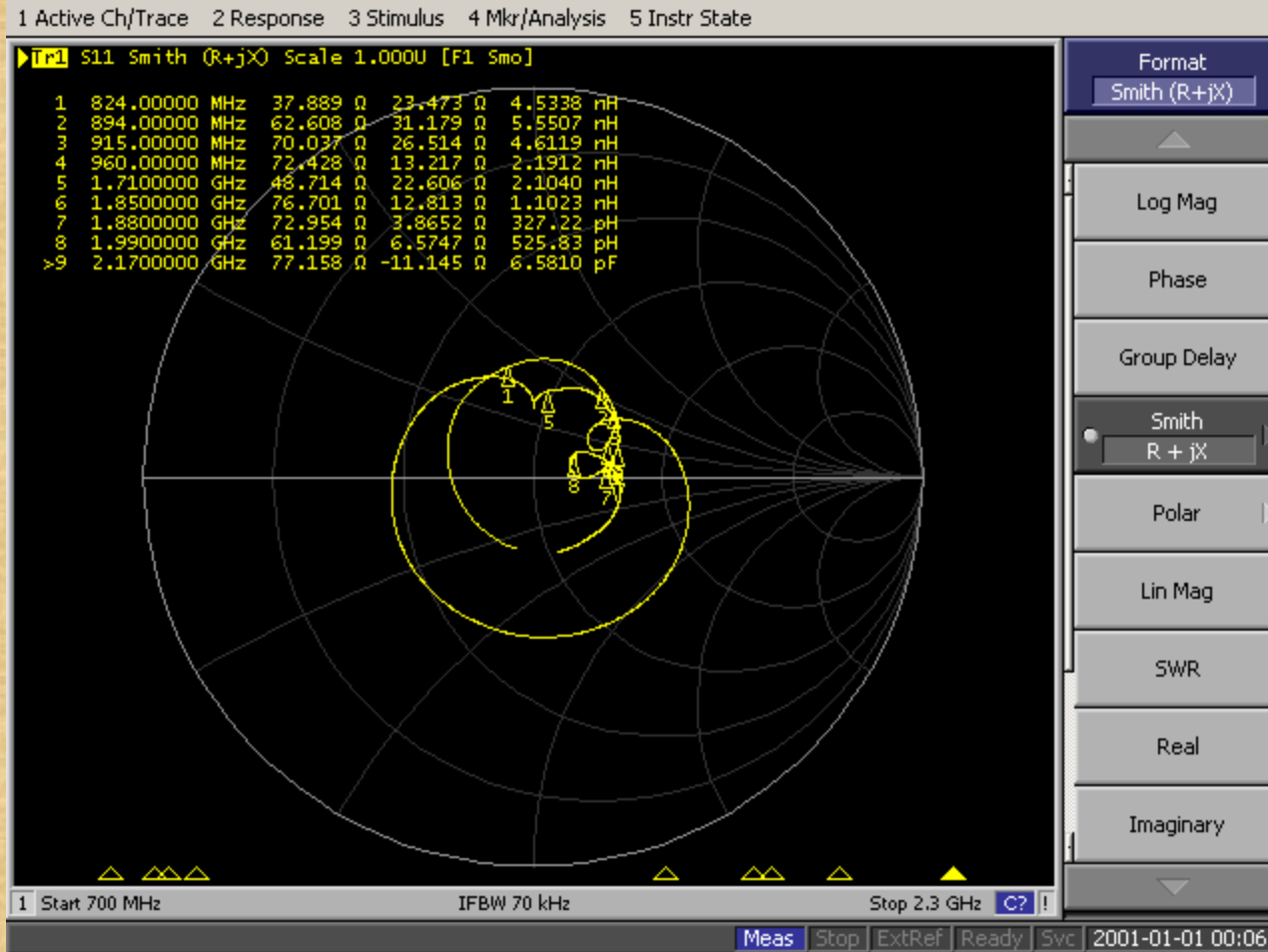

RISCO

GSM Antenna 3D Chamber Measurements



RISCO

GSM Antenna 3D Chamber Test Results

Band Designator	Frequency [MHz]	Ant EFF [%]	Ant EFF [db]	Peak gain [dBi]
AMPS	824	29.78	-5.26	-1.82
AMPS	836	32.07	-4.94	-2.33
AMPS	849	39.12	-4.08	-1.25
AMPS	869	31.16	-5.06	-1.45
AMPS	881	28.20	-5.50	-1.76
AMPS	894	16.64	-7.79	-2.09
GSM	915	26.23	-5.81	-0.94
GSM	925	22.66	-6.45	-1.15
GSM	943	18.69	-7.28	-1.61
GSM	960	23.66	-6.26	-0.78
DCS	1710	39.89	-3.99	1.42
DCS	1748	41.30	-3.84	1.83
DCS	1785	36.87	-4.33	1.30
DCS	1805	39.47	-4.04	1.61
DCS	1843	40.62	-3.91	1.59
PCS	1850	41.61	-3.81	1.75
PCS	1880	42.46	-3.72	1.53
PCS	1910	43.95	-3.57	1.98
PCS	1930	45.26	-3.44	2.03
PCS	1960	48.48	-3.14	2.17
PCS	1990	46.99	-3.28	1.90
UMTS	2110	44.63	-3.50	1.63
UMTS	2140	42.80	-3.69	1.20
UMTS	2170	42.02	-3.77	1.03

FCC

FCC

RISCO

GSM Antenna 3D Chamber Pattern Test Results

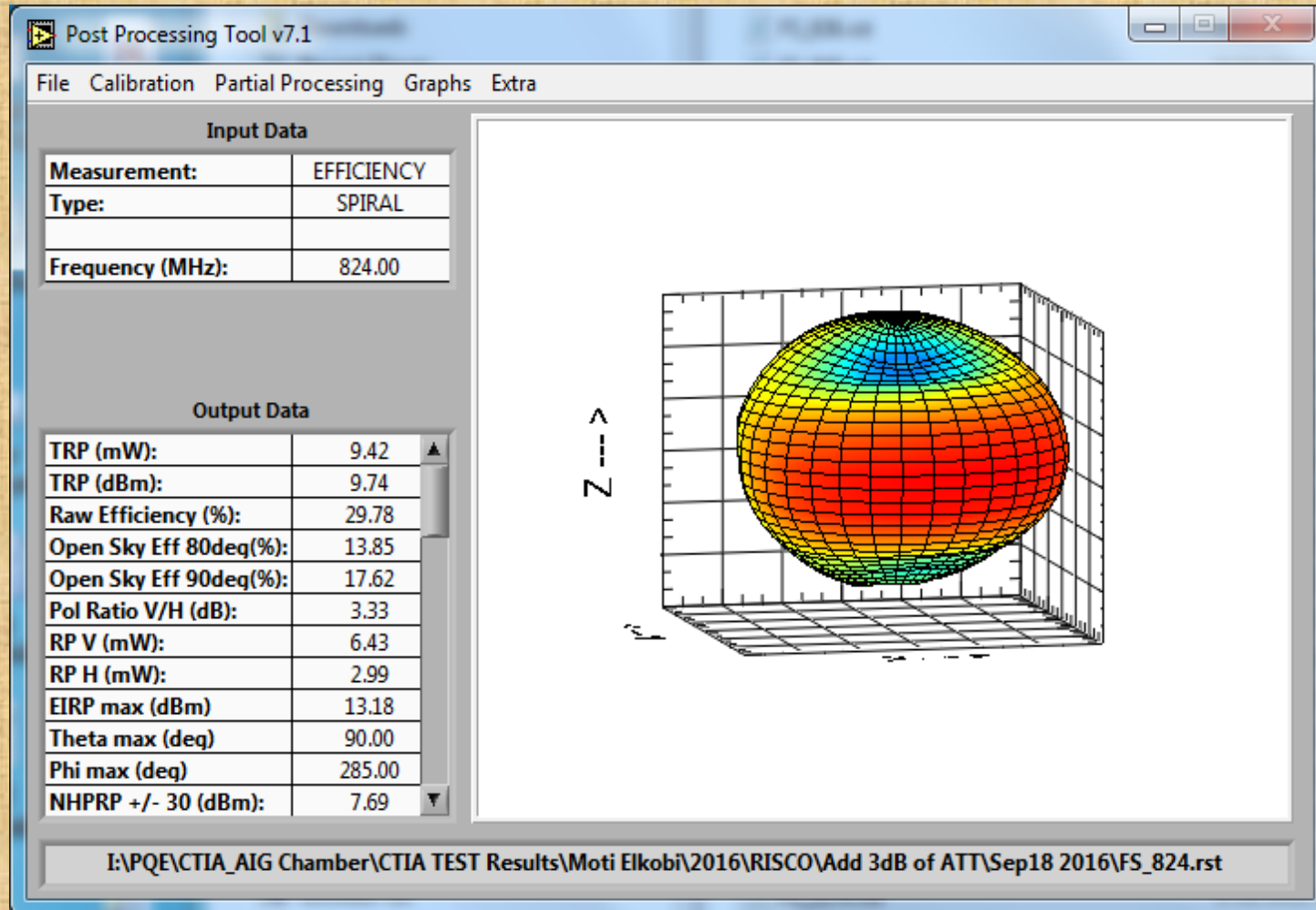

RISCO

GSM Antenna 3D Chamber Pattern Test Results

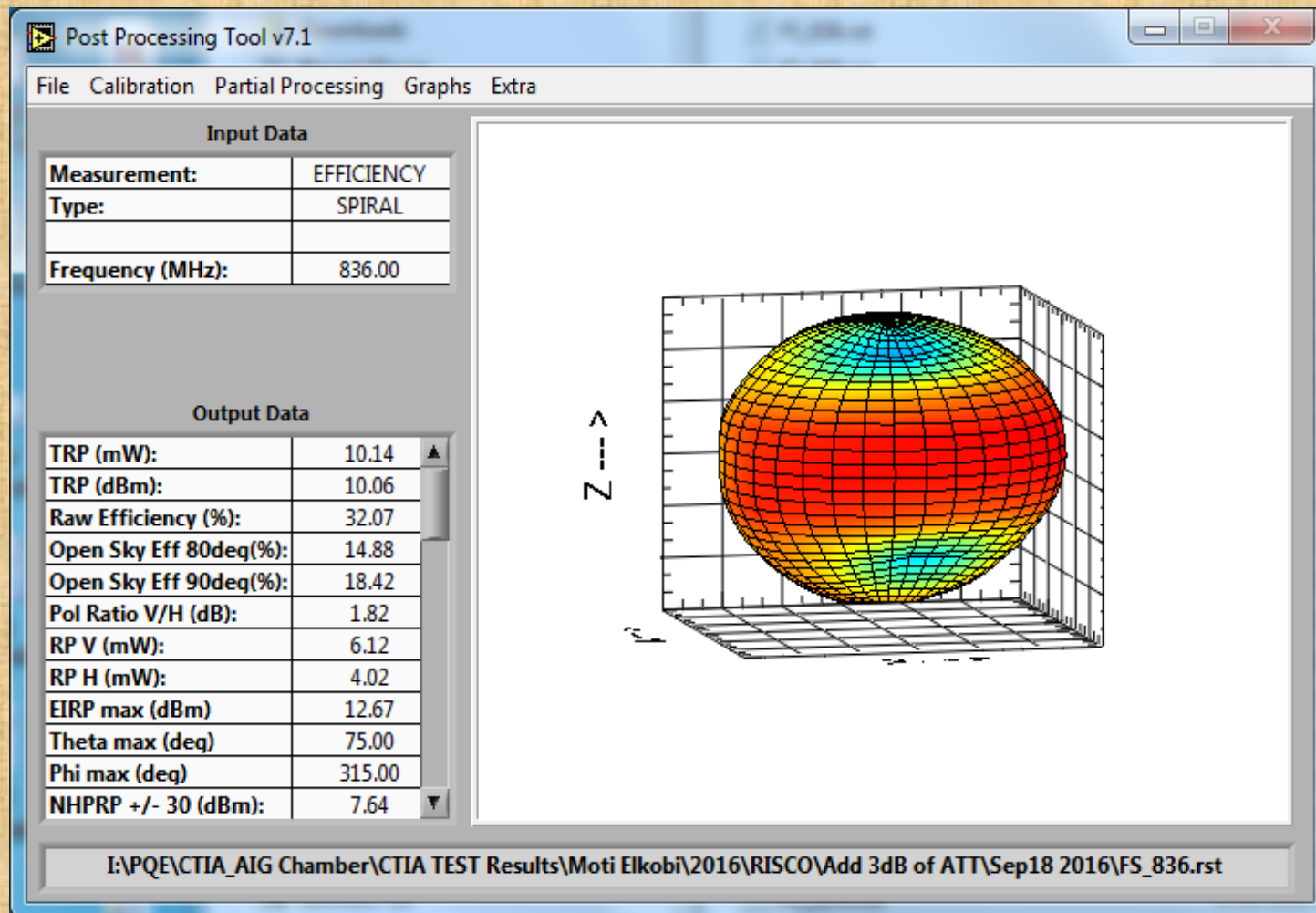

RISCO

GSM Antenna 3D Chamber Pattern Test Results

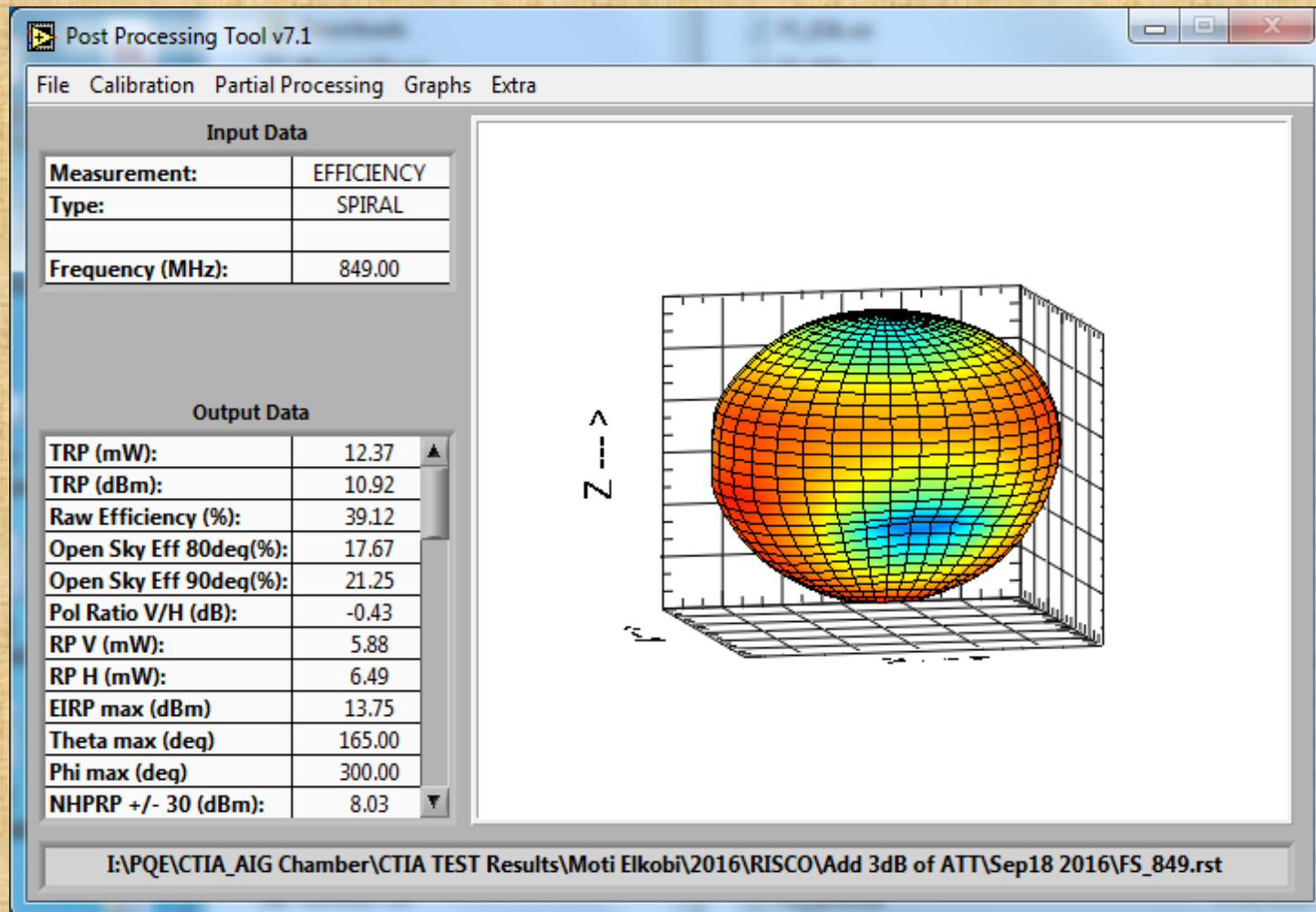

RISCO

GSM Antenna 3D Chamber Pattern Test Results

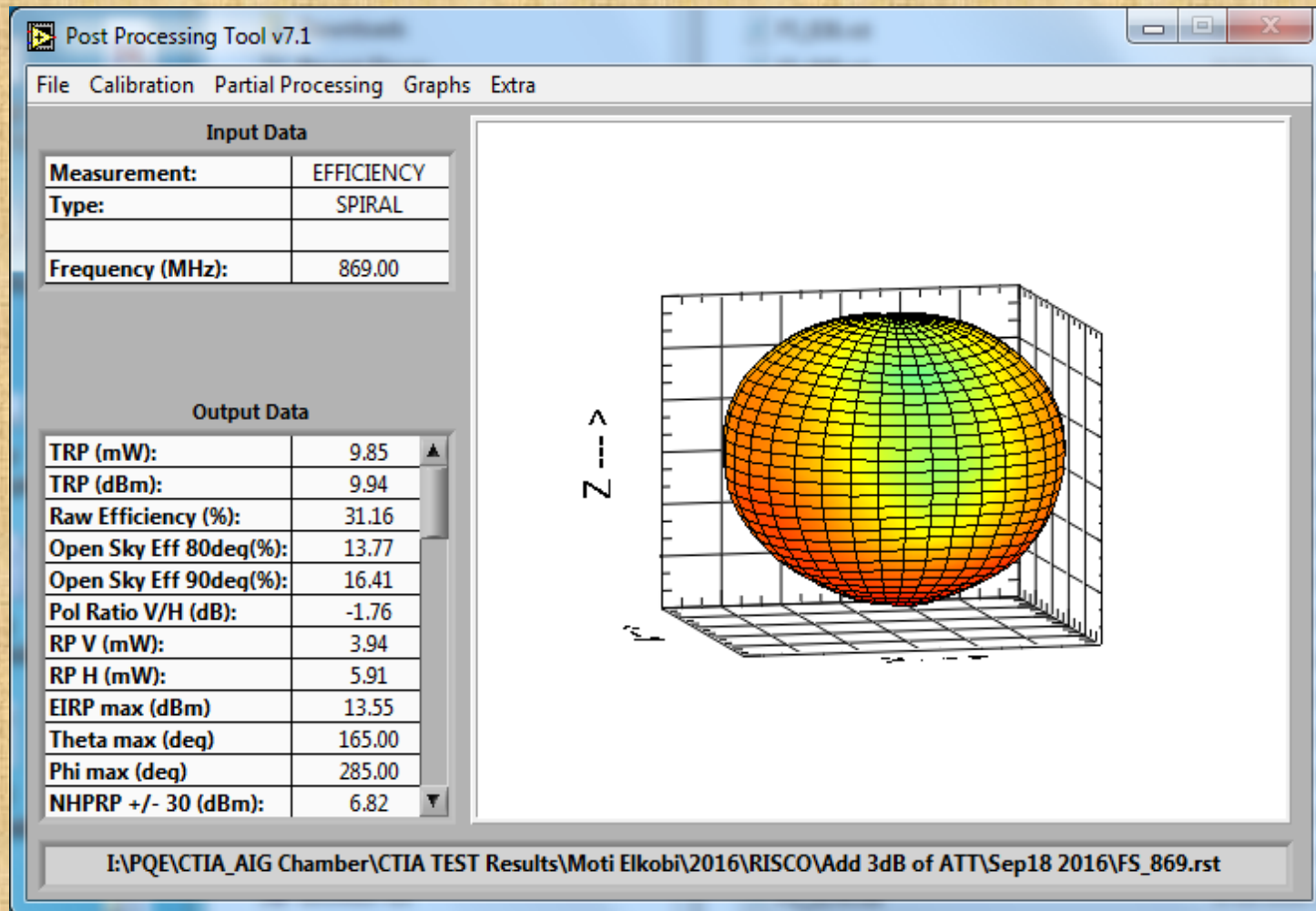

RISCO

GSM Antenna 3D Chamber Pattern Test Results

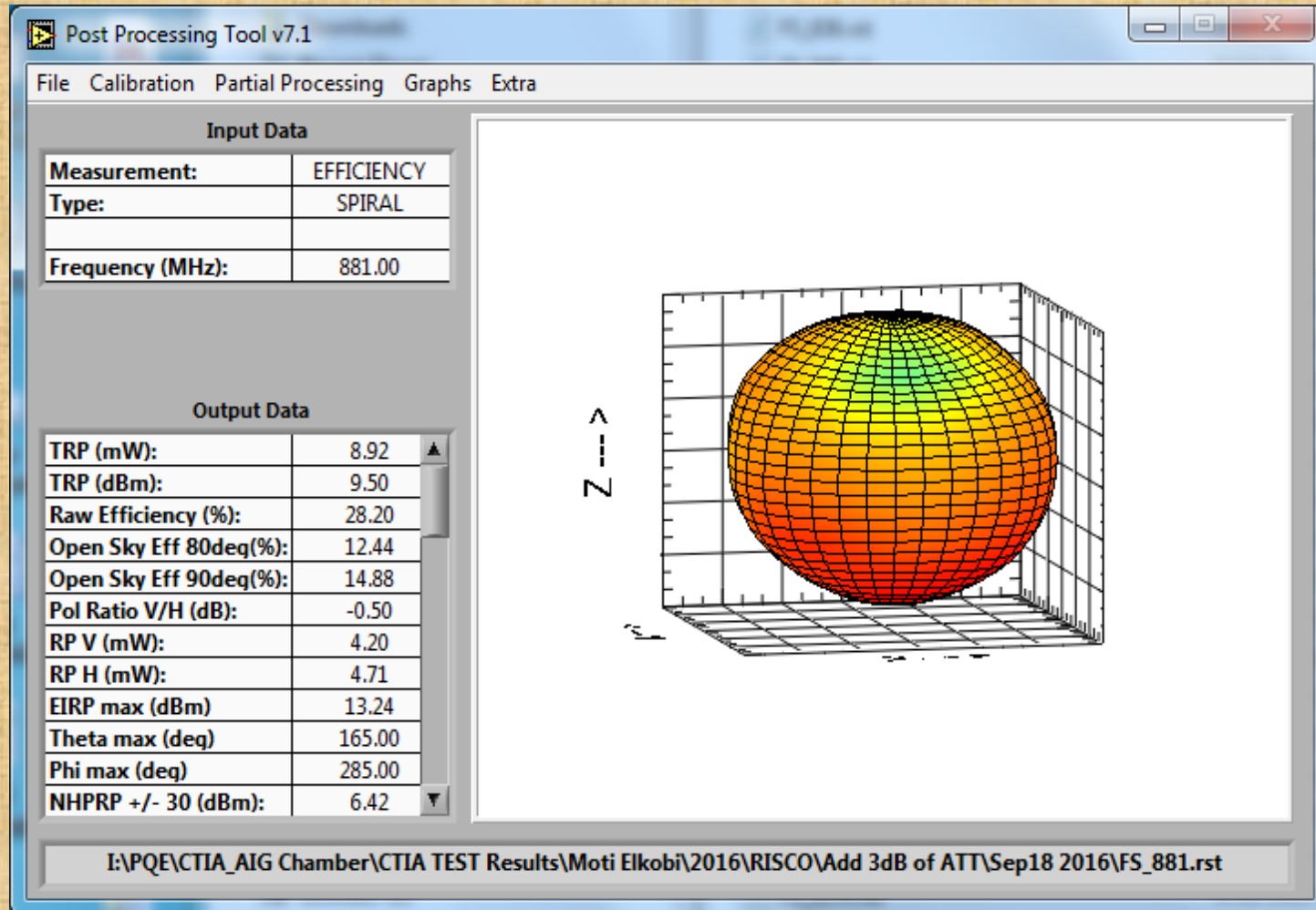

RISCO

GSM Antenna 3D Chamber Pattern Test Results

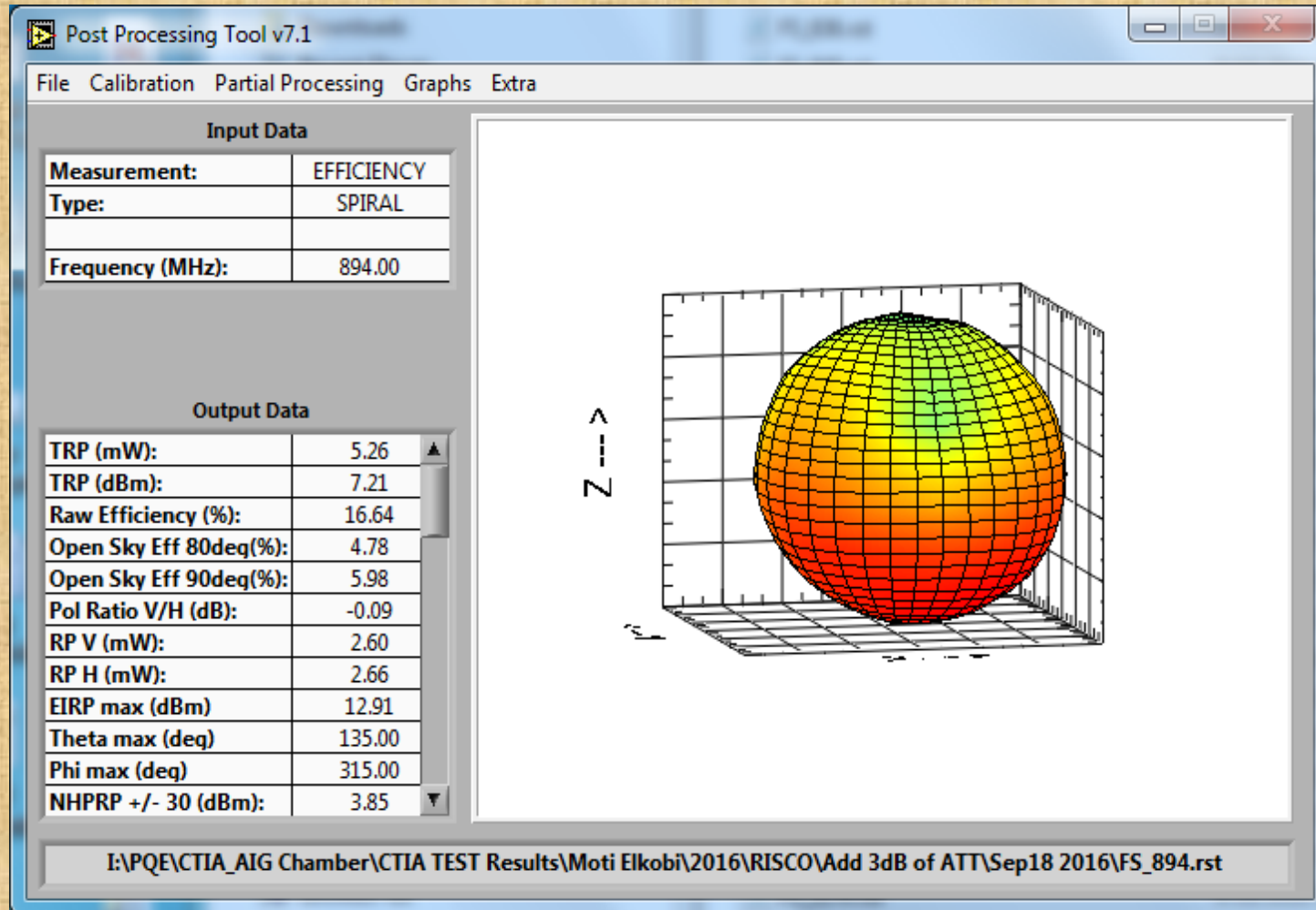

RISCO

GSM Antenna 3D Chamber Pattern Test Results

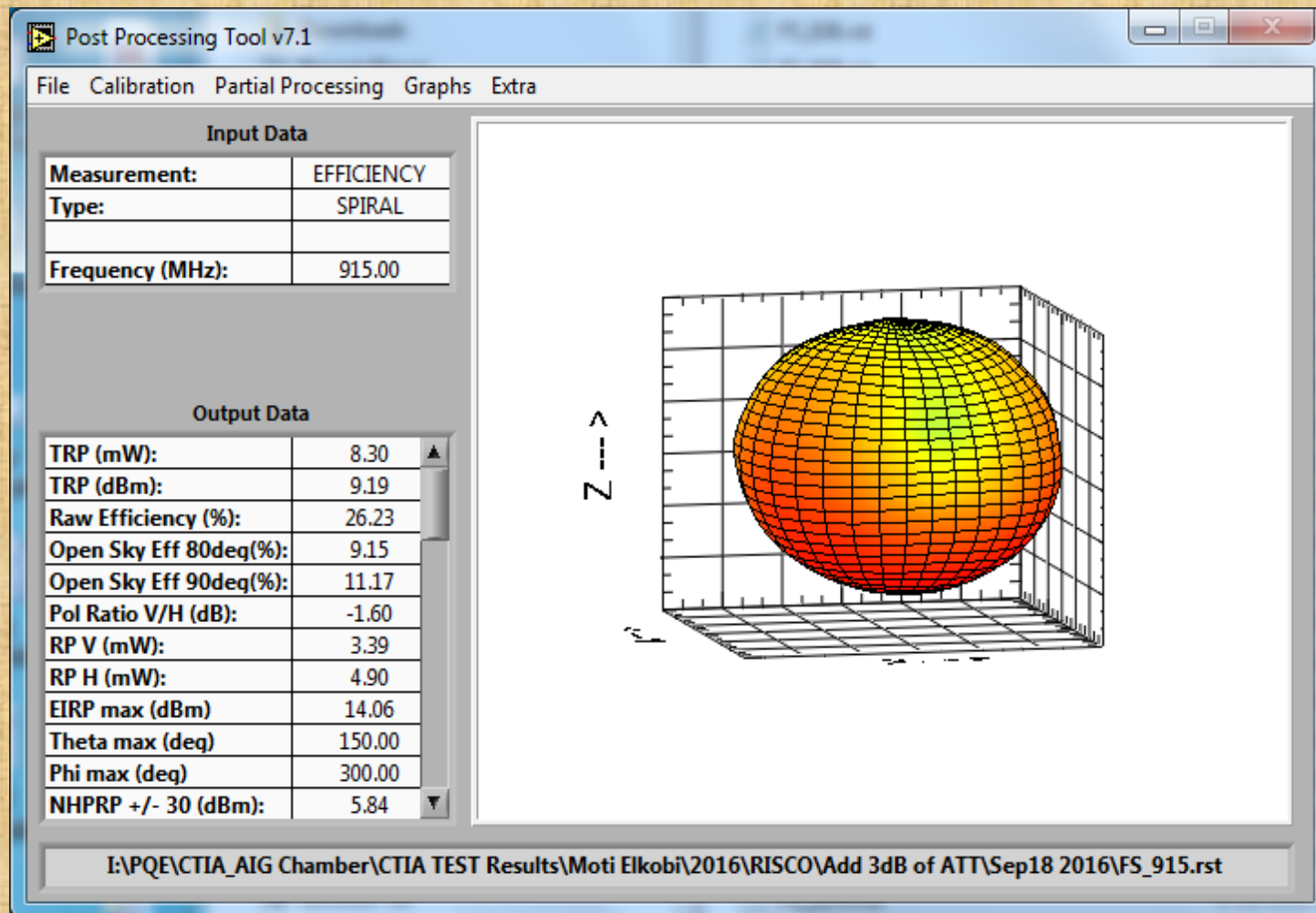

RISCO

GSM Antenna 3D Chamber Pattern Test Results

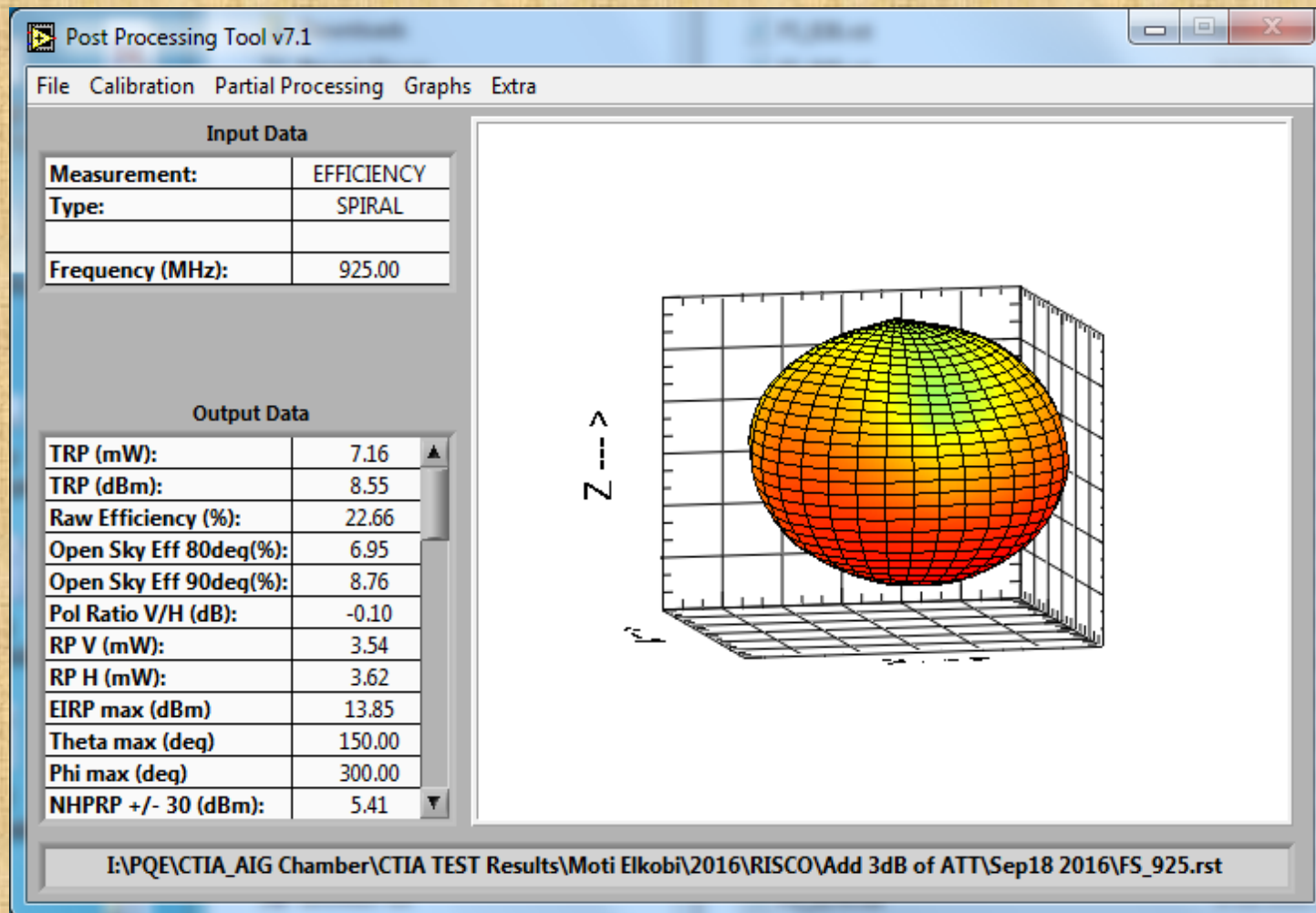

RISCO

GSM Antenna 3D Chamber Pattern Test Results

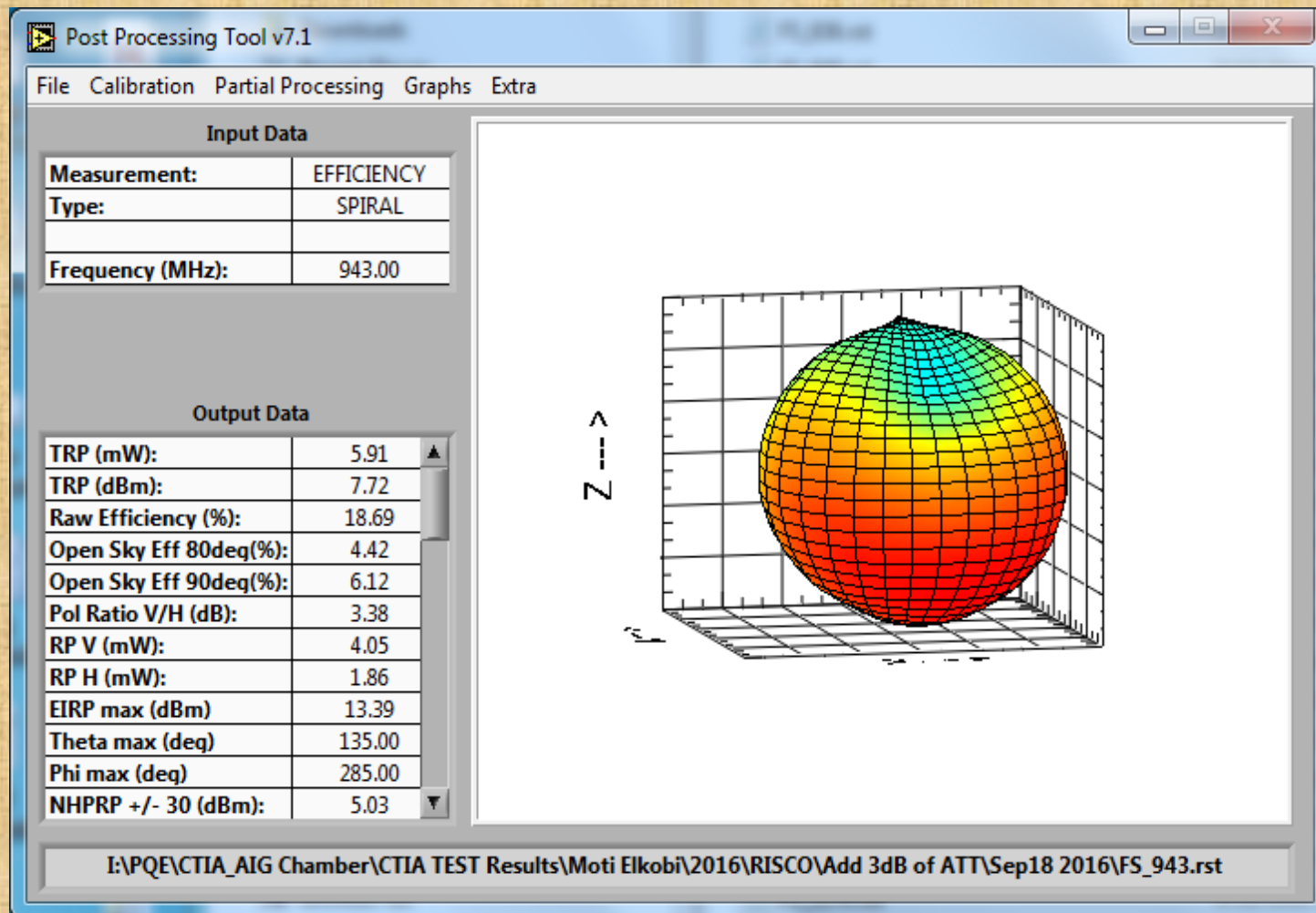

RISCO

GSM Antenna 3D Chamber Pattern Test Results

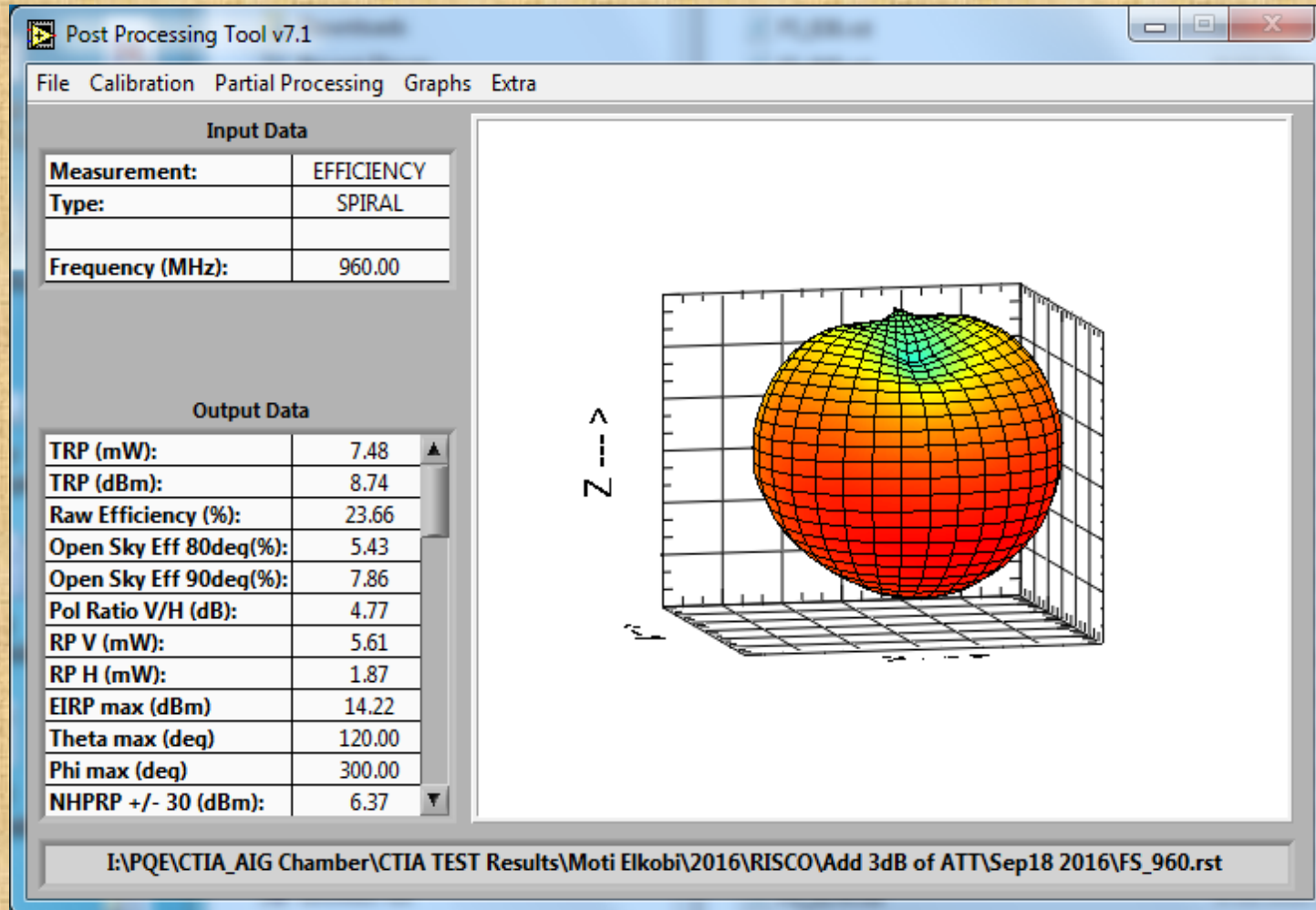

RISCO

GSM Antenna 3D Chamber Pattern Test Results

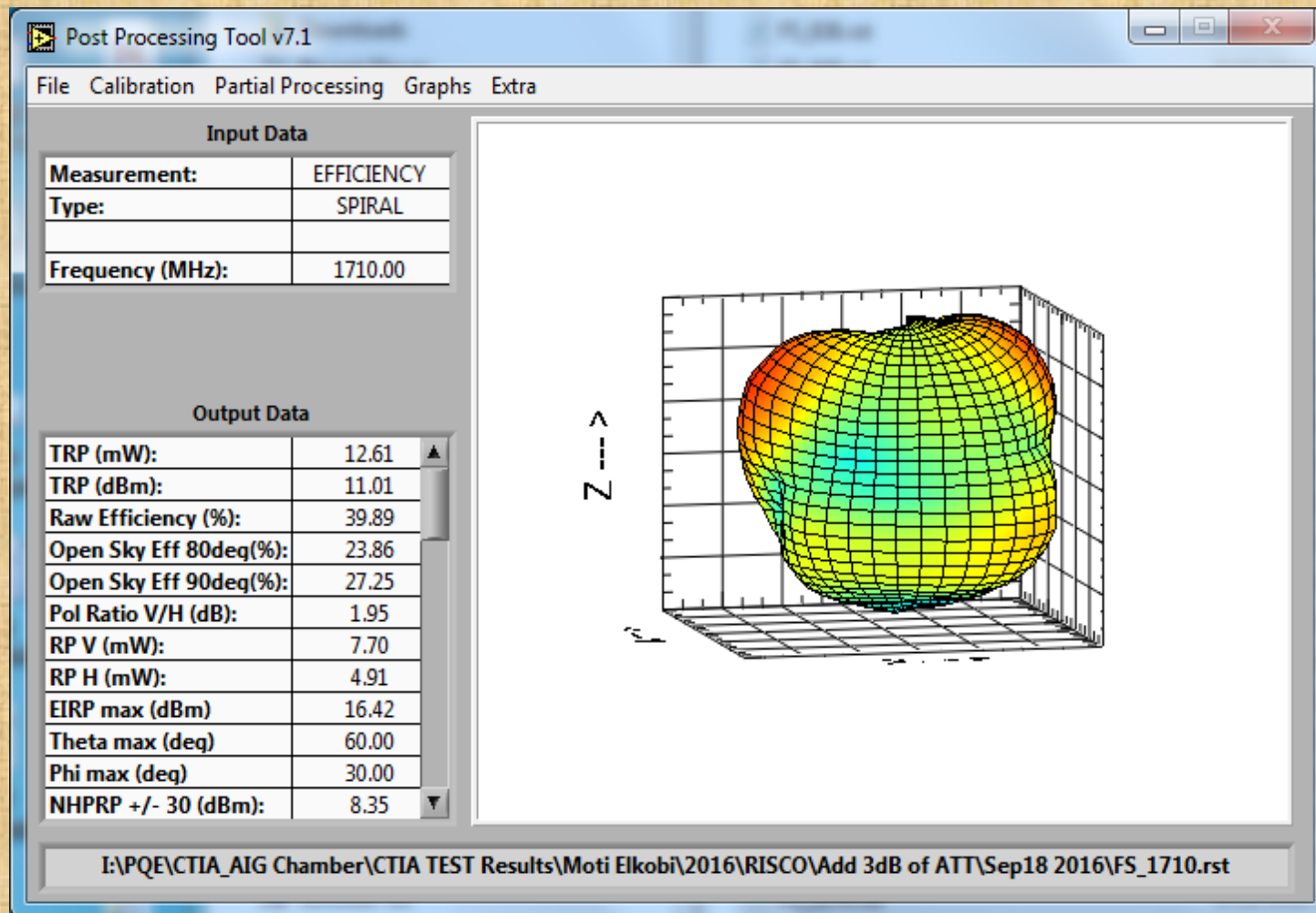

RISCO

GSM Antenna 3D Chamber Pattern Test Results

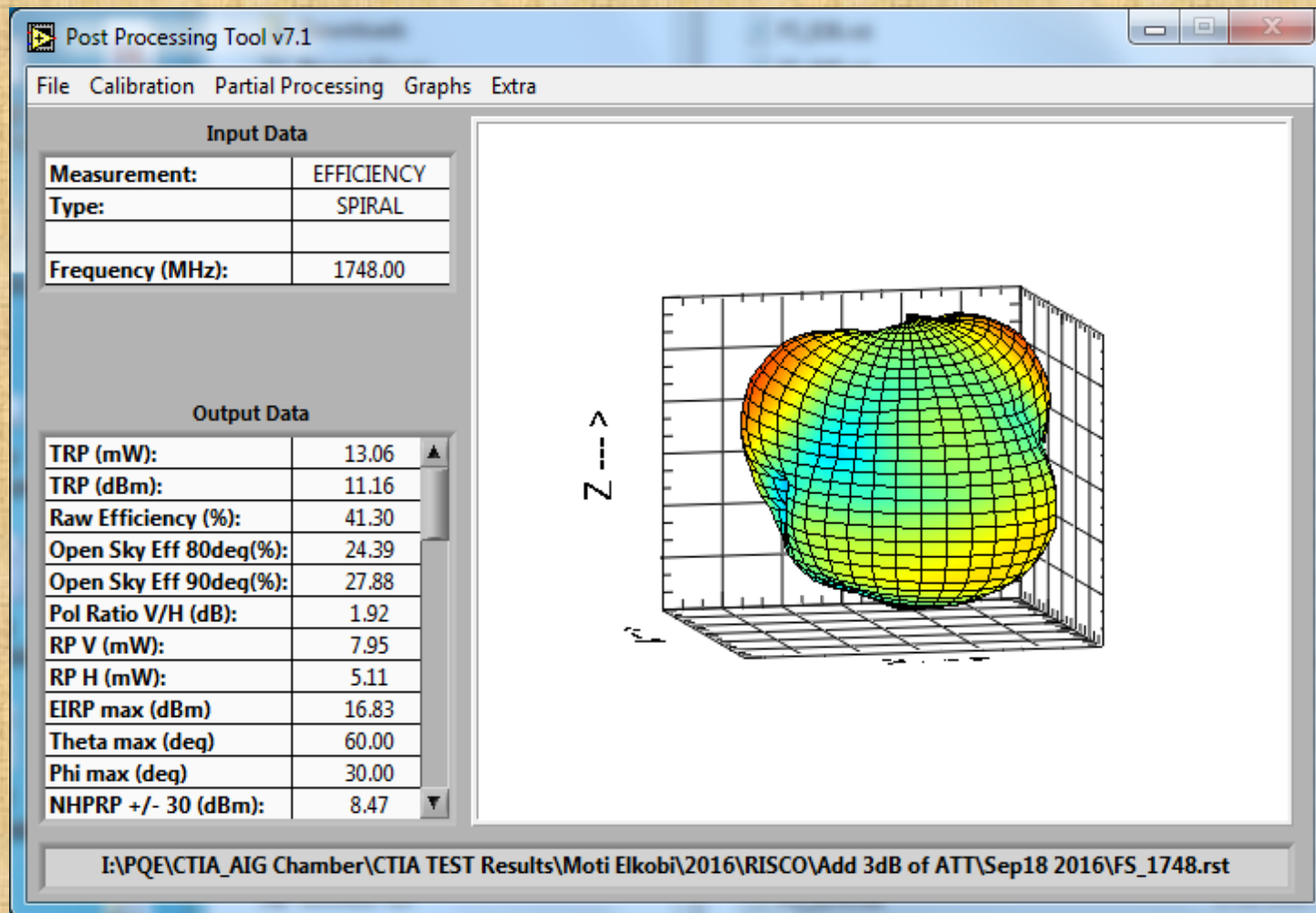

RISCO

GSM Antenna 3D Chamber Pattern Test Results

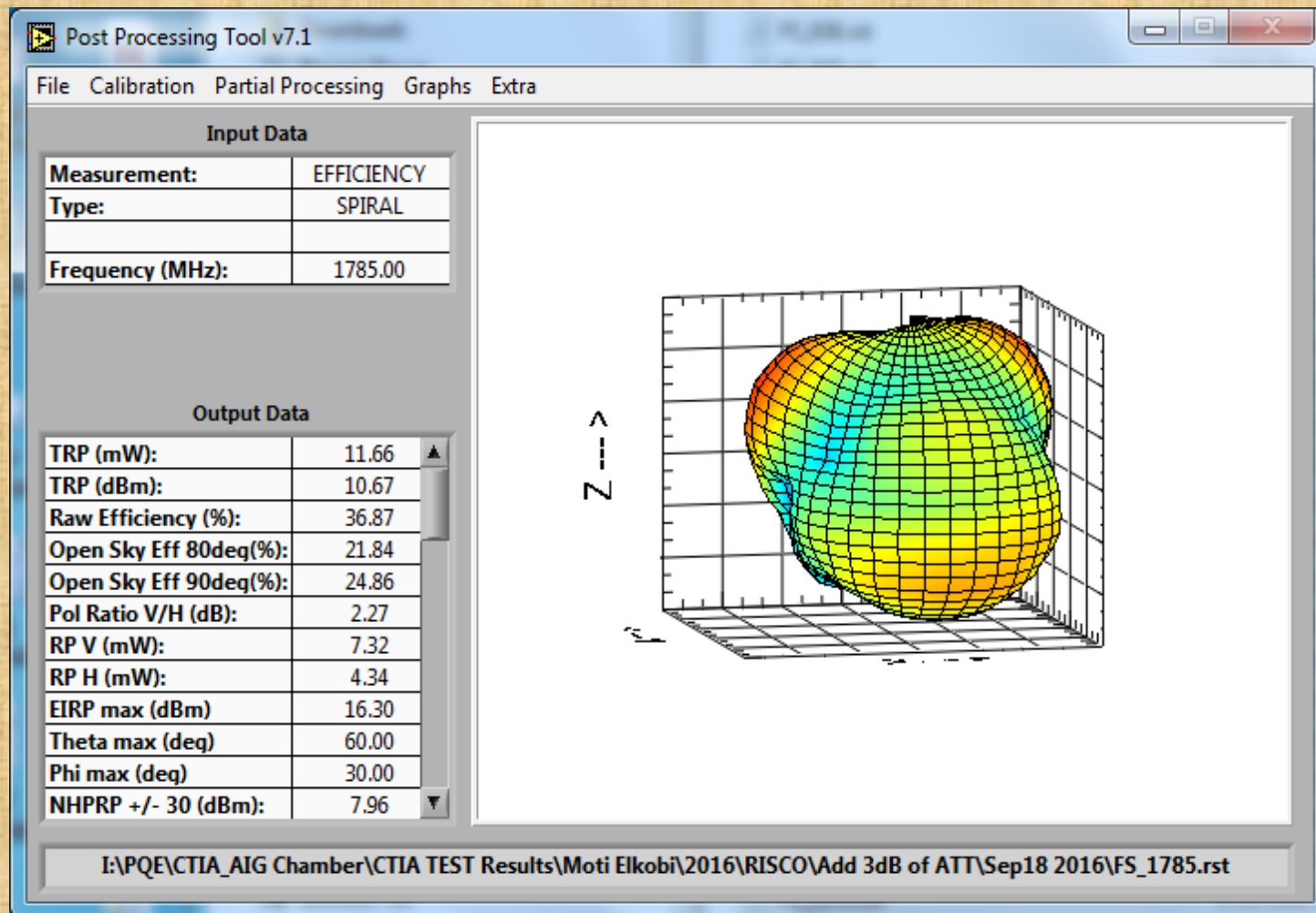

RISCO

GSM Antenna 3D Chamber Pattern Test Results

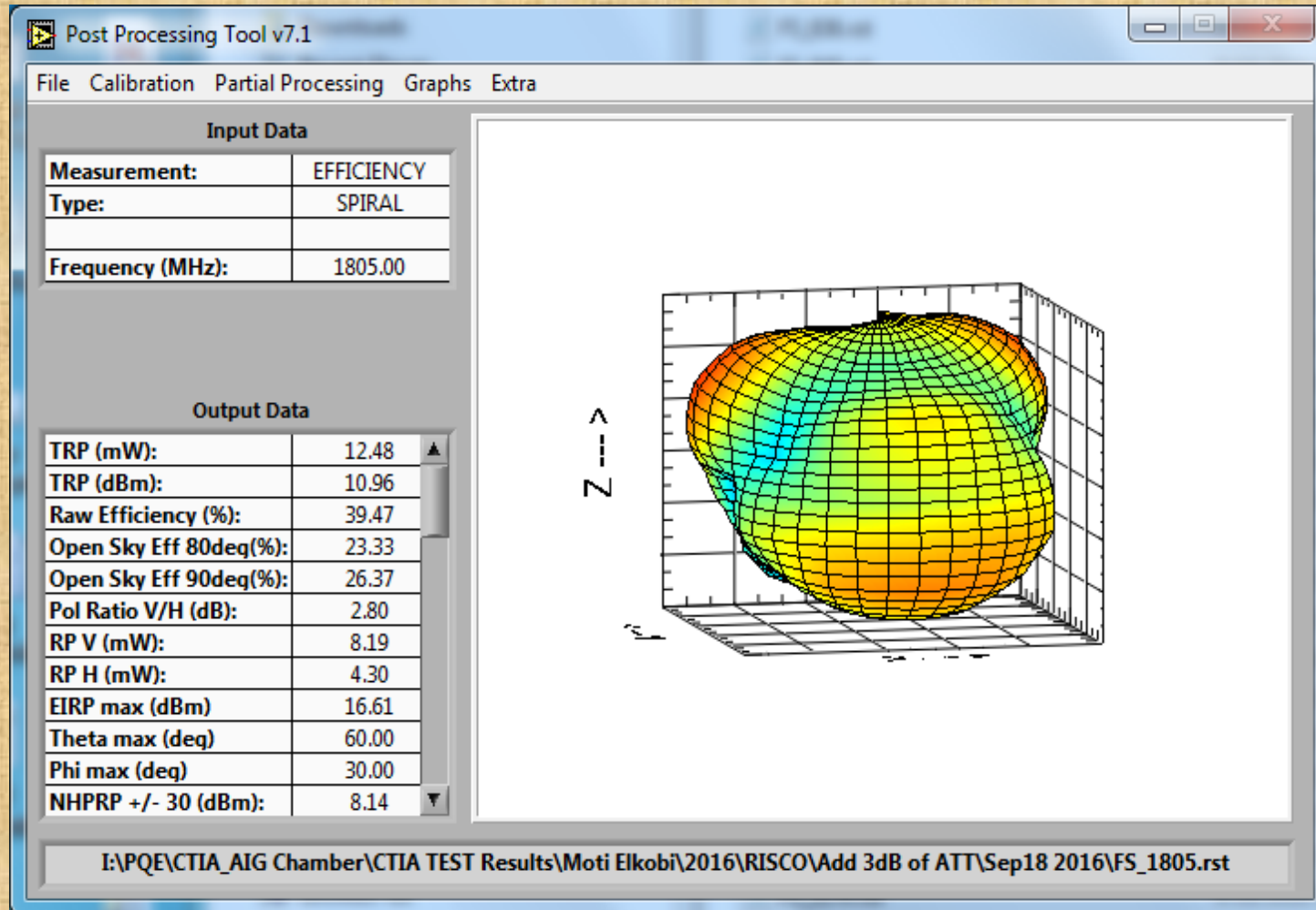

RISCO

GSM Antenna 3D Chamber Pattern Test Results

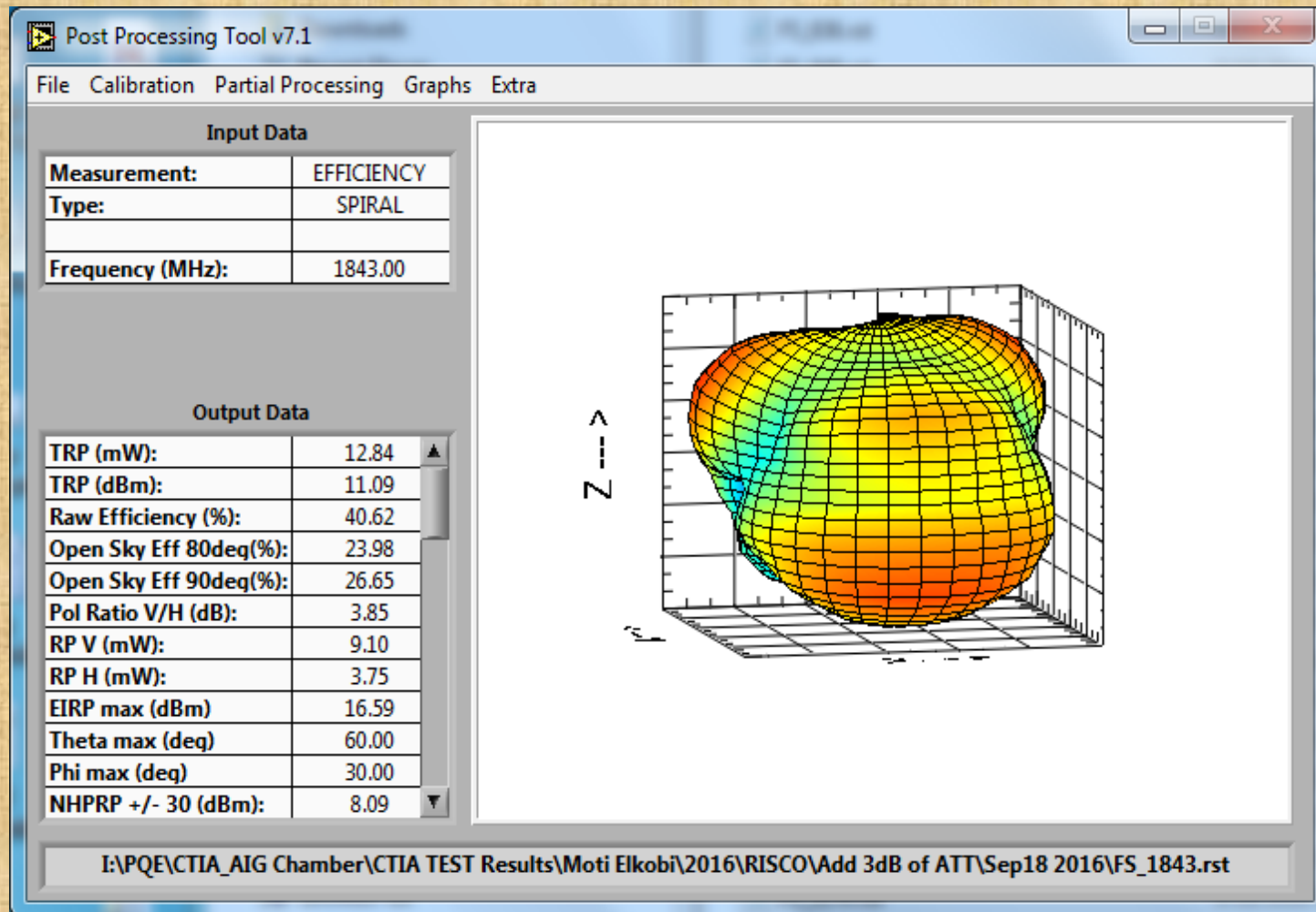

RISCO

GSM Antenna 3D Chamber Pattern Test Results

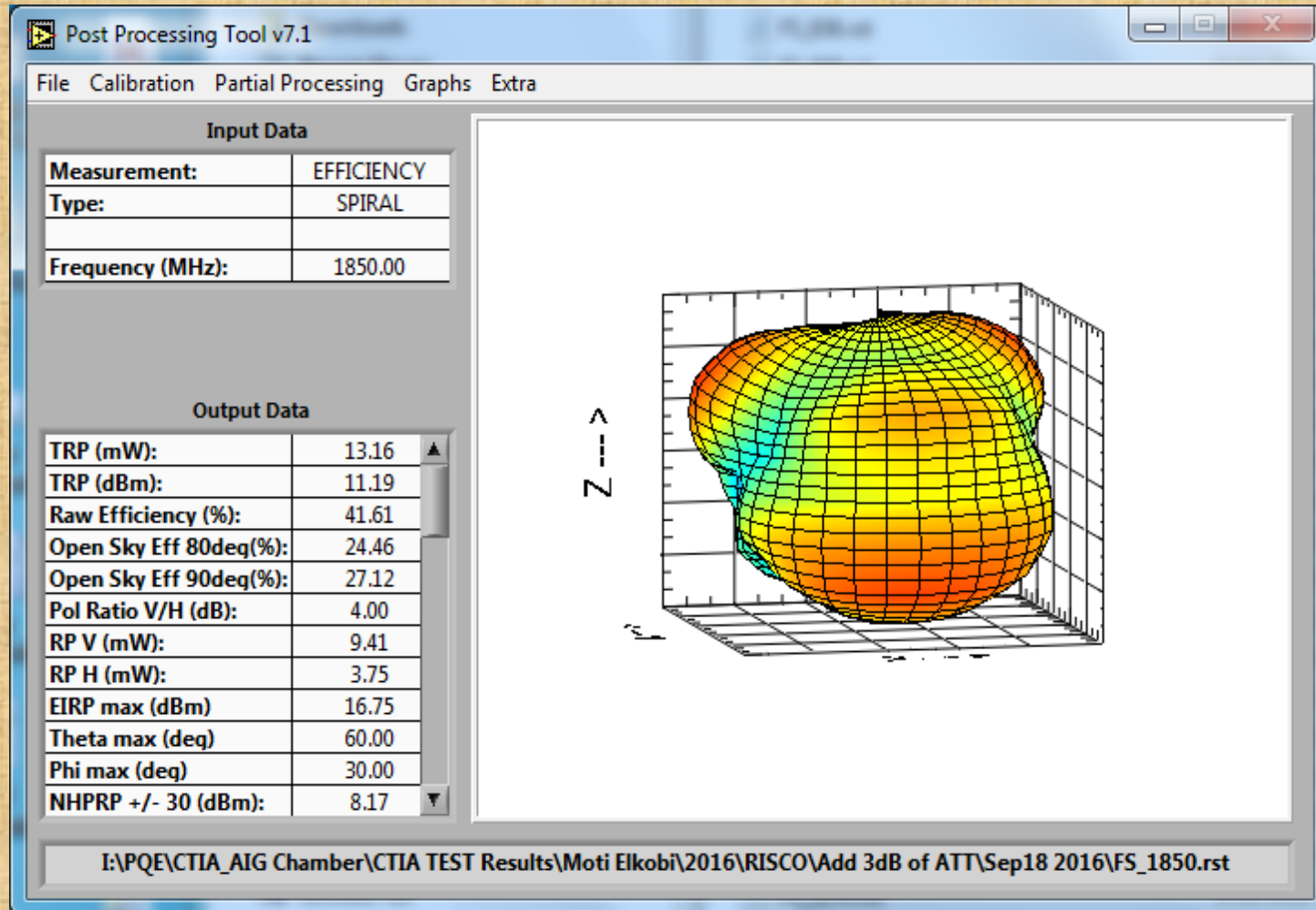

RISCO

GSM Antenna 3D Chamber Pattern Test Results

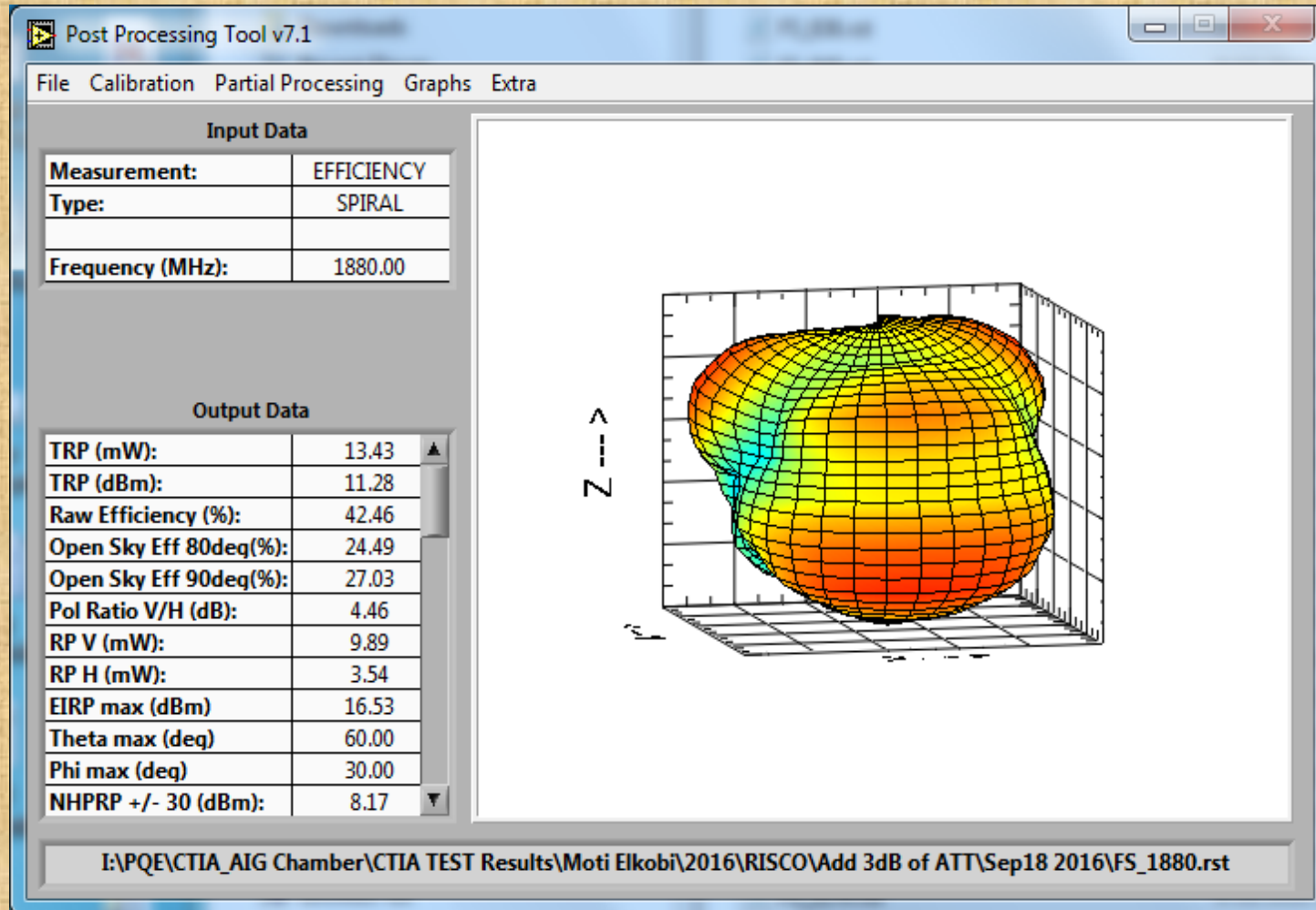

RISCO

GSM Antenna 3D Chamber Pattern Test Results

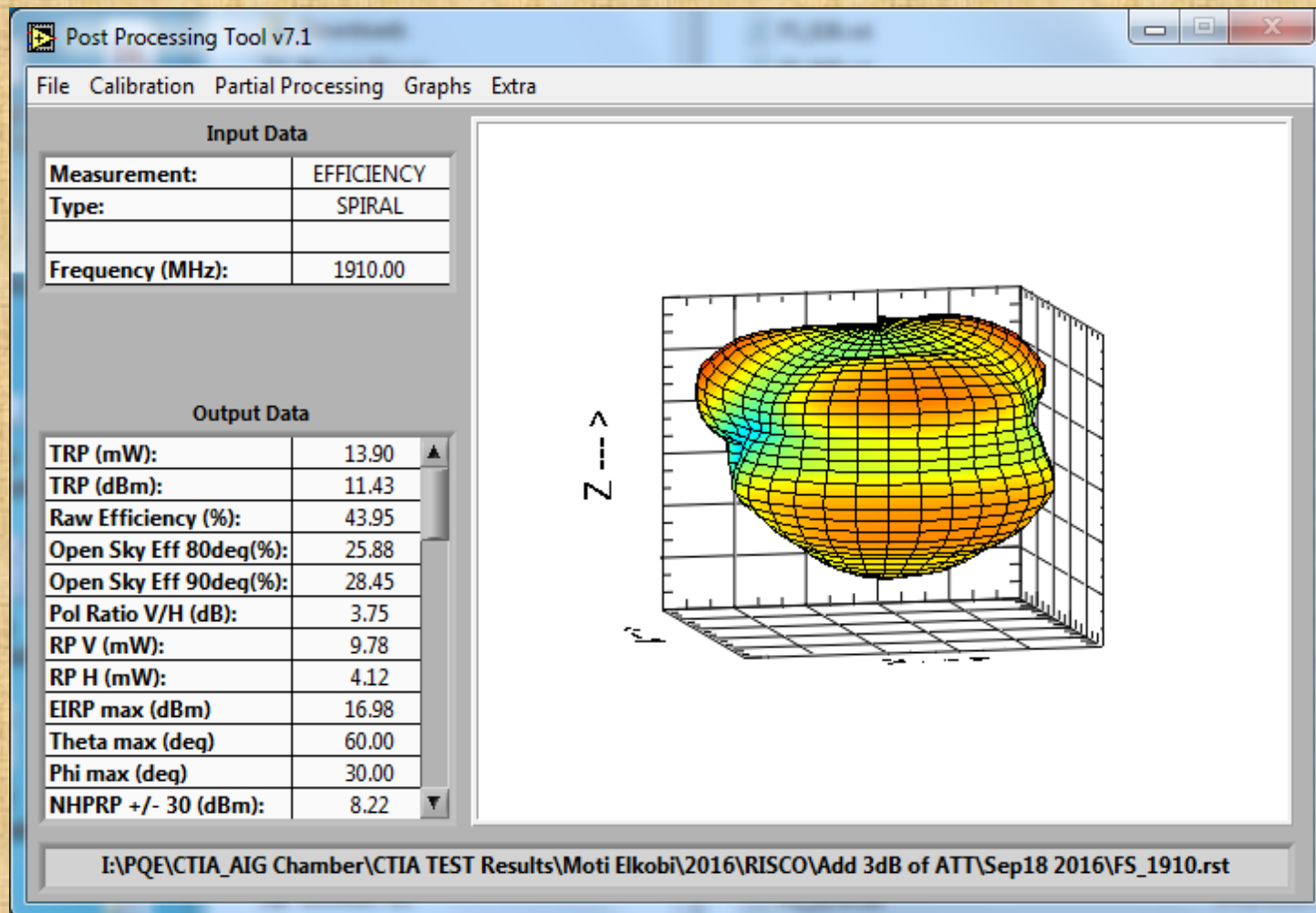

RISCO

GSM Antenna 3D Chamber Pattern Test Results

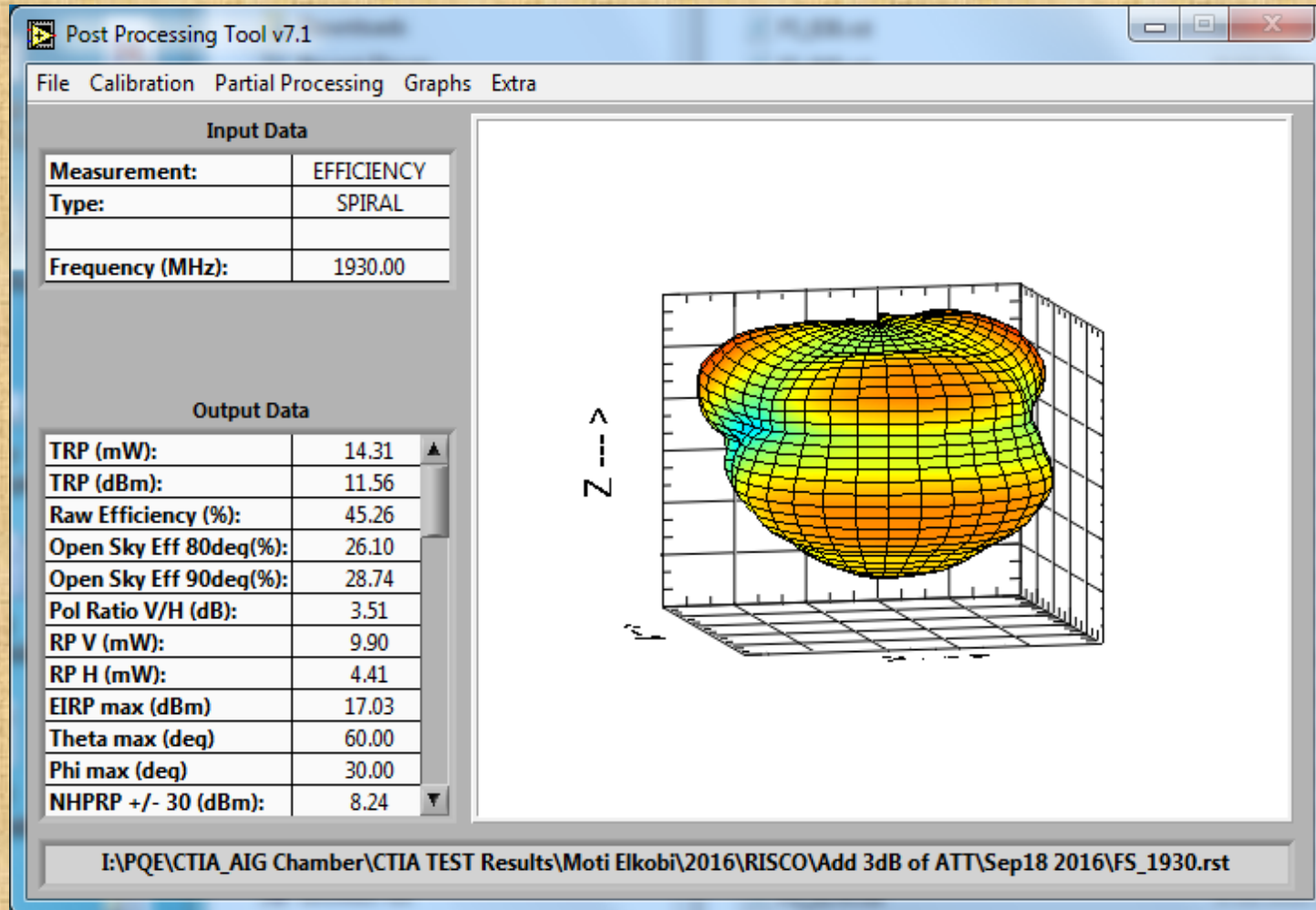

RISCO

GSM Antenna 3D Chamber Pattern Test Results

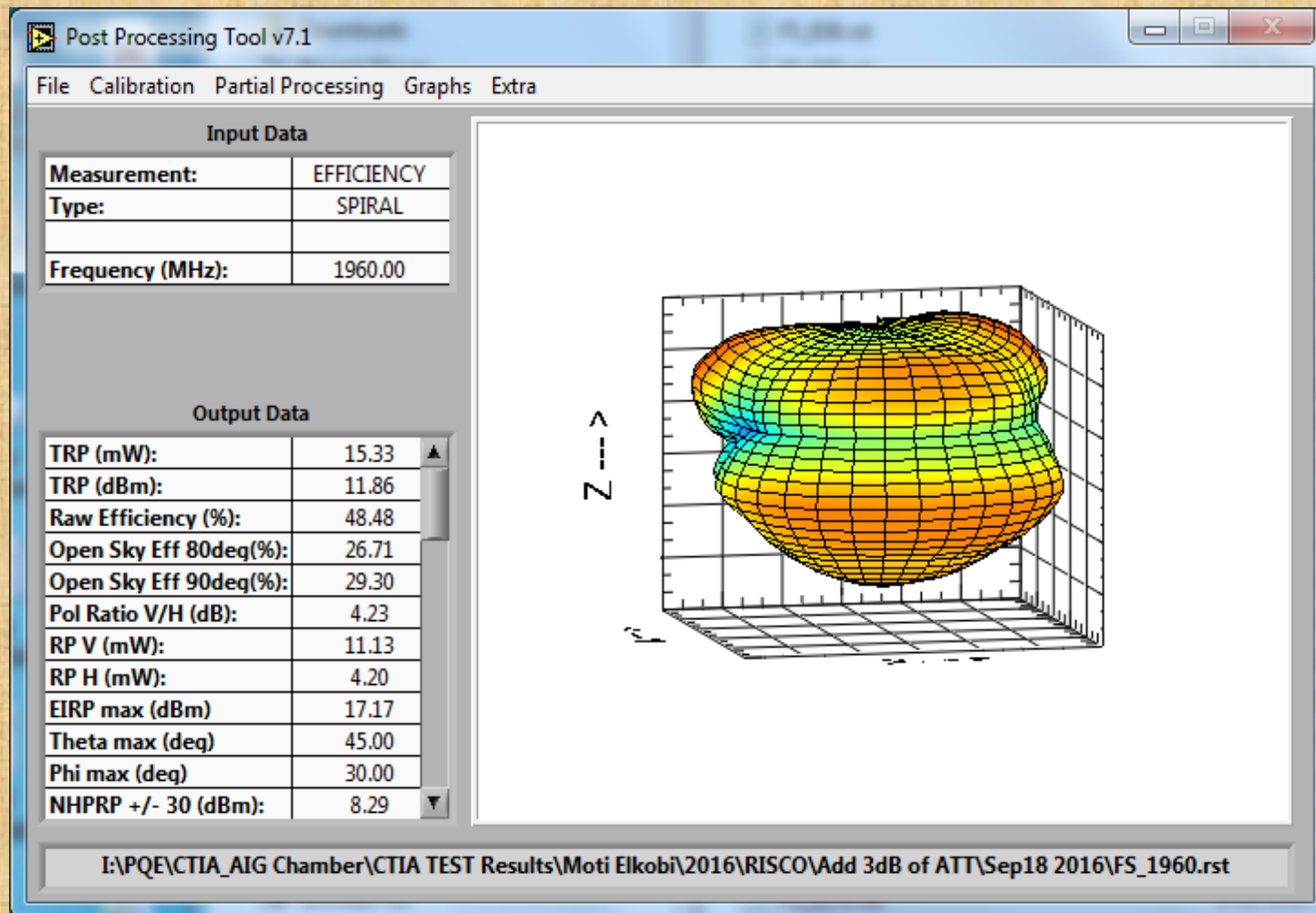

RISCO

GSM Antenna 3D Chamber Pattern Test Results

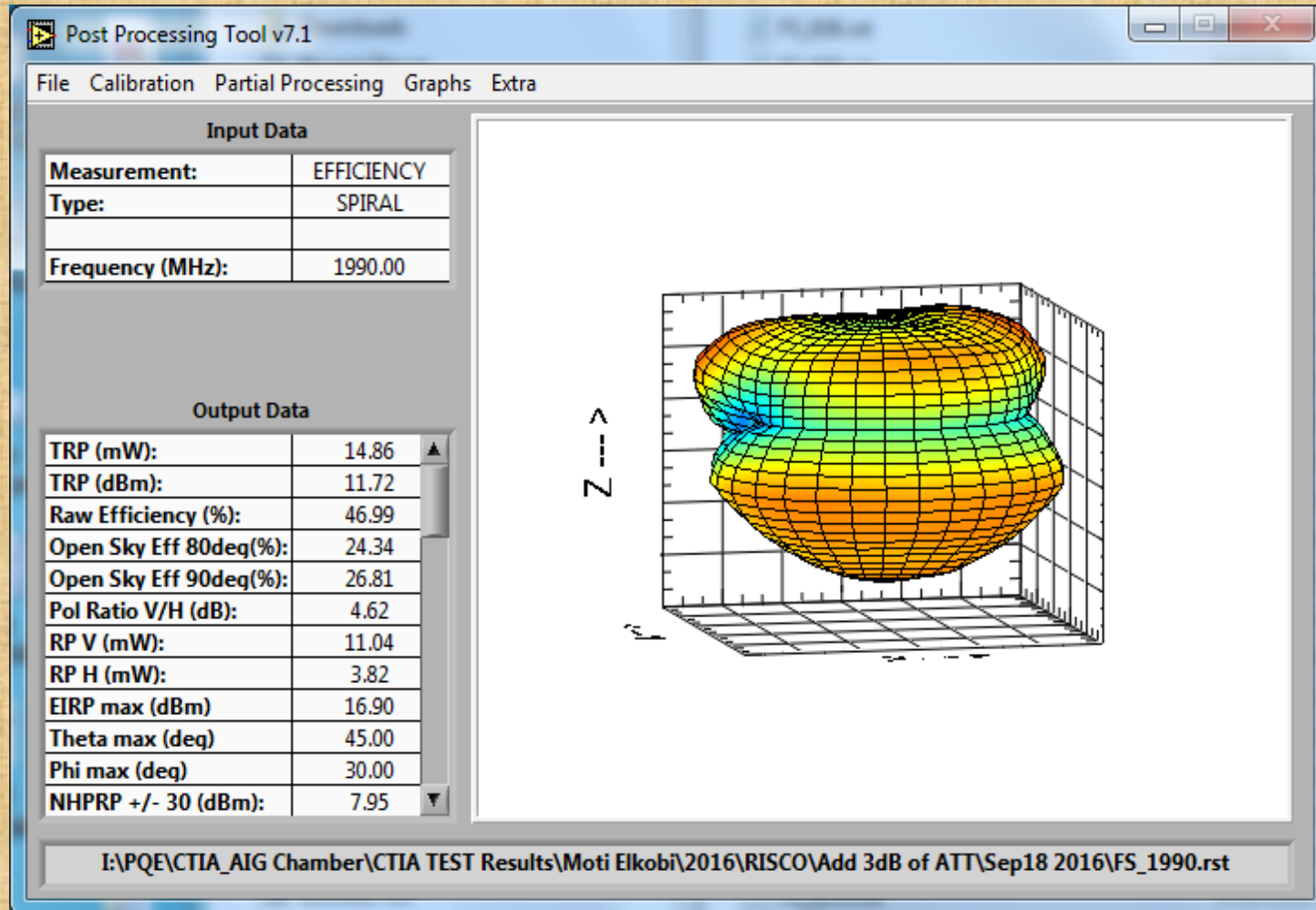

RISCO

GSM Antenna 3D Chamber Pattern Test Results

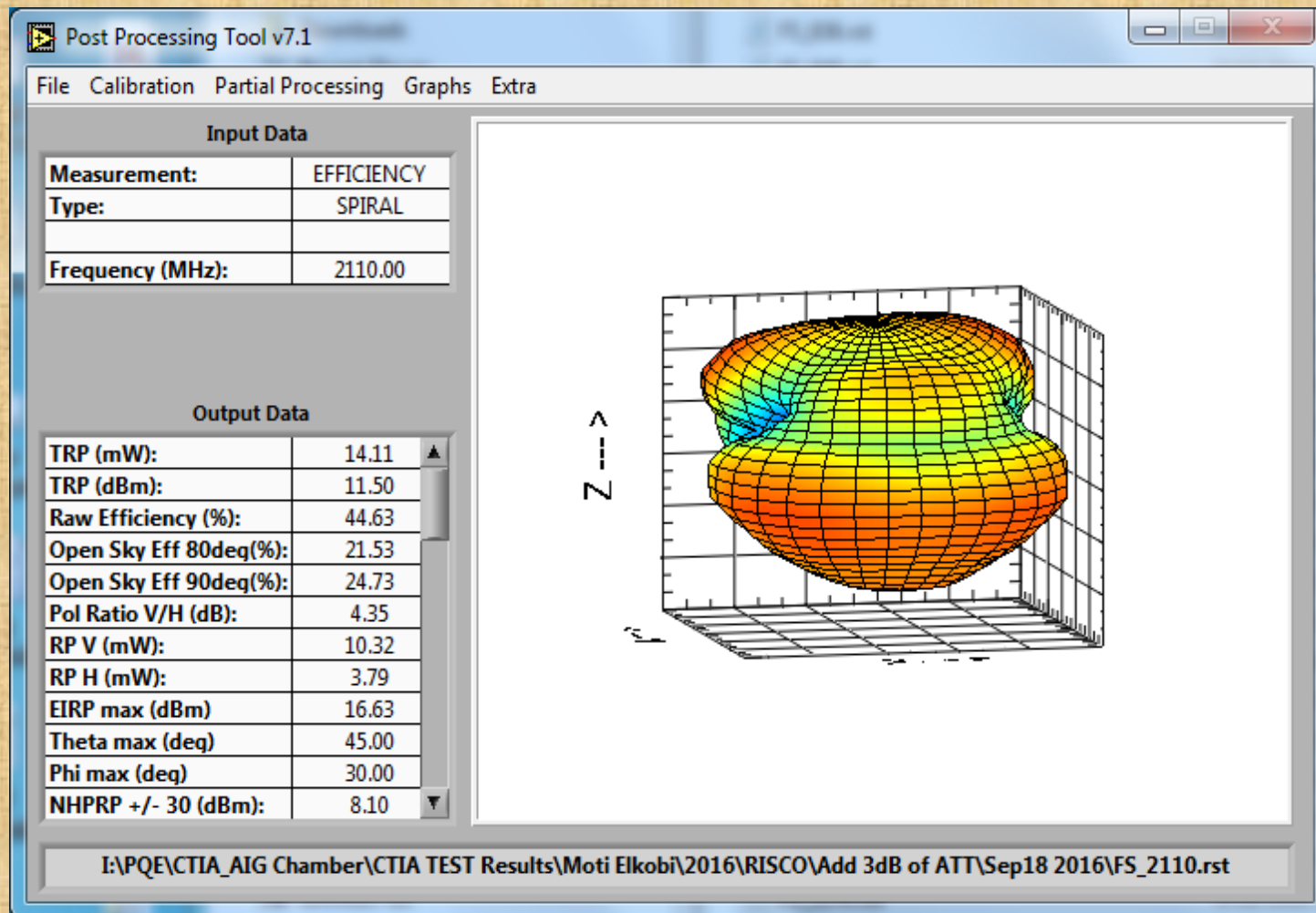

RISCO

GSM Antenna 3D Chamber Pattern Test Results

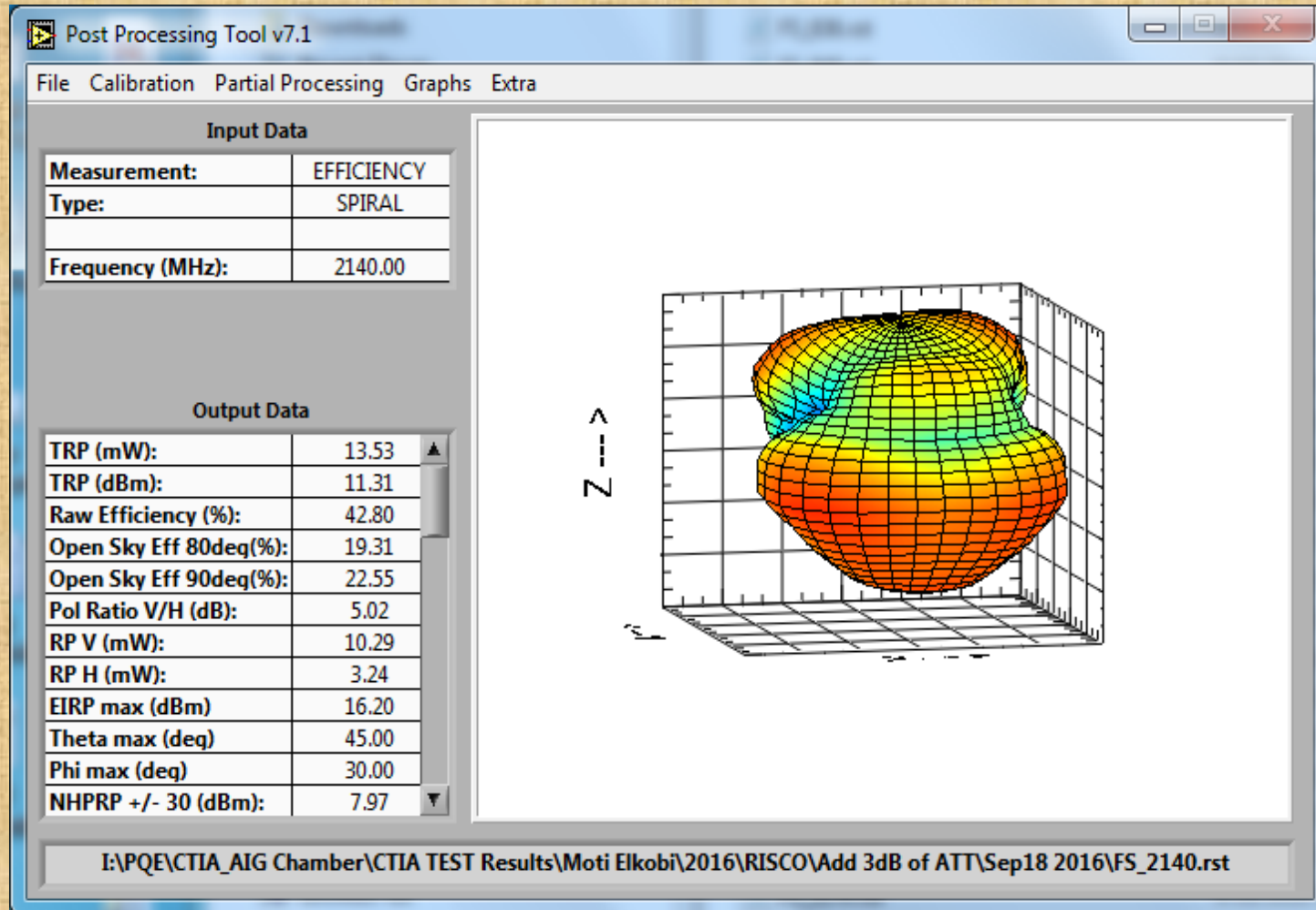

RISCO

GSM Antenna 3D Chamber Pattern Test Results

