



# FCC TEST REPORT

Report No.: STS2205137W09

Issued for  
Risco Ltd.

14 Hachoma Street, Rishon Lezion, Israel

<b>Product Name:</b>	RisControl IPS Touchscreen Keypad
<b>Brand Name:</b>	RISCO
<b>Model Name:</b>	RP432KPTZ
<b>Series Model:</b>	N/A
<b>FCC ID:</b>	JE4RP432KPTZ
<b>Test Standard:</b>	FCC Part 15.249

Any reproduction of this document must be done in full. No single part of this document may be reproduced without permission from STS, All Test Data Presented in this report is only applicable to presented Test sample.





TEST RESULT CERTIFICATION

Applicant's Name .....: Risco Ltd.
Address.....: 14 Hachoma Street, Rishon Lezion, Israel
Manufacturer's Name .....: Guangzhou MCOHome Technology Co.,Ltd
Address.....: Room 1504-1505, Building No.23 Tianan Headquarter Center, No.555 Panyu Avenue North, DongHuan street, Panyu, Guangzhou 511400, China

Product Description

Product Name .....: RisControl IPS Touchscreen Keypad
Brand Name .....: RISCO
Model Name.....: RP432KPTZ
Series Model .....: N/A

Test Standards.....: FCC Part15.249
Test Procedure.....: ANSI C63.10-2013

This device described above has been tested by STS, the test results show that the equipment under test (EUT) is in compliance with the FCC requirements. And it is applicable only to the tested sample identified in the report.
This report shall not be reproduced except in full, without the written approval of STS, this document only be altered or revised by STS, personal only, and shall be noted in the revision of the document.

Date of Test.....:
Date of receipt of test item.....: 19 May 2022
Date of performance of tests ...: 19 May 2022 ~ 15 June 2022
Date of Issue.....: 15 June 2022
Test Result .....: Pass

Testing Engineer : [Signature]
(Chris Chen)

Technical Manager : [Signature]
(Sean she)

Authorized Signatory : [Signature]
(Bovey Yang)





<b>Table of Contents</b>	<b>Page</b>
<b>1. SUMMARY OF TEST RESULTS</b>	<b>5</b>
1.1 TEST FACTORY	6
1.2 MEASUREMENT UNCERTAINTY	6
<b>2. GENERAL INFORMATION</b>	<b>7</b>
2.1 GENERAL DESCRIPTION OF THE EUT	7
2.2 DESCRIPTION OF THE TEST MODES	8
2.3 TEST SOFTWARE AND POWER LEVEL	8
2.4 BLOCK DIAGRAM SHOWING THE CONFIGURATION OF SYSTEM TESTED	9
2.5 DESCRIPTION OF NECESSARY ACCESSORIES AND SUPPORT UNITS	10
2.6 EQUIPMENTS LIST FOR ALL TEST ITEMS	11
<b>3. EMC EMISSION TEST</b>	<b>13</b>
3.1 CONDUCTED EMISSION MEASUREMENT	13
3.2 RADIATED EMISSION MEASUREMENT	17
<b>4. BANDWIDTH TEST</b>	<b>29</b>
4.1 TEST PROCEDURE	29
4.2 TEST SETUP	29
4.3 EUT OPERATION CONDITIONS	29
4.4 TEST RESULTS	30
<b>5. ANTENNA REQUIREMENT</b>	<b>31</b>
5.1 STANDARD REQUIREMENT	31
5.2 EUT ANTENNA	31
<b>APPENDIX- PHOTOS OF TEST SETUP</b>	<b>32</b>



**Revision History**

Rev.	Issue Date	Report NO.	Effect Page	Contents
00	15 June 2022	STS2205137W09	ALL	Initial Issue





## 1. SUMMARY OF TEST RESULTS

Test procedures according to the technical standards:

FCC Part 15.249 , Subpart C			
Standard Section	Test Item	Judgment	Remark
15.207	Conducted Emission	Pass	
15.203	Antenna Requirement	Pass	
15.249	Radiated Spurious Emission	Pass	
15.249	Radiated Band Edge Emission	Pass	
15.249	Field Strength of fundamental	Pass	
15.215(c)	20dB Bandwidth	Pass	

NOTE:

- (1) 'N/A' denotes test is not applicable in this Test Report.
- (2) All tests are according to ANSI C63.10-2013.

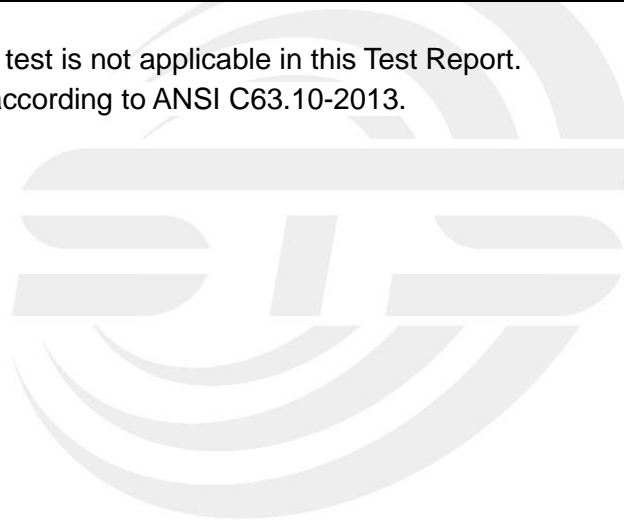



### 1.1 TEST FACTORY

SHENZHEN STS TEST SERVICES CO., LTD

Add. : A 1/F, Building B, Zhuoke Science Park, No.190 Chongqing Road, HepingShequ, Fuyong Sub-District, Bao'an District, Shenzhen, Guang Dong, China

FCC test Firm Registration Number: 625569

IC test Firm Registration Number: 12108A

A2LA Certificate No.: 4338.01

### 1.2 MEASUREMENT UNCERTAINTY

The reported uncertainty of measurement  $y \pm U$ , where expanded uncertainty  $U$  is based on a standard uncertainty multiplied by a coverage factor of  $k=2$ , providing a level of confidence of approximately **95 %**.

No.	Item	Uncertainty
1	RF output power, conducted	$\pm 0.87$ dB
2	Unwanted Emissions, conducted	$\pm 2.895$ dB
3	All emissions, radiated 9K-30MHz	$\pm 3.80$ dB
4	All emissions, radiated 30M-1GHz	$\pm 4.09$ dB
5	All emissions, radiated 1G-6GHz	$\pm 4.92$ dB
6	All emissions, radiated >6G	$\pm 5.49$ dB
7	Conducted Emission (9KHz-30MHz)	$\pm 2.73$ dB



## 2. GENERAL INFORMATION

### 2.1 GENERAL DESCRIPTION OF THE EUT

Product Name	RisControl IPS Touchscreen Keypad	
Trade Name	RISCO	
Model Name	RP432KPTZ	
Series Model	N/A	
Model Difference	N/A	
Product Description	The EUT is a RisControl IPS Touchscreen Keypad	
	Operation Frequency:	908.4MHz
	Modulation Type:	GFSK
	Antenna Designation:	Please refer to the Note 2.
	Antenna Gain(Peak):	0dBi
Based on the application, features, or specification exhibited in User Manual, the EUT is considered as an ITE/Computing Device. More details of EUT technical specification, please refer to the User Manual.		
Rating	Input: DC 13.8V 5W Max	
Connecting I/O Port(s)	Please refer to the Note 1.	

Model	Description	PCB Part number	HW Rev	S/W Rev
RP432KPTZ	RisControl+Zwave	MH-RCPAD	V1.9	V2.2

Note:

1. For a more detailed features description, please refer to the manufacturer's specifications or the User Manual.

#### 2. Table for Filed Antenna

Ant	Brand	Model Name	Antenna Type	Connector	Gain (dBi)	NOTE
1	RISCO	RP432KPTZ	Monopole	N/A	0dBi	Antenna

Note: The antenna information refer the manufacturer provide report, applicable only to the tested sample identified in the report.



## 2.2 DESCRIPTION OF THE TEST MODES

For conducted test items and radiated spurious emissions  
Each of these EUT operation mode(s) or test configuration mode(s) mentioned below was evaluated respectively.

Pretest Mode	Description	Data/Modulation
Mode 1	TX	GFSK

Note:

- (1) All above mode have been measurement, only worst data was reported.
- (2) We have be tested for all available U.S. voltage and frequencies(For 120V,50/60Hz and 240V, 50/60Hz) for which the device is capable of operation, and the worst case of 120V,50/60Hz is shown in the report.

For AC Conducted Emission

Test Case	
AC Conducted Emission	Mode 2 : Keeping TX

## 2.3 TEST SOFTWARE AND POWER LEVEL

During testing channel & power controlling software provided by the customer was used to control the operating channel as well as the output power level.

RF Function	Type	Mode Or Modulation type	ANT Gain(dBi)	Power Class	Software For Testing
Z-wave	908.4MHz	GFSK	0	Default	The EUT has signal transmission when it is powered on



## 2.4 BLOCK DIAGRAM SHOWING THE CONFIGURATION OF SYSTEM TESTED

During testing channel & power controlling software provided by the customer was used to control the operating channel as well as the output power level. The RF output power selection is for the setting of RF output power expected by the customer and is going to be fixed on the firmware of the final end product power parameters.

### Radiated Spurious Emission Test

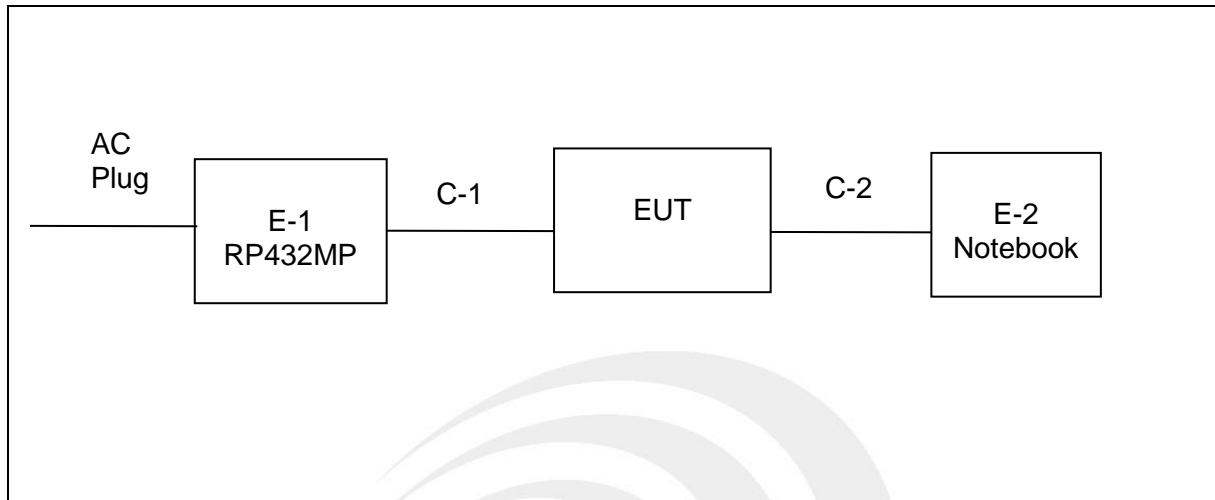

### Conducted Emission Test

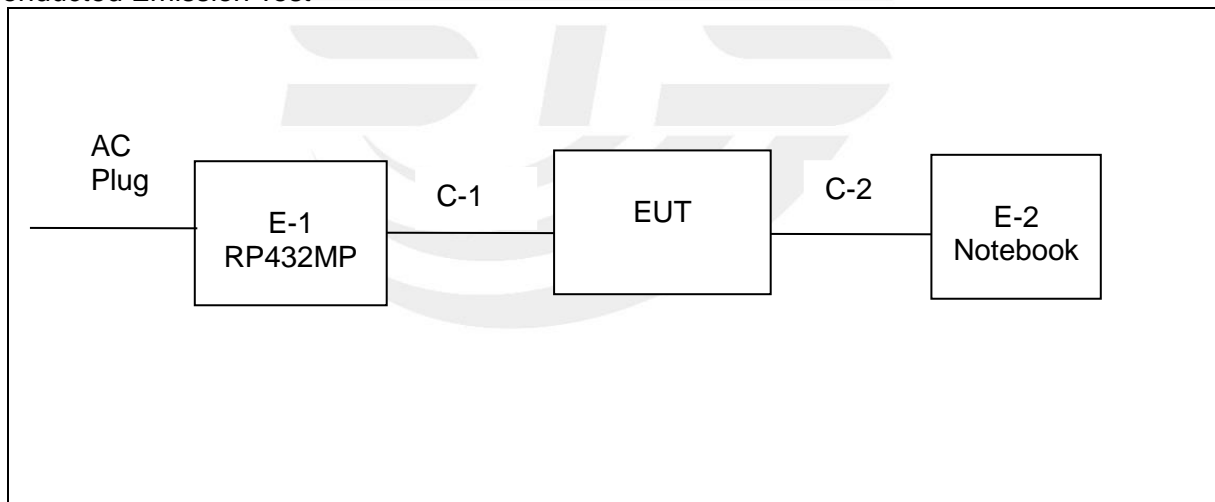

## 2.5 DESCRIPTION OF NECESSARY ACCESSORIES AND SUPPORT UNITS

The EUT has been tested as an independent unit together with other necessary accessories or support units. The following support units or accessories were used to form a representative test configuration during the tests.

### Necessary accessories

Item	Equipment	Mfr/Brand	Model/Type No.	Length	Note
E-1	DC Power	N/A	Power	>30m	NO
C-1	Signal	N/A	Signal	>30m	NO

### Support units

Item	Equipment	Mfr/Brand	Model/Type No.	Length	Note
E-2	Control panel	RISCO	RP432MP	>30m	NO

#### Note:

- (1) For detachable type I/O cable should be specified the length in cm in 『Length』 column.

2.6 EQUIPMENTS LIST FOR ALL TEST ITEMS

Radiation Test equipment

Kind of Equipment	Manufacturer	Type No.	Serial No.	Last calibration	Calibrated until
Test Receiver	R&S	ESCI	101427	2021.09.30	2022.09.29
Signal Analyzer	R&S	FSV 40-N	101823	2021.09.30	2022.09.29
Active loop Antenna	ZHINAN	ZN30900C	16035	2021.04.11	2023.04.10
Bilog Antenna	TESEQ	CBL6111D	34678	2020.10.12	2022.10.11
Horn Antenna	SCHWARZBECK	BBHA 9120D	02014	2021.10.11	2023.10.10
SHF-EHF Horn Antenna (18G-40GHz)	A-INFO	LB-180400-KF	J211020657	2020.10.12	2022.10.11
Pre-Amplifier(0.1M-3 GHz)	EM	EM330	060665	2021.10.08	2022.10.07
Pre-Amplifier (1G-18GHz)	SKET	LNPA-01018G-45	SK2018080901	2021.09.30	2022.09.29
Pre-Amplifier (18G-40GHz)	SKET	LNPA-1840-50	SK2018101801	2021.09.28	2022.09.27
Temperature & Humidity	HH660	Mieo	N/A	2021.10.09	2022.10.08
turn table	EM	SC100_1	60531	N/A	N/A
Antenna mast	EM	SC100	N/A	N/A	N/A
Test SW	FARAD	EZ-EMC(Ver.STSLAB-03A1 RE)			

Conduction Test equipment

Kind of Equipment	Manufacturer	Type No.	Serial No.	Last calibration	Calibrated until
Test Receiver	R&S	ESCI	101427	2021.09.30	2022.09.29
LISN	R&S	ENV216	101242	2021.09.30	2022.09.29
LISN	EMCO	3810/2NM	23625	2021.09.30	2022.09.29
Temperature & Humidity	HH660	Mieo	N/A	2021.10.09	2022.10.08
Test SW	FARAD	EZ-EMC(Ver.STSLAB-03A1 CE)			



## RF Connected Test

Kind of Equipment	Manufacturer	Type No.	Serial No.	Last calibration	Calibrated until
Power Sensor	Keysight	U2021XA	MY55520005	2021.09.30	2022.09.29
			MY55520006	2021.09.30	2022.09.29
			MY56120038	2021.09.30	2022.09.29
			MY56280002	2021.09.30	2022.09.29
Signal Analyzer	Agilent	N9020A	MY51110105	2022.03.01	2023.02.28
Temperature & Humidity	HH660	Mieo	N/A	2021.10.09	2022.10.08
Test SW	FARAD	EZ-EMC(Ver.STSLAB-03A1 RE)			





### 3. EMC EMISSION TEST

#### 3.1 CONDUCTED EMISSION MEASUREMENT

##### 3.1.1 POWER LINE CONDUCTED EMISSION LIMITS

The radio frequency voltage that is conducted back onto the AC power line on any frequency or frequencies, within the band 150 kHz to 30 MHz, shall not exceed the limits in the following table.

FREQUENCY (MHz)	Quasi-peak	Average
0.15 -0.5	66 - 56 *	56 - 46 *
0.50 -5.0	56.00	46.00
5.0 -30.0	60.00	50.00

Note:

- (1) The tighter limit applies at the band edges.
- (2) The limit of “ \* ” marked band means the limitation decreases linearly with the logarithm of the frequency in the range.

The following table is the setting of the receiver

Receiver Parameters	Setting
Attenuation	10 dB
Start Frequency	0.15 MHz
Stop Frequency	30 MHz
IF Bandwidth	9 kHz

### 3.1.2 TEST PROCEDURE

- a. The EUT is 0.8 m from the horizontal ground plane and 0.4 m from the vertical ground plane with EUT being connected to the power mains through a line impedance stabilization network (LISN). All other support equipments are powered from additional LISN(s). The LISN provides 50 Ohm/ 50uH of coupling impedance for the measuring instrument.
- b. Interconnecting cables that hang closer than 40 cm to the ground plane shall be folded back and forth in the center forming a bundle 30 to 40 cm long.
- c. I/O cables that are not connected to a peripheral shall be bundled in the center. The end of the cable may be terminated, if required, using the correct terminating impedance. The overall length shall not exceed 1 m.
- d. LISN is at least 80 cm from the nearest part of EUT chassis.
- e. For the actual test configuration, please refer to the related Item –EUT Test Photos.

### 3.1.3 TEST SETUP

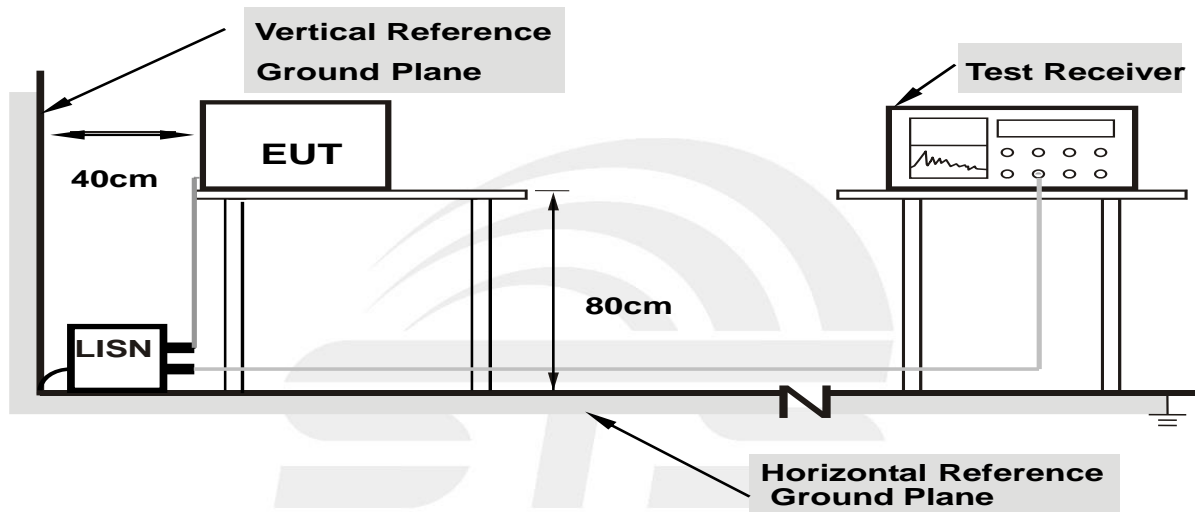

- Note: 1.Support units were connected to second LISN.**  
**2.Both of LISNs (AMN) are 80 cm from EUT and at least 80 cm from other units and other metal planes support.**

### 3.1.4 EUT OPERATING CONDITIONS

The EUT was configured for testing in a typical fashion (as a customer would normally use it). The EUT has been programmed to continuously transmit during test. This operating condition was tested and used to collect the included data.



3.1.5 TEST RESULT

Temperature:	25.4(C)	Relative Humidity:	51%RH
Test Voltage:	AC 120V/60Hz	Phase:	L
Test Mode:	Mode 2		

No.	Frequency (MHz)	Reading (dBuV)	Correct Factor(dB)	Result (dBuV)	Limit (dBuV)	Margin (dB)	Remark
1	0.1500	33.38	20.33	53.71	66.00	-12.29	QP
2	0.1500	22.30	20.33	42.63	56.00	-13.37	AVG
3	0.1700	30.92	20.33	51.25	64.96	-13.71	QP
4	0.1700	18.12	20.33	38.45	54.96	-16.51	AVG
5	0.2140	26.75	20.37	47.12	63.05	-15.93	QP
6	0.2140	15.98	20.37	36.35	53.05	-16.70	AVG
7	0.5100	27.61	20.53	48.14	56.00	-7.86	QP
8	0.5100	19.94	20.53	40.47	46.00	-5.53	AVG
9	0.7300	14.71	20.34	35.05	56.00	-20.95	QP
10	0.7300	4.13	20.34	24.47	46.00	-21.53	AVG
11	18.1860	10.12	22.47	32.59	60.00	-27.41	QP
12	18.1860	2.85	22.47	25.32	50.00	-24.68	AVG

Remark:

1. All readings are Quasi-Peak and Average values
2. Margin = Result (Result = Reading + Factor) – Limit
3. Factor=LISN factor+Cable loss+Limiter (10dB)

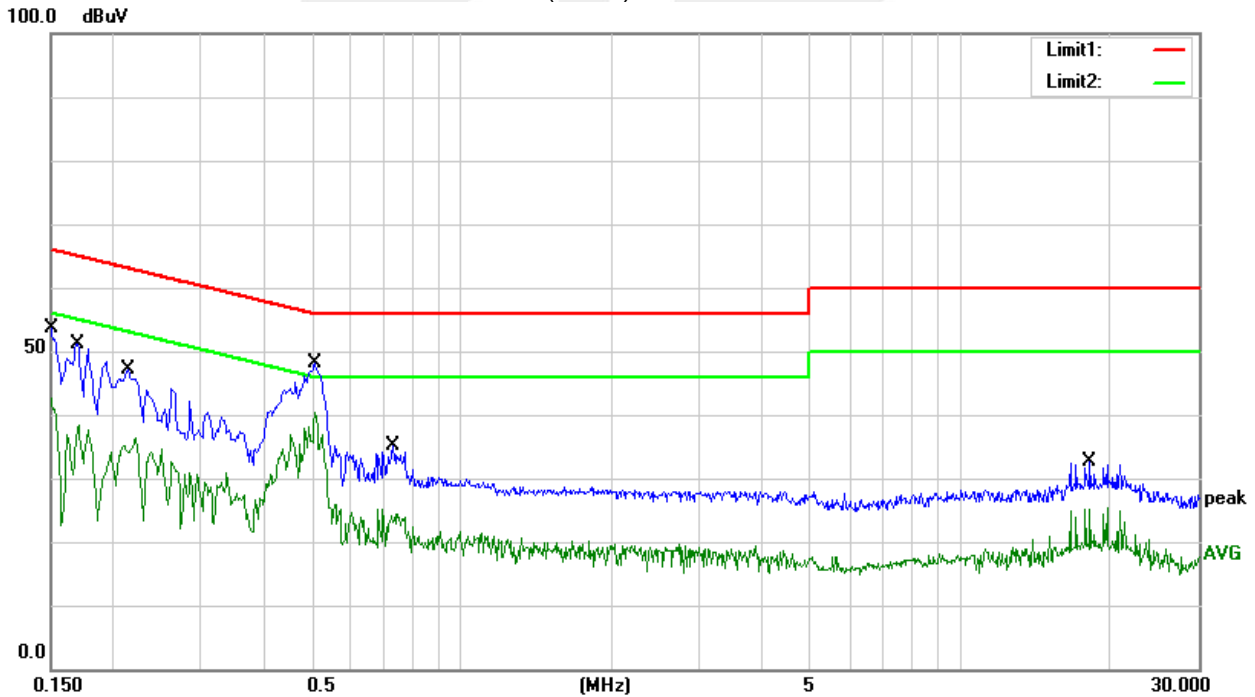



Temperature:	25.4(C)	Relative Humidity:	51%RH
Test Voltage:	AC 120V/60Hz	Phase:	N
Test Mode:	Mode 2		

No.	Frequency (MHz)	Reading (dBuV)	Correct Factor(dB)	Result (dBuV)	Limit (dBuV)	Margin (dB)	Remark
1	0.1500	30.84	20.33	51.17	66.00	-14.83	QP
2	0.1500	18.28	20.33	38.61	56.00	-17.39	AVG
3	0.2100	24.86	20.35	45.21	63.21	-18.00	QP
4	0.2100	13.74	20.35	34.09	53.21	-19.12	AVG
5	0.4994	24.20	20.54	44.74	56.01	-11.27	QP
6	0.4994	18.48	20.54	39.02	46.01	-6.99	AVG
7	0.7460	13.63	20.34	33.97	56.00	-22.03	QP
8	0.7460	4.61	20.34	24.95	46.00	-21.05	AVG
9	1.3300	13.17	20.30	33.47	56.00	-22.53	QP
10	1.3300	2.45	20.30	22.75	46.00	-23.25	AVG
11	17.8020	16.34	22.39	38.73	60.00	-21.27	QP
12	17.8020	9.34	22.39	31.73	50.00	-18.27	AVG

Remark:

1. All readings are Quasi-Peak and Average values
2. Margin = Result (Result =Reading + Factor )–Limit
3. Factor=LISN factor+Cable loss+Limiter (10dB)

100.0 dBuV

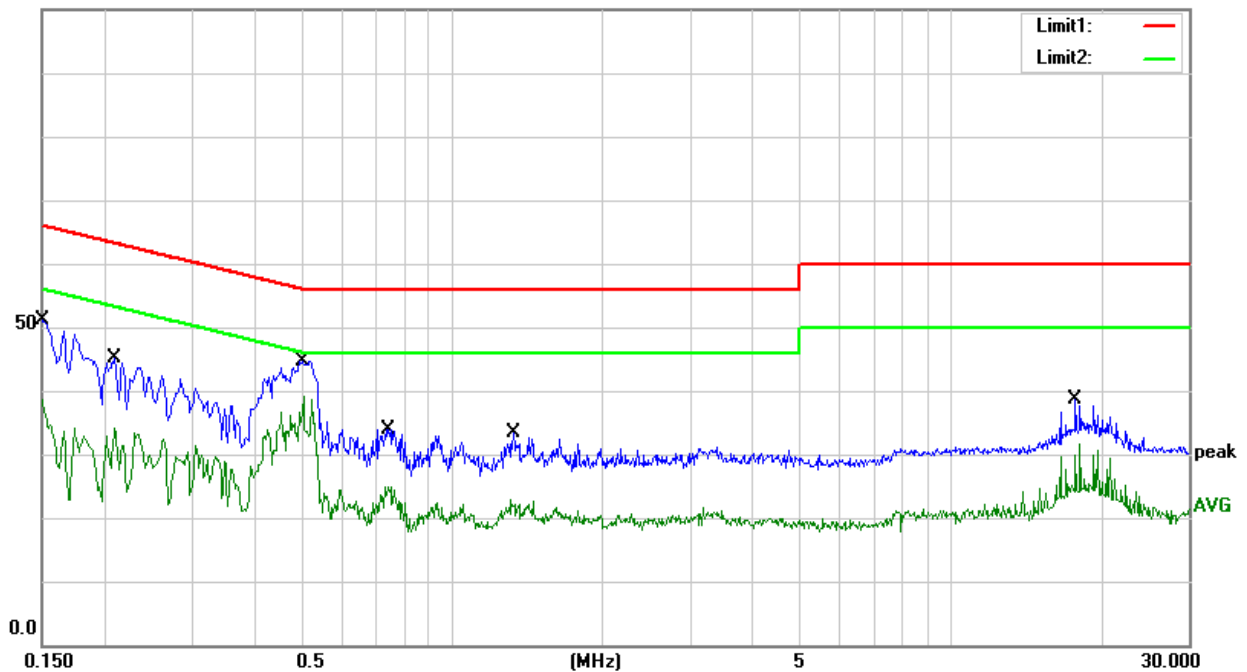



### 3.2 RADIATED EMISSION MEASUREMENT

#### 3.2.1 RADIATED EMISSION LIMITS

In any 100 kHz bandwidth outside the operating frequency band. In case the emission fall within the restricted band specified on Part 15.249 and the Part 15.209(a) limit in the table below has to be followed.

Standard FCC 15.209

Frequencies (MHz)	Field Strength (micorvolts/meter)	Measurement Distance (meters)
0.009~0.490	2400/F(KHz)	300
0.490~1.705	24000/F(KHz)	30
1.705~30.0	30	30
30~88	100	3
88~216	150	3
216~960	200	3
960~1000	500	3
Above 1000	Other:74.0 dB(μV)/m (Peak) 54.0 dB(μV)/m (Average)	3

Standard FCC 15.249

Frequency of Emission (MHz)	Field Strength of fundamental (millivolts /meter)	Field Strength of Harmonics (microvolts/meter)
900~928	50	500
2400~2483.5	50	500
5725~5875	50	500
24000~242500	250	2500

Notes:

- (1) Emissions radiated outside of the specified frequency bands, except for harmonics, shall be attenuated by at least 50 dB below the level of the fundamental or to the general radiated emission limits in Section 15.209, whichever is the lesser attenuation.

#### LIMITS OF RESTRICTED FREQUENCY BANDS

FREQUENCY (MHz)	FREQUENCY (MHz)	FREQUENCY (MHz)	FREQUENCY (GHz)
0.090-0.110	16.42-16.423	399.9-410	4.5-5.15
0.495-0.505	16.69475-16.69525	608-614	5.35-5.46
2.1735-2.1905	16.80425-16.80475	960-1240	7.25-7.75
4.125-4.128	25.5-25.67	1300-1427	8.025-8.5
4.17725-4.17775	37.5-38.25	1435-1626.5	9.0-9.2
4.20725-4.20775	73-74.6	1645.5-1646.5	9.3-9.5
6.215-6.218	74.8-75.2	1660-1710	10.6-12.7



6.26775-6.26825	108-121.94	1718.8-1722.2	13.25-13.4
6.31175-6.31225	123-138	2200-2300	14.47-14.5
8.291-8.294	149.9-150.05	2310-2390	15.35-16.2
8.362-8.366	156.52475-156.52525	2483.5-2500	17.7-21.4
8.37625-8.38675	156.7-156.9	2690-2900	22.01-23.12
8.41425-8.41475	162.0125-167.17	3260-3267	23.6-24.0
12.29-12.293	167.72-173.2	3332-3339	31.2-31.8
12.51975-12.52025	240-285	3345.8-3358	36.43-36.5
12.57675-12.57725	322-335.4	3600-4400	Above 38.6
13.36-13.41			

Spectrum Parameter	Setting
Detector	Peak/AV
Attenuation	Auto
Start Frequency	1000 MHz
Stop Frequency	10th carrier harmonic
RB (emission in restricted band)	>20BW
VB (emission in restricted band)	=3xRB

Receiver Parameter	Setting
Attenuation	Auto
Start ~ Stop Frequency	9kHz~90kHz / RB 200Hz for PK & AV
	90kHz~110kHz / RB 200Hz for QP
	110kHz~490kHz / RB 200Hz for PK & AV
	490kHz~30MHz / RB 9kHz for QP
	30MHz~1000MHz / RB 120kHz for QP



### 3.2.2 TEST PROCEDURE

- a. The measuring distance of 3m shall be used for measurements. The EUT was placed on the top of a rotating table 0.8 meter above the ground at a 3 meter semi-anechoic chamber. The table was rotated 360 degrees to determine the position of the highest radiation (Below 1GHz)
- b. The measuring distance of 3m shall be used for measurements. The EUT was placed on the top of a rotating table 1.5 meter above the ground at a 3 meter semi-anechoic chamber. The table was rotated 360 degrees to determine the position of the highest radiation (Above 1GHz)
- c. The height of the test antenna shall vary between 1m to 4m. Both horizontal and vertical polarization of the antenna are set to make the measurement.
- d. The initial step in collecting radiated emission data is a receive peak detector mode. Pre-scanning the measurement frequency range. Significant peaks are then marked and then Quasi Peak detector mode re-measured.
- e. All readings are peak unless otherwise stated QP in column of Note. Peak denoted that the Peak reading compliance with the QP limits and then QP Mode measurement didn't perform (Below 1GHz)
- f. All readings are Peak mode value unless otherwise stated AVG in column of Note. If the Peak mode measured value compliance with the Peak limits and lower than AVG Limits, the EUT shall be deemed to meet Peak & AVG limits and then only Peak mode was measured, but AVG mode didn't perform. (Above 1GHz)
- g. For the actual test configuration, please refer to the related Item –EUT Test Photos.  
Note: Both horizontal and vertical antenna polarities were tested and performed pretest to three orthogonal axis. The worst case emissions were reported.

### 3.2.3 DEVIATION FROM TEST STANDARD

No deviation

### 3.2.4 TEST SETUP

(A) Radiated Emission Test-Up Frequency Below 30MHz

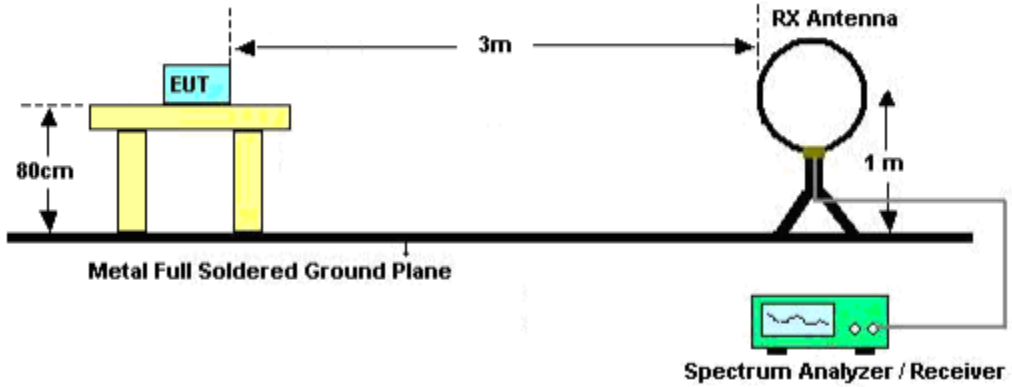

(B) Radiated Emission Test-Up Frequency 30MHz~1GHz

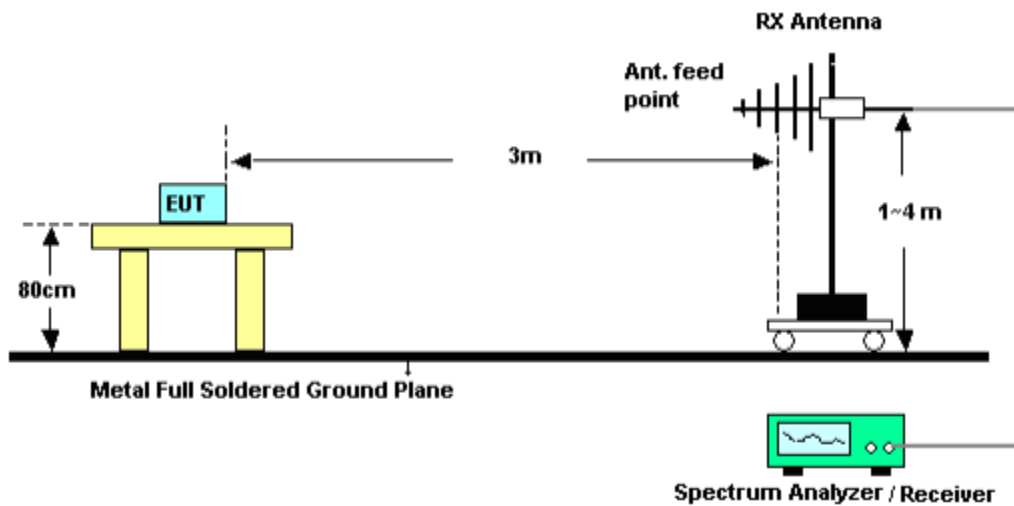

(C) Radiated Emission Test-Up Frequency Above 1GHz

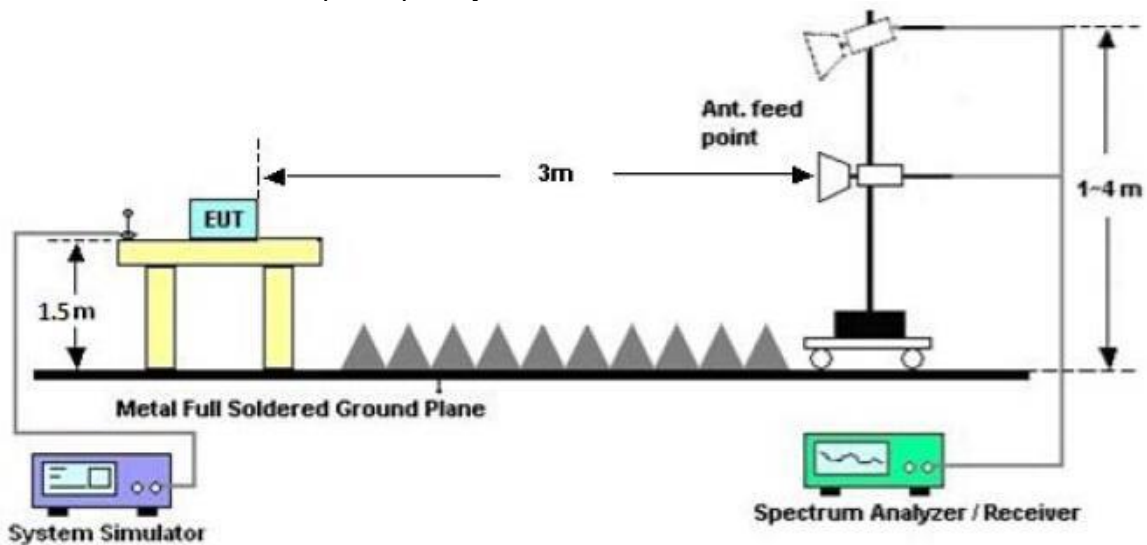



### 3.2.5 FIELD STRENGTH CALCULATION

The field strength is calculated by adding the Antenna Factor and Cable Factor and subtracting the Amplifier Gain and Duty Cycle Correction Factor (if any) from the measured reading. The basic equation with a sample calculation is as follows:

Margin=PL-PK L or AL- AV L; Margin only shown the worst case.

Where

PR = Peak Reading

AR = Average Reading

PL = Peak Level

AL = Average Level

AF = Antenna Factor

PK L = Peak Limit

AV L = AV Limit

For example

Frequency	PR	AR	AF	PL	AL	PK L	AV L	Margin
(MHz)	(dB $\mu$ V/m)	(dB $\mu$ V/m)	(dB)	(dB $\mu$ V/m)	(dB $\mu$ V/m)	(dB $\mu$ V/m)	(dB $\mu$ V/m)	(dB)
2178	40.23	30.31	9.83	50.06	40.14	74.00	54.00	-13.86





### 3.2.6 EUT OPERATING CONDITIONS

The EUT tested system was configured as the statements of 2.4 Unless otherwise a special operating condition is specified in the follows during the testing.

Below 30 MHz

Temperature:	23.1(C)	Relative Humidity:	60%RH
Test Voltage:	DC 13.8V	Polarization:	---
Test Mode:	TX Mode		

Freq. (MHz)	Reading (dBuV/m)	Limit (dBuV/m)	Margin (dB)	State P/F
--	--	--	--	PASS
--	--	--	--	PASS

**NOTE:**

The amplitude of spurious emissions which are attenuated by more than 20dB below the permissible value has no need to be reported.

Distance extrapolation factor =  $40 \log (\text{specific distance}/\text{test distance})(\text{dB})$ ;

Limit line = specific limits(dBuv) + distance extrapolation factor.

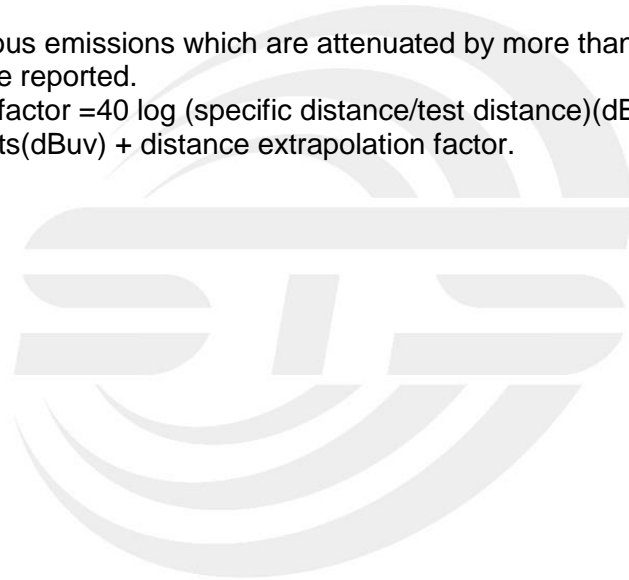



Between 30MHz – 1000 MHz Radiation Spurious

Temperature:	23.1(C)	Relative Humidity:	60%RH
Test Voltage:	DC 13.8V	Phase:	Horizontal
Test Mode:	Mode 1		

No.	Frequency (MHz)	Reading (dBuV)	Correct Factor(dB/m)	Result (dBuV/m)	Limit (dBuV/m)	Margin (dB)	Remark
1	86.2600	47.41	-21.96	25.45	40.00	-14.55	peak
2	167.7400	42.70	-19.58	23.12	43.50	-20.38	peak
3	428.6700	39.21	-10.14	29.07	46.00	-16.93	peak
4	711.9100	28.25	-3.74	24.51	46.00	-21.49	peak
5	839.9500	28.84	-0.34	28.50	46.00	-17.50	peak
6	974.7800	28.82	2.32	31.14	54.00	-22.86	peak

Remark:

1. Margin = Result (Result =Reading + Factor)–Limit
2. Factor= Antenna factor+Cable attenuation factor(cable loss)-Amplifier gain

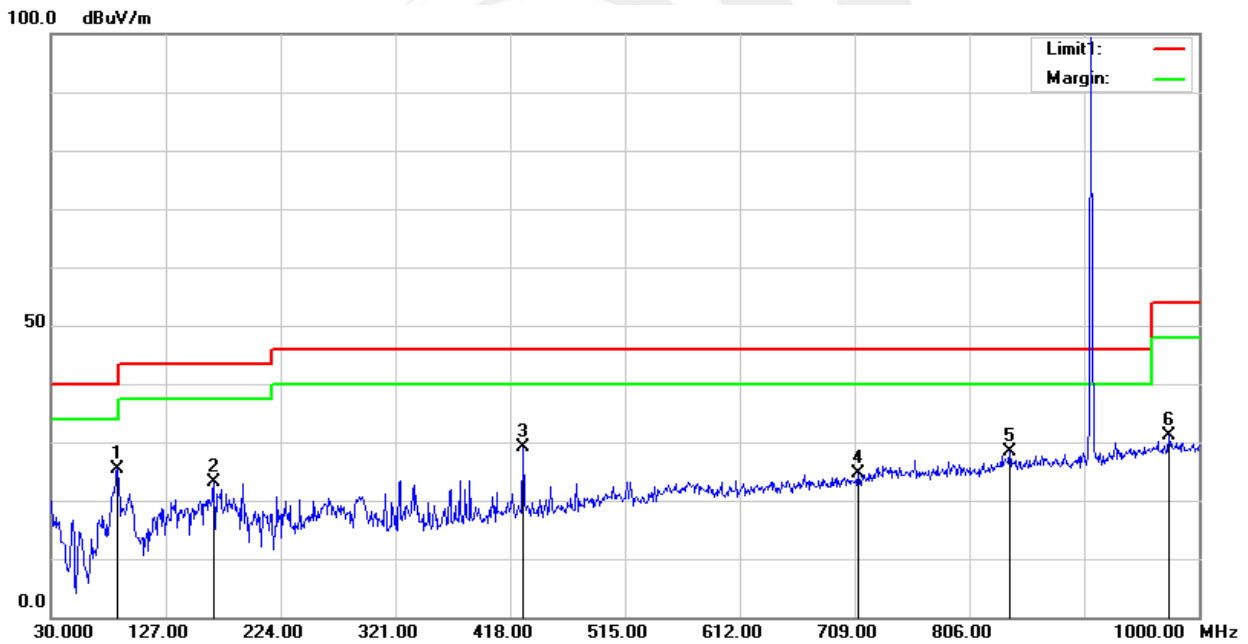



Temperature:	23.1(C)	Relative Humidity:	60%RH
Test Voltage:	DC 13.8V	Phase:	Vertical
Test Mode:	Mode 1		

No.	Frequency (MHz)	Reading (dBuV)	Correct Factor(dB/m)	Result (dBuV/m)	Limit (dBuV/m)	Margin (dB)	Remark
1	30.9700	45.69	-13.35	32.34	40.00	-7.66	peak
2	71.7100	47.59	-24.56	23.03	40.00	-16.97	peak
3	191.9900	42.54	-21.04	21.50	43.50	-22.00	peak
4	404.4200	36.54	-10.88	25.66	46.00	-20.34	peak
5	867.1100	29.91	-0.50	29.41	46.00	-16.59	peak
6	980.6000	27.78	2.63	30.41	54.00	-23.59	peak

Remark:

1. Margin = Result (Result =Reading + Factor )-Limit
2. Factor= Antenna factor+Cable attenuation factor(cable loss)-Amplifier gain

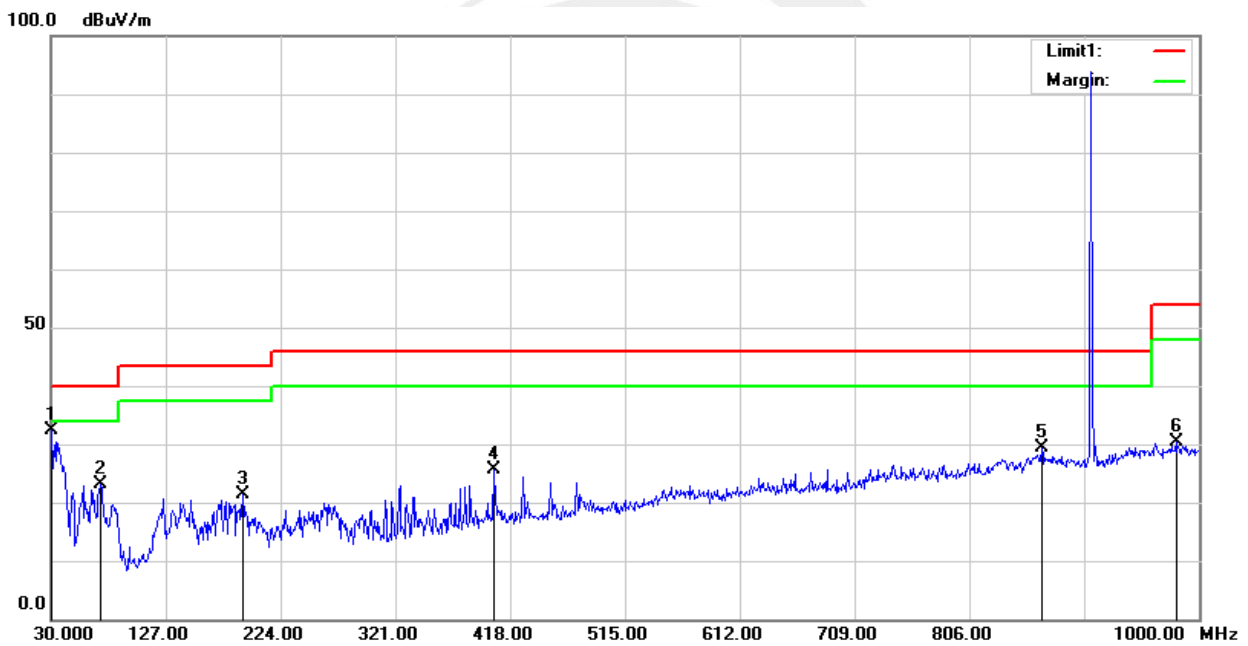





## Above 1G Radiation Spurious

Frequency (MHz)	Meter Reading (dB $\mu$ V/m)	Detector (PK/QP/AV)	Amplifier (dB)	Loss (dB)	Antenna Factor (dB/m)	Orrected Factor (dB)	Corrected Amplitude (dB $\mu$ V/m)	FCC Part 15.249/15.209/205		RX Antenna
								Limit (dB $\mu$ V/m)	Margin (dB)	Polar (H/V)
1816.85	67.60	PK	45.10	4.91	25.00	-15.19	52.41	74	-21.59	H
1816.85	67.13	PK	45.10	4.91	25.00	-15.19	51.94	74	-22.06	V
2725.12	66.12	PK	44.10	5.03	25.80	-13.27	52.85	74	-21.15	H
2725.12	66.74	PK	44.10	5.03	25.80	-13.27	53.47	74	-20.53	V
3633.70	50.66	PK	43.80	6.72	33.40	-3.68	46.98	74	-27.02	H
3633.70	50.86	PK	43.80	6.72	33.40	-3.68	47.18	74	-26.82	V

Note: The peak value is less than the AV limit, so AV data does not need to be tested.





Duty cycle

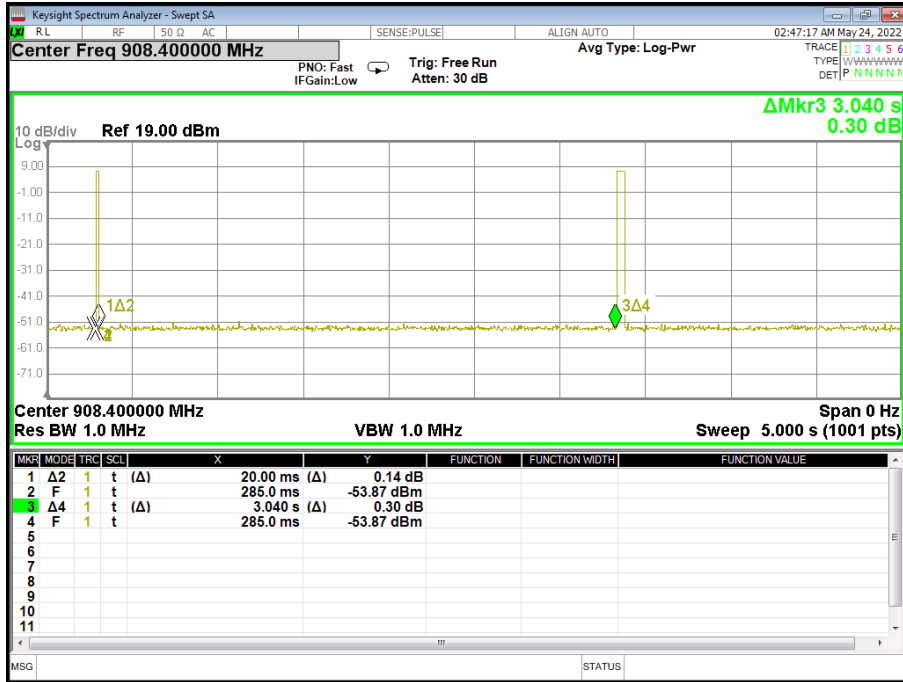

Ton (μs)	Tp (μs)	Duty Factor
20000	3040000	43.64

Note: Duty Factor=20\*LOG10(1/(Ton/Tp))



(Radiation Band edge)

Horizontal

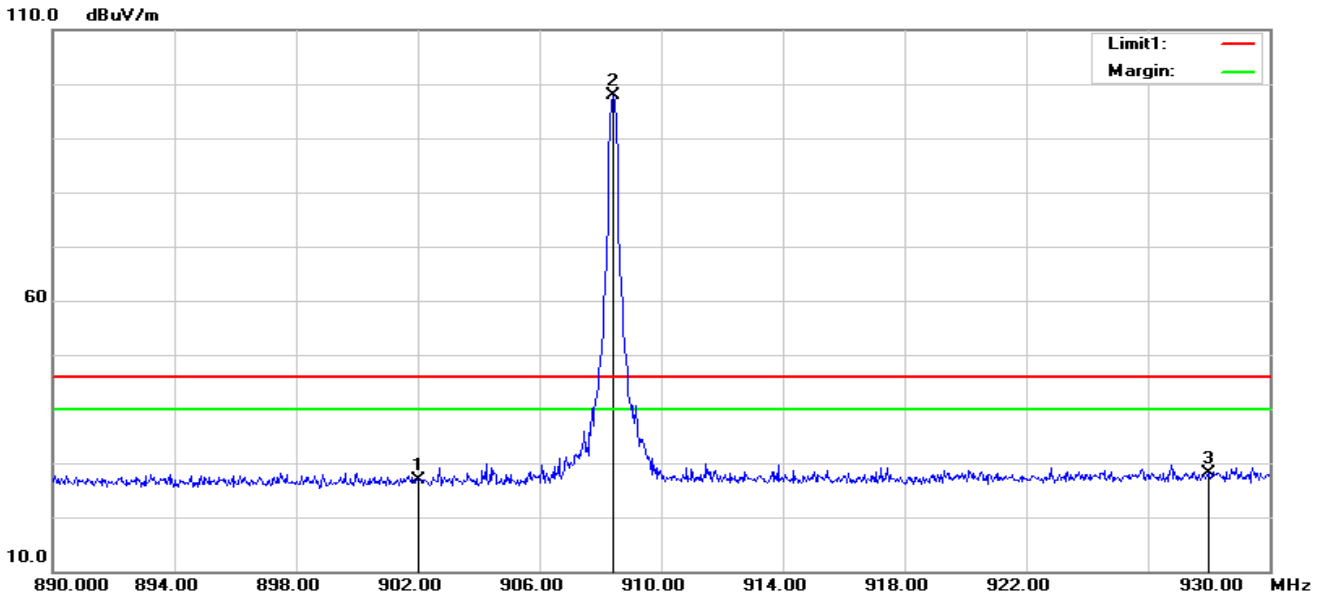

No.	Frequency (MHz)	Reading (dBuV)	Correct Factor(dB/m)	Result (dBuV/m)	Limit (dBuV/m)	Margin (dB)	Remark
1	902.0000	27.29	-0.40	26.89	46.00	-19.11	peak
2	928.0000	27.63	0.43	28.06	46.00	-17.94	peak

Fundamental Frequency

No.	Frequency (MHz)	Reading (dBuV)	Correct Factor(dB/m)	Duty cycle Factor(dB/m)	Result (dBuV/m)	Limit (dBuV/m)	Margin (dB)	Remark
3	908.4400	97.98	-0.22	-	97.76	114	-16.24	peak
4	908.4400	97.98	-0.22	43.64	54.12	94	-39.88	AVG



Vertical

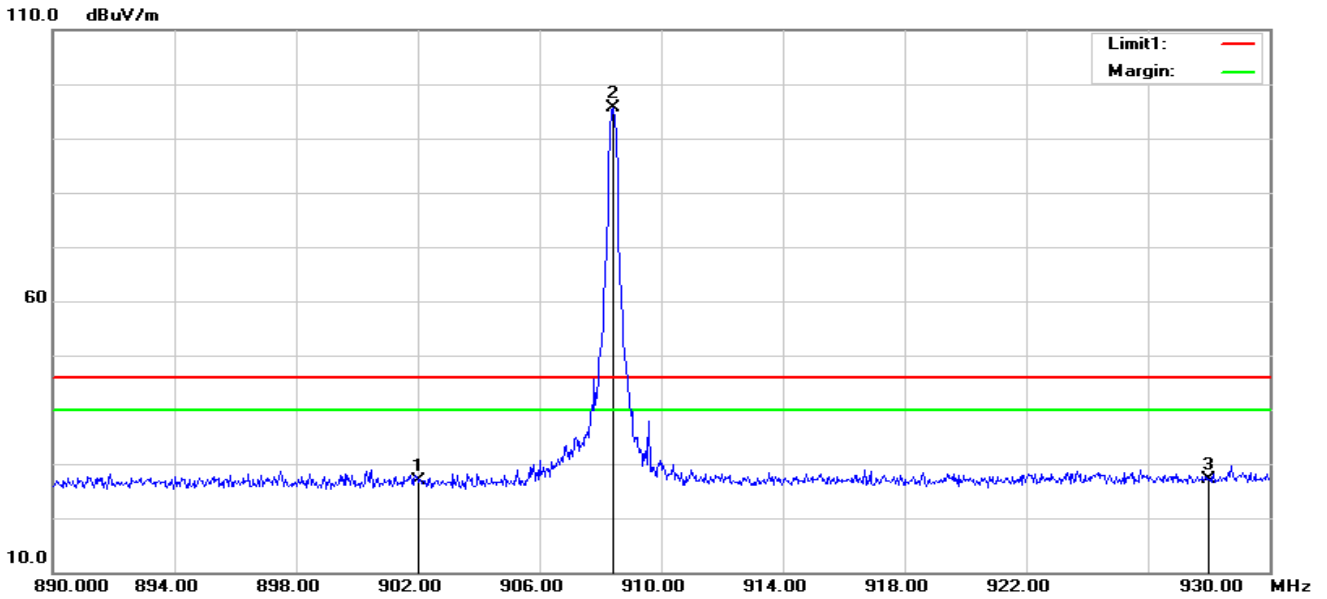

No.	Frequency (MHz)	Reading (dBuV)	Correct Factor(dB/m)	Result (dBuV/m)	Limit (dBuV/m)	Margin (dB)	Remark
1	902.0000	27.32	-0.40	26.92	46.00	-19.08	peak
2	928.0000	26.64	0.43	27.07	46.00	-18.93	peak

Fundamental Frequency

No.	Frequency (MHz)	Reading (dBuV)	Correct Factor(dB/m)	Duty cycle Factor(dB/m)	Result (dBuV/m)	Limit (dBuV/m)	Margin (dB)	Remark
3	908.4000	95.82	-0.23	-	95.59	114	-18.41	peak
4	908.4000	95.82	-0.23	43.64	51.95	94	-42.05	AVG

#### 4. BANDWIDTH TEST

##### 4.1 TEST PROCEDURE

- a. The EUT was directly connected to the spectrum analyzer and antenna output port as show in the block diagram below.
- b. Spectrum Setting : RBW= 1% to 5% OBW, VBW $\geq$ RBW, Sweep time = Auto.

##### 4.2 TEST SETUP



##### 4.3 EUT OPERATION CONDITIONS

TX mode.





4.4 TEST RESULTS

Temperature:	25 °C	Relative Humidity:	50%
Test Voltage:	AC 120V/60Hz		

Test Channel	Frequency(MHz)	20 dB Bandwidth(KHz)	99% Bandwidth(KHz)
CH01	908.4	117	108.97

Mid Channel

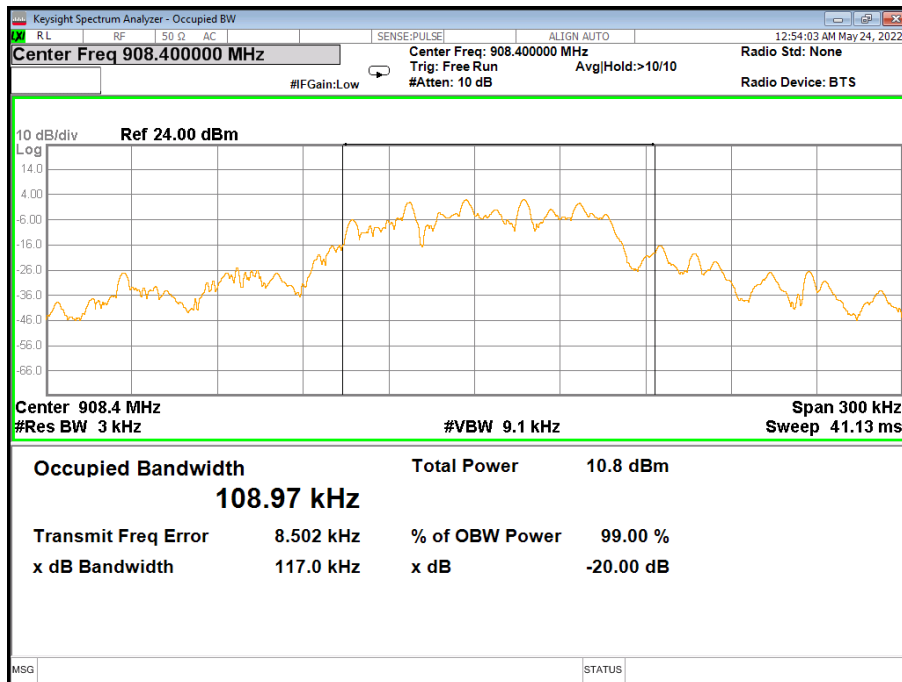



## 5. ANTENNA REQUIREMENT

### 5.1 STANDARD REQUIREMENT

According to the FCC Part 15 Paragraph 15.203, an intentional radiator shall be designed to ensure that no antenna other than that furnished by the responsible party shall be used with the device.

### 5.2 EUT ANTENNA

The EUT antenna is Monopole Antenna. It conforms to the standard requirements.





## APPENDIX- PHOTOS OF TEST SETUP

Note: See test photos in setup photo document for the actual connections between Product and support equipment.

※※※※END OF THE REPORT※※※※

