

TEST REPORT

ACCORDING TO: FCC CFR 47 part 15 subpart C, §15.225 and subpart B

FOR:

Risco Ltd.

Proximity LCD keypad

Model: RP432KPP

FCC ID:JE4RP432KPP

This report is in conformity with ISO/IEC 17025. The "A2LA Accredited" symbol endorsement applies only to the tests and calibrations that are listed in the scope of Hermon Laboratories accreditation. The test results relate only to the items tested.
This test report shall not be reproduced in any form except in full with the written approval of Hermon Laboratories Ltd.

Table of contents

1	Applicant information	3
2	Equipment under test attributes	3
3	Manufacturer information	3
4	Test details	3
5	Tests summary	4
6	EUT description	5
6.1	General information	5
6.2	Ports and lines	5
6.3	Support and test equipment	5
6.4	Changes made in the EUT	5
6.5	Test configuration	5
6.6	Transmitter characteristics	6
7	Transmitter tests according to 47CFR part 15 subpart C requirements	7
7.1	In band radiated emissions	7
7.2	Out of band radiated emissions	12
7.3	Frequency stability test	18
7.4	Conducted emissions	20
7.5	Occupied bandwidth test	23
7.6	Antenna requirements	26
8	Emissions tests according to FCC 47CFR part 15 subpart B requirements	27
8.1	Conducted emissions	27
8.2	Radiated emission measurements	31
9	APPENDIX A Test equipment and ancillaries used for tests	35
10	APPENDIX A Measurement uncertainties	36
11	APPENDIX C Test laboratory description	37
12	APPENDIX D Specification references	37
13	APPENDIX E Test equipment correction factors	38
14	APPENDIX F Abbreviations and acronyms	44

1 Applicant information

Client name: Risco Ltd.
Address: 14 Hahoma Street, Rishon LeZion 75655, Israel
Telephone: +972 3963 7777 ext.710
Fax: +972 3961 6584
E-mail: NimrodH@riscogroup.com
Contact name: Mr. Nimrod Herman

2 Equipment under test attributes

Product name: Proximity LCD keypad
Product type: Transceiver
Model(s): RP432KPP
Serial number: 000A
Hardware version: C
Software release: v0.46
Receipt date 4/1/2012

3 Manufacturer information

Manufacturer name: Risco Ltd.
Address: 14 Hahoma Street, Rishon LeZion 75655, Israel
Telephone: +972 3963 7777 ext.710
Fax: +972 3961 6584
E-Mail: NimrodH@riscogroup.com
Contact name: Mr. Nimrod Herman



4 Test details

Project ID: 23097
Location: Hermon Laboratories Ltd. Harakevet Industrial Zone, Binyamina 30500, Israel
Test started: 4/1/2012
Test completed: 4/1/2012
Test specification(s): FCC CFR 47 part 15 subpart C, §15.225 and subpart B class B

5 Tests summary

Test	Status
Transmitter characteristics	
Sections 15.225(a) (b) (c), In band radiated emissions	Pass
Sections 15.225(d), Out of band radiated emissions	Pass
Section 15.225(e), Frequency stability	Pass
Section 15.207(a), Conducted emission	Pass
Section 15.215(c), Occupied bandwidth	Pass
Section 15.203, Antenna requirements	Pass
Unintentional emissions	
Section 15.107, Conducted emission at AC power port	Pass
Section 15.109, Radiated emission	Pass

Testing was completed against all relevant requirements of the test standard. The results obtained indicate that the product under test complies in full with the requirements tested.
The test results relate only to the items tested. Pass/ fail decision was based on nominal values.

	Name and Title	Date	Signature
Tested by:	Mr. S. Samokha, test engineer	April 1, 2012	
Reviewed by:	Mrs. M. Cherniavsky, certification engineer	April 9, 2012	
Approved by:	Mr. M. Nikishin, EMC and Radio group manager	April 17, 2012	

6 EUT description

6.1 General information

The EUT, RP432KPP keypad, is a part of LightSys system. The RF part is an RFID feature which allows to arm/disarm the keypad using a proximity tag.

6.2 Ports and lines

Port type	Port description	Connected from	Connected to	Qty.	Cable type	Cable length, m
Power	DC+signal	Main panel	EUT	1	Unshielded	10
Power	AC power	Mains	Main panel	1	Unshielded	1.5

6.3 Support and test equipment

Description	Manufacturer	Model number	Serial number
Main panel, HW rev D, SW release v1.40	Risco Ltd.	RP432M	000005

6.4 Changes made in the EUT

No changes were implemented.

6.5 Test configuration

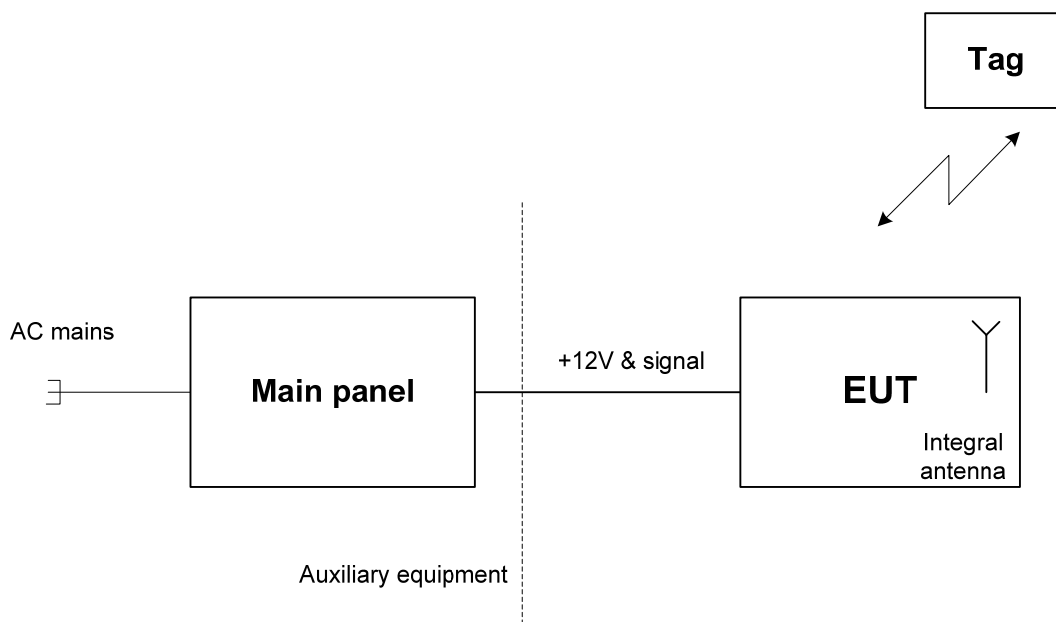



6.6 Transmitter characteristics

Type of equipment			
V	Stand-alone (Equipment with or without its own control provisions)		
	Combined equipment (Equipment where the radio part is fully integrated within another type of equipment)		
	Plug-in card (Equipment intended for a variety of host systems)		
Assigned frequency range		13.110-14.010 MHz	
Operating frequency		13.56 MHz	
Is transmitter output power variable?	V	No	
		continuous variable	
	Yes	stepped variable with stepsize dB	
		minimum RF power	dBm
		maximum RF power	dBm
Antenna connection			
unique coupling	standard connector	V	integral
		V	without temporary RF connector
Antenna/s technical characteristics			
Type	Manufacturer	Model number	Gain
Printed	Risco	NA	2 dBi
Type of modulation		ASK	
Modulating test signal		ID code	
Transmitter power source			
	Battery	Nominal rated voltage	Battery type
	DC	Nominal rated voltage	
V	AC mains	Nominal rated voltage	120 VAC/12 VDC from main panel
Common power source for transmitter and receiver			yes



Test specification:	Sections 15.225(a) (b) (c), In band radiated emissions		
Test procedure:	ANSI C63.4, Sections 5.3 and 13.1.4		
Test mode:	Compliance	Verdict:	PASS
Date(s):	4/1/2012		
Temperature: 22.3 °C	Air Pressure: 1011 hPa	Relative Humidity: 38 %	Power Supply: 120 VAC
Remarks:			

7 Transmitter tests according to 47CFR part 15 subpart C requirements

7.1 In band radiated emissions

7.1.1 General

This test was performed to measure field strength of fundamental emission and modulation products from the EUT within the assigned band. Specification test limits are given in Table 7.1.1.

Table 7.1.1 Radiated emission limits

Frequency, MHz	Field strength at 30 m distance*		Field strength at 3 m distance*	
	µV/m	dB(µV/m)	µV/m	dB(µV/m)**
13.110 – 13.410	106	40.5	10600	80.5
13.410 – 13.553	334	50.5	33400	90.5
13.553 – 13.567	15848	84.0	1584800	124.0
13.567 – 13.710	334	50.5	33400	90.5
13.710 – 14.010	106	40.5	10600	80.5

*- The limit is provided in quasi peak values.

** - The limit for 3 m test distance was calculated using the inverse square distance extrapolation factor as follows:

$$\text{Lim}_{S_2} = \text{Lim}_{S_1} + 40 \log (S_1/S_2),$$

where S_1 and S_2 – standard defined and test distance respectively in meters.

7.1.2 Test procedure

7.1.2.1 The EUT was set up as shown in Figure 7.1.1 energized and the performance check was conducted.

7.1.2.2 The specified frequency range was investigated with loop antenna connected to spectrum analyzer/ EMI receiver. To find maximum radiation the turntable was rotated 360° , the measuring antenna was rotated around its vertical axis and the measuring antenna polarization was switched from vertical to horizontal.

7.1.2.3 The worst test results (the lowest margins) were recorded in Table 7.1.2 and shown in the associated plots.



Test specification:	Sections 15.225(a) (b) (c), In band radiated emissions		
Test procedure:	ANSI C63.4, Sections 5.3 and 13.1.4		
Test mode:	Compliance	Verdict:	PASS
Date(s):	4/1/2012		
Temperature: 22.3 °C	Air Pressure: 1011 hPa	Relative Humidity: 38 %	Power Supply: 120 VAC
Remarks:			

Figure 7.1.1 Setup for in band radiated emission measurements

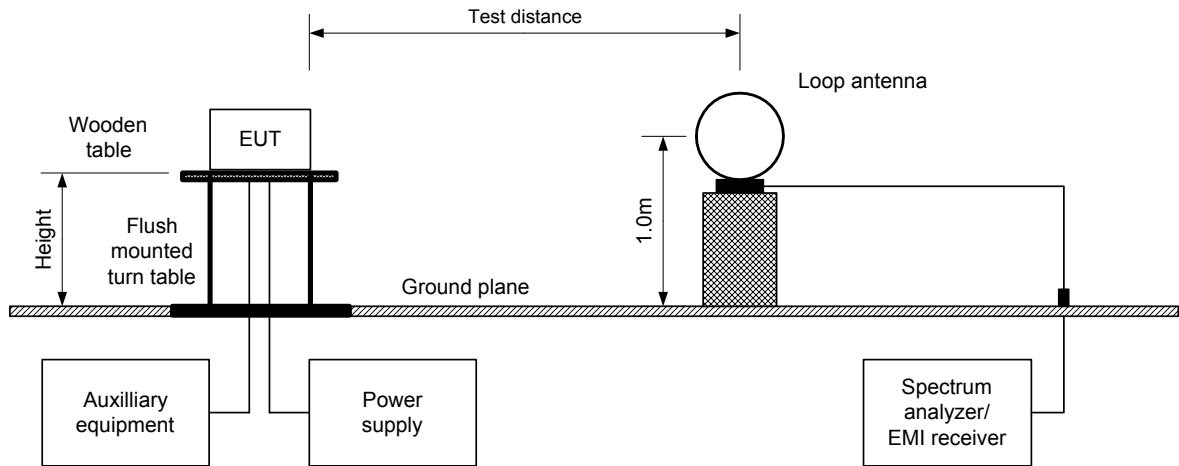



Test specification:		Sections 15.225(a) (b) (c), In band radiated emissions	
Test procedure:		ANSI C63.4, Sections 5.3 and 13.1.4	
Test mode:		Compliance	
Date(s):		4/1/2012	
Temperature: 22.3 °C		Air Pressure: 1011 hPa	
		Relative Humidity: 38 %	
		Power Supply: 120 VAC	
Remarks:			

Table 7.1.2 In band radiated emission test results

TEST DISTANCE: 3 m
 EUT POSITION: Typical (Vertical)
 MODULATION: CW
 MODULATING SIGNAL: ID code
 TRANSMITTER OUTPUT POWER SETTINGS: Maximum
 INVESTIGATED FREQUENCY RANGE: 13.110 – 14.010 MHz
 RESOLUTION BANDWIDTH: 9.0 kHz
 VIDEO BANDWIDTH: 30.0 kHz

Carrier frequency, MHz	Peak emission, dB(µV/m)	Quasi-peak			Antenna polarization	Azimuth**, degrees	Verdict	
		Measured emission, dB(µV/m)	Limit, dB(µV/m)	Margin, dB*				
Unom								
13.5598	64.32	64.32	124.0	-59.68	Vertical	177	Pass	
115%Unom								
13.5588	64.20	64.20	124.0	-59.80	Vertical	177		
85%Unom								
135595	64.43	64.43	124.0	-59.57	Vertical	177		

*- Margin = Measured emission - specification limit.
 **- EUT front panel refer to 0 degrees position of turntable.

Reference numbers of test equipment used

HL 0446	HL 0521	HL 2871	HL 3617				
---------	---------	---------	---------	--	--	--	--

Full description is given in Appendix A.



HERMON LABORATORIES

Test specification:		Sections 15.225(a) (b) (c), In band radiated emissions	
Test procedure:		ANSI C63.4, Sections 5.3 and 13.1.4	
Test mode:		Compliance	
Date(s):		4/1/2012	
Temperature: 22.3 °C		Air Pressure: 1011 hPa	
		Relative Humidity: 38 %	
		Power Supply: 120 VAC	
Remarks:			

Plot 7.1.1 Fundamental emission test result

TEST SITE: Semi anechoic chamber
TEST DISTANCE: 3 m
DETECTOR: Peak hold
EUT POSITION: Typical (Vertical)
INPUT VOLTAGE: Unom

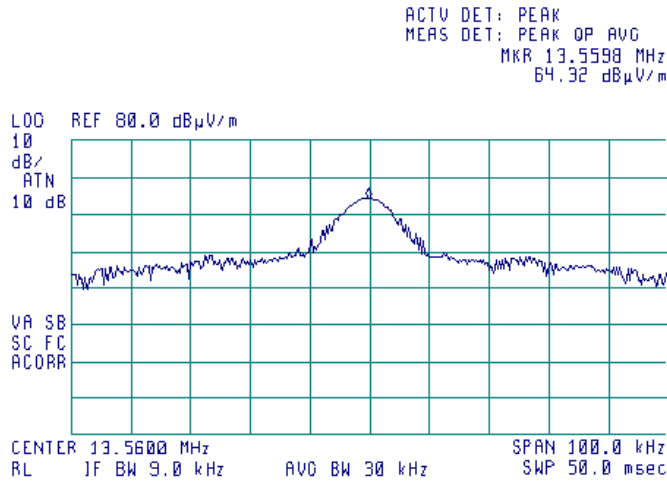

Plot 7.1.2 Fundamental emission test result

TEST SITE: Semi anechoic chamber
TEST DISTANCE: 3 m
DETECTOR: Peak hold
EUT POSITION: Typical (Vertical)
INPUT VOLTAGE: 115%Unom

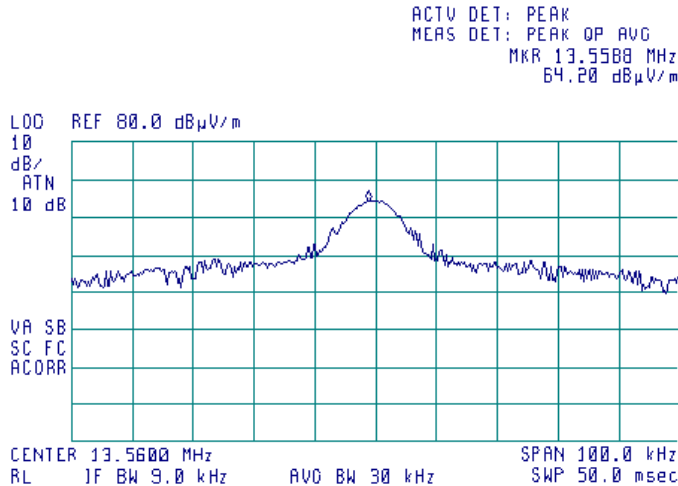



HERMON LABORATORIES

Test specification:		Sections 15.225(a) (b) (c), In band radiated emissions	
Test procedure:		ANSI C63.4, Sections 5.3 and 13.1.4	
Test mode:		Compliance	
Date(s):		4/1/2012	
Temperature: 22.3 °C		Air Pressure: 1011 hPa	
		Relative Humidity: 38 %	
		Power Supply: 120 VAC	
Remarks:			
		Verdict: PASS	

Plot 7.1.3 Fundamental emission test result

TEST SITE: Semi anechoic chamber
 TEST DISTANCE: 3 m
 DETECTOR: Peak hold
 EUT POSITION: Typical (Vertical)
 INPUT VOLTAGE: 85%Unom

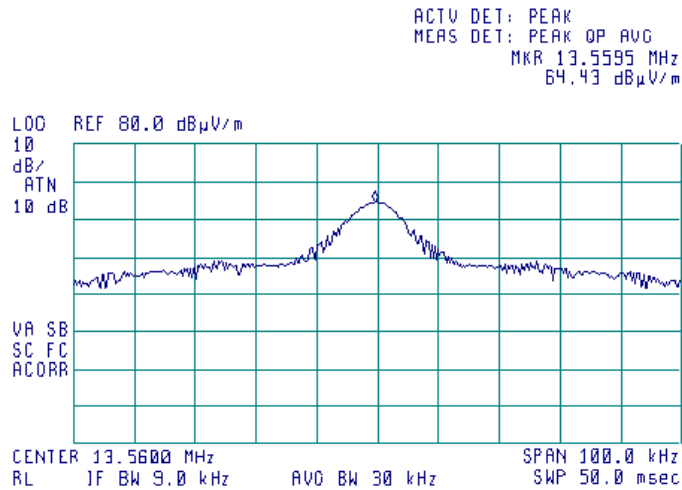

Plot 7.1.4 In band radiated emission test results

TEST SITE: Semi anechoic chamber
 TEST DISTANCE: 3 m
 DETECTOR: Peak hold

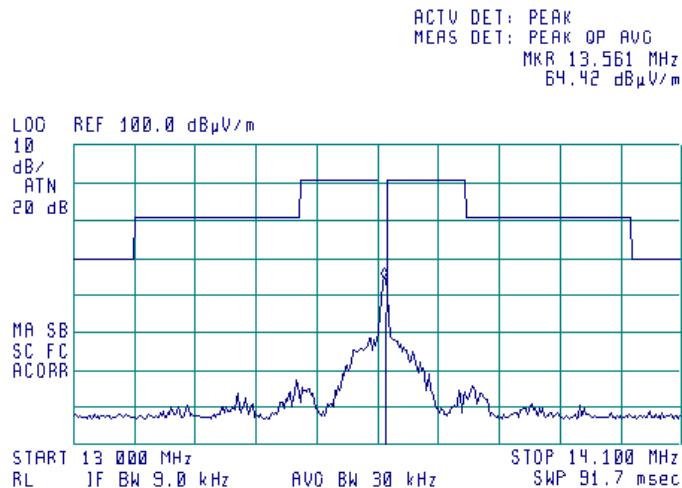



Test specification:		Sections 15.225(d), Out of band radiated emissions	
Test procedure:		ANSI C63.4, Sections 5.3 and 13.1.4	
Test mode:		Compliance	
Date(s):		4/1/2012	
Temperature: 22.3 °C		Air Pressure: 1011 hPa	
Remarks:		Verdict: PASS	
		Relative Humidity: 38 %	
		Power Supply: 120 VAC	

7.2 Out of band radiated emissions

7.2.1 General

This test was performed to measure field strength of spurious emissions from the EUT. Specification test limits are given in Table 7.2.1.

Table 7.2.1 Radiated emission limits

Frequency, MHz	Field strength at 3 m within restricted bands, dB(μV/m)***		
	Peak	Quasi Peak	Average
0.009 – 0.090	148.5 – 128.5	NA	128.5 – 108.5**
0.090 – 0.110	NA	108.5 – 106.8**	NA
0.110 – 0.490	126.8 – 113.8	NA	106.8 – 93.8**
0.490 – 1.705	NA	73.8 – 63.0**	NA
1.705 – 30.0*		69.5**	
30 – 88		40.0	
88 – 216		43.5	
216 – 960		46.0	
960 - 1000		54.0	

*- The above field strength limits applied from the lowest radio frequency generated in the device, without going below 9 kHz up to the tenth harmonic of the highest fundamental frequency.

** - The limit for 3 m test distance was calculated using the inverse square distance extrapolation factor as follows:

$$\text{Lim}_{S_2} = \text{Lim}_{S_1} + 40 \log (S_1/S_2),$$

where S_1 and S_2 – standard defined and test distance respectively in meters.

*** - The limit decreases linearly with the logarithm of frequency.

7.2.2 Test procedure for spurious emission field strength measurements in 9 kHz to 30 MHz band

7.2.2.1 The EUT was set up as shown in Figure 7.2.1, energized and the performance check was conducted.

7.2.2.2 The specified frequency range was investigated with loop antenna connected to spectrum analyzer/ EMI receiver. To find maximum radiation the turntable was rotated 360°, the measuring antenna was rotated around its vertical axis and the measuring antenna polarization was switched from vertical to horizontal.

7.2.2.3 The worst test results (the lowest margins) were recorded in Table 7.2.2 and shown in the associated plots.

7.2.3 Test procedure for spurious emission field strength measurements above 30 MHz

7.2.3.1 The EUT was set up as shown in Figure 7.2.2, energized and the performance check was conducted.

7.2.3.2 The specified frequency range was investigated with antenna connected to spectrum analyzer/ EMI receiver. To find maximum radiation the turntable was rotated 360°, the measuring antenna height was changed from 1 to 4 m, its polarization was switched from vertical to horizontal.

7.2.3.3 The worst test results (the lowest margins) were recorded in Table 7.2.2 and shown in the associated plots.



Test specification:	Sections 15.225(d), Out of band radiated emissions		
Test procedure:	ANSI C63.4, Sections 5.3 and 13.1.4		
Test mode:	Compliance	Verdict:	PASS
Date(s):	4/1/2012		
Temperature: 22.3 °C	Air Pressure: 1011 hPa	Relative Humidity: 38 %	Power Supply: 120 VAC
Remarks:			

Figure 7.2.1 Radiated emissions below 30 MHz test set up

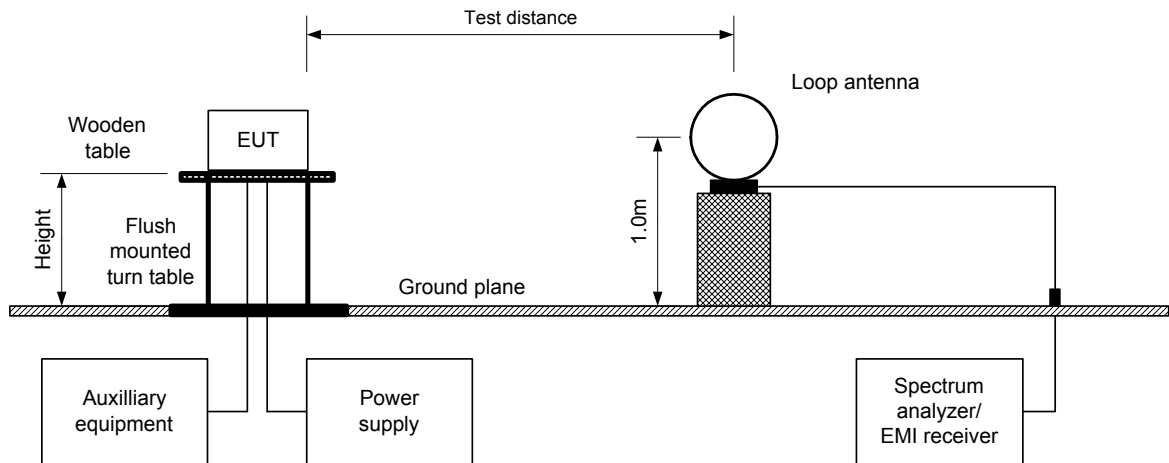
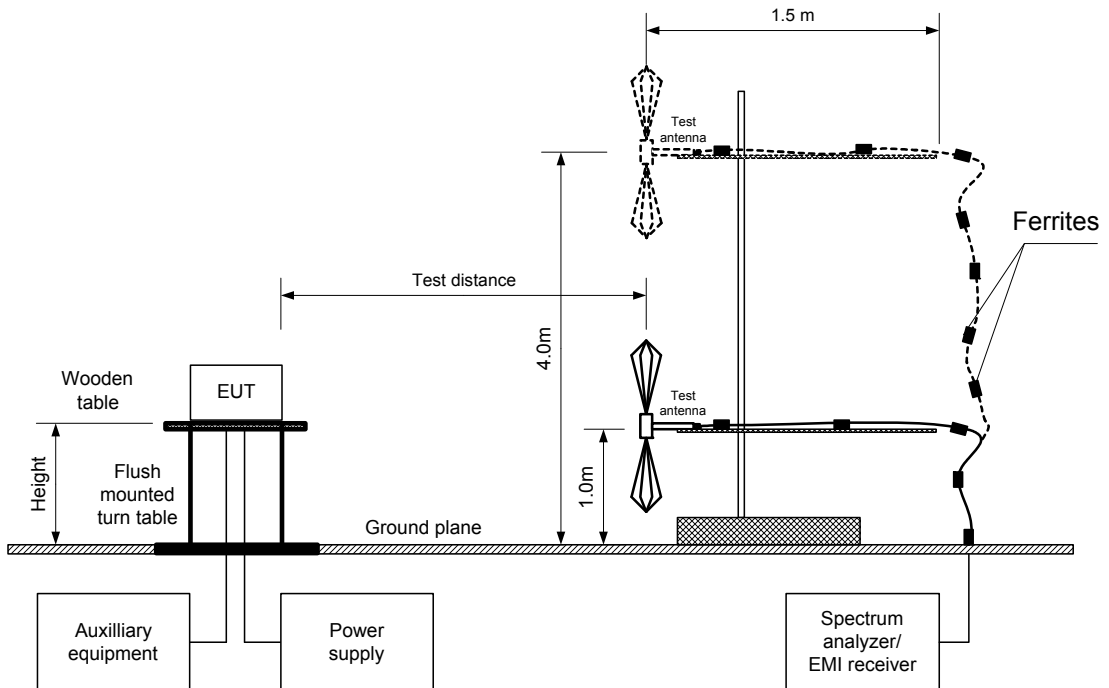

Figure 7.2.2 Radiated emissions above 30 MHz test set up





Test specification:		Sections 15.225(d), Out of band radiated emissions	
Test procedure:		ANSI C63.4, Sections 5.3 and 13.1.4	
Test mode:		Compliance	
Date(s):		4/1/2012	
Temperature: 22.3 °C		Air Pressure: 1011 hPa	
		Relative Humidity: 38 %	
		Power Supply: 120 VAC	
Remarks:			

Table 7.2.2 Out of band radiated emissions test results

TEST DISTANCE: 3 m
 EUT POSITION: Typical (Vertical)
 MODULATION: CW
 MODULATING SIGNAL: ID code
 TRANSMITTER OUTPUT POWER SETTINGS: Maximum
 INVESTIGATED FREQUENCY RANGE: 0.009 – 1000 MHz
 RESOLUTION BANDWIDTH: 1.0 kHz (9 kHz – 150 kHz)
 9.0 kHz (150 kHz – 30 MHz)
 120 kHz (30 MHz – 1000 MHz)
 VIDEO BANDWIDTH: ≥ Resolution bandwidth
 TEST ANTENNA TYPE: Active loop (9 kHz – 30 MHz)
 Biconilog (30 MHz – 1000 MHz)

Frequency, MHz	Peak emission, dB(µV/m)	Quasi-peak			Antenna polarization	Antenna height, m	Turn-table position**, degrees	Verdict
		Measured emission, dB(µV/m)	Limit, dB(µV/m)	Margin, dB*				
40.680275	27.0	24.6	40.0	-15.4	Vertical	1.3	100	Pass
67.800000	41.1	30.8	40.0	-9.2	Vertical	1.0	197	
135.60000	34.0	29.7	43.5	-13.8	Vertical	1.0	73	
230.52000	34.5	25.9	46.0	-20.1	Vertical	1.0	177	
338.98300	44.8	38.2	46.0	-7.8	Vertical	1.4	336	
379.68000	42.4	38.0	46.0	-8.0	Vertical	1.3	333	
610.20000	47.0	39.8	46.0	-6.2	Vertical	1.0	316	
623.76000	47.0	38.8	46.0	-7.2	Vertical	1.0	338	

*- Margin = Measured emission - specification limit.
 **- EUT front panel refer to 0 degrees position of turntable.

Reference numbers of test equipment used

HL 0446	HL 0521	HL 0604	HL 2871	HL 3617			
---------	---------	---------	---------	---------	--	--	--

Full description is given in Appendix A.



HERMON LABORATORIES

Test specification:		Sections 15.225(d), Out of band radiated emissions	
Test procedure:		ANSI C63.4, Sections 5.3 and 13.1.4	
Test mode:		Compliance	
Date(s):		4/1/2012	
Temperature: 22.3 °C		Air Pressure: 1011 hPa	
		Relative Humidity: 38 %	
		Power Supply: 120 VAC	
Remarks:			

Plot 7.2.1 Radiated emission measurements from 9 to 150 kHz

TEST SITE: Semi anechoic chamber
 TEST DISTANCE: 3 m
 ANTENNA POLARIZATION: Vertical
 DETECTOR: Peak hold

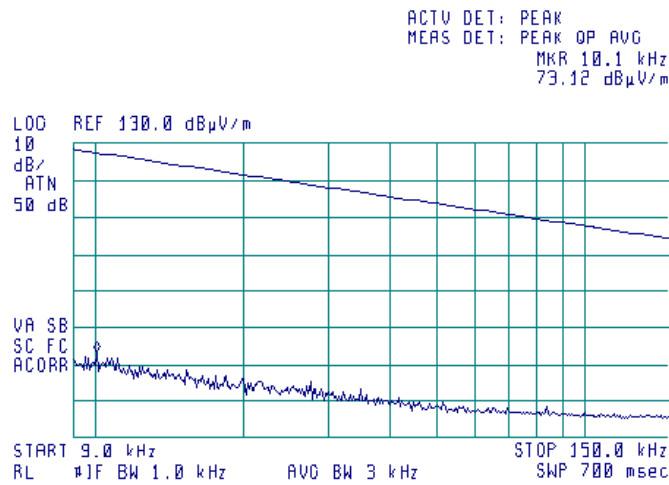

Plot 7.2.2 Radiated emission measurements from 9 to 150 kHz

TEST SITE: Semi anechoic chamber
 TEST DISTANCE: 3 m
 ANTENNA POLARIZATION: Horizontal
 DETECTOR: Peak hold

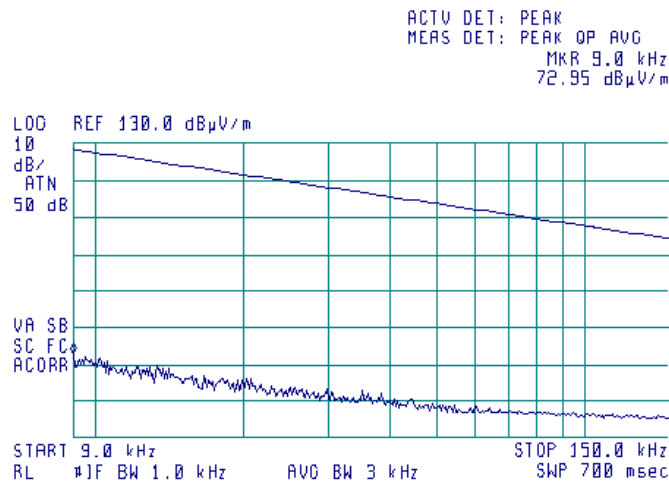



HERMON LABORATORIES

Test specification:		Sections 15.225(d), Out of band radiated emissions	
Test procedure:		ANSI C63.4, Sections 5.3 and 13.1.4	
Test mode:		Compliance	
Date(s):		4/1/2012	
Temperature: 22.3 °C		Air Pressure: 1011 hPa	
Relative Humidity: 38 %		Power Supply: 120 VAC	
Remarks:			
Verdict: PASS			

Plot 7.2.3 Radiated emission measurements from 0.15 to 30 MHz

TEST SITE: Semi anechoic chamber
 TEST DISTANCE: 3 m
 ANTENNA POLARIZATION: Vertical
 DETECTOR: Peak hold

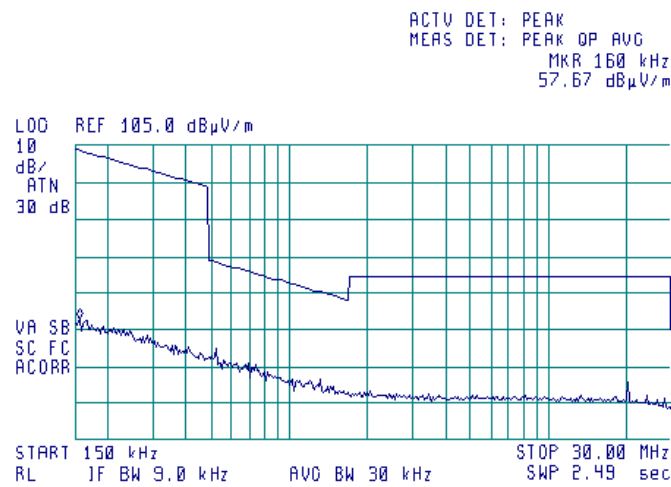

Plot 7.2.4 Radiated emission measurements from 0.15 to 30 MHz

TEST SITE: Semi anechoic chamber
 TEST DISTANCE: 3 m
 ANTENNA POLARIZATION: Horizontal
 DETECTOR: Peak hold

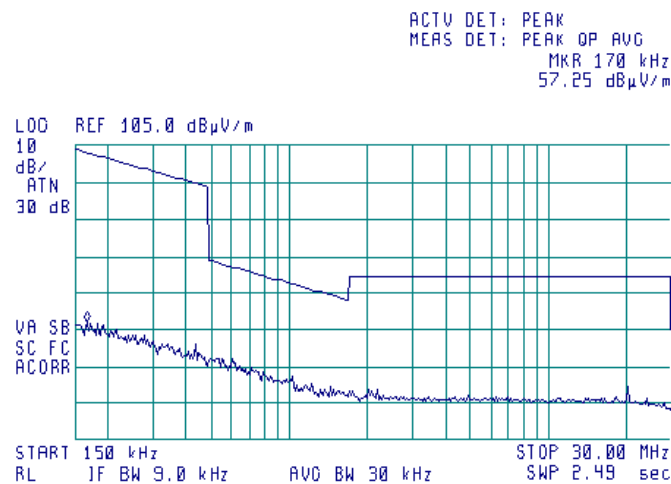



HERMON LABORATORIES

Test specification:		Sections 15.225(d), Out of band radiated emissions	
Test procedure:		ANSI C63.4, Sections 5.3 and 13.1.4	
Test mode:		Compliance	
Date(s):		4/1/2012	
Temperature: 22.3 °C		Air Pressure: 1011 hPa	
		Relative Humidity: 38 %	
		Power Supply: 120 VAC	
Remarks:			
		Verdict: PASS	

Plot 7.2.5 Radiated emission measurements from 30 to 1000 MHz

TEST SITE: Semi anechoic chamber
 TEST DISTANCE: 3 m
 ANTENNA POLARIZATION: Vertical
 DETECTOR: Peak hold

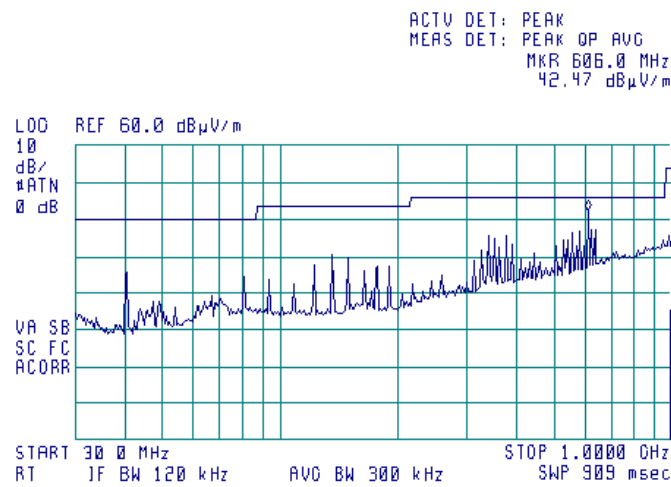

Plot 7.2.6 Radiated emission measurements from 30 to 1000 MHz

TEST SITE: Semi anechoic chamber
 TEST DISTANCE: 3 m
 ANTENNA POLARIZATION: Horizontal
 DETECTOR: Peak hold

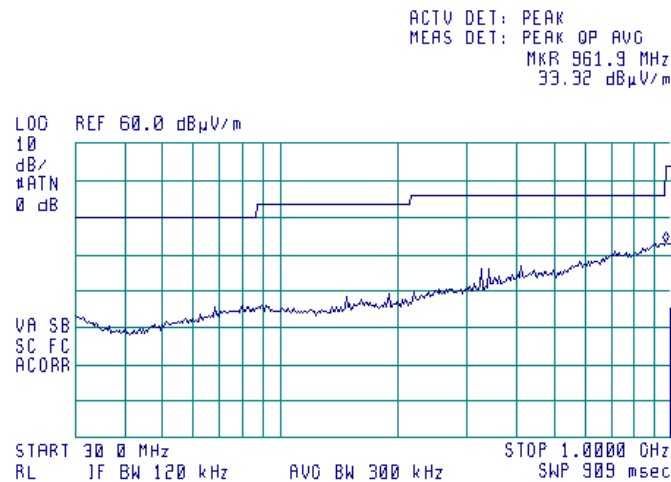



Test specification:		Section 15.225(e), Frequency stability	
Test procedure:		ANSI C63.4, Section 13.1.6	
Test mode:		Compliance	
Date(s):		4/1/2012	
Temperature: 22.3 °C		Air Pressure: 1011 hPa	
		Relative Humidity: 38 %	
		Power Supply: 120 VAC	
Remarks:			

7.3 Frequency stability test

7.3.1 General

This test was performed to measure frequency stability of transmitter RF carrier. Specification test limits are given in Table 7.3.1.

Table 7.3.1 Frequency stability limits

Assigned frequency, MHz	Maximum allowed frequency displacement	
	%	Hz
13.560	± 0.01 %	1356

7.3.2 Test procedure

- 7.3.2.1 The EUT was set up as shown in Figure 7.3.1, energized and its proper operation was checked.
- 7.3.2.2 The EUT power was turned off. Temperature within test chamber was set to the required one and a period of time sufficient to stabilize all of the oscillator circuit components was allowed.
- 7.3.2.3 The EUT was powered on and carrier frequency was measured at start up moment and then after 2, 5 and 10 minutes. The EUT was powered off.
- 7.3.2.4 The above procedure was repeated at the rest of the test temperatures and voltages as provided in Table 7.3.2.
- 7.3.2.5 Frequency displacement was calculated and compared with the limit as provided in Table 7.3.2.

Figure 7.3.1 Frequency stability test setup

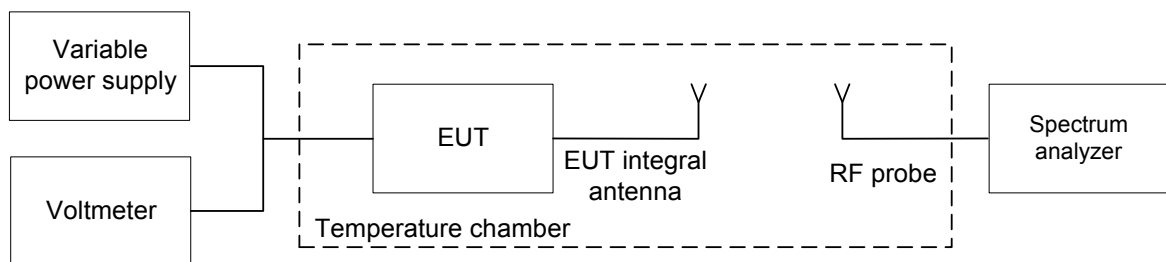



Test specification: Section 15.225(e), Frequency stability			
Test procedure: ANSI C63.4, Section 13.1.6			
Test mode: Compliance		Verdict: PASS	
Date(s): 4/1/2012			
Temperature: 22.3 °C	Air Pressure: 1011 hPa	Relative Humidity: 38 %	Power Supply: 120 VAC
Remarks:			

Table 7.3.2 Frequency stability test results

OPERATING FREQUENCY: 13.5596 MHz
 NOMINAL POWER VOLTAGE: 120 VAC
 TEMPERATURE STABILIZATION PERIOD: 20 min
 POWER DURING TEMPERATURE TRANSITION: Off
 SPECTRUM ANALYZER MODE: Counter
 RESOLUTION BANDWIDTH: 100 Hz
 VIDEO BANDWIDTH: 300 Hz
 MODULATION: Unmodulated

Temperature, °C	Voltage, V	Frequency, MHz				Max frequency drift, Hz		Limit, Hz	Margin, Hz	Verdict
		Start up	2 nd min	5 th min	10 th min	Positive	Negative			
-20	nominal	13.559633	13.559643	13.559637	13.559653	16	-4	1356	1340	Pass
20	nominal +15%	13.559626	NA	NA	13.559638	1	-11		1345	
20	nominal	13.559604	NA	NA	13.559637*	0	-33		1323	
20	nominal -15%	13.559614	NA	NA	13.55964	3	-23		1333	
50	nominal	13.559586	13.559599	13.559589	13.559595	0	-51		1305	

* - Reference frequency

Reference numbers of test equipment used

HL 0337	HL 1194	HL 1481	HL 3818				
---------	---------	---------	---------	--	--	--	--

Full description is given in Appendix A.



Test specification: Section 15.207(a), Conducted emission	
Test procedure:	ANSI C63.4, Section 13.1.3
Test mode:	Compliance
Date(s):	4/1/2012
Temperature: 22.3 °C	Air Pressure: 1011 hPa
Relative Humidity: 38.1 %	Power Supply: 120 VAC
Remarks:	
Verdict: PASS	

7.4 Conducted emissions

7.4.1 General

This test was performed to measure common mode conducted emissions at the power port. Specification test limits are given in Table 7.4.1.

Table 7.4.1 Limits for conducted emissions

Frequency, MHz	Class B limit, dB(μV)	
	QP	AVRG
0.15 - 0.5	66 - 56*	56 - 46*
0.5 - 5.0	56	46
5.0 - 30	60	50

* The limit decreases linearly with the logarithm of frequency.

7.4.2 Test procedure

7.4.2.1 The EUT was set up as shown in Figure 7.4.1, energized and the performance check was conducted.

7.4.2.2 The measurements were performed at power terminals with the LISN, connected to a spectrum analyzer in the frequency range referred to in Table 7.4.2. Unused coaxial connector of the LISN was terminated with 50 Ohm. Quasi-peak and average detectors were used throughout the testing.

7.4.2.3 The position of the device cables was varied to determine maximum emission level.

7.4.2.4 The worst test results (the lowest margins) were recorded in Table 7.4.2 and shown in the associated plots.

Figure 7.4.1 Setup for conducted emission measurements, table-top equipment

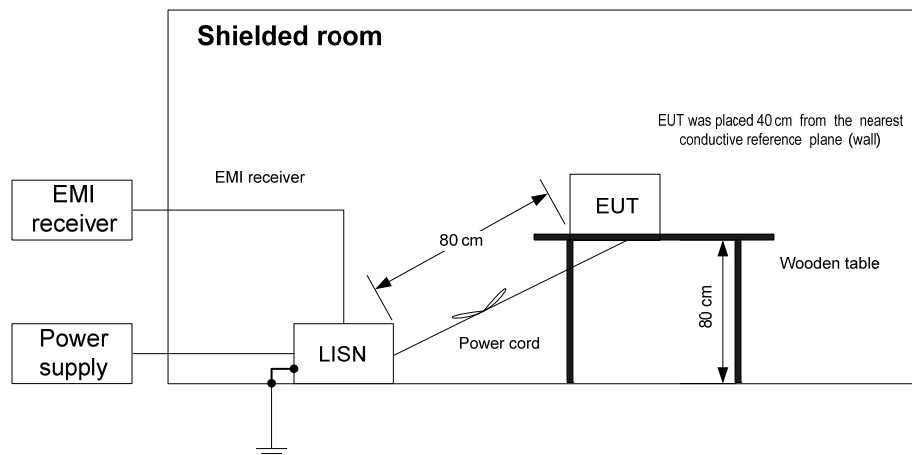



Test specification:		Section 15.207(a), Conducted emission	
Test procedure:		ANSI C63.4, Section 13.1.3	
Test mode:		Compliance	
Date(s):		4/1/2012	
Temperature: 22.3 °C		Air Pressure: 1011 hPa	
		Relative Humidity: 38.1 %	
		Power Supply: 120 VAC	
Remarks:			

Table 7.4.2 Conducted emission test results

LINE: AC mains
 EUT OPERATING MODE: Transmit
 EUT SET UP: TABLE-TOP
 TEST SITE: SHIELDED ROOM
 DETECTORS USED: PEAK / QUASI-PEAK / AVERAGE
 FREQUENCY RANGE: 150 kHz - 30 MHz
 RESOLUTION BANDWIDTH: 9 kHz

Frequency, MHz	Peak emission, dB(µV)	Quasi-peak			Average			Line ID	Verdict
		Measured emission, dB(µV)	Limit, dB(µV)	Margin, dB*	Measured emission, dB(µV)	Limit, dB(µV)	Margin, dB*		
0.151825	58.56	53.46	65.91	-12.45	38.03	55.91	-17.88	L1	Pass
0.167190	57.49	49.16	65.16	-16.00	26.43	55.16	-28.73		
0.208900	50.84	45.62	63.31	-17.69	30.37	53.31	-22.94		
0.234025	48.09	43.10	62.35	-19.25	27.01	52.35	-25.34		
0.560625	38.20	32.46	56.00	-23.54	22.60	46.00	-23.40		
0.151050	58.02	52.91	65.95	-13.04	37.92	55.95	-18.03	L2	Pass
0.166430	54.76	48.78	65.20	-16.42	24.89	55.20	-30.31		
0.204398	51.49	45.79	63.48	-17.69	29.50	53.48	-23.98		
0.231515	49.67	42.25	62.44	-20.19	24.51	52.44	-27.93		
0.553460	35.53	33.28	56.00	-22.72	24.47	46.00	-21.53		

*- Margin = Measured emission - specification limit.

Reference numbers of test equipment used

HL 0521	HL 0580	HL 2888	HL 3617	HL 3776			
---------	---------	---------	---------	---------	--	--	--

Full description is given in Appendix A.



Test specification:	Section 15.207(a), Conducted emission		
Test procedure:	ANSI C63.4, Section 13.1.3		
Test mode:	Compliance	Verdict:	PASS
Date(s):	4/1/2012		
Temperature: 22.3 °C	Air Pressure: 1011 hPa	Relative Humidity: 38.1 %	Power Supply: 120 VAC
Remarks:			

Plot 7.4.1 Conducted emission measurements

LINE: L1
EUT OPERATING MODE: Transmit
LIMIT: QUASI-PEAK, AVERAGE
DETECTOR: PEAK



ACTV DET: PEAK
MEAS DET: PEAK QP AVG
MKR 150 kHz
56.03 dBµV

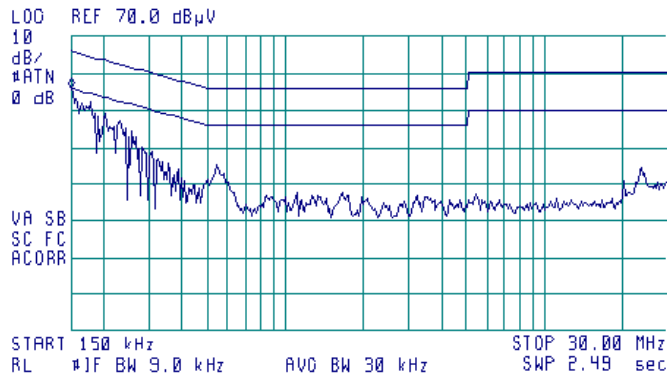

Plot 7.4.2 Conducted emission measurements

LINE: L2
EUT OPERATING MODE: Transmit
LIMIT: QUASI-PEAK, AVERAGE
DETECTOR: PEAK



ACTV DET: PEAK
MEAS DET: PEAK QP AVG
MKR 150 kHz
56.43 dBµV

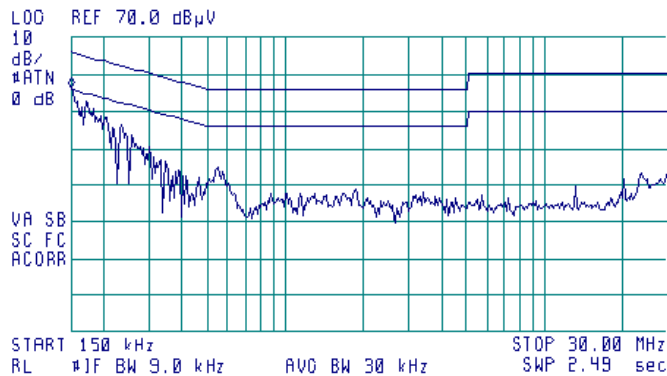



Test specification:	Section 15.215(c), Occupied bandwidth		
Test procedure:	ANSI C63.4, Section 13.1.7		
Test mode:	Compliance	Verdict:	PASS
Date(s):	4/1/2012		
Temperature: 22.3 °C	Air Pressure: 1011 hPa	Relative Humidity: 38 %	Power Supply: 120 VAC
Remarks:			

7.5 Occupied bandwidth test

7.5.1 General

This test was performed to verify that the 20 dB bandwidth of the emissions was contained within the standard specified frequency band according to FCC §15.215 requirements. Specification test limits are given in Table 7.3.1.

Table 7.5.1 Occupied bandwidth limits

Assigned frequency, MHz	Modulation envelope reference points*, dBc
13.110 – 13.410	20.0
13.410 – 13.553	
13.553 – 13.567	
13.567 – 13.710	
13.710 – 14.010	

*- Modulation envelope reference points provided in terms of attenuation below modulated carrier.

7.5.2 Test procedure

- 7.5.2.1 The EUT was set up as shown in Figure 7.3.1, energized and its proper operation was checked.
- 7.5.2.2 The spectrum analyzer sweep time and bandwidth were set to capture all major modulation sidebands of emission and sweep time was set sufficiently slow to ensure peak measurements. Spectrum analyzer was set in peak hold mode and time sufficient for trace stabilization was allowed.
- 7.5.2.3 The peak of emission was measured. The transmitter occupied bandwidth was measured with spectrum analyzer as frequency delta between reference points on modulation envelope and provided in Table 7.3.2 and associated plot.
- 7.5.2.4 Modulation bandwidth was calculated by adding of the negative frequency drift to the lower measured frequency and the positive frequency drift to the higher measured frequency. The obtained modulation bandwidth was verified to be within the allowed frequency range.

Figure 7.5.1 Occupied bandwidth test setup





Test specification:		Section 15.215(c), Occupied bandwidth	
Test procedure:		ANSI C63.4, Section 13.1.7	
Test mode:		Compliance	
Date(s):		4/1/2012	
Temperature: 22.3 °C		Air Pressure: 1011 hPa	
		Relative Humidity: 38 %	
		Power Supply: 120 VAC	
Remarks:			

Table 7.5.2 Occupied bandwidth test results

ASSIGNED FREQUENCY BAND 13.553 – 13.567 MHz
DETECTOR USED: Peak hold
RESOLUTION BANDWIDTH: 1 kHz
VIDEO BANDWIDTH: 3 kHz
MODULATION ENVELOPE REFERENCE POINTS: 20 dBc
MODULATION: ID code
MODULATING SIGNAL: Enable

Band edge	Cross point frequency, MHz	Frequency drift, kHz		Modulation band edge, MHz	Assigned band edge, MHz	Verdict
		Negative	Positive			
Low	13.5563	0.051	NA	13.556249	13.553	Pass
High	13.5638	NA	0.016	13.563716	13.567	Pass

Reference numbers of test equipment used

HL 0446	HL 0521	HL 2871	HL 3617				
---------	---------	---------	---------	--	--	--	--

Full description is given in Appendix A.



HERMON LABORATORIES

Test specification:	Section 15.215(c), Occupied bandwidth		
Test procedure:	ANSI C63.4, Section 13.1.7		
Test mode:	Compliance	Verdict:	PASS
Date(s):	4/1/2012		
Temperature: 22.3 °C	Air Pressure: 1011 hPa	Relative Humidity: 38 %	Power Supply: 120 VAC
Remarks:			

Plot 7.5.1 Occupied bandwidth test result low band edge

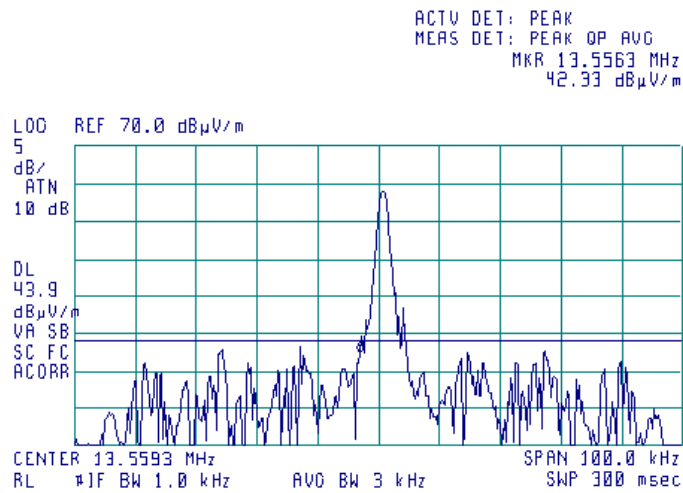

Plot 7.5.2 Occupied bandwidth test result high band edge

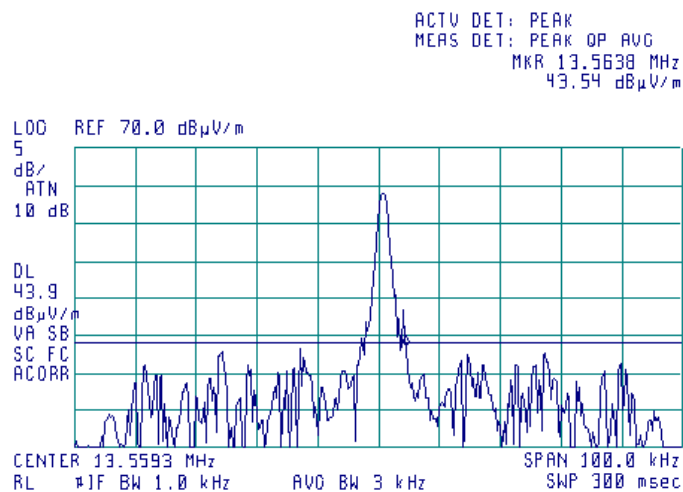



Test specification:	Section 15.203, Antenna requirement		
Test procedure:	ANSI C63.4, Section 13.1.7		
Test mode:	Compliance	Verdict:	PASS
Date(s):	11/9/2011		
Temperature: 23°C	Air Pressure: 1012 hPa	Relative Humidity: 48 %	Power Supply: 120 VAC
Remarks:			

7.6 Antenna requirements

The EUT was verified for compliance with antenna requirements. A transmitter shall be designed to ensure that no antenna other than that furnished by the responsible party will be used with the device. It may be either permanently attached or employs a unique antenna connector for every antenna proposed for use with the EUT. This requirement does not apply to professionally installed transmitters.

The rationale for compliance with the above requirements was either visual inspection results or supplier declaration. The summary of results is provided in Table 7.6.1.

Table 7.6.1 Antenna requirements

Requirement	Rationale	Verdict
The transmitter antenna is permanently attached	Visual inspection	Comply
The transmitter employs a unique antenna connector	NA	
The transmitter requires professional installation	NA	

Photograph 7.6.1 Antenna assembly





Test specification:		Section 15.107, Conducted emission at AC power port	
Test procedure:		ANSI C63.4, Sections 11.5 and 12.1.3	
Test mode:		Compliance	
Date(s):		4/1/2012	
Temperature: 22.3 °C		Air Pressure: 1011 hPa	
		Relative Humidity: 38 %	
		Power Supply: 120 VAC	
Remarks:			

8 Emissions tests according to FCC 47CFR part 15 subpart B requirements

8.1 Conducted emissions

8.1.1 General

This test was performed to measure common mode conducted emissions at the mains power port. Specification test limits are given in Table 8.1.1.

Table 8.1.1 Limits for conducted emissions

Frequency, MHz	Class B limit, dB(μV)		Class A limit, dB(μV)	
	QP	AVRG	QP	AVRG
0.15 - 0.5	66 - 56*	56 - 46*	79	66
0.5 - 5.0	56	46	73	60
5.0 - 30	60	50	73	60

* The limit decreases linearly with the logarithm of frequency.

8.1.2 Test procedure

- 8.1.2.1 The EUT was set up as shown in Figure 8.1.1 and associated photograph, energized and the performance check was conducted.
- 8.1.2.2 The measurements were performed at power terminals with the LISN, connected to a spectrum analyzer in the frequency range referred to in Table 8.1.2. Unused coaxial connector of the LISN was terminated with 50 Ohm. Quasi-peak and average detectors were used throughout the testing.
- 8.1.2.3 The position of the device cables was varied to determine maximum emission level.
- 8.1.2.4 The worst test results (the lowest margins) were recorded in Table 8.1.2 and shown in the associated plots.



Test specification:	Section 15.107, Conducted emission at AC power port		
Test procedure:	ANSI C63.4, Sections 11.5 and 12.1.3		
Test mode:	Compliance	Verdict:	PASS
Date(s):	4/1/2012		
Temperature: 22.3 °C	Air Pressure: 1011 hPa	Relative Humidity: 38 %	Power Supply: 120 VAC
Remarks:			

Figure 8.1.1 Setup for conducted emission measurements, table-top equipment

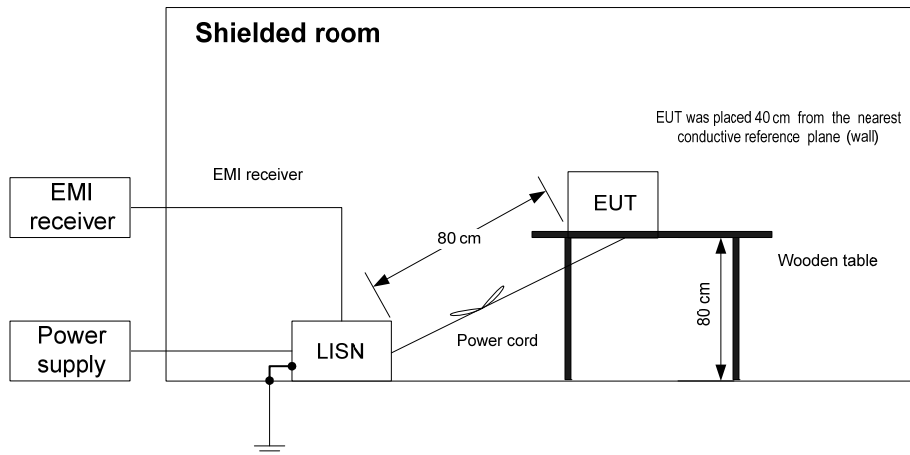

Photograph 8.1.1 Setup for conducted emission measurements

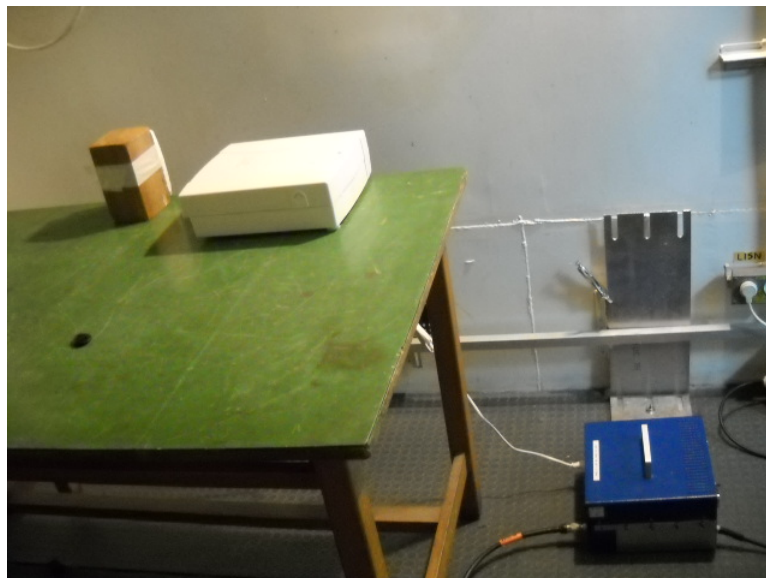



Test specification:		Section 15.107, Conducted emission at AC power port	
Test procedure:		ANSI C63.4, Sections 11.5 and 12.1.3	
Test mode:		Compliance	
Date(s):		4/1/2012	
Temperature: 22.3 °C		Air Pressure: 1011 hPa	
		Relative Humidity: 38 %	
		Power Supply: 120 VAC	
Remarks:			

Table 8.1.2 Conducted emission test results

LINE: AC mains
LIMIT: Class B
EUT OPERATING MODE: Stand-by
EUT SET UP: TABLE-TOP
TEST SITE: SHIELDED ROOM
DETECTORS USED: PEAK / QUASI-PEAK / AVERAGE
FREQUENCY RANGE: 150 kHz - 30 MHz
RESOLUTION BANDWIDTH: 9 kHz

Frequency, MHz	Peak emission, dB(µV)	Quasi-peak			Average			Line ID	Verdict
		Measured emission, dB(µV)	Limit, dB(µV)	Margin, dB*	Measured emission, dB(µV)	Limit, dB(µV)	Margin, dB*		
0.151825	58.56	53.46	65.91	-12.45	38.03	55.91	-17.88	L1	Pass
0.167190	57.49	49.16	65.16	-16.00	26.43	55.16	-28.73		
0.208900	50.84	45.62	63.31	-17.69	30.37	53.31	-22.94		
0.234025	48.09	43.10	62.35	-19.25	27.01	52.35	-25.34		
0.560625	38.20	32.46	56.00	-23.54	22.60	46.00	-23.40		
0.151050	58.02	52.91	65.95	-13.04	37.92	55.95	-18.03	L2	Pass
0.166430	54.76	48.78	65.20	-16.42	24.89	55.20	-30.31		
0.204398	51.49	45.79	63.48	-17.69	29.50	53.48	-23.98		
0.231515	49.67	42.25	62.44	-20.19	24.51	52.44	-27.93		
0.553460	35.53	33.28	56.00	-22.72	24.47	46.00	-21.53		

*- Margin = Measured emission - specification limit.

Reference numbers of test equipment used

HL 0521	HL 0580	HL 2888	HL 3617	HL 3776			
---------	---------	---------	---------	---------	--	--	--

Full description is given in Appendix A.



Test specification:		Section 15.107, Conducted emission at AC power port	
Test procedure:		ANSI C63.4, Sections 11.5 and 12.1.3	
Test mode:		Verdict:	
Compliance		PASS	
Date(s):		4/1/2012	
Temperature: 22.3 °C	Air Pressure: 1011 hPa	Relative Humidity: 38 %	Power Supply: 120 VAC
Remarks:			

Plot 8.1.1 Conducted emission measurements

LINE: L1
LIMIT: Class B
EUT OPERATING MODE: Stand-by
LIMIT: QUASI-PEAK, AVERAGE
DETECTOR: PEAK



ACTV DET: PEAK
MEAS DET: PEAK OP AVG
MKR 150 kHz
56.03 dBµV

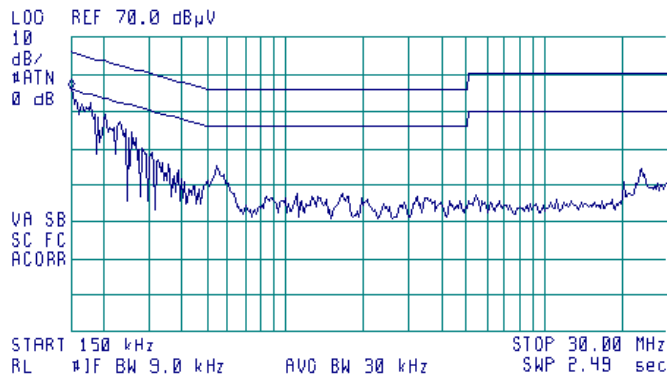

Plot 8.1.2 Conducted emission measurements

LINE: L2
LIMIT: Class B
EUT OPERATING MODE: Stand-by
LIMIT: QUASI-PEAK, AVERAGE
DETECTOR: PEAK



ACTV DET: PEAK
MEAS DET: PEAK OP AVG
MKR 150 kHz
56.43 dBµV

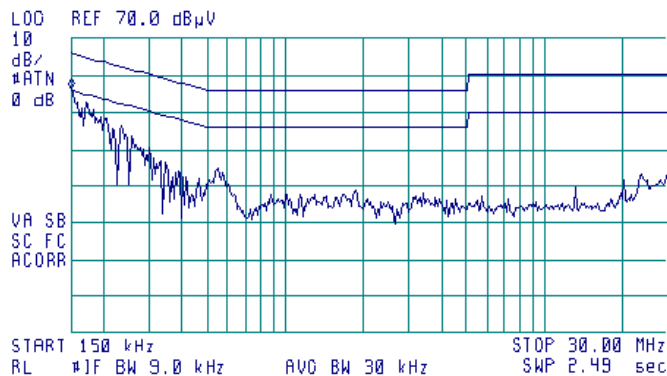



Test specification:		Section 15.109, Radiated emission	
Test procedure:		ANSI C63.4, Sections 11.6 and 12.1.4	
Test mode:		Compliance	
Date(s):		4/1/2012	
Temperature: 22.3 °C		Air Pressure: 1011 hPa	
		Relative Humidity: 38 %	
		Power Supply: 120 VAC	
Remarks:			

8.2 Radiated emission measurements

8.2.1 General

This test was performed to measure radiated emissions from the EUT enclosure. Specification test limits are given in Table 8.2.1.

Table 8.2.1 Radiated emission test limits

Frequency, MHz	Class B limit, dB(μ V/m)		Class A limit, dB(μ V/m)	
	10 m distance	3 m distance	10 m distance	3 m distance
30 - 88	29.5*	40.0	39.0	49.5*
88 - 216	33.0*	43.5	43.5	54.0*
216 - 960	35.5*	46.0	46.4	56.9*
Above 960	43.5*	54.0	49.5	60.0*

* The limit for test distance other than specified was calculated using the inverse linear distance extrapolation factor as follows: $Lim_{S_2} = Lim_{S_1} + 20 \log(S_1/S_2)$, where S_1 and S_2 – standard defined and test distance respectively in meters.

8.2.2 Test procedure

8.2.2.1 The EUT was set up as shown in Figure 8.2.1 and associated photograph, energized and the performance check was conducted.

8.2.2.2 The specified frequency range was investigated with biconilog antenna connected to EMI receiver. To find maximum radiation the turntable was rotated 360⁰, the measuring antenna height was changed from 1 to 4 m, its polarization was switched from vertical to horizontal and the EUT cables position was varied.

8.2.2.3 The worst test results (the lowest margins) were recorded in Table 8.2.2 and shown in the associated plots.



Test specification:	Section 15.109, Radiated emission		
Test procedure:	ANSI C63.4, Sections 11.6 and 12.1.4		
Test mode:	Compliance	Verdict:	PASS
Date(s):	4/1/2012		
Temperature: 22.3 °C	Air Pressure: 1011 hPa	Relative Humidity: 38 %	Power Supply: 120 VAC
Remarks:			

Figure 8.2.1 Setup for radiated emission measurements in anechoic chamber, table-top equipment

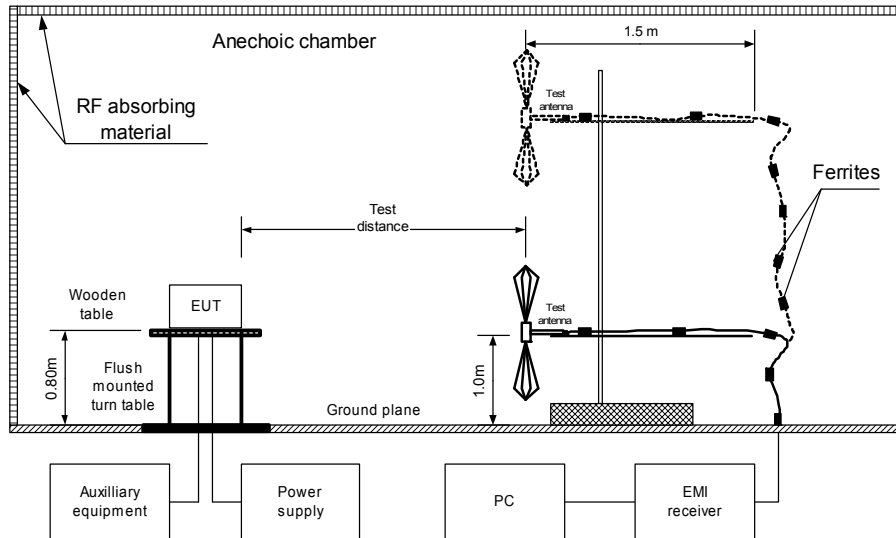

Photograph 8.2.1 Setup for preliminary radiated emission measurements





Test specification:		Section 15.109, Radiated emission	
Test procedure:		ANSI C63.4, Sections 11.6 and 12.1.4	
Test mode:		Compliance	
Date(s):		4/1/2012	
Temperature: 22.3 °C		Air Pressure: 1011 hPa	
		Relative Humidity: 38 %	
		Power Supply: 120 VAC	
Remarks:			

Table 8.2.2 Radiated emission test results

EUT SET UP: TABLE-TOP
LIMIT: Class B
EUT OPERATING MODE: Stand-by
TEST SITE: SEMI ANECHOIC CHAMBER
TEST DISTANCE: 3 m
DETECTORS USED: PEAK / QUASI-PEAK
FREQUENCY RANGE: 30 MHz – 1000 MHz
RESOLUTION BANDWIDTH: 120 kHz

Frequency, MHz	Peak emission, dB(µV/m)	Quasi-peak			Antenna polarization	Antenna height, m	Turn-table position**, degrees	Verdict
		Measured emission, dB(µV/m)	Limit, dB(µV/m)	Margin, dB*				
40.680275	27.0	24.6	40.0	-15.4	Vert	1.3	100	Pass
67.800000	41.1	30.8	40.0	-9.2	Vert	1.0	197	
135.600000	34.0	29.7	43.5	-13.8	Vert	1.0	73	
230.520000	34.5	25.9	46.0	-20.1	Vert	1.0	177	
338.983000	44.8	38.2	46.0	-7.8	Vert	1.4	336	
379.680000	42.4	38.0	46.0	-8.0	Vert	1.3	333	
610.200000	47.0	39.8	46.0	-6.2	Vert	1.0	316	
623.760000	47.0	38.8	46.0	-7.2	Vert	1.0	338	

*- Margin = Measured emission - specification limit.
**- EUT front panel refer to 0 degrees position of turntable.

Reference numbers of test equipment used

HL 0521	HL 0604	HL 2871	HL 3617				
---------	---------	---------	---------	--	--	--	--

Full description is given in Appendix A.



HERMON LABORATORIES

Test specification:	Section 15.109, Radiated emission		
Test procedure:	ANSI C63.4, Sections 11.6 and 12.1.4		
Test mode:	Compliance	Verdict:	PASS
Date(s):	4/1/2012		
Temperature: 22.3 °C	Air Pressure: 1011 hPa	Relative Humidity: 38 %	Power Supply: 120 VAC
Remarks:			

Plot 8.2.1 Radiated emission measurements in 30 - 1000 MHz range, vertical antenna polarization

TEST SITE: Semi anechoic chamber
LIMIT: Class B
TEST DISTANCE: 3 m
EUT OPERATING MODE: Stand-by

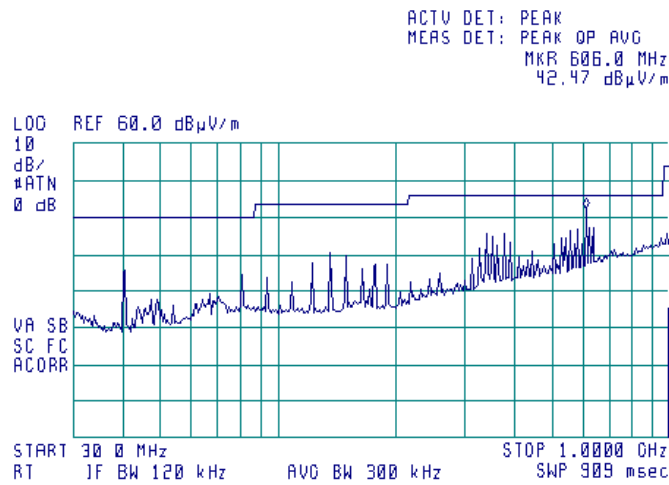

Plot 8.2.2 Radiated emission measurements in 30 - 1000 MHz range, horizontal antenna polarization

TEST SITE: Semi anechoic chamber
LIMIT: Class B
TEST DISTANCE: 3 m
EUT OPERATING MODE: Stand-by

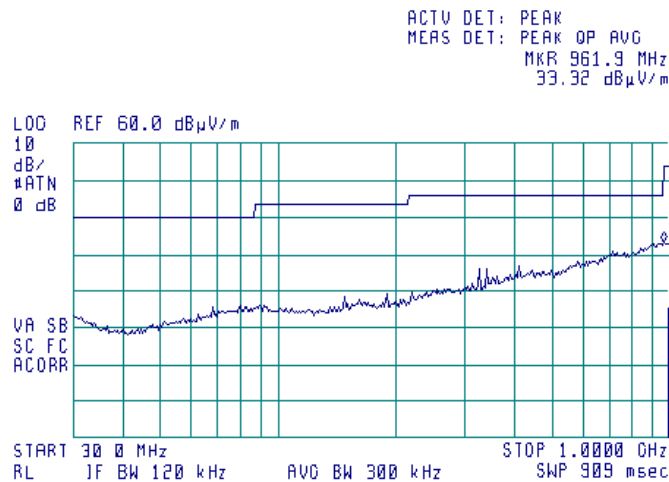

**9 APPENDIX A Test equipment and ancillaries used for tests**

HL No	Description	Manufacturer	Model	Ser. No.	Last Cal./ Check	Due Cal./ Check
0337	Probe Set, Hand held, 5 probes	Electro-Metrics	EHFP-30	238	07-Jun-11	07-Jun-12
0446	Antenna, Loop, Active, 10 kHz - 30 MHz	EMCO	6502	2857	03-Jul-11	03-Jul-12
0521	EMI Receiver (Spectrum Analyzer) with RF filter section 9 kHz-6.5 GHz	Hewlett Packard	8546A	3617A 00319, 3448A002 53	29-Aug-11	29-Sep-12
0580	DC block adaptor 10 kHz - 2.2 GHz	Anritsu	MA8601 A	580	24-Nov-11	24-Nov-12
0604	Antenna BiconiLog Log-Periodic/T Bow-TIE, 26 - 2000 MHz	EMCO	3141	9611-1011	11-Jan-11	11-Jan-13
1194	Variac, 220 V/ 2.5 A	Matsunaga	NA	2962	05-Apr-12	05-Apr-13
1481	Cable, 1 m	Harbour Industries	MIL 17/60- RG142	1481	01-Sep-11	01-Sep-12
2871	Microwave Cable Assembly, 18 GHz, 6.4 m, SMA - SMA	Huber-Suhner	198-8155-00	2871	15-Jan-12	15-Jan-13
2888	LISN Two-line V-Network 50 Ohm / 50 uH + 5 Ohm, 16A, MIL STD 461E, CISPR 16-1	Rolf Heine	NNB-2/16Z	02/10018	02-Jan-12	02-Jan-13
3617	Cable RF, 6.5 m, N type-N type, DC-6.5 GHz	Suhner Switzerland	RG 214/U	NA	19-May-11	19-May-12
3776	Attenuator, N-type, 10 dB, DC to 18 GHz, 5 W	Mini-Circuits	BW-N10W5+	NA	22-Jun-11	22-Jun-12
3818	PSA Series Spectrum Analyzer, 3 Hz- 44 GHz	Agilent Technologies	E4446A	MY482502 88	16-Feb-12	16-Feb-13

10 APPENDIX B Measurement uncertainties

Expanded uncertainty at 95% confidence in Hermon Labs EMC measurements

Test description	Expanded uncertainty
Conducted emissions with LISN	9 kHz to 150 kHz: ± 3.9 dB 150 kHz to 30 MHz: ± 3.8 dB
Radiated emissions at 10 m measuring distance Horizontal polarization Vertical polarization	Biconilog antenna: ± 5.0 dB Biconical antenna: ± 5.0 dB Log periodic antenna: ± 5.1 dB Double ridged horn antenna: ± 5.3 dB Biconilog antenna: ± 5.5 dB Biconical antenna: ± 5.5 dB Log periodic antenna: ± 5.6 dB Double ridged horn antenna: ± 5.8 dB
Radiated emissions at 3 m measuring distance Horizontal polarization Vertical polarization	Biconilog antenna: ± 5.3 dB Biconical antenna: ± 5.0 dB Log periodic antenna: ± 5.3 dB Double ridged horn antenna: ± 5.3 dB Biconilog antenna: ± 6.0 dB Biconical antenna: ± 5.7 dB Log periodic antenna: ± 6.0 dB Double ridged horn antenna: ± 6.0 dB
Conducted emissions at RF antenna connector	9 kHz to 2.9 GHz: ± 2.6 dB 2.9 GHz to 6.46 GHz: ± 3.5 dB 6.46 GHz to 13.2 GHz: ± 4.3 dB 13.2 GHz to 22.0 GHz: ± 5.0 dB 22.0 GHz to 26.8 GHz: ± 5.5 dB 26.8 GHz to 40.0 GHz: ± 4.8 dB

Hermon Laboratories is accredited by A2LA for calibration according to present requirements of ISO/IEC 17025 and NCSL Z540-1. The accreditation is granted to perform calibration of parameters that are listed in the Scope of Hermon Laboratories Accreditation.

Hermon Laboratories calibrates its reference and transfer standards by calibration laboratories accredited to ISO/IEC 17025 by a mutually recognized Accreditation Body or by a recognized national metrology institute. All reference and transfer standards used in the calibration system are traceable to national or international standards.

In-house calibration of all test and measurement equipment is performed on a regular basis according to Hermon Laboratories calibration procedures, manufacturer calibration/verification procedures or procedures defined in the relevant standards. The Hermon Laboratories test and measurement equipment is calibrated within the tolerances specified by the manufacturers and/or by the relevant standards.

11 APPENDIX C Test laboratory description

Tests were performed at Hermon Laboratories Ltd., which is a fully independent, private, EMC, safety, environmental and telecommunication testing facility.

Hermon Laboratories is listed by the Federal Communications Commission (USA) for all parts of Code of Federal Regulations 47 (CFR 47), Registration Numbers 90624 for OATS and 90623 for the anechoic chamber; by Industry Canada for electromagnetic emissions (file numbers IC 2186A-1 for OATS, IC 2186A-2 for anechoic chamber, IC 2186A-3 for full-anechoic chamber for RE measurements above 1 GHz), certified by VCCI, Japan (the registration numbers are R-808 for OATS, R-1082 for anechoic chamber, G-27 for full-anechoic chamber for RE measurements above 1 GHz, C-845 for conducted emissions site, T-1606 for conducted emissions at telecommunication ports), has a status of a Telefication - Listed Testing Laboratory, Certificate No. L138/00. The laboratory is accredited by American Association for Laboratory Accreditation (USA) according to ISO/IEC 17025 for electromagnetic compatibility, product safety, telecommunications testing and environmental simulation (for exact scope please refer to Certificate No. 839.01). The FCC Designation Number is US1003.

Address: P.O. Box 23, Binyamina 30500, Israel.
Telephone: +972 4628 8001
Fax: +972 4628 8277
e-mail: mail@hermonlabs.com
website: www.hermonlabs.com

Person for contact: Mr. Alex Usoskin, CEO.

12 APPENDIX D Specification references

47CFR part 15: 2011	Radio Frequency Devices.
ANSI C63.2: 1996	American National Standard for Instrumentation-Electromagnetic Noise and Field Strength, 10 kHz to 40 GHz-Specifications.
ANSI C63.4: 2003	American National Standard for Methods of Measurement of Radio-Noise Emissions from Low-Voltage Electrical and Electronic Equipment in the Range of 9 kHz to 40 GHz.

13 APPENDIX E Test equipment correction factors

Correction factor
Line impedance stabilization network
Model NNB-2/16Z, Rolf Heine, HL 2888

Frequency, kHz	Insertion loss,dB		Measurement Uncertainty, dB
	L1	N	
10	0.48	0.79	±0.6
20	0.52	0.63	
30	0.31	0.35	
40	0.20	0.22	
50	0.16	0.17	
100	0.10	0.08	
300	0.08	0.06	
500	0.10	0.06	
600	0.09	0.07	
800	0.10	0.07	
1000	0.10	0.08	
2000	0.12	0.11	
3000	0.16	0.14	
4000	0.17	0.18	
6000	0.26	0.23	
10000	0.49	0.41	
14000	0.66	0.54	
16000	0.79	0.69	
18000	0.86	0.76	
20000	0.96	0.85	
25000	1.22	1.08	
28000	1.35	1.21	
30000	1.43	1.29	

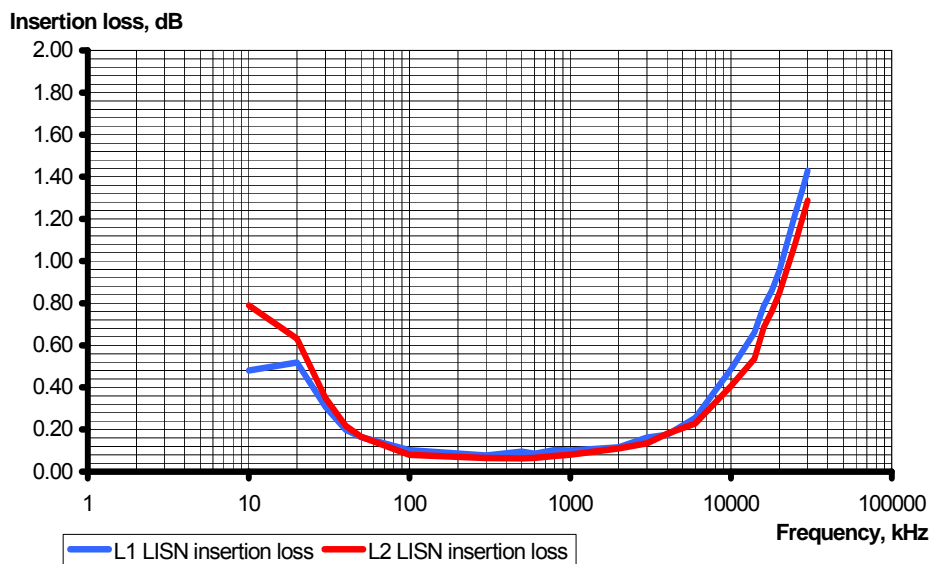



Antenna factor
Active loop antenna
Model 6502, S/N 2857, HL 0446

Frequency, MHz	Magnetic antenna factor, dB	Electric antenna factor, dB
0.009	-32.8	18.7
0.010	-33.8	17.7
0.020	-38.3	13.2
0.050	-41.1	10.4
0.075	-41.3	10.2
0.100	-41.6	9.9
0.150	-41.7	9.8
0.250	-41.6	9.9
0.500	-41.8	9.8
0.750	-41.9	9.7
1.000	-41.4	10.1
2.000	-41.5	10.0
3.000	-41.4	10.2
4.000	-41.4	10.1
5.000	-41.5	10.1
10.000	-41.9	9.6
15.000	-41.9	9.6
20.000	-42.2	9.3
25.000	-42.8	8.7
30.000	-44.0	7.5

Antenna factor in dB(1/m) is to be added to receiver meter reading in dB(μ V) to convert it into field intensity in dB(μ V/m).



Antenna factor
Biconilog antenna EMCO Model 3141
Ser.No.1011, HL 0604

Frequency, MHz	Antenna Factor, dB(1/m)	Frequency, MHz	Antenna Factor, dB(1/m)
26	7.8	940	24.0
28	7.8	960	24.1
30	7.8	980	24.5
40	7.2	1000	24.9
60	7.1	1020	25.0
70	8.5	1040	25.2
80	9.4	1060	25.4
90	9.8	1080	25.6
100	9.7	1100	25.7
110	9.3	1120	26.0
120	8.8	1140	26.4
130	8.7	1160	27.0
140	9.2	1180	27.0
150	9.8	1200	26.7
160	10.2	1220	26.5
170	10.4	1240	26.5
180	10.4	1260	26.5
190	10.3	1280	26.6
200	10.6	1300	27.0
220	11.6	1320	27.8
240	12.4	1340	28.3
260	12.8	1360	28.2
280	13.7	1380	27.9
300	14.7	1400	27.9
320	15.2	1420	27.9
340	15.4	1440	27.8
360	16.1	1460	27.8
380	16.4	1480	28.0
400	16.6	1500	28.5
420	16.7	1520	28.9
440	17.0	1540	29.6
460	17.7	1560	29.8
480	18.1	1580	29.6
500	18.5	1600	29.5
520	19.1	1620	29.3
540	19.5	1640	29.2
560	19.8	1660	29.4
580	20.6	1680	29.6
600	21.3	1700	29.8
620	21.5	1720	30.3
640	21.2	1740	30.8
660	21.4	1760	31.1
680	21.9	1780	31.0
700	22.2	1800	30.9
720	22.2	1820	30.7
740	22.1	1840	30.6
760	22.3	1860	30.6
780	22.6	1880	30.6
800	22.7	1900	30.6
820	22.9	1920	30.7
840	23.1	1940	30.9
860	23.4	1960	31.2
880	23.8	1980	31.6
900	24.1	2000	32.0
920	24.1		

Antenna factor in dB(1/m) is to be added to receiver meter reading in dB(μV) to convert it into field intensity in dB(μV/m).



Cable loss
Cable MIL 17/60-RG142, HL 1481

Frequency, GHz	Cable loss, dB
2	1
2.2	1.1
2.4	1.1
2.6	1.2
2.8	1.2
3	1.2
3.2	1.3
3.4	1.3
3.6	1.5
3.8	1.5
4	1.6
4.2	1.7
4.4	1.8
4.6	1.9
4.8	2
5	2
5.2	2
5.4	2.1
5.6	2.1
5.8	2.2
6	2.2
6.2	2.2
6.4	2.3
6.6	2.3
6.8	2.3
7	2.4
7.2	2.4
7.4	2.5
7.6	2.5
7.8	2.6
8	2.7
8.2	2.8
8.4	3.1
8.6	3.3
8.8	3.5
9	4



Cable loss
Cable coaxial, Huber-Suhner, 18 GHz, 6.4 m, SMA - SMA, model 198-8155-00,
HL 2871

Frequency, MHz	Cable loss, dB	Frequency, MHz	Cable loss, dB	Frequency, MHz	Cable loss, dB
10	0.12	5750	2.34	12000	3.55
30	0.14	6000	2.39	12250	3.61
100	0.27	6250	2.46	12500	3.67
250	0.45	6500	2.52	12750	3.74
500	0.63	6750	2.58	13000	3.79
750	0.76	7000	2.64	13250	3.82
1000	0.89	7250	2.68	13500	3.83
1250	1.01	7500	2.73	13750	3.83
1500	1.12	7750	2.78	14000	3.88
1750	1.23	8000	2.83	14250	3.93
2000	1.32	8250	2.88	14500	3.96
2250	1.41	8500	2.94	14750	4.01
2500	1.49	8750	2.97	15000	4.00
2750	1.58	9000	3.02	15250	4.01
3000	1.66	9250	3.07	15500	4.00
3250	1.73	9500	3.13	15750	4.13
3500	1.80	9750	3.18	16000	4.22
3750	1.87	10000	3.21	16250	4.29
4000	1.93	10250	3.26	16500	4.29
4250	2.01	10500	3.30	16750	4.32
4500	2.06	10750	3.36	17000	4.37
4750	2.12	11000	3.39	17250	4.45
5000	2.17	11250	3.44	17500	4.49
5250	2.24	11500	3.48	17750	4.53
5500	2.29	11750	3.52	18000	4.55



Cable loss
Cable coaxial, RG-214/U, N type-N type, 6.5 m
Suhner Switzerland, HL 3617

Frequency, MHz	Cable loss, dB	Frequency, MHz	Cable loss, dB	Frequency, MHz	Cable loss, dB
10	0.13	2200	2.97	4500	5.10
50	0.33	2300	3.06	4600	5.20
100	0.48	2400	3.16	4700	5.34
200	0.71	2500	3.23	4800	5.36
300	0.89	2600	3.34	4900	5.48
400	1.04	2700	3.42	5000	5.52
500	1.19	2800	3.52	5100	5.61
600	1.32	2900	3.61	5200	5.72
700	1.44	3000	3.69	5300	5.81
800	1.56	3100	3.80	5400	5.93
900	1.68	3200	3.86	5500	6.08
1000	1.80	3300	3.98	5600	6.12
1100	1.90	3400	4.07	5700	6.25
1200	2.00	3500	4.14	5800	6.31
1300	2.11	3600	4.27	5900	6.41
1400	2.21	3700	4.36	6000	6.51
1500	2.30	3800	4.47	6100	6.62
1600	2.40	3900	4.62	6200	6.73
1700	2.49	4000	4.63	6300	6.86
1800	2.61	4100	4.76	6400	6.94
1900	2.69	4200	4.83	6500	7.06
2000	2.79	4300	4.89		
2100	2.88	4400	5.04		



14 APPENDIX F Abbreviations and acronyms

A	ampere
AC	alternating current
A/m	ampere per meter
AM	amplitude modulation
AVRG	average (detector)
cm	centimeter
dB	decibel
dBm	decibel referred to one milliwatt
dB(μ V)	decibel referred to one microvolt
dB(μ V/m)	decibel referred to one microvolt per meter
dB(μ A)	decibel referred to one microampere
DC	direct current
EIRP	equivalent isotropically radiated power
ERP	effective radiated power
EUT	equipment under test
F	frequency
GHz	gigahertz
GND	ground
H	height
HL	Hermon laboratories
Hz	hertz
k	kilo
kHz	kilohertz
LO	local oscillator
m	meter
MHz	megahertz
min	minute
mm	millimeter
ms	millisecond
μ s	microsecond
NA	not applicable
NB	narrow band
OATS	open area test site
Ω	Ohm
PM	pulse modulation
PS	power supply
ppm	part per million (10^{-6})
QP	quasi-peak
RE	radiated emission
RF	radio frequency
rms	root mean square
Rx	receive
s	second
T	temperature
Tx	transmit
V	volt
WB	wideband

END OF DOCUMENT