



# MEASUREMENT REPORT

## FCC PART15 Subpart C ( Section 15.245 )

---

**FCC ID:** JE4RK412DTPT  
**APPLICANT:** RISCO LTD.  
**Application Type:** Certification  
**Product:** Digi-Sense DT Pet, US  
**Model No.:** RK412DTPT  
**Brand Name:** RISCO  
**FCC Classification:** Part 15 Field Disturbance Sensor (FDS)  
**FCC Rule Part(s):** FCC PART15 Subpart C ( Section 15.245 )  
**Test Procedure(s):** ANSI C63.10-2013  
**Test Date:** January 05 ~ January 31, 2018

Reviewed By : Kevin Guo  
( Kevin Guo )

Approved By : Marlin Chen  
( Marlin Chen )



The test results relate only to the samples tested.

This equipment has been shown to be capable of compliance with the applicable technical standards as indicated in the measurement report and was tested in accordance with the measurement procedures specified in ANSI C63.10-2013. Test results reported herein relate only to the item(s) tested.

The test report shall not be reproduced except in full without the written approval of MRT Technology (Suzhou) Co., Ltd.

### Revision History

Report No.	Version	Description	Issue Date	Note
1703WSU00201	Rev. 01	Initial report	01-31-2018	Valid

# CONTENTS

Description	Page
<b>1. INTRODUCTION .....</b>	<b>6</b>
1.1. Scope .....	6
1.2. MRT Test Location .....	6
<b>2. PRODUCT INFORMATION .....</b>	<b>7</b>
2.1. Equipment Description.....	7
2.2. Test Mode .....	7
2.3. Description of Test Software.....	7
2.4. Duty Cycle .....	7
2.5. Test Configuration .....	8
2.6. EMI Suppression Device(s)/Modifications.....	8
2.7. Labeling Requirements.....	8
<b>3. DESCRIPTION of TEST.....</b>	<b>9</b>
3.1. Evaluation Procedure .....	9
3.2. AC Line Conducted Emissions .....	9
3.3. Radiated Emissions.....	10
<b>4. ANTENNA REQUIREMENTS.....</b>	<b>11</b>
<b>5. TEST EQUIPMENT CALIBRATION DATA .....</b>	<b>12</b>
<b>6. MEASUREMENT UNCERTAINTY.....</b>	<b>13</b>
<b>7. TEST RESULT .....</b>	<b>14</b>
7.1. Summary .....	14
7.2. 99% Bandwidth Measurement .....	15
7.2.1. Test Limit .....	15
7.2.2. Test Procedure used .....	15
7.2.3. Test Setting.....	15
7.2.4. Test Setup.....	15
7.2.5. Test Result.....	16
7.3. Field strength of fundamental .....	17
7.3.1. Standard Applicable .....	17
7.3.2. Test Procedure used .....	17
7.3.3. Test Procedure.....	17
7.3.4. Test Setup.....	18
7.3.5. Test Results .....	19

---

7.4.	Field strength of harmonics.....	20
7.4.1.	Standard Applicable .....	20
7.4.2.	Test Procedure used .....	21
7.4.3.	Test Procedure.....	21
7.4.4.	Test Setup.....	22
7.4.5.	Test Result.....	24
7.5.	AC Conducted Emissions Measurement.....	27
7.5.1.	Test Limit .....	27
7.5.2.	Test Setup.....	27
7.5.3.	Test Result.....	27
<b>8.</b>	<b>CONCLUSION.....</b>	<b>28</b>

## §2.1033 General Information

<b>Applicant:</b>	RISCO LTD.
<b>Applicant Address:</b>	14 Hachoma Street, Rishon Lezion, 75655, Israel
<b>Manufacturer:</b>	RISCO LTD.
<b>Manufacturer Address:</b>	Sderot Yahalom 6 Kiryat Gat, Israel
<b>Test Site:</b>	MRT Technology (Suzhou) Co., Ltd
<b>Test Site Address:</b>	D8 Building, No.2 Tian'edang Rd., Wuzhong Economic Development Zone, Suzhou, China
<b>MRT Registration No.:</b>	893164
<b>Test Device Serial No.:</b>	N/A <input type="checkbox"/> Production <input checked="" type="checkbox"/> Pre-Production <input type="checkbox"/> Engineering

### Test Facility / Accreditations

Measurements were performed at MRT Laboratory located in Tian'edang Rd., Suzhou, China.

- MRT facility is a FCC registered (MRT Reg. No. 893164) test facility with the site description report on file and has met all the requirements specified in Section 2.948 of the FCC Rules.
- MRT facility is an IC registered (MRT Reg. No. 11384A-1) test laboratory with the site description on file at Industry Canada.
- MRT facility is a VCCI registered (R-4179, G-814, C-4664, T-2206) test laboratory with the site description on file at VCCI Council.
- MRT Lab is accredited to ISO 17025 by the American Association for Laboratory Accreditation (A2LA) under the American Association for Laboratory Accreditation Program (A2LA Cert. No. 3628.01) in EMC, Telecommunications and Radio testing for FCC, Industry Canada, EU and TELEC Rules.



## 1. INTRODUCTION

### 1.1. Scope

Measurement and determination of electromagnetic emissions (EMC) of radio frequency devices including intentional and/or unintentional radiators for compliance with the technical rules and regulations of the Federal Communications Commission and the Industry Canada Certification and Engineering Bureau.

### 1.2. MRT Test Location

The map below shows the location of the MRT LABORATORY, its proximity to the Taihu Lake. These measurement tests were conducted at the MRT Technology (Suzhou) Co., Ltd. Facility located at D8 Building, No.2 Tian'edang Rd., Wuzhong Economic Development Zone, Suzhou, China. The detailed description of the measurement facility was found to be in compliance with the requirements of § 2.948 according to ANSI C63.4-2014.



## 2. PRODUCT INFORMATION

### 2.1. Equipment Description

Product Name	Digi-Sense DT Pet, US
Model No.	RK412DTPT
MW module model Name	NJR4178
Transmitting Frequency	10.525GHz
Modulation	CW
Operation Voltage	DC 12V
Antenna Type	PCB Antenna
Max. Peak Gain	1.0 dBi

### 2.2. Test Mode

Test Mode	Mode 1: Transmit by 10.525GHz
-----------	-------------------------------

### 2.3. Description of Test Software

The test utility software used during testing was engineering directive ordered by applicant.

### 2.4. Duty Cycle

Test Mode	Duty Cycle
10.525GHz	5%

10.525GHz	--
	--

## 2.5. Test Configuration

The **Digi-Sense DT Pet, US** was tested per the guidance of FCC Part 15.245 and ANSI 63.10-2013 was used to reference the appropriate EUT setup for radiated spurious emissions testing and AC line conducted testing.

## 2.6. EMI Suppression Device(s)/Modifications

No EMI suppression device(s) were added and/or no modifications were made during testing.

## 2.7. Labeling Requirements

Per 2.1074 & 15.19; Docket 95-19

The label shall be permanently affixed at a conspicuous location on the device; instruction manual or pamphlet supplied to the user and be readily visible to the purchaser at the time of purchase.

However, when the device is so small wherein placement of the label with specified statement is not practical, only the FCC ID must be displayed on the device per Section 15.19(a)(5). Please see attachment for FCC ID label and label location.



### 3. DESCRIPTION of TEST

#### 3.1. Evaluation Procedure

The measurement procedures described in the American National Standard for Testing Unlicensed Wireless Devices (ANSI C63.10-2013), and the guidance provided in FCC Part 15.245 were used in the measurement of the **Digi-Sense DT Pet, US**.

**Deviation from measurement procedure.....None**

#### 3.2. AC Line Conducted Emissions

The line-conducted facility is located inside an 8'x4'x4' shielded enclosure. A 1m x 2m wooden table 80cm high is placed 40cm away from the vertical wall and 80cm away from the sidewall of the shielded room. Two 10kHz-30MHz, 50Ω/50uH Line-Impedance Stabilization Networks (LISNs) are bonded to the shielded room floor. Power to the LISNs is filtered by external high-current high-insertion loss power line filters. These filters attenuate ambient signal noise from entering the measurement lines. These filters are also bonded to the shielded enclosure.

The EUT is powered from one LISN and the support equipment is powered from the second LISN. All interconnecting cables more than 1 meter were shortened to a 1 meter length by non-inductive bundling (serpentine fashion) and draped over the back edge of the test table. All cables were at least 40cm above the horizontal reference ground-plane. Power cables for support equipment were routed down to the second LISN while ensuring that that cables were not draped over the second LISN.

Sufficient time for the EUT, support equipment, and test equipment was allowed in order for them to warm up to their normal operating condition. The RF output of the LISN was connected to the receiver and exploratory measurements were made to determine the frequencies producing the maximum emission from the EUT. The receiver was scanned from 150kHz to 30MHz. The detector function was set to peak mode for exploratory measurements while the bandwidth of the analyzer was set to 9kHz. The EUT, support equipment, and interconnecting cables were arranged and manipulated to maximize each emission. Each emission was also maximized by varying: power lines, the mode of operation or data exchange speed, or support equipment whichever determined the worst-case emission. Once the worst case emissions have been identified, the one EUT cable configuration/arrangement and mode of operation that produced these emissions are used for final measurements on the same test site. The analyzer is set to CISPR quasi-peak and average detectors with a 9kHz resolution bandwidth for final measurements.

An extension cord was used to connect to a single LISN which powered by EUT. The extension cord was calibrated with LISN, the impedance and insertion loss are compliance with the requirements as stated in ANSI C63.10-2013.

### 3.3. Radiated Emissions

The radiated test facilities consisted of an indoor 3 meter semi-anechoic chamber used for final measurements and exploratory measurements, when necessary. The measurement area is contained within the semi-anechoic chamber which is shielded from any ambient interference. For measurements above 1GHz absorbers are arranged on the floor between the turn table and the antenna mast in such a way so as to maximize the reduction of reflections. For measurements below 1GHz, the absorbers are removed. A MF Model 210SS turntable is used for radiated measurement. It is a continuously rotatable, remote controlled, metallic turntable and 2 meters (6.56 ft.) in diameter. The turn table is flush with the raised floor of the chamber in order to maintain its function as a ground plane. An 80cm high PVC support structure is placed on top of the turntable.

For all measurements, the spectrum was scanned through all EUT azimuths and from 1 to 4 meter receive antenna height using a broadband antenna from 30MHz up to the upper frequency shown in 15.33(b)(1) depending on the highest frequency generated or used in the device or on which the device operates or tunes. For frequencies above 1GHz, linearly polarized double ridge horn antennas were used. For frequencies below 30MHz, a calibrated loop antenna was used. When exploratory measurements were necessary, they were performed at 1 meter test distance inside the semi-anechoic chamber using broadband antennas, broadband amplifiers, and spectrum analyzers to determine the frequencies and modes producing the maximum emissions. Sufficient time for the EUT, support equipment, and test equipment was allowed in order for them to warm up to their normal operating condition. The test set-up for frequencies below 1GHz was placed on top of the 0.8 meter high, 1 x 1.5 meter table; and test set-up for frequencies 1-40GHz was placed on top of the 1.5 meter high, 1 x 1.5 meter table. The EUT, support equipment, and interconnecting cables were arranged and manipulated to maximize each emission. Appropriate precaution was taken to ensure that all emissions from the EUT were maximized and investigated. The system configuration, clock speed, mode of operation or video resolution, if applicable, turntable azimuth, and receive antenna height was noted for each frequency found.

Final measurements were made in the semi-anechoic chamber using calibrated, linearly polarized broadband and horn antennas. The test setup was configured to the setup that produced the worst case emissions. The spectrum analyzer was set to investigate all frequencies required for testing to compare the highest radiated disturbances with respect to the specified limits. The turntable containing the EUT was rotated through 360 degrees and the height of the receive antenna was varied 1 to 4 meters and stopped at the azimuth and height producing the maximum emission. Each emission was maximized by changing the orientation of the EUT through three orthogonal planes and changing the polarity of the receive antenna, whichever produced the worst-case emissions. According to 3dB Beam-Width of horn antenna, the horn antenna should be always directed to the EUT when rising height.

## 4. ANTENNA REQUIREMENTS

### **Excerpt from §15.203 of the FCC Rules/Regulations:**

“An intentional radiator antenna shall be designed to ensure that no antenna other than that furnished by the responsible party can be used with the device. The use of a permanently attached antenna or of an antenna that uses a unique coupling to the intentional radiator shall be considered sufficient to comply with the provisions of this section.”

- The antenna of the Radio Controller is **permanently attached**.
- There are no provisions for connection to an external antenna.

### **Conclusion:**

The **Digi-Sense DT Pet, US** complies with the requirement of §15.203.

## 5. TEST EQUIPMENT CALIBRATION DATA

### Radiated Emission-AC1

Instrument	Manufacturer	Type No.	Asset No.	Cali. Interval	Cali. Due Date
PXA Signal Analyzer	Keysight	9030B	MRTSUE06395	1 year	2018/09/13
EMI Test Receiver	R&S	ESR7	MRTSUE06001	1 year	2018/08/18
Loop Antenna	Schwarzbeck	FMZB 1519	MRTSUE06025	1 year	2018/11/20
EXA Signal Analyzer	Agilent	N9020A	MRTSUE06106	1 year	2018/04/25
Microwave System Amplifier	Agilent	83017A	MRTSUE06076	1 year	2018/11/17
Bilog Period Antenna	Schwarzbeck	VULB 9168	MRTSUE06172	1 year	2018/11/18
Broad Band Horn Antenna	Schwarzbeck	BBHA9120D	MRTSUE06023	1 year	2018/10/21
Broad Band Horn Antenna	Schwarzbeck	BBHA 9170	MRTSUE06024	1 year	2018/12/14
Micro-Wave Antenna	MI-WWAVE	261U-25	MRTSUE06273	1 year	2018/12/26
Waveguide Harmonic Mixer	Keysight	M1970V	MRTSUE06271	1 year	2018/12/26
Amplifier	Schwarzbeck	BBV 9721	MRTSUE06121	1 year	2018/06/14
DC Power Supply	GWINSTEK	DPS-99306D	MRTSUE06063	1 year	N/A
Hygrothermograph	Testo	608-H1	MRTSUE06403	1 year	2018/08/14
Anechoic Chamber	TDK	Chamber-AC1	MRTSUE06212	1 year	2018/05/10

## 6. MEASUREMENT UNCERTAINTY

Where relevant, the following test uncertainty levels have been estimated for tests performed on the EUT as specified in CISPR 16-4-2. This uncertainty represents an expanded uncertainty expressed at approximately the 95% confidence level using a coverage factor of  $k = 2$ .

Radiated Emission Measurement-AC1
Measuring Uncertainty for a Level of Confidence of 95% ( $U=2Uc(y)$ ): 9kHz ~ 1GHz: 4.18dB

## 7. TEST RESULT

### 7.1. Summary

Company Name: **RISCO LTD.**  
 FCC ID: **JE4RK412DTPT**

FCC Part Section(s)	Test Description	Test Limit	Test Condition	Test Result	Reference
15.215(c)	Occupied Bandwidth	N/A	Radiated	Pass	Section 7.2
15.245(b)	Field strength of fundamental	Refer to Section 7.3.1		Pass	Section 7.3
15.245(b) 15.209	Field strength of harmonics	Refer to Section 7.4.1		Pass	Section 7.4
15.207	AC Conducted Emissions 150kHz - 30MHz	< FCC 15.207 limits	Line Conducted	N/A	Section 7.5

**Notes:**

- 1) Mode of operation and data rates were investigated. The test results shown in the following sections represent the worst case emissions.
- 2) The analyzer plots shown in this section were all taken with a correction table loaded into the analyzer. The correction table was used to account for the losses of the cables and attenuators used as part of the system to connect the EUT to the analyzer at all frequencies of interest.
- 3) The radiation measurements are performed in X, Y, Z axis positioning. Only the worst case is shown in the report.

## 7.2. 99% Bandwidth Measurement

### 7.2.1. Test Limit

N/A

### 7.2.2. Test Procedure used

ANSI C63.10 Section 6.9

### 7.2.3. Test Setting

1. The analyzers' automatic bandwidth measurement capability was used to perform the 99% bandwidth measurement. The bandwidth measurement was not influenced by any intermediated power nulls in the fundamental emission.
2. RBW = approximately 1% to 5% of the OBW.
3. VBW  $\geq 3 \times$  RBW.
4. Detector = Peak.
5. Trace mode = max hold.

### 7.2.4. Test Setup

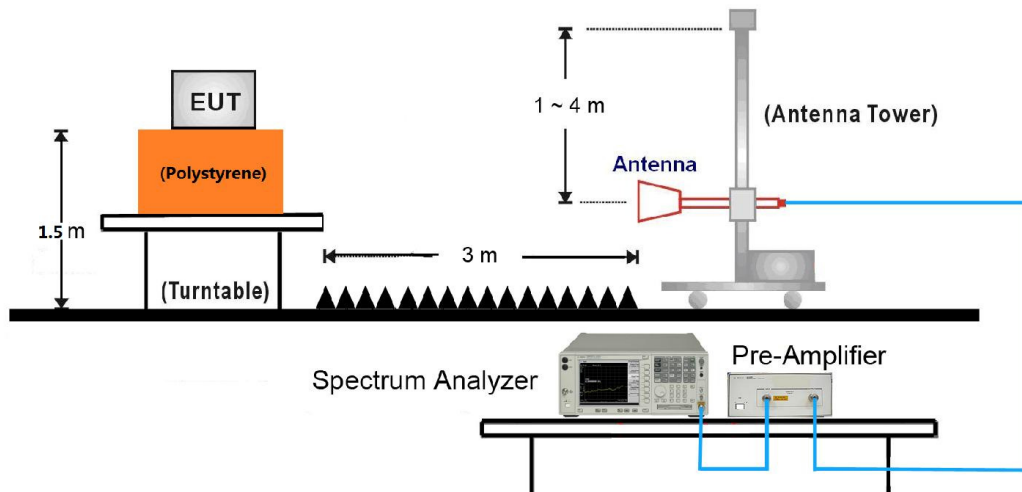

**7.2.5. Test Result**

Frequency (GHz)	99% Bandwidth (KHz)
10.525	686.4

99% Occupied Bandwidth	
10.525GHz	--
<p>The screenshot shows a Keysight Spectrum Analyzer interface. The main display shows a signal peak at 10.524 GHz with a power level of -12.93 dBm. The center frequency is set to 10.53 GHz, the span is 3 MHz, and the resolution bandwidth (Res BW) is 10.000 kHz. The video bandwidth (Video BW) is 30.000 kHz. The interface also shows various settings like input, attenuator, and trigger. A table at the bottom of the screenshot provides additional metrics: Occupied Bandwidth (686.54 kHz), Total Power (-5.77 dBm), Transmit Freq Error (-514.57 MHz), % of OBW Power (99.00%), and x dB Bandwidth (542.4 kHz).</p>	--



### 7.3. Field strength of fundamental

#### 7.3.1. Standard Applicable

According to §15.245(b), The field strength of emissions from intentional radiators operated within these frequency bands shall comply with the following:

Fundamental frequency (MHz)	Field strength of fundamental (millivolts/meter)	Field strength of harmonics (millivolts/meter)
902 - 928	500	1.6
2435 - 2465	500	1.6
5785 - 5815	500	1.6
10500 - 10550	2500	25.0
24075 - 24175	2500	25.0

Note 1: Field strength limits are specified at a distance of 3 meters.  
 Note 2: The emission limits shown above are based on measurement instrumentation employing an average detector. The provisions in §15.35 for limiting peak emissions apply.

#### 7.3.2. Test Procedure used

ANSI C63.10 Section 6.6

#### 7.3.3. Test Procedure

##### Peak Field Strength Measurements

1. Analyzer center frequency was set to the frequency of the radiated spurious emission of interest
2. RBW = as specified in Table 1
3. VBW = 3MHz
4. Detector = peak
5. Sweep time = auto couple
6. Trace mode = max hold
7. Trace was allowed to stabilize

**Table 1 - RBW as a function of frequency**

Frequency	RBW
9 ~ 150 kHz	200 ~ 300 Hz
0.15 ~ 30 MHz	9 ~ 10 kHz
30 ~ 1000 MHz	100 ~ 120 kHz
> 1000 MHz	1 MHz

### Average Field Strength Measurements

1. Analyzer center frequency was set to the frequency of the radiated spurious emission of interest
2. RBW = 1MHz
3. VBW  $\geq 1/T$
4. De As an alternative, the instrument may be set to linear detector mode. Ensure that video filtering is applied in linear voltage domain (rather than in a log or dB domain). Some instruments require linear display mode in order to accomplish this. Others have a setting for Average-VBW Type, which can be set to "Voltage" regardless of the display mode
5. Detector = Peak
6. Sweep time = auto
7. Trace mode = max hold
8. Allow max hold to run for at least 50 times (1/duty cycle) traces

#### 7.3.4. Test Setup

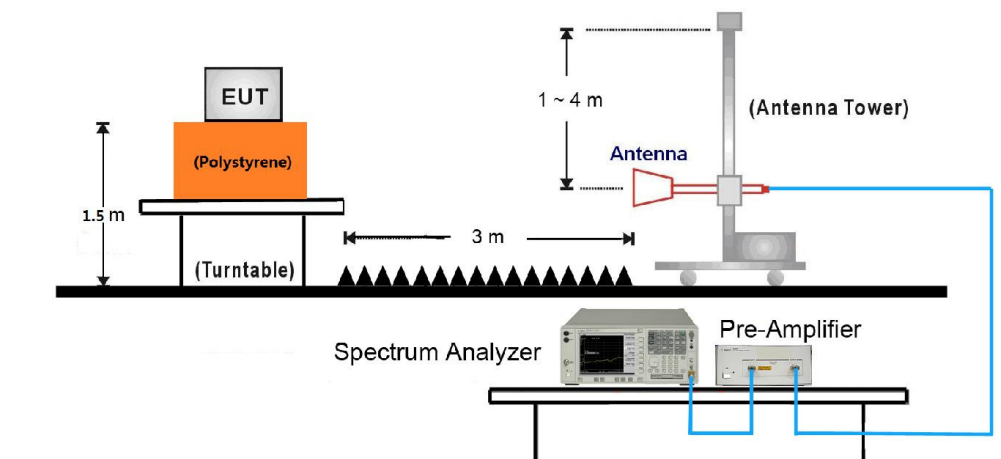

### 7.3.5. Test Results

Product	Digi-Sense DT Pet, US	Temperature	23°C
Test Engineer	Bruce Wang	Relative Humidity	54%
Test Site	AC1	Test Date	2018/01/19

Frequency (GHz)	Reading Level (dBμV)	Factor (dB)	Measure Level (dBμV/m)	Limit (dBμV/m)	Margin (dB)	Detector	Polarization
10.525	53.8	49.9	103.7	148	-44.3	Peak	Horizontal
10.525	52.2	49.9	102.1	128	-25.9	Average	Horizontal
10.525	41.0	49.9	90.9	148	-57.1	Peak	Vertical
10.525	40.2	49.9	90.1	128	-37.9	Average	Vertical

Note: Peak Limit (dBuV/m) = Average Limit (dBuV/m) + 20dB.

**7.4. Field strength of harmonics**

**7.4.1. Standard Applicable**

According to §15.245(b), the field strength of emissions from intentional radiators operated within these frequency bands shall comply with the following:

<b>Fundamental frequency (MHz)</b>	<b>Field strength of fundamental (millivolts/meter)</b>	<b>Field strength of harmonics (millivolts/meter)</b>
902 - 928	500	1.6
2435 - 2465	500	1.6
5785 - 5815	500	1.6
10500 - 10550	2500	25.0
24075 - 24175	2500	25.0

Note 1: Harmonic emissions in the restricted bands at and above 17.7 GHz shall not exceed 7.5 mV/m.  
 Note 2: Emissions radiated outside of the specified frequency bands, except for harmonics, shall be attenuated by at least 50 dB below the level of the fundamental or to the general radiated emission limits in §15.209, whichever is the lesser attenuation.  
 Note 3: Field strength limits are specified at a distance of 3 meters.  
 Note 4: The emission limits shown above are based on measurement instrumentation employing an average detector. The provisions in §15.35 for limiting peak emissions apply.

**For 15.205 requirement:**

Radiated emissions which fall in the restricted bands, as defined in Section 15.205(a) of FCC part 15, must also comply with the radiated emission limits specified in Section 15.209(a).

Frequency (MHz)	Frequency (MHz)	Frequency (MHz)	Frequency (GHz)
0.090 - 0.110	16.42-16.423	399.9 - 410	4.5-5.15
<sup>1</sup> 0.495 - 0.505	16.69475-16.69525	608 - 614	5.35-5.46
2.1735-2.1905	16.80425-16.80475	960 - 1240	7.25-7.75
4.125-4.128	25.5 -25.67	1300 - 1427	8.25 - 8.5
4.17725-4.17775	37.5-38.25	1435-1626.5	9.0-9.2
4.20725-4.20775	73-74.6	1645.5-1646.5	9.3-9.5
6.215-6.218	74.8-75.2	1660 - 1710	10.6-12.7
6.26775-6.26825	108-121.94	1718.8-1722.2	13.25-13.4
6.31175-6.31225	123 - 138	2200 - 2300	14.47-14.5
8.291-8.294	149.9-150.05	2310-2390	15.35-16.2
8.362-8.366	156.52475-156.525	2483.5 - 2500	17.7-21.4
8.37625-8.38675	156.7-156.9	2690 - 2900	22.01-23.12
8.41425-8.41475	162.0125-167.17	3260 - 3267	23.6-24.0
12.29-12.293	167.72-173.2	3332 - 3339	31.2-31.8
12.51975-12.52025	240 - 285	3345.8 - 3358	36.43-36.5
12.57675-12.57725	322-335.4	3600 - 4400	( <sup>2</sup> )
13.36-13.41	--	--	--

**7.4.2. Test Procedure used**

ANSI C63.10 Section 6.6

**7.4.3. Test Procedure**

**Peak Field Strength Measurements**

1. Analyzer center frequency was set to the frequency of the radiated spurious emission of interest
2. RBW = as specified in Table 1
3. VBW = 3MHz
4. Detector = peak
5. Sweep time = auto couple
6. Trace mode = max hold
7. Trace was allowed to stabilize

**Table 1 - RBW as a function of frequency**

Frequency	RBW
9 ~ 150 kHz	200 ~ 300 Hz
0.15 ~ 30 MHz	9 ~ 10 kHz
30 ~ 1000 MHz	100 ~ 120 kHz
> 1000 MHz	1 MHz

### **Average Field Strength Measurements**

1. Analyzer center frequency was set to the frequency of the radiated spurious emission of interest
2. RBW = 1MHz
3. VBW  $\geq 1/T$
4. De As an alternative, the instrument may be set to linear detector mode. Ensure that video filtering is applied in linear voltage domain (rather than in a log or dB domain). Some instruments require linear display mode in order to accomplish this. Others have a setting for Average-VBW Type, which can be set to "Voltage" regardless of the display mode
5. Detector = Peak
6. Sweep time = auto
7. Trace mode = max hold
8. Allow max hold to run for at least 50 times (1/duty cycle) traces

#### **7.4.4. Test Setup**

##### 9kHz ~ 30MHz Test Setup:

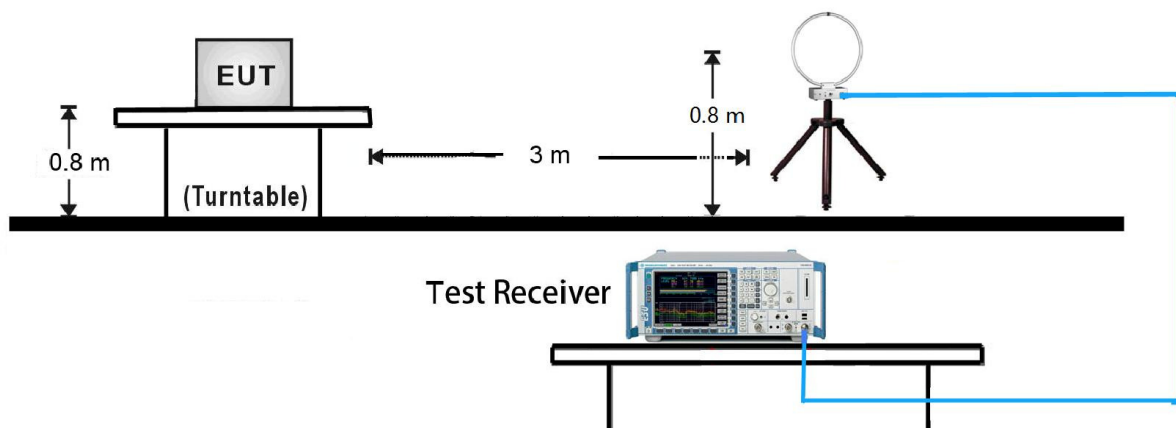

30MHz ~ 1GHz Test Setup:

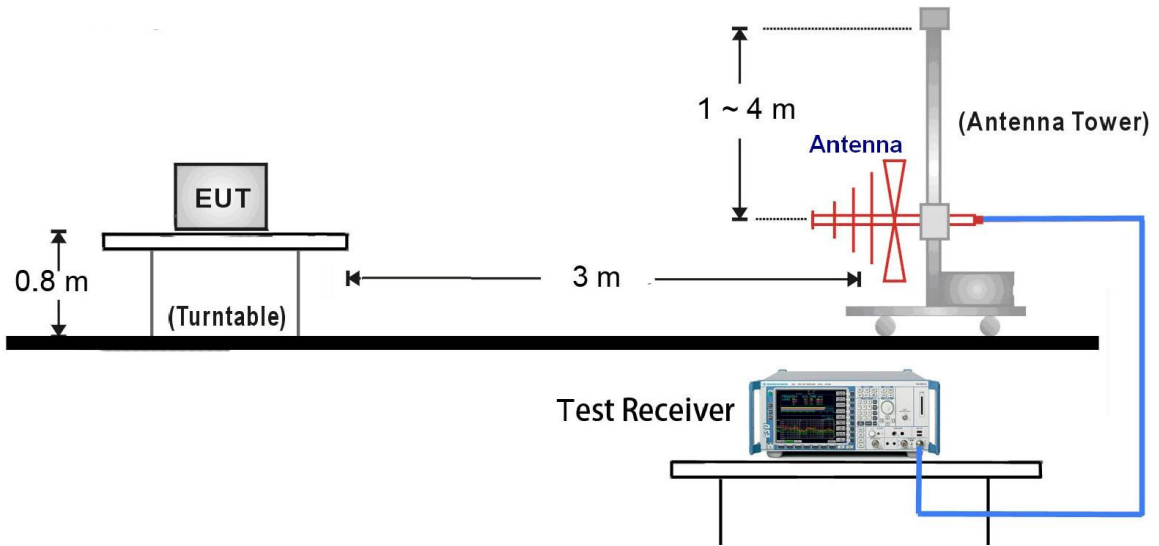

1GHz ~ 18GHz Test Setup:

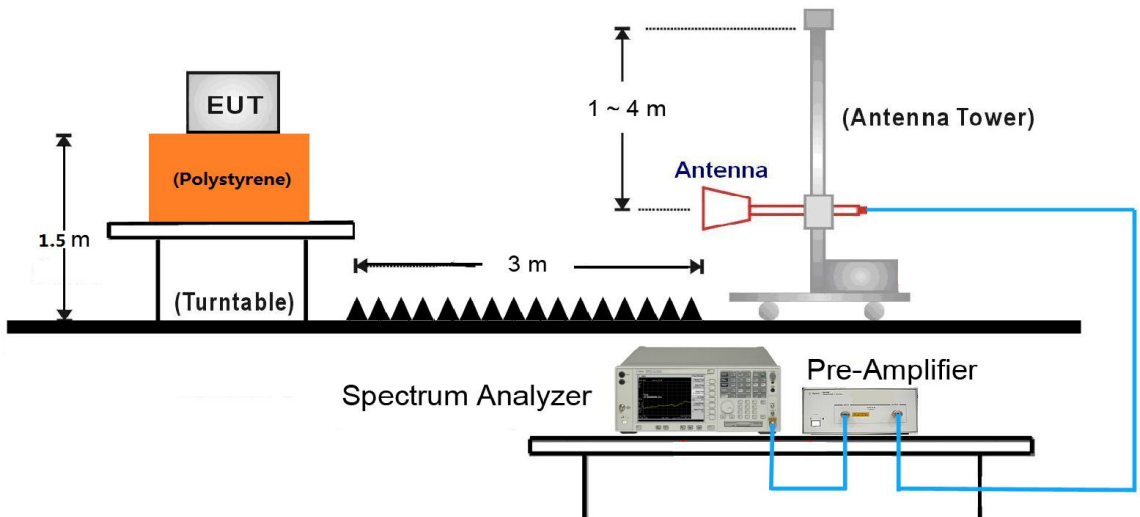

18GHz ~ 60GHz Test Setup:

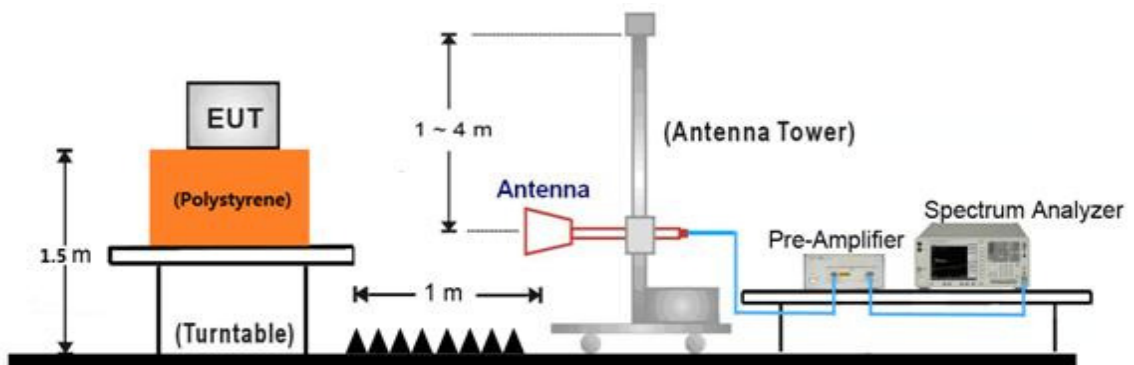

**7.4.5. Test Result**

Product	Digi-Sense DT Pet, US	Temperature	26°C
Test Engineer	Bruce Wang	Relative Humidity	56%
Test Site	AC1	Test Date	2018/01/19
Test Mode:	10.525GHz		
Remark:	1. Average measurement was not performed if peak level lower than average limit. 2. Other frequency was 20dB below limit line within 1-18GHz, there is not show in the report.		

Mark	Frequency (MHz)	Reading Level (dBµV)	Factor (dB)	Measure Level (dBµV/m)	Limit (dBµV/m)	Margin (dB)	Detector	Polarization
1	7953.0	46.7	13.5	60.2	74	-13.8	Peak	Horizontal
2	7953.0	26.2	13.5	39.7	54	-14.3	Average	Horizontal
3	13707.5	45.2	20.3	65.5	74	-8.5	Peak	Horizontal
4	13707.5	23.6	20.3	43.9	54	-10.1	Average	Horizontal
5	7477.0	47.2	12.9	60.1	74	-13.9	Peak	Vertical
6	7477.0	24.7	12.9	37.6	54	-16.4	Average	Vertical
7	14481.0	45.4	21.1	66.5	74	-7.5	Peak	Vertical
8	14481.0	22.1	21.1	43.2	54	-10.8	Average	Vertical

Note : Measure Level (dBµV/m) = Reading Level (dBµV) + Factor (dB)  
 Factor (dB) = Cable Loss (dB) + Antenna Factor (dB/m) - Pre\_Amplifier Gain (dB)



**Radiated Emission below 1GHz:**

Site: AC1	Time: 2018/01/19 - 05:45
Limit: FCC_Part15.209_RE(3m)	Engineer: Bruce Wang
Probe: VULB 9168 _20-2000MHz	Polarity: Horizontal
EUT: Digi-Sense DT Pet, US	Power: DC 12V
Test Mode: Transmit at Channel 10525MHz	

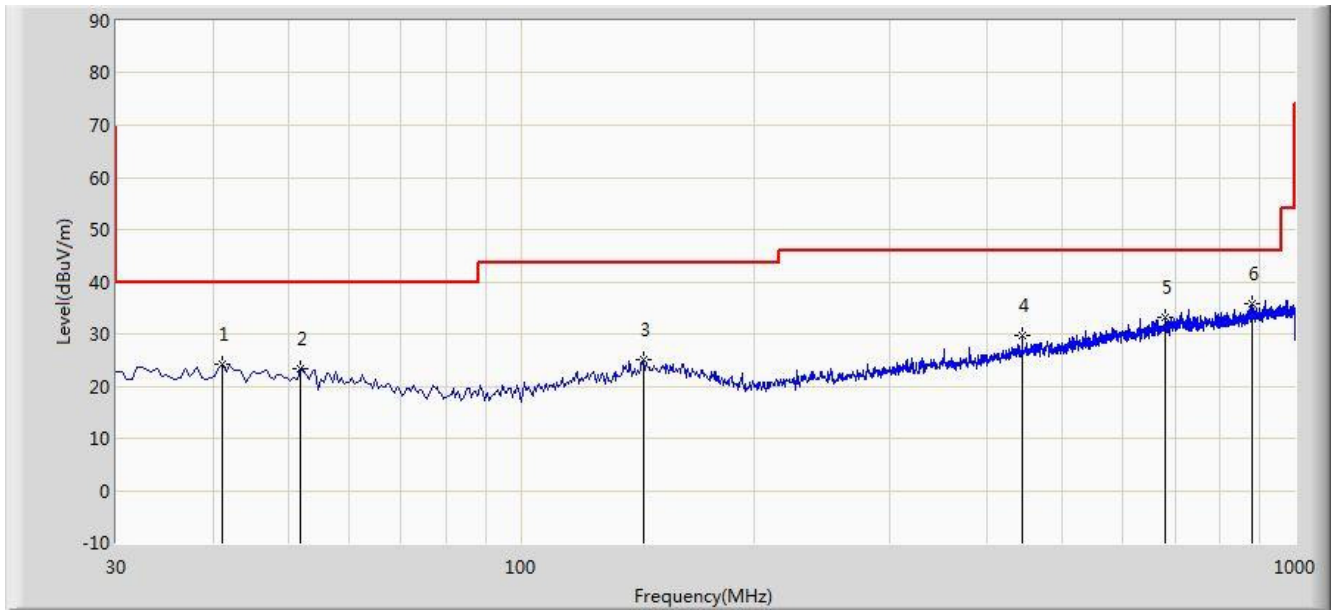

No	Flag	Mark	Frequency (MHz)	Measure Level (dBuV/m)	Reading Level (dBuV)	Over Limit (dB)	Limit (dBuV/m)	Factor (dB)	Type
1			41.155	24.152	9.600	-15.848	40.000	14.552	PK
2			51.825	23.297	9.234	-16.703	40.000	14.064	PK
3			143.975	25.156	10.290	-18.344	43.500	14.866	PK
4			444.190	29.696	11.926	-16.304	46.000	17.770	PK
5			681.355	33.230	11.360	-12.770	46.000	21.869	PK
6		*	878.750	35.702	11.582	-10.298	46.000	24.120	PK

Note 1: Measure Level (dBuV/m) = Reading Level (dBuV) + Factor (dB)

Factor (dB) = Cable Loss (dB) + Antenna Factor (dB/m)

Note 2: If the emission level of the EUT in peak mode was 10dB lower than the limit specified, peak value of EUT will be reported. Otherwise, the emission will be repeated by using the quasi-peak method and reported.

Note 3: The test trace is same as the ambient noise and the amplitude of the emissions are attenuated more than 20dB below the permissible (the test frequency range: 9kHz ~ 30MHz, 40GHz ~ 60GHz), therefore no data appear in the report.

Site: AC1	Time: 2018/01/19 - 06:02
Limit: FCC_Part15.209_RE(3m)	Engineer: Bruce Wang
Probe: VULB 9168 _20-2000MHz	Polarity: Vertical
EUT: Digi-Sense DT Pet, US	Power: DC 12V
Test Mode: Transmit at Channel 10525MHz	

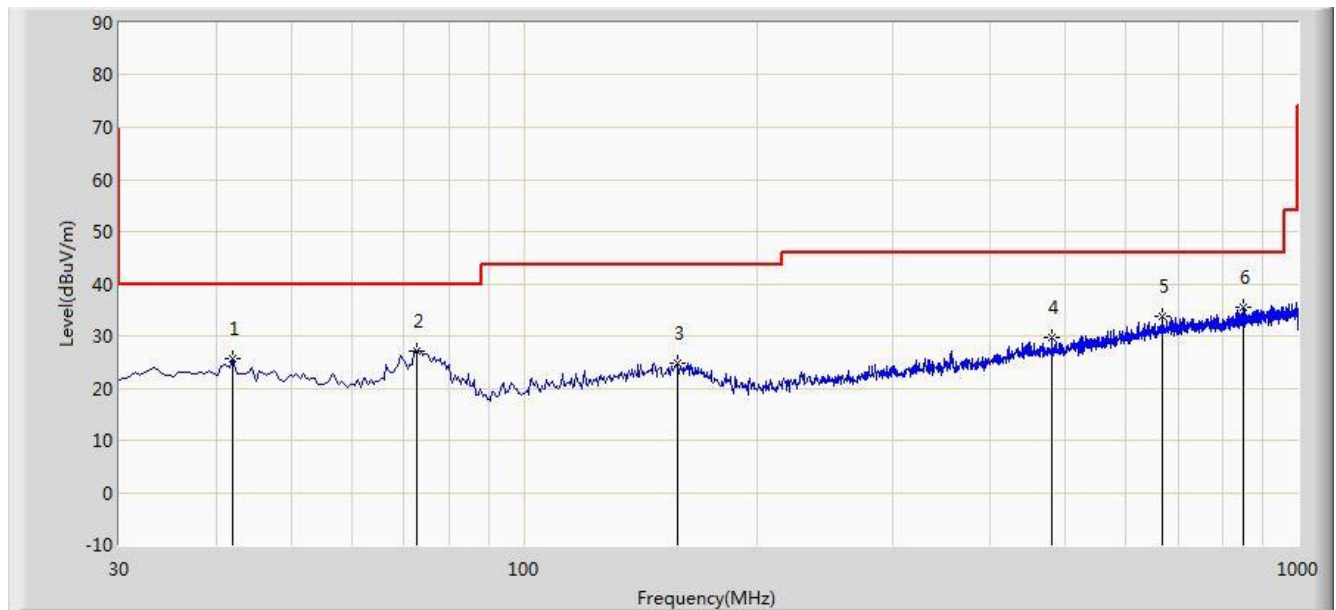

No	Flag	Mark	Frequency (MHz)	Measure Level (dBuV/m)	Reading Level (dBuV)	Over Limit (dB)	Limit (dBuV/m)	Factor (dB)	Type
1			42.125	25.553	11.063	-14.447	40.000	14.490	PK
2			72.680	27.140	15.946	-12.860	40.000	11.193	PK
3			158.040	24.711	9.413	-18.789	43.500	15.298	PK
4			481.535	29.614	11.311	-16.386	46.000	18.303	PK
5			668.260	33.683	11.977	-12.317	46.000	21.706	PK
6		*	851.590	35.586	11.821	-10.414	46.000	23.765	PK

Note 1: Measure Level (dBuV/m) = Reading Level (dBuV) + Factor (dB)

Factor (dB) = Cable Loss (dB) + Antenna Factor (dB/m)

Note 2: If the emission level of the EUT in peak mode was 10dB lower than the limit specified, peak value of EUT will be reported. Otherwise, the emission will be repeated by using the quasi-peak method and reported.

Note 3: The test trace is same as the ambient noise and the amplitude of the emissions are attenuated more than 20dB below the permissible (the test frequency range: 9kHz ~ 30MHz, 40GHz ~ 60GHz), therefore no data appear in the report.

## 7.5. AC Conducted Emissions Measurement

### 7.5.1. Test Limit

FCC Part 15 Subpart C Paragraph 15.207 Limits		
Frequency (MHz)	QP (dBuV)	AV (dBuV)
0.15 - 0.50	66 - 56	56 - 46
0.50 - 5.0	56	46
5.0 - 30	60	50

Note 1: The lower limit shall apply at the transition frequencies.

Note 2: The limit decreases linearly with the logarithm of the frequency in the range 0.15MHz to 0.5MHz.

### 7.5.2. Test Setup

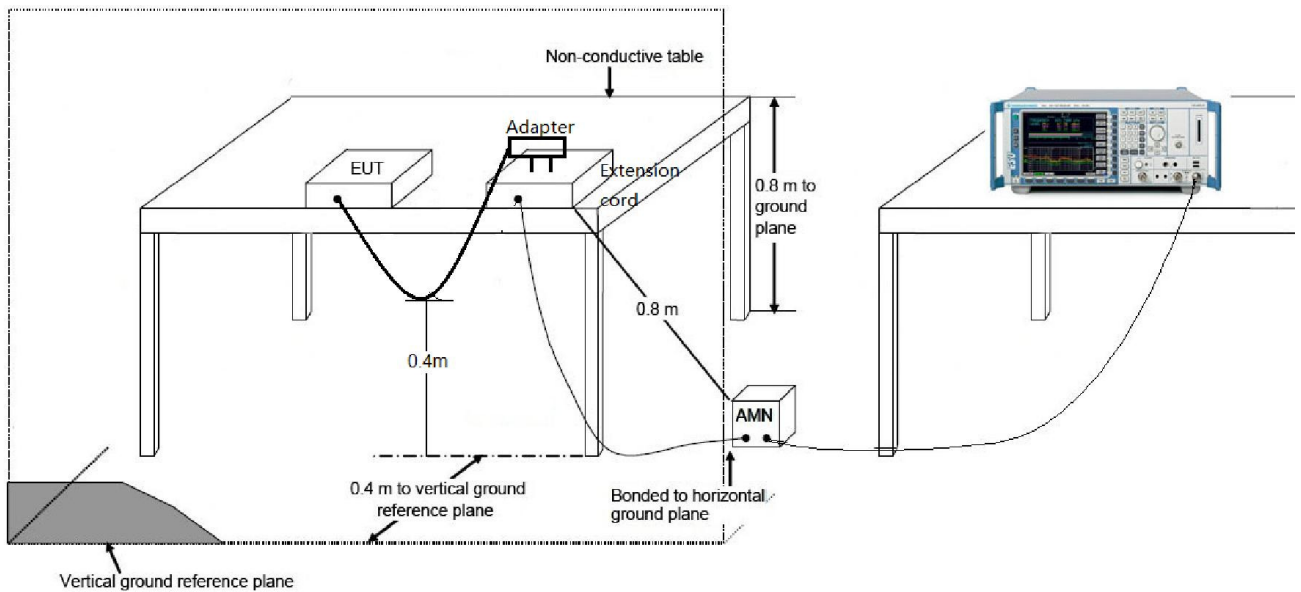

### 7.5.3. Test Result

Power supply of this device is by DC, so this item is not assessed.

## 8. CONCLUSION

The data collected relate only the item(s) tested and show that the **Digi-Sense DT Pet, US** is in compliance with FCC Part 15.245 of the FCC Rules.

---

The End