

EN

FR

ES

IT

PR

NL

# Beyond™ DT Wired Outdoor Detector Installation Instructions



Model: RK350DT

For more information about RISCO Group's branches, distributors and full product line, please visit [riscogroup.com](http://riscogroup.com)



## Description

The Beyond™ DT has been designed to provide enhanced 24-hour outdoor protection, with Active IR Anti-mask capabilities. Integrated Dual Technology (DT) combines two K-band microwave channels with two PIR sensors for better catch performance and pet immunity, minimizing false alarms. The Beyond™ DT can also be installed on the RISCO Bus saving time and money.

## Features include

- PIR coverage: 12m, 90°
- Two channel K band - MW detection (**Sway Recognition**)
- Pet friendly (pet immunity)
- Two correlated PIR Sensors
- Light sensor for reducing false alarms due to sunlight
- Active IR Anti mask
- Mounting at 2.2m with optional swivel bracket
- Designed for outdoor installation, UV resistant, IP 54
- Cover and wall tamperers
- Optional Swivel Bracket (Model: RA350S)

## Installation

### Step 1: Preliminary Considerations

Select the mounting location for best coverage of the area that is to be protected (see Coverage Patterns). Pay attention to the following:

- Install the device at a height of 2.2m (7 ft 2 in). Any lower installation will reduce the detection range accordingly.
- For pet immunity, the height of an animal (without weight limitation) is up to 50 cm (1ft 6 in) when the device is installed at 2.2 m (7ft 2 in). Any lower installation will reduce the pet immunity accordingly.
- Install the device in a location where the detector's field of view is clear of any static obstacles.
- Mount the device so that walking traffic cuts across the beam pattern.
- Do not install the device close to any moving objects.
- Do not install more than one DT detector within a 1m radius.

### Step 2: Mounting the Detector on Wall Bracket

1. Unscrew the fastening screw and remove the detector from the mounting bracket (see Figure 1).
2. Open the 5 knockout holes of the wall bracket, and use as a template for mounting (see Figure 2).
3. Insert external wiring through the cable channel on the back of the wall bracket (see Figure 2).
4. Secure the wall bracket to the wall (see Figure 3).
5. Connect the Terminal Block to the detector (see Figure 4).
6. Connect the terminal wiring (see Step 5a).
7. Set the DIP switch settings (see Step 5b).
8. Mount the detector to the wall bracket (see Figure 5).

9. Perform a walk test (see Step 7).
10. Insert and fasten the screw to lock the detector (see Figure 5).

### Step 3: PIR Coverage

Mounting height [m]	Swivel Angle [°]	Distance [m]
1.8	0	10
	5	7
	10	5
2.2 (optimal)	0	12
	5	8
	10	6
2.5	0	N/A
	5	10
	10	7
2.7	0	N/A
	5	10
	10	7

NA = Avoid such installation

### Step 4: Setting Detector Mode

#### Standalone Mode

1. DIP SW 6 is OFF
2. Terminal wiring as in Step 5a

#### RISCO BUS Mode

1. DIP SW 6 is ON
2. Wiring:
  - a) + - terminal – Detector 12 VDC, - GND
  - b) Connecting YEL / GRN – Detector BUS
  - c) Continue to step 6

### Step 5a: Connecting the Terminal Wiring (Standalone Mode)

Connect the terminal wiring according to the following:

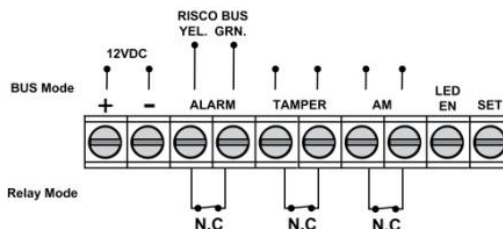

Terminal	Description	
+ -	+12 VDC, - GND	
ALARM YEL GRN	N.C alarm relay	YEL / GRN (RISCO BUS)
	NOTE: As defined by DIP SW 6	
TAMPER +-	N.C tamper switch	
AM +-	N.C anti mask alarm relay	
LED ENABLE	<p>Used to remotely control the LEDs when DIP1 is set to ON</p> <p><b>Enable:</b> input is +12V OR no terminal connection</p> <p><b>Disable:</b> Connect the input to 0V</p> <p>This feature prevents an intruder from gaining knowledge of the detector's status and disables anti-mask detection.</p>	
SET / UNSET	This input enables controlling anti-masking operation in accordance to the system status, Set (Arm) / Unset (Disarm).	
	System Status	Input Status
	Set (Arm)	0V
	Unset (Disarm)	12V or no connection
	AM Relay	Off
	On*	
	* DIP SW 4 is ON (Anti mask enabled)	

NOTE: Make sure that jumper J5 is installed to bypass the Swivel Tamper.

## Step 5b: Setting DIP Switch Settings (Standalone Mode)

Set the DIP switch settings according to the table, below:

DIP SW	Description	Def.	Def. Status				
1*	LEDs: ON: Enable / OFF: Disable	ON	LEDs ON				
2*	Sensitivity (PIR)	Low	Mid.	Norm.	Max.	ON	Normal
		OFF	OFF	ON	ON		
3*		OFF	ON	OFF	ON	OFF	
4*	Anti Masking: ON: Enable / OFF: Disable	ON	Enable				
5*	High Sensitivity (Anti Mask): ON: High /OFF: Low	OFF	Low				
6	Mode: ON: BUS / OFF: Relay (see Defining BUS ID)	OFF	Relay				
	Relay mode	DIP SW 7	DIP SW 8	DIP SW 9	DIP SW 10		
	Normal	OFF	OFF	OFF	OFF		
	DEOL	ON	ON	OFF	OFF		
	TEOL	ON	ON	ON	ON		

### NOTES:

1. For DEOL DIP switches 7 and 8 should both be ON.
2. For TEOL DIP switch 7-10 should be ON.



Adjust microwave coverage area by using the trimmer on the PCB.

## Step 6a: Defining the BUS ID (BUS Mode)

Use DIP switches 1 to 5 to define the BUS ID of each detector. Define the BUS ID settings according to the table below.

Set DIP switch setting 6 according to the following data:

6	Mode: ON: BUS / OFF: Relay (see Defining BUS ID)	ON	BUS
---	--	----	-----

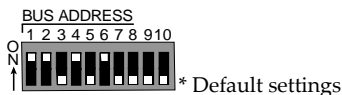

ID	1	2	3	4	5
01	OFF	OFF	OFF	OFF	OFF
02	ON	OFF	OFF	OFF	OFF
03	OFF	ON	OFF	OFF	OFF
04	ON	ON	OFF	OFF	OFF
05	OFF	OFF	ON	OFF	OFF
06	ON	OFF	ON	OFF	OFF
07	OFF	ON	ON	OFF	OFF
08	ON	ON	ON	OFF	OFF
09	OFF	OFF	OFF	ON	OFF
10	ON	OFF	OFF	ON	OFF
11	OFF	ON	OFF	ON	OFF
12	ON	ON	OFF	ON	OFF
13	OFF	OFF	ON	ON	OFF
14	ON	OFF	ON	ON	OFF
15	OFF	ON	ON	ON	OFF
16	ON	ON	ON	ON	OFF

ID	1	2	3	4	5
17	OFF	OFF	OFF	OFF	ON
18	ON	OFF	OFF	OFF	ON
19	OFF	ON	OFF	OFF	ON
20	ON	ON	OFF	OFF	ON
21	OFF	OFF	ON	OFF	ON
22	ON	OFF	ON	OFF	ON
23	OFF	ON	ON	OFF	ON
24	ON	ON	ON	OFF	ON
25	OFF	OFF	OFF	ON	ON
26	ON	OFF	OFF	ON	ON
27	OFF	ON	OFF	ON	ON
28	ON	ON	OFF	ON	ON
29	OFF	OFF	ON	ON	ON
30	ON	OFF	ON	ON	ON
31	OFF	ON	ON	ON	ON
32	ON	ON	ON	ON	ON

**NOTE:** This step is only relevant for detectors that are connected to the RISCO BUS.

## Step 6b: Defining System Settings (BUS Mode)

### LightSYS / ProSYS Plus – Add the BUS detector

1. Select Installer menu: [7] Install > [1] BUS Device > [1] Automatic. The system automatically searches for the detectors BUS ID and assigns a zone (according to the defined DIP switch settings).
2. Scroll to the defined zone with type ODT50 and click OK to confirm.

### Configure the BUS detector parameters:

Select Installer menu: [2] Zones > [1] Parameters > [2] By Category > [7] Advanced [4] BUS Zone Parameters (see LightSYS / ProSYS Plus Installation Manual).

**NOTE:** For LightSYS Version 5.20 and above.

## Step 7: Performing a Walk Test

The detector cover should be closed during the walk test. Apply power and wait at least two minutes for the detector to stabilize. Upon detection the detector transmits a signal and the LEDs light-up. Walk through the entire protected area and observe the LEDs to confirm full coverage (see LED Status).

### Manually initiate a walk test:

Select User Menu: Maintenance > Walk Test > Select Full Walk Test or Quick Walk Test. The detector remains in walk test mode until any key on the panel is pressed.

## LED Status

LED	State	Description
YELLOW	Blink ON	Indicates start of PIR detection analysis
	Steady ON	Indicates PIR detection
	Flashing	Indicates Active IR AM (Anti mask) detection
GREEN	Steady ON	Indicates MW detection
RED	Steady ON	Indicates ALARM
	Flashing	Indicates malfunctioned communication with the RISCO system (BUS Mode only)
All LEDs	Flashing (One after another)	Unit initialization on power up

NOTE: DIP-SW 1 should be in ON position to enable LED indications.

## Self-Test

Every hour the detector performs an internal self-test for both PIR and MW channels. A fault detected in the self-test will be indicated by a momentary open anti-mask relay (in relay mode) or by a corresponding message in the panel (in BUS mode).

## Specifications

Electrical	
Current consumption:	30mA at 12 VDC (Stand by) 42mA at 12 VDC (MAX with LED ON)
Power output	16dBm
Voltage requirements	9 -16 VDC
Alarm contacts	24 VDC, 0.1A
AM contacts	24 VDC, 0.1A
Tamper contacts	24 VDC, 0.1A
Physical	
Size (LxWxD):	170 x 90 x 90mm
Weight:	0.532 Kg
Environmental	
RF Immunity:	According to EN50130-4
Operating Temperature:	-30°C to 60°C (90% humidity)
Storage Temperature:	-30°C to 70°C (90% humidity)

# Preliminary Considerations

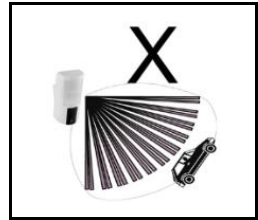
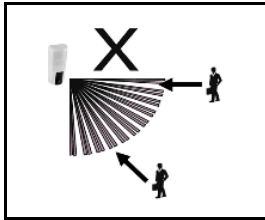
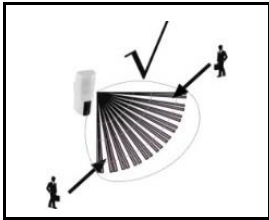
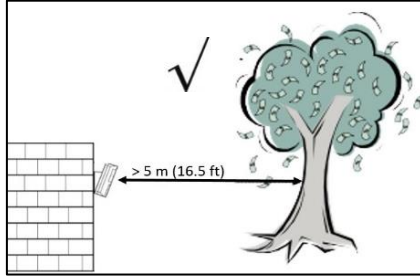
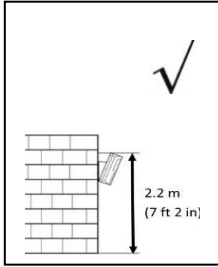

**NOTE:** Avoid installation facing moving cars / road at a distance of up to 30m.

PIR Coverage Pattern: 12m, 90°

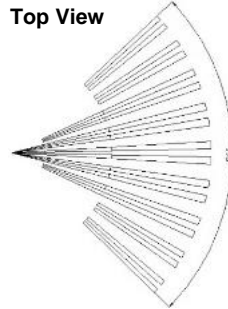
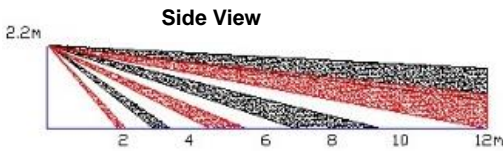

# Termination Resistance

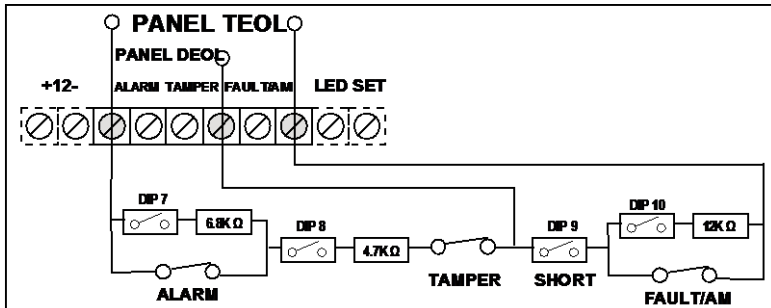



Figure 1

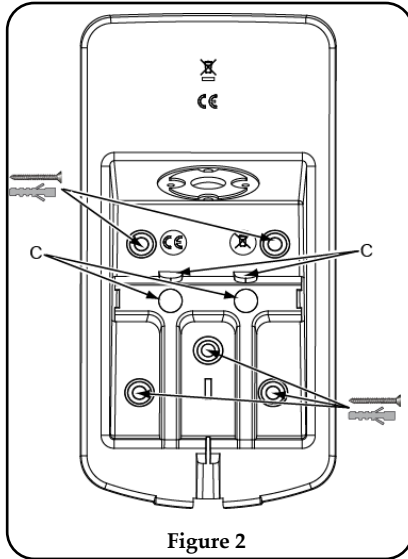

Figure 2

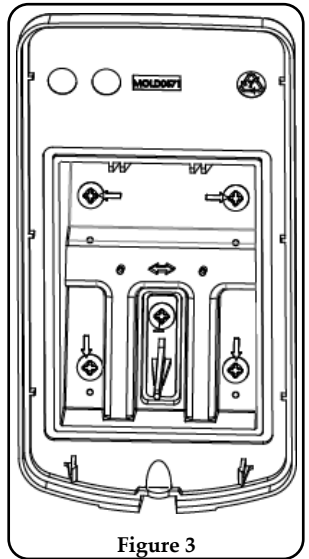

Figure 3

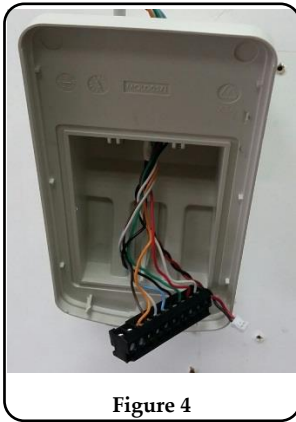

Figure 4



Figure 5

**Ordering Information**

RK350DT0000A	Beyond DT, K Band Detector
RA350S00000A	180° Swivel for Beyond DT

**RED Compliance Statement**

Hereby, RISCO Group declares that this equipment is in compliance with the essential requirements and other relevant provisions of Directive 2014/53/EU. For the CE Declaration of Conformity please refer to our website: [www.riscogroup.com](http://www.riscogroup.com)



## Description

Le Beyond™ DT a été conçu pour assurer une protection extérieure fiable 24 heures sur 24, avec une fonction d'anti-masque à IR actif. La double technologie (DT) intégrée associe deux canaux hyperfréquences bande K à deux capteurs IRP de façon à optimiser les performances de détection et l'immunité aux animaux, pour ainsi minimiser les fausses alarmes. Le Beyond™ DT peut aussi être installé sur le Bus RISCO pour un gain de temps et d'argent.

## Principales fonctionnalités

- Couverture IRP : 12 m, 90°
- 2 canaux de détection hyperfréquence bande K (reconnaissance des mouvements de balancier)
- Immunité aux animaux
- Deux capteurs IRP en corrélation
- Capteur optique pour réduire les fausses alarmes provoquées par la lumière du soleil
- Anti-masque à IR actif
- Installation à 2,2 m avec un support de fixation en option
- Conçu pour une installation en extérieur, résistant aux UV, indice IP 54
- Autoprotection à l'ouverture et à l'arrachement
- Support pivotant en option (modèle : RA350S)

## Installation

### Étape 1 : Considérations préliminaires

Sélectionnez l'emplacement de montage le mieux adapté pour couvrir la zone à protéger (reportez-vous à la section Couverture IRP). Respectez les consignes suivantes :

- Installez l'appareil à une hauteur de 2,2 mètres. Toute installation à une hauteur inférieure risque de réduire la portée de détection.
- Pour l'immunité aux animaux, l'animal doit mesurer 50 cm maximum (sans limitation de poids) lorsque l'appareil est installé à 2,2 m. Toute installation à une hauteur inférieure réduira l'immunité aux animaux en conséquence.
- Installez l'appareil dans un lieu où aucun obstacle statique n'obstrue le champ de vision du détecteur.
- Installez l'appareil de façon à ce que les personnes qui marchent dans la zone surveillée coupent les faisceaux de détection.
- N'installez pas l'appareil à proximité d'objets en mouvement.
- N'installez pas plusieurs détecteurs DT dans un rayon de 1 mètre.

### Étape 2 : Installation du détecteur sur le support mural

1. Desserrez la vis de fixation et retirez le détecteur du support de montage (reportez-vous à la Figure 1).

2. Ouvrez les 5 trous marqués du support mural et utilisez-les comme gabarits pour l'installation (reportez-vous à la Figure 2).
3. Insérez les câbles externes dans la voie de câbles à l'arrière du support mural (reportez-vous à la Figure 2).
4. Fixez le support de montage au mur (reportez-vous à la Figure 3).
5. Récupérez le bornier débrochable pour le câbler (reportez-vous à la Figure 4).
6. Câblez le bornier débrochable (reportez-vous à l'Étape 5a).
7. Raccordez le bornier débrochable, puis configurez les DIP Switchs (reportez-vous à l'Étape 5b).
8. Montez le détecteur sur le support mural (reportez-vous à la Figure 5).
9. Effectuez un test de marche (reportez-vous à l'Étape 7).
10. Insérez la vis et serrez-la pour fixer le détecteur (reportez-vous à la Figure 5).

### Étape 3 : Couverture IRP

Hauteur d'installation [m]	Angle de pivotement [°]	Distance [m]
1,8	0	10
	5	7
	10	5
2,2 (optimale)	0	12
	5	8
	10	6
2,5	0	N/A
	5	10
	10	7
2,7	0	N/A
	5	10
	10	7

N/A = Évitez ce type d'installation

### Étape 4 : Sélection du mode du détecteur

#### Mode Autonome

1. Le DIP Switch 6 est en position OFF
2. Câblage du bornier conformément à l'Étape 5a

#### Mode Bus RISCO

1. Le DIP Switch 6 est en position ON
2. Câblage :
  - a) Borne + - - Alimentation du détecteur 12 V CC, - 0 V
  - b) Câblages des bornes YEL/GRN - Bus du détecteur
  - c) Passez à l'étape 6

## Étape 5a : Câblage du bornier (mode Autonome)

Câblez le bornier en procédant comme suit :

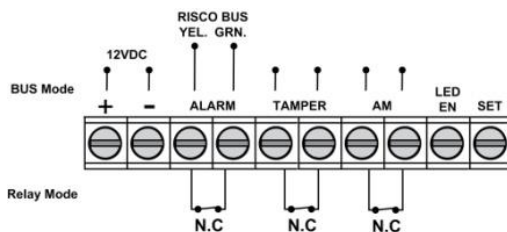

Borne	Description									
+ -	+12 V CC, - 0 V									
ALARM YEL GRN	Relais d'alarme N.F   YEL/GRN (Bus RISCO) <b>REMARQUE</b> : selon la configuration du DIP Switch 6									
TAMPER + -	Relais d'autoprotection N.F									
AM + -	Relais d'alarme anti-masque N.F									
LED ENABLE	Borne utilisée pour contrôler à distance les LEDs lorsque le DIP Switch 1 est réglé sur ON <b>Activé</b> : l'entrée est de +12 V ou aucune connexion à la borne <b>Désactivé</b> : raccordez cette entrée sur 0 V Cette fonction empêche un intrus de connaître l'état du détecteur et désactive la détection anti-masque.									
SET/UNSET	Cette entrée permet de contrôler l'opération d'anti-masquage en fonction de l'état du système : Set (Armé) / Unset (Désarmé). <table border="1" style="width: 100%; border-collapse: collapse;"> <thead> <tr> <th>État du système</th> <th>État de l'entrée</th> <th>Relais AM</th> </tr> </thead> <tbody> <tr> <td>Set (Armé)</td> <td>0 V</td> <td>Désactivé</td> </tr> <tr> <td>Unset (Désarmé)</td> <td>12 V ou pas de connexion</td> <td>Activé*</td> </tr> </tbody> </table> <p>* Le DIP Switch 4 est réglé sur ON (anti-masque activé)</p>	État du système	État de l'entrée	Relais AM	Set (Armé)	0 V	Désactivé	Unset (Désarmé)	12 V ou pas de connexion	Activé*
État du système	État de l'entrée	Relais AM								
Set (Armé)	0 V	Désactivé								
Unset (Désarmé)	12 V ou pas de connexion	Activé*								

**REMARQUE** : vérifiez que le cavalier J5 est installé pour ignorer l'autoprotection du support.

## Étape 5b : Configuration des DIP Switch (mode Autonome)

Configurez les DIP Switch en vous reportant au tableau ci-dessous :

DIP SW	Description	Déf.	État déf.			
1*	LEDs : ON : activées / OFF : désactivées	ON	LEDs activées			
2*	Sensibilité (IRP)	Faible	Moyen	Normal	ON	Normal
		OFF	OFF	ON		
3*		OFF	ON	OFF	ON	OFF
4*	Anti-masque : ON : activé / OFF : désactivé	ON		Activé		
5*	Haute sensibilité (AM) : ON : élevée / OFF : faible	OFF		Faible		
6	Mode : ON : Bus / OFF : Relais (voir Définition de l'ID Bus)	OFF		Relais		

Mode relais	DIP Switch 7	DIP Switch 8	DIP Switch 9	DIP Switch 10
Normal	OFF	OFF	OFF	OFF
DEOL	ON	ON	OFF	OFF
TEOL	ON	ON	ON	ON

**REMARQUES :**

1. Pour un câblage DEOL, les DIP Switch 7 et 8 doivent être sur ON.
2. Pour un câblage TEOL, les DIP Switch 7 à 10 doivent être sur ON.



Réglez la zone de couverture des canaux hyperfréquences à l'aide du potentiomètre du PCB.

## Étape 6a : Définition de l'ID Bus (mode BUS)

Utilisez les DIP Switch 1 à 5 pour définir l'ID Bus de chaque détecteur. Définissez les paramètres d'ID Bus en vous reportant au tableau ci-dessous.

Configurez le commutateur DIP 6 en fonction des données suivantes :

6	Mode : ON : Bus / OFF : Relais (voir Définition de l'ID Bus)	ON	BUS
---	--	----	-----

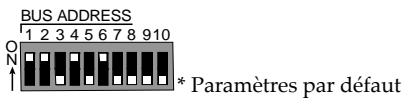

ID	1	2	3	4	5	ID	1	2	3	4	5
01	OFF	OFF	OFF	OFF	OFF	17	OFF	OFF	OFF	OFF	ON
02	ON	OFF	OFF	OFF	OFF	18	ON	OFF	OFF	OFF	ON
03	OFF	ON	OFF	OFF	OFF	19	OFF	ON	OFF	OFF	ON
04	ON	ON	OFF	OFF	OFF	20	ON	ON	OFF	OFF	ON
05	OFF	OFF	ON	OFF	OFF	21	OFF	OFF	ON	OFF	ON
06	ON	OFF	ON	OFF	OFF	22	ON	OFF	ON	OFF	ON
07	OFF	ON	ON	OFF	OFF	23	OFF	ON	ON	OFF	ON
08	ON	ON	ON	OFF	OFF	24	ON	ON	ON	OFF	ON
09	OFF	OFF	OFF	ON	OFF	25	OFF	OFF	OFF	ON	ON
10	ON	OFF	OFF	ON	OFF	26	ON	OFF	OFF	ON	ON
11	OFF	ON	OFF	ON	OFF	27	OFF	ON	OFF	ON	ON
12	ON	ON	OFF	ON	OFF	28	ON	ON	OFF	ON	ON
13	OFF	OFF	ON	ON	OFF	29	OFF	OFF	ON	ON	ON
14	ON	OFF	ON	ON	OFF	30	ON	OFF	ON	ON	ON
15	OFF	ON	ON	ON	OFF	31	OFF	ON	ON	ON	ON
16	ON	ON	ON	ON	OFF	32	ON	ON	ON	ON	ON

**REMARQUE :** cette étape s'applique uniquement aux détecteurs connectés au bus RISCO.

## Étape 6b : Configuration des paramètres système (mode Bus)

### LightSYS / ProSYS Plus – Ajout du détecteur Bus

1. Allez dans le menu Installateur : Programmation > [7] Install > [1] Access. BUS > [1] Automatique. Le système cherche automatiquement l'ID Bus des détecteurs et les assigne à une zone (selon l'ID défini par la configuration des DIP Switch).
2. Vérifiez que la zone est bien reconnue en type ODT50 et cliquez sur OK pour confirmer.

### Configuration des paramètres du détecteur Bus :

Allez dans le menu Installateur : Programmation > [2] Zones > [1] Paramètres > [2] Par catégorie > [7] Avancée > [4] Param. Z. Bus (reportez-vous au guide d'installation de la LightSYS/ProSYS Plus).

**REMARQUE :** pour LightSYS v5.20 et les versions ultérieures.

## Étape 7 : Test de marche

Le couvercle du détecteur doit être fermé lors du test de marche. Mettez le détecteur sous tension et attendez au moins deux minutes qu'il se stabilise. Pendant la détection, le détecteur transmet un signal et la LED s'allume. Parcourez la zone protégée et observez les LEDs pour vérifier que la zone est entièrement couverte (reportez-vous à la rubrique État des LEDs).

### Lancement manuel du Test de marche :

Allez dans le menu Utilisateur ou Installateur : Maintenance > Test de marche > Test complet ou Test rapide. Le détecteur reste en mode Test de marche tant que vous n'appuyez sur aucune touche.

## État des LEDs

LED	État	Description
JAUNE	1 seul clignotement	Indique le début de l'analyse de détection IRP
	Fixe	Indique une détection IRP
	Clignotement continu	Indique une détection AM (anti-masque) à IR actif
VERT	Fixe	Indique une détection hyperfréquence
ROUGE	Fixe	Indique une alarme
	Clignotement continu	Indique une erreur de communication avec le système RISCO (mode Bus uniquement)
Toutes les LEDs	Clignotement continu (l'une après l'autre)	Initialisation de l'unité après la mise sous tension

**REMARQUE :** Le DIP Switch 1 doit être en position ON pour activer les indications LEDs.

## Test automatique

Toutes les heures, le détecteur effectue un test automatique interne pour les canaux IRP et hyperfréquences. Toute erreur détectée au cours d'un test automatique est indiquée par un relais anti-masque momentanément ouvert (en mode Relais) ou par un message correspondant sur la centrale (en mode Bus).

# Spécifications

Électriques	
Consommation électrique :	30mA à 12 VCC (Repos) 42mA à 12 VCC (MAX avec LEDs activées)
Puissance disponible	16dBm
Tension requise :	9 -16 VCC
Contacts d'alarme :	24 VCC, 0.1A
Contacts anti-masque :	24 VCC, 0.1A
Contacts autoprotection :	24 VCC, 0.1A
Physiques	
Dimensions (LxlxP) :	170 x 90 x 90mm
Poids :	0.532 Kg
Environnementales	
Immunité RF :	Selon la norme EN50130-4
Température de fonctionnement :	-30°C à 60°C (90% d'humidité)
Température de stockage :	-30°C à 70°C (90% d'humidité)

# Considérations préliminaires

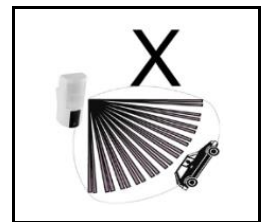
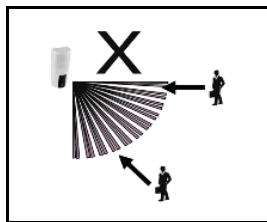
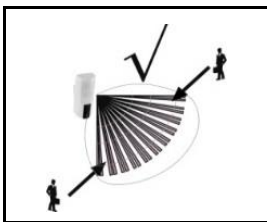
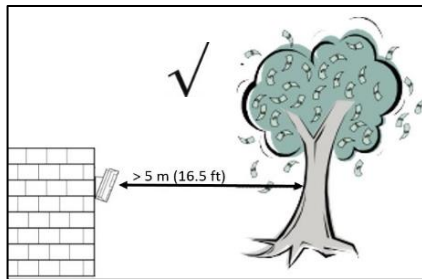
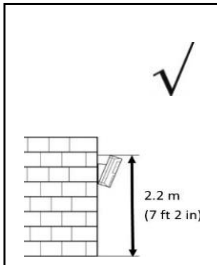

**REMARQUE :** Evitez d'installer le détecteur face à une route / des véhicules en mouvement à moins de 30 m maximum.

Couverture IRP : 12 m, 90°

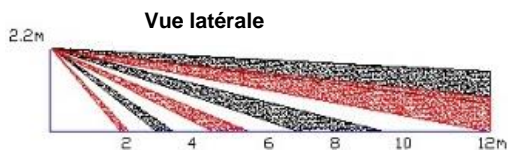

**Vue de dessus**

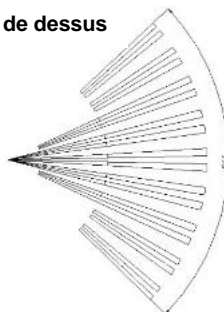

## Résistances de fin de ligne

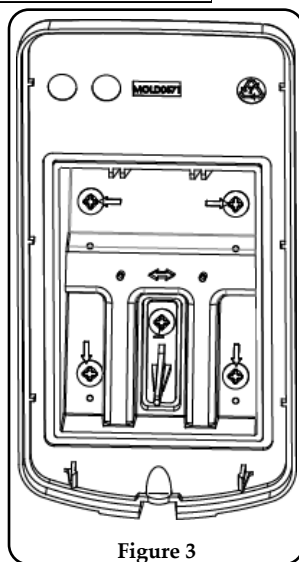
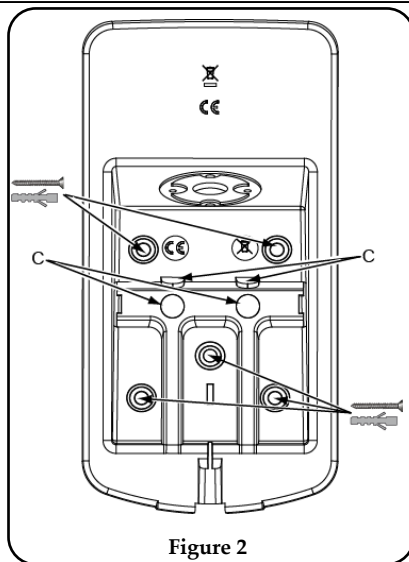
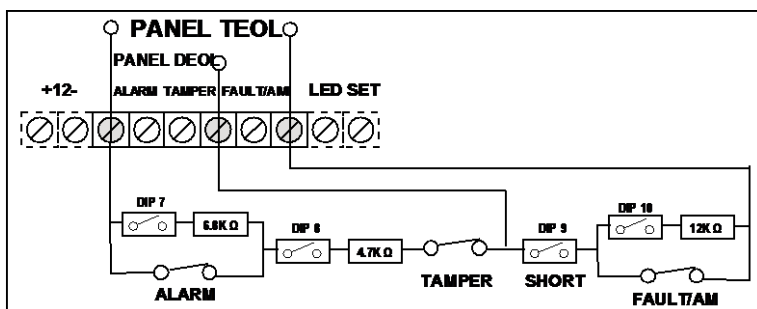



Figure 4



Figure 5

## Informations de commande

RK350DT0000A	Beyond DT, Détecteur Bande K
RA350S00000A	Support 180° pour détecteur Beyond DT

## Rapport de Conformité RED

Par la présente, RISCO Group, déclare que cet équipement est en conformité aux conditions essentielles et à d'autres dispositions appropriées de la directive 2014/53/EU.

Vous pouvez trouver la copie complète de la déclaration de conformité à la directive 2014/53/EU sur notre site web, à l'adresse suivante : [www.riscogroup.com](http://www.riscogroup.com).



## Descripción

El Beyond™ DT ha sido diseñado para ofrecer protección en exterior mejorada las 24 horas con funciones de antienmascaramiento IR activo. La tecnología dual integrada (DT) combina dos canales de microondas de banda K con dos sensores PIR para un mejor rendimiento de la detección e inmunidad anti mascotas, reduciendo así al mínimo las alarmas falsas. El Beyond™ DT también se puede instalar en el BUS de RISCO para ahorrar tiempo y dinero.

## Funciones

- Cobertura PIR: 12 m, 90°
- Banda K de dos canales - Detección MW (**Reconocimiento de oscilaciones**)
- Apto para mascotas (inmunidad ante mascotas)
- Dos sensores PIR correlacionados
- Sensor de luz para reducir las falsas alarmas por luz solar
- Antienmascaramiento IR activo
- Montaje a 2,2 m con rótula opcional
- Diseñado para instalación en exterior, resistente a rayos UV, IP 54
- Tamper de cubierta y de pared.
- Rótula opcional (Modelo: RA350S)

## Instalación

### Paso 1: Consideraciones previas

Seleccionar la ubicación de montaje que mejor cubra la zona que se va a proteger (consultar Patrones de cobertura). Respetar lo siguiente:

- Instalar el dispositivo a una altura de 2,2 m. Cualquier instalación a menor altura reducirá el rango de detección.
- Para la inmunidad ante a mascotas, la altura de un animal (sin limitación de peso) puede ser de hasta 50 cm cuando el dispositivo se instala a 2,2 m. Cualquier instalación a menor altura reducirá el rango de detección.
- Instalar el dispositivo en un lugar donde el campo de visión del detector no tenga ningún obstáculo estático.
- Montar el dispositivo de modo que el movimiento de personas corte el patrón del haz.
- No instalar el dispositivo cerca de objetos en movimiento.
- No instalar más de un detector DT en un radio de 1 m.

### Paso 2: Montar el detector en el soporte de pared

1. Aflojar el tornillo de fijación y separar el detector del soporte de montaje (ver Figura 1).
2. Abrir los 5 orificios troquelados del soporte de pared y usarlos como plantilla para el montaje (ver Figura 2).
3. Introducir el cableado externo por el canal del cable de la parte posterior del soporte de pared (ver Figura 2).
4. Fijar el soporte de montaje a la pared (ver Figura 3).

5. Conectar el bloque de terminales al detector (ver Figura 4).
6. Conectar el cableado del terminal (ver Paso 5a).
7. Configurar los interruptores DIP (ver Paso 5b).
8. Montar el detector en el soporte de pared (ver Figura 5).
9. Llevar a cabo un test de movimiento (ver el Paso 7).
10. Introducir y fijar el tornillo para bloquear el detector (ver Figura 5).

### Paso 3: Cobertura de PIR

Altura de montaje [m]	Ángulo de giro [°]	Distancia [m]
1,8	0	10
	5	7
	10	5
2,2 (óptima)	0	12
	5	8
	10	6
2,5	0	N/A
	5	10
	10	7
2,7	0	N/A
	5	10
	10	7

NA = Evitar esta instalación

### Paso 4: Ajuste del modo del detector

#### Modo cableado independiente

1. El interruptor DIP SW 6 está desactivado (OFF)
2. Cableado del terminal como en el Paso 5a

#### Modo BUS de RISCO

1. El interruptor DIP SW 6 está activado (ON)
2. Cableado:
  - a) Terminal + - - Detector 12 VDC, - GND
  - b) Conexión YEL/GRN - Detector BUS
  - c) Continuar con el Paso 6

### Paso 5a: Conexión del cableado del terminal (Modo independiente)

Conectar el cableado del terminal según el siguiente esquema:

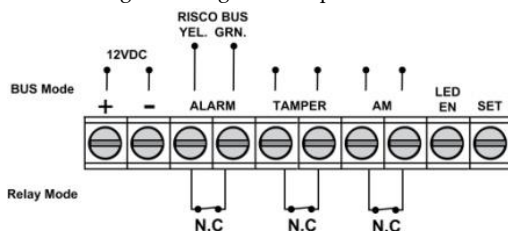

Terminal	Descripción		
+ -	+12 VCC, - GND		
ALARM YEL GRN	Relé de alarma N.C.	ALARM YEL GRN	
	<b>NOTA:</b> tal como lo define el interruptor DIP SW 6		
TAMPER +-	Interruptor del tamper N.C.		
AM +-	Relé de alarma antienmascaramiento N.C.		
LED ENABLE	Se utiliza para controlar de forma remota los LED cuando DIP1 está ajustado en ON <b>Activar:</b> la entrada es +12V o BIEN no hay conexión al terminal <b>Desactivar:</b> conectar la entrada a 0V Esta función evita que intrusos puedan conocer el estado del detector y desactivar la detección antienmascaramiento.		
SET/UNSET	Esta entrada permite controlar la operación de antienmascaramiento según el estado del sistema, Set (armado)/Unset (desarmado).		
	Estado del sistema	Entrada	Relé de antienmascaramiento
	Set (armado)	0V	Desactivado
	Unset (desarmado)	12V o sin conexión	Activado*
* El interruptor DIP SW 4 está ajustado en ON (antienmascaramiento activado)			

**NOTA:** Verificar que el puente J5 está habilitado para anular el tamper de giro.

## Paso 5b: Ajuste de los interruptores DIP (Modo independiente)

Ajustar los interruptores DIP según la siguiente tabla:

Interruptor DIP SW	Descripción				Predet.	Estado predet.			
1*	LED: ENC.: Activar/APAG.: Desactivar				ENC.	LED ENC.			
2*	Sensibilidad (PIR)	Baja	Med.	2*	Sensibilidad (PIR)	Baja APAG			
		APAG	APAG	ON			ON		
3*		APAG	ENC.	3*	ON	APAG	Med. APAG ENC.		
4*	Antienmascaramiento: ENC.: Activar/APAG.: Desactivar				ENC.	Activar			
5*	Alta sensibilidad (antienmascaramiento): ENC.: Alta/APAG.: Baja				APAG.	Baja			
6	Modo: ENC.: BUS/APAG.: Relé (ver Definición del ID del BUS)				APAG.	Relé			
Modo de relé		DIP SW 7		DIP SW 8		DIP SW 9		DIP SW 10	
Normal		OFF		OFF		OFF		OFF	
DEOL		ON		ON		OFF		OFF	
TEOL		ON		ON		ON		ON	

### NOTAS:

1. Los interruptores DIP DEOL 7 y 8 deben estar ajustados en ON.
2. Los interruptores DIP DEOL 7-10 deben estar ajustados en ON.



Ajustar la zona de cobertura de microondas con el recortador de la placa base.

## Paso 6a: Definición del ID del BUS (Modo BUS)

Utilizar los interruptores DIP 1 al 5 para definir el ID del BUS de cada detector. Definir los ajustes del ID del BUS según la siguiente tabla:

Ajustar el interruptor DIP 6 según los siguientes datos:

6	Modo: ENC.: BUS/APAG.: Relé (ver Definición del ID del BUS)	ON	BUS
---	---	----	-----

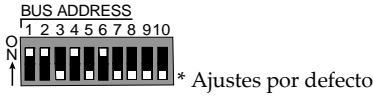

ID	1	2	3	4	5
01	OFF	OFF	OFF	OFF	OFF
02	ON	OFF	OFF	OFF	OFF
03	OFF	ON	OFF	OFF	OFF
04	ON	ON	OFF	OFF	OFF
05	OFF	OFF	ON	OFF	OFF
06	ON	OFF	ON	OFF	OFF
07	OFF	ON	ON	OFF	OFF
08	ON	ON	ON	OFF	OFF
09	OFF	OFF	OFF	ON	OFF
10	ON	OFF	OFF	ON	OFF
11	OFF	ON	OFF	ON	OFF
12	ON	ON	OFF	ON	OFF
13	OFF	OFF	ON	ON	OFF
14	ON	OFF	ON	ON	OFF
15	OFF	ON	ON	ON	OFF
16	ON	ON	ON	ON	OFF
17	OFF	OFF	OFF	OFF	ON
18	ON	OFF	OFF	OFF	ON
19	OFF	ON	OFF	OFF	ON
20	ON	ON	OFF	OFF	ON
21	OFF	OFF	ON	OFF	ON
22	ON	OFF	ON	OFF	ON
23	OFF	ON	ON	OFF	ON
24	ON	ON	ON	OFF	ON
25	OFF	OFF	OFF	ON	ON
26	ON	OFF	OFF	ON	ON
27	OFF	ON	OFF	ON	ON
28	ON	ON	OFF	ON	ON
29	OFF	OFF	ON	ON	ON
30	ON	OFF	ON	ON	ON
31	OFF	ON	ON	ON	ON
32	ON	ON	ON	ON	ON

NOTA: Este paso solo es relevante para detectores conectados al BUS de RISCO.

## Paso 6b: Definición de los ajustes del sistema (Modo BUS)

### LightSYS/ProSYS Plus – Añadir el detector en BUS

1. Seleccionar el menú del instalador: [7] Instalar > [1] Dispositivos BUS > [1] Automático. El sistema buscará automáticamente el ID del BUS de los detectores y asignará una zona (en función de los ajustes del interruptor DIP realizados).
2. Vaya a la zona definida con tipo ODT50 y pulse OK para confirmar.

### Configurar los parámetros del detector en BUS:

Seleccionar el menú del instalador: [2] Zonas > [1] Parámetros > [2] Por Categoría > [7] Parám. Avanz. [4] Parám. Z.BUS (consultar el Manual de instalación de LightSYS/ProSYS Plus).

NOTA: Para LightSYS 5.20 y versión posterior.

## Paso 7: Llevar a cabo un test de movimiento

La tapa del detector debe estar cerrada durante el test de movimiento. Encender la unidad y esperar al menos dos minutos a que el detector se estabilice. Con la detección, el detector transmite una señal y los LED se encienden. Camine por toda la zona protegida y observe los LED para confirmar la cobertura total (ver Estado de los LED).

### Iniciar manualmente un test de movimiento:

Seleccionar el menú del usuario: Mantenimiento > Test Movimiento > Seleccionar Test Movimiento completo o Test Movimiento rápido. El detector permanece en modo de test de movimiento mientras no se pulse ningún botón del panel.

## Estado de los LED:

LED	Estado	Descripción
AMARILLO	Parpadeo ENC.	Indica el inicio del análisis de detección PIR
	Fijo ENC.	Indica detección PIR
	Parpadeo	Indica detección de antiensucamiento IR activo
VERDE	Fijo ENC.	Indica detección MW
ROJO	Fijo ENC.	Indica ALARMA
	Parpadeo	Indica un fallo en la comunicación con el sistema de RISCO (solo Modo BUS)
Todos los LED	Parpadeo (secuencial)	La unidad se está inicializando durante el encendido

**NOTA:** El interruptor DIP-SW 1 debe estar ajustado en ON para permitir las indicaciones de los LED.

## Autotest

Cada hora, el detector lleva a cabo un autotest interno de los canales PIR y MW. Un fallo detectado en el autotest se reflejará como un relé de antiensucamiento momentáneamente abierto (en modo de relé) o como un mensaje en el panel (en modo BUS).

## Especificaciones

Datos eléctricos	
Consumo de corriente:	30 mA a 12 VCC (reposo) 42 mA a 12 VCC (MÁX con LED encendidos)
Salida de alimentación	16dBm
Requisitos de voltaje	9 -16 VCC
Contactos de alarma	24 VCC, 0,1 A
Contactos de antiensucamiento	24 VCC, 0,1 A
Contactos del tamper	24 VCC, 0,1 A
Datos físicos	
Tamaño (ALxANxPR):	170 x 90 x 90 mm
Peso:	0,532 kg
Datos medioambientales	
Inmunidad RF:	Según la norma EN50130-4
Temperatura de funcionamiento:	De -30 °C a 60 °C (90 % de humedad)
Temperatura de almacenamiento:	De -30 °C a 70 °C (90 % de humedad)

## Consideraciones previas

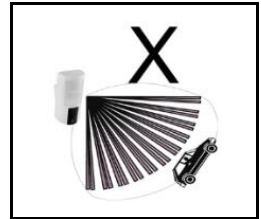
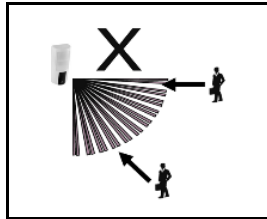
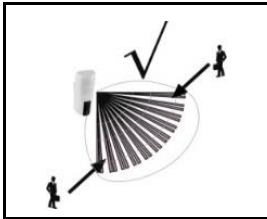
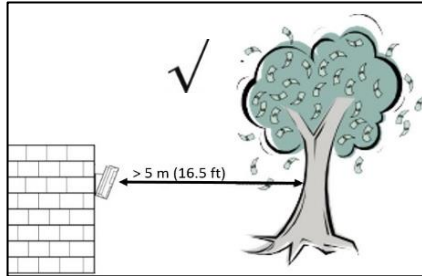
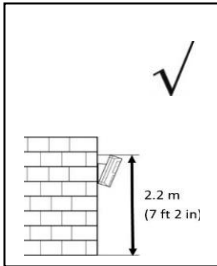

NOTA: Evitar la instalación frente a vehículos en movimiento/carreteras a una distancia de hasta 30 m.

Patrón de cobertura PIR: 12 m, 90°

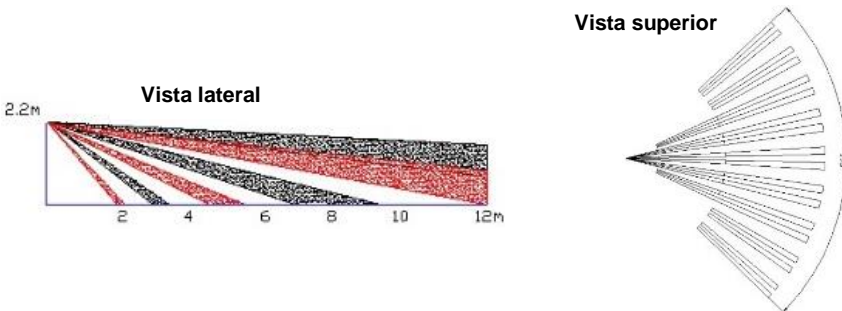

## Resistencia de terminación





Figura 1



Figura 2

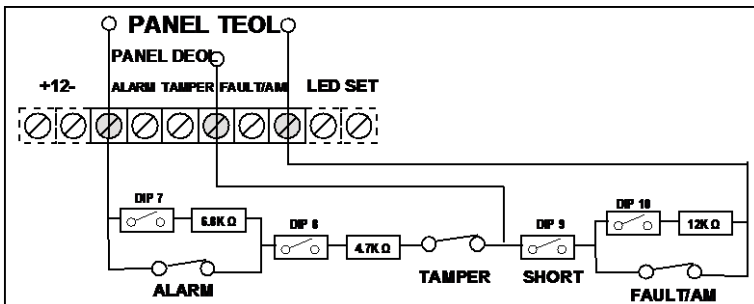

Figura 3

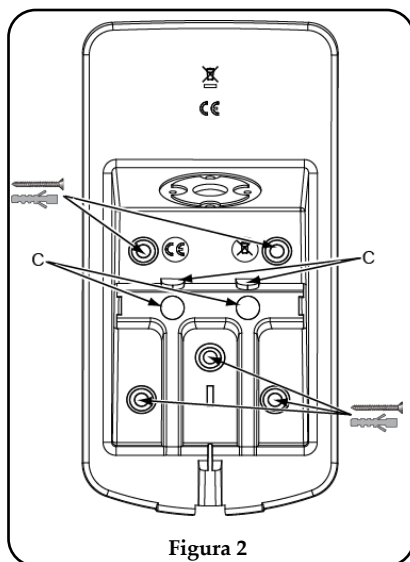

Figura 4

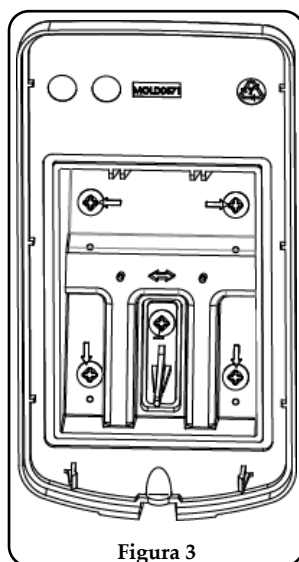

Figura 5

### Información para pedidos

RK350DT0000A	Detector de banda K Beyond DT
RA350S00000A	Rótula 180° para Beyond DT

### Declaración de Conformidad RED :

Por la presente, RISCO Group declara que este equipo cumple con los requisitos esenciales y otras disposiciones relevantes de la Directiva 2014/53/EU. Para la Declaración de Conformidad CE, por favor diríjase a nuestra web: [www.riscogroup.com](http://www.riscogroup.com)

## Descrizione

Beyond™ DT è stato progettato per offrire una maggiore protezione in esterno in abbinamento ai sistemi antintrusione. Beyond™ DT è protetto dai tentativi di sabotaggio tramite un sistema di Anti-Mascheramento ad infrarossi attivo. La doppia tecnologia integrata (DT) unisce due canali a microonde in banda K con due sensori PIR per una migliore rilevazione degli intrusi e l'immunità agli animali, riducendo al minimo i falsi allarmi.

Beyond™ DT può anche essere installato direttamente sul BUS RISCO per un maggior controllo ed un cablaggio più semplice e veloce.

### Le caratteristiche includono:

- Copertura PIR: 12m, 90°
- Due canali MW in banda K con tecnologia SRT (Riconoscimento degli oggetti che oscillano)
- Due sensori PIR correlati
- Sensore luce per la riduzione dei falsi allarmi a causati dalla luce solare.
- Anti-Mascheramento ad IR attivo
- Installazione a 2.2 metri di altezza con uno snodo opzionale
- Progettato per installazioni in esterno, resistente UV, IP 54
- Tamper anti-apertura e anti-rimozione
- Snodo opzionale (RA350S)

## Installazione

### Passo 1: Considerazioni preliminari

Scegliere la posizione migliore in riferimento all'area da proteggere (vedi Diagrammi di Copertura). Fare attenzione a quanto segue:

- Installare l'unità ad una altezza di 2.2 metri. Una installazione più bassa ridurrà progressivamente l'area di copertura
- L'immunità animali (senza limitazione di peso) è garantita fino a 50 cm con il rivelatore installato a 2.2 metri. Installazioni più basse riducono la massima altezza per l'immunità dell'animale
- Installare il dispositivo in una posizione dove non ci sono ostacoli che possano ostruirne il campo di azione.
- Installare l'unità in modo che gli eventuali intrusi siano obbligati ad attraversarne l'area di copertura.
- Non installare il dispositivo troppo vicino ad oggetti in movimento.
- Non installare più di un rivelatore DT entro un raggio di un metro.

### Passo 2: Installazione del rivelatore

1. Svitare la vite di fissaggio e rimuovere il rivelatore dalla sua staffa. (vedi Figura 1).
2. Aprire i 5 fori a sfondare della staffa di fissaggio ed usarla come dima per il montaggio (vedi Figura 2).
3. Inserire il cavo esterno dal retro della staffa di montaggio (vedi Figura 2)



4. Fissare la staffa alla parete (vedi Figura 3)
5. Connettere la morsettiera al rivelatore (vedi Figura 4)
6. Cablare la morsettiera (vedi Passo 5a).
7. Impostare i microinterruttori (vedi Passo 5b).
8. Rimontare il rivelatore sulla staffa di fissaggio (vedi Figura 5).
9. Effettuare la prova di movimento (vedi Passo 7).
10. Inserire e serrare la vite di chiusura del rivelatore (vedi Figura 5).

### Passo 3: Area di copertura PIR

Altezza di Installazione in metri	Angolo di inclinazione in gradi	Distanza in metri
1.8	0	10
	5	7
	10	5
2.2 (ottimale)	0	12
	5	8
	10	6
2.5	0	N/A
	5	10
	10	7
2.7	0	N/A
	5	10
	10	7

NA = Evitare questa installazione

### Passo 4: Impostare la modalità di funzionamento del rivelatore

#### Modalità a Relè

1. Impostare il microinterruttore 6 su OFF
2. Cablare la morsettiera come illustrato al Passo 5a

#### Modalità BUS RISCO

1. Impostare il microinterruttore 6 su ON
2. Cablaggio:
  - a) morsetti + -: Aliment. sensore 12 Vcc, - GND
  - b) Morsetti YEL / GRN: BUS rivelatore
  - c) Proseguire con il Passo 6

## Passo 5a: Cablaggio Morsettiera

Cablare la morsettiera come segue:

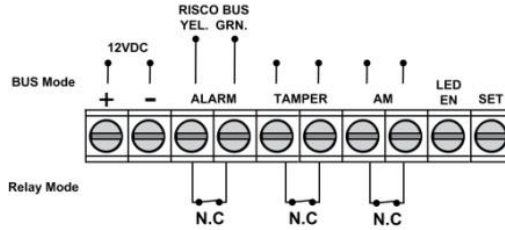

Morsetto	Descrizione	
+ -	+12 Vcc, - GND	
ALARM YEL GRN	Relè di allarme N.C.	YEL / GRN (BUS RISCO)
	NOTA: impostazione definita dal MIC. 6	
TAMPER +-	Relè tamper N.C	
AM +-	Relè Anti-Mascheramento N.C	
LED ENABLE	Usato per controllare remotamente il LED quando il MIC. 1 è impostato su ON <u>Abilitato</u> : portare una tensione +12V oppure nessuna connessione al morsetto <u>Disabilitato</u> : Connettere una tensione di riferimento 0V A sistema inserito questa funzione disabilita i LED (evitando che un intruso possa verificare che il sistema ha generato un allarme) e l'antimascheramento.	
SET / UNSET	Questo ingresso permette di controllare il funzionamento dell'Anti-Mascheramento e del LED in riferimento allo stato del sistema, Inserito/Disinserito.	
	Stato sistema	Stato ingresso
	Inserito	0V
	Disinserito	12V o nessuna connessione
		Relè AM
		Disabilitato
		Abilitato*
	* MIC. 4 = ON (Anti-Mascheramento abilitato)	

NOTA: per escludere il tamper dello snodo accertarsi che il ponticello J5 sia inserito.

## Passo 5b: Impostazione Microint. (Modalità a Relè)

Impostare i microinterruttori come da tabella seguente:

MIC	Descrizione				Dflt.	Stato
1*	LED: ON = Abilitati / OFF = Disabilitati				ON	LED ON
2*	Sensibilità	Bassa	Media	Norm.	Max	ON
		OFF	OFF	ON	ON	
3*		OFF	ON	OFF	ON	OFF
						Normale

4*	Anti-Mascheramento: ON=Abilitato / OFF=Disabilitato	ON	Abilitato		
5*	Sensibilità Anti-Mascheramento Livello sensibilità: ON=Alto / OFF=Basso	OFF	Basso		
6	Modo: ON=BUS / OFF=Relè (vedi Impostazione ID BUS)	OFF	Relè		
<b>Solo Modalità Relè</b>		<b>MIC 7</b>	<b>MIC 8</b>	<b>MIC 9</b>	<b>MIC 10</b>
Normale		OFF	OFF	OFF	OFF
DEOL		ON	ON	OFF	OFF
TEOL		ON	ON	ON	ON

**NOTE:**

1. I microinterruttori da 1-5\* sono usati per impostare l'ID dell'unità nel modo BUS (vedi Impostazione ID BUS).
2. Per DEOL, i mic. 7 e 8 vanno impostati su ON.
3. Per TEOL, i mic. 7-10 vanno impostati su ON.



Regolare la copertura della microonda usando il potenziometro situato sulla scheda elettronica.

## Passo 6a: Impostazione ID BUS (Modalità BUS)

Usare i microinterruttori da 1 a 5 per impostare l'ID sul BUS del rivelatore come da tabella seguente.

6	Il default è ID=9. Impostare il microinterruttore 6 in ON per la modalità BUS.	ON	BUS
---	--	----	-----



\* Impostazione di default

ID	1	2	3	4	5
01	OFF	OFF	OFF	OFF	OFF
02	ON	OFF	OFF	OFF	OFF
03	OFF	ON	OFF	OFF	OFF
04	ON	ON	OFF	OFF	OFF
05	OFF	OFF	ON	OFF	OFF
06	ON	OFF	ON	OFF	OFF
07	OFF	ON	ON	OFF	OFF
08	ON	ON	ON	OFF	OFF
09	OFF	OFF	OFF	ON	OFF
10	ON	OFF	OFF	ON	OFF
11	OFF	ON	OFF	ON	OFF
12	ON	ON	OFF	ON	OFF

ID	1	2	3	4	5
17	OFF	OFF	OFF	OFF	ON
18	ON	OFF	OFF	OFF	ON
19	OFF	ON	OFF	OFF	ON
20	ON	ON	OFF	OFF	ON
21	OFF	OFF	ON	OFF	ON
22	ON	OFF	ON	OFF	ON
23	OFF	ON	ON	OFF	ON
24	ON	ON	ON	OFF	ON
25	OFF	OFF	OFF	ON	ON
26	ON	OFF	OFF	ON	ON
27	OFF	ON	OFF	ON	ON
28	ON	ON	OFF	ON	ON

13	OFF	OFF	ON	ON	OFF	29	OFF	OFF	ON	ON	ON
14	ON	OFF	ON	ON	OFF	30	ON	OFF	ON	ON	ON
15	OFF	ON	ON	ON	OFF	31	OFF	ON	ON	ON	ON
16	ON	ON	ON	ON	OFF	32	ON	ON	ON	ON	ON

NOTA: Questa fase è necessaria solo per i rivelatori che si vogliono connettere al BUS RISCO.

## Passo 6b: Impostazioni alla centrale RISCO (Modalità BUS)

### LightSYS/ProSYS Plus – Aggiungere un rivelatore BUS

1. In Prog. Tecnica selezionare [7] Configuraz.ne > [1] Accessori BUS > [2] Config. Manuale > [9] Zone BUS.
2. Selezionare il numero ID/ZONA (come impostato tramite i primi 5 microint.) e scegliere come tipo rivelatore l' ODT50.

### Assegnazione del rivelatore BUS ad una zona

Con Lightsys il numero ID del rivelatore è automaticamente anche il numero della zona. Con Prosys Plus al momento dell'aggiunta del rivelatore BUS viene scelto il numero di zona e l'ID del rivelatore BUS ad essa associato.

Configurare i parametri del rivelatore su BUS.

In Prog. Tecnica selezionare [2] Zone > [1] Per Parametro > [7] Avanzati > [4] Zone BUS (vedi Manuale Tecnico LightSYS / ProSYS Plus).

NOTA: Le versioni LightSyS compatibili con Beyond iniziano dalla 5.20.

## Passo 7: Prova di movimento

Il rivelatore deve essere chiuso durante la prova di movimento (Test sensori). Alimentare il rivelatore e attendere almeno 2 minuti affinché lo stesso si stabilizza. Ad ogni rilevazione il rivelatore attiverà la sua uscita a relè e farà illuminare i LED. Attraversare l'area protetta e osservare l'accensione dei LED a conferma della corretta copertura del rivelatore (vedi stato dei LED).

Per iniziare la procedura di Test Sensori fare riferimento al manuale della centrale che si sta utilizzando.

## Stato dei LED

LED	Stato	Descrizione
GIALLO VERDE	Fisso acceso	Indica rilevazione sui canali PIR
	Lampeggiante	Indica che l'IR di Anti-Mask si è attivato
	Fisso acceso	Indica rilevazione sui canali MW
ROSSO	Fisso acceso ON	Indica ALLARME
TUTTI I LED	Lampeggiante	Indica una anomalia di comunicazione con il sistema BUS RISCO (solo Modalità BUS)
	Lampeggiante (In sequenza)	Inizializzazione unità all'alimentazione

NOTA: Il MIC. 1 deve essere su ON per abilitare le segnalazioni LED.

## Auto-Test

Ogni ora il rivelatore effettua un auto-test interno per tutti i canali di rilevazione, sia PIR che MW. Una condizione di guasto durante l'auto-test verrà indicata con l'attivazione impulsiva dell'uscita Fault/AM (modalità relè) o tramite un messaggio specifico dell'anomalia registrato nel menù guasti della centrale (modalità BUS).

## Specifiche tecniche

Elettriche	
Assorbimento in corrente	30mA a 12 VDC (a riposo) 42mA a 12 VDC (max. con LED accesi)
Uscite di Alimentazione	16dBm
Tensione richiesta	9 -16 VDC
Contatti di allarme	24 VDC, 0.1A
Contatti AM/Anomalia	24 VDC, 0.1A
Contatti tamper	24 VDC, 0.1A
Fisiche	
Dimensioni (H x L x P):	170x90x90mm
Peso:	0.532 Kg
Ambientali	
Immunità RF:	Conforme alla EN50130-4
Temp. di funzionamento:	Da -30°C a 60°C (umidità 90%)
Temp. di stoccaggio:	Da -30°C a 70°C (umidità 90%)

## Considerazioni preliminari

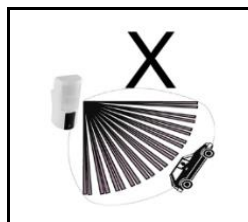
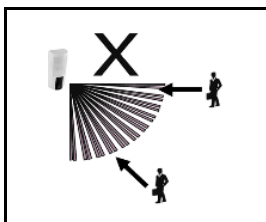
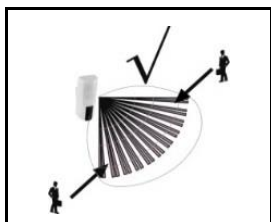
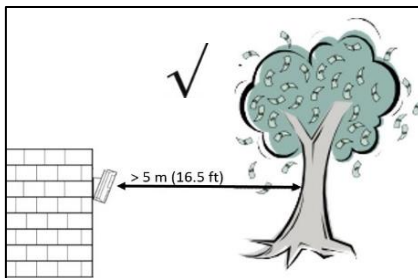
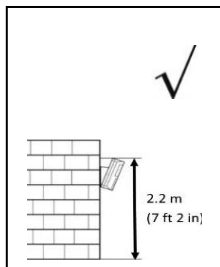

**NOTA: OTA:** Evitare l'installazione di fronte a strade con passaggio di veicoli fino a 30 metri di distanza.

PIR Coverage Pattern: 12m, 90°

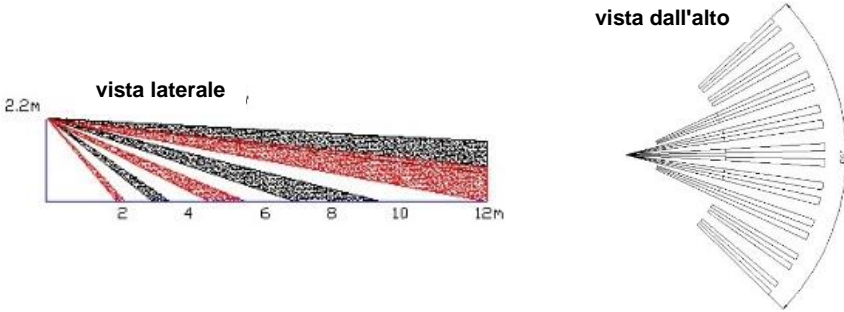

## Termination Resistance

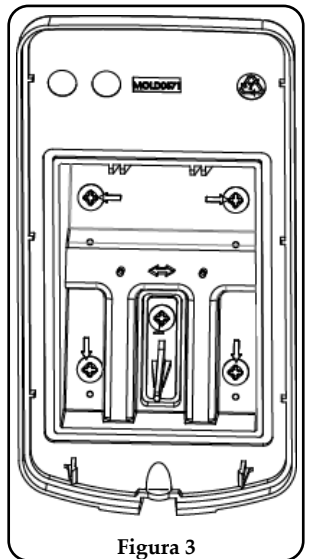
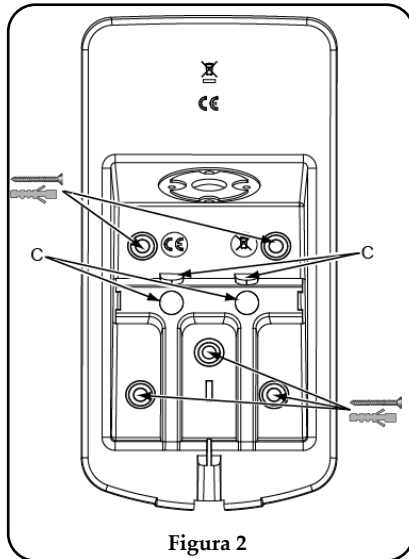
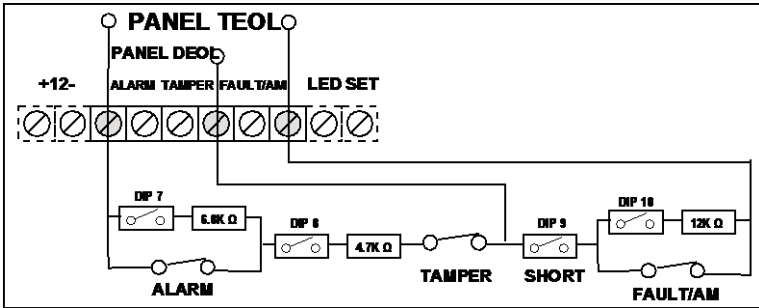



**Figura 4**



**Figura 5**

**Informazioni sull'ordine**

RK350DT0000A	Beyond DT, K Band Detector
RA350S00000A	180° Swivel for Beyond DT

**Dichiarazione di Conformità RED:**

La sottoscritta RISCO Group, dichiara sotto la propria responsabilità che questo prodotto è conforme ai requisiti essenziali e alle altre rilevanti disposizioni della Direttiva Europea 2014/53/EU. Per le Dichiarazioni di Conformità CE, visitate il nostro sito web: [www.riscogroup.com](http://www.riscogroup.com)



## Descrição

O Beyond™ DT foi projetado para fornecer uma proteção externa aprimorada 24 horas, com recursos de antimascaramento por infravermelho ativo. A tecnologia dual (DT) integrada combina dois canais de micro-ondas de banda K com dois sensores PIR para um melhor desempenho de captura e imunidade a animais, minimizando alarmes falsos. O Beyond™ DT também pode ser instalado no RISCO Bus, economizando tempo e dinheiro.

## Características

- Cobertura PIR: 12 m, 90°
- Dois canais de banda K - Detecção por micro-ondas (reconhecimento de oscilação)
- Conciliável com animais (imunidade a animais domésticos)
- Dois sensores PIR correlacionados
- Sensor de luz para reduzir alarmes falsos devido à luz solar
- Antimascaramento por infravermelho ativo
- Montagem a 2,2 m com suporte giratório opcional
- Projetado para instalação externa, resistente a raios UV, IP 54
- Protetores antivolação de tampa e parede.
- Suporte giratório opcional (modelo: RA350S)

## Instalação

### Passo 1: Considerações Iniciais

Selecione o local de montagem para obter a melhor cobertura da área a ser protegida (ver Padrões de Cobertura). Observe as recomendações a seguir:

- Instale o dispositivo na altura de 2,2 m (7 pés e 2 pol.). A instalação em altura inferior reduzirá o alcance da detecção.
- Para a imunidade a animais, a altura do animal (sem limite de peso) pode ser de até 50 cm (1 pé e 6 pol.) com o dispositivo instalado a 2,2 m (7 pés e 2 pol.). A instalação em altura inferior reduzirá o alcance da detecção.
- Instale o dispositivo em um local onde o campo de visão do detector não tenha obstruções estáticas.
- Monte o dispositivo de forma que o tráfego a pé cruze o feixe de varredura.
- Não instale o dispositivo perto de objetos em movimento.
- Não instale mais de um detector DT dentro de um raio de 1 m.

### Passo 2: Montagem do Detector no Suporte de Parede

1. Solte o parafuso de fixação e remova o detector do suporte de montagem (ver Figura 1).
2. Abra os 5 furos do suporte de parede e use-os como modelo para montagem (ver Figura 2).
3. Passe a fiação externa através do canal do cabo na parte traseira do suporte de parede (ver Figura 2).
4. Fixe o suporte à parede (ver Figura 3).



5. Conecte o bloco de terminais ao detector (ver Figura 4).
6. Conecte a fiação do terminal (ver Passo 5a).
7. Defina as configurações das chaves DIP (ver Passo 5b).
8. Monte o detector no suporte de parede (ver Figura 5).
9. Faça um teste de caminhada (ver Passo 7).
10. Insira e aperte o parafuso para travar o detector (ver Figura 5).

### Passo 3: Cobertura PIR

Altura da montagem [m]	Ângulo do Suporte Giratório [°]	Distância [m]
1,8	0	10
	5	7
	10	5
2,2 (ideal)	0	12
	5	8
	10	6
2,5	0	–
	5	10
	10	7
2,7	0	–
	5	10
	10	7

NA = Evite tal instalação

### Passo 4: Configuração do Modo do Detector

#### Modo Autônomo

1. Chave DIP 6 desligada
2. Fiação do terminal como no Passo 5a

#### Modo RISCO BUS

1. Chave DIP 6 ligada
2. Fiação:
  - a) Terminal + - - Detector 12 V CC, - GND
  - b) Conexão AMAR/VERD – Detector BUS
  - c) Continua no Passo 6

### Passo 5a: Conexão da Fiação do Terminal (Modo Autônomo)

Conecte a fiação do terminal de acordo com as informações a seguir:

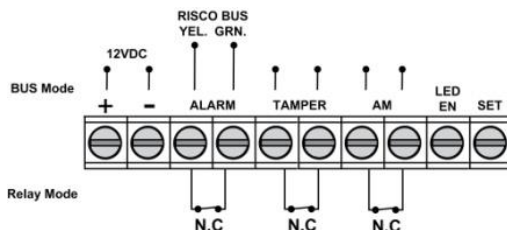

Terminal	Descrição		
+ -	+12 V CC, - GND		
ALARME AMAR VERD	Relé do alarme N.F.	ALARME AMAR VERD	
	NOTA: Como definido pela chave DIP 6		
VIOLAÇÃO +-	Chave de violação N.F.		
AM +-	Relé do alarme de antimascaramento N.F.		
HABILITAR LED	Usado para controlar remotamente os LEDs quando a DIP 1 estiver definida como LIG <b>Habilitar:</b> a entrada é de +12 V OU sem conexão no terminal <b>Desabilitar:</b> conecte a entrada em 0 V Esse recurso evita que um intruso fique sabendo do status do detector e desative a detecção de antimascaramento.		
ATIVAR/DESATIVAR	Essa entrada permite controlar a operação de antimascaramento de acordo com o status do sistema, Ativar (armar)/Desativar (desarmar).		
	Status do sistema	Status da entrada	Relé de AM
	Ativar (armar)	0 V	Desligado
	Desativar (desarmar)	12 V ou sem conexão	Ligado*
* Chave DIP 4 ligada (antimascaramento habilitado)			

NOTA: Assegure que o jumper J5 esteja instalado para ignorar a violação do suporte giratório

## Passo 5b: Definição das Configurações das Chaves DIP (Modo Autônomo)

Defina as configurações das chaves DIP de acordo com a tabela abaixo:

CH DIP	Descrição				Def.	Status def.	
1*	LEDs: LIG: Habilitar/DESL: Desabilitar				ON	LEDs LIG	
2*	Sensibilidade (PIR)	Baix.	Méd.	2*	Sensibilidade (PIR)	Baix. OFF ON	
		OFF	OFF	ON			ON
3*		OFF	ON	3*	ON	OFF	
4*	Antimascaramento: LIG: Habilitar/DESL: Desabilitar				ON	Habilitar	
5*	Alta sensibilidade (Antimasc.): LIG: Alta/DESL: Baixa				OFF	Baix.	
6	Modo: LIG: BUS/DESL: Relé (ver Definição do ID do BUS)				OFF	Relé	
Modo relé		CH DIP 7		CH DIP 8		CH DIP 9	
Normal		OFF		OFF		OFF	
DEOL		ON		ON		OFF	
TEOL		ON		ON		ON	

### NOTAS:

1. Para DEOL, as chaves DIP 7 e 8 devem estar ligadas.
2. Para TEOL, as chaves DIP de 7 a 10 devem estar ligadas.



Ajuste a área de cobertura de micro-ondas usando o aparador na PCB.

## Passo 6a: Definição do ID do BUS (Modo BUS)

Use as chaves DIP de 1 a 5 para definir o ID do BUS de cada detector. Defina as configurações do ID do BUS de acordo com a tabela abaixo.

Defina a configuração da chave DIP 6 de acordo com os seguintes dados:

6	Modo: LIG: BUS/DESL: Relé (ver Definição do ID do BUS)	LIG	BUS
---	--	-----	-----

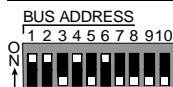

\* Configuração padrão

ID	1	2	3	4	5
01	OFF	OFF	OFF	OFF	OFF
02	ON	OFF	OFF	OFF	OFF
03	OFF	ON	OFF	OFF	OFF
04	ON	ON	OFF	OFF	OFF
05	OFF	OFF	ON	OFF	OFF
06	ON	OFF	ON	OFF	OFF
07	OFF	ON	ON	OFF	OFF
08	ON	ON	ON	OFF	OFF
09	OFF	OFF	OFF	ON	OFF
10	ON	OFF	OFF	ON	OFF
11	OFF	ON	OFF	ON	OFF
12	ON	ON	OFF	ON	OFF
13	OFF	OFF	ON	ON	OFF
14	ON	OFF	ON	ON	OFF
15	OFF	ON	ON	ON	OFF
16	ON	ON	ON	ON	OFF
17	OFF	OFF	OFF	OFF	ON
18	ON	OFF	OFF	OFF	ON
19	OFF	ON	OFF	OFF	ON
20	ON	ON	OFF	OFF	ON
21	OFF	OFF	ON	OFF	ON
22	ON	OFF	ON	OFF	ON
23	OFF	ON	ON	OFF	ON
24	ON	ON	ON	OFF	ON
25	OFF	OFF	OFF	ON	ON
26	ON	OFF	OFF	ON	ON
27	OFF	ON	OFF	ON	ON
28	ON	ON	OFF	ON	ON
29	OFF	OFF	ON	ON	ON
30	ON	OFF	ON	ON	ON
31	OFF	ON	ON	ON	ON
32	ON	ON	ON	ON	ON

NOTA: Esse passo é relevante apenas para detectores conectados ao RISCO BUS.

## Passo 6b: Definição das Configurações do Sistema (Modo BUS)

### LightSYS/ProSYS Plus – Adicionar o detector BUS

1. Selecione Menu de Instalação: [7] Instalar > [1] Dispositivo BUS > [1] Automático. O sistema busca automaticamente o ID do BUS dos detectores e atribui uma zona (de acordo com as configurações definidas das chaves DIP).
2. Avance até a zona definida com o tipo ODT50 e clique em OK para confirmar.

### Configure os parâmetros do detector BUS:

Selecione Menu de Instalação: [2] Zonas > [1] Parâmetros > [2] Por categoria > [7] Avançado [4] Parâmetros de zona BUS (ver o Manual de Instalação do LightSYS/ProSYS Plus).

NOTA: Para LightSYS Versão 5.20 e superior.

## Passo 7: Executar Teste de Caminhada

A tampa do detector deve ser fechada durante o teste de caminhada. Ligue a energia e aguarde pelo menos dois minutos para que o detector se estabilize. Após a detecção, o detector transmite um sinal e os LEDs acendem. Caminhe por toda a área protegida e observe os LEDs para confirmar a cobertura total (ver status do LED).

### Inicie manualmente um teste de caminhada:

Selecione Menu do Usuário: Manutenção > Teste de Caminhada > Selecione Teste de Caminhada Completo ou Teste de Caminhada Rápido. O detector permanece no modo de teste de caminhada até que alguma tecla no painel seja pressionada.

## Status do LED

LED	Status	Descrição
AMARELO	Piscando LIG	Indica o início da análise de detecção PIR
	Constante LIG	Indica detecção PIR
	Piscando rápido	Indica detecção de AM (antimascaramento) por infravermelho ativo.
VERDE	Constante LIG	Indica detecção de micro-ondas
VERMELHO	Constante LIG	Indica ALARME
	Piscando rápido	Indica problema na comunicação com o sistema RISCO (apenas em modo BUS)
Todos os LEDs	Piscando rápido (um após o outro)	Inicialização da unidade após ligar energia

NOTA: A chave DIP 1 deve estar na posição LIG para habilitar as indicações de LED.

## Autoteste

A cada hora, o detector realiza um autoteste interno para os canais de PIR e micro-ondas. Uma falha detectada no autoteste será indicada por um relé de antimascaramento aberto momentaneamente (no modo relé) ou por uma mensagem correspondente no painel (no modo BUS).

## Especificações

Elétricas	
Consumo de corrente:	30 mA em 12 V CC (standby) 42 mA em 12 V CC (máx. com LED )
Saída de energia	16dBm
Requisitos de voltagem	9-16 V CC
Contatos do alarme	24 V CC, 0,1 A
Contatos de AM	24 V CC, 0,1 A
Contatos de violação	24 V CC, 0,1 A
Físicas	
Tamanho (C x L x P):	170 x 90 x 90 mm
Peso:	0,532 Kg
Ambientais	
Imunidade a RF:	Em conformidade com a EN50130-4
Temperatura de funcionamento:	-30 °C a 60 °C (umidade de 90%)
Temperatura de armazenamento:	-30 °C a 70 °C (umidade de 90%)

## Considerações Iniciais

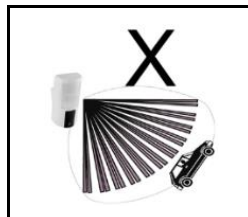
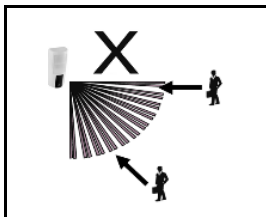
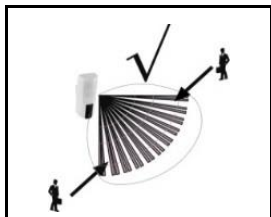
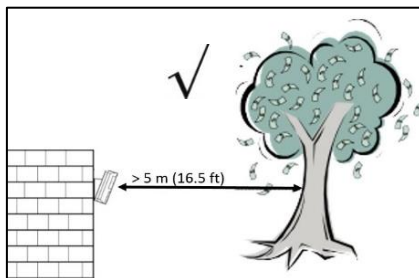
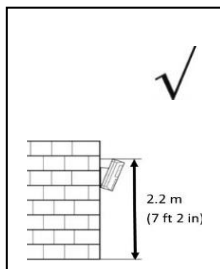

NOTA: Evite a instalação voltada para carros/estrada a uma distância de até 30 m.

Padrão de Cobertura do PIR: 12 m, 90°

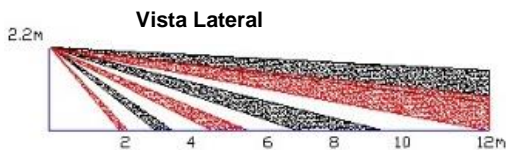

**Vista Do Topo**

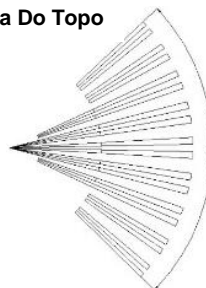

## Termination Resistance

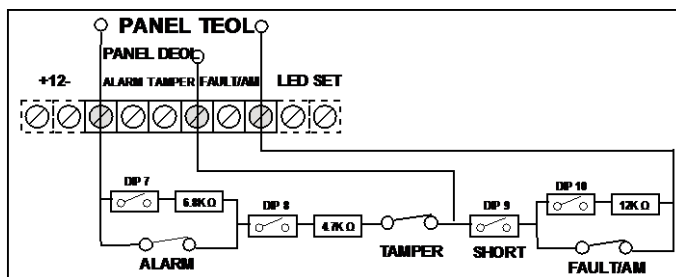



Figure 1

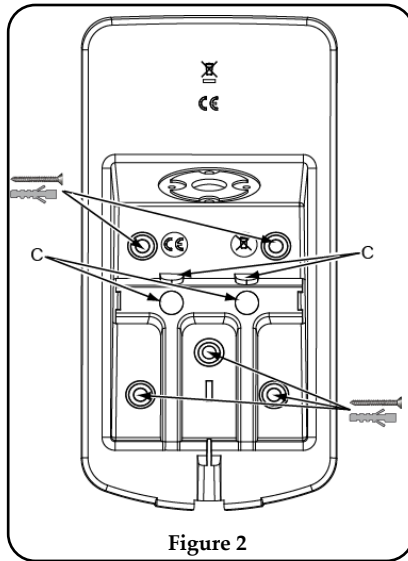

Figure 2

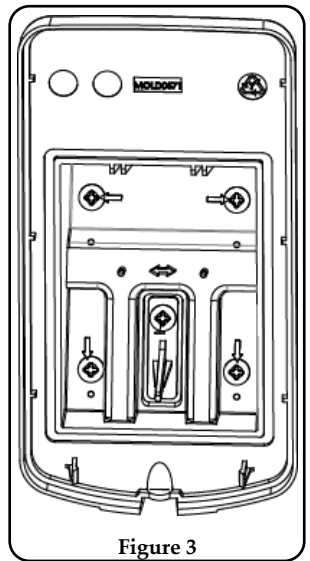

Figure 3



Figure 4



Figure 5

### Informações sobre pedidos

RK350DT0000A	Beyond DT, Detector de Banda K
RA350S00000A	Suporte Giratório 180° para Beyond DT

### Declaração de conformidade RED:

Por meio deste, a RISCO Group declara que seu equipamento está em conformidade com as necessidades essenciais e outras provisões relevantes da diretiva 2014/53/EU. 1 Para ver a declaração de conformidade da CE, por favor consulte a nossa website: [www.riscogroup.com](http://www.riscogroup.com)

## Beschrijving

De Beyond™ DT is ontwikkeld om een verhoogde 24-uurs buiten beveiliging te creëren, door gebruik te maken van actieve IR Anti-masking technologie. De geïntegreerde Dual Technologie (DT) combineert twee K-band microwave kanalen met twee PIR sensoren voor een betere detectie performantie en pet immuniteit, waardoor valse alarmen gerudeceerd worden. De Beyond™ DT kan ook aangesloten worden via de RISCO Bus, welke u tijd en geld bespaart.

## Kenmerken

- PIR bereik: 12m, 90°
- Twee kanaals K band - MW detectie (Sway herkenningstechnologie)
- Diervriendelijk (pet immuniteit)
- Twee gecorreleerde PIR Sensoren
- Licht sensor voor het reduceren van valse alarmen door invallend zonlicht
- Actieve IR Anti-mask
- Installatiehoogte op 2,2m met optionele swivel beugel
- Ontwikkeld voor buiteninstallaties, UV resistent, IP 54
- Cover- en Muursabotageschakelaars.
- Optionele Swivel beugel (Model: RA350S)

## Installatie

### Stap1: Voorafgaande aanbevelingen

Selecteer de optimale montageplaats zodat het detectiegebied zo goed mogelijk is afgestemd op de te beveiligen omgeving (zie Detectiepatroon). Opgelet voor volgende punten:

- Installeer de detector op een hoogte van 2,2m (7 ft 2 in). Elke installatie lager dan 2,2m zal het detectiebereik derhalve beïnvloeden.
- Voor pet immuniteit dient de hoogte van het dier (zonder gewichtslimiet) tot 50 cm (1ft 6 in) te bedragen wanneer de detector geïnstalleerd is op 2,2 m (7ft 2 in). Elke installatie lager dan 2,2m zal het detectiebereik derhalve beïnvloeden.
- Installeer de detector op een locatie waar het zichtsveld vrij is van statische obstakels.
- Monteer de detector zo dat de indringer de infrarood stralen kruist volgens zijn bewegingsrichting.
- Installeer de detector niet vlakbij bewegende objecten.
- Bij installeren van meer dan één DT detector moet u meer dan 1m afstand nemen tussen elke unit.

### Stap 2: Monteren van de detector op de muurbeugel

1. Draai de bevestigingsschroef los en verwijder de detector van de montagebeugel (zie Figuur 1).
2. Verwijder de 5 uitdrukbare uitsparingen uit de muurbeugel waardoor u de beugel kan gebruiken als mal voor de montage (zie Figuur 2).

3. Trek de externe bekabeling door de kabeluitsparing welke op de achterkant van de muurbeugel zit (zie Figuur 2 C).
4. Bevestig de muurbeugel tegen de muur (zie Figuur 3).
5. Verbind de eindelus bekabeling (zie Stap 5a).
6. Stel de DIP switches in (zie Stap 5b).
7. Verbind de klemmenstrook met de detector (zie Figuur 4).
8. Monteer de detector op de muurbeugel (zie Figuur 5).
9. Uitvoeren van een looptest (zie Stap 7).
10. Plaats de schroef en draai deze aan tot de detector volledig dicht is (zie Figuur 5).

### Stap 3: PIR Bereik

Montagehoogte [m]	Swivel hoek [°]	Afstand [m]
1.8	0	10
	5	7
	10	5
2.2 (optimaal)	0	12
	5	8
	10	6
2.5	0	N/A
	5	10
	10	7
2.7	0	N/A
	5	10
	10	7

NA = Vermijd zulke installaties

### Stap 4: Instellen van de detector mode

#### Stand alone Mode

1. DIP SW 6 staat op OFF
2. Eindelus aansluiting zoals in Stap 5a

#### RISCO BUS Mode

1. DIP SW 6 staat op ON
2. Bedrading::
  - a) + - klem – Detector 12 VDC, - GND
  - b) Aansluiten van YEL / GRN – Detector BUS
  - c) Ga naar stap 6



## Step 5a: Aansluiten van de klemmenstrook (Stand alone Mode)

Sluit de klemmenstrook aan volgens onderstaande schema:

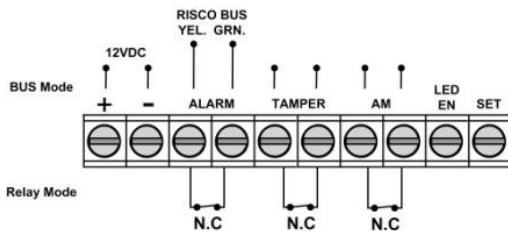

Klem	Beschrijving									
+ -	+12 VDC, - GND									
ALARM YEL GRN	N.G alarm relais									
	ALARM YEL GRN									
	<b>Opn:</b> zoals gedefinieerd via DIP SW 6									
TAMPER +-	N.G sabotage schakelaar									
AM +-	N.G anti-mask alarm relais									
LED ENABLE	<p>Wordt gebruikt om de LED vanop afstand te besturen wanneer DIP1 ingesteld is op ON</p> <p><b>Enable:</b> ingang is +12V OF geen aansluiting op de klemmenstrook</p> <p><b>Disable:</b> Verbind de ingang met 0V</p> <p>Deze functie verhindert een indringer om info te verkrijgen over de status van de detector en de Anti-mask uit te schakelen.</p>									
SET / UNSET	<p>Deze ingang maakt het mogelijk om de Anti-masking te activeren volgens de system status, Ingeschakeld/Uitgeschakeld.</p> <table border="1" style="width: 100%; border-collapse: collapse;"> <thead> <tr> <th>Systeem Status</th> <th>Ingang Status</th> <th>AM Relais</th> </tr> </thead> <tbody> <tr> <td>Ingeschakeld</td> <td>0V</td> <td>Off</td> </tr> <tr> <td>Uitgeschakeld</td> <td>12V of geen connectie</td> <td>On*</td> </tr> </tbody> </table> <p>* DIP SW 4 is ON (Anti mask geactiveerd)</p>	Systeem Status	Ingang Status	AM Relais	Ingeschakeld	0V	Off	Uitgeschakeld	12V of geen connectie	On*
Systeem Status	Ingang Status	AM Relais								
Ingeschakeld	0V	Off								
Uitgeschakeld	12V of geen connectie	On*								

**Opn:** Verzeker u ervan dat jumper J5 geplaatst is om de Swivel sabotage schakelaar te overbruggen.

## Step 5b: Instellen van de DIP Switches (Stand alone Mode)

Stel de DIP switches in volgens de onderstaande tabel

DIP SW	Beschrijving	Def.	Def. Status
1*	LED's: ON: Enable / OFF: Disable	ON	LED's AAN
2*	Sensitivity (PIR)	Low	Mid.
		Mid.	
3*	Sensitivity (PIR)	2*	Low
		3*	
4*	Anti-Masking: ON: Enable / OFF: Disable	ON	Enable
5*	Hoge gevoeligheid (Anti-Mask): ON: Hoog /OFF: Laag	OFF	Laag
6	Mode: ON: BUS / OFF: Relais (zie Definieren BUS ID)	OFF	Relais

Relay mode	DIP SW 7	DIP SW 8	DIP SW 9	DIP SW 10
Normaal	OFF	OFF	OFF	OFF
DEOL	ON	ON	OFF	OFF
TEOL	ON	ON	ON	ON

**Opmerkingen:**

1. Voor DEOL dienen DIP switches 7 en 8 op ON te staan.
2. Voor TEOL dienen DIP switches 7 tot 10 op ON te staan.



Pas het microwave bereik aan via de trimmer op de PCB.

## Step 6a: Definieren van het BUS ID (BUS Mode)

Gebruik DIP switches 1 tot 5 om het correcte BUS ID nr in te stellen voor elke detector. Definieer de BUS ID instellingen volgens de onderstaande tabel.

Stel DIP switch 6 in volgens de onderstaande data:

6	Mode: ON: BUS / OFF: Relay (zie Definieren BUS ID)	ON	BUS
---	--	----	-----

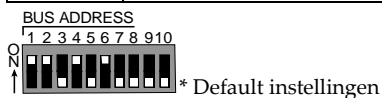

ID	1	2	3	4	5
01	OFF	OFF	OFF	OFF	OFF
02	ON	OFF	OFF	OFF	OFF
03	OFF	ON	OFF	OFF	OFF
04	ON	ON	OFF	OFF	OFF
05	OFF	OFF	ON	OFF	OFF
06	ON	OFF	ON	OFF	OFF
07	OFF	ON	ON	OFF	OFF
08	ON	ON	ON	OFF	OFF
09	OFF	OFF	OFF	ON	OFF
10	ON	OFF	OFF	ON	OFF
11	OFF	ON	OFF	ON	OFF
12	ON	ON	OFF	ON	OFF
13	OFF	OFF	ON	ON	OFF
14	ON	OFF	ON	ON	OFF
15	OFF	ON	ON	ON	OFF
16	ON	ON	ON	ON	OFF
17	OFF	OFF	OFF	OFF	ON
18	ON	OFF	OFF	OFF	ON
19	OFF	ON	OFF	OFF	ON
20	ON	ON	OFF	OFF	ON
21	OFF	OFF	ON	OFF	ON
22	ON	OFF	ON	OFF	ON
23	OFF	ON	ON	OFF	ON
24	ON	ON	ON	OFF	ON
25	OFF	OFF	OFF	ON	ON
26	ON	OFF	OFF	ON	ON
27	OFF	ON	OFF	ON	ON
28	ON	ON	OFF	ON	ON
29	OFF	OFF	ON	ON	ON
30	ON	OFF	ON	ON	ON
31	OFF	ON	ON	ON	ON
32	ON	ON	ON	ON	ON

**Opn:** Deze stap is enkel relevant voor detectoren die aangesloten zijn op de RISCO BUS.

## Stap 6b: Definieren van de systeem instellingen (BUS Mode)

### LightSYS / ProSYS Plus – Toevoegen van een BUS detector

1. Selecteer Installateur menu: [7] BUS apparaten > [1] Automatisch. Het systeem zal automatisch zoeken naar het Bus ID van de detector en koppelen aan een vrije zone (volgens de ingestelde DIP switch instellingen).
2. Scroll, indien nodig, om het type in te stellen op ODT50 en klik OK om te bevestigen.

### Configureer de BUS detector parameters:

Selecteer Installateur menu: [2] Zones > [1] Parameters > [2] categorie > [7] geavanceerd [4] BUS Zone Parameters (zie LightSYS / ProSYS Plus Installatie handleiding).

**Opm:** Voor LightSYS Versie 5.20 en hoger.

## Step 7: Uitvoeren van een looptest (Walk test)

De detector dient gesloten te zijn tijdens de looptest. Start de detector op en wacht tenminste 2 minuten zodat de detector kan stabiliseren. Bij detectie door de detector zal er een signaal verstuurd worden en de LED's lichten op. Wandel door het volledige detectiepatroon en controleer de Led's om het volledige bereik te testen (zie LED Status).

### Manueel activeren van de looptest:

Selecteer in het gebruikersmenu: Onderhoud > looptest > Selecteer volledige looptest of Snelle looptest. De detector blijft in looptest mode totdat er een toetsaanslag gebeurt op het keypad.

## LED Status

LED	State	Description
GEEL	Traag knipperen AAN	Wijst op de start van de PIR detectie analyse
	Continu AAN	Wijst op PIR detectie
	Knipperen	Wijst op Actieve IR AM (Anti mask) detectie
GROEN	Continu AAN	Wijst op MW detectie
ROOD	Continu AAN	Wijst op ALARM
	Knipperen	Wijst op een communicatie probleem met het RISCO systeem (enkel BUS Mode)
Alle LED's	Knipperen (1 na 1)	Detector initialiseerd tijdens opstart

**Opm:** DIP-SW 1 dient in de ON positie te staan om de LED indicatie te activeren.

## Zelf-Test

Elk uur zal de detector een interne zelftest uitvoeren op het PIR en MW kanaal. Wanneer er een fout gedetecteerd wordt zal de detector kortstondig de Anti-mask relais aansturen (Stand alone mode) of indien in BUS mode een foutboodschap versturen.

# Specifications

Electrisch	
Stroomverbruik:	30mA op 12 VDC (Stand by) 42mA op 12 VDC (MAX met LED AAN)
Stroomuitgang	16dBm
Spanningsvereisten	9 -16 VDC
Alarm contacten	24 VDC, 0.1A
AM contacten	24 VDC, 0.1A
Sabotage contacten	24 VDC, 0.1A
Fysisch	
Afmetingen (LxWxD):	170 x 90 x 90mm
Gewicht:	0.532 Kg
Gebruiksomgeving	
RF-Immunititeit:	In lijn met de EN50130-4
Bedrijfstemperatuur:	-30°C tot 60°C (90% vochtigheid)
Opslag Temperatuur:	-30°C tot 70°C (90% vochtigheid)

# Aandachtspunten

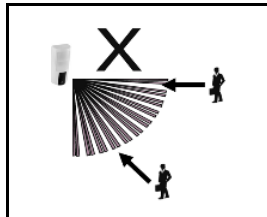
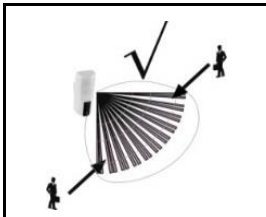
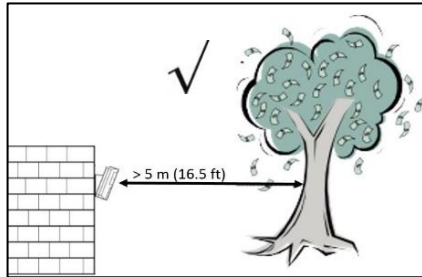
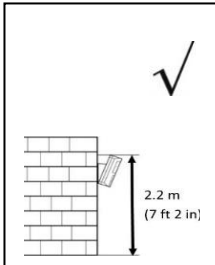

**Opm:** Vermijd installaties waarbij de detector gericht is naar rijdende auto's of een straat, tot op een afstand van 30m.

PIR Detectiepatroon: 12m, 90°

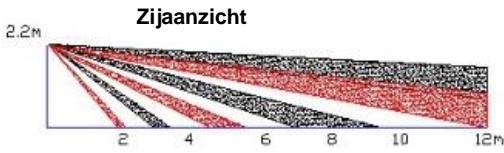

Bovenaanzicht (Top view) of the PIR detection pattern. It shows a fan-shaped area of detection extending 12 meters from a 2.2m high sensor. The detection area is divided into alternating red and black zones, indicating the sensor's field of view and blind spots. The x-axis is labeled with 2, 4, 6, 8, 10, and 12m.

## Eindelus weerstands aansluiting

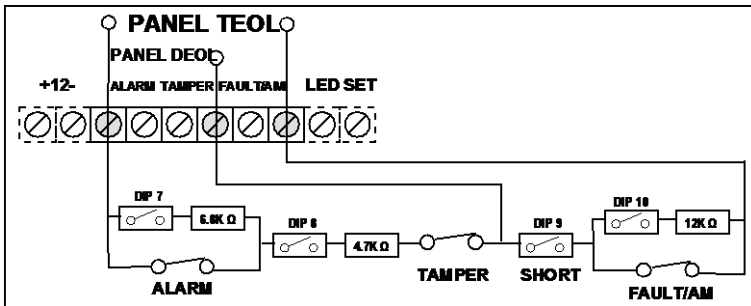

Figuur 1

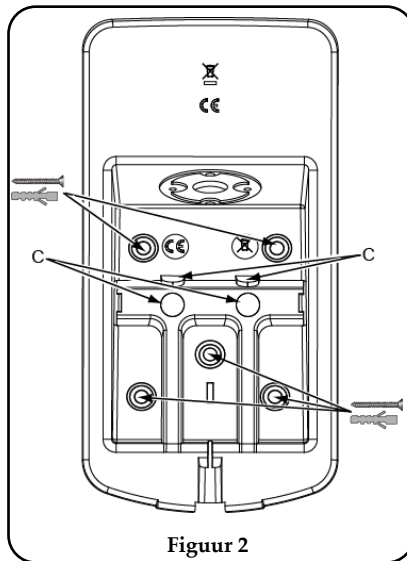

Figuur 2

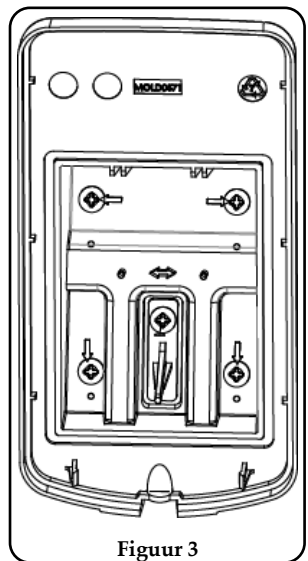

Figuur 3



Figuur 4



Figuur 5

#### Bestelinformatie

RK350DT0000A	Beyond DT, K Band Detector
RA350S00000A	180° Swivel voor Beyond DT

## RED Compliance Statement:

RISCO Group bevestigt dat dit product in lijn is met de essentieel verplichtingen en andere belangrijke clauses van de 2014/53/EU Directieven. Voor de conformiteit verklaring zie onze website: [www.riscogroup.com](http://www.riscogroup.com)

FCC ID:JE4RK350DT

IC:6564A-RK350DT

This device complies with part 15 of the FCC Rules. Operation is subject to the following two conditions:

- (1) This device may not cause harmful interference, and
- (2) This device must accept any interference received, including interference that may cause undesired operation.

Any Changes or modifications not expressly approved by the party responsible for compliance could void the user's authority to operate the equipment.

#### FCC Note

This equipment has been tested and found to comply with the limits for a Class B digital device, pursuant to part 15 of the FCC Rules.

These limits are designed to provide reasonable protection against harmful interference in a residential installation. This equipment generates uses and can radiate radio frequency energy and, if not installed and used in accordance with the instructions, may cause harmful interference to radio communications. However, there is no guarantee that interference will not occur in a particular installation. If this equipment does cause harmful interference to radio or television reception, which can be determined by turning the equipment on and off, the user is encouraged to try to correct the interference by one or more of the following measures:

- Reorient or relocate the receiving antenna.
- Increase the separation between the equipment and the receiver.
- Connect the equipment into an outlet on a different circuit from that to which the receiver is connected.
- Consult the dealer or an experienced radio/TV technician for help.

## **IC Warning**

This device complies with Industry Canada licence-exempt RSS standard(s). Operation is subject to the following two conditions:

(1) This device may not cause interference, and

(2) This device must accept any interference, including interference that may cause undesired operation of the device.

Le présent appareil est conforme aux CNR d'Industrie Canada applicables aux appareils radio exempts de licence. L'exploitation est autorisée aux deux conditions suivantes: (1) l'appareil ne doit pas produire de brouillage, et (2) l'utilisateur de l'appareil doit accepter tout brouillage radioélectrique subi, même si le brouillage est susceptible d'en compromettre le fonctionnement

## Standard Limited Product Warranty (“Limited Warranty”)

RISCO Ltd. (“RISCO”) guarantee RISCO’s hardware products (“Products”) to be free from defects in materials and workmanship when used and stored under normal conditions and in accordance with the instructions for use supplied by RISCO, for a period of (i) 24 months from the date of delivery of the Product (the “Warranty Period”). This Limited Warranty covers the Product only within the country where the Product was originally purchased and only covers Products purchased as new.

**Contact with customers only.** This Limited Warranty is solely for the benefit of customers who purchased the Products directly from RISCO or from an authorized distributor of RISCO. RISCO does not warrant the Product to consumers and nothing in this Warranty obligates RISCO to accept Product returns directly from end users who purchased the Products for their own use from RISCO’s customer or from any installer of RISCO, or otherwise provide warranty or other services to any such end user directly. RISCO’s authorized distributor or installer shall handle all interactions with its end users in connection with this Limited Warranty. RISCO’s authorized distributor or installer shall make no warranties, representations, guarantees or statements to its end users or other third parties that suggest that RISCO has any warranty or service obligation to, or any contractual privity with, any recipient of a Product.

**Remedies.** In the event that a material defect in a Product is discovered and reported to RISCO during the Warranty Period, RISCO shall accept return of the defective Product in accordance with the below RMA procedure and, at its option, either (i) repair or have repaired the defective Product, or (ii) provide a replacement product to the customer.

**Return Material Authorization.** In the event that you need to return your Product for repair or replacement, RISCO will provide you with a Return Merchandise Authorization Number (RMA#) as well as return instructions. Do not return your Product without prior approval from RISCO. Any Product returned without a valid, unique RMA# will be refused and returned to the sender at the sender’s expense. The returned Product must be accompanied with a detailed description of the defect discovered (“Defect Description”) and must otherwise follow RISCO’s then-current RMA procedure published in RISCO’s website at [www.riscogroup.com](http://www.riscogroup.com) in connection with any such return. If RISCO determines in its reasonable discretion that any Product returned by customer conforms to the applicable warranty (“Non-Defective Product”), RISCO will notify the customer of such determination and will return the applicable Product to customer at customer’s expense. In addition, RISCO may propose and assess customer a charge for testing and examination of Non-Defective Product.

**Entire Liability.** The repair or replacement of Products in accordance with this Limited Warranty shall be RISCO’s entire liability and customer’s sole and exclusive remedy in case a material defect in a Product is discovered and reported as required herein. RISCO’s obligation and this Limited Warranty are contingent upon the full payment by customer for such Product and upon a proven weekly testing and examination of the Product functionality.

**Limitations.** This Limited Warranty is the only warranty made by RISCO with respect to the Products. The warranty is not transferable to any third party. To the maximum extent permitted by applicable law, this Limited Warranty shall not apply and will be void if: (i) the conditions set forth above are not met (including, but not limited to, full payment by customer for the Product and a proven weekly testing and examination of the Product functionality); (ii) if the Products or any part or component thereof: (a) have been subjected to improper operation or installation; (b) have been subject to neglect, abuse, willful damage, abnormal working conditions, failure to follow RISCO’s instructions (whether oral or in writing); (c) have been misused, altered, modified or repaired without RISCO’s written approval or combined with, or installed on products, or equipment of the customer or of any third party; (d) have been damaged by any factor beyond RISCO’s reasonable control such as, but not limited to, power failure, electric power surges, or unsuitable third party components and the interaction of software therewith or (e) any failure or delay in the performance of the Product attributable to any means of communication provided by any third party service provider, including, but not limited to, GSM interruptions, lack of or internet outage and/or telephony failure. BATTERIES ARE EXPLICITLY EXCLUDED FROM THE WARRANTY AND RISCO SHALL NOT BE HELD RESPONSIBLE OR LIABLE IN RELATION THERETO, AND THE ONLY WARRANTY APPLICABLE THERETO, IF ANY, IS THE BATTERY MANUFACTURER’S WARRANTY. RISCO does not install or integrate the Product in the end user’s security system and is therefore not responsible for and cannot guarantee the performance of the end user’s security system which uses the Product or which the Product is a component of.

This Limited Warranty applies only to Products manufactured by or for RISCO. Further, this Limited Warranty does not apply to any software (including operating system) added to or provided with the Products or any third-party software, even if packaged or sold with the RISCO Product. Manufacturers, suppliers, or third parties other than RISCO may provide their own warranties, but RISCO, to the extent permitted by law and except as otherwise specifically set forth herein, provides its Products “AS IS”. Software and applications distributed or made available by RISCO in conjunction with the Product (with or without the RISCO brand), including, but not limited to system software, as well as P2P services or any other service made available by RISCO in relation to the Product, are not covered under this Limited Warranty. Refer to the Terms of Service at: <https://riscocloud.com/ELAS/WebUI/UserLogin/License> for details of your rights and



obligations with respect to the use of such applications, software or any service. RISCO does not represent that the Product may not be compromised or circumvented; that the Product will prevent any personal injury or property loss by burglary, robbery, fire or otherwise, or that the Product will in all cases provide adequate warning or protection. A properly installed and maintained alarm may only reduce the risk of a burglary, robbery or fire without warning, but it is not insurance or a guarantee that such will not occur or will not cause or lead to personal injury or property loss. CONSEQUENTLY, RISCO SHALL HAVE NO LIABILITY FOR ANY PERSONAL INJURY, PROPERTY DAMAGE OR OTHER LOSS BASED ON ANY CLAIM AT ALL INCLUDING A CLAIM THAT THE PRODUCT FAILED TO GIVE WARNING.

EXCEPT FOR THE WARRANTIES SET FORTH HEREIN, RISCO AND ITS LICENSORS HEREBY DISCLAIM ALL EXPRESS, IMPLIED OR STATUTORY, REPRESENTATIONS, WARRANTIES, GUARANTEES, AND CONDITIONS WITH REGARD TO THE PRODUCTS, INCLUDING BUT NOT LIMITED TO ANY REPRESENTATIONS, WARRANTIES, GUARANTEES, AND CONDITIONS OF MERCHANTABILITY, FITNESS FOR A PARTICULAR PURPOSE, TITLE AND WARRANTIES AGAINST HIDDEN OR LATENT DEFECTS, TO THE EXTENT PERMITTED BY LAW. WITHOUT LIMITING THE GENERALITY OF THE FOREGOING, RISCO AND ITS LICENSORS DO NOT REPRESENT OR WARRANT THAT: (i) THE OPERATION OR USE OF THE PRODUCT WILL BE TIMELY, SECURE, UNINTERRUPTED OR ERROR-FREE; (ii) THAT ANY FILES, CONTENT OR INFORMATION OF ANY KIND THAT MAY BE ACCESSED THROUGH THE PRODUCT SHALL REMAIN SECURED OR NON DAMAGED. CUSTOMER ACKNOWLEDGES THAT NEITHER RISCO NOR ITS LICENSORS CONTROL THE TRANSFER OF DATA OVER COMMUNICATIONS FACILITIES, INCLUDING THE INTERNET, GSM OR OTHER MEANS OF COMMUNICATIONS AND THAT RISCO'S PRODUCTS, MAY BE SUBJECT TO LIMITATIONS, DELAYS, AND OTHER PROBLEMS INHERENT IN THE USE OF SUCH MEANS OF COMMUNICATIONS. RISCO IS NOT RESPONSIBLE FOR ANY DELAYS, DELIVERY FAILURES, OR OTHER DAMAGE RESULTING FROM SUCH PROBLEMS. RISCO WARRANTS THAT ITS PRODUCTS DO NOT, TO THE BEST OF ITS KNOWLEDGE, INFRINGE UPON ANY PATENT, COPYRIGHT, TRADEMARK, TRADE SECRET OR OTHER INTELLECTUAL PROPERTY RIGHT IN ANY EVENT RISCO SHALL NOT BE LIABLE FOR ANY AMOUNTS REPRESENTING LOST REVENUES OR PROFITS, PUNITIVE DAMAGES, OR FOR ANY OTHER INDIRECT, SPECIAL, INCIDENTAL, OR CONSEQUENTIAL DAMAGES, EVEN IF THEY WERE FORESEEABLE OR RISCO HAS BEEN INFORMED OF THEIR POTENTIAL.

## Contacting RISCO Group

RISCO Group is committed to customer service and product support. You can contact us through our website ([www.riscogroup.com](http://www.riscogroup.com)) or at the following telephone and fax numbers:

### **United Kingdom**

Tel: +44-(0)-161-655-5500

[support-uk@riscogroup.com](mailto:support-uk@riscogroup.com)

### **Italy**

Tel: +39-02-66590054

[support-it@riscogroup.com](mailto:support-it@riscogroup.com)

### **Spain**

Tel: +34-91-490-2133

[support-es@riscogroup.com](mailto:support-es@riscogroup.com)

### **France**

Tel: +33-164-73-28-50

[support-fr@riscogroup.com](mailto:support-fr@riscogroup.com)

### **Israel**

Tel: +972-3-963-7777

[support@riscogroup.com](mailto:support@riscogroup.com)

### **Belgium (Benelux)**

Tel: +32-2522-7622

[support-be@riscogroup.com](mailto:support-be@riscogroup.com)

### **USA**

Tel: +1-631-719-4400

[support-usa@riscogroup.com](mailto:support-usa@riscogroup.com)

### **China (Shanghai)**

Tel: +86-21-52-39-0066

[support-cn@riscogroup.com](mailto:support-cn@riscogroup.com)

### **Australia**

Tel: + 1800-991-542

[support-au@riscogroup.com](mailto:support-au@riscogroup.com)



**FCC Caution.**

This device complies with part 15 of the FCC Rules. Operation is subject to the following two conditions:

- (1) This device may not cause harmful interference, and
- (2) this device must accept any interference received, including interference that may cause undesired operation.

Any Changes or modifications not expressly approved by the party responsible for compliance could void the user's authority to operate the equipment.

Note: This equipment has been tested and found to comply with the limits for a Class B digital device, pursuant to part 15 of the FCC Rules. These limits are designed to provide reasonable protection against harmful interference in a residential installation. This equipment generates uses and can radiate radio frequency energy and, if not installed and used in accordance with the instructions, may cause harmful interference to radio communications. However, there is no guarantee that interference will not occur in a particular installation. If this equipment does cause harmful interference to radio or television reception, which can be determined by turning the equipment off and on, the user is encouraged to try to correct the interference by one or more of the following measures:

- Reorient or relocate the receiving antenna.
- Increase the separation between the equipment and receiver.
- Connect the equipment into an outlet on a circuit different from that to which the receiver is connected.
- Consult the dealer or an experienced radio/TV technician for help.

This equipment complies with FCC radiation exposure limits set forth for an uncontrolled environment. This equipment should be installed and operated with minimum distance 20cm between the radiator & your body.