

# TEST REPORT

of

## FCC Part 15 Subpart B & C

Product : **Aivia M8600 Wireless Macro Gaming Mouse Receiver**

Model: **2871586000CBS-RX**

Brand: **GIGABYTE**

Applicant: **GIGA-BYTE Technology Co., Ltd.**

Address: **No. 6, Bau-Chiang Rd., Hsin Tien City,  
Taipei Hsien, Taiwan**

### Test Performed by:

#### International Standards Laboratory

<Lung-Tan LAB>

\*Site Registration No.

BSMI: SL2-IN-E-0013; TAF: 0997; IC: IC4067B-1;

VCCI: R-1435, C-1440, T-1676, G-17, R-2598, C-2845, T-1464, G-16,  
G-211, NEMKO: ELA 113B

\*Address:

No. 120, Lane 180, San Ho Tsuen, Hsin Ho Rd.

Lung-Tan Hsiang, Tao Yuan County 325, Taiwan

\*Tel : 886-3-407-1718; Fax: 886-3-407-1738

Report No.: **ISL-10LR039FC**

Issue Date : **2010/11/05**

This report totally contains 38 pages including this cover page and contents page.

Test results given in this report apply only to the specific sample(s) tested and are traceable to national or international standard through calibration of the equipment and evaluating measurement uncertainty herein.

This report MUST not be used to claim product endorsement by TAF, NVLAP or any agency of the Government.

This test report shall not be reproduced except in full, without the written approval of International Standards Laboratory.

Contents of Report

- 1. General ..... 1
  - 1.1 Certification of Accuracy of Test Data ..... 1
  - 1.2 Test Results Summary ..... 2
  - 1.3 Test Frequencies of the wireless module..... 2
  - 1.4 Test Conditions..... 2
- 2. Description of Equipment Under Test (EUT) ..... 3
  - 2.1 Description of Support Equipment ..... 4
    - 2.1.1 Software for Controlling Support Unit ..... 4
    - 2.1.2 I/O Cable Condition of EUT and Support Units..... 4
- 3. TEST RESULTS ..... 5
  - 3.1 Powerline Conducted Emissions ..... 5
    - 3.1.1 EUT Configuration ..... 5
    - 3.1.2 Test Procedure ..... 5
    - 3.1.3 EMI Receiver/Spectrum Analyzer Configuration (for the frequencies tested)..... 5
    - 3.1.4 Test Data:..... 6
  - 3.2 Radiated Emission Measurement ..... 8
    - 3.2.1 EUT Configuration ..... 8
    - 3.2.2 Test Procedure ..... 8
    - 3.2.3 EMI Receiver/Spectrum Analyzer Configuration (for the frequencies tested)..... 8
    - 3.2.4 Test Data:..... 9
  - 3.3 Band Edge & Fundamental Emission Measurement ..... 17
    - 3.3.1 Test Procedure ..... 17
    - 3.3.2 Test Setup ..... 17
    - 3.3.3 Test Data:..... 18
  - 3.4 Band Edge Restricted Bands & Fundamental Emission Measurement..... 21
    - 3.4.1 Test Procedure (Radiated & Fundamental)..... 21
    - 3.4.2 Test Setup (Radiated & Fundamental)..... 21
    - 3.4.3 Test Data..... 22
- 4. Appendix ..... 28
  - 4.1 Appendix A: Measurement Procedure for Power line Conducted Emissions..... 28
  - 4.2 Appendix B: Test Procedure for Radiated Emissions ..... 29
  - 4.3 Appendix C: Test Equipment ..... 30
    - 4.3.1 Test Equipment List..... 30
    - 4.3.2 Software for Controlling Spectrum/Receiver and Calculating Test Data ..... 30
  - 4.4 Appendix D: Layout of EUT and Support Equipment ..... 31
    - 4.4.1 General Conducted Test Configuration ..... 31
    - 4.4.2 General Radiation Test Configuration ..... 32
  - 4.5 Appendix E: Accuracy of Measurement ..... 33
  - 4.6 Appendix F: Photographs of EUT Configuration Test Set Up..... 34

## 1. General

### 1.1 Certification of Accuracy of Test Data

**Standards:** CFR 47 Part 15 Subpart B Class B  
CFR 47 Part 15 Subpart C (Section 15.249)

**Test Procedure:** ANSI C63.4:2003

**Equipment Tested:** Aivia M8600 Wireless Macro Gaming Mouse Receiver

**Model:** 28715860000CBS-RX

**Applied by:** GIGABYTE

**Sample received Date:** 2010/10/12

**Final test Date :** 2010/11/03

**Test Result** PASS

**Test Site:** Chamber 14, Conduction 03

**Temperature** Refer to each site test data

**Humidity:** Refer to each site test data

**Test Engineer:**

Scott Chien

Scott Chien

All the tests in this report have been performed and recorded in accordance with the standards described above and performed by an independent electromagnetic compatibility consultant, International Standards Laboratory.

The test results contained in this report accurately represent the measurements of the characteristics and the energy generated by sample equipment under test at the time of the test. The sample equipment tested as described in this report is in compliance with the limits of above standards.

Approve & Signature

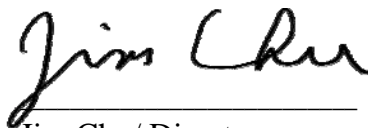

Jim Chu/ Director

## 1.2 Test Results Summary

The wireless functions of EUT has been tested according to the FCC regulations listed below:

Tested Standards: 47 CFR Part 15 Subpart C			
Standard Section	Test Type	Result	Remarks
15.207	AC Power Line Emissions	Pass	
15.249	Radiated Emissions 30MHz – 25 GHz	Pass	
15.249	Band Edge Measurement	Pass	

## 1.3 Test Frequencies of the wireless module

EUT Channel	Test Frequency (MHz)
1	2402
4	2439
8	2479

## 1.4 Test Conditions

- a. Normal test conditions:  
Temperature: 25 °C  
Relative Humidity: 50% to 75%
- b. During the test, the EUT was set in continuously transmitting mode with a duty cycle of 40.8%.
- c. The channel 1, 4, 8 of EUT were all tested

## 2. Description of Equipment Under Test (EUT)

Description:	Aivia M8600 Wireless Macro Gaming Mouse Receiver
Condition:	Pre-Production
Model:	28715860000CBS-RX
FCC ID:	JCK287158600-RX
Frequency Range of 802.11b/g/n:	2400 - 2483.5 MHz
Support channel:	8 Channels
Modulation Skill:	GFSK
Antennas Type:	Printed on PCB
Antenna Connected:	The antenna printed on the PCB of the wireless module .The user is not possible to change the antenna without disassembling the EUT.
Antenna peak Gain:	0 dBi.
Power Type of wireless module:	NB or PC USB Port Supply Voltage

The channel and the operation frequency of is listed below:

Channel	Frequency(MHz)	Channel	Frequency(MHz)
01	2402	07	2468
02	2411	08	2479
03	2425		
04	2439		
05	2447		
06	2450		

## 2.1 Description of Support Equipment

No	Unit	Model / Serial No.	Brand	Power Cord	FCC ID
1	DELL NB	Latitude D620 S/N:N/A	DELL	Non-shielded Detachable	FCC DOC

### 2.1.1 Software for Controlling Support Unit

During the test, the EUT is connected to a notebook PC which excutes the RF software to make the transmitter continuously send RF signals.

	Filename	Issued Date
Control Soft	rf_gaming_test_mode. exe	8/30/2010

### 2.1.2 I/O Cable Condition of EUT and Support Units

Description	Path	Cable Length	Cable Type	Connector Type
USB Data Cable	EUT to NB USB Port	1.8M	Nonshielded, Detachable (with cord)	Metal Head

### 3. TEST RESULTS

#### 3.1 Powerline Conducted Emissions

##### 3.1.1 EUT Configuration

The EUT was set up on the non-conductive table that is 1.0 by 1.5 meter, 80cm above ground. The wall of the shielded room was located 40cm to the rear of the EUT.

Power to the EUT was provided through the LISN. The impedance vs. frequency characteristic of the LISN is complied with the limit used.

Both lines (neutral and hot) were connected to the LISN in series at testing. A coaxial-type connector which provides one 50 ohms terminating impedance was provided for connecting the test instrument. The excess length of the power cord was folded back and forth at the center of the lead so as to form a bundle not exceeding 40cm in length.

Any changes made to the configuration, or modifications made to the EUT, during testing are noted in the following test record.

If the EUT is a Personal Computer or a peripheral of personal computer, and the personal computer has an auxiliary AC outlet which can be used for providing power to an external monitor, then all measurements will be made with the monitor power from first the computer-mounted AC outlet and then a floor-mounted AC outlet.

##### 3.1.2 Test Procedure

The system was set up as described above, with the EMI diagnostic software running. The main power line conducted EMI tests were run on the hot and neutral conductors of the power cord and the results were recorded. The effect of varying the position of the interface cables has been investigated to find the configuration that produces maximum emission.

At the frequencies where the peak values of the emissions were higher than 6dB below the applicable limits, the emissions were also measured with the quasi-peak detectors. At the frequencies where the quasi-peak values of the emissions were higher than 6dB below the applicable average limits, the emissions were also measured with the average detectors.

The highest emissions were analyzed in details by operating the spectrum analyzer in fixed tuned mode to determine the nature of the emissions and to provide information which could be useful in reducing their amplitude.

##### 3.1.3 EMI Receiver/Spectrum Analyzer Configuration (for the frequencies tested)

Frequency Range	150 KHz--30MHz
Detector Function	Quasi-Peak/Average
Bandwidth (RBW)	9KHz

### 3.1.4 Test Data:

#### Power Line Conducted Emissions (Hot) Lowest, Middle, Highest channel

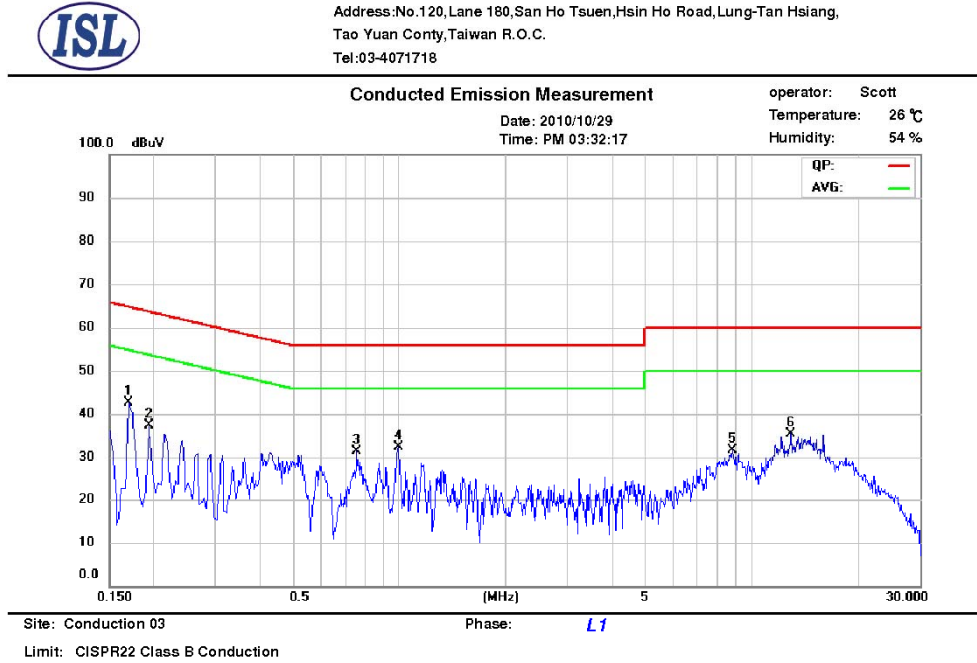

No.	Frequency MHz	LISN Loss dB	Cable Loss dB	QP Correct dBuV	QP Limit dBuV	QP Margin dB	AVG Correct dBuV	AVG Limit dBuV	AVG Margin dB	Note
1	0.1700	0.08	0.04	41.05	64.9	-23.9	25.45	54.9	-29.5	
2	0.1940	0.07	0.04	35.22	63.8	-28.6	21.08	53.8	-32.7	
3	0.7580	0.06	0.06	26.94	56.0	-29.0	21.43	46.0	-24.5	
4	0.9980	0.06	0.06	29.39	56.0	-26.6	22.24	46.0	-23.7	
5	8.8140	0.09	0.2	27.66	60.0	-32.3	22.23	50.0	-27.7	
6	12.9300	0.15	0.23	28.66	60.0	-31.3	23.10	50.0	-26.9	



**Power Line Conducted Emissions (Neutral) Lowest, Middle, Highest channel**



Address: No.120, Lane 180, San Ho Tsuen, Hsin Ho Road, Lung-Tan Hsiang,  
Tao Yuan Conty, Taiwan R.O.C.  
Tel: 03-4071718

**Conducted Emission Measurement**

operator: Scott  
Temperature: 26 °C  
Humidity: 54 %

Date: 2010/10/29  
Time: PM 03:34:26

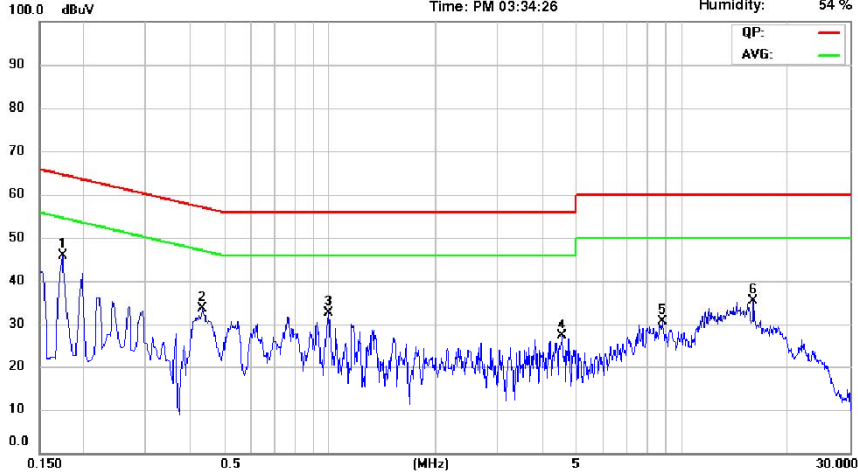

Site: Conduction 03

Phase: N

Limit: CISPR22 Class B Conduction

No.	Frequency MHz	LISN Loss dB	Cable Loss dB	QP Correct. dBuV	QP Limit dBuV	QP Margin dB	AVG Correct. dBuV	AVG Limit dBuV	AVG Margin dB	Note
1	0.1740	0.11	0.04	44.29	64.7	-20.4	32.02	54.7	-22.7	
2	0.4340	0.08	0.06	30.97	57.1	-26.2	25.50	47.1	-21.6	
3	0.9980	0.07	0.06	30.31	56.0	-25.6	22.88	46.0	-23.1	
4	4.5860	0.09	0.15	23.27	56.0	-32.7	15.37	46.0	-30.6	
5	8.8180	0.11	0.2	26.32	60.0	-33.6	20.95	50.0	-29.0	
6	16.0220	0.24	0.24	34.61	60.0	-25.3	32.44	50.0	-17.5	

\* NOTE: During the test, the EMI receiver was set to Max. Hold then switch the EUT Channel between Lowest, Middle, Highest to get the maximum reading of all these channels.  
Margin = Amplitude + Insertion Loss- Limit  
A margin of -8dB means that the emission is 8dB below the limit

## 3.2 Radiated Emission Measurement

### 3.2.1 EUT Configuration

The equipment under test was set up on the 3 meter chamber with measurement distance of 3 meters. The EUT was placed on a non-conductive table 80cm above ground.

Any changes made to the configuration, or modifications made to the EUT, during testing are noted in the following test record.

### 3.2.2 Test Procedure

The system was set up as described above, with the EMI diagnostic software running. We found the maximum readings by varying the height of antenna and then rotating the turntable. Both polarization of antenna, horizontal and vertical, are measured.

30M to 1GHz: The highest emissions between 30 MHz to 1000 MHz were also analyzed in details by operating the spectrum analyzer and/or EMI receiver in quasi-peak mode to determine the precise amplitude of the emissions. While doing so, the interconnecting cables and major parts of the system were moved around, the antenna height was varied between one and four meters, its polarization was varied between vertical and horizontal, and the turntable was slowly rotated, to maximize the emission.

1GHz – 25GHz: The highest emissions were also analyzed in details by operating the spectrum analyzer and/or EMI receiver in peak mode to determine the precise amplitude of the emission. While doing so, the interconnecting cables and major parts of the system were moved around, the antenna height was varied between one and four meters, its polarization was varied between vertical and horizontal, and the turntable was slowly rotated, to maximize the emission. During test the EMI receiver and spectrum was setup *according to EMI Receiver/Spectrum Analyzer Configuration*.

For the test of 2<sup>nd</sup> to 10<sup>th</sup> harmonics frequencies, the equipment setup was also refer to EMI Receiver/Spectrum Analyzer Configuration. The frequencies were tested using Peak mode first, if the test data is higher than the emissions limit, an additional measurement using Average mode will be performed and the average reading will be compared to the limit and record in test report.

### 3.2.3 EMI Receiver/Spectrum Analyzer Configuration (for the frequencies tested)

Frequency Range Tested:	30MHz~1000MHz
Detector Function:	Quasi-Peak Mode
Resolution Bandwidth (RBW):	120KHz
Video Bandwidth (VBW)	360KHz

Frequency Range Tested:	1GHz – 25 GHz
Detector Function:	Peak Mode
Resolution Bandwidth (RBW):	1MHz
Video Bandwidth (VBW)	3MHz

Frequency Range Tested:	1GHz – 25 GHz
Detector Function:	Average Mode
Resolution Bandwidth (RBW):	1MHz
Video Bandwidth (VBW)	1K Hz

3.2.4 Test Data:

30M – 1GHz Open Field Radiated Emissions (Horizontal) Lowest, Middle, Highest channel

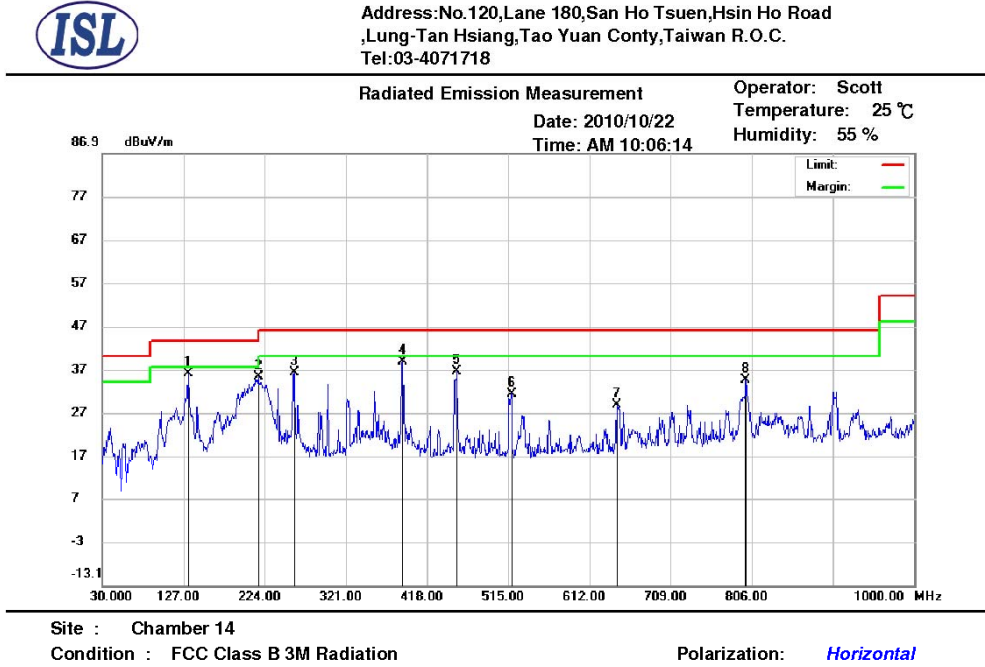

Mk.	Frequency (MHz)	RX_R (dBuV/m)	Ant_F (dB)	Cab_L (dB)	PreAmp (dB)	Emission (dBuV/m)	Limit (dBuV/m)	Margin (dB)	Ant.Pos (cm)	Tab.Pos (deg.)	Detector
1	132.8200	57.54	12.3	0.73	34.43	36.14	43.50	-7.36	241	70	peak
2	216.2400	58.41	10.5	0.9	34.51	35.30	46.00	-10.70	100	47	peak
3	258.9200	56.25	13.51	1	34.4	36.36	46.00	-9.64	100	195	peak
4	388.9000	55.12	16.21	1.18	33.78	38.73	46.00	-7.27	100	264	peak
5	453.8900	51.81	17.15	1.3	33.73	36.53	46.00	-9.47	100	148	peak
6	518.8800	45.68	18.08	1.34	33.71	31.39	46.00	-14.61	353	314	peak
7	644.9800	41.40	19.27	1.5	33.41	28.76	46.00	-17.24	393	318	peak
8	799.2100	45.15	20.59	1.7	32.96	34.48	46.00	-11.52	146	103	peak

\*:Maximum data x:Over limit !:over margin

### 30M – 1GHz Open Field Radiated Emissions (Vertical) Lowest, Middle, Highest channel

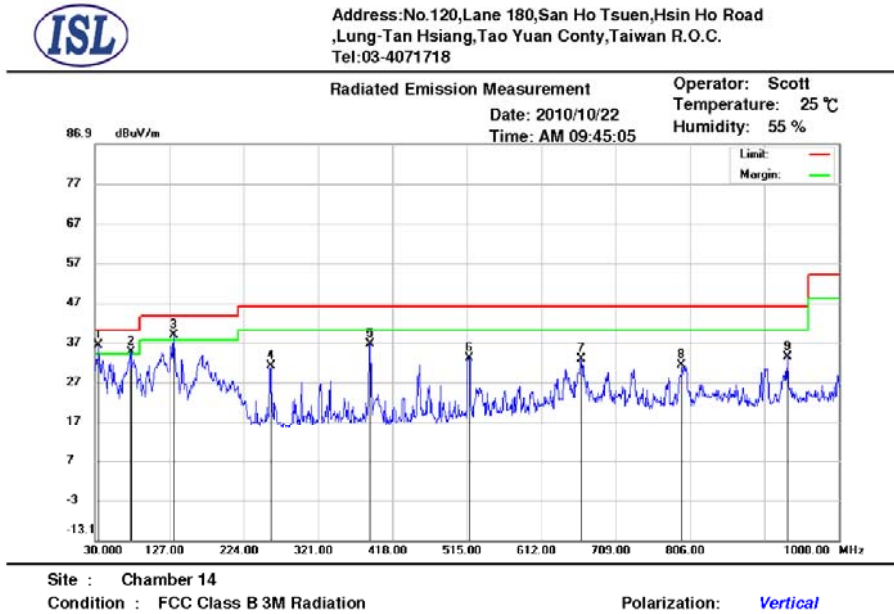

Mk.	Frequency (MHz)	RX_R (dBuV/m)	Ant_F (dB)	Cab_L (dB)	PreAmp (dB)	Emission (dBuV/m)	Limit (dBuV/m)	Margin (dB)	Ant.Pos (cm)	Tab.Pos (deg.)	Detector
1	34.8500	53.97	16.79	0.4	34.78	36.38	40.00	-3.62	328	26	peak
2	76.5600	61.27	7.22	0.6	34.54	34.55	40.00	-5.45	383	267	peak
3	132.8200	60.09	12.3	0.73	34.43	38.69	43.50	-4.81	100	239	peak
4	258.9200	51.04	13.51	1	34.4	31.15	46.00	-14.85	140	247	peak
5	388.9000	52.95	16.21	1.18	33.78	36.56	46.00	-9.44	100	165	peak
6	517.9100	47.42	18.06	1.34	33.71	33.11	46.00	-12.89	100	36	peak
7	664.3800	45.24	19.39	1.53	33.32	32.84	46.00	-13.16	100	56	peak
8	795.3300	42.00	20.55	1.69	32.97	31.27	46.00	-14.73	155	90	peak
9	933.0700	42.19	21.83	1.87	32.7	33.19	46.00	-12.81	246	114	peak

\*:Maximum data x:Over limit !:over margin

NOTE:

→ During the Pre-test, the EUT has been tested for Lowest, Middle, Highest channel transmit from Main and Aux antenna respectively to get all the critical emission frequencies. In the final test all the critical emission frequencies has been tested and the test data are listed above.

→ Margin = Corrected Amplitude – Limit

Corrected Amplitude = Radiated Amplitude + Antenna Correction Factor + Cable Loss - Pre-Amplifier Gain

A margin of -8dB means that the emission is 8dB below the limit

**All frequencies from 30MHz to 1GHz have been tested**

1GHz~ 25 GHz (Horizontal), Lowest Channel



Address: No.120, Lane 180, San Ho Tsuen, Hsin Ho Road  
, Lung-Tan Hsiang, Tao Yuan Conty, Taiwan R.O.C.  
Tel: 03-4071718

Radiated Emission Measurement

Operator: Scott

Date: 2010/10/22

Temperature: 25 °C

Time: AM 11:49:50

Humidity: 55 %

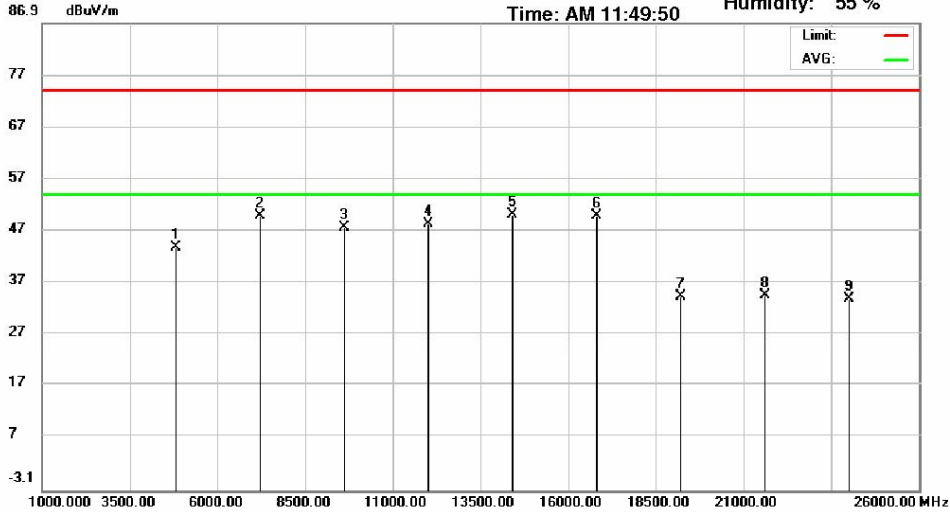

Site : Chamber 14

Condition : FCC Class B Radiation(Peak)

Polarization: *Horizontal*

Mk.	Frequency (MHz)	RX_R (dBuV/m)	Ant_F (dB)	Cab_L (dB)	PreAmp (dB)	Emission (dBuV/m)	Limit (dBuV/m)	Margin (dB)	Ant.Pos (cm)	Tab.Pos (deg.)	Detector
1	4804.000	53.06	34.64	3.42	47.32	43.80	74.00	-30.20	160	265	peak
2	7200.000	55.96	36.08	4.18	46.34	49.88	74.00	-24.12	154	5	peak
3	9608.000	49.08	37.11	4.92	43.56	47.55	74.00	-26.45	337	90	peak
4	12010.000	46.74	39.3	5.6	43.31	48.33	74.00	-25.67	129	206	peak
5	14412.000	50.99	39.76	6	46.56	50.19	74.00	-23.81	329	344	peak
6	16814.000	47.94	42.17	6.66	46.89	49.88	74.00	-24.12	384	97	peak
7	19216.000	53.15	23.84	5.7	48.43	34.26	74.00	-39.74	236	19	peak
8	21618.000	50.37	24.48	6.02	46.26	34.61	74.00	-39.39	239	169	peak
9	24020.000	47.99	24.7	6.4	45.1	33.99	74.00	-40.01	388	282	peak

\*:Maximum data x:Over limit !:over margin

1GHz~ 25 GHz (Vertical), Lowest Channel



Address: No.120, Lane 180, San Ho Tsuen, Hsin Ho Road  
, Lung-Tan Hsiang, Tao Yuan Conty, Taiwan R.O.C.  
Tel: 03-4071718

Radiated Emission Measurement

Operator: Scott  
Temperature: 25 °C  
Humidity: 55 %

Date: 2010/10/22  
Time: AM 11:53:50

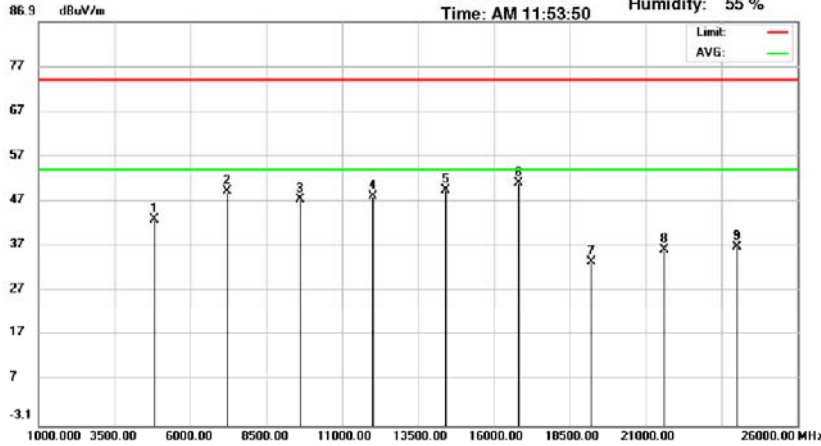

Site : Chamber 14

Condition : FCC Class B Radiation(Peak)

Polarization: Vertical

Mk.	Frequency (MHz)	RX_R (dBuV/m)	Ant_F (dB)	Cab_L (dB)	PreAmp (dB)	Emission (dBuV/m)	Limit (dBuV/m)	Margin (dB)	Ant.Pos (cm)	Tab.Pos (deg.)	Detector
1	4804.000	52.27	34.64	3.42	47.32	43.01	74.00	-30.99	318	31	peak
2	7200.000	55.40	36.08	4.18	46.34	49.32	74.00	-24.68	232	97	peak
3	9608.000	48.85	37.11	4.92	43.56	47.32	74.00	-26.68	100	107	peak
4	12010.000	46.53	39.3	5.6	43.31	48.12	74.00	-25.88	339	207	peak
5	14412.000	50.29	39.76	6	46.56	49.49	74.00	-24.51	256	143	peak
6	16814.000	49.01	42.17	6.66	46.89	50.95	74.00	-23.05	220	252	peak
7	19216.000	52.40	23.84	5.7	48.43	33.51	74.00	-40.49	109	336	peak
8	21618.000	51.86	24.48	6.02	46.26	36.10	74.00	-37.90	119	298	peak
9	24020.000	50.74	24.7	6.4	45.1	36.74	74.00	-37.26	184	36	peak

\*:Maximum data x:Over limit !:over margin

Note:

- According to the standards used, Where limits are specified by agencies for both average and peak (or quasi-peak) detection , if the peak (or quasi-peak) measured value complies with the average limit , it is unnecessary to perform an average measurement.
- “ peak”: peak mode; “avg”: average mode
- The Spectrum noise level+Correction Factor < Limit - 6 dB
- Margin=Corrected Amplitude – Limit
- Corrected Amplitude=Radiated Amplitude+Antenna Correction Factor+Cable Loss-Pre-Amplifier Gain
- A margin of -8dB means that the emission is 8dB below the limit.

**All frequencies from 1GHz to 25 GHz have been tested.**

1GHz~ 25 GHz (Horizontal), Middle Channel



Address: No.120, Lane 180, San Ho Tsuen, Hsin Ho Road  
, Lung-Tan Hsiang, Tao Yuan Conty, Taiwan R.O.C.  
Tel: 03-4071718

Radiated Emission Measurement

Operator: Scott  
Temperature: 25 °C  
Humidity: 55 %

Date: 2010/10/22  
Time: AM 11:56:27

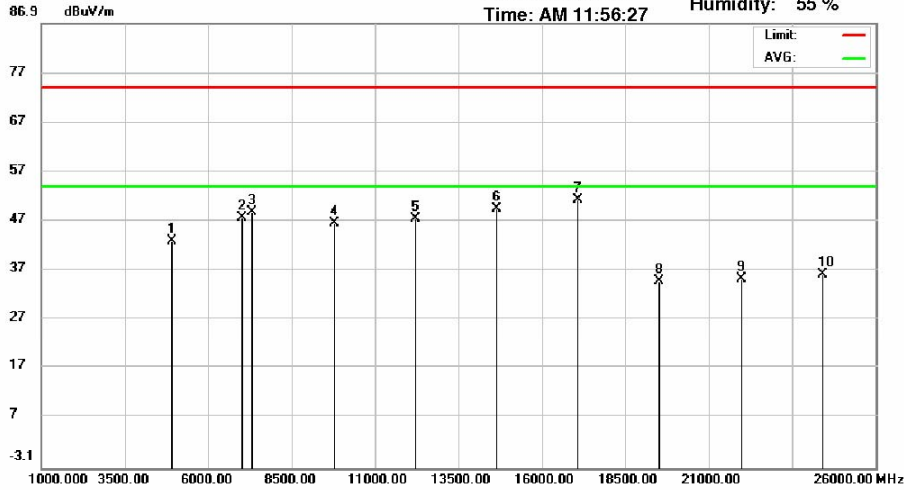

Site : Chamber 14

Condition : FCC Class B Radiation(Peak)

Polarization: *Horizontal*

Mk.	Frequency (MHz)	RX_R (dBuV/m)	Ant_F (dB)	Cab_L (dB)	PreAmp (dB)	Emission (dBuV/m)	Limit (dBuV/m)	Margin (dB)	Ant.Pos (cm)	Tab.Pos (deg.)	Detector
1	4878.000	52.21	34.62	3.45	47.35	42.93	74.00	-31.07	194	111	peak
2	7025.000	53.85	36.19	4.11	46.48	47.67	74.00	-26.33	166	81	peak
3	7317.000	54.82	36.01	4.23	46.25	48.81	74.00	-25.19	100	24	peak
4	9756.000	47.78	37.26	4.95	43.5	46.49	74.00	-27.51	100	10	peak
5	12195.000	46.02	39.34	5.64	43.5	47.50	74.00	-26.50	153	252	peak
6	14634.000	50.21	40.01	6.05	46.78	49.49	74.00	-24.51	315	183	peak
7	17073.000	48.96	41.98	6.73	46.52	51.15	74.00	-22.85	270	217	peak
8	19512.000	53.33	23.9	5.7	48.19	34.74	74.00	-39.26	396	116	peak
9	21951.000	50.53	24.41	6.09	45.86	35.17	74.00	-38.83	382	176	peak
10	24390.000	50.04	24.7	6.48	45.1	36.12	74.00	-37.88	162	1	peak

\*:Maximum data x:Over limit !:over margin

1GHz~ 25 GHz (Vertical), Middle Channel

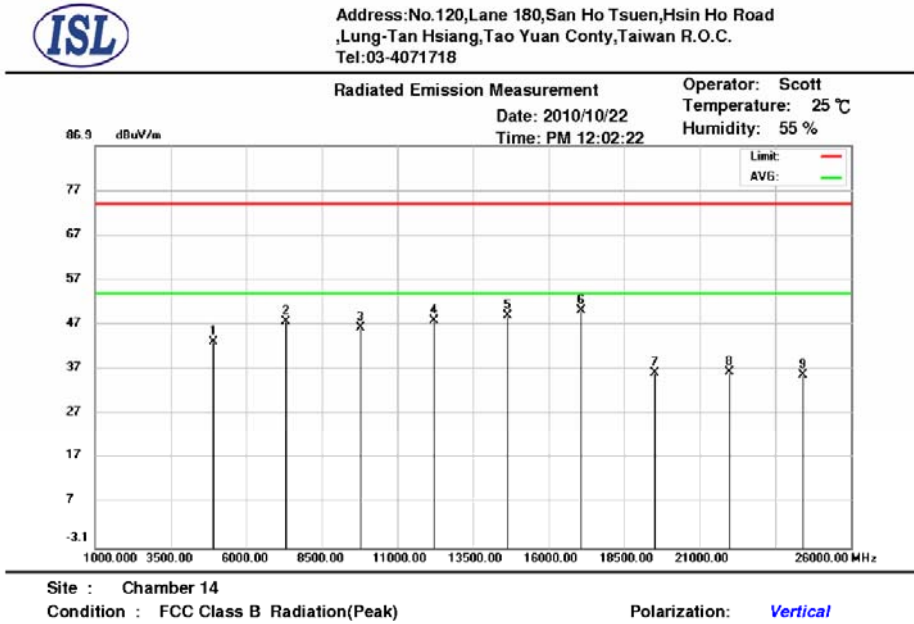

Mk.	Frequency (MHz)	RX_R (dBuV/m)	Ant_F (dB)	Cab_L (dB)	PreAmp (dB)	Emission (dBuV/m)	Limit (dBuV/m)	Margin (dB)	Ant.Pos (cm)	Tab.Pos (deg.)	Detector
1	4878.000	52.52	34.62	3.45	47.35	43.24	74.00	-30.76	100	238	peak
2	7317.000	53.62	36.01	4.23	46.25	47.61	74.00	-26.39	196	173	peak
3	9756.000	47.60	37.26	4.95	43.5	46.31	74.00	-27.69	163	169	peak
4	12195.000	46.31	39.34	5.64	43.5	47.79	74.00	-26.21	252	243	peak
5	14634.000	49.73	40.01	6.05	46.78	49.01	74.00	-24.99	100	51	peak
6	17073.000	47.87	41.98	6.73	46.52	50.06	74.00	-23.94	102	106	peak
7	19512.000	54.70	23.9	5.7	48.19	36.11	74.00	-37.89	144	302	peak
8	21951.000	51.85	24.41	6.09	45.86	36.49	74.00	-37.51	276	13	peak
9	24390.000	49.74	24.7	6.48	45.1	35.82	74.00	-38.18	179	163	peak

! : Maximum data    x : Over limit    ! : over margin

Note:

- According to the standards used, where limits are specified by agencies for both average and peak (or quasi-peak) detection, if the peak (or quasi-peak) measured value complies with the average limit, it is unnecessary to perform an average measurement.
- “peak”: peak mode; “avg”: average mode
- The Spectrum noise level+Correction Factor < Limit - 6 dB
- Margin=Corrected Amplitude – Limit
- Corrected Amplitude=Radiated Amplitude+Antenna Correction Factor+Cable Loss-Pre-Amplifier Gain
- A margin of -8dB means that the emission is 8dB below the limit.

**All frequencies from 1GHz to 25 GHz have been tested.**



1GHz~ 25 GHz (Horizontal), Highest Channel

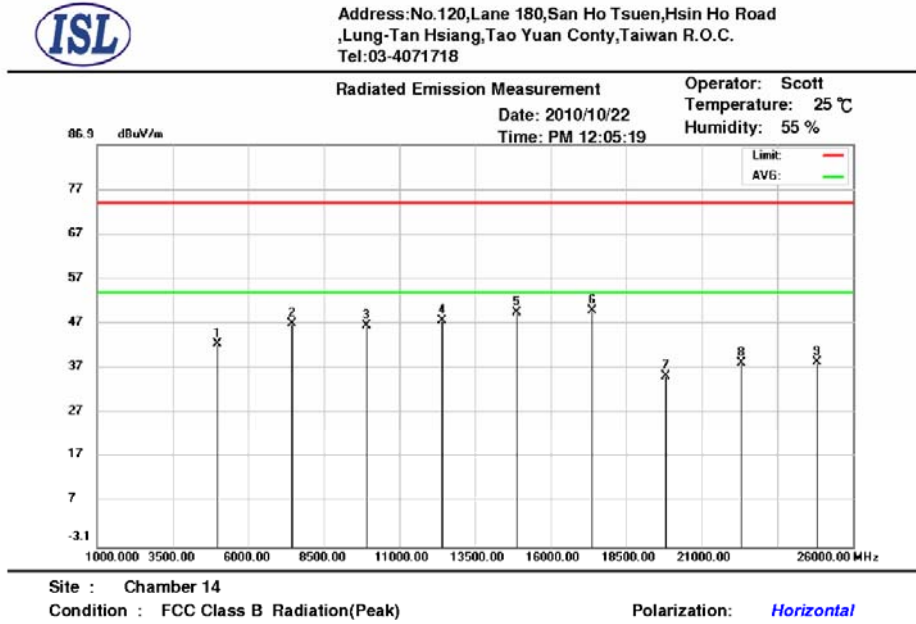

Mk.	Frequency (MHz)	RX_R (dBuV/m)	Ant_F (dB)	Cab_L (dB)	PreAmp (dB)	Emission (dBuV/m)	Limit (dBuV/m)	Margin (dB)	Ant.Pos (cm)	Tab.Pos (deg.)	Detector
1	4958.000	51.82	34.61	3.48	47.38	42.53	74.00	-31.47	144	152	peak
2	7437.000	52.96	35.94	4.27	46.15	47.02	74.00	-26.98	184	1	peak
3	9916.000	47.62	37.42	4.98	43.43	46.59	74.00	-27.41	337	182	peak
4	12395.000	46.33	39.38	5.68	43.7	47.69	74.00	-26.31	100	340	peak
5	14874.000	50.12	40.2	6.15	46.92	49.55	74.00	-24.45	106	183	peak
6	17353.000	47.27	41.54	6.84	45.85	49.80	74.00	-24.20	229	290	peak
7	19823.000	53.26	24.03	5.76	47.88	35.17	74.00	-38.83	100	325	peak
8	22311.000	53.48	24.46	6.1	45.74	38.30	74.00	-35.70	227	30	peak
9	24790.000	52.27	24.58	6.56	45.1	38.31	74.00	-35.69	100	213	peak

^:Maximum data x:Over limit !:over margin

1GHz~ 25 GHz (Vertical), Highest Channel

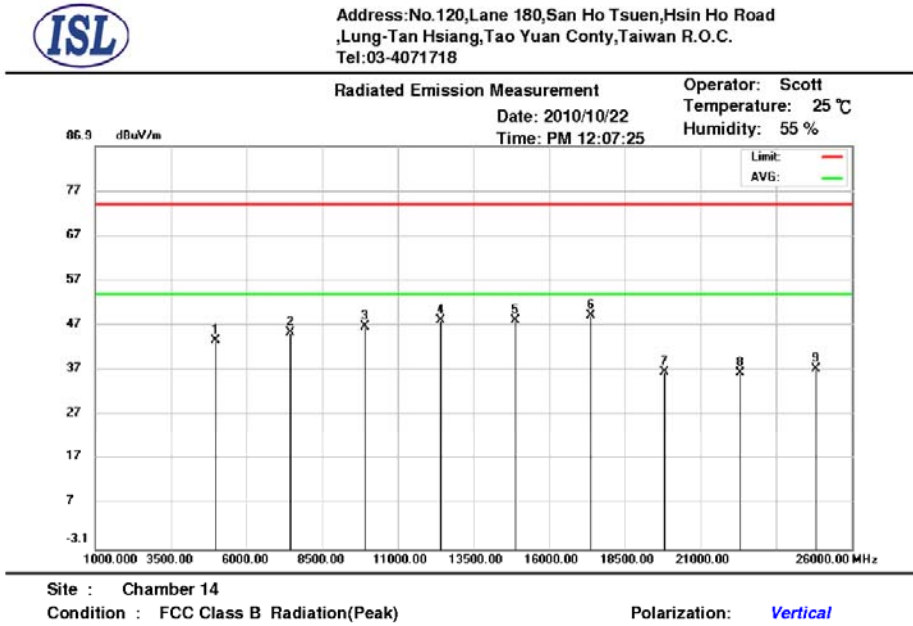

Mk.	Frequency (MHz)	RX_R (dBuV/m)	Ant F (dB)	Cab L (dB)	PreAmp (dB)	Emission (dBuV/m)	Limit (dBuV/m)	Margin (dB)	Ant.Pos (cm)	Tab.Pos (deg.)	Detector
1	4958.000	52.99	34.61	3.48	47.38	43.70	74.00	-30.30	362	63	peak
2	7437.000	51.24	35.94	4.27	46.15	45.30	74.00	-28.70	100	159	peak
3	9916.000	47.66	37.42	4.98	43.43	46.63	74.00	-27.37	306	208	peak
4	12395.000	46.68	39.38	5.68	43.7	48.04	74.00	-25.96	190	263	peak
5	14874.000	48.68	40.2	6.15	46.92	48.11	74.00	-25.89	100	274	peak
6	17353.000	46.67	41.54	6.84	45.85	49.20	74.00	-24.80	109	346	peak
7	19823.000	54.69	24.03	5.76	47.88	36.60	74.00	-37.40	194	23	peak
8	22311.000	51.48	24.46	6.1	45.74	36.30	74.00	-37.70	379	20	peak
9	24790.000	51.34	24.58	6.56	45.1	37.38	74.00	-36.62	235	145	peak

\*:Maximum data x:Over limit !:over margin

Note:

- According to the standards used, where limits are specified by agencies for both average and peak (or quasi-peak) detection, if the peak (or quasi-peak) measured value complies with the average limit, it is unnecessary to perform an average measurement.
- “peak”: peak mode; “avg”: average mode
- The Spectrum noise level+Correction Factor < Limit - 6 dB
- Margin=Corrected Amplitude – Limit
- Corrected Amplitude=Radiated Amplitude+Antenna Correction Factor+Cable Loss-Pre-Amplifier Gain
- A margin of -8dB means that the emission is 8dB below the limit.

**All frequencies from 1GHz to 25 GHz have been tested.**

### 3.3 Band Edge & Fundamental Emission Measurement

#### 3.3.1 Test Procedure

##### Conducted

1. The transmitter output of EUT was connected to the spectrum analyzer.  
Equipment mode: Spectrum analyzer  
Detector function: Peak mode  
SPAN: 100MHz  
RBW: 100KHz  
VBW: 100KHz  
Center frequency: 2.375GHz, 2.5GHz.
2. Using Peak Search to read the peak power of Carrier frequencies after Maximum Hold function is completed
3. Find the next peak frequency outside the operation frequency band

##### Radiated

1. Antenna and Turntable test procedure same as Radiated Emission Measurement.  
Equipment mode: Spectrum analyzer  
Detector function: Peak mode  
SPAN: 100MHz  
RBW: 100KHz  
VBW: 100KHz  
Center frequency: 2.375GHz, 2.5GHz.
2. Using Peak Search to read the peak power of Carrier frequencies after Maximum Hold function is completed
3. Find the next peak frequency outside the operation frequency band

#### 3.3.2 Test Setup

##### Conducted



##### Radiated

Same as *Radiated Emission Measurement*

**3.3.3 Test Data:**

**Table: Band Edge measurement**

Conducted Test

Temperature (°C):25

Test Engineer:Scott Chien

Humidity (%):55

Channel	Frequency	Spectrum Reading	Carrier - Outsideband Limit: >20dB	Pass/Fail
	(MHz)	(dBuV)	(dB)	
01	2402.1	98.12	---	---
Outside band	2400	60.07	38.05	Pass
08	2478.94	99.6	---	---
Outside band	2483.5	53.71	45.89	Pass

Radiated Test

Temperature (°C):25

Test Engineer:Scott Chien

Humidity (%):60

Channel	Frequency	Spectrum Reading	Carrier - Outsideband Limit: >20dB	Pass/Fail
	(MHz)	(dBuV)	(dB)	
01	2402.08	58.93	---	---
Outside band	2399.9	27.76	31.17	Pass
08	2479.06	58.01	---	---
Outside band	2483.38	21.4	36.61	Pass

**Band Edge Conducted Measurement**



Date: 26.OCT.2010 15:01:05

**Band Edge Conducted Measurement**

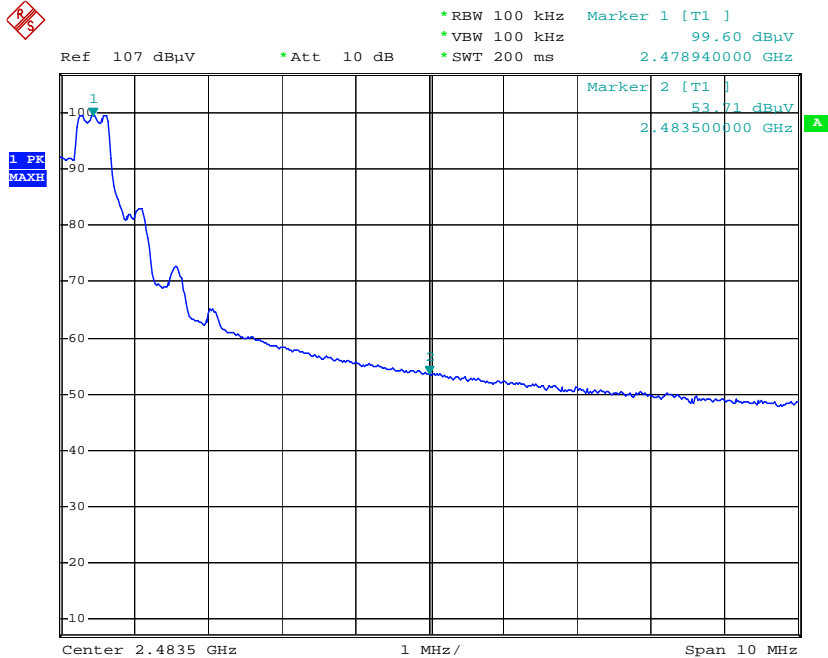

Date: 26.OCT.2010 15:02:31

**Band Edge Radiated Measurement**

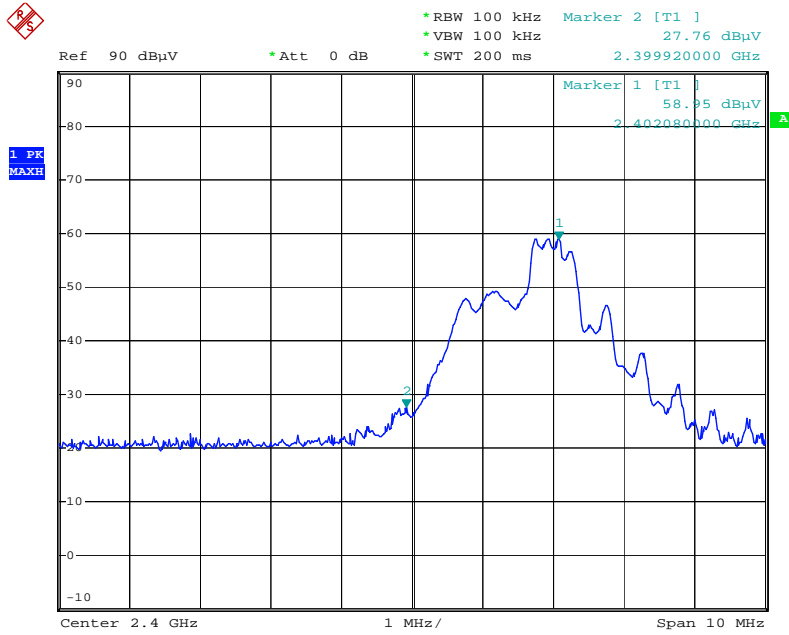

Date: 12.OCT.2010 22:59:35

**Band Edge Radiated Measurement**

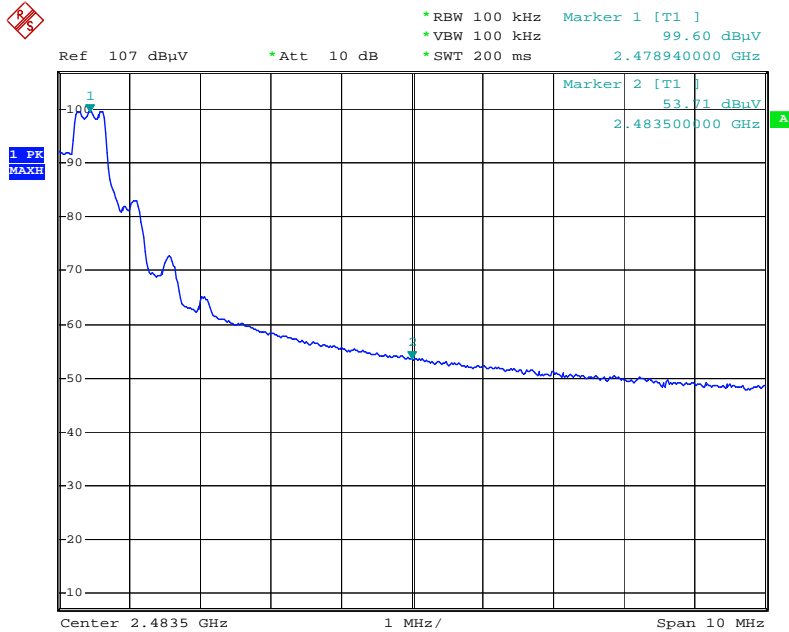

Date: 26.OCT.2010 15:02:31

### 3.4 Band Edge Restricted Bands & Fundamental Emission Measurement

#### 3.4.1 Test Procedure (Radiated & Fundamental)

1. Antenna and Turntable test procedure same as Radiated Emission Measurement.  
Equipment mode: Spectrum analyzer  
Detector function: Peak mode  
SPAN: 100MHz  
RBW: 1MHz  
VBW: 3MHz  
Center frequency: 2.39GHz, 2.4835GHz.
2. Using Peak Search to read the peak power of Carrier frequencies after Maximum Hold function is completed.
3. Find the next peak frequency outside the operation frequency band
4. For peak frequency emission level measurement in Restricted Band  
Change RBW: 1MHz  
VBW: 1KHz
5. Get the spectrum reading after Maximum Hold function is completed.

#### 3.4.2 Test Setup (Radiated & Fundamental)

Same as *Radiated Emission Measurement*

### 3.4.3 Test Data

#### Channel 1: Restricted Bands Measurement & Fundamental Emission (Radiated) (Peak)

RBW:1MHz VBW: Peak:3MH; Average:1KHz

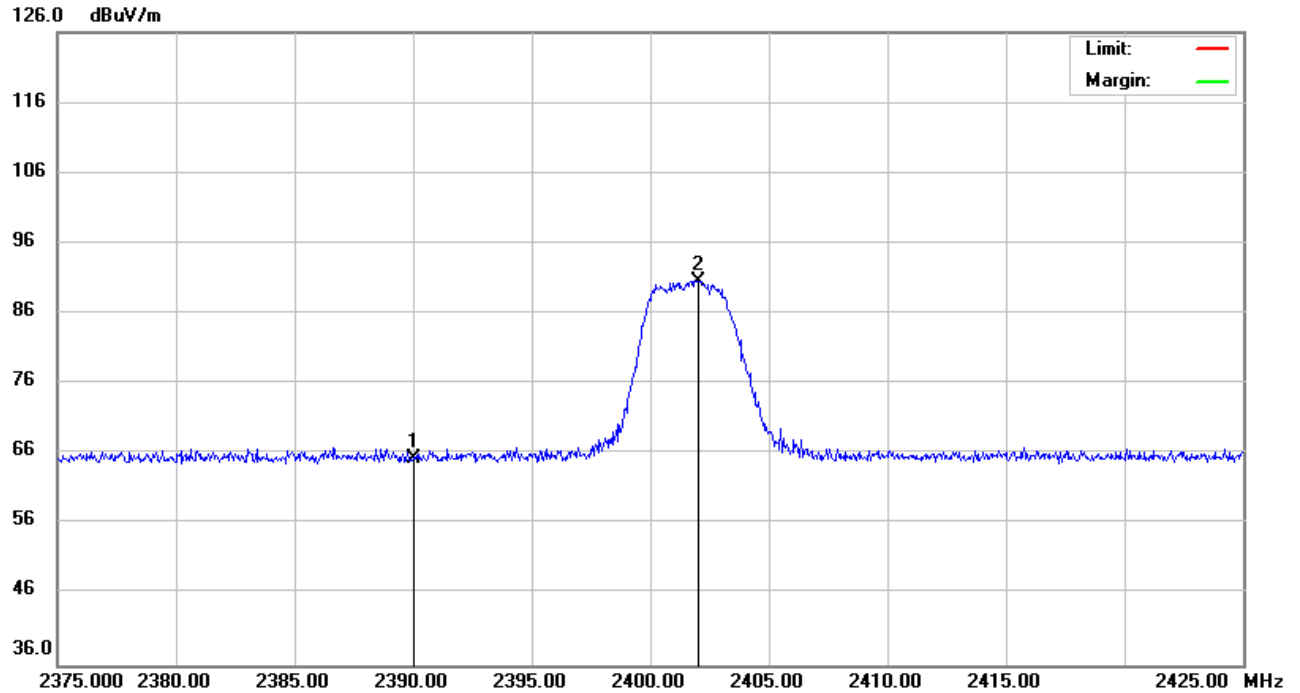

Mk.	Frequency (MHz)	RX_R (dBuV/m)	Ant_F (dB)	Cab_L (dB)	PreAmp (dB)	Emission (dBuV/m)	Limit (dBuV/m)	Margin (dB)	Description
1	2390.000	30.25	32.8	2.33	0	65.38	74	-8.62	Channel_1 Restricted band (peak mode)
2	2402.000	55.34	32.82	2.34	0	90.50	114	-23.5	Channel_1 (peak mode)

Note:

- The Spectrum noise level+Correction Factor < Limit - 6 dB
- Margin=Corrected Amplitude – Limit
- Corrected Amplitude=Radiated Amplitude+Antenna Correction Factor+Cable Loss
- A margin of -8dB means that the emission is 8dB below the limit.



**Channel 1: Restricted Bands Measurement & Fundamental Emission (Radiated) (Average)**

RBW:1MHz VBW: Peak:3MHz; Average:1KHz

126.0 dBuV/m

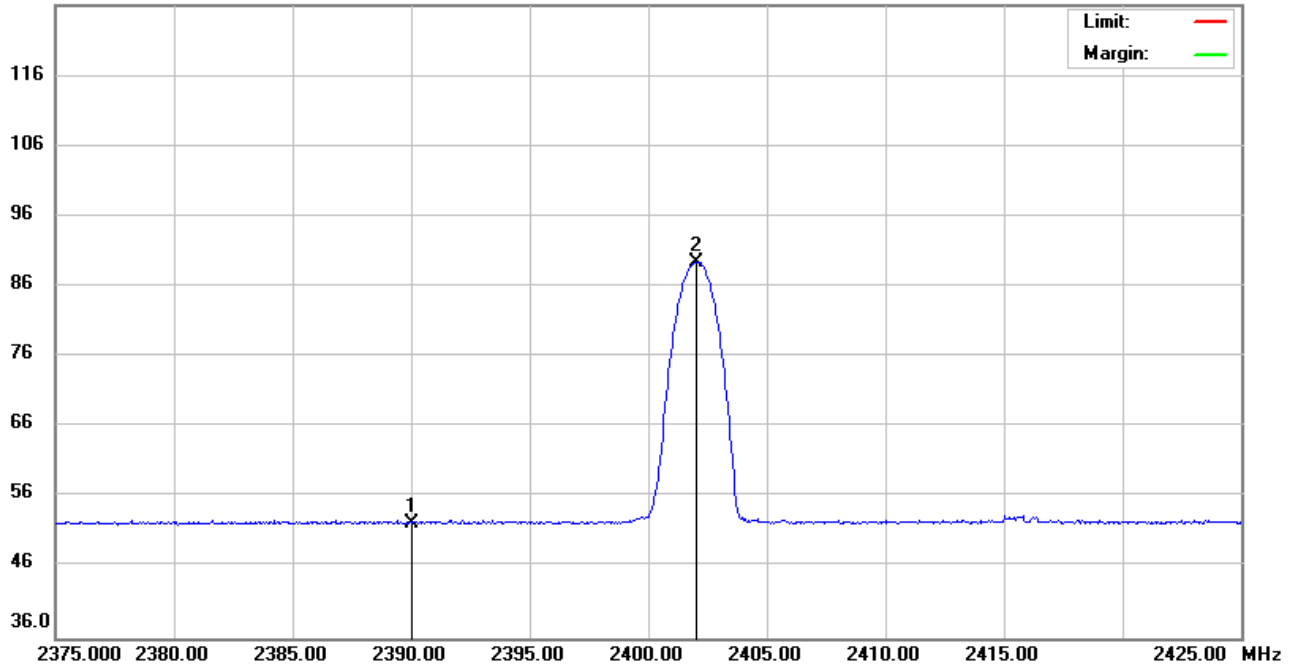

Mk.	Frequency (MHz)	RX_R (dBuV/m)	Ant_F (dB)	Cab_L (dB)	PreAmp (dB)	Emission (dBuV/m)	Limit (dBuV/m)	Margin (dB)	Description
1	2390.000	17.25	32.8	2.33	0	52.38	54	-1.62	Channel_1 Restricted band (average mode)
2	2402.000	54.31	32.82	2.34	0	89.47	94	-4.53	Channel_1 (average mode)

Note:

- The Spectrum noise level+Correction Factor < Limit - 6 dB
- Margin=Corrected Amplitude - Limit
- Corrected Amplitude=Radiated Amplitude+Antenna Correction Factor+Cable Loss
- A margin of -8dB means that the emission is 8dB below the limit

**Channel 4: Fundamental Emission (Radiated) (Peak)**

RBW:1MHz VBW: Peak:3MH; Average:1KHz

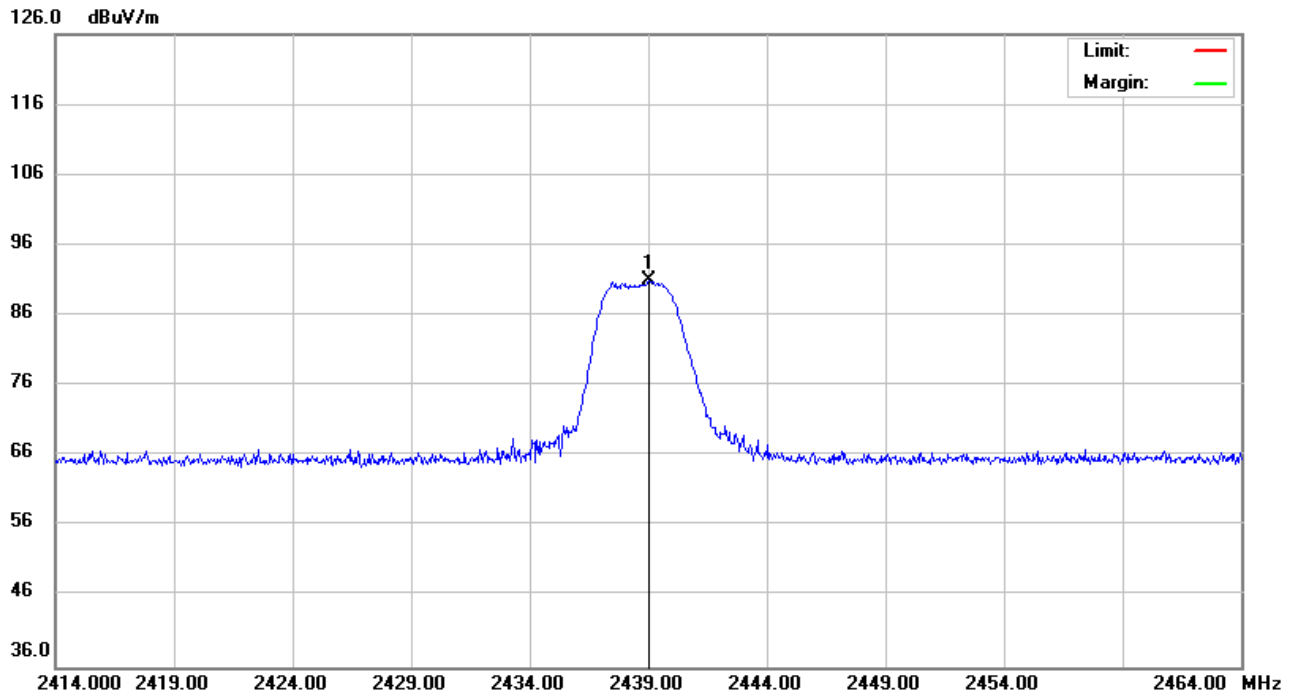

Mk.	Frequency (MHz)	RX_R (dBuV/m)	Ant_F (dB)	Cab_L (dB)	PreAmp (dB)	Emission (dBuV/m)	Limit (dBuV/m)	Margin (dB)	Description
1	2439.000	55.68	32.89	2.36	0	90.93	114	-23.07	Channel_4 (peak mode)

Note:

- The Spectrum noise level+Correction Factor < Limit - 6 dB
- Margin=Corrected Amplitude – Limit
- Corrected Amplitude=Radiated Amplitude+Antenna Correction Factor+Cable Loss
- A margin of -8dB means that the emission is 8dB below the limit

**Channel 4: Fundamental Emission (Radiated) (Average)**

RBW:1MHz VBW: Peak:3MH; Average:1KHz

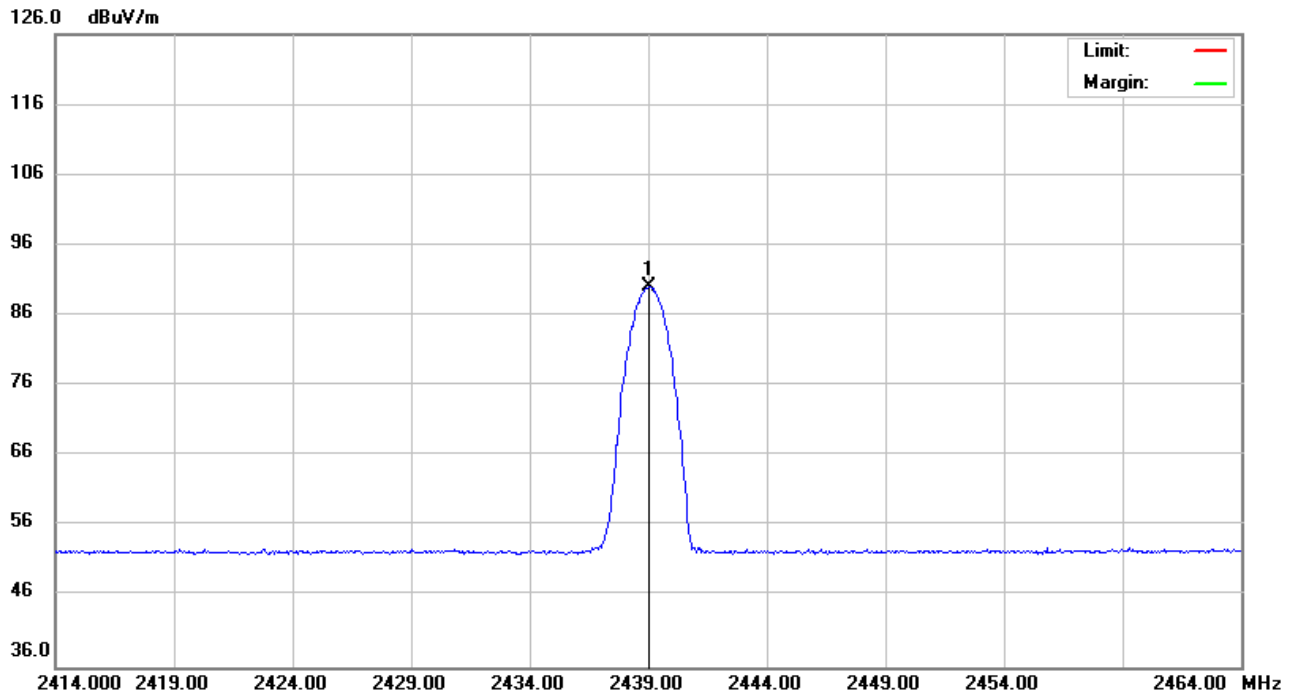

Mk.	Frequency (MHz)	RX_R (dBuV/m)	Ant_F (dB)	Cab_L (dB)	PreAmp (dB)	Emission (dBuV/m)	Limit (dBuV/m)	Margin (dB)	Description
1	2439.000	54.78	32.89	2.36	0	90.03	94	-3.97	Channel_4 (average mode)

Note:

- The Spectrum noise level+Correction Factor < Limit - 6 dB
- Margin=Corrected Amplitude - Limit
- Corrected Amplitude=Radiated Amplitude+Antenna Correction Factor+Cable Loss
- A margin of -8dB means that the emission is 8dB below the limit

**Channel 8: Restricted Bands Measurement & Fundamental Emission (Radiated) (Peak)**

RBW:1MHz VBW: Peak:3MH; Average:1KHz

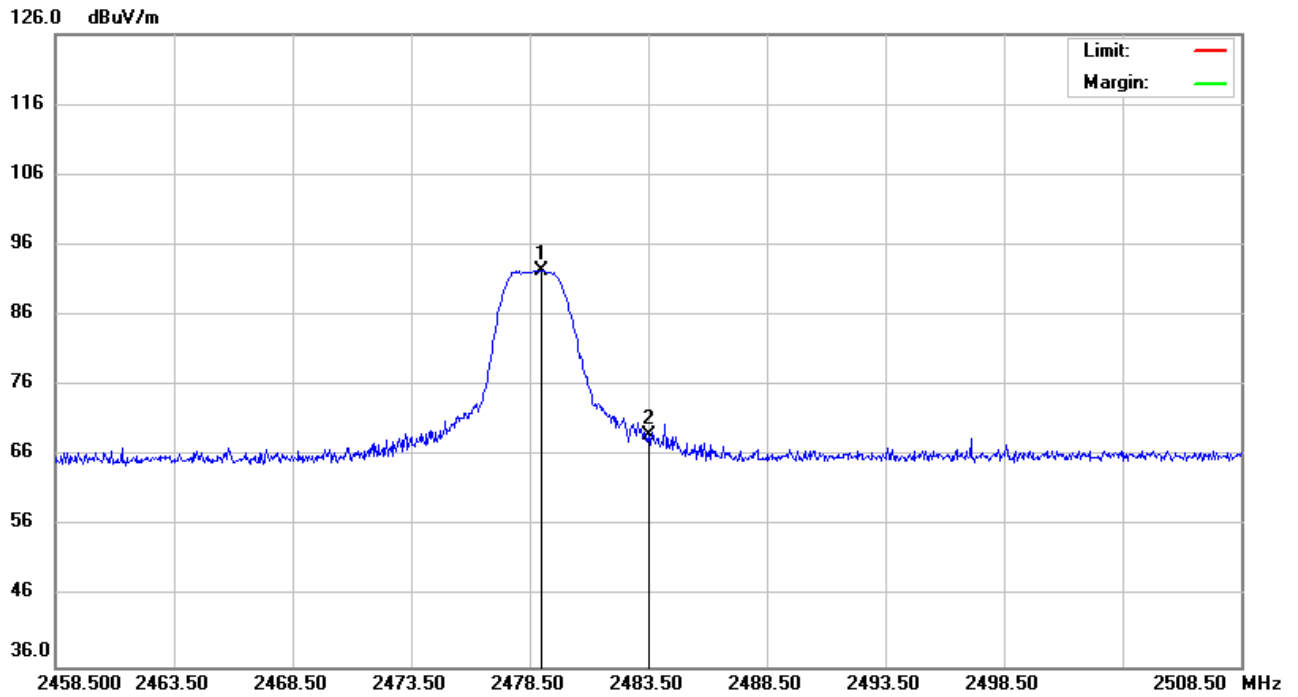

Mk.	Frequency (MHz)	RX_R (dBuV/m)	Ant_F (dB)	Cab_L (dB)	PreAmp (dB)	Emission (dBuV/m)	Limit (dBuV/m)	Margin (dB)	Description
1	2479.000	57.01	32.96	2.39	0	92.36	114	-21.64	Channel_8 (peak mode)
2	2483.500	33.51	32.97	2.39	0	68.87	74	-5.13	Channel_8 Restricted band (peak mode)

Note:

- The Spectrum noise level+Correction Factor < Limit - 6 dB
- Margin=Corrected Amplitude – Limit
- Corrected Amplitude=Radiated Amplitude+Antenna Correction Factor+Cable Loss
- A margin of -8dB means that the emission is 8dB below the limit

**Channel 8: Restricted Bands Measurement & Fundamental Emission (Radiated) (Average)**

RBW:1MHz VBW: Peak:3MHz; Average:1KHz

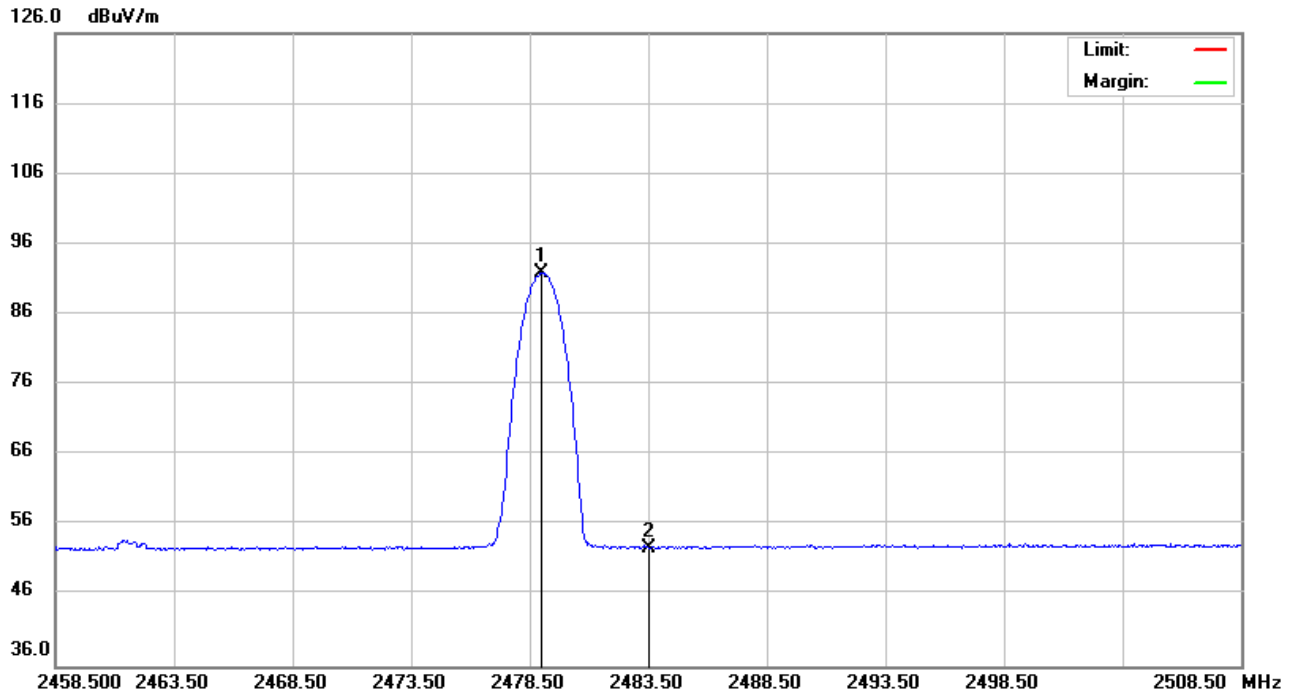

Mk.	Frequency (MHz)	RX_R (dBuV/m)	Ant_F (dB)	Cab_L (dB)	PreAmp (dB)	Emission (dBuV/m)	Limit (dBuV/m)	Margin (dB)	Description
1	2479.000	56.50	32.96	2.39	0	91.85	94	-2.15	Channel_8 (average mode)
2	2483.500	17.35	32.97	2.39	0	52.71	54	-1.29	Channel_8 Restricted band (average mode)

Note:

- The Spectrum noise level+Correction Factor < Limit - 6 dB
- Margin=Corrected Amplitude – Limit
- Corrected Amplitude=Radiated Amplitude+Antenna Correction Factor+Cable Loss
- A margin of -8dB means that the emission is 8dB below the limit

## 4. Appendix

### 4.1 Appendix A: Measurement Procedure for Power line Conducted Emissions

The measurements are performed in a 3.5m x 3.4m x 2.5m shielded room, which referred as Conduction 01 test site, or a 3m x 3m x 2.3m test site, which referred as Conduction 02 test site. The EUT was placed on non-conduction 1.0m x 1.5m table, which is 0.8 meters above an earth-grounded.

Power to the EUT was provided through the LISN which has the Impedance (50ohm/50uH) vs. Frequency Characteristic in accordance with the required standard. Power to the LISNs were filtered to eliminate ambient signal interference and these filters were bonded to the ground plane. Peripheral equipment required to provide a functional system (support equipment) for EUT testing was powered from the second LISN through a ganged, metal power outlet box which is bonded to the ground plane at the LISN.

If the EUT is supplied with a flexible power cord, the power cord length in excess of the distance separating the EUT from the LISN shall be folded back and forth at the center of the lead so as to form a bundle not exceeding 40cm in length. If the EUT is provided with a permanently coiled power cord, bundling of the cord is not required. If the EUT is supplied without a power cord, the EUT shall be connected to the LISN by a power cord of the type specified by the manufacturer which shall not be longer than 1 meter. The excess power cord shall be bundled as described above. If a non-flexible power cord is provided with the EUT, it shall be cut to the length necessary to attach the EUT to the LISN and shall not be bundled.

The interconnecting cables were arranged and moved to get the maximum emission. Both the line of power cord, hot and neutral, were measured.

The highest emissions were analyzed in details by operating the spectrum analyzer in fixed tuned mode to determine the nature of the emissions and to provide information which could be useful in reducing their amplitude.

## 4.2 Appendix B: Test Procedure for Radiated Emissions

### Preliminary Measurements in the Anechoic Chamber

The radiated emissions are initially measured in the anechoic chamber at a measurement distance of 3 meters. Desktop EUT are placed on a wooden stand 0.8 meter in height. The measurement antenna is 3 meters from the EUT. The test setup in anechoic chamber is the same as open site. The turntable rotated 360°. The antenna height is varied from 1-2.5m. The primary objective of the radiated measurements in the anechoic chamber is to identify the frequency spectrum in the absence of the electromagnetic environment existing on the open test site. The frequencies can then be pre-selected on the open test site to obtain the corresponding amplitude. The initial scan is made with the spectrum analyzer in automatic sweep mode. The spectrum peaks are then measured manually to determine the exact frequencies.

### Measurements on the Open Site or 3m EMC Chamber

The radiated emissions test will then be repeated on the open site or 3m EMC chamber to measure the amplitudes accurately and without the multiple reflections existing in the shielded room. The EUT and support equipment are set up on the turntable of one of the 3 or 10 meter open field sites. Desktop EUT are set up on a wooden stand 0.8 meter above the ground.

For the initial measurements, the receiving antenna is varied from 1-4 meter height and is changed in the vertical plane from vertical to horizontal polarization at each frequency. Both readings are recorded with the quasi-peak detector with 120KHz bandwidth. For frequency between 30 MHz and 1000MHz, the reading is recorded with peak detector or quasi-peak detector. For frequency above 1 GHz, the reading is recorded with peak detector or average detector with 1 MHz bandwidth.

At the highest amplitudes observed, the EUT is rotated in the horizontal plane while changing the antenna polarization in the vertical plane to maximize the reading. The interconnecting cables were arranged and moved to get the maximum emission. Once the maximum reading is obtained, the antenna elevation and polarization will be varied between specified limits to maximize the readings.

### 4.3 Appendix C: Test Equipment

#### 4.3.1 Test Equipment List

Location	Equipment Name	Brand	Model	S/N	Last Cal. Date	Next Cal. Date
Conduction 03	Conduction 03 -1 Cable	WOKEN	CFD 300-NL	Conduction 03 -1	06/21/2010	06/21/2011
Conduction 03	EMI Receiver 11	ROHDE & SCHWARZ	ESCI	100568	06/18/2010	06/18/2011
Conduction 03	ISNT4-02	FCC	FCC-TLISN-T 4-02	20575	05/15/2010	05/15/2011
Conduction 03	ISNT8-02	FCC	FCC-TLISN-T 8-02	20476	05/15/2010	05/15/2011
Conduction 03	LISN 07	FCC Inc.	FCC-LISN-50-100-4-02	07040	06/02/2010	06/02/2011
Conduction 03	LISN 08	FCC	FCC-LISN50-25-2-01	07039	06/25/2010	06/25/2011

Location	Equipment Name	Brand	Model	S/N	Last Cal. Date	Next Cal. Date
Chmb14						
Radiation (Chamber14)	Spectrum Analyzer 21	Agilent	N9010A	MY49060537	07/13/2010	07/13/2011
Rad. Above 1GHz (Chamber14)	Horn Antenna 06	ETS	3117	00066665	09/28/2010	09/28/2011
Rad. Above 1GHz (Chamber14)	SUCOFLEX 1GHz~26.5GHz cable	HUBER+SUHNER AG.	Sucoflex 104	286305/4	09/30/2010	09/30/2011
Rad. Above 1GHz (Chamber14)	Preamplifier 13	MITEQ	JS44-0010180 0-25-10P-44	1329256	06/10/2010	06/10/2011

Note: Calibration is traceable to NIST or national or international standards.

#### 4.3.2 Software for Controlling Spectrum/Receiver and Calculating Test Data

Radiation/Conduction	Filename	Version	Issued Date
Lung_Tan Conduction	EZ EMC	1.1.4.2	2/10/2007
Lung_Tan Radiation	EZ EMC	1.1.4.2	1/24/2007



## 4.4 Appendix D: Layout of EUT and Support Equipment

### 4.4.1 General Conducted Test Configuration

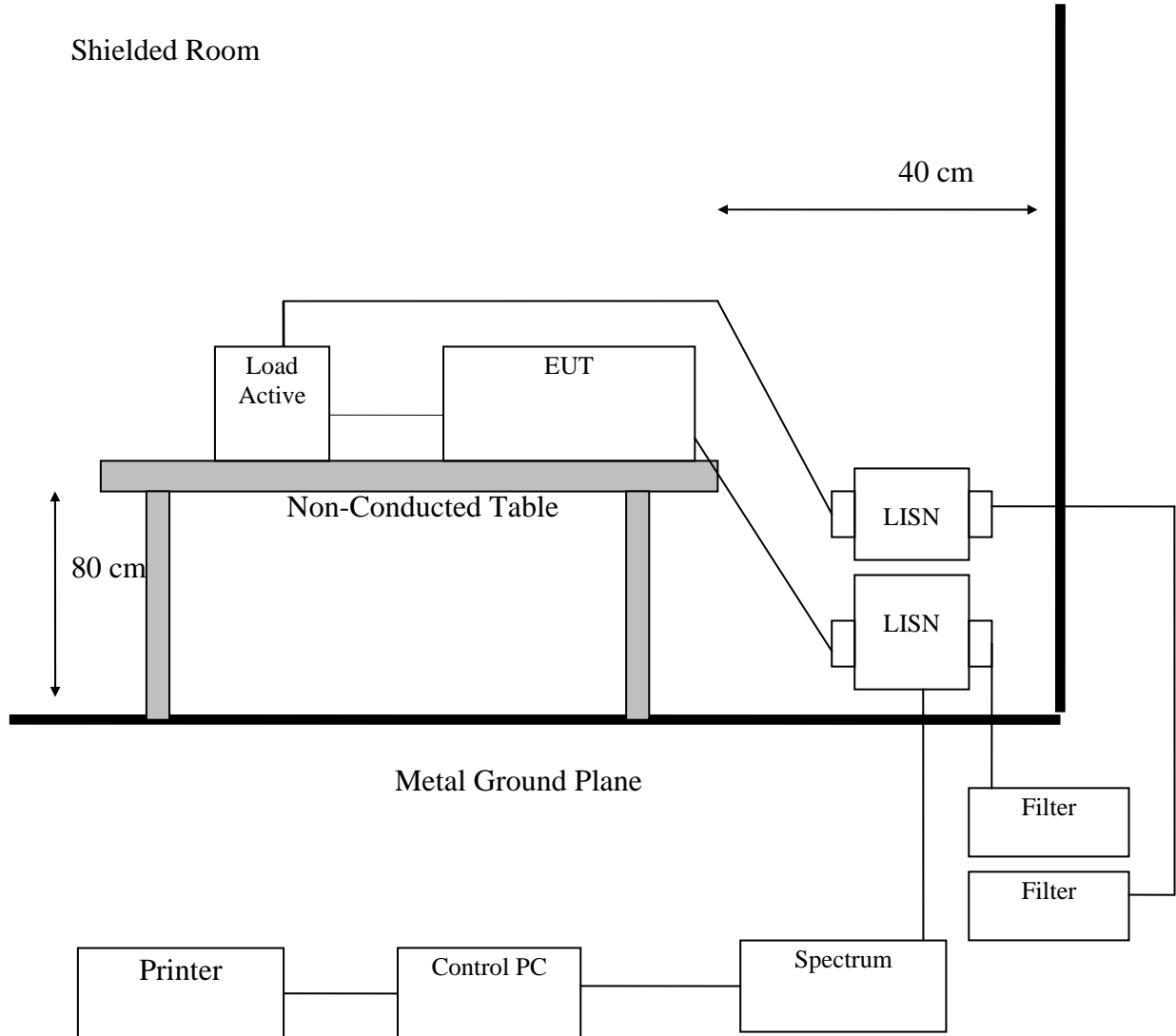

**4.4.2 General Radiation Test Configuration**

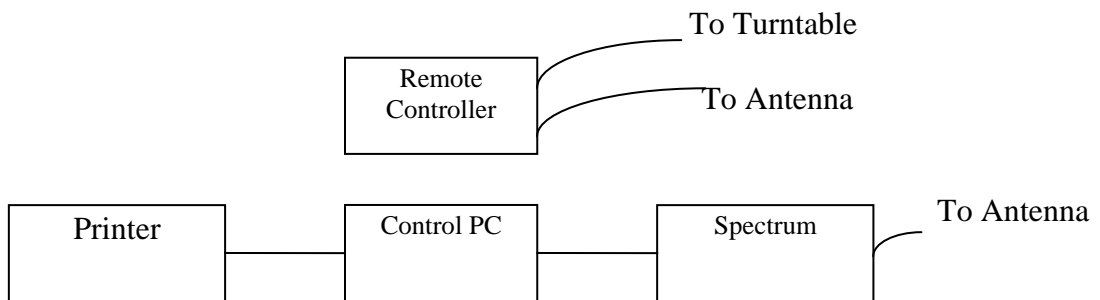
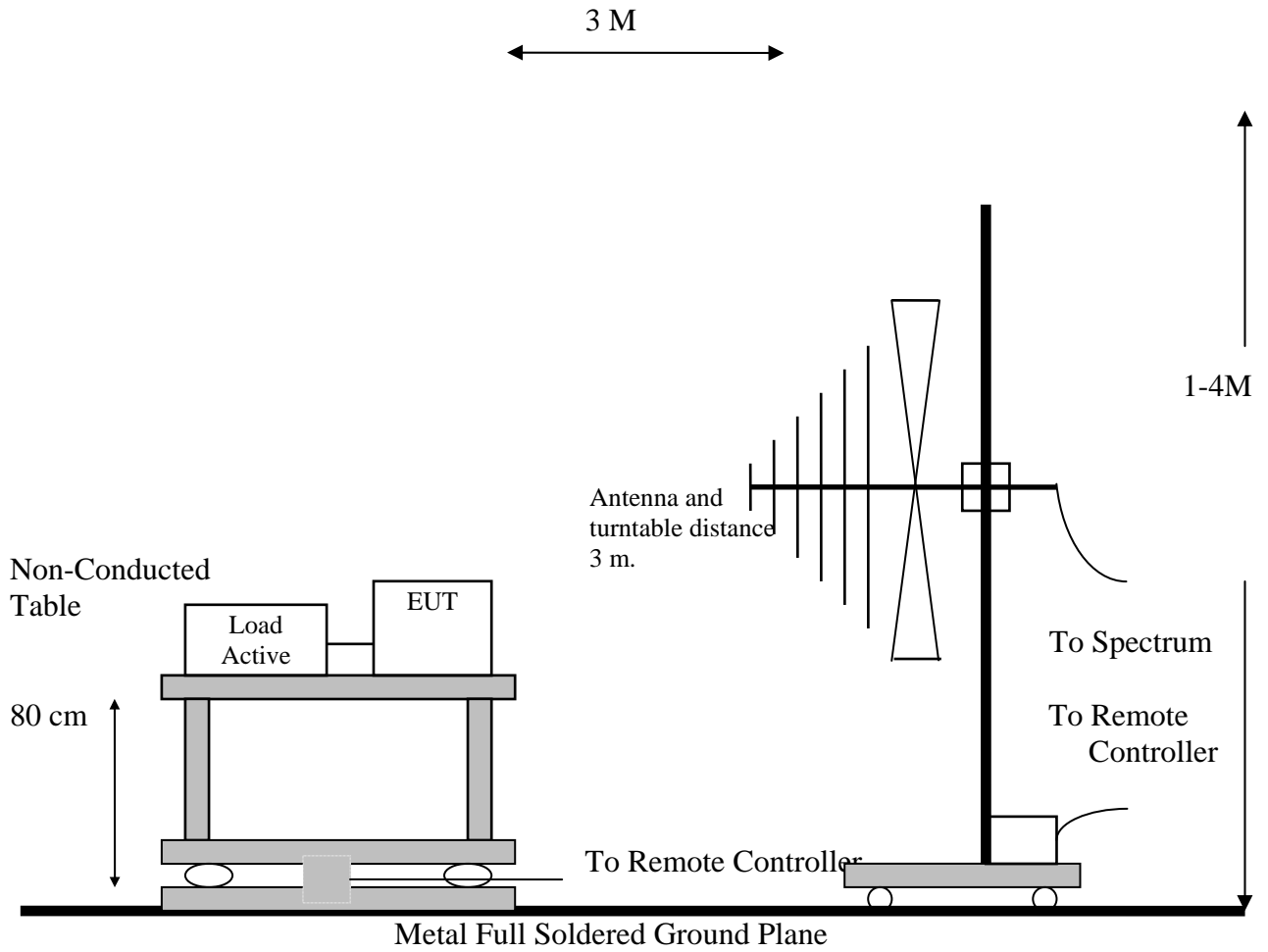

## 4.5 Appendix E: Accuracy of Measurement

The measurement uncertainty refers to CISPR 16-4-2:2003. The coverage factor  $k = 2$  yields approximately a 95 % level of confidence.

<Conduction 03>:  $\pm 3.551$  dB

<Chamber 14 (3M)>

Horizontal

30MHz~200MHz:  $\pm 4.316$  dB

200MHz~1GHz:  $\pm 4.587$  dB

Vertically

30MHz~200MHz:  $\pm 4.420$  dB

200MHz~1GHz:  $\pm 4.573$  dB

1GHz~26.5GHz  $\pm 3.722$  dB

## 4.6 Appendix F: Photographs of EUT Configuration Test Set Up

The Front View of Highest Conducted Set-up For EUT



The Back View of Highest Conducted Set-up For EUT

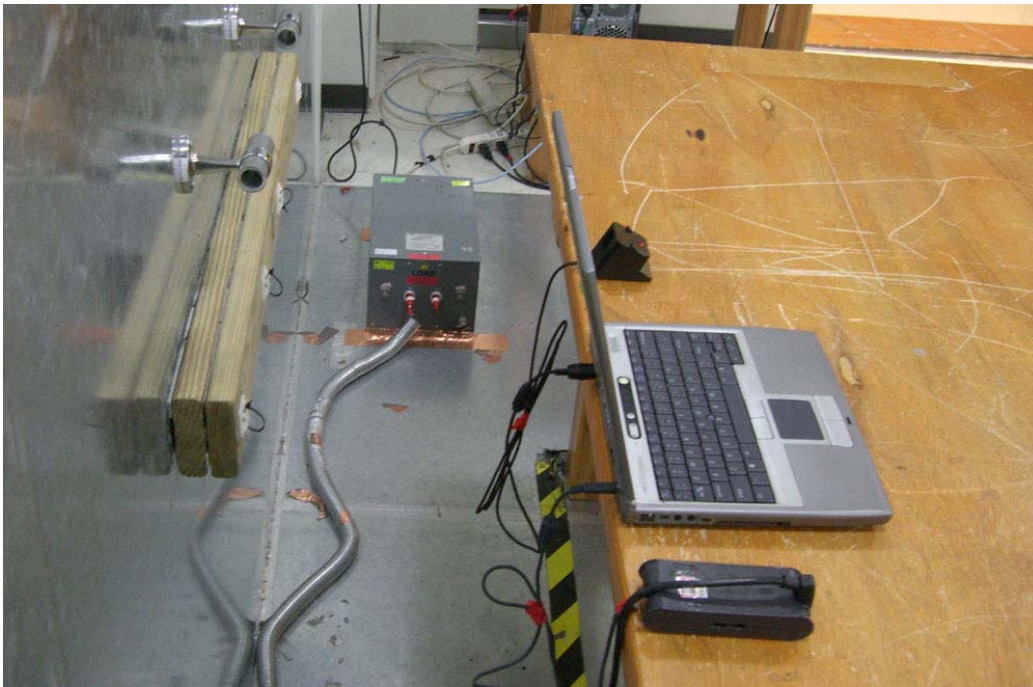



The Front View of Highest Radiated Set-up For EUT

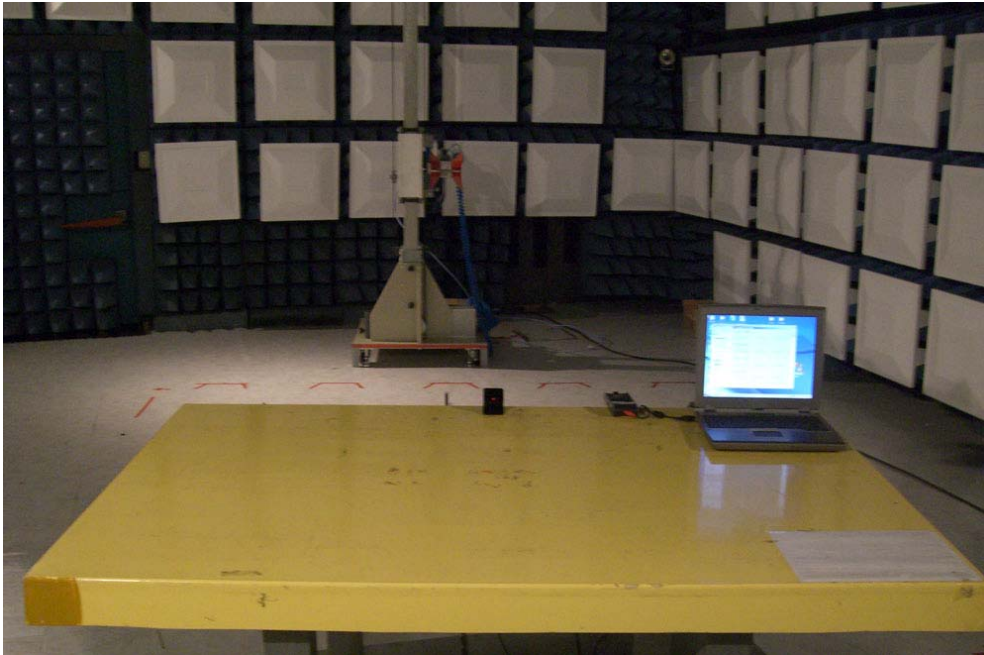

The Back View of Highest Radiated Set-up For EUT

