

## SAR Test Report

Product Name : Touch Note

Model No. : T1005, T1005M, T1005 G, T1005X, T1005C, R1002, R1003

Applicant : GIGA-BYTE TECHNOLOGY CO., LTD

Address : 5FL., No. 6, Bau Chiang Road, Hsin-Tien,  
Taipei-Hsien, Taiwan, R.O.C.

Date of Receipt : 2010/09/01

Issued Date : 2010/09/13

Report No. : 109073R-HPUSP09V01

Report Version : V1.0

The test results relate only to the samples tested.

The test report shall not be reproduced except in full without the written approval of QuieTek Corporation.

# Test Report Certification

Issued Date: 2010/09/13

Report No.:109073R-HPUSP09V01



Product Name : Touch Note  
Applicant : GIGA-BYTE TECHNOLOGY CO., LTD  
Address : 5FL., No. 6, Bau Chiang Road, Hsin-Tien, Taipei-Hsien, Taiwan, R.O.C.  
Manufacturer : GIGA-BYTE TECHNOLOGY CO., LTD  
Model No. : T1005, T1005M, T1005 G, T1005X, T1005C, R1002, R1003  
Trade Name : GIGABYTE  
FCC ID : JCK-T1005  
Applicable Standard : FCC Oet65 Supplement C June 2001  
IEEE Std. 1528-2003 47CFR § 2.1093  
Test Result : Max. SAR Measurement (1g)  
**0.165** W/kg  
Application Type : Certification

The test results relate only to the samples tested.

The test report shall not be reproduced except in full without the written approval of Quietek Corporation.

Documented By : Anny Chou  
(Adm.Assistant / Anny Chou)

Tested By : Jung Chang  
(Engineer / Jung Chang)

Approved By : Vincent Lin  
(Manager / Vincent Lin)

## TABLE OF CONTENTS

| Description   | Page      |
|---|-----------|
| <b>1. General Information.....</b>                                  | <b>5</b>  |
| 1.1 EUT Description .....   | 5         |
| 1.2 Test Environment .....  | 6         |
| <b>2. SAR Measurement System.....</b>                               | <b>7</b>  |
| 2.1 DASY5 System Description .....                                  | 7         |
| 2.1.1 Applications .....  | 8         |
| 2.1.2 Area Scans.....   | 8         |
| 2.1.3 Zoom Scan (Cube Scan Averaging).....                          | 8         |
| 2.1.4 Uncertainty of Inter-/Extrapolation and Averaging .....       | 8         |
| 2.2 DASY5 E-Field Probe .....                                       | 9         |
| 2.2.1 Isotropic E-Field Probe Specification .....                   | 9         |
| 2.3 Boundary Detection Unit and Probe Mounting Device .....         | 10        |
| 2.4 DATA Acquisition Electronics (DAE) and Measurement Server ..... | 10        |
| 2.5 Robot.....  | 11        |
| 2.6 Light Beam Unit.....  | 11        |
| 2.7 Device Holder .....   | 12        |
| 2.8 SAM Twin Phantom .....  | 12        |
| <b>3. Tissue Simulating Liquid .....</b>                            | <b>13</b> |
| 3.1 The composition of the tissue simulating liquid .....           | 13        |
| 3.2 Tissue Calibration Result .....                                 | 13        |
| 3.3 Tissue Dielectric Parameters for Head and Body Phantoms .....   | 14        |
| <b>4. SAR Measurement Procedure.....</b>                            | <b>15</b> |
| 4.1 SAR System Validation.....                                      | 15        |
| 4.1.1 Validation Dipoles.....                                       | 15        |
| 4.1.2 Validation Result .....                                       | 15        |
| 4.2 SAR Measurement Procedure.....                                  | 16        |
| <b>5. SAR Exposure Limits .....</b>                                 | <b>17</b> |
| <b>6. Test Equipment List.....</b>                                  | <b>18</b> |
| <b>7. Measurement Uncertainty.....</b>                              | <b>19</b> |
| <b>8. Peak Conducted Power Measurement .....</b>                    | <b>20</b> |
| <b>9. Test Results .....</b>  | <b>21</b> |
| 9.1 SAR Test Results Summary .....                                  | 21        |
| Appendix.....   | 22        |

Appendix A. SAR System Validation Data

Appendix B. SAR measurement Data

Appendix C. Test Setup Photographs & EUT Photographs

Appendix D. Probe Calibration Data

Appendix E. Dipole Calibration Data

## 1. General Information

### 1.1 EUT Description

|                                  |   |
|----------------------------------|---|
| Product Name                     | Touch Note  |
| Trade Name                       | GIGABYTE  |
| Model No.                        | T1005, T1005M, T1005 G, T1005X, T1005C, R1002, R1003    |
| FCC ID                           | JCK-T1005   |
| TX Frequency                     | 2412MHz ~ 2462MHz                                       |
| Number of Channel                | 11  |
| Type of Modulation               | DSSS/OFDM   |
| Antenna Type                     | PIFA  |
| Antenna Kit                      | Main: RFA-02-P24-70B-340-R,<br>Aux: RFA-02-P24-70-305-L |
| Antenna Gain                     | 0.88dBi   |
| WLAN Module                      | MFR: AzureWave, M/N: AW-NE139H                          |
| Device Category                  | Portable  |
| RF Exposure Environment          | Uncontrolled  |
| Max. Output Power<br>(Conducted) | 802.11b: 18.50 dBm<br>802.11g: 18.65 dBm                |

Note:

The test method are refer to FCC KDB 447498, KDB 616217 and KDB 248227.

## 1.2 Test Environment

Ambient conditions in the laboratory:

| Items            | Required | Actual  |
|------------------|----------|---------|
| Temperature (°C) | 18-25    | 21.7 ±2 |
| Humidity (%RH)   | 30-70    | 56      |

Site Description:

Accredited by TAF  
 Accredited Number: 0914  
 Effective through: December 12, 2011



Site Name: Quietek Corporation

Site Address: No. 5-22, Ruei-Shu Valley, Ruei-Ping Tsuen,  
 Lin-Kou Shiang, Taipei,  
 Taiwan, R.O.C.  
 TEL : 886-2-8601-3788 / FAX : 886-2-8601-3789  
 E-Mail : [service@quietek.com](mailto:service@quietek.com)

## 2. SAR Measurement System

### 2.1 DASY5 System Description

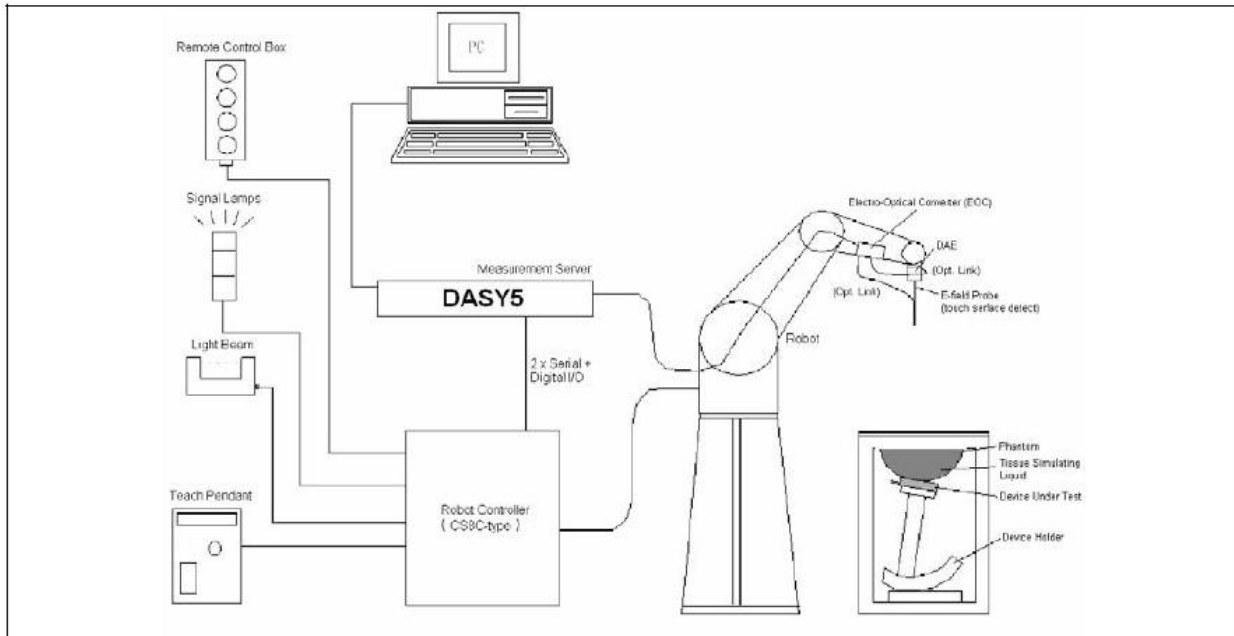

The DASY5 system for performing compliance tests consists of the following items:

- A standard high precision 6-axis robot with controller, teach pendant and software. An arm extension for accommodating the data acquisition electronics (DAE).
- A data acquisition electronics (DAE) which performs the signal amplification, signal multiplexing, AD-conversion, offset measurements, mechanical surface detection, collision detection, etc. The unit is battery powered with standard or rechargeable batteries. The signal is optically transmitted to the EOC.
- The Electro-optical converter (EOC) performs the conversion from optical to electrical signals for the digital communication to the DAE. To use optical surface detection, a special version of the EOC is required. The EOC signal is transmitted to the measurement server.
- The Light Beam used is for probe alignment. This improves the (absolute) accuracy of the probe positioning.
- A computer running WinXP and the DASY5 software.
- Remote control and teach pendant as well as additional circuitry for robot safety such as warning lamps, etc.
- The phantom, the device holder and other accessories according to the targeted measurement.

**2.1.1 Applications**

Predefined procedures and evaluations for automated compliance testing with all worldwide standards, e.g., IEEE 1528, OET 65, IEC 62209-1, IEC 62209-2, EN 50360, EN 50383 and others.

**2.1.2 Area Scans**

Area scans are defined prior to the measurement process being executed with a user defined variable spacing between each measurement point (integral) allowing low uncertainty measurements to be conducted. Scans defined for FCC applications utilize a 10mm<sup>2</sup> step integral, with 1mm interpolation used to locate the peak SAR area used for zoom scan assessments.

When an Area Scan has measured all reachable points, it computes the field maxima found in the scanned area, within a range of the global maximum. The range (in dB) is specified in the standards for compliance testing. For example, a 2 dB range is required in IEEE 1528-2003, EN 50361 and IEC 62209 standards, whereby 3 dB is a requirement when compliance is assessed in accordance with the ARIB standard (Japan).

**2.1.3 Zoom Scan (Cube Scan Averaging)**

Zoom Scans are used to assess the peak spatial SAR values within a cubic averaging volume containing 1 g and 10 g of simulated tissue. A density of 1000 kg/m<sup>3</sup> is used to represent the head and body tissue density and not the phantom liquid density, in order to be consistent with the definition of the liquid dielectric properties, i.e. the side length of the 1 g cube is 10mm, with the side length of the 10 g cube 21,5mm.

The zoom scan integer steps can be user defined so as to reduce uncertainty, but normal practice for typical test applications (including FCC) utilize a physical step of 5x5x7 (8mmx8mmx5mm) providing a volume of 32mm in the X & Y axis, and 30mm in the Z axis.

**2.1.4 Uncertainty of Inter-/Extrapolation and Averaging**

In order to evaluate the uncertainty of the interpolation, extrapolation and averaged SAR calculation algorithms of the Postprocessor, DASY5 allows the generation of measurement grids which are artificially predefined by analytically based test functions. Therefore, the grids of area scans and zoom scans can be filled with uncertainty test data, according to the SAR benchmark functions of IEEE 1528. The three analytical functions shown in equations as below are used to describe the possible range of the expected SAR distributions for the tested handsets. The field gradients are covered by the spatially flat



distribution f1, the spatially steep distribution f3 and f2 accounts for H-field cancellation on the phantom/tissue surface.

$$f_1(x, y, z) = Ae^{-\frac{z}{2a}} \cos^2 \left( \frac{\pi \sqrt{x'^2 + y'^2}}{5a} \right)$$

$$f_2(x, y, z) = Ae^{-\frac{z}{a}} \frac{a^2}{a^2 + x'^2} \left( 3 - e^{-\frac{2z}{a}} \right) \cos^2 \left( \frac{\pi y'}{2 \cdot 3a} \right)$$

$$f_3(x, y, z) = A \frac{a^2}{\frac{a^2}{4} + x'^2 + y'^2} \left( e^{-\frac{2z}{a}} + \frac{a^2}{2(a + 2z)^2} \right)$$

**2.2 DASY5 E-Field Probe**

The SAR measurement is conducted with the dosimetric probe manufactured by SPEAG. The probe is specially designed and calibrated for use in liquid with high permittivity. The dosimetric probe has special calibration in liquid at different frequency. SPEAG conducts the probe calibration in compliance with international and national standards (e.g. IEEE 1528, EN 62209-1, IEC 62209, etc.) under ISO 17025. The calibration data are in Appendix D.

**2.2.1 Isotropic E-Field Probe Specification**

|                      |  |   |
|----------------------|--|---|
| <b>Model</b>         | Ex3DV4   |   |
| <b>Construction</b>  | Symmetrical design with triangular core Built-in shielding against static charges PEEK enclosure material (resistant to organic solvents, e.g., DGBE)  |   |
| <b>Frequency</b>     | 10 MHz to 6 GHz<br>Linearity: ± 0.2 dB (30 MHz to 6 GHz)   |  |
| <b>Directivity</b>   | ± 0.3 dB in HSL (rotation around probe axis)<br>± 0.5 dB in tissue material (rotation normal to probe axis)  |   |
| <b>Dynamic Range</b> | 10 µW/g to 100 mW/g<br>Linearity: ± 0.2 dB (noise: typically < 1 µW/g)   |   |
| <b>Dimensions</b>    | Overall length: 330 mm (Tip: 20 mm)<br>Tip diameter: 2.5 mm (Body: 12 mm)<br>Typical distance from probe tip to dipole centers: 1 mm   |   |
| <b>Application</b>   | High precision dosimetric measurements in any exposure scenario (e.g., very strong gradient fields). Only probe which enables compliance testing for frequencies up to 6 GHz with precision of better 30%. |   |

**2.3 Boundary Detection Unit and Probe Mounting Device**

The DASY probes use a precise connector and an additional holder for the probe, consisting of a plastic tube and a flexible silicon ring to center the probe. The connector at the DAE is flexibly mounted and held in the default position with magnets and springs. Two switching systems in the connector mount detect frontal and lateral probe collisions and trigger the necessary software response.



**2.4 DATA Acquisition Electronics (DAE) and Measurement Server**

The data acquisition electronics (DAE) consists of a highly sensitive electrometer-grade preamplifier with auto-zeroing, a channel and gain-switching multiplexer, a fast 16 bit AD-converter and a command decoder and control logic unit.

Transmission to the measurement server is accomplished through an optical downlink for data and status information as well as an optical uplink for commands and the clock.

The input impedance of the DAE4 is 200M Ohm; the inputs are symmetrical and floating. Common mode rejection is above 80dB.



The DASY5 measurement server is based on a PC/104 CPU board with a 400MHz intel ULV Celeron, 128MB chipdisk and 128MB RAM. The necessary circuits for communication with the DAE electronics box, as well as the 16 bit AD converter system for optical detection and digital I/O interface are contained on the DASY5 I/O board, which is directly connected to the PC/104 bus of the CPU board.



## 2.5 Robot

The DASY5 system uses the high precision robots TX90 XL type out of the newer series from Stäubli SA (France). For the 6-axis controller DASY5 system, the CS8C robot controller version from Stäubli is used.

The XL robot series have many features that are important for our application:

- High precision (repeatability 0.02 mm)
- High reliability (industrial design)
- Jerk-free straight movements
- Low ELF interference (the closed metallic construction shields against motor control fields)
- 6-axis controller



## 2.6 Light Beam Unit

The light beam switch allows automatic "tooling" of the probe. During the process, the actual position of the probe tip with respect to the robot arm is measured, as well as the probe length and the horizontal probe offset. The software then corrects all movements, such that the robot coordinates are valid for the probe tip.

The repeatability of this process is better than 0.1 mm. If a position has been taught with an aligned probe, the same position will be reached with another aligned probe within 0.1 mm, even if the other probe has different dimensions. During probe rotations, the probe tip will keep its actual position.



**2.7 Device Holder**

The DASY5 device holder is designed to cope with different positions given in the standard. It has two scales for the device rotation (with respect to the body axis) and the device inclination (with respect to the line between the ear reference points). The rotation center for both scales is the ear reference point (EPR).

Thus the device needs no repositioning when changing the angles.

The DASY5 device holder has been made out of low-loss POM material having the following dielectric parameters: relative permittivity  $\epsilon_r = 3$  and loss tangent  $\delta = 0.02$ . The amount of dielectric material has been reduced in the closest vicinity of the device, since measurements have suggested that the influence of the clamp on the test results could thus be lowered.



**2.8 SAM Twin Phantom**

The SAM twin phantom is a fiberglass shell phantom with 2mm shell thickness (except the ear region where shell thickness increases to 6mm). It has three measurement areas:

- Left head
- Right head
- Flat phantom



The bottom plate contains three pair of bolts for locking the device holder. The device holder positions are adjusted to the standard measurement positions in the three sections. A white cover is provided to tap the phantom during off-periods to prevent water evaporation and changes in the liquid parameters. On the phantom top, three reference markers are provided to identify the phantom position with respect to the robot.

**3. Tissue Simulating Liquid**

**3.1 The composition of the tissue simulating liquid**

| INGREDIENT<br>(% Weight) | 900MHz<br>Head | 1800MHz<br>Head | 2450MHz<br>Head | 2450MHz<br>Body |
|--------------------------|----------------|-----------------|-----------------|-----------------|
| <b>Water</b>             | --             | --              | --              | 73.2            |
| <b>Salt</b>              | --             | --              | --              | 0.04            |
| <b>Sugar</b>             | --             | --              | --              | 0.00            |
| <b>HEC</b>               | --             | --              | --              | 0.00            |
| <b>Preventol</b>         | --             | --              | --              | 0.00            |
| <b>DGBE</b>              | --             | --              | --              | 26.7            |

**3.2 Tissue Calibration Result**

The dielectric parameters of the liquids were verified prior to the SAR evaluation using APREL Dielectric Probe Kit and Anritsu MS4623B Vector Network Analyzer.

| <b>Body Tissue Simulant Measurement</b> |                                 |                          |                        |                      |
|---|---------------------------------|--------------------------|------------------------|----------------------|
| Frequency<br>[MHz]                      | Description                     | Dielectric Parameters    |                        | Tissue Temp.<br>[°C] |
|   |                                 | $\epsilon_r$             | $\sigma$ [s/m]         |                      |
| 2450MHz                                 | Reference result<br>± 5% window | 52.7<br>50.065 to 55.335 | 1.95<br>1.852 to 2.047 | N/A                  |
|   | 10-Sep-10                       | 53.01                    | 1.92                   | 20.5                 |
| 2412 MHz                                | Low channel                     | 54.18                    | 1.88                   | 20.5                 |
| 2437 MHz                                | Mid channel                     | 53.26                    | 1.91                   | 20.5                 |
| 2462 MHz                                | High channel                    | 52.30                    | 1.95                   | 20.5                 |

**3.3 Tissue Dielectric Parameters for Head and Body Phantoms**

The head tissue dielectric parameters recommended by the IEEE SCC-34/SC-2 in P1528 have been incorporated in the following table. These head parameters are derived from planar layer models simulating the highest expected SAR for the dielectric properties and tissue thickness variations in a human head. Other head and body tissue parameters that have not been specified in P1528 are derived from the tissue dielectric parameters computed from the 4-Cole-Cole equations described in Reference [12] and extrapolated according to the head parameters specified in P1528.

| Target Frequency<br>(MHz) | Head         |                | Body         |                |
|---------------------------|--------------|----------------|--------------|----------------|
|                           | $\epsilon_r$ | $\sigma$ (S/m) | $\epsilon_r$ | $\sigma$ (S/m) |
| 150                       | 52.3         | 0.76           | 61.9         | 0.80           |
| 300                       | 45.3         | 0.87           | 58.2         | 0.92           |
| 450                       | 43.5         | 0.87           | 56.7         | 0.94           |
| 835                       | 41.5         | 0.90           | 55.2         | 0.97           |
| 900                       | 41.5         | 0.97           | 55.0         | 1.05           |
| 915                       | 41.5         | 0.98           | 55.0         | 1.06           |
| 1450                      | 40.5         | 1.20           | 54.0         | 1.30           |
| 1610                      | 40.3         | 1.29           | 53.8         | 1.40           |
| 1800 – 2000               | 40.0         | 1.40           | 53.3         | 1.52           |
| 2450                      | 39.2         | 1.80           | 52.7         | 1.95           |
| 3000                      | 38.5         | 2.40           | 52.0         | 2.73           |
| 5800                      | 35.3         | 5.27           | 48.2         | 6.00           |

( $\epsilon_r$  = relative permittivity,  $\sigma$  = conductivity and  $\rho = 1000 \text{ kg/m}^3$ )

## 4. SAR Measurement Procedure

### 4.1 SAR System Validation

#### 4.1.1 Validation Dipoles

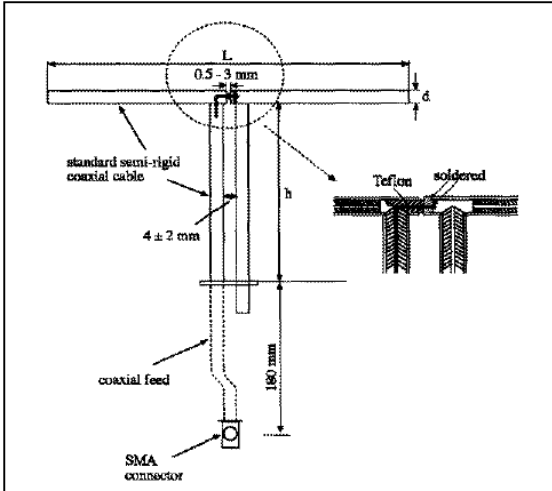

The dipoles used is based on the IEEE-1528 standard, and is complied with mechanical and electrical specifications in line with the requirements of both IEEE and FCC Supplement C. the table below provides details for the mechanical and electrical specifications for the dipoles.

| Frequency | L (mm) | h (mm) | d (mm) |
|-----------|--------|--------|--------|
| 2450MHz   | 53.5   | 30.4   | 3.6    |

#### 4.1.2 Validation Result

| System Performance Check at 2450MHz |                               |                           |                           |                   |
|-------------------------------------|-------------------------------|---------------------------|---------------------------|-------------------|
| Validation Kit: ASL-D-2450-S-2      |                               |                           |                           |                   |
| Frequency [MHz]                     | Description                   | SAR [w/kg] 1g             | SAR [w/kg] 10g            | Tissue Temp. [°C] |
| 2450 MHz                            | Reference result ± 10% window | 48.07<br>43.263 to 52.877 | 25.65<br>23.085 to 28.215 | N/A               |
|                                     | 10-Sep-10                     | 54                        | 24.52                     | 20.5              |

Note: (1) All SAR values are normalized to 1W forward power.  
 (2) The power level is used 250mW

**4.2 SAR Measurement Procedure**

The ALSAS-10U calculates SAR using the following equation,

$$SAR = \frac{\sigma |E|^2}{\rho}$$

$\sigma$ : represents the simulated tissue conductivity

$\rho$ : represents the tissue density

The EUT is set to transmit at the required power in line with product specification, at each frequency relating to the LOW, MID, and HIGH channel settings.

Pre-scans are made on the device to establish the location for the transmitting antenna, using a large area scan in either air or tissue simulation fluid.

The EUT is placed against the Universal Phantom where the maximum area scan dimensions are larger than the physical size of the resonating antenna. When the scan size is not large enough to cover the peak SAR distribution, it is modified by either extending the area scan size in both the X and Y directions, or the device is shifted within the predefined area.

The area scan is then run to establish the peak SAR location (interpolated resolution set at 1mm<sup>2</sup> )which is then used to orient the center of the zoom scan. The zoom scan is then executed and the 1g and 10g averages are derived from the zoom scan volume (interpolated resolution set at 1mm<sup>3</sup> ).



**5. SAR Exposure Limits**

SAR assessments have been made in line with the requirements of IEEE-1528, FCC Supplement C, and comply with ANSI/IEEE C95.1-1992 “Uncontrolled Environments” limits. These limits apply to a location which is deemed as “Uncontrolled Environment” which can be described as a situation where the general public may be exposed to an RF source with no prior knowledge or control over their exposure.

**Limits for General Population/Uncontrolled Exposure (W/kg)**

| <b>Type Exposure</b>                                     | <b>Uncontrolled Environment Limit</b> |
|--|---------------------------------------|
| Spatial Peak SAR (1g cube tissue for brain or body)      | <b>1.60 W/kg</b>                      |
| Spatial Average SAR (whole body)                         | <b>0.08 W/kg</b>                      |
| Spatial Peak SAR (10g for hands, feet, ankles and wrist) | <b>4.00 W/kg</b>                      |

## 6. Test Equipment List

| Instrument                                | Manufacturer | Model No.    | Serial No.     | Last Calibration | Next Calibration |
|---|--------------|--------------|----------------|------------------|------------------|
| Stäubli Robot TX60L                       | Stäubli      | TX60L        | F09/5BL1A1/A06 | May. 2009        | only once        |
| Controller                                | Speag        | CS8c         | N/A            | May. 2009        | only once        |
| Aprél Reference Dipole<br>2450MHz         | Aprél        | ALS-D-2450   | QTK-319        | May. 2010        | May. 2012        |
| SAM Twin Phantom                          | Speag        | QD000 P40 CA | Tp 1515        | N/A              | N/A              |
| Device Holder                             | Speag        | N/A          | N/A            | N/A              | N/A              |
| Data Acquisition Electronic               | Speag        | DAE4         | 1207           | Apr. 2010        | Apr. 2011        |
| E-Field Probe                             | Speag        | EX3DV4       | 3698           | July. 2010       | July. 2011       |
| SAR Software                              | Speag        | DASY52       | V52.2 Build 0  | N/A              | N/A              |
| Aprél Dipole Spaccer                      | Aprél        | ALS-DS-U     | QTK-295        | N/A              | N/A              |
| Power Amplifier                           | Mini-Circuit | ZHL-42       | D051404-20     | N/A              | N/A              |
| Directional Coupler                       | Agilent      | 778D-012     | 50550          | N/A              | N/A              |
| Universal<br>RadioCommunication<br>Tester | R&S          | CMU 200      | 104846         | May. 2010        | May. 2011        |
| Vector Network                            | Anritsu      | MS4623B      | 992801         | Aug. 2010        | Aug. 2011        |
| Signal Generator                          | Anritsu      | MG3692A      | 042319         | Jun. 2010        | Jun. 2011        |
| Power Meter                               | Anritsu      | ML2487A      | 6K00001447     | Apr. 2010        | Apr. 2011        |
| Wide Bandwidth Sensor                     | Anritsu      | MA2491       | 030677         | Apr. 2010        | Apr. 2011        |

7. Measurement Uncertainty

| Uncertainty                  |                   |             |      |              |               |                |                 |                     |
|------------------------------|-------------------|-------------|------|--------------|---------------|----------------|-----------------|---------------------|
| Error Description            | Uncertainty value | Prob. Dist. | Div. | ( $c_i$ ) 1g | ( $c_i$ ) 10g | Std. Unc. (1g) | Std. Unc. (10g) | ( $v_i$ ) $v_{eff}$ |
| <b>Measurement System</b>    |                   |             |      |              |               |                |                 |                     |
| Probe Calibration            | ±5.9 %            | N           | 1    | 1            | 1             | ±5.9 %         | ±5.9 %          | ∞                   |
| Axial Isotropy               | ±4.7 %            | R           | √3   | 0.7          | 0.7           | ±1.9 %         | ±1.9 %          | ∞                   |
| Hemispherical Isotropy       | ±9.6 %            | R           | √3   | 0.7          | 0.7           | ±3.9 %         | ±3.9 %          | ∞                   |
| Boundary Effects             | ±1.0 %            | R           | √3   | 1            | 1             | ±0.6 %         | ±0.6 %          | ∞                   |
| Linearity                    | ±4.7 %            | R           | √3   | 1            | 1             | ±2.7 %         | ±2.7 %          | ∞                   |
| System Detection Limits      | ±1.0 %            | R           | √3   | 1            | 1             | ±0.6 %         | ±0.6 %          | ∞                   |
| Readout Electronics          | ±0.3 %            | N           | 1    | 1            | 1             | ±0.3 %         | ±0.3 %          | ∞                   |
| Response Time                | ±0.8 %            | R           | √3   | 1            | 1             | ±0.5 %         | ±0.5 %          | ∞                   |
| Integration Time             | ±2.6 %            | R           | √3   | 1            | 1             | ±1.5 %         | ±1.5 %          | ∞                   |
| RF Ambient Noise             | ±3.0 %            | R           | √3   | 1            | 1             | ±1.7 %         | ±1.7 %          | ∞                   |
| RF Ambient Reflections       | ±3.0 %            | R           | √3   | 1            | 1             | ±1.7 %         | ±1.7 %          | ∞                   |
| Probe Positioner             | ±0.4 %            | R           | √3   | 1            | 1             | ±0.2 %         | ±0.2 %          | ∞                   |
| Probe Positioning            | ±2.9 %            | R           | √3   | 1            | 1             | ±1.7 %         | ±1.7 %          | ∞                   |
| Max. SAR Eval.               | ±1.0 %            | R           | √3   | 1            | 1             | ±0.6 %         | ±0.6 %          | ∞                   |
| <b>Test Sample Related</b>   |                   |             |      |              |               |                |                 |                     |
| Device Positioning           | ±2.9 %            | N           | 1    | 1            | 1             | ±2.9 %         | ±2.9 %          | 145                 |
| Device Holder                | ±3.6 %            | N           | 1    | 1            | 1             | ±3.6 %         | ±3.6 %          | 5                   |
| Power Drift                  | ±5.0 %            | R           | √3   | 1            | 1             | ±2.9 %         | ±2.9 %          | ∞                   |
| <b>Phantom and Setup</b>     |                   |             |      |              |               |                |                 |                     |
| Phantom Uncertainty          | ±4.0 %            | R           | √3   | 1            | 1             | ±2.3 %         | ±2.3 %          | ∞                   |
| Liquid Conductivity (target) | ±5.0 %            | R           | √3   | 0.64         | 0.43          | ±1.8 %         | ±1.2 %          | ∞                   |
| Liquid Conductivity (meas.)  | ±2.5 %            | N           | 1    | 0.64         | 0.43          | ±1.6 %         | ±1.1 %          | ∞                   |
| Liquid Permittivity (target) | ±5.0 %            | R           | √3   | 0.6          | 0.49          | ±1.7 %         | ±1.4 %          | ∞                   |
| Liquid Permittivity (meas.)  | ±2.5 %            | N           | 1    | 0.6          | 0.49          | ±1.5 %         | ±1.2 %          | ∞                   |
| Combined Std. Uncertainty    |                   |             |      |              |               | ±10.9 %        | ±10.7 %         | 387                 |
| Expanded STD Uncertainty     |                   |             |      |              |               | ±21.9 %        | ±21.4 %         |                     |

**8. Peak Conducted Power Measurement**

802.11 b

| Frequency (MHz) | Output Power (dBm) | Path Loss (dB) | Result (dBm) | Result (mW) |
|-----------------|--------------------|----------------|--------------|-------------|
| 2412            | 16.20              | 0.5            | 16.70        | 46.77       |
| 2437            | 18.00              | 0.5            | 18.50        | 70.79       |
| 2462            | 17.05              | 0.5            | 17.55        | 56.89       |

802.11 g

| Frequency (MHz) | Output Power (dBm) | Path Loss (dB) | Result (dBm) | Result (mW) |
|-----------------|--------------------|----------------|--------------|-------------|
| 2412            | 14.60              | 0.5            | 15.10        | 32.36       |
| 2437            | 18.15              | 0.5            | 18.65        | 73.28       |
| 2462            | 15.16              | 0.5            | 15.66        | 36.81       |

802.11n-20M

| Frequency (MHz) | Output Power (dBm) | Path Loss (dB) | Result (dBm) | Result (mW) |
|-----------------|--------------------|----------------|--------------|-------------|
| 2412            | 14.40              | 0.5            | 14.90        | 30.90       |
| 2437            | 17.75              | 0.5            | 18.25        | 66.83       |
| 2462            | 13.50              | 0.5            | 14.00        | 25.12       |

802.11n-40M

| Frequency (MHz) | Output Power (dBm) | Path Loss (dB) | Result (dBm) | Result (mW) |
|-----------------|--------------------|----------------|--------------|-------------|
| 2412            | 13.55              | 0.5            | 14.05        | 25.41       |
| 2437            | 15.83              | 0.5            | 16.33        | 42.95       |
| 2462            | 14.11              | 0.5            | 14.61        | 28.91       |

**9. Test Results**

**9.1 SAR Test Results Summary**

| SAR MEASUREMENT                           |                     |           |      |                             |                  |                 |
|---|---------------------|-----------|------|-----------------------------|------------------|-----------------|
| Ambient Temperature (°C) : 21.7 ±2        |                     |           |      | Relative Humidity (%): 56   |                  |                 |
| Liquid Temperature (°C) : 20.5 ±2         |                     |           |      | Depth of Liquid (cm):>15    |                  |                 |
| Product: Touch Note                       |                     |           |      |                             |                  |                 |
| Test Mode: 802.11g(Tablet PC Mode)        |                     |           |      |                             |                  |                 |
| Test Position<br>Body                     | Antenna<br>Position | Frequency |      | Conducted<br>Power<br>(dBm) | SAR 1g<br>(W/kg) | Limit<br>(W/kg) |
|   |                     | Channel   | MHz  |                             |                  |                 |
| Side                                      | Fixed               | 6         | 2437 | 18.65                       | 0.027            | 1.6             |
| Test Mode: 802.11b(Tablet PC Mode)        |                     |           |      |                             |                  |                 |
| Side                                      | Fixed               | 1         | 2412 | 16.70                       | 0.165            | 1.6             |
| Side                                      | Fixed               | 6         | 2437 | 18.50                       | 0.146            | 1.6             |
| Side                                      | Fixed               | 11        | 2462 | 17.55                       | 0.048            | 1.6             |
| Top                                       | Fixed               | 6         | 2437 | 18.50                       | 0.00488          | 1.6             |
| Back                                      | Fixed               | 6         | 2437 | 18.50                       | 0.00874          | 1.6             |
| Bottom                                    | Fixed               | 6         | 2437 | 18.50                       | 0.00662          | 1.6             |
| Test Mode: 802.11b(Notebook Mode)         |                     |           |      |                             |                  |                 |
| Bottom                                    | Fixed               | 6         | 2437 | 18.50                       | 0.0079           | 1.6             |
| Test Mode: 802.11n (20M) (Tablet PC Mode) |                     |           |      |                             |                  |                 |
| Side                                      | Fixed               | 1         | 2412 | 14.90                       | 0.024            | 1.6             |
| Test Mode: 802.11n (40M) (Tablet PC Mode) |                     |           |      |                             |                  |                 |
| Side                                      | Fixed               | 3         | 2422 | 14.05                       | 0.013            | 1.6             |

**Appendix****Appendix A. SAR System Validation Data****Appendix B. SAR measurement Data****Appendix C. Test Setup Photographs & EUT Photographs****Appendix D. Probe Calibration Data****Appendix E. Dipole Calibration Data**

**Appendix A. SAR System Validation Data**

Date/Time: 9/10/2010

Test Laboratory: Quietek

**System Performance Check\_2450MHz-Body**

**DUT: Dipole 2450 MHz; Type: ALS-D-2450-S-2; Serial: QTK-319**

Communication System: CW; Frequency: 2450 MHz; Communication System PAR: 0 dB

Medium parameters used:  $f = 2450 \text{ MHz}$ ;  $\sigma = 1.92 \text{ mho/m}$ ;  $\epsilon_r = 53$ ;  $\rho = 1000 \text{ kg/m}^3$

Phantom section: Flat Section

Ambient Temperature ( $^{\circ}\text{C}$ ) : 21.7, Liquid Temperature ( $^{\circ}\text{C}$ ) : 20.5

Measurement Standard: DASYS (IEEE/IEC/ANSI C63.19-2007)

DASY5 Configuration:

- Probe: EX3DV4 - SN3698; ConvF(7.01, 7.01, 7.01); Calibrated: 7/19/2010
- Sensor-Surface: 2mm (Mechanical Surface Detection)
- Electronics: DAE4 Sn1207; Calibrated: 4/26/2010
- Phantom: SAM Left Table; Type: SAM;
- Measurement SW: DASYS2, V52.2 Build 0; Postprocessing SW: SEMCAD X, V14.2 Build 2Version 14.2.2 (1674) (Deployment Build)

**Configuration/2450MHz\_Body/Area Scan (7x7x1):** Measurement grid:  $dx=15\text{mm}$ ,  $dy=15\text{mm}$

Maximum value of SAR (measured) = 18.3 mW/g

**Configuration/2450MHz\_Body/Zoom Scan (7x7x7) (5x5x7)/Cube 0:**

Measurement grid:  $dx=8\text{mm}$ ,  $dy=8\text{mm}$ ,  $dz=5\text{mm}$

Reference Value = 106.9 V/m; Power Drift = -0.126 dB

Peak SAR (extrapolated) = 28.5 W/kg

**SAR(1 g) = 13.5 mW/g; SAR(10 g) = 6.13 mW/g**

Maximum value of SAR (measured) = 21.1 mW/g

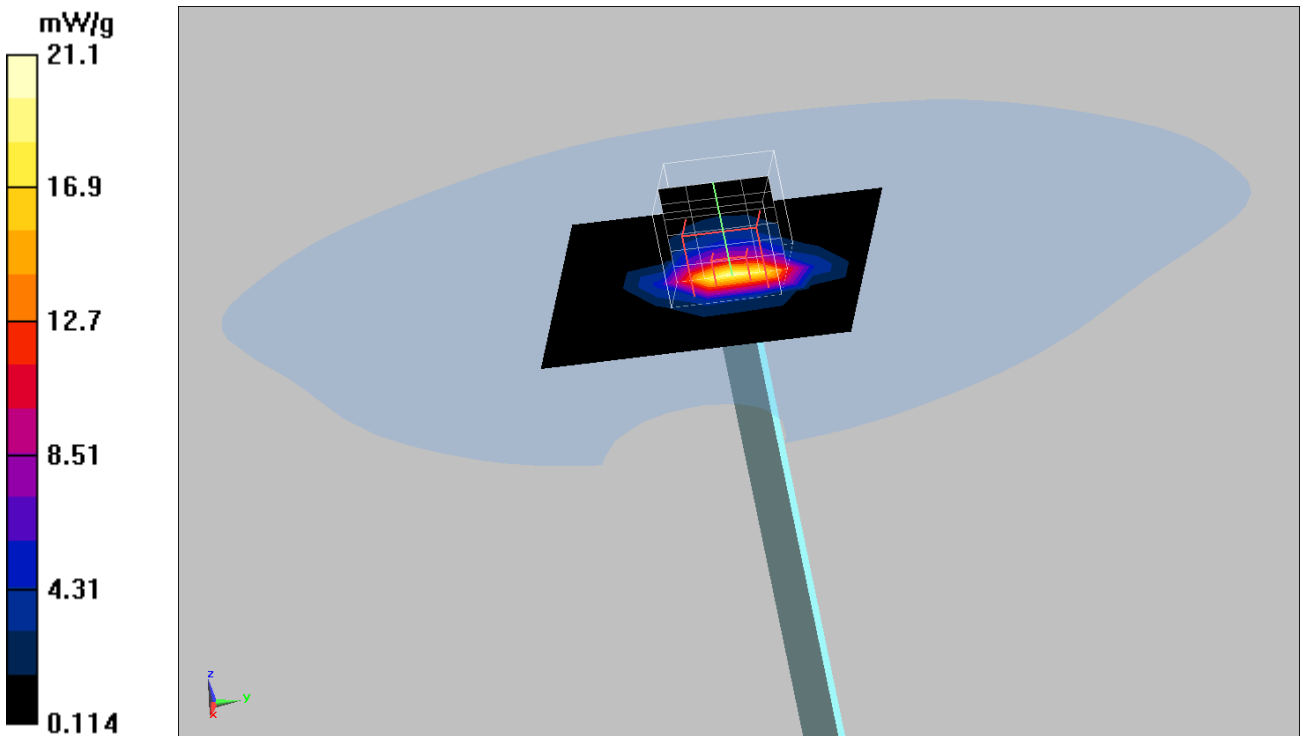

Appendix B. SAR measurement Data

Date/Time: 9/10/2010

Test Laboratory: QuieTek

802.11g\_6-Side

DUT: Touch Note; Type: T1005

Communication System: 802.11g; Frequency: 2437 MHz; Communication System PAR: 0 dB  
 Medium parameters used:  $f = 2437 \text{ MHz}$ ;  $\sigma = 1.91 \text{ mho/m}$ ;  $\epsilon_r = 53.3$ ;  $\rho = 1000 \text{ kg/m}^3$

Phantom section: Flat Section

Ambient Temperature ( $^{\circ}\text{C}$ ) : 21.7, Liquid Temperature ( $^{\circ}\text{C}$ ) : 20.5

Measurement Standard: DASYS (IEEE/IEC/ANSI C63.19-2007)

DASY5 Configuration:

- Probe: EX3DV4 - SN3698; ConvF(7.01, 7.01, 7.01); Calibrated: 7/19/2010
- Sensor-Surface: 4mm (Mechanical Surface Detection)
- Electronics: DAE4 Sn1207; Calibrated: 4/26/2010
- Phantom: SAM with left table; Type: SAM;
- Measurement SW: DASYS2, V52.2 Build 0; Postprocessing SW: SEMCAD X, V14.2 Build 2Version 14.2.2 (1674) (Deployment Build)

**Configuration/Body/Area Scan (5x10x1):** Measurement grid:  $dx=13\text{mm}$ ,  $dy=13\text{mm}$

Maximum value of SAR (measured) = 0.030 mW/g

**Configuration/Body/Zoom Scan (7x7x7) (7x7x7)/Cube 0:** Measurement grid:

$dx=5\text{mm}$ ,  $dy=5\text{mm}$ ,  $dz=5\text{mm}$

Reference Value = 3.64 V/m; Power Drift = 0.148 dB

Peak SAR (extrapolated) = 0.136 W/kg

**SAR(1 g) = 0.027 mW/g; SAR(10 g) = 0.012 mW/g**

Maximum value of SAR (measured) = 0.031 mW/g

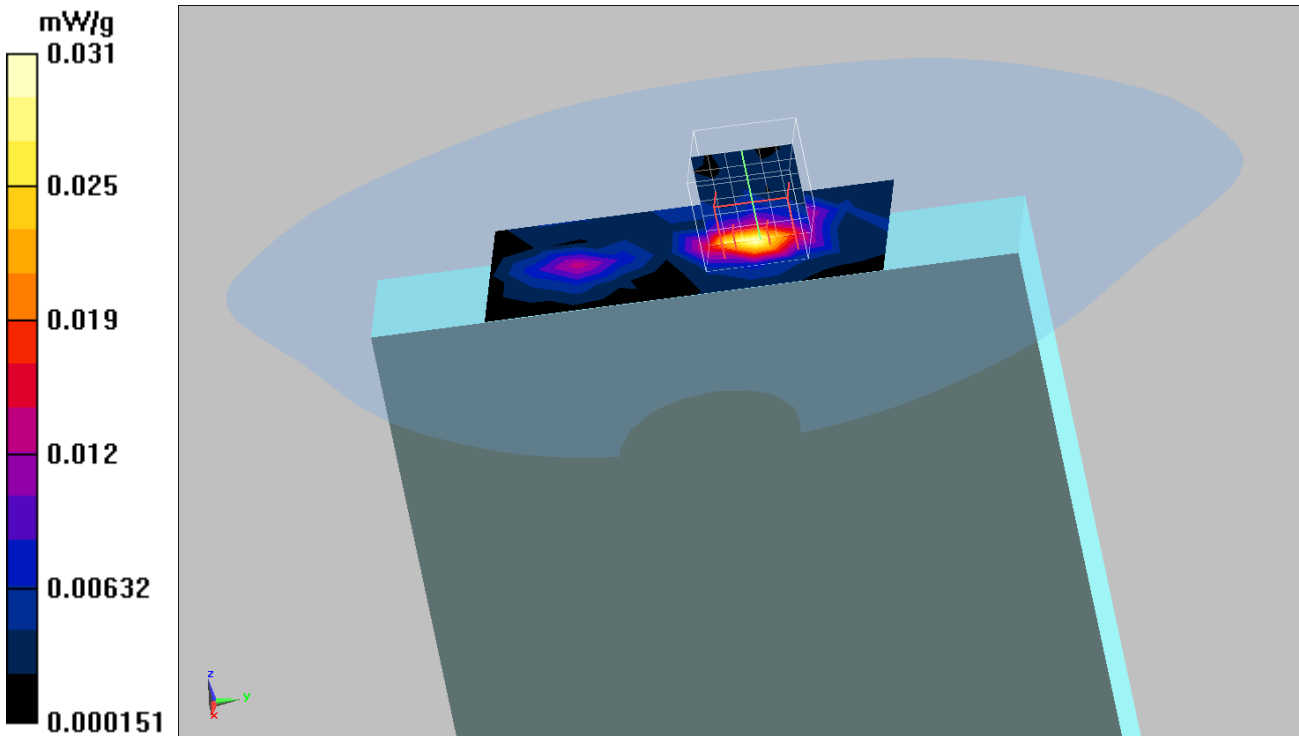



Date/Time: 9/10/2010

Test Laboratory: QuieTek

**802.11b\_1-Side**

**DUT: Touch Note; Type: T1005**

Communication System: 802.11b; Frequency: 2412 MHz; Communication System PAR: 0 dB

Medium parameters used:  $f = 2412 \text{ MHz}$ ;  $\sigma = 1.88 \text{ mho/m}$ ;  $\epsilon_r = 54.2$ ;  $\rho = 1000 \text{ kg/m}^3$

Phantom section: Flat Section

Ambient Temperature ( $^{\circ}\text{C}$ ) : 21.7, Liquid Temperature ( $^{\circ}\text{C}$ ) : 20.5

Measurement Standard: DASYS (IEEE/IEC/ANSI C63.19-2007)

DASY5 Configuration:

- Probe: EX3DV4 - SN3698; ConvF(7.01, 7.01, 7.01); Calibrated: 7/19/2010
- Sensor-Surface: 4mm (Mechanical Surface Detection)
- Electronics: DAE4 Sn1207; Calibrated: 4/26/2010
- Phantom: SAM with left table; Type: SAM;
- Measurement SW: DASY52, V52.2 Build 0; Postprocessing SW: SEMCAD X, V14.2 Build 2Version 14.2.2 (1674) (Deployment Build)

**Configuration/Body/Area Scan (5x10x1):** Measurement grid:  $dx=13\text{mm}$ ,  $dy=13\text{mm}$   
 Maximum value of SAR (measured) = 0.197 mW/g

**Configuration/Body/Zoom Scan (7x7x7) (7x7x7)/Cube 0:** Measurement grid:  
 $dx=5\text{mm}$ ,  $dy=5\text{mm}$ ,  $dz=5\text{mm}$   
 Reference Value = 10.4 V/m; Power Drift = -0.146 dB  
 Peak SAR (extrapolated) = 0.440 W/kg  
**SAR(1 g) = 0.165 mW/g; SAR(10 g) = 0.069 mW/g**  
 Maximum value of SAR (measured) = 0.191 mW/g

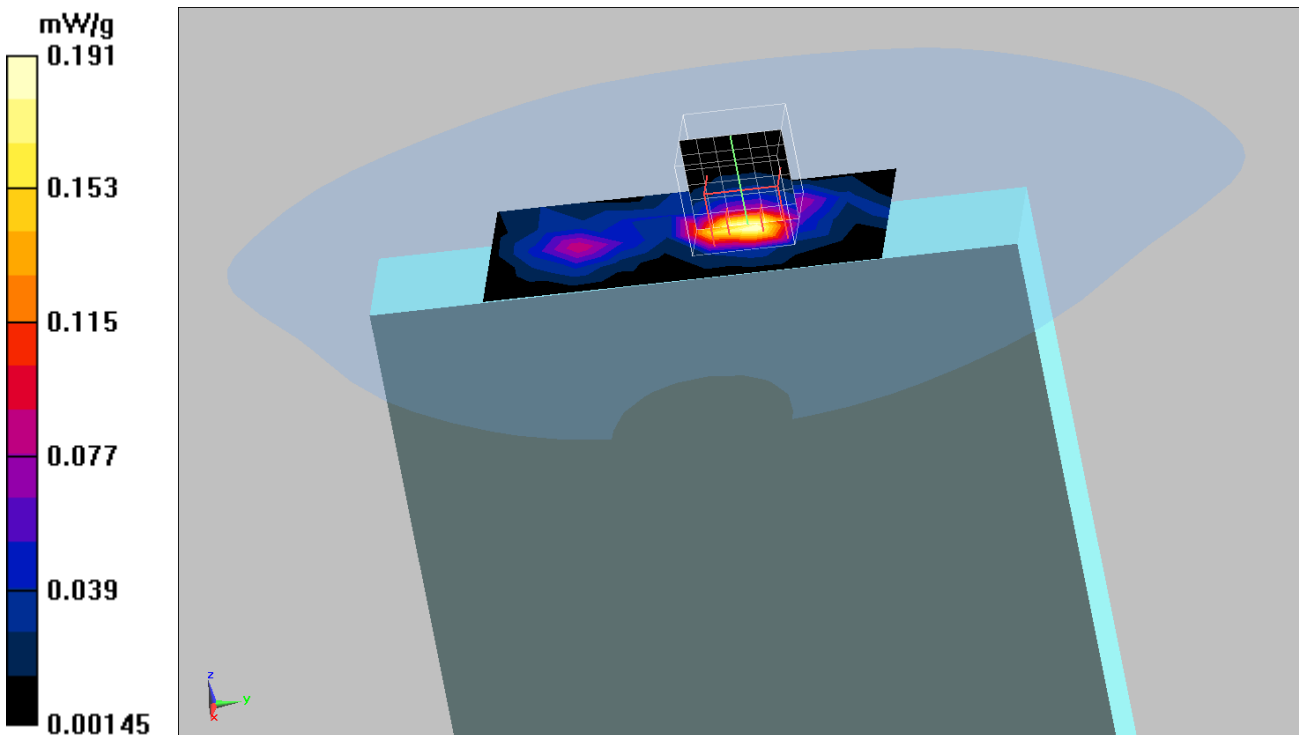

Date/Time: 9/10/2010

Test Laboratory: QuieTek

**802.11b\_6-Side**

**DUT: Touch Note; Type: T1005**

Communication System: 802.11b; Frequency: 2437 MHz; Communication System PAR: 0 dB

Medium parameters used:  $f = 2437 \text{ MHz}$ ;  $\sigma = 1.91 \text{ mho/m}$ ;  $\epsilon_r = 53.3$ ;  $\rho = 1000 \text{ kg/m}^3$

Phantom section: Flat Section

Ambient Temperature ( $^{\circ}\text{C}$ ) : 21.7, Liquid Temperature ( $^{\circ}\text{C}$ ) : 20.5

Measurement Standard: DASY5 (IEEE/IEC/ANSI C63.19-2007)

DASY5 Configuration:

- Probe: EX3DV4 - SN3698; ConvF(7.01, 7.01, 7.01); Calibrated: 7/19/2010
- Sensor-Surface: 4mm (Mechanical Surface Detection)
- Electronics: DAE4 Sn1207; Calibrated: 4/26/2010
- Phantom: SAM with left table; Type: SAM;
- Measurement SW: DASY52, V52.2 Build 0; Postprocessing SW: SEMCAD X, V14.2 Build 2Version 14.2.2 (1674) (Deployment Build)

**Configuration/Body/Area Scan (5x10x1):** Measurement grid:  $dx=13\text{mm}$ ,  $dy=13\text{mm}$   
 Maximum value of SAR (measured) = 0.135 mW/g

**Configuration/Body/Zoom Scan (7x7x7) (7x7x7)/Cube 0:** Measurement grid:  
 $dx=5\text{mm}$ ,  $dy=5\text{mm}$ ,  $dz=5\text{mm}$   
 Reference Value = 8.25 V/m; Power Drift = 0.116 dB  
 Peak SAR (extrapolated) = 0.380 W/kg  
**SAR(1 g) = 0.146 mW/g; SAR(10 g) = 0.061 mW/g**  
 Maximum value of SAR (measured) = 0.174 mW/g

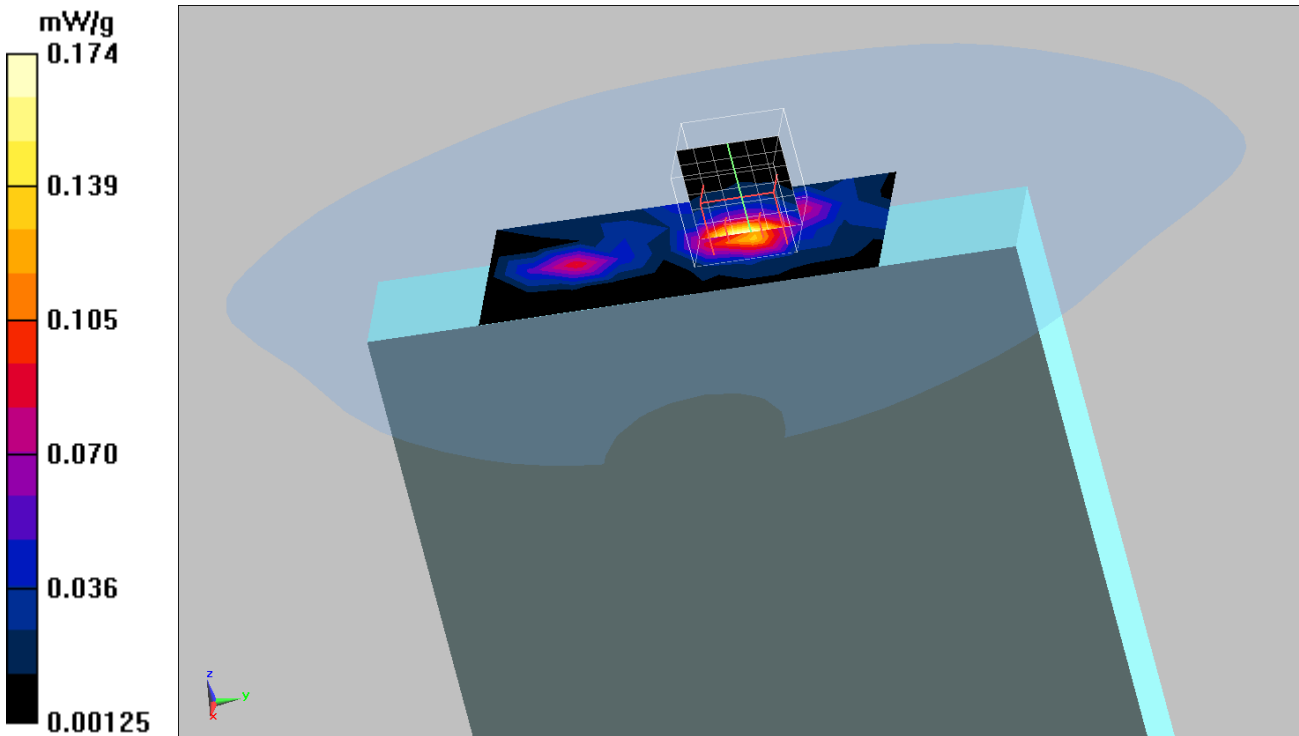

Date/Time: 9/10/2010

Test Laboratory: QuieTek

**802.11b\_11-Side**

**DUT: Touch Note; Type: T1005**

Communication System: 802.11b; Frequency: 2462 MHz; Communication System PAR: 0 dB

Medium parameters used:  $f = 2462 \text{ MHz}$ ;  $\sigma = 1.95 \text{ mho/m}$ ;  $\epsilon_r = 52.3$ ;  $\rho = 1000 \text{ kg/m}^3$

Phantom section: Flat Section

Ambient Temperature ( $^{\circ}\text{C}$ ) : 21.7, Liquid Temperature ( $^{\circ}\text{C}$ ) : 20.5

Measurement Standard: DASYS (IEEE/IEC/ANSI C63.19-2007)

DASY5 Configuration:

- Probe: EX3DV4 - SN3698; ConvF(7.01, 7.01, 7.01); Calibrated: 7/19/2010
- Sensor-Surface: 4mm (Mechanical Surface Detection)
- Electronics: DAE4 Sn1207; Calibrated: 4/26/2010
- Phantom: SAM with left table; Type: SAM;
- Measurement SW: DASYS2, V52.2 Build 0; Postprocessing SW: SEMCAD X, V14.2 Build 2Version 14.2.2 (1674) (Deployment Build)

**Configuration/Body/Area Scan (5x10x1):** Measurement grid:  $dx=13\text{mm}$ ,  $dy=13\text{mm}$   
 Maximum value of SAR (measured) = 0.049 mW/g

**Configuration/Body/Zoom Scan (7x7x7) (7x7x7)/Cube 0:** Measurement grid:  
 $dx=5\text{mm}$ ,  $dy=5\text{mm}$ ,  $dz=5\text{mm}$

Reference Value = 3.95 V/m; Power Drift = 0.112 dB

Peak SAR (extrapolated) = 0.121 W/kg

**SAR(1 g) = 0.048 mW/g; SAR(10 g) = 0.023 mW/g**

Maximum value of SAR (measured) = 0.052 mW/g

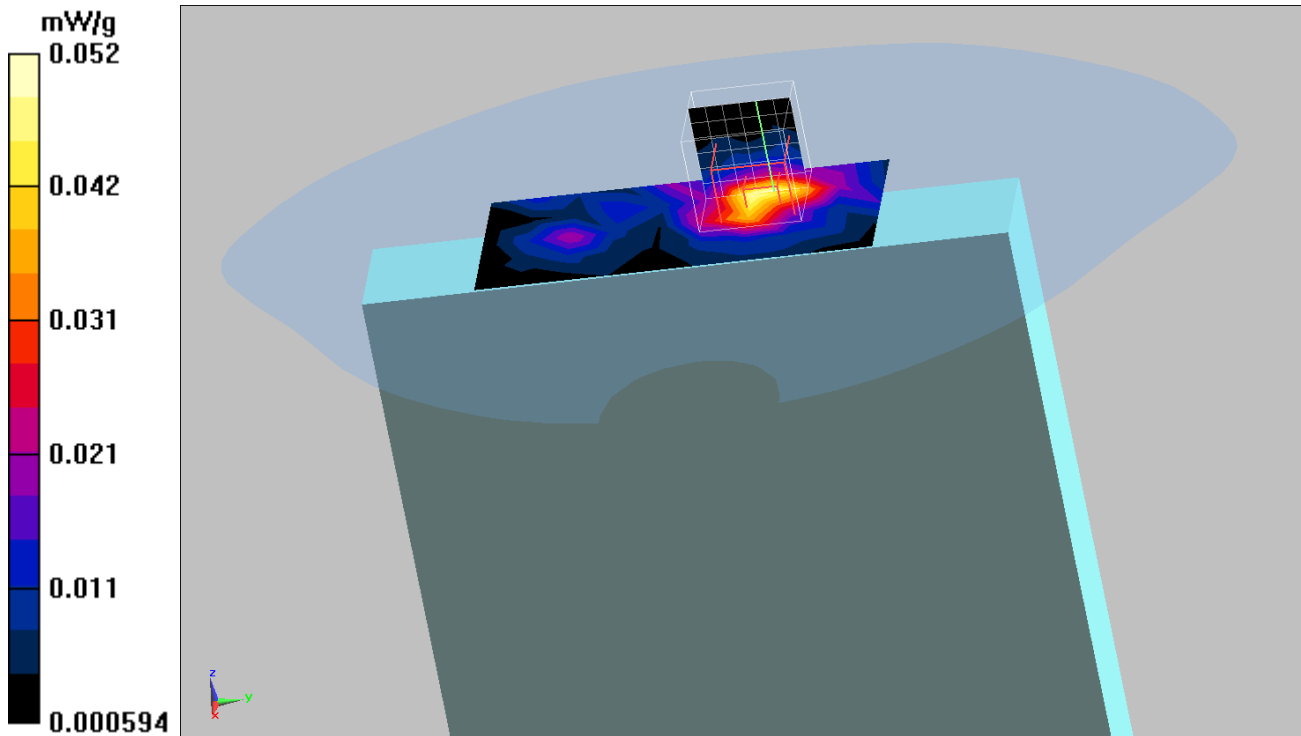

Date/Time: 9/10/2010

Test Laboratory: QuieTek

**802.11b\_6-Top**

**DUT: Touch Note; Type: T1005**

Communication System: 802.11b; Frequency: 2437 MHz; Communication System PAR: 0 dB

Medium parameters used:  $f = 2437$  MHz;  $\sigma = 1.91$  mho/m;  $\epsilon_r = 53.3$ ;  $\rho = 1000$  kg/m<sup>3</sup>

Phantom section: Flat Section

Ambient Temperature (°C) : 21.7, Liquid Temperature (°C) : 20.5

Measurement Standard: DASY5 (IEEE/IEC/ANSI C63.19-2007)

DASY5 Configuration:

- Probe: EX3DV4 - SN3698; ConvF(7.01, 7.01, 7.01); Calibrated: 7/19/2010
- Sensor-Surface: 4mm (Mechanical Surface Detection)
- Electronics: DAE4 Sn1207; Calibrated: 4/26/2010
- Phantom: SAM with left table; Type: SAM;
- Measurement SW: DASY52, V52.2 Build 0; Postprocessing SW: SEMCAD X, V14.2 Build 2Version 14.2.2 (1674) (Deployment Build)

**Configuration/Body/Area Scan (5x10x1):** Measurement grid: dx=13mm, dy=13mm  
 Maximum value of SAR (measured) = 0.00451 mW/g

**Configuration/Body/Zoom Scan (7x7x7) (7x7x7)/Cube 0:** Measurement grid:  
 dx=5mm, dy=5mm, dz=5mm

Reference Value = 0.483 V/m; Power Drift = 0.081 dB

Peak SAR (extrapolated) = 0.017 W/kg

**SAR(1 g) = 0.00488 mW/g; SAR(10 g) = 0.00153 mW/g**

Maximum value of SAR (measured) = 0.00669 mW/g

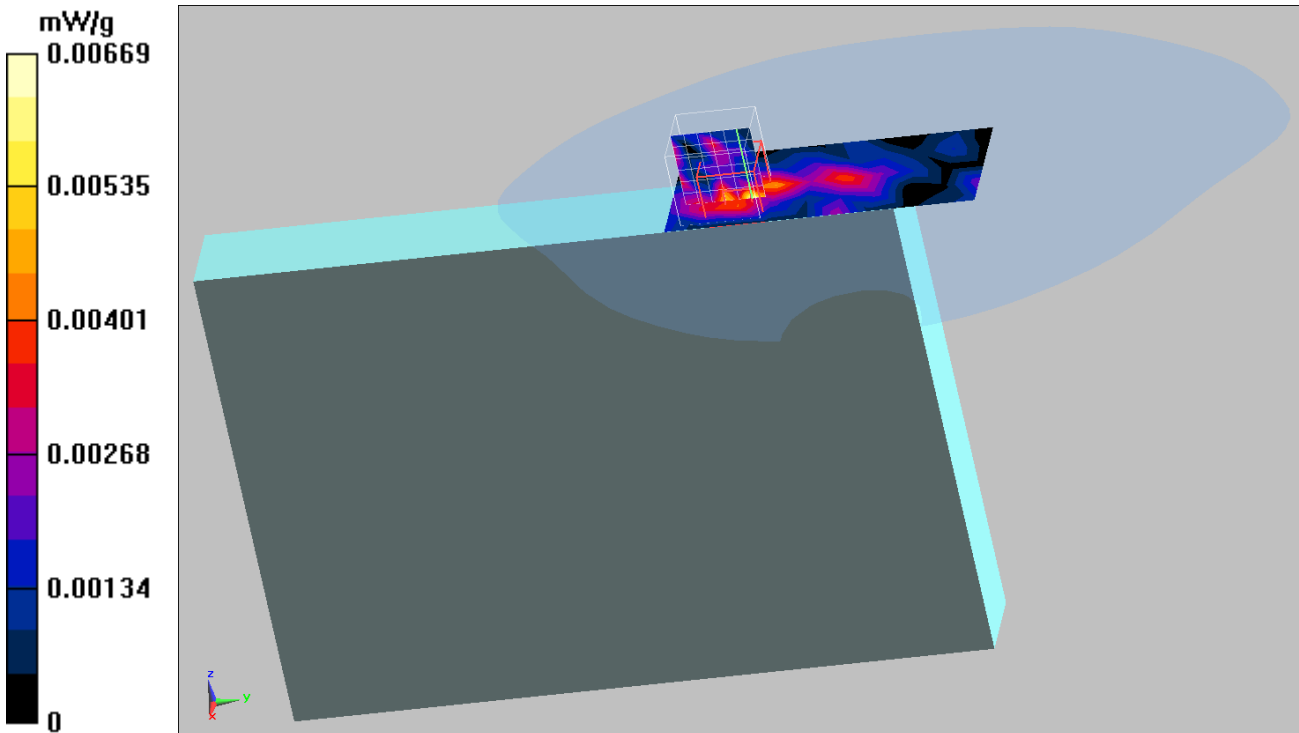

Date/Time: 9/10/2010

Test Laboratory: QuieTek

**802.11b\_6-Back**

**DUT: Touch Note; Type: T1005**

Communication System: 802.11b; Frequency: 2437 MHz; Communication System PAR: 0 dB

Medium parameters used:  $f = 2437 \text{ MHz}$ ;  $\sigma = 1.91 \text{ mho/m}$ ;  $\epsilon_r = 53.3$ ;  $\rho = 1000 \text{ kg/m}^3$

Phantom section: Flat Section

Ambient Temperature ( $^{\circ}\text{C}$ ) : 21.7, Liquid Temperature ( $^{\circ}\text{C}$ ) : 20.5

Measurement Standard: DASYS (IEEE/IEC/ANSI C63.19-2007)

DASY5 Configuration:

- Probe: EX3DV4 - SN3698; ConvF(7.01, 7.01, 7.01); Calibrated: 7/19/2010
- Sensor-Surface: 4mm (Mechanical Surface Detection)
- Electronics: DAE4 Sn1207; Calibrated: 4/26/2010
- Phantom: SAM with left table; Type: SAM;
- Measurement SW: DASY52, V52.2 Build 0; Postprocessing SW: SEMCAD X, V14.2 Build 2Version 14.2.2 (1674) (Deployment Build)

**Configuration/Body/Area Scan (7x5x1):** Measurement grid:  $dx=13\text{mm}$ ,  $dy=13\text{mm}$   
 Maximum value of SAR (measured) = 0.00996 mW/g

**Configuration/Body/Zoom Scan (7x7x7) (7x7x7)/Cube 0:** Measurement grid:  
 $dx=5\text{mm}$ ,  $dy=5\text{mm}$ ,  $dz=5\text{mm}$   
 Reference Value = 1.7 V/m; Power Drift = -0.122 dB  
 Peak SAR (extrapolated) = 0.020 W/kg  
**SAR(1 g) = 0.00874 mW/g; SAR(10 g) = 0.00707 mW/g**  
 Maximum value of SAR (measured) = 0.013 mW/g

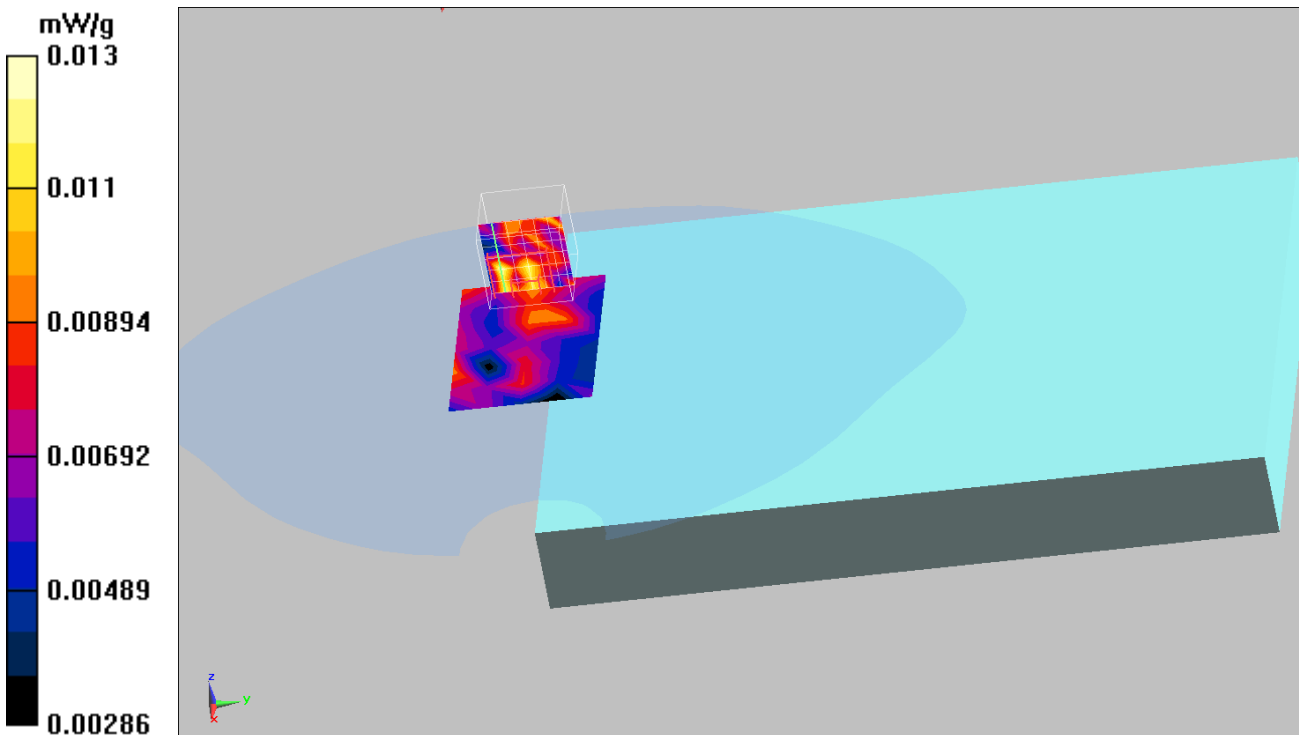

Date/Time: 9/10/2010

Test Laboratory: QuieTek

**802.11b\_6-Bottom**

**DUT: Touch Note; Type: T1005**

Communication System: 802.11b; Frequency: 2437 MHz; Communication System PAR: 0 dB

Medium parameters used:  $f = 2437 \text{ MHz}$ ;  $\sigma = 1.91 \text{ mho/m}$ ;  $\epsilon_r = 53.3$ ;  $\rho = 1000 \text{ kg/m}^3$

Phantom section: Flat Section

Ambient Temperature ( $^{\circ}\text{C}$ ) : 21.7, Liquid Temperature ( $^{\circ}\text{C}$ ) : 20.5

Measurement Standard: DASY5 (IEEE/IEC/ANSI C63.19-2007)

DASY5 Configuration:

- Probe: EX3DV4 - SN3698; ConvF(7.01, 7.01, 7.01); Calibrated: 7/19/2010
- Sensor-Surface: 4mm (Mechanical Surface Detection)
- Electronics: DAE4 Sn1207; Calibrated: 4/26/2010
- Phantom: SAM with left table; Type: SAM;
- Measurement SW: DASY52, V52.2 Build 0; Postprocessing SW: SEMCAD X, V14.2 Build 2Version 14.2.2 (1674) (Deployment Build)

**Configuration/Body/Area Scan (5x10x1):** Measurement grid:  $dx=13\text{mm}$ ,  $dy=13\text{mm}$   
 Maximum value of SAR (measured) = 0.00526 mW/g

**Configuration/Body/Zoom Scan (7x7x7) (7x7x7)/Cube 0:** Measurement grid:  
 $dx=5\text{mm}$ ,  $dy=5\text{mm}$ ,  $dz=5\text{mm}$

Reference Value = 0.875 V/m; Power Drift = 0.128 dB

Peak SAR (extrapolated) = 0.014 W/kg

**SAR(1 g) = 0.00662 mW/g; SAR(10 g) = 0.0031 mW/g**

Maximum value of SAR (measured) = 0.00866 mW/g

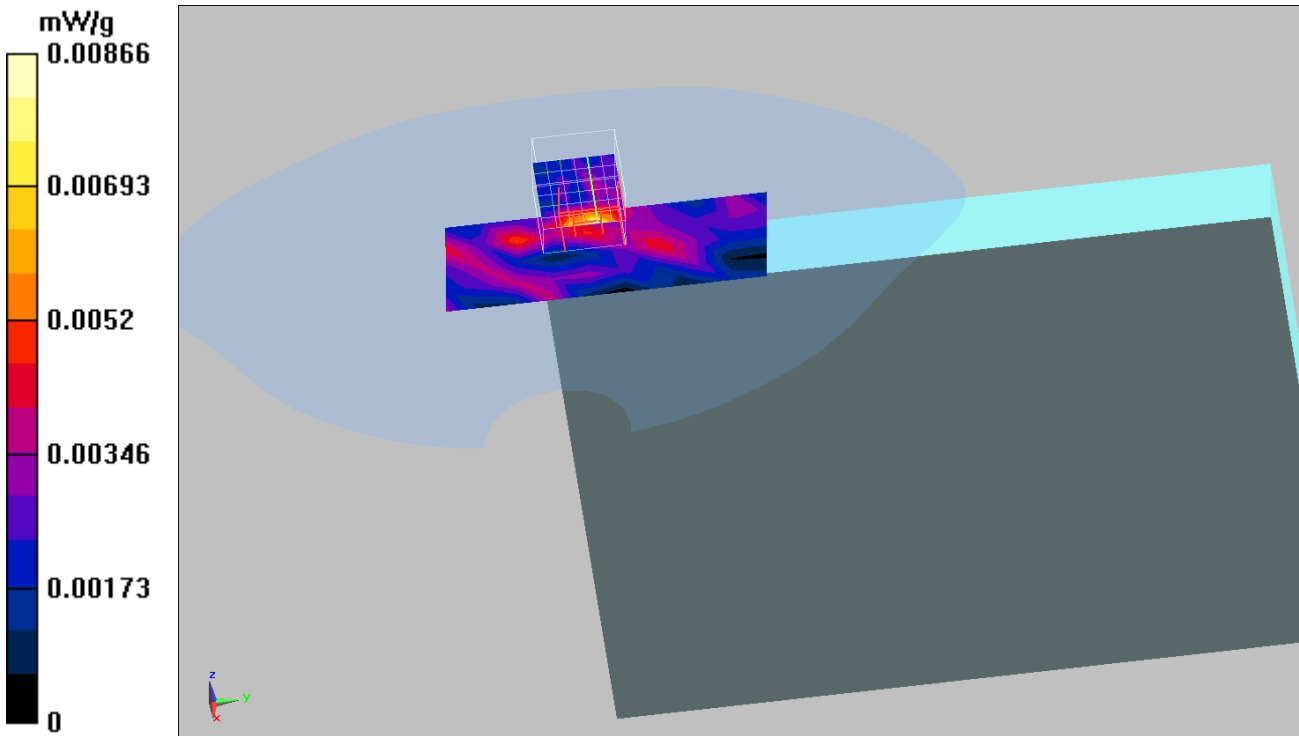

Date/Time: 9/10/2010

Test Laboratory: QuieTek

**802.11b\_6-Botton NB**

**DUT: Touch Note; Type: T1005**

Communication System: 802.11b; Frequency: 2437 MHz; Communication System PAR: 0 dB

Medium parameters used:  $f = 2437 \text{ MHz}$ ;  $\sigma = 1.91 \text{ mho/m}$ ;  $\epsilon_r = 53.3$ ;  $\rho = 1000 \text{ kg/m}^3$

Phantom section: Flat Section

Ambient Temperature ( $^{\circ}\text{C}$ ) : 21.7, Liquid Temperature ( $^{\circ}\text{C}$ ) : 20.5

Measurement Standard: DASYS (IEEE/IEC/ANSI C63.19-2007)

DASY5 Configuration:

- Probe: EX3DV4 - SN3698; ConvF(7.01, 7.01, 7.01); Calibrated: 7/19/2010
- Sensor-Surface: 4mm (Mechanical Surface Detection)
- Electronics: DAE4 Sn1207; Calibrated: 4/26/2010
- Phantom: SAM with left table; Type: SAM;
- Measurement SW: DASY52, V52.2 Build 0; Postprocessing SW: SEMCAD X, V14.2 Build 2Version 14.2.2 (1674) (Deployment Build)

**Configuration/Body/Area Scan (7x5x1):** Measurement grid:  $dx=13\text{mm}$ ,  $dy=13\text{mm}$   
 Maximum value of SAR (measured) = 0.00954 mW/g

**Configuration/Body/Zoom Scan (7x7x7) (7x7x7)/Cube 0:** Measurement grid:  
 $dx=5\text{mm}$ ,  $dy=5\text{mm}$ ,  $dz=5\text{mm}$   
 Reference Value = 1.7 V/m; Power Drift = 0.170 dB  
 Peak SAR (extrapolated) = 0.013 W/kg  
**SAR(1 g) = 0.0079 mW/g; SAR(10 g) = 0.007 mW/g**  
 Maximum value of SAR (measured) = 0.012 mW/g

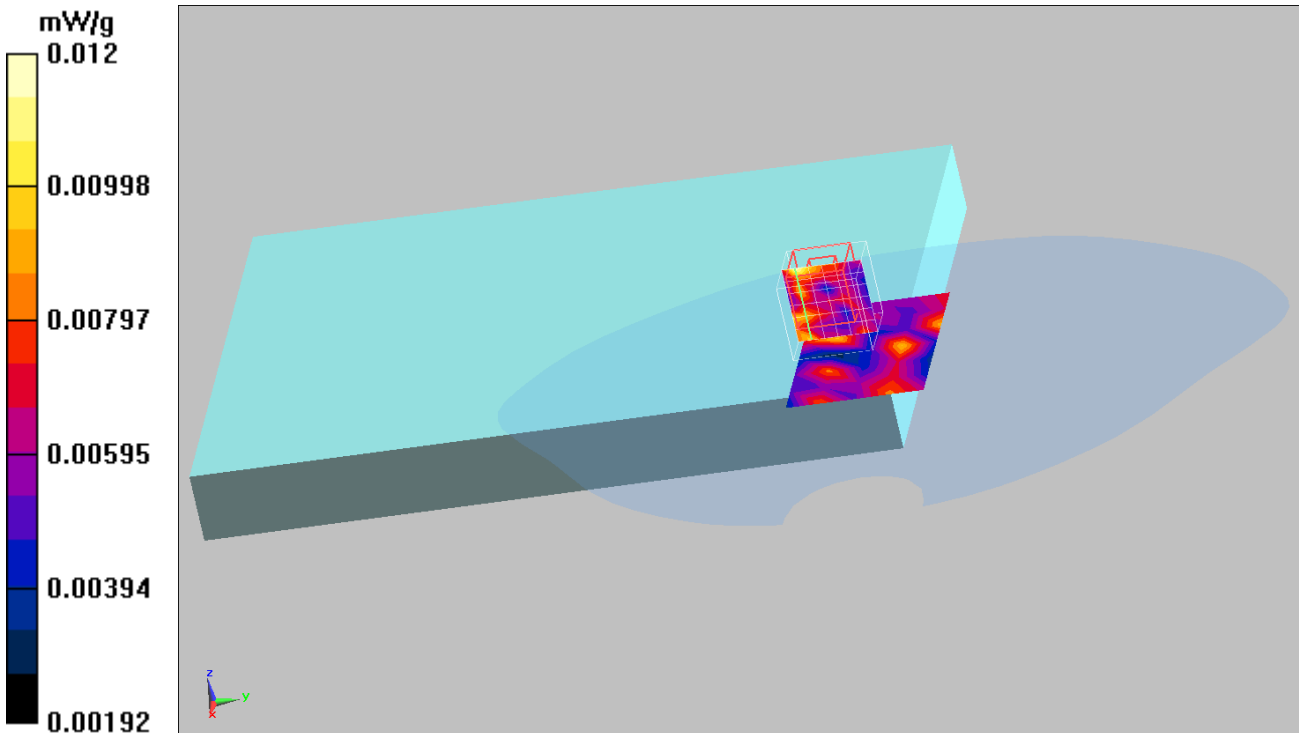

Date/Time: 9/10/2010

Test Laboratory: QuieTek

**802.11n 20M\_1-Side**

**DUT: Touch Note; Type: T1005**

Communication System: 802.11n; Frequency: 2412 MHz; Communication System PAR: 0 dB

Medium parameters used:  $f = 2412 \text{ MHz}$ ;  $\sigma = 1.88 \text{ mho/m}$ ;  $\epsilon_r = 54.2$ ;  $\rho = 1000 \text{ kg/m}^3$

Phantom section: Flat Section

Ambient Temperature ( $^{\circ}\text{C}$ ) : 21.7, Liquid Temperature ( $^{\circ}\text{C}$ ) : 20.5

Measurement Standard: DASY5 (IEEE/IEC/ANSI C63.19-2007)

DASY5 Configuration:

- Probe: EX3DV4 - SN3698; ConvF(7.01, 7.01, 7.01); Calibrated: 7/19/2010
- Sensor-Surface: 4mm (Mechanical Surface Detection)
- Electronics: DAE4 Sn1207; Calibrated: 4/26/2010
- Phantom: SAM with left table; Type: SAM;
- Measurement SW: DASY52, V52.2 Build 0; Postprocessing SW: SEMCAD X, V14.2 Build 2Version 14.2.2 (1674) (Deployment Build)

**Configuration/Body/Area Scan (5x10x1):** Measurement grid:  $dx=13\text{mm}$ ,  $dy=13\text{mm}$   
 Maximum value of SAR (measured) = 0.020 mW/g

**Configuration/Body/Zoom Scan (7x7x7) (7x7x7)/Cube 0:** Measurement grid:  
 $dx=5\text{mm}$ ,  $dy=5\text{mm}$ ,  $dz=5\text{mm}$

Reference Value = 2.94 V/m; Power Drift = 0.121 dB

Peak SAR (extrapolated) = 0.072 W/kg

**SAR(1 g) = 0.024 mW/g; SAR(10 g) = 0.011 mW/g**

Maximum value of SAR (measured) = 0.027 mW/g

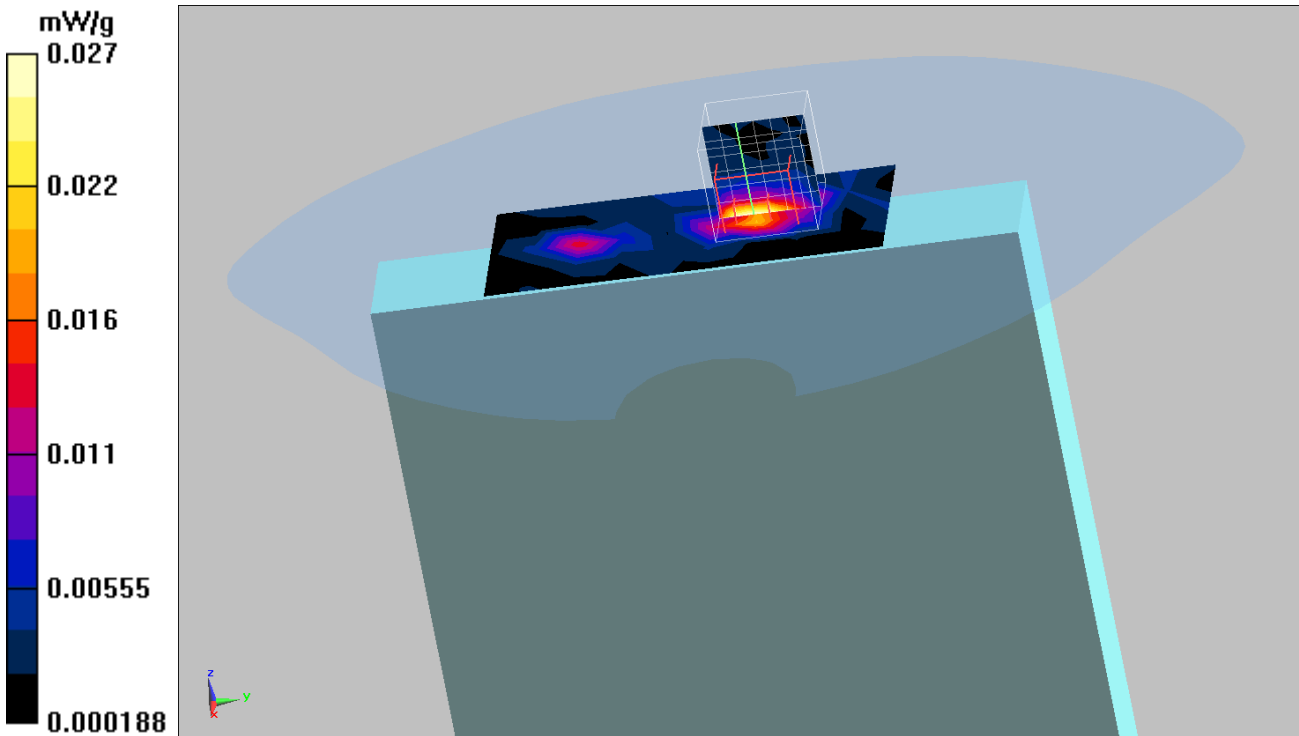



Date/Time: 9/10/2010

Test Laboratory: QuieTek

**802.11n 40M\_3-Side**

**DUT: Touch Note; Type: T1005**

Communication System: 802.11n; Frequency: 2422 MHz; Communication System PAR: 0 dB

Medium parameters used:  $f = 2422 \text{ MHz}$ ;  $\sigma = 1.89 \text{ mho/m}$ ;  $\epsilon_r = 53.8$ ;  $\rho = 1000 \text{ kg/m}^3$

Phantom section: Flat Section

Ambient Temperature ( $^{\circ}\text{C}$ ) : 21.7, Liquid Temperature ( $^{\circ}\text{C}$ ) : 20.5

Measurement Standard: DASYS (IEEE/IEC/ANSI C63.19-2007)

DASY5 Configuration:

- Probe: EX3DV4 - SN3698; ConvF(7.01, 7.01, 7.01); Calibrated: 7/19/2010
- Sensor-Surface: 4mm (Mechanical Surface Detection)
- Electronics: DAE4 Sn1207; Calibrated: 4/26/2010
- Phantom: SAM with left table; Type: SAM;
- Measurement SW: DASY52, V52.2 Build 0; Postprocessing SW: SEMCAD X, V14.2 Build 2Version 14.2.2 (1674) (Deployment Build)

**Configuration/Body/Area Scan (5x10x1):** Measurement grid:  $dx=13\text{mm}$ ,  $dy=13\text{mm}$   
 Maximum value of SAR (measured) = 0.014 mW/g

**Configuration/Body/Zoom Scan (7x7x7) (7x7x7)/Cube 0:** Measurement grid:  
 $dx=5\text{mm}$ ,  $dy=5\text{mm}$ ,  $dz=5\text{mm}$

Reference Value = 2.48 V/m; Power Drift = 0.184 dB

Peak SAR (extrapolated) = 0.038 W/kg

**SAR(1 g) = 0.013 mW/g; SAR(10 g) = 0.00547 mW/g**

Maximum value of SAR (measured) = 0.015 mW/g

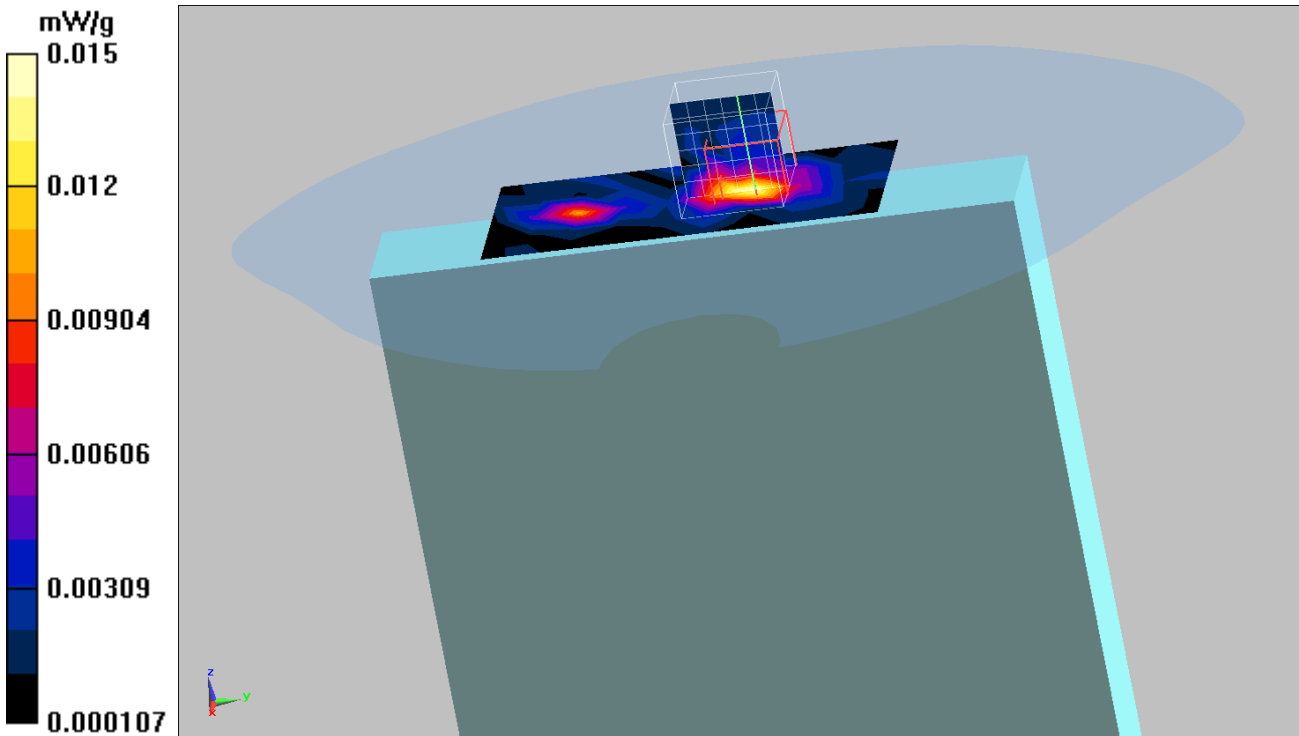

802.11b EUT Side Z-Axis plot

Channel: 1

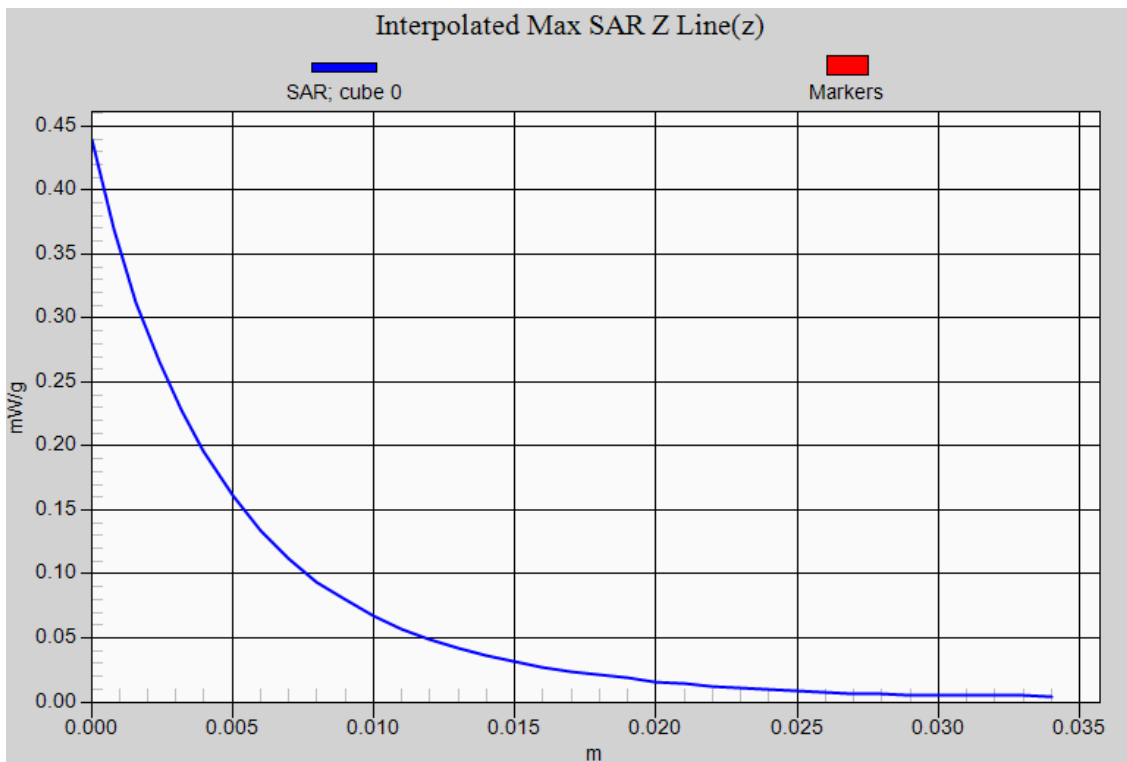



## **Appendix D. Probe Calibration Data**

**Object: EX3DV4- SN 3698**

1155

**Calibration Laboratory of  
Schmid & Partner  
Engineering AG**  
Zeughausstrasse 43, 8004 Zurich, Switzerland



**S** Schweizerischer Kalibrierdienst  
**C** Service suisse d'étalonnage  
**S** Servizio svizzero di taratura  
**S** Swiss Calibration Service

Accredited by the Swiss Accreditation Service (SAS)  
**The Swiss Accreditation Service is one of the signatories to the EA  
Multilateral Agreement for the recognition of calibration certificates**

Accreditation No.: **SCS 108**

Client **Quietek (Auden)**

Certificate No: **EX3-3698\_Jul10**

# CALIBRATION CERTIFICATE

Object **EX3DV4 - SN.3698**

Calibration procedure(s) **QA CAL-01.v6, QA CAL-14.v3, QA CAL-23.v3 and QA CAL-25.v2  
Calibration procedure for dosimetric E-field probes**

Calibration date: **July 19, 2010**

This calibration certificate documents the traceability to national standards, which realize the physical units of measurements (SI).  
The measurements and the uncertainties with confidence probability are given on the following pages and are part of the certificate.

All calibrations have been conducted in the closed laboratory facility: environment temperature (22 ± 3)°C and humidity < 70%.

Calibration Equipment used (M&TE critical for calibration)

| Primary Standards          | ID #            | Cal Date (Certificate No.)     | Scheduled Calibration |
|----------------------------|-----------------|--------------------------------|-----------------------|
| Power meter E4419B         | GB41293874      | 1-Apr-10 (No. 217-01136)       | Apr-11                |
| Power sensor E4412A        | MY41495277      | 1-Apr-10 (No. 217-01136)       | Apr-11                |
| Power sensor E4412A        | MY41498087      | 1-Apr-10 (No. 217-01136)       | Apr-11                |
| Reference 3 dB Attenuator  | SN: S5054 (3c)  | 30-Mar-10 (No. 217-01159)      | Mar-11                |
| Reference 20 dB Attenuator | SN: S5086 (20b) | 30-Mar-10 (No. 217-01161)      | Mar-11                |
| Reference 30 dB Attenuator | SN: S5129 (30b) | 30-Mar-10 (No. 217-01160)      | Mar-11                |
| Reference Probe ES3DV2     | SN: 3013        | 30-Dec-09 (No. ES3-3013_Dec09) | Dec-10                |
| DAE4                       | SN: 660         | 20-Apr-10 (No. DAE4-660_Apr10) | Apr-11                |

| Secondary Standards       | ID #         | Check Date (in house)             | Scheduled Check        |
|---------------------------|--------------|-----------------------------------|------------------------|
| RF generator HP 8648C     | US3642U01700 | 4-Aug-99 (in house check Oct-09)  | In house check: Oct-11 |
| Network Analyzer HP 8753E | US37390585   | 18-Oct-01 (in house check Oct-09) | In house check: Oct10  |

|                | Name          | Function          | Signature |
|----------------|---------------|-------------------|-----------|
| Calibrated by: | Katja Pokovic | Technical Manager |           |
| Approved by:   | Niels Kuster  | Quality Manager   |           |

Issued: July 20, 2010

This calibration certificate shall not be reproduced except in full without written approval of the laboratory.



Accredited by the Swiss Accreditation Service (SAS)

The Swiss Accreditation Service is one of the signatories to the EA  
Multilateral Agreement for the recognition of calibration certificates

Accreditation No.: **SCS 108**

## Glossary:

|                          |   |
|--------------------------|---|
| TSL                      | tissue simulating liquid  |
| NORM <sub>x,y,z</sub>    | sensitivity in free space   |
| ConvF                    | sensitivity in TSL / NORM <sub>x,y,z</sub>  |
| DCP                      | diode compression point   |
| CF                       | crest factor (1/duty_cycle) of the RF signal  |
| A, B, C                  | modulation dependent linearization parameters   |
| Polarization $\varphi$   | $\varphi$ rotation around probe axis  |
| Polarization $\vartheta$ | $\vartheta$ rotation around an axis that is in the plane normal to probe axis (at measurement center),<br>i.e., $\vartheta = 0$ is normal to probe axis |

## Calibration is Performed According to the Following Standards:

- IEEE Std 1528-2003, "IEEE Recommended Practice for Determining the Peak Spatial-Averaged Specific Absorption Rate (SAR) in the Human Head from Wireless Communications Devices: Measurement Techniques", December 2003
- IEC 62209-1, "Procedure to measure the Specific Absorption Rate (SAR) for hand-held devices used in close proximity to the ear (frequency range of 300 MHz to 3 GHz)", February 2005

## Methods Applied and Interpretation of Parameters:

- NORM<sub>x,y,z</sub>**: Assessed for E-field polarization  $\vartheta = 0$  ( $f \leq 900$  MHz in TEM-cell;  $f > 1800$  MHz: R22 waveguide). NORM<sub>x,y,z</sub> are only intermediate values, i.e., the uncertainties of NORM<sub>x,y,z</sub> does not effect the E<sup>2</sup>-field uncertainty inside TSL (see below ConvF).
- NORM(f)<sub>x,y,z</sub>** = NORM<sub>x,y,z</sub> \* frequency\_response (see Frequency Response Chart). This linearization is implemented in DASY4 software versions later than 4.2. The uncertainty of the frequency response is included in the stated uncertainty of ConvF.
- DCP<sub>x,y,z</sub>**: DCP are numerical linearization parameters assessed based on the data of power sweep with CW signal (no uncertainty required). DCP does not depend on frequency nor media.
- A<sub>x,y,z</sub>; B<sub>x,y,z</sub>; C<sub>x,y,z</sub>; VR<sub>x,y,z</sub>**: A, B, C are numerical linearization parameters assessed based on the data of power sweep for specific modulation signal. The parameters do not depend on frequency nor media. VR is the maximum calibration range expressed in RMS voltage across the diode.
- ConvF and Boundary Effect Parameters**: Assessed in flat phantom using E-field (or Temperature Transfer Standard for  $f \leq 800$  MHz) and inside waveguide using analytical field distributions based on power measurements for  $f > 800$  MHz. The same setups are used for assessment of the parameters applied for boundary compensation (alpha, depth) of which typical uncertainty values are given. These parameters are used in DASY4 software to improve probe accuracy close to the boundary. The sensitivity in TSL corresponds to NORM<sub>x,y,z</sub> \* ConvF whereby the uncertainty corresponds to that given for ConvF. A frequency dependent ConvF is used in DASY version 4.4 and higher which allows extending the validity from  $\pm 50$  MHz to  $\pm 100$  MHz.
- Spherical isotropy (3D deviation from isotropy)**: in a field of low gradients realized using a flat phantom exposed by a patch antenna.
- Sensor Offset**: The sensor offset corresponds to the offset of virtual measurement center from the probe tip (on probe axis). No tolerance required.

# Probe EX3DV4

## SN:3698

|                  |                  |
|------------------|------------------|
| Manufactured:    | April 22, 2009   |
| Last calibrated: | October 30, 2009 |
| Recalibrated:    | July 19, 2010    |

Calibrated for DASY/EASY Systems

(Note: non-compatible with DASY2 system!)

**DASY/EASY - Parameters of Probe: EX3DV4 SN:3698****Basic Calibration Parameters**

|   | Sensor X | Sensor Y | Sensor Z | Unc (k=2) |
|---|----------|----------|----------|-----------|
| Norm ( $\mu\text{V}/(\text{V}/\text{m})^2$ ) <sup>A</sup> | 0.48     | 0.45     | 0.45     | ± 10.1%   |
| DCP (mV) <sup>B</sup>                                     | 94.4     | 86.2     | 90.3     |           |

**Modulation Calibration Parameters**

| UID   | Communication System Name | PAR  |   | A<br>dB | B<br>dBuV | C    | VR<br>mV | Unc <sup>E</sup><br>(k=2) |
|-------|---------------------------|------|---|---------|-----------|------|----------|---------------------------|
| 10000 | CW                        | 0.00 | X | 0.00    | 0.00      | 1.00 | 300      | ± 1.5%                    |
|       |                           |      | Y | 0.00    | 0.00      | 1.00 | 300      |                           |
|       |                           |      | Z | 0.00    | 0.00      | 1.00 | 300      |                           |

The reported uncertainty of measurement is stated as the standard uncertainty of measurement multiplied by the coverage factor k=2, which for a normal distribution corresponds to a coverage probability of approximately 95%.

<sup>A</sup> The uncertainties of NormX,Y,Z do not affect the E<sup>2</sup>-field uncertainty inside TSL (see Pages 5 and 6).

<sup>B</sup> Numerical linearization parameter: uncertainty not required.

<sup>E</sup> Uncertainty is determined using the maximum deviation from linear response applying rectangular distribution and is expressed for the square of the field value.

## DASY/EASY - Parameters of Probe: EX3DV4 SN:3698

### Calibration Parameter Determined in Head Tissue Simulating Media

| f [MHz] | Validity [MHz] <sup>c</sup> | Permittivity | Conductivity | ConvF X | ConvF Y | ConvF Z | Alpha | Depth Unc (k=2) |
|---------|-----------------------------|--------------|--------------|---------|---------|---------|-------|-----------------|
| 850     | ± 50 / ± 100                | 41.5 ± 5%    | 0.92 ± 5%    | 8.23    | 8.23    | 8.23    | 0.99  | 0.52 ± 11.0%    |
| 900     | ± 50 / ± 100                | 41.5 ± 5%    | 0.97 ± 5%    | 8.52    | 8.52    | 8.52    | 0.71  | 0.61 ± 11.0%    |
| 1810    | ± 50 / ± 100                | 40.0 ± 5%    | 1.40 ± 5%    | 7.34    | 7.34    | 7.34    | 0.59  | 0.69 ± 11.0%    |
| 1900    | ± 50 / ± 100                | 40.0 ± 5%    | 1.40 ± 5%    | 7.32    | 7.32    | 7.32    | 0.66  | 0.64 ± 11.0%    |
| 2450    | ± 50 / ± 100                | 39.2 ± 5%    | 1.80 ± 5%    | 6.77    | 6.77    | 6.77    | 0.39  | 0.80 ± 11.0%    |
| 2600    | ± 50 / ± 100                | 39.0 ± 5%    | 1.96 ± 5%    | 6.76    | 6.76    | 6.76    | 0.24  | 1.19 ± 11.0%    |
| 3500    | ± 50 / ± 100                | 37.9 ± 5%    | 2.91 ± 5%    | 6.51    | 6.51    | 6.51    | 0.20  | 1.85 ± 13.1%    |
| 5200    | ± 50 / ± 100                | 36.0 ± 5%    | 4.66 ± 5%    | 4.63    | 4.63    | 4.63    | 0.45  | 1.80 ± 13.1%    |
| 5300    | ± 50 / ± 100                | 35.9 ± 5%    | 4.76 ± 5%    | 4.44    | 4.44    | 4.44    | 0.45  | 1.80 ± 13.1%    |
| 5500    | ± 50 / ± 100                | 35.6 ± 5%    | 4.96 ± 5%    | 4.42    | 4.42    | 4.42    | 0.50  | 1.80 ± 13.1%    |
| 5600    | ± 50 / ± 100                | 35.5 ± 5%    | 5.07 ± 5%    | 4.14    | 4.14    | 4.14    | 0.50  | 1.80 ± 13.1%    |
| 5800    | ± 50 / ± 100                | 35.3 ± 5%    | 5.27 ± 5%    | 4.05    | 4.05    | 4.05    | 0.50  | 1.80 ± 13.1%    |

<sup>c</sup> The validity of ± 100 MHz only applies for DASY v4.4 and higher (see Page 2). The uncertainty is the RSS of the ConvF uncertainty at calibration frequency and the uncertainty for the indicated frequency band.



## DASY/EASY - Parameters of Probe: EX3DV4 SN:3698

### Calibration Parameter Determined in Body Tissue Simulating Media

| f [MHz] | Validity [MHz] <sup>c</sup> | Permittivity | Conductivity | ConvF X | ConvF Y | ConvF Z | Alpha | Depth Unc (k=2) |
|---------|-----------------------------|--------------|--------------|---------|---------|---------|-------|-----------------|
| 850     | ± 50 / ± 100                | 55.2 ± 5%    | 0.99 ± 5%    | 8.21    | 8.21    | 8.21    | 0.99  | 0.53 ± 11.0%    |
| 900     | ± 50 / ± 100                | 55.0 ± 5%    | 1.05 ± 5%    | 8.61    | 8.61    | 8.61    | 0.59  | 0.73 ± 11.0%    |
| 1810    | ± 50 / ± 100                | 53.3 ± 5%    | 1.52 ± 5%    | 7.22    | 7.22    | 7.22    | 0.71  | 0.62 ± 11.0%    |
| 1900    | ± 50 / ± 100                | 53.3 ± 5%    | 1.52 ± 5%    | 7.16    | 7.16    | 7.16    | 0.84  | 0.59 ± 11.0%    |
| 2450    | ± 50 / ± 100                | 52.7 ± 5%    | 1.95 ± 5%    | 7.01    | 7.01    | 7.01    | 0.44  | 0.81 ± 11.0%    |
| 2600    | ± 50 / ± 100                | 52.5 ± 5%    | 2.16 ± 5%    | 7.00    | 7.00    | 7.00    | 0.35  | 0.95 ± 11.0%    |
| 3500    | ± 50 / ± 100                | 51.3 ± 5%    | 3.31 ± 5%    | 5.93    | 5.93    | 5.93    | 0.25  | 1.60 ± 13.1%    |
| 5200    | ± 50 / ± 100                | 49.0 ± 5%    | 5.30 ± 5%    | 4.11    | 4.11    | 4.11    | 0.55  | 1.95 ± 13.1%    |
| 5300    | ± 50 / ± 100                | 48.5 ± 5%    | 5.42 ± 5%    | 3.89    | 3.89    | 3.89    | 0.55  | 1.95 ± 13.1%    |
| 5500    | ± 50 / ± 100                | 48.6 ± 5%    | 5.65 ± 5%    | 3.40    | 3.40    | 3.40    | 0.60  | 1.95 ± 13.1%    |
| 5600    | ± 50 / ± 100                | 48.5 ± 5%    | 5.77 ± 5%    | 3.20    | 3.20    | 3.20    | 0.65  | 1.95 ± 13.1%    |
| 5800    | ± 50 / ± 100                | 48.2 ± 5%    | 6.00 ± 5%    | 3.48    | 3.48    | 3.48    | 0.65  | 1.90 ± 13.1%    |

<sup>c</sup> The validity of ± 100 MHz only applies for DASY v4.4 and higher (see Page 2). The uncertainty is the RSS of the ConvF uncertainty at calibration frequency and the uncertainty for the indicated frequency band.

### Frequency Response of E-Field

(TEM-Cell:ifi110 EXX, Waveguide: R22)

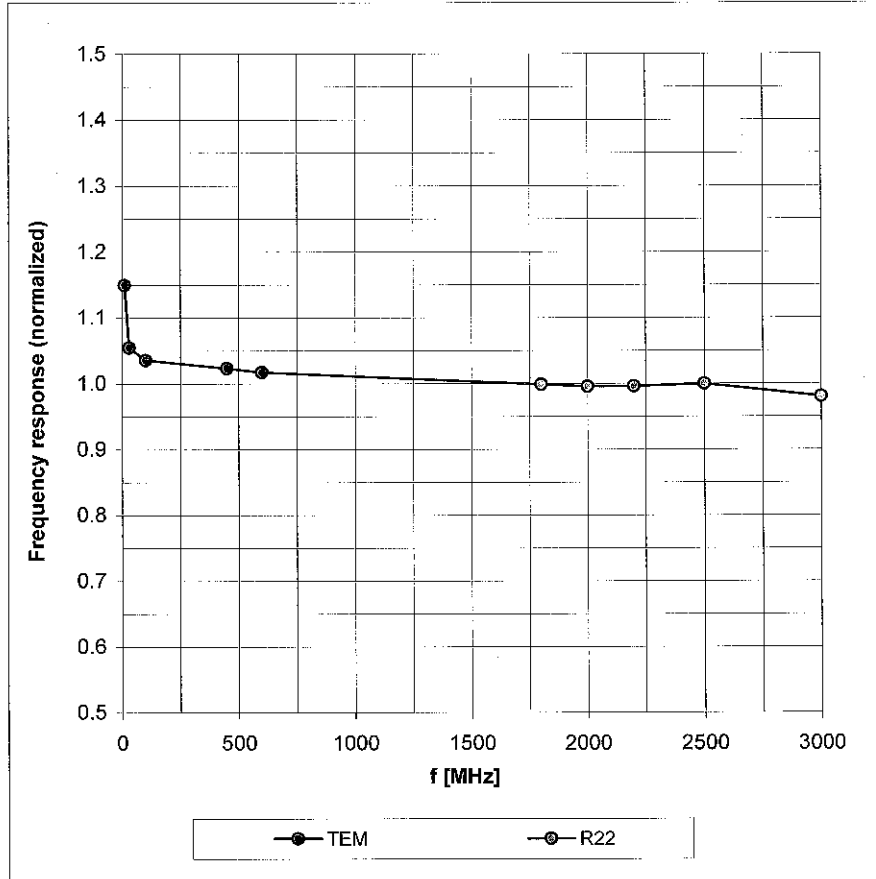

Uncertainty of Frequency Response of E-field:  $\pm 6.3\%$  ( $k=2$ )

### Receiving Pattern ( $\phi$ ), $\theta = 0^\circ$

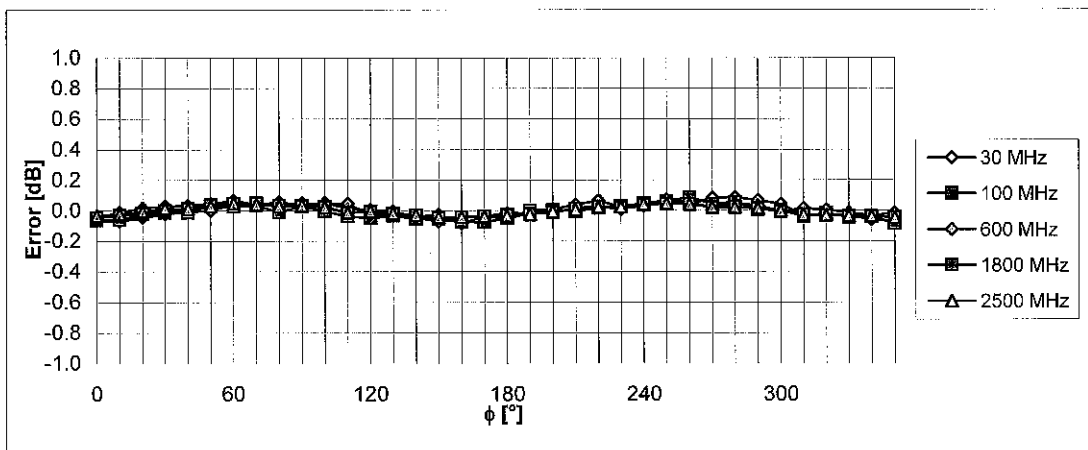
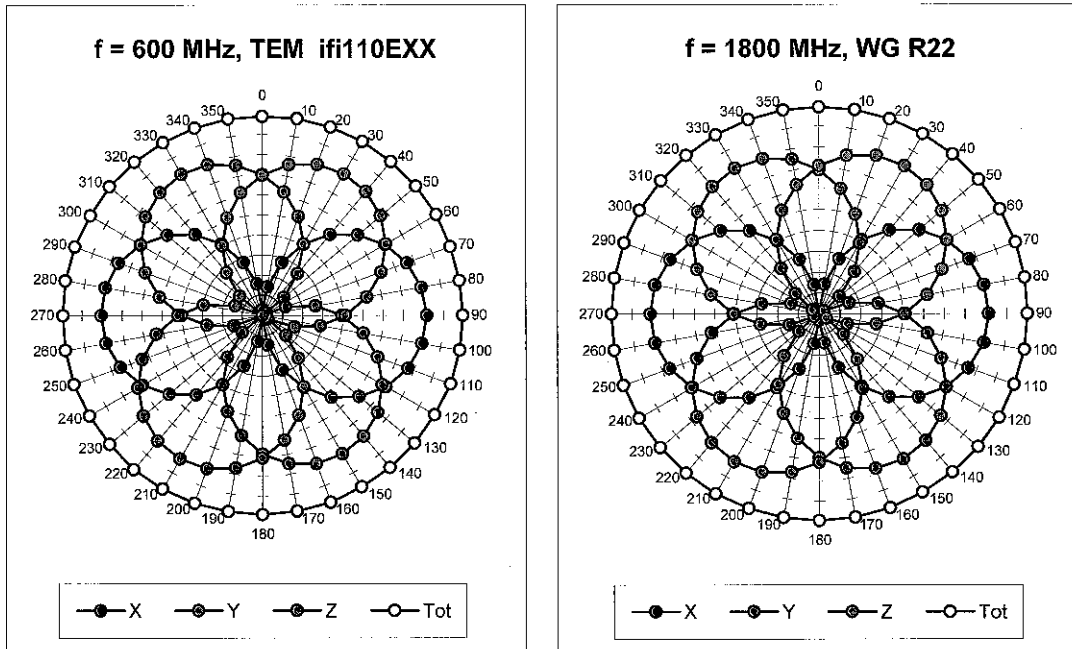

Uncertainty of Axial Isotropy Assessment:  $\pm 0.5\%$  ( $k=2$ )

### Dynamic Range f(SAR<sub>head</sub>) (Waveguide R22, f = 1800 MHz)

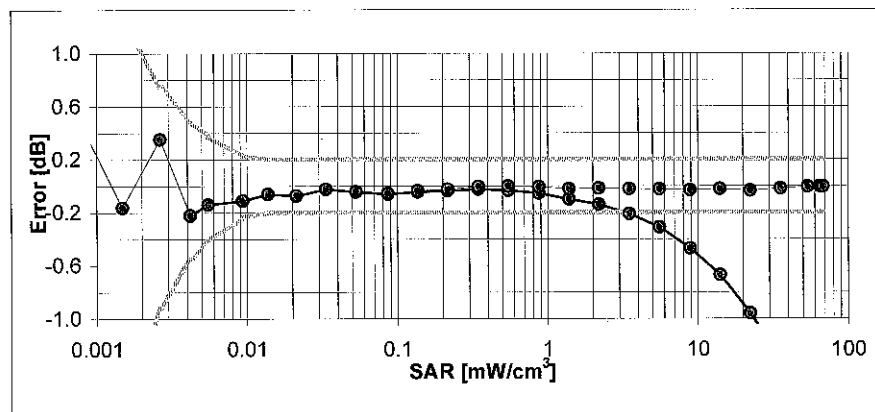
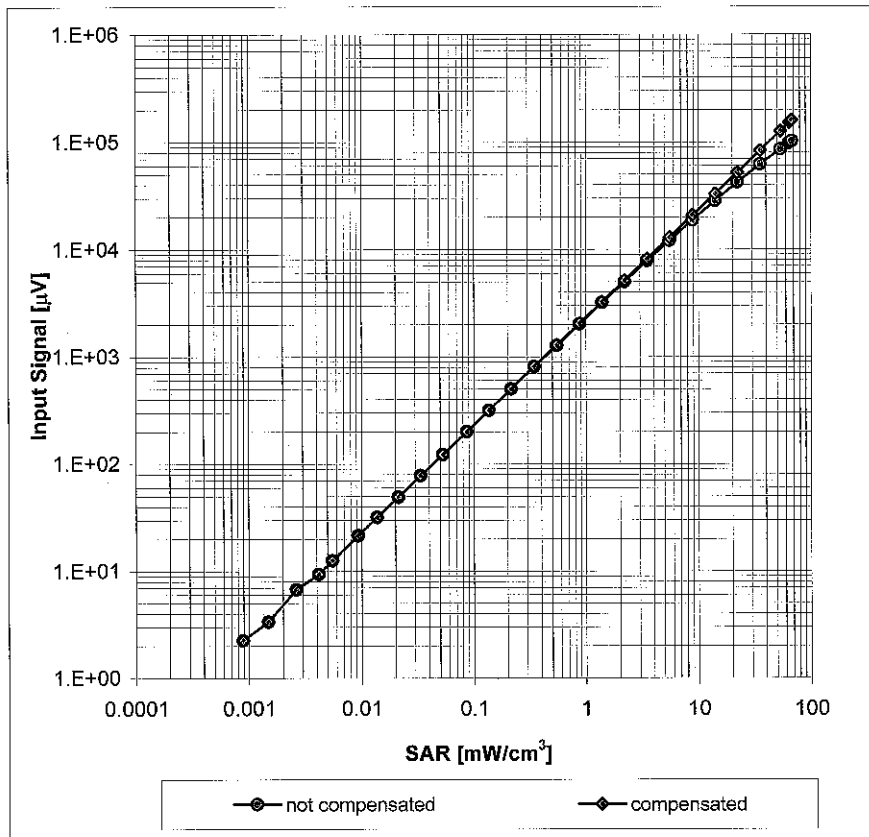

Uncertainty of Linearity Assessment: ± 0.6% (k=2)

### Conversion Factor Assessment

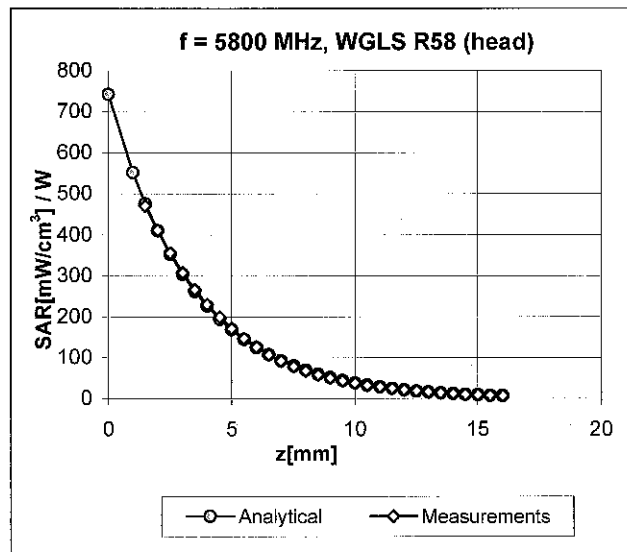
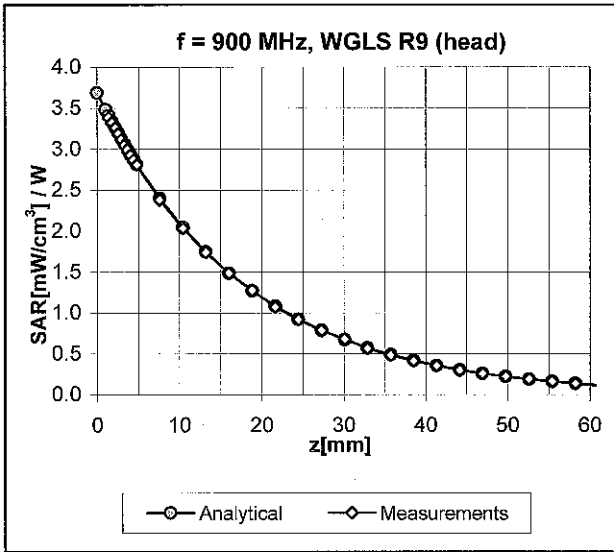

### Deviation from Isotropy in HSL

Error ( $\phi, \vartheta$ ), f = 900 MHz

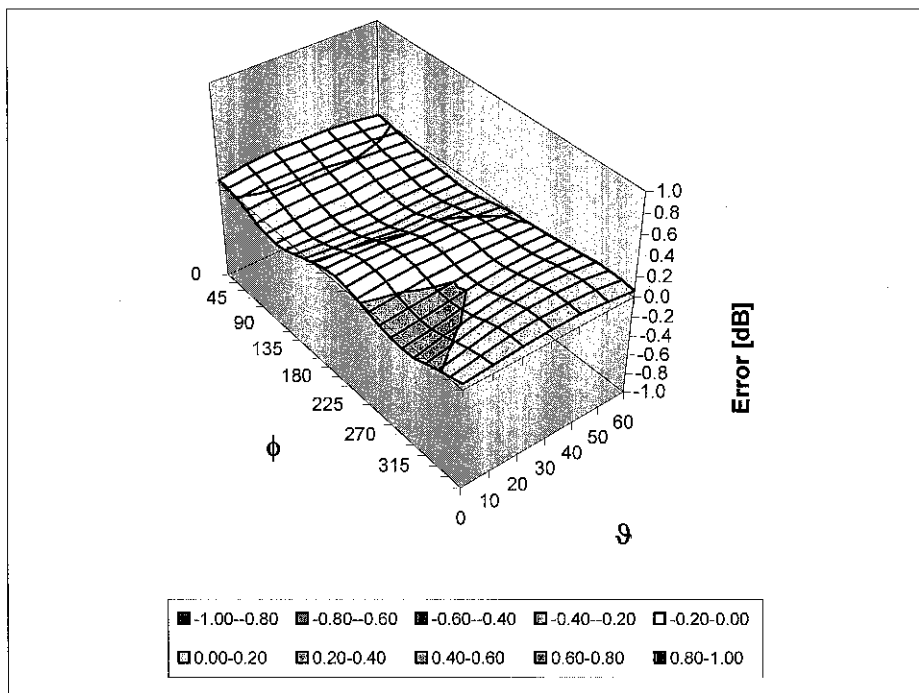

Uncertainty of Spherical Isotropy Assessment:  $\pm 2.6\%$  (k=2)

## Other Probe Parameters

|   |                |
|---|----------------|
| Sensor Arrangement                            | Triangular     |
| Connector Angle (°)                           | Not applicable |
| Mechanical Surface Detection Mode             | enabled        |
| Optical Surface Detection Mode                | disabled       |
| Probe Overall Length                          | 337 mm         |
| Probe Body Diameter                           | 10 mm          |
| Tip Length                                    | 9 mm           |
| Tip Diameter                                  | 2.5 mm         |
| Probe Tip to Sensor X Calibration Point       | 1 mm           |
| Probe Tip to Sensor Y Calibration Point       | 1 mm           |
| Probe Tip to Sensor Z Calibration Point       | 1 mm           |
| Recommended Measurement Distance from Surface | 2 mm           |



## **Appendix E. Dipole Calibration**

**Validation Dipole 2450 MHz**

**M/N: ALS-D-2450**

**S/N: QTK-319**

55

**Calibration Laboratory of**  
**Schmid & Partner**  
**Engineering AG**  
Zeughausstrasse 43, 8004 Zurich, Switzerland



**S** Schweizerischer Kalibrierdienst  
**S** Service suisse d'étalonnage  
**C** Servizio svizzero di taratura  
**S** Swiss Calibration Service

Accredited by the Swiss Accreditation Service (SAS)  
The Swiss Accreditation Service is one of the signatories to the EA  
Multilateral Agreement for the recognition of calibration certificates

Accreditation No.: **SCS 108**

Client **Quietek (Auden)**

Certificate No: **ALS-2450-QTK-319\_May10**

# CALIBRATION CERTIFICATE

Object **ALS-D-2450-SN: QTK-319**

Calibration procedure(s) **QA CAL-05.v7  
Calibration procedure for dipole validation kits**

Calibration date: **May 27, 2010**

This calibration certificate documents the traceability to national standards, which realize the physical units of measurements (SI).  
The measurements and the uncertainties with confidence probability are given on the following pages and are part of the certificate.

All calibrations have been conducted in the closed laboratory facility: environment temperature (22 ± 3)°C and humidity < 70%.

Calibration Equipment used (M&TE critical for calibration)

| Primary Standards           | ID #               | Cal Date (Certificate No.)        | Scheduled Calibration  |
|-----------------------------|--------------------|-----------------------------------|------------------------|
| Power meter EPM-442A        | GB37480704         | 06-Oct-09 (No. 217-01086)         | Oct-10                 |
| Power sensor HP 8481A       | US37292783         | 06-Oct-09 (No. 217-01086)         | Oct-10                 |
| Reference 20 dB Attenuator  | SN: 5086 (20g)     | 30-Mar-10 (No. 217-01158)         | Mar-11                 |
| Type-N mismatch combination | SN: 5047.2 / 06327 | 30-Mar-10 (No. 217-01162)         | Mar-11                 |
| Reference Probe ES3DV3      | SN: 3205           | 30-Apr-10 (No. ES3-3205_Apr10)    | Apr-11                 |
| DAE4                        | SN: 601            | 02-Mar-10 (No. DAE4-601_Mar10)    | Mar-11                 |
| Secondary Standards         | ID #               | Check Date (in house)             | Scheduled Check        |
| Power sensor HP 8481A       | MY41092317         | 18-Oct-02 (in house check Oct-09) | In house check: Oct-11 |
| RF generator R&S SMT-06     | 100005             | 4-Aug-99 (in house check Oct-09)  | In house check: Oct-11 |
| Network Analyzer HP 8753E   | US37390585 S4206   | 18-Oct-01 (in house check Oct-09) | In house check: Oct-10 |

|                |             |                       |                  |
|----------------|-------------|-----------------------|------------------|
|                | <b>Name</b> | <b>Function</b>       | <b>Signature</b> |
| Calibrated by: | Dimce Iliev | Laboratory Technician |                  |

|              |               |                   |                  |
|--------------|---------------|-------------------|------------------|
|              | <b>Name</b>   | <b>Function</b>   | <b>Signature</b> |
| Approved by: | Katja Pokovic | Technical Manager |                  |

Issued: May 27, 2010

This calibration certificate shall not be reproduced except in full without written approval of the laboratory.





Accredited by the Swiss Accreditation Service (SAS)  
The Swiss Accreditation Service is one of the signatories to the EA  
Multilateral Agreement for the recognition of calibration certificates

Accreditation No.: **SCS 108**

**Glossary:**

|       |                                 |
|-------|---------------------------------|
| TSL   | tissue simulating liquid        |
| ConvF | sensitivity in TSL / NORM x,y,z |
| N/A   | not applicable or not measured  |

**Calibration is Performed According to the Following Standards:**

- a) IEEE Std 1528-2003, "IEEE Recommended Practice for Determining the Peak Spatial-Averaged Specific Absorption Rate (SAR) in the Human Head from Wireless Communications Devices: Measurement Techniques", December 2003
- b) IEC 62209-1, "Procedure to measure the Specific Absorption Rate (SAR) for hand-held devices used in close proximity to the ear (frequency range of 300 MHz to 3 GHz)", February 2005
- c) Federal Communications Commission Office of Engineering & Technology (FCC OET), "Evaluating Compliance with FCC Guidelines for Human Exposure to Radiofrequency Electromagnetic Fields; Additional Information for Evaluating Compliance of Mobile and Portable Devices with FCC Limits for Human Exposure to Radiofrequency Emissions", Supplement C (Edition 01-01) to Bulletin 65

**Additional Documentation:**

- d) DASY4/5 System Handbook

**Methods Applied and Interpretation of Parameters:**

- *Measurement Conditions:* Further details are available from the Validation Report at the end of the certificate. All figures stated in the certificate are valid at the frequency indicated.
- *Antenna Parameters with TSL:* The dipole is mounted with the spacer to position its feed point exactly below the center marking of the flat phantom section, with the arms oriented parallel to the body axis.
- *Feed Point Impedance and Return Loss:* These parameters are measured with the dipole positioned under the liquid filled phantom. The impedance stated is transformed from the measurement at the SMA connector to the feed point. The Return Loss ensures low reflected power. No uncertainty required.
- *Electrical Delay:* One-way delay between the SMA connector and the antenna feed point. No uncertainty required.
- *SAR measured:* SAR measured at the stated antenna input power.
- *SAR normalized:* SAR as measured, normalized to an input power of 1 W at the antenna connector.
- *SAR for nominal TSL parameters:* The measured TSL parameters are used to calculate the nominal SAR result.

## Measurement Conditions

DASY system configuration, as far as not given on page 1.

|                                     |                           |             |
|-------------------------------------|---------------------------|-------------|
| <b>DASY Version</b>                 | DASY5                     | V5.2        |
| <b>Extrapolation</b>                | Advanced Extrapolation    |             |
| <b>Phantom</b>                      | Modular Flat Phantom V4.9 |             |
| <b>Distance Dipole Center - TSL</b> | 10 mm                     | with Spacer |
| <b>Zoom Scan Resolution</b>         | dx, dy, dz = 5 mm         |             |
| <b>Frequency</b>                    | 2450 MHz ± 1 MHz          |             |

## Head TSL parameters

The following parameters and calculations were applied.

|   | Temperature     | Permittivity | Conductivity     |
|---|-----------------|--------------|------------------|
| <b>Nominal Head TSL parameters</b>      | 22.0 °C         | 39.2         | 1.80 mho/m       |
| <b>Measured Head TSL parameters</b>     | (22.0 ± 0.2) °C | 39.0 ± 6 %   | 1.76 mho/m ± 6 % |
| <b>Head TSL temperature during test</b> | (21.5 ± 0.2) °C | ----         | ----             |

## SAR result with Head TSL

| <b>SAR averaged over 1 cm<sup>3</sup> (1 g) of Head TSL</b> | Condition          |                                  |
|---|--------------------|----------------------------------|
| SAR measured  | 250 mW input power | 12.8 mW / g                      |
| SAR normalized  | normalized to 1W   | 51.2 mW / g                      |
| SAR for nominal Head TSL parameters                         | normalized to 1W   | <b>51.7 mW /g ± 17.0 % (k=2)</b> |

| <b>SAR averaged over 10 cm<sup>3</sup> (10 g) of Head TSL</b> | condition          |                                  |
|---|--------------------|----------------------------------|
| SAR measured  | 250 mW input power | 5.98 mW / g                      |
| SAR normalized  | normalized to 1W   | 23.9 mW / g                      |
| SAR for nominal Head TSL parameters                           | normalized to 1W   | <b>24.0 mW /g ± 16.5 % (k=2)</b> |

## Body TSL parameters

The following parameters and calculations were applied.

|   | Temperature     | Permittivity | Conductivity     |
|---|-----------------|--------------|------------------|
| <b>Nominal Body TSL parameters</b>      | 22.0 °C         | 52.7         | 1.95 mho/m       |
| <b>Measured Body TSL parameters</b>     | (22.0 ± 0.2) °C | 53.6 ± 6 %   | 1.97 mho/m ± 6 % |
| <b>Body TSL temperature during test</b> | (21.5 ± 0.2) °C | ----         | ----             |

## SAR result with Body TSL

| <b>SAR averaged over 1 cm<sup>3</sup> (1 g) of Body TSL</b> | Condition          |                                   |
|---|--------------------|-----------------------------------|
| SAR measured  | 250 mW input power | 13.0 mW / g                       |
| SAR normalized  | normalized to 1W   | 52.0 mW / g                       |
| SAR for nominal Body TSL parameters                         | normalized to 1W   | <b>51.9 mW / g ± 17.0 % (k=2)</b> |

| <b>SAR averaged over 10 cm<sup>3</sup> (10 g) of Body TSL</b> | condition          |                                   |
|---|--------------------|-----------------------------------|
| SAR measured  | 250 mW input power | 6.10 mW / g                       |
| SAR normalized  | normalized to 1W   | 24.4 mW / g                       |
| SAR for nominal Body TSL parameters                           | normalized to 1W   | <b>24.4 mW / g ± 16.5 % (k=2)</b> |

## Appendix

### Antenna Parameters with Head TSL

|                                      |                             |
|--------------------------------------|-----------------------------|
| Impedance, transformed to feed point | $39.0 \Omega + 1.0 j\Omega$ |
| Return Loss                          | - 18.1 dB                   |

### Antenna Parameters with Body TSL

|                                      |                             |
|--------------------------------------|-----------------------------|
| Impedance, transformed to feed point | $41.7 \Omega - 6.3 j\Omega$ |
| Return Loss                          | - 18.9 dB                   |

### General Antenna Parameters and Design

|                                  |          |
|----------------------------------|----------|
| Electrical Delay (one direction) | 1.183 ns |
|----------------------------------|----------|

After long term use with 100W radiated power, only a slight warming of the dipole near the feedpoint can be measured.

The dipole is made of standard semirigid coaxial cable. The center conductor of the feeding line is directly connected to the second arm of the dipole. The antenna is therefore short-circuited for DC-signals.

No excessive force must be applied to the dipole arms, because they might bend or the soldered connections near the feedpoint may be damaged.

### Additional EUT Data

|                 |               |
|-----------------|---------------|
| Manufactured by | APREL         |
| Manufactured on | Not available |

## DASY5 Validation Report for Head TSL

Date/Time: 25.05.2010 16:00:07

Test Laboratory: SPEAG, Zurich, Switzerland

**DUT: Dipole 2450 MHz; Type: D2450V2; Serial: D2450V2 - SN:QTK-319**

Communication System: CW; Frequency: 2450 MHz; Duty Cycle: 1:1

Medium: HSL U11 BB

Medium parameters used:  $f = 2450$  MHz;  $\sigma = 1.76$  mho/m;  $\epsilon_r = 39$ ;  $\rho = 1000$  kg/m<sup>3</sup>

Phantom section: Flat Section

Measurement Standard: DASY5 (IEEE/IEC/ANSI C63.19-2007)

DASY5 Configuration:

- Probe: ES3DV3 - SN3205; ConvF(4.53, 4.53, 4.53); Calibrated: 30.04.2010
- Sensor-Surface: 3mm (Mechanical Surface Detection)
- Electronics: DAE4 Sn601; Calibrated: 02.03.2010
- Phantom: Flat Phantom 5.0 (front); Type: QD000P50AA; Serial: 1001
- Measurement SW: DASY5, V5.2 Build 162; SEMCAD X Version 14.0 Build 61

**Pin=250 mW /d=10mm, dist=3.0mm (ES-Probe)/Zoom Scan (7x7x7) /Cube 0:** Measurement grid: dx=5mm, dy=5mm, dz=5mm

Reference Value = 101.0 V/m; Power Drift = 0.042 dB

Peak SAR (extrapolated) = 26.6 W/kg

**SAR(1 g) = 12.8 mW/g; SAR(10 g) = 5.98 mW/g**

Maximum value of SAR (measured) = 16.8 mW/g

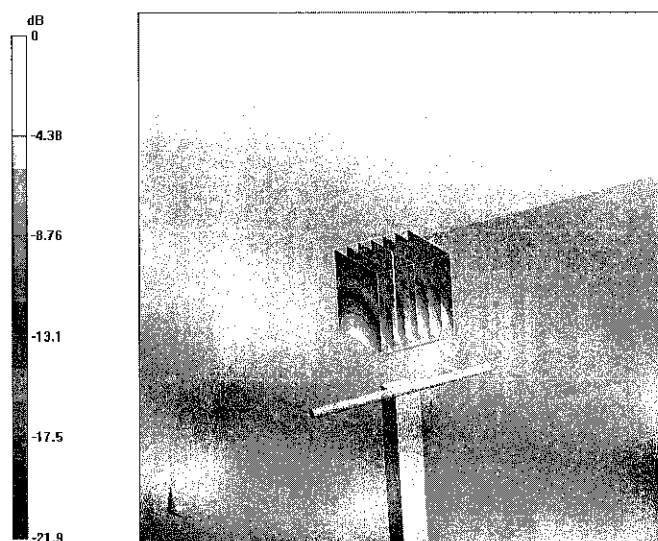

0 dB = 16.8mW/g

# Impedance Measurement Plot for Head TSL

25 May 2010 10:25:46

CH1 S11 1 U FS 3: 39.027  $\Omega$  1.0352  $\Omega$  67.245  $\mu\text{H}$  2 450.000 005 MHz

\*  
Del  
Cor

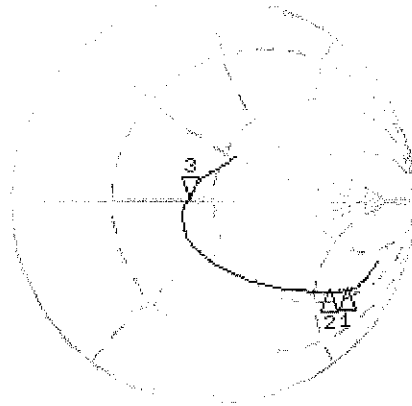

CH1 Markers  
1: 50.023  $\Omega$   
-139.22  $\Omega$   
1.80000 GHz  
2: 51.352  $\Omega$   
-117.16  $\Omega$   
1.90000 GHz

Avg  
16  
↑

CH2 S11 LOG 5 dB/REF -20 dB 3: -18.146 dB 2 450.000 005 MHz

Cor

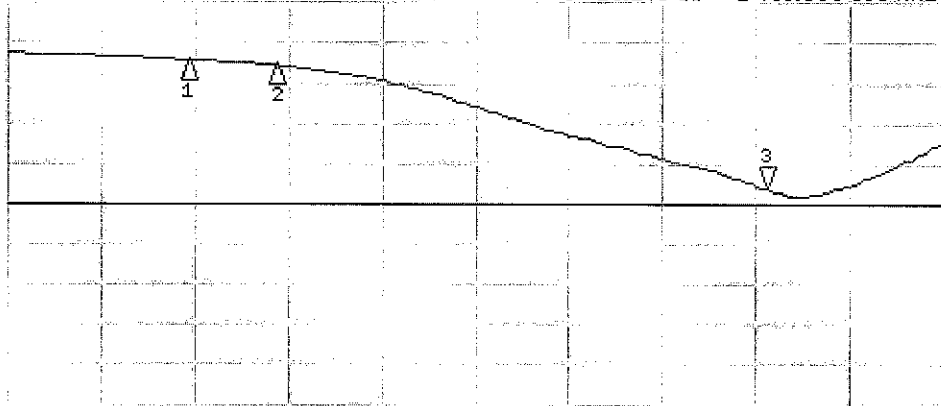

CH2 Markers  
1: -2.0848 dB  
1.80000 GHz  
2: -2.7551 dB  
1.90000 GHz

Avg  
16  
↑

START 1 800.000 000 MHz

STOP 2 650.000 000 MHz

## DASY5 Validation Report for Body

Date/Time: 27.05.2010 11:36:56

Test Laboratory: SPEAG, Zurich, Switzerland

**DUT: Dipole 2450 MHz; Type: D2450V2; Serial: D2450V2 - SN:QTK-319**

Communication System: CW; Frequency: 2450 MHz; Duty Cycle: 1:1

Medium: MSL U11 BB

Medium parameters used:  $f = 2450$  MHz;  $\sigma = 1.98$  mho/m;  $\epsilon_r = 53.7$ ;  $\rho = 1000$  kg/m<sup>3</sup>

Phantom section: Flat Section

Measurement Standard: DASY5 (IEEE/IEC/ANSI C63.19-2007)

DASY5 Configuration:

- Probe: ES3DV3 - SN3205; ConvF(4.31, 4.31, 4.31); Calibrated: 30.04.2010
- Sensor-Surface: 3mm (Mechanical Surface Detection)
- Electronics: DAE4 Sn601; Calibrated: 02.03.2010
- Phantom: Flat Phantom 5.0 (back); Type: QD000P50AA; Serial: 1002
- Measurement SW: DASY5, V5.2 Build 162; SEMCAD X Version 14.0 Build 61

**Pin=250 mW /d=10mm, dist=3.0mm (ES-Probe)/Zoom Scan (7x7x7) /Cube 0:** Measurement grid: dx=5mm, dy=5mm, dz=5mm

Reference Value = 95.3 V/m; Power Drift = -0.029 dB

Peak SAR (extrapolated) = 26.6 W/kg

**SAR(1 g) = 13 mW/g; SAR(10 g) = 6.1 mW/g**

Maximum value of SAR (measured) = 17 mW/g

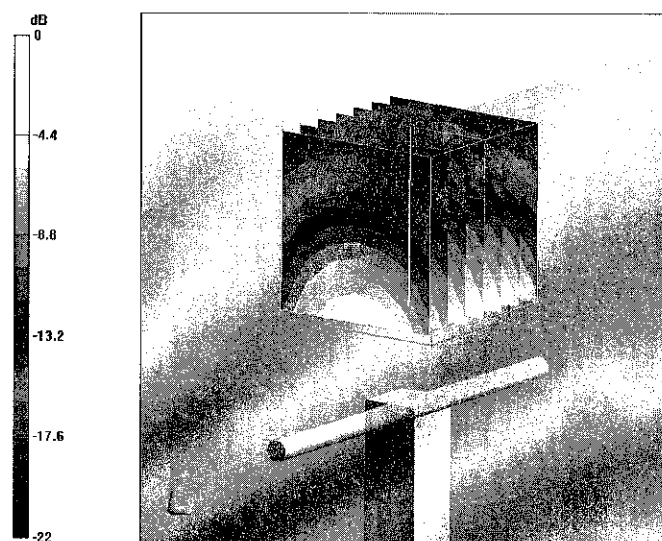

0 dB = 17mW/g

# Impedance Measurement Plot for Body TSL

27 May 2010 08:43:24

CH1 S11 1 U FS 1: 41.660  $\Omega$  -6.3301  $\Omega$  10.252 pF 2 450.000 000 MHz

\*  
De1  
Cor

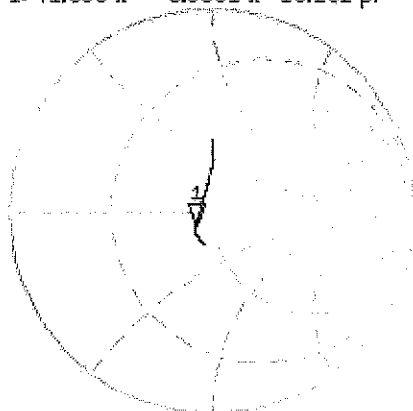

Avg  
16  
↑

CH2 S11 LOG 5 dB/REF -20 dB 1:-18.867 dB 2 450.000 000 MHz

Cor

Avg  
16  
↑

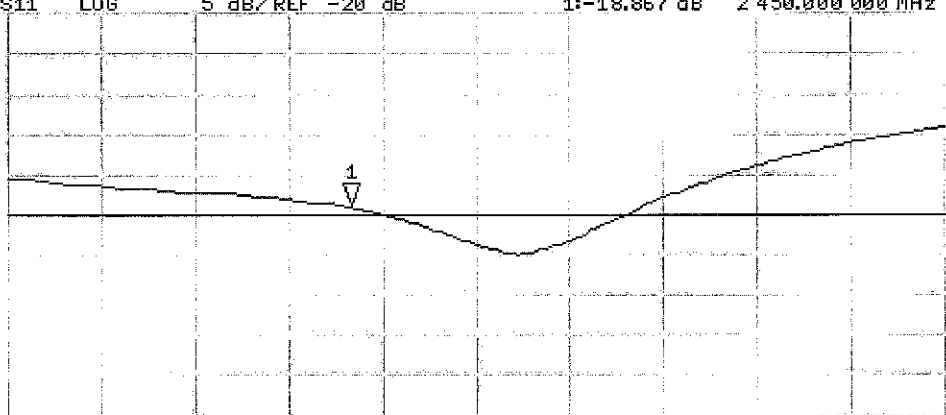

START 2 250.000 000 MHz

STOP 2 800.000 000 MHz