



# SPORTON International Inc.

No. 52, Hwa Ya 1st Rd., Kwei-Shan Hsiang, TaoYuan Hsien, Taiwan, R.O.C.  
Ph: 886-3-327-3456 / FAX: 886-3-327-0973 / www.sporton.com.tw

## FCC RADIO TEST REPORT

Applicant's company	GIGA-BYTE TECHNOLOGY CO., LTD.
Applicant Address	No.6, Bau Chiang Road, Hsin-Tien, Taipei Hsien, Taiwan, R.O.C.
FCC ID	JCK-GN-WS31N-RH
Manufacturer's company	GIGA-BYTE TECHNOLOGY CO., LTD.
Manufacturer Address	No.6, Bau Chiang Road, Hsin-Tien, Taipei Hsien, Taiwan, R.O.C.

Product Name	AirCruiser N300 Mini Card
Brand Name	GIGA-BYTE
Model Name	GN-WS31N-RH
Test Rule	47 CFR FCC Part 15 Subpart C § 15.247
Test Freq. Range	2400 ~ 2483.5MHz
Received Date	Oct. 9, 2007
Final Test Date	Nov. 27, 2007
Submission Type	Original Equipment

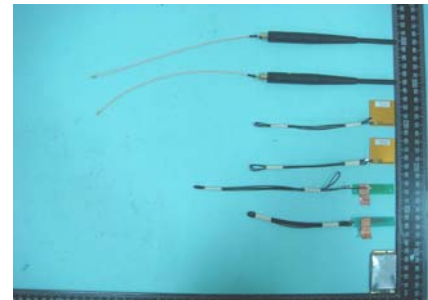

### Statement

**Test result included is only for the Draft n part of the product.**

The test result in this report refers exclusively to the presented test model / sample.

Without written approval of SPORTON International Inc., the test report shall not be reproduced except in full.

The measurements and test results shown in this test report were made in accordance with the procedures

and found in compliance with the limit given in **ANSI C63.4-2003** and **47 CFR FCC Part 15 Subpart C**.

The test equipment used to perform the test is calibrated and traceable to NML/ROC.



## Table of Contents

<b>1. CERTIFICATE OF COMPLIANCE .....</b>	<b>1</b>
<b>2. SUMMARY OF THE TEST RESULT .....</b>	<b>2</b>
<b>3. GENERAL INFORMATION .....</b>	<b>3</b>
3.1. Product Details.....	3
3.2. Accessories.....	4
3.3. Table for Filed Antenna.....	5
3.4. Table for Carrier Frequencies .....	6
3.5. Table for Test Modes .....	6
3.6. Table for Testing Locations.....	7
3.7. Table for Supporting Units .....	7
3.8. Table for Parameters of Test Software Setting .....	8
3.9. Test Configurations .....	9
<b>4. TEST RESULT .....</b>	<b>11</b>
4.1. AC Power Line Conducted Emissions Measurement.....	11
4.2. Maximum Peak Output Power Measurement .....	21
4.3. Power Spectral Density Measurement .....	23
4.4. 6dB Spectrum Bandwidth Measurement .....	28
4.5. Radiated Emissions Measurement .....	33
4.6. Band Edge Emissions Measurement .....	93
4.7. Antenna Requirements .....	104
<b>5. LIST OF MEASURING EQUIPMENTS .....</b>	<b>105</b>
<b>6. TEST LOCATION.....</b>	<b>107</b>
<b>7. TAF CERTIFICATE OF ACCREDITATION .....</b>	<b>108</b>
<b>APPENDIX A. PHOTOGRAPHS OF EUT.....</b>	<b>A1 ~ A13</b>
<b>APPENDIX B. TEST PHOTOS.....</b>	<b>B1 ~ B21</b>
<b>APPENDIX C. MAXIMUM PERMISSIBLE EXPOSURE.....</b>	<b>C1 ~C3</b>
<b>APPENDIX D. ANTENNA LIST .....</b>	<b>D1 ~D4</b>





## 1. CERTIFICATE OF COMPLIANCE

Product Name : AirCruiser N300 Mini Card  
Brand Name : GIGA-BYTE  
Model Name : GN-WS31N-RH  
Applicant : GIGA-BYTE TECHNOLOGY CO., LTD.  
Test Rule Part(s) : 47 CFR FCC Part 15 Subpart C § 15.247

Sporton International as requested by the applicant to evaluate the EMC performance of the product sample received on Oct. 9, 2007 would like to declare that the tested sample has been evaluated and found to be in compliance with the tested rule parts. The data recorded as well as the test configuration specified is true and accurate for showing the sample's EMC nature.

A handwritten signature in blue ink that reads 'Wayne Hsu 5.3.08'. The signature is written in a cursive style.

Wayne Hsu

SPORTON INTERNATIONAL INC.

## 2. SUMMARY OF THE TEST RESULT

Applied Standard: 47 CFR FCC Part 15 Subpart C				
Part	Rule Section	Description of Test	Result	Under Limit
4.1	15.207	AC Power Line Conducted Emissions	Complies	6.28 dB
4.2	15.247(b)(3)	Maximum Peak Conducted Output Power	Complies	5.60 dB
4.3	15.247(e)	Power Spectral Density	Complies	20.17 dB
4.4	15.247(a)(2)	6dB Spectrum Bandwidth	Complies	-
4.5	15.247(d)	Radiated Emissions	Complies	3.03 dB
4.6	15.247(d)	Band Edge Emissions	Complies	0.14 dB
4.7	15.203	Antenna Requirements	Complies	-

Test Items	Uncertainty	Remark
AC Power Line Conducted Emissions	±2.3dB	Confidence levels of 95%
Maximum Peak Conducted Output Power	±0.8dB	Confidence levels of 95%
Power Spectral Density	±0.5dB	Confidence levels of 95%
6dB Spectrum Bandwidth	±8.5×10 <sup>-8</sup>	Confidence levels of 95%
Radiated Emissions (9kHz~30MHz)	±0.8dB	Confidence levels of 95%
Radiated Emissions (30MHz~1000MHz)	±1.9dB	Confidence levels of 95%
Radiated / Band Edge Emissions (1GHz~18GHz)	±1.9dB	Confidence levels of 95%
Radiated Emissions (18GHz~40GHz)	±1.9dB	Confidence levels of 95%
Temperature	±0.7°C	Confidence levels of 95%
Humidity	±3.2%	Confidence levels of 95%
DC / AC Power Source	±1.4%	Confidence levels of 95%

### 3. GENERAL INFORMATION

#### 3.1. Product Details

Items	Description
Product Type	WLAN (1TX, 2RX)
Radio Type	Intentional Transceiver
Power Type	From Host System
Modulation	see the below table for draft n
Data Modulation	OFDM (BPSK / QPSK / 16QAM / 64QAM)
Data Rate (Mbps)	see the below table for Draft n
Frequency Range	2400 ~ 2483.5MHz
Channel Number	11 for 20MHz bandwidth ; 7 for 40MHz bandwidth
Channel Band Width (99%)	MCS0 (20MHz) : 17.60 MHz MCS0 (40MHz) : 36.00 MHz
Conducted Output Power	MCS0 (20MHz) : 24.40 dBm MCS0 (40MHz) : 21.30 dBm
Carrier Frequencies	Please refer to section 3.4
Antenna	Please refer to section 3.3

#### Antenna & Band width

Antenna	Single (TX)	
	20 MHz	40 MHz
Band width Mode		
802.11b	V	X
802.11g	V	X
Draft n	V	V

#### Draft n spec

MCS Index	Nss	Modulation	R	NBPSK	NCBPS		NDBPS		Data rate(Mbps)	
					20MHz	40MHz	20MHz	40MHz	800nsGI	
									20MHz	40MHz
0	1	BPSK	$\frac{1}{2}$	1	52	108	26	54	6.5	13.5
1	1	QPSK	$\frac{1}{2}$	2	104	216	52	108	13.0	27.0
2	1	QPSK	$\frac{3}{4}$	2	104	216	78	162	19.5	40.5
3	1	16-QAM	$\frac{1}{2}$	4	208	432	104	216	26.0	54.0
4	1	16-QAM	$\frac{3}{4}$	4	208	432	156	324	39.0	81.0
5	1	64-QAM	$\frac{2}{3}$	6	312	648	208	432	52.0	108.0
6	1	64-QAM	$\frac{3}{4}$	6	312	648	234	486	58.5	121.5
7	1	64-QAM	$\frac{5}{6}$	6	312	648	260	540	65.0	135.0

Symbol	Explanation
NSS	Number of spatial streams
R	Code rate
NBPSC	Number of coded bits per single carrier
NCBPS	Number of coded bits per symbol
NDBPS	Number of data bits per symbol
GI	guard interval

### 3.2. Accessories

N/A

### 3.3. Table for Filed Antenna

Ant.	Brand	Model Name	Antenna Type	Connector	Gain (dBi)
A-1	Joymax	IWX-145XRSXX	Dipole Antenna	Reversed-SMA	4
A-2	Joymax	IWX-145XRSXX	Dipole Antenna	Reversed-SMA	4
B-1	Hitachi Cable	HFT40-LG02	PIFA Antenna	N/A	2.81
B-2	Hitachi Cable	HFT40-LG02	PIFA Antenna	N/A	2.81
C-1	VSO	S79-1800700-V03	PCB Antenna	N/A	0.75
C-2	VSO	S79-1800700-V03	PCB Antenna	N/A	0.75
D-1	Tyco	1909966-1	PIFA Antenna	N/A	2.99
D-2	Tyco	1909966-1	PIFA Antenna	N/A	2.99

Note: The EUT has 39 antennas. Ant. A, Ant. B, Ant. C and Ant. D is worst case and recorded in this report.

Please refer to appendix D for all 37 antennas (including Dipole, PIFA and PCB).

Connect 0 & Connect 1 could receive simultaneously.

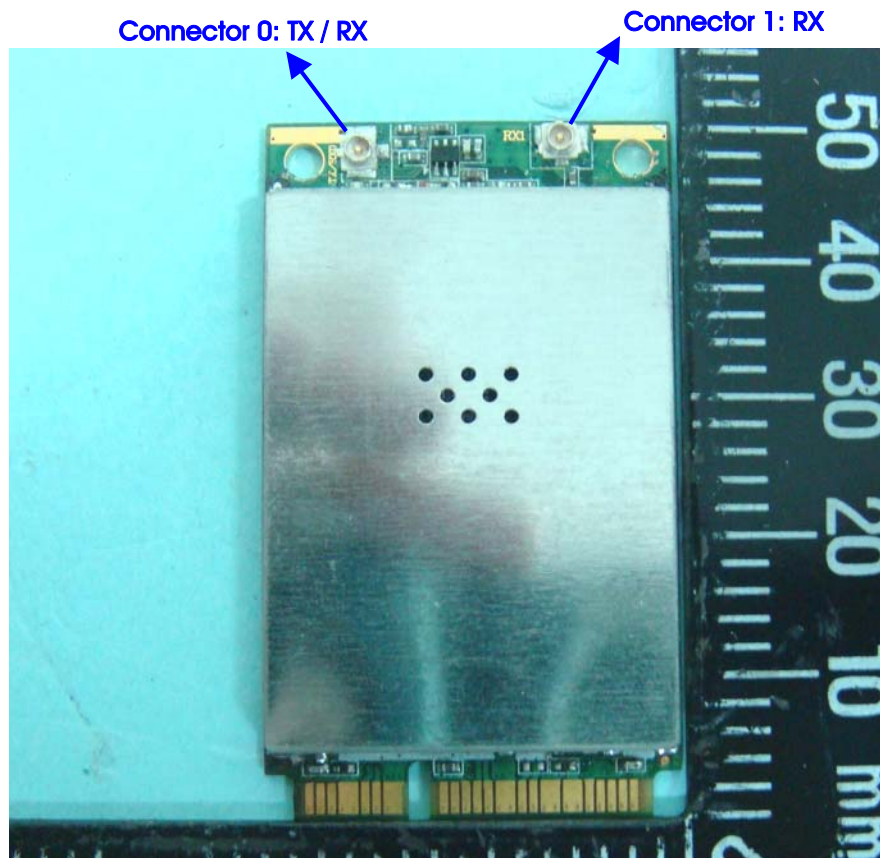



### 3.4. Table for Carrier Frequencies

There are two bandwidth systems for draft n.

For both 20MHz bandwidth systems, use Channel 1~Channel 11.

For both 40MHz bandwidth systems, use Channel 3~Channel 9.

Frequency Band	Channel No.	Frequency	Channel No.	Frequency
2400~2483.5MHz	1	2412 MHz	7	2442 MHz
	2	2417 MHz	8	2447 MHz
	3	2422 MHz	9	2452 MHz
	4	2427 MHz	10	2457 MHz
	5	2432 MHz	11	2462 MHz
	6	2437 MHz		

### 3.5. Table for Test Modes

Preliminary tests were performed in different data rate to find the worst radiated emission. The data rate shown in the table below is the worst-case rate with respect to the specific test item. Investigation has been done on all the possible configurations for searching the worst cases. The following table is a list of the test modes shown in this test report.

Test Items	Mode	Data Rate	Channel	Antenna
AC Power Line Conducted Emissions	Normal Link	Auto	-	A-1/ B-1/ C-1 / D-1
Maximum Peak Conducted Output Power	MCS0/20MHz	6.5 Mbps	1/6/11	A-1
	MCS0/40MHz	13.5 Mbps	3/6/9	A-1
Power Spectral Density 6dB Spectrum Bandwidth	MCS0/20MHz	6.5 Mbps	1/6/11	A-1
	MCS0/40MHz	13.5 Mbps	3/6/9	A-1
Radiated Emissions 9kHz~1GHz	Normal Link	Auto	-	A-1/ B-1/ C-1 / D-1
Radiated Emissions 1GHz~10 <sup>th</sup> Harmonic	MCS0/20MHz	6.5 Mbps	1/6/11	A-1/ B-1/ C-1 / D-1
	MCS0/40MHz	13.5 Mbps	3/6/9	A-1/ B-1/ C-1 / D-1
Band Edge Emissions	MCS0/20MHz	6.5 Mbps	1/11	A-1/ B-1/ C-1 / D-1
	MCS0/40MHz	13.5 Mbps	3/9	A-1/ B-1/ C-1 / D-1

The following test modes were performed for all tests:

Mode 1: Dipole Antenna mode

Mode 2: PIFA Antenna mode (Ant. Gain: 2.81dBi)

Mode 3: PCB Antenna mode

Mode 4: PIFA Antenna mode (Ant. Gain: 2.99dBi)

### 3.6. Table for Testing Locations

Test Site No.	Site Category	Location	FCC Reg. No.	IC File No.	VCCI Reg. No
03CH03-HY	SAC	Hwa Ya	101377	IC 4088	-
CO04-HY	Conduction	Hwa Ya	101377	IC 4088	-
TH01-HY	OVEN Room	Hwa Ya	-	-	-

Open Area Test Site (OATS); Semi Anechoic Chamber (SAC); Fully Anechoic Chamber (FAC).

Please refer section 6 for Test Site Address.

### 3.7. Table for Supporting Units

Support Unit	Brand	Model	FCC ID
Notebook	ASUS	A8H	PPD-AR5BxB61
Mouse	QSKY	Lx-619B	DOC
Modem	ACEEX	DM1414	IFAXDM1414
Printer	EPSON	LQ-300	DOC
AP	PLANEX	GW-AP54SGX	N/A

### 3.8. Table for Parameters of Test Software Setting

During testing, Channel & Power Controlling Software provided by the customer was used to control the operating channel as well as the output power level. The RF output power selection is for the setting of RF output power expected by the customer and is going to be fixed on the firmware of the final end product.

#### Power Parameters of Draft n MCS0 20MHz

Test Software Version	RALINK		
Frequency	2412 MHz	2437 MHz	2462 MHz
Draft n	9	0E	0D

#### Power Parameters of Draft n MCS0 40MHz

Test Software Version	RALINK		
Frequency	2422 MHz	2437 MHz	2452 MHz
Draft n	3	8	0B

An executive program, EMCTEST.EXE under WIN XP, which generates a complete line of continuously repeating " H " pattern was used as the test software.

The program was executed as follows:

- a. Turn on the power of all equipment.
- b. The NB sends " H " messages to the panel, and the panel displays " H " patterns on the screen.
- c. The NB sends " H " messages to the printer, then the printer prints them on the paper.
- d. The NB sends " H " messages to the modem.
- e. Repeat the steps from b to d.

At the same time, the following programs were executed:

Executed "ping.exe" to link with the remote workstation to receive and transmit data by LAN and WLAN.

Executed " RALINK" to control the EUT continuously transmit RF signal.

### 3.9. Test Configurations

#### 3.9.1. Radiation Emissions Test Configuration

Test Configuration: 9KHz~1GHz

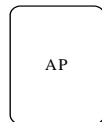
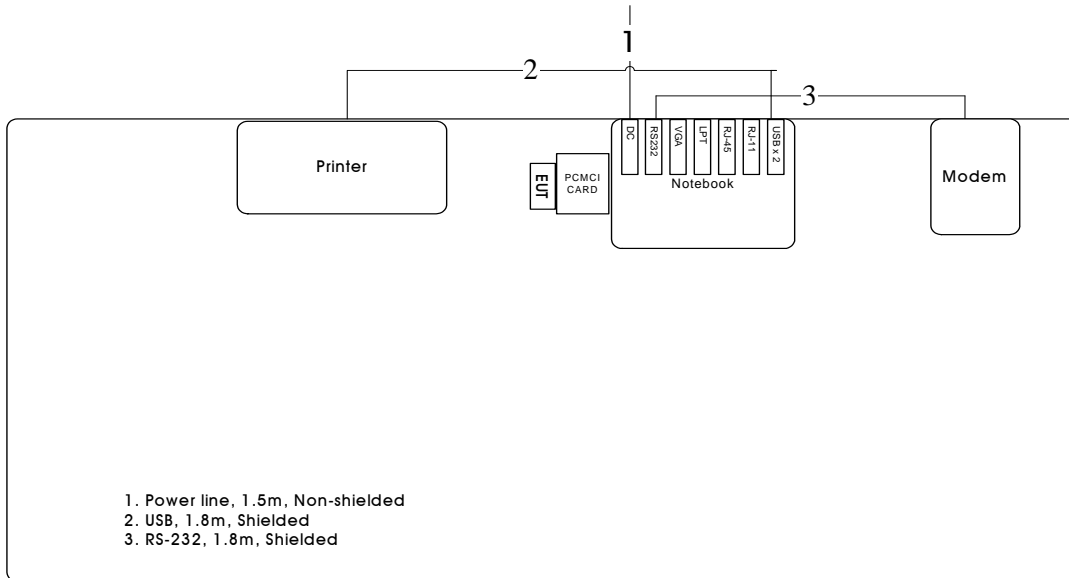

Test Configuration: Above 1GHz

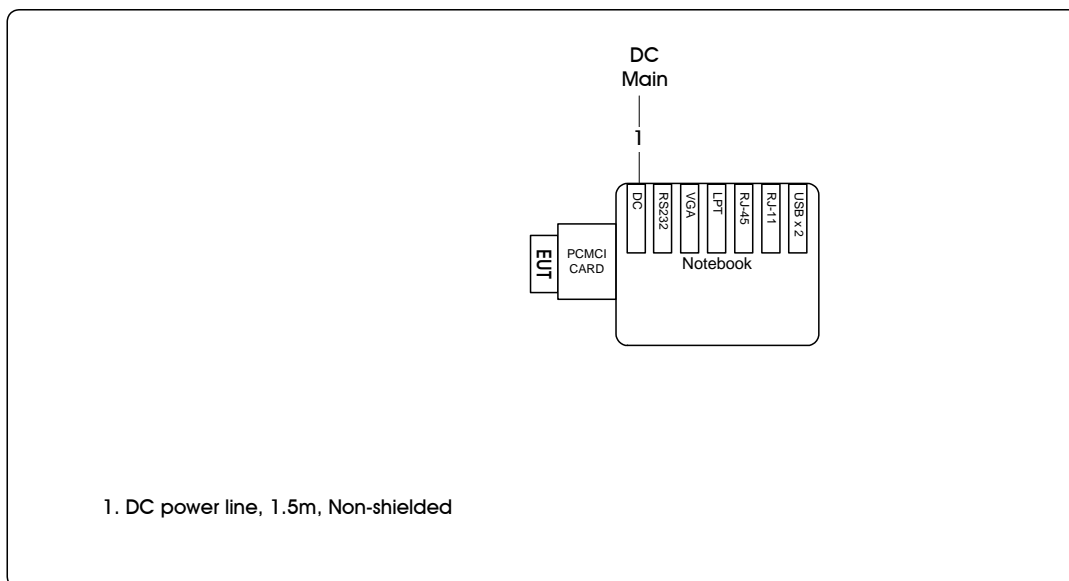

### 3.9.2. AC Power Line Conduction Emissions Test Configuration

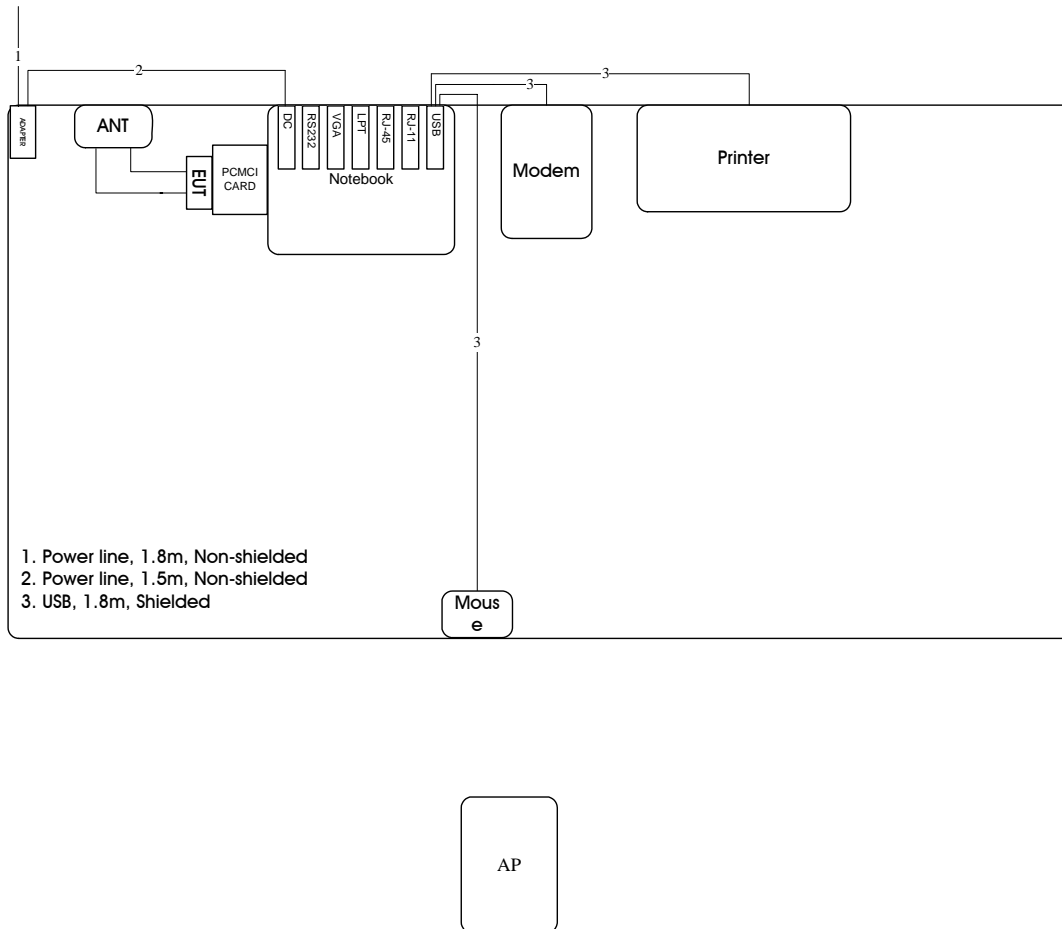

## 4. TEST RESULT

### 4.1. AC Power Line Conducted Emissions Measurement

#### 4.1.1. Limit

For this product which is designed to be connected to the AC power line, the radio frequency voltage that is conducted back onto the AC power line on any frequency or frequencies within the band 150 kHz to 30 MHz shall not exceed below limits table.

Frequency (MHz)	QP Limit (dBuV)	AV Limit (dBuV)
0.15~0.5	66~56	56~46
0.5~5	56	46
5~30	60	50

#### 4.1.2. Measuring Instruments and Setting

Please refer to section 5 of equipments list in this report. The following table is the setting of the receiver.

Receiver Parameters	Setting
Attenuation	10 dB
Start Frequency	0.15 MHz
Stop Frequency	30 MHz
IF Bandwidth	9 KHz

#### 4.1.3. Test Procedures

1. Configure the EUT according to ANSI C63.4. The EUT or host of EUT has to be placed 0.4 meter far from the conducting wall of the shielding room and at least 80 centimeters from any other grounded conducting surface.
2. Connect EUT or host of EUT to the power mains through a line impedance stabilization network (LISN).
3. All the support units are connected to the other LISNs. The LISN should provide 50uH/50ohms coupling impedance.
4. The frequency range from 150 KHz to 30 MHz was searched.
5. Set the test-receiver system to Peak Detect Function and Specified Bandwidth with Maximum Hold Mode.
6. The measurement has to be done between each power line and ground at the power terminal.

#### 4.1.4. Test Setup Layout

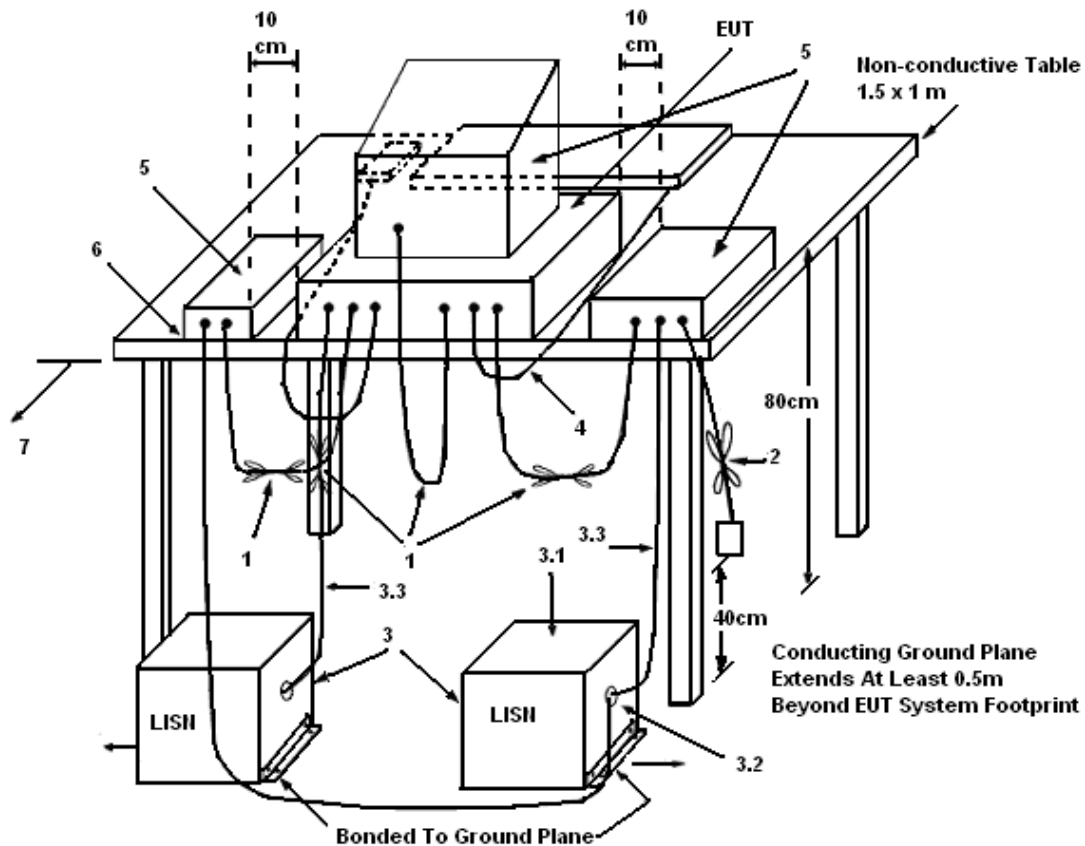

#### LEGEND:

- (1) Interconnecting cables that hang closer than 40 cm to the ground plane shall be folded back and forth in the center forming a bundle 30 to 40 cm long.
- (2) I/O cables that are not connected to a peripheral shall be bundled in the center. The end of the cable may be terminated, if required, using the correct terminating impedance. The overall length shall not exceed 1 m.
- (3) EUT connected to one LISN. Unused LISN measuring port connectors shall be terminated in  $50 \Omega$ . LISN can be placed on top of, or immediately beneath, reference ground plane.
  - (3.1) All other equipment powered from additional LISN(s).
  - (3.2) Multiple outlet strip can be used for multiple power cords of non-EUT equipment.
  - (3.3) LISN at least 80 cm from nearest part of EUT chassis.
- (4) Cables of hand-operated devices, such as keyboards, mice, etc., shall be placed as for normal use.
- (5) Non-EUT components of EUT system being tested.
- (6) Rear of EUT, including peripherals, shall all be aligned and flush with rear of tabletop.
- (7) Rear of tabletop shall be 40 cm removed from a vertical conducting plane that is bonded to the ground plane.

4.1.5. Test Deviation

There is no deviation with the original standard.

4.1.6. EUT Operation during Test

The EUT was placed on the test table and programmed in normal function.

4.1.7. Results of AC Power Line Conducted Emissions Measurement

Temperature	23°C	Humidity	54%
Test Engineer	Rex Chiu	Phase	Line
Configuration	Normal Link / Mode 1		

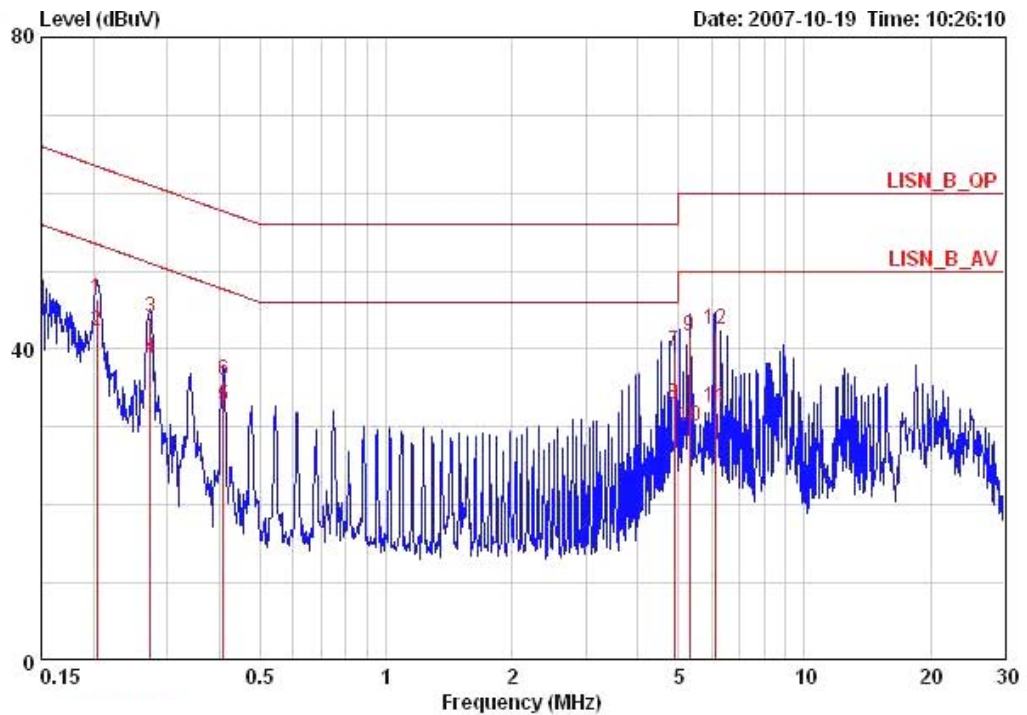

	Freq	Level	Over Limit	Limit Line	Read Level	LISN Factor	Cable Loss	Remark	Pol/Phase
	MHz	dBuV	dB	dBuV	dBuV	dB	dB		
1	0.20396	46.50	-16.95	63.45	46.20	0.10	0.20	QP	LINE
2	0.20396	42.32	-11.13	53.45	42.02	0.10	0.20	AVERAGE	LINE
3	0.27297	43.95	-17.08	61.03	43.65	0.10	0.20	QP	LINE
4	0.27297	38.70	-12.33	51.03	38.40	0.10	0.20	AVERAGE	LINE
5	0.40831	32.68	-15.01	47.68	32.38	0.10	0.20	AVERAGE	LINE
6	0.40831	35.87	-21.82	57.68	35.57	0.10	0.20	QP	LINE
7	4.894	39.66	-16.34	56.00	39.35	0.01	0.30	QP	LINE
8	4.894	32.84	-13.16	46.00	32.53	0.01	0.30	AVERAGE	LINE
9	5.301	41.56	-18.44	60.00	41.24	0.02	0.30	QP	LINE
10	5.301	30.17	-19.83	50.00	29.85	0.02	0.30	AVERAGE	LINE
11	6.117	32.37	-17.63	50.00	32.01	0.04	0.33	AVERAGE	LINE
12	6.117	42.61	-17.39	60.00	42.25	0.04	0.33	QP	LINE



Temperature	23°C	Humidity	54%
Test Engineer	Rex Chiu	Phase	Neutral
Configuration	Normal Link / Mode 1		

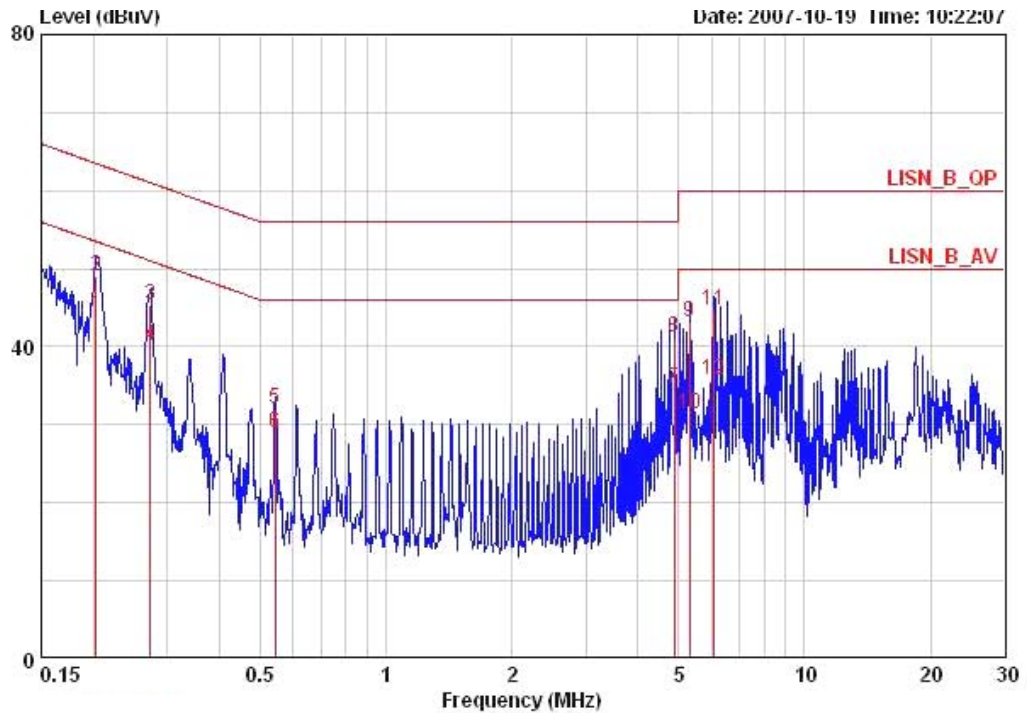

	Freq	Level	Over	Limit	Read	LISN	Cable		
	MHz	dBuV	Limit	Line	Level	Factor	Loss	Remark	Pol/Phase
			dB	dBuV	dBuV	dB	dB		
1	0.20289	44.14	-9.35	53.49	43.74	0.20	0.20	AVERAGE	NEUTRAL
2	0.20289	49.05	-14.44	63.49	48.65	0.20	0.20	QP	NEUTRAL
3	0.27282	45.44	-15.60	61.03	45.07	0.17	0.20	QP	NEUTRAL
4	0.27282	40.13	-10.91	51.03	39.76	0.17	0.20	AVERAGE	NEUTRAL
5	0.54404	31.99	-24.01	56.00	31.69	0.10	0.20	QP	NEUTRAL
6	0.54404	28.89	-17.11	46.00	28.59	0.10	0.20	AVERAGE	NEUTRAL
7	4.893	34.62	-11.38	46.00	34.22	0.10	0.30	AVERAGE	NEUTRAL
8	4.893	41.28	-14.72	56.00	40.88	0.10	0.30	QP	NEUTRAL
9	5.301	43.15	-16.85	60.00	42.75	0.10	0.30	QP	NEUTRAL
10	5.301	31.40	-18.60	50.00	31.00	0.10	0.30	AVERAGE	NEUTRAL
11	6.049	44.78	-15.22	60.00	44.37	0.10	0.31	QP	NEUTRAL
12	6.049	35.73	-14.27	50.00	35.32	0.10	0.31	AVERAGE	NEUTRAL

Temperature	23°C	Humidity	54%
Test Engineer	Rex Chiu	Phase	Line
Configuration	Normal Link / Mode 2		

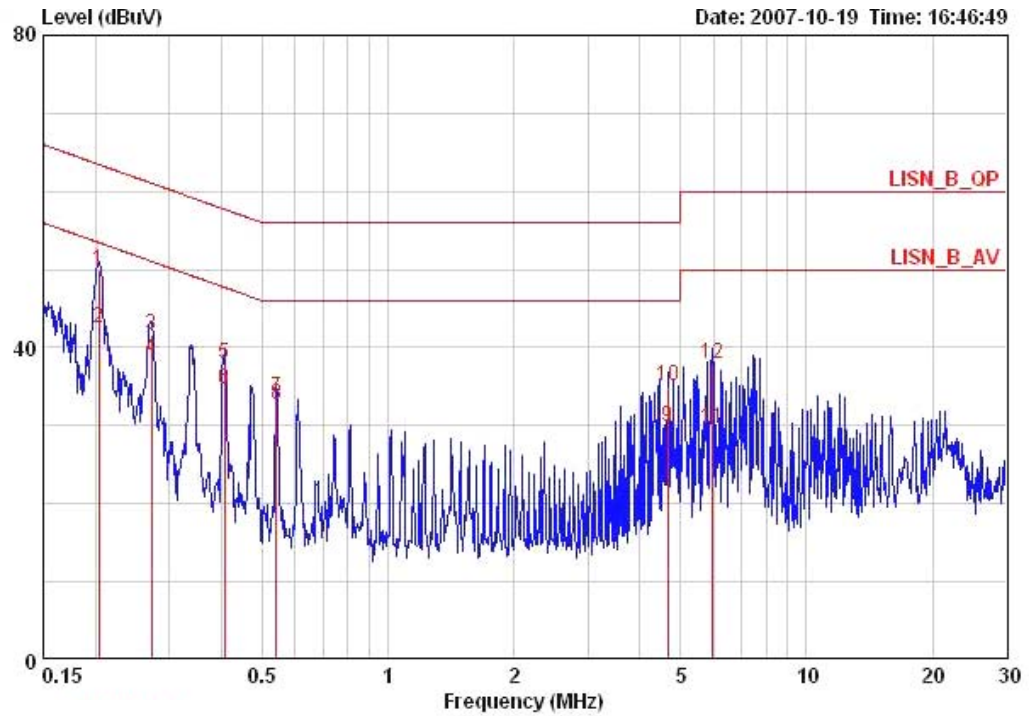

	Freq	Level	Over	Limit	Read	LISN	Cable	Remark	Pol/Phase
	MHz	dBuV	Limit	Line	Level	Factor	Loss		
			dB	dBuV	dBuV	dB	dB		
1	0.20396	49.83	-13.62	63.45	49.53	0.10	0.20	QP	LINE
2	0.20396	42.43	-11.02	53.45	42.13	0.10	0.20	AVERAGE	LINE
3	0.27152	41.73	-19.34	61.07	41.43	0.10	0.20	QP	LINE
4	0.27152	38.48	-12.59	51.07	38.18	0.10	0.20	AVERAGE	LINE
5	0.40615	38.04	-19.69	57.73	37.74	0.10	0.20	QP	LINE
6	0.40615	34.65	-13.08	47.73	34.35	0.10	0.20	AVERAGE	LINE
7	0.54068	33.62	-22.39	56.00	33.34	0.08	0.20	QP	LINE
8	0.54068	32.71	-13.30	46.00	32.43	0.08	0.20	AVERAGE	LINE
9	4.665	29.90	-16.10	46.00	29.59	0.01	0.30	AVERAGE	LINE
10	4.665	35.14	-20.86	56.00	34.83	0.01	0.30	QP	LINE
11	5.950	29.70	-20.30	50.00	29.37	0.03	0.30	AVERAGE	LINE
12	5.950	37.85	-22.15	60.00	37.52	0.03	0.30	QP	LINE

Temperature	23°C	Humidity	54%
Test Engineer	Rex Chiu	Phase	Neutral
Configuration	Normal Link / Mode 2		

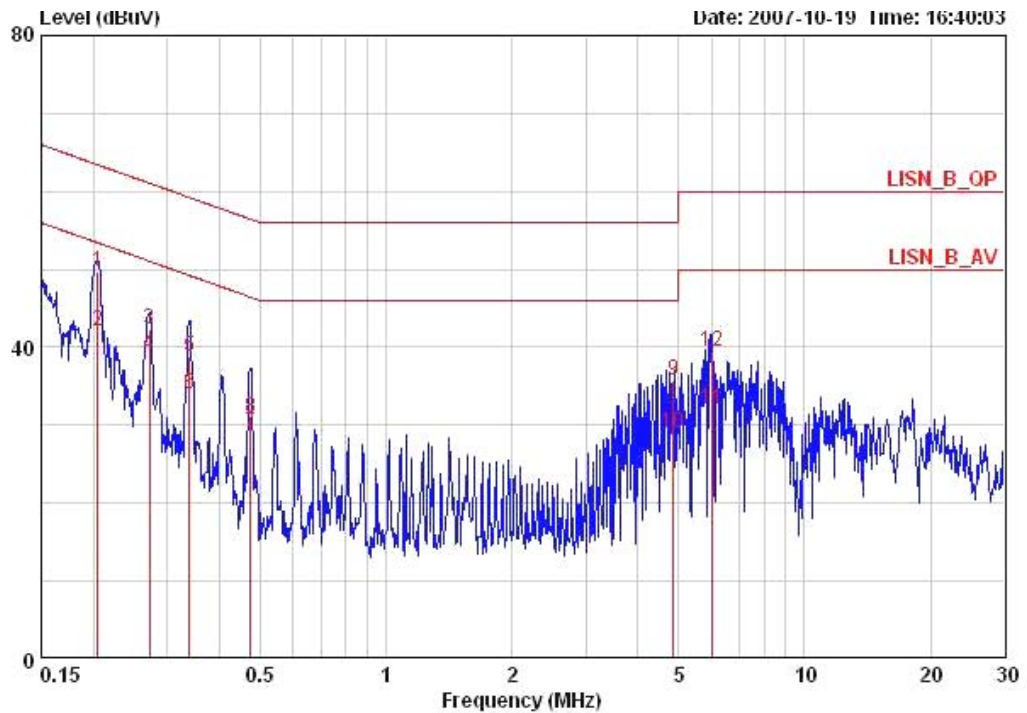

	Freq	Level	Over Limit	Limit Line	Read Level	LISN Factor	Cable Loss	Remark	Pol/Phase
	MHz	dBuV	dB	dBuV	dBuV	dB	dB		
1	0.20505	49.65	-13.75	63.40	49.25	0.20	0.20	QP	NEUTRAL
2	0.20505	42.14	-11.26	53.40	41.74	0.20	0.20	AVERAGE	NEUTRAL
3	0.27152	42.33	-18.74	61.07	41.96	0.17	0.20	QP	NEUTRAL
4	0.27152	38.94	-12.13	51.07	38.57	0.17	0.20	AVERAGE	NEUTRAL
5	0.33920	38.79	-20.43	59.22	38.46	0.13	0.20	QP	NEUTRAL
6	0.33920	34.03	-15.19	49.22	33.70	0.13	0.20	AVERAGE	NEUTRAL
7	0.47360	29.09	-17.37	46.45	28.81	0.10	0.18	AVERAGE	NEUTRAL
8	0.47360	30.89	-25.57	56.45	30.61	0.10	0.18	QP	NEUTRAL
9	4.869	35.71	-20.29	56.00	35.31	0.10	0.30	QP	NEUTRAL
10	4.869	29.06	-16.94	46.00	28.66	0.10	0.30	AVERAGE	NEUTRAL
11	6.019	31.96	-18.04	50.00	31.55	0.10	0.31	AVERAGE	NEUTRAL
12	6.019	39.52	-20.48	60.00	39.11	0.10	0.31	QP	NEUTRAL

Temperature	23°C	Humidity	54%
Test Engineer	Rex Chiu	Phase	Line
Configuration	Normal Link / Mode 3		

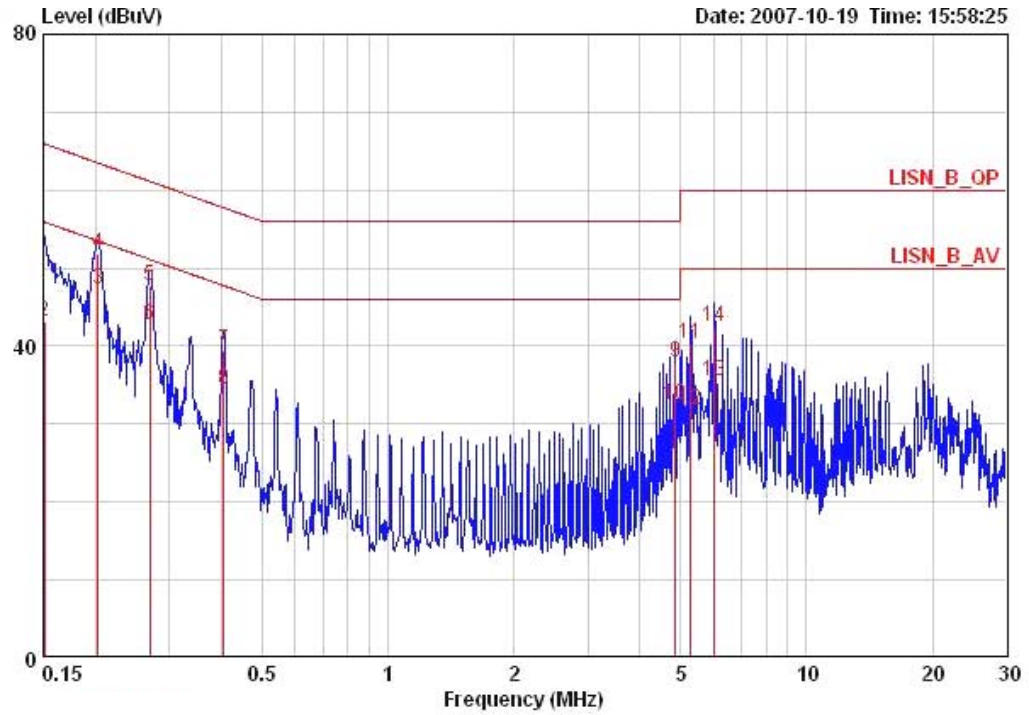

	Freq	Level	Over	Limit	Read	LISN	Cable	Remark	Pol/Phase
	MHz	dBuV	Limit	Line	Level	Factor	Loss		
			dB	dBuV	dBuV	dB	dB		
1	0.15080	27.01	-28.95	55.96	26.61	0.20	0.20	AVERAGE	LINE
2	0.15080	43.09	-22.87	65.96	42.69	0.20	0.20	QP	LINE
3	0.20289	47.21	-6.28	53.49	46.91	0.10	0.20	AVERAGE	LINE
4	0.20289	51.92	-11.57	63.49	51.62	0.10	0.20	QP	LINE
5	0.27009	47.67	-13.45	61.12	47.37	0.10	0.20	QP	LINE
6	0.27009	42.78	-8.34	51.12	42.48	0.10	0.20	AVERAGE	LINE
7	0.40400	39.38	-18.40	57.77	39.08	0.10	0.20	QP	LINE
8	0.40400	34.45	-13.33	47.77	34.15	0.10	0.20	AVERAGE	LINE
9	4.861	37.93	-18.07	56.00	37.62	0.01	0.30	QP	LINE
10	4.861	32.51	-13.49	46.00	32.20	0.01	0.30	AVERAGE	LINE
11	5.265	40.36	-19.64	60.00	40.04	0.02	0.30	QP	LINE
12	5.265	31.80	-18.20	50.00	31.48	0.02	0.30	AVERAGE	LINE
13	6.008	35.54	-14.46	50.00	35.21	0.03	0.30	AVERAGE	LINE
14	6.008	42.40	-17.60	60.00	42.07	0.03	0.30	QP	LINE

Temperature	23°C	Humidity	54%
Test Engineer	Rex Chiu	Phase	Neutral
Configuration	Normal Link / Mode 3		

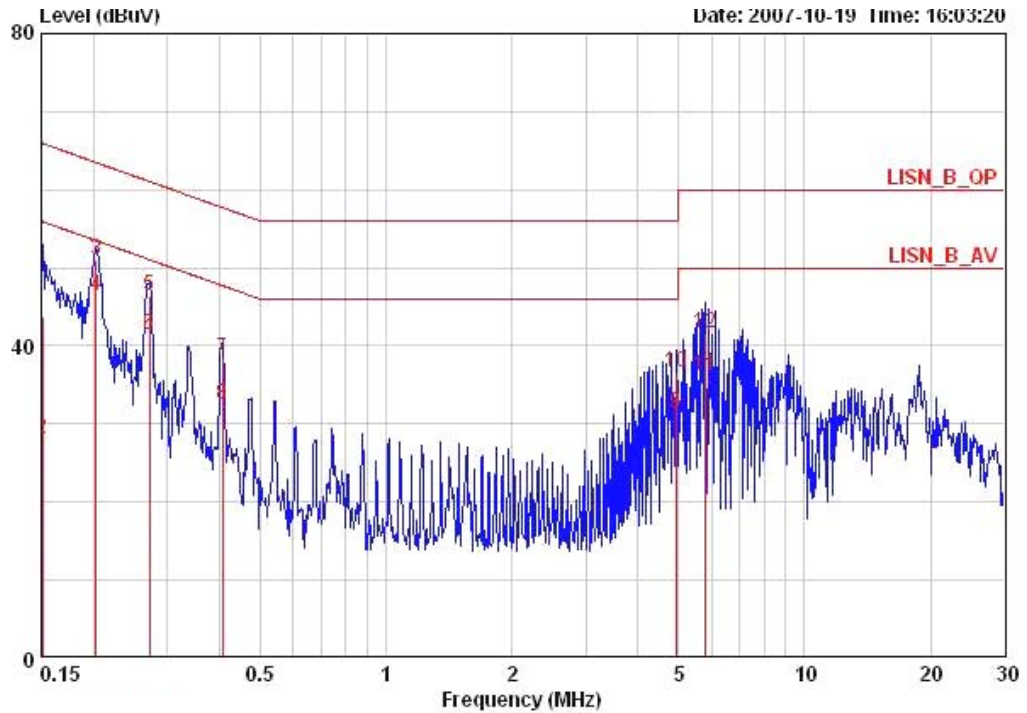

	Freq	Level	Over Limit	Limit Line	Read Level	LISN Factor	Cable Loss	Remark	Pol/Phase
	MHz	dBuV	dB	dBuV	dBuV	dB	dB		
1	0.15080	43.74	-22.22	65.96	43.24	0.30	0.20	QP	NEUTRAL
2	0.15080	28.08	-27.88	55.96	27.58	0.30	0.20	AVERAGE	NEUTRAL
3	0.20289	51.02	-12.47	63.49	50.62	0.20	0.20	QP	NEUTRAL
4	0.20289	46.51	-6.98	53.49	46.11	0.20	0.20	AVERAGE	NEUTRAL
5	0.27152	46.40	-14.67	61.07	46.03	0.17	0.20	QP	NEUTRAL
6	0.27152	41.38	-9.69	51.07	41.01	0.17	0.20	AVERAGE	NEUTRAL
7	0.40615	38.38	-19.35	57.73	38.08	0.10	0.20	QP	NEUTRAL
8	0.40615	32.48	-15.25	47.73	32.18	0.10	0.20	AVERAGE	NEUTRAL
9	4.934	31.35	-14.65	46.00	30.95	0.10	0.30	AVERAGE	NEUTRAL
10	4.934	36.70	-19.30	56.00	36.30	0.10	0.30	QP	NEUTRAL
11	5.812	36.14	-13.86	50.00	35.74	0.10	0.30	AVERAGE	NEUTRAL
12	5.812	41.74	-18.26	60.00	41.34	0.10	0.30	QP	NEUTRAL

Note:

Level = Read Level + LISN Factor + Cable Loss.



Temperature	23°C	Humidity	54%
Test Engineer	Rex Chiu	Phase	Line
Configuration	Normal Link / Mode 4		

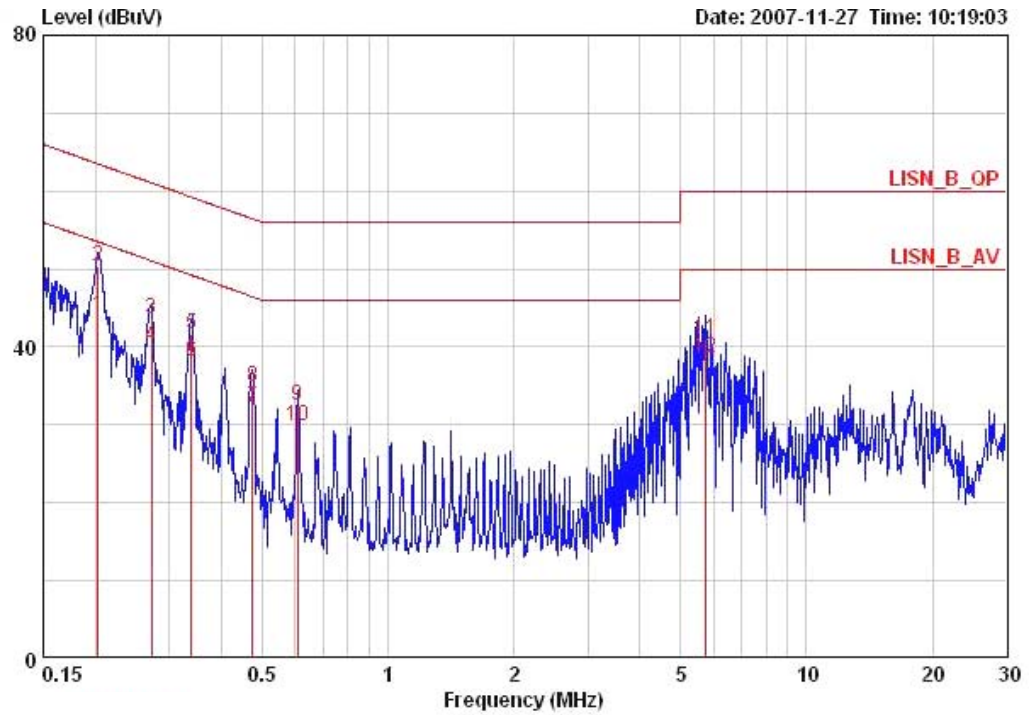

	Freq	Level	Over	Limit	Read	LISN	Cable	Remark	Pol/Phase
	MHz	dBuV	Limit	Line	Level	Factor	Loss		
			dB	dBuV	dBuV	dB	dB		
1	0.20289	44.07	-9.42	53.49	43.77	0.10	0.20	AVERAGE	LINE
2	0.20289	50.41	-13.08	63.49	50.11	0.10	0.20	QP	LINE
3	0.27152	43.61	-17.46	61.07	43.31	0.10	0.20	QP	LINE
4	0.27152	40.05	-11.02	51.07	39.75	0.10	0.20	AVERAGE	LINE
5	0.33820	41.70	-17.55	59.25	41.40	0.10	0.20	QP	LINE
6	0.33820	38.05	-11.20	49.25	37.75	0.10	0.20	AVERAGE	LINE
7	0.47360	32.25	-14.20	46.45	31.99	0.09	0.18	AVERAGE	LINE
8	0.47360	34.82	-21.63	56.45	34.56	0.09	0.18	QP	LINE
9	0.60795	32.44	-23.57	56.00	32.17	0.07	0.20	QP	LINE
10	0.60795	29.80	-16.21	46.00	29.53	0.07	0.20	AVERAGE	LINE
11	5.744	41.07	-18.93	60.00	40.74	0.03	0.30	QP	LINE
12	5.744	38.48	-11.52	50.00	38.15	0.03	0.30	AVERAGE	LINE

Temperature	23°C	Humidity	54%
Test Engineer	Rex Chiu	Phase	Neutral
Configuration	Normal Link / Mode 4		

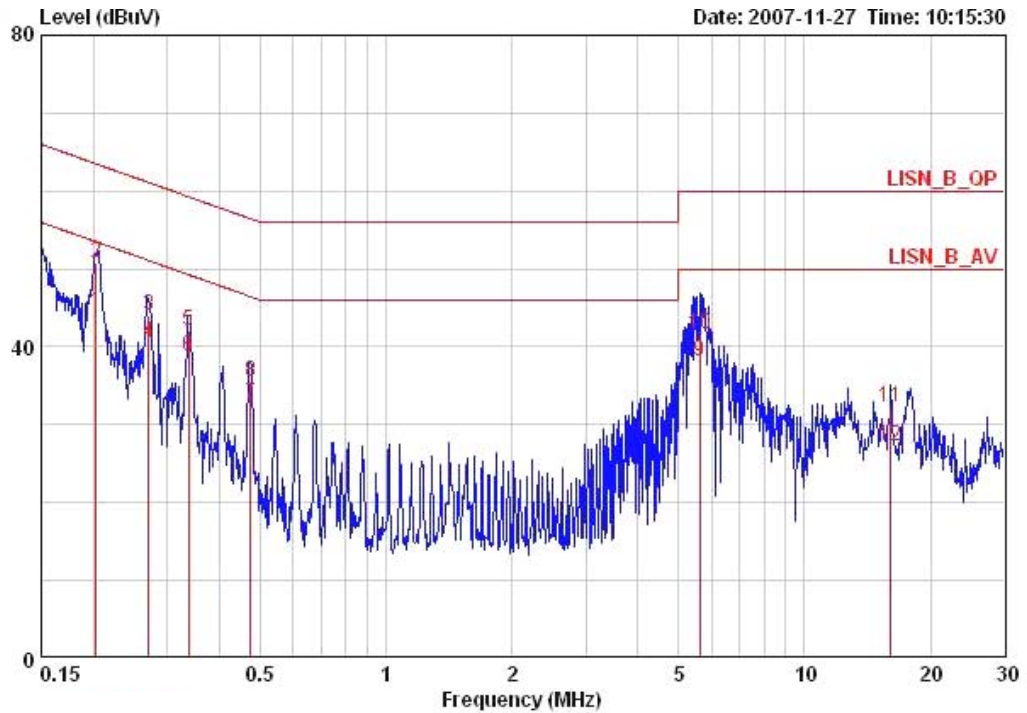

	Freq	Level	Over	Limit	Read	LISN	Cable	Remark	Pol/Phase
	MHz	dBuV	dB	dBuV	dBuV	dB	dB		
1	0.20294	44.53	-8.96	53.49	44.13	0.20	0.20	AVERAGE	NEUTRAL
2	0.20294	50.82	-12.67	63.49	50.42	0.20	0.20	QP	NEUTRAL
3	0.27044	43.98	-17.13	61.10	43.61	0.17	0.20	QP	NEUTRAL
4	0.27044	40.51	-10.60	51.10	40.14	0.17	0.20	AVERAGE	NEUTRAL
5	0.33740	41.97	-17.29	59.27	41.64	0.13	0.20	QP	NEUTRAL
6	0.33740	38.72	-10.54	49.27	38.39	0.13	0.20	AVERAGE	NEUTRAL
7	0.47360	32.63	-13.83	46.45	32.35	0.10	0.18	AVERAGE	NEUTRAL
8	0.47360	35.44	-21.02	56.45	35.16	0.10	0.18	QP	NEUTRAL
9	5.607	38.18	-11.82	50.00	37.78	0.10	0.30	AVERAGE	NEUTRAL
10	5.607	41.65	-18.35	60.00	41.25	0.10	0.30	QP	NEUTRAL
11	16.015	32.35	-27.65	60.00	31.85	0.10	0.40	QP	NEUTRAL
12	16.015	27.35	-22.65	50.00	26.85	0.10	0.40	AVERAGE	NEUTRAL

Note:

Level = Read Level + LISN Factor + Cable Loss.

## 4.2. Maximum Peak Output Power Measurement

### 4.2.1. Limit

For systems using digital modulation in the 2400-2483.5MHz, the limit for peak output power is 30dBm. The limited has to be reduced by the amount in dB that the gain of the antenna exceed 6dBi. In case of point-to-point operation, the limit has to be reduced by 1dB for every 3dB that the directional gain of the antenna exceeds 6dBi.

### 4.2.2. Measuring Instruments and Setting

Please refer to section 5 of equipments list in this report. The following table is the setting of the power meter.

Power Meter Parameter	Setting
Filter No.	Auto
Measurement time	0.135 s ~ 26 s
Used Peak Sensor	NRV-Z32 (model 04)

### 4.2.3. Test Procedures

1. The transmitter output (antenna port) was connected to the power meter.
2. Turn on the EUT and power meter and then record the peak power value.
3. Repeat above procedures on all channels needed to be tested.

### 4.2.4. Test Setup Layout

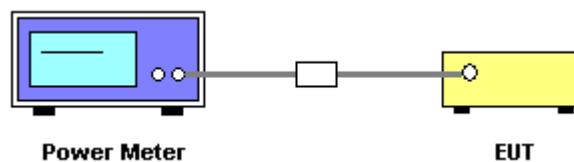

### 4.2.5. Test Deviation

There is no deviation with the original standard.

### 4.2.6. EUT Operation during Test

The EUT was programmed to be in continuously transmitting mode.



#### 4.2.7. Test Result of Maximum Peak Output Power

<b>Temperature</b>	25°C	<b>Humidity</b>	60%
<b>Test Engineer</b>	Aric Lee	<b>Configurations</b>	Draft n

##### Configuration Draft n MCS0 20MHz

Channel	Frequency	Conducted Power (dBm)	Max. Limit (dBm)	Result
1	2412 MHz	22.60	30.00	Complies
6	2437 MHz	24.40	30.00	Complies
11	2462 MHz	22.30	30.00	Complies

##### Configuration Draft n MCS0 40MHz

Channel	Frequency	Conducted Power (dBm)	Max. Limit (dBm)	Result
3	2422 MHz	19.30	30.00	Complies
6	2437 MHz	21.30	30.00	Complies
9	2452 MHz	21.30	30.00	Complies

### 4.3. Power Spectral Density Measurement

#### 4.3.1. Limit

For digitally modulated systems, the power spectral density conducted from the intentional radiator to the antenna shall not be greater than 8 dBm in any 3 kHz band during any time interval of continuous transmission.

#### 4.3.2. Measuring Instruments and Setting

Please refer to section 5 of equipments list in this report. The following table is the setting of Spectrum Analyzer.

Spectrum Parameter	Setting
Attenuation	Auto
Span Frequency	1.5MHz
RB	3 kHz
VB	30 kHz
Detector	Peak
Trace	Max Hold
Sweep Time	500s

#### 4.3.3. Test Procedures

1. The transmitter output (antenna port) was connected to the spectrum analyser.
2. Set RBW of spectrum analyzer to 3kHz and VBW to 30kHz. Set Detector to Peak, Trace to Max Hold.
3. Mark the frequency with maximum peak power as the center of the display of the spectrum.
4. Set the span to 1.5MHz and the sweep time to 500s and record the maximum peak value.

#### 4.3.4. Test Setup Layout

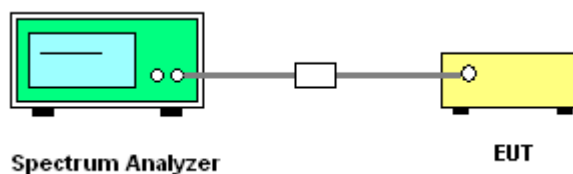

#### 4.3.5. Test Deviation

There is no deviation with the original standard.

#### 4.3.6. EUT Operation during Test

The EUT was programmed to be in continuously transmitting mode.

#### 4.3.7. Test Result of Power Spectral Density

<b>Temperature</b>	25°C	<b>Humidity</b>	60%
<b>Test Engineer</b>	Aric Lee	<b>Configurations</b>	Draft n

##### Configuration Draft n MCS0 20MHz

Channel	Frequency	Power Density (dBm)	Max. Limit (dBm)	Result
1	2412 MHz	-13.45	8	Complies
6	2437 MHz	-12.17	8	Complies
11	2462 MHz	-14.26	8	Complies

##### Configuration Draft n MCS0 40MHz

Channel	Frequency	Power Density (dBm)	Max. Limit (dBm)	Result
3	2422 MHz	-17.29	8	Complies
6	2437 MHz	-17.94	8	Complies
9	2452 MHz	-18.21	8	Complies

## Power Density Plot on Configuration Drafft n MCS0 20MHz / 2412 MHz

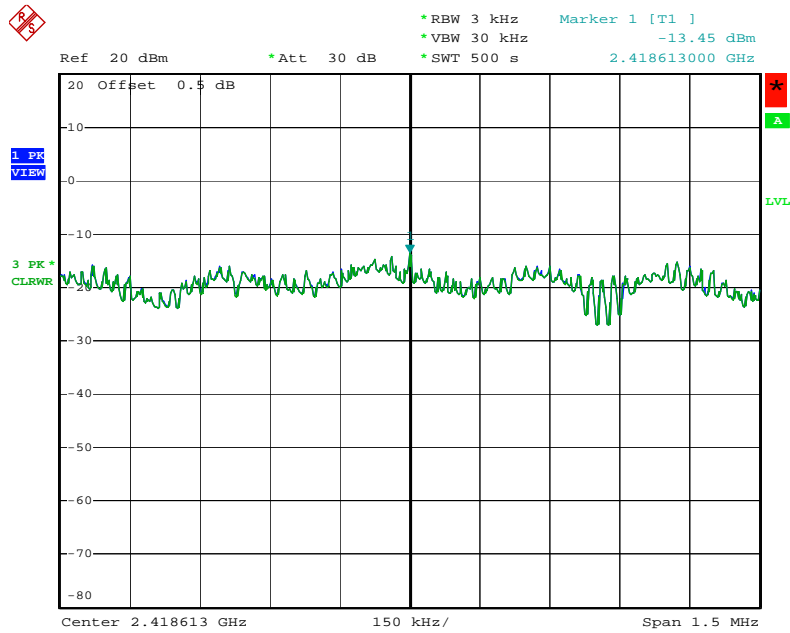

Date: 16.OCT.2007 15:52:58

## Power Density Plot on Configuration Drafft n MCS0 20MHz / 2437 MHz

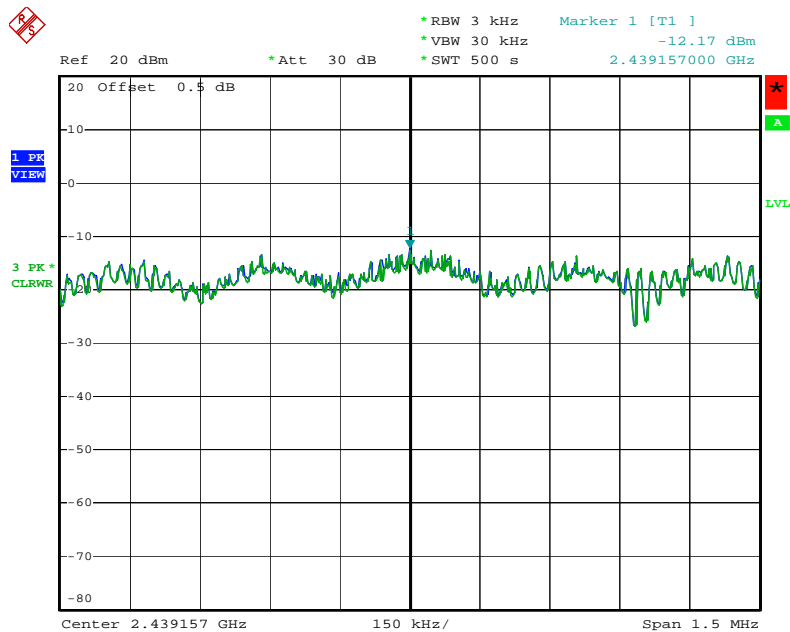

Date: 16.OCT.2007 15:51:37

**Power Density Plot on Configuration Drafft n MCS0 20MHz / 2462 MHz**

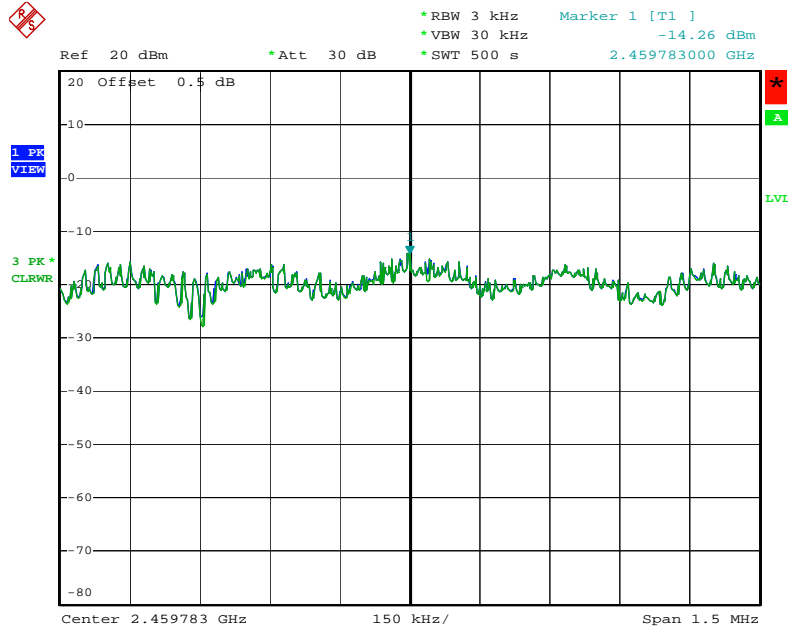

Date: 16.OCT.2007 15:50:25

**Power Density Plot on Configuration Drafft n MCS0 40MHz / 2422 MHz**

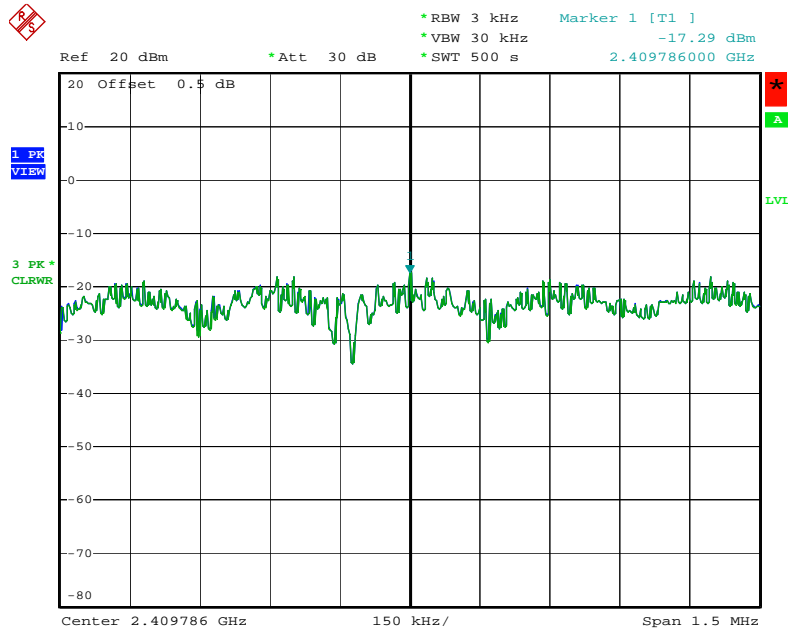

Date: 16.OCT.2007 15:57:16

Power Density Plot on Configuration Drafft n MCS0 40MHz Ant. A / 2437 MHz

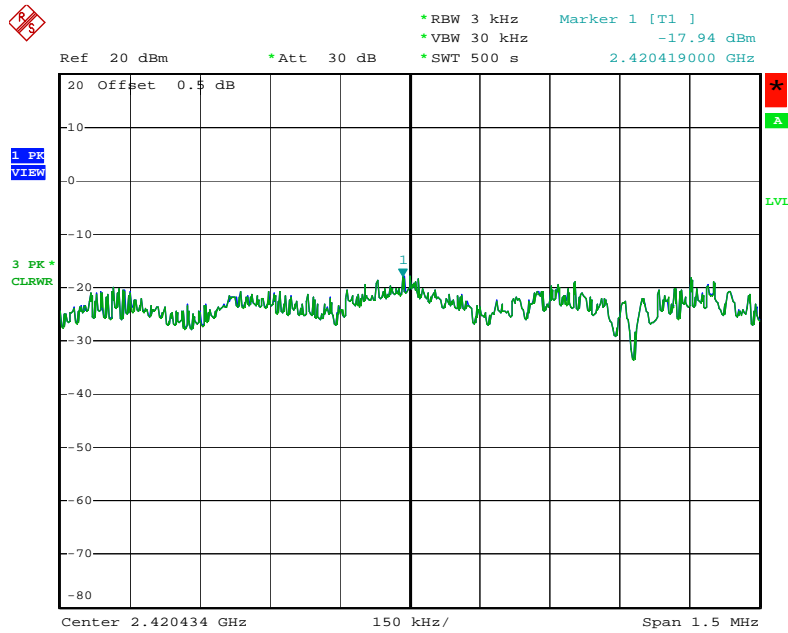

Date: 16.OCT.2007 15:58:40

Power Density Plot on Configuration Drafft n MCS0 40MHz Ant. A / 2452 MHz

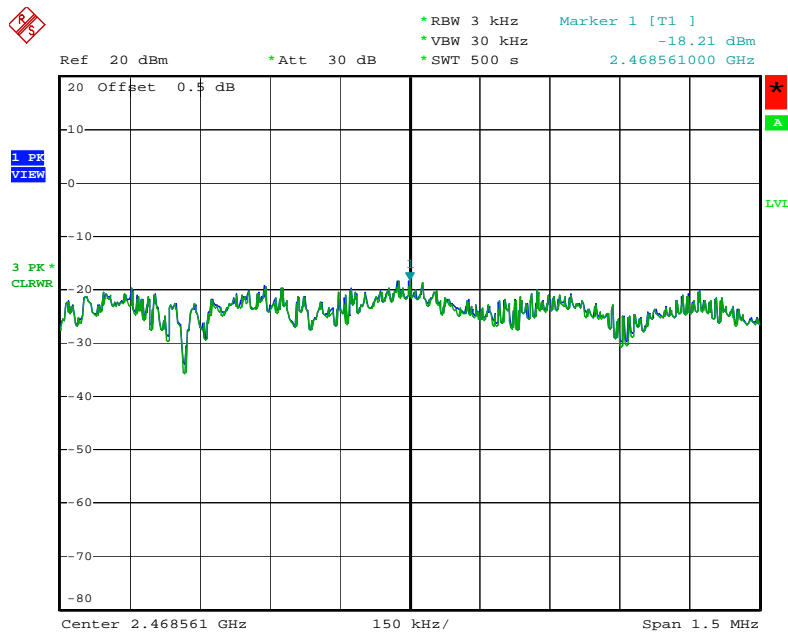

Date: 16.OCT.2007 16:00:02

#### 4.4. 6dB Spectrum Bandwidth Measurement

##### 4.4.1. Limit

For digital modulation systems, the minimum 6 dB bandwidth shall be at least 500 kHz.

##### 4.4.2. Measuring Instruments and Setting

Please refer to section 5 of equipments list in this report. The following table is the setting of the Spectrum Analyzer.

Spectrum Parameters	Setting
Attenuation	Auto
Span Frequency	> 6dB Bandwidth
RB	100 kHz
VB	100 kHz
Detector	Peak
Trace	Max Hold
Sweep Time	Auto

##### 4.4.3. Test Procedures

1. The transmitter output (antenna port) was connected to the spectrum analyser in peak hold mode.
2. The resolution bandwidth of 100 kHz and the video bandwidth of 100 kHz were used.
3. Measured the spectrum width with power higher than 6dB below carrier.

##### 4.4.4. Test Setup Layout

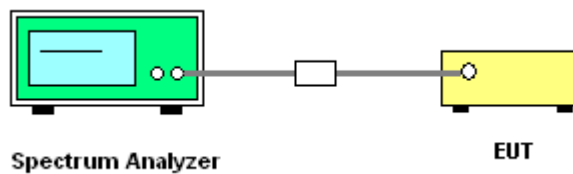

##### 4.4.5. Test Deviation

There is no deviation with the original standard.

##### 4.4.6. EUT Operation during Test

The EUT was programmed to be in continuously transmitting mode.

## 4.4.7. Test Result of 6dB Spectrum Bandwidth

<b>Temperature</b>	25°C	<b>Humidity</b>	60%
<b>Test Engineer</b>	Aric Lee	<b>Configurations</b>	Draft n

## Configuration Draft n MCS0 20MHz

Channel	Frequency	6dB Bandwidth (MHz)	99% Occupied Bandwidth (MHz)	Min. Limit (kHz)	Test Result
1	2412 MHz	17.64	17.60	500	Complies
6	2437 MHz	17.64	17.60	500	Complies
11	2462 MHz	17.68	17.60	500	Complies

## Configuration Draft n MCS0 40MHz

Channel	Frequency	6dB Bandwidth (MHz)	99% Occupied Bandwidth (MHz)	Min. Limit (kHz)	Test Result
3	2422 MHz	36.32	36.00	500	Complies
6	2437 MHz	36.32	35.92	500	Complies
9	2452 MHz	36.48	36.00	500	Complies



6 dB Bandwidth Plot on Configuration Draft n MCS0 20MHz / 2412 MHz

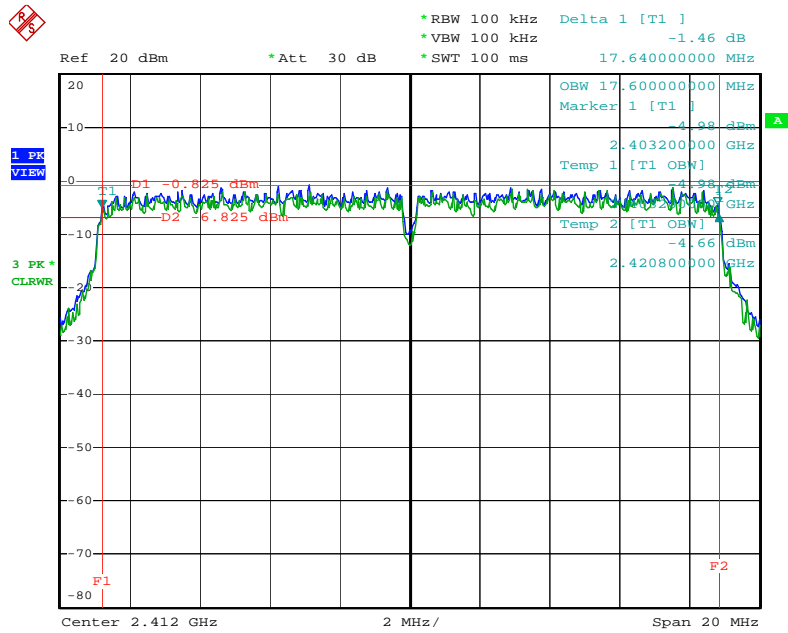

Date: 16.OCT.2007 15:52:33

6 dB Bandwidth Plot on Configuration Draft n MCS0 20MHz / 2437 MHz

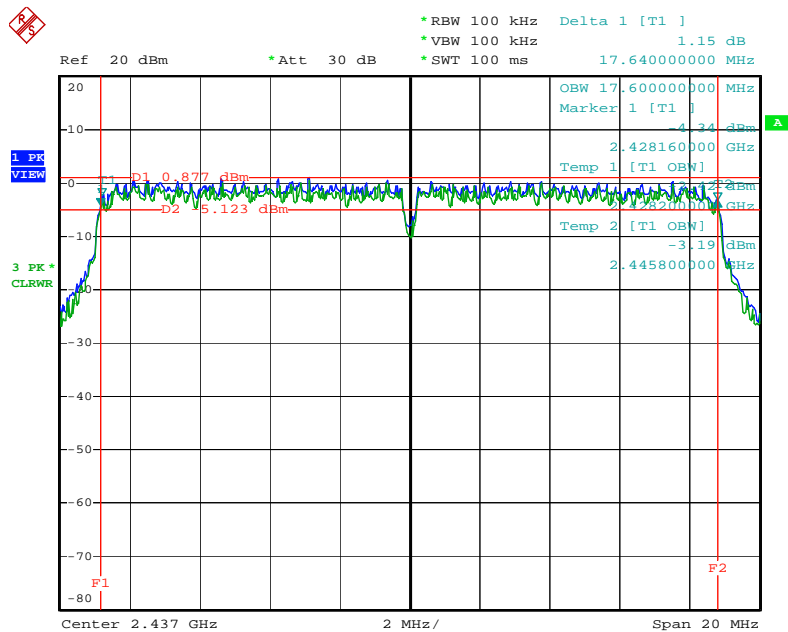

Date: 16.OCT.2007 15:51:21

6 dB Bandwidth Plot on Configuration Draft n MCS0 20MHz / 2462 MHz

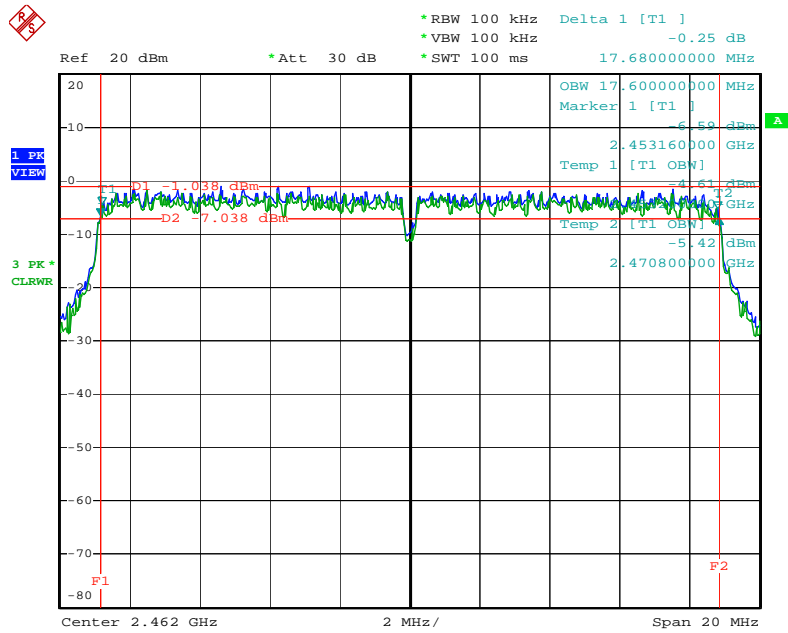

Date: 16.OCT.2007 15:50:10

6 dB Bandwidth Plot on Configuration Draft n MCS0 40MHz / 2422 MHz

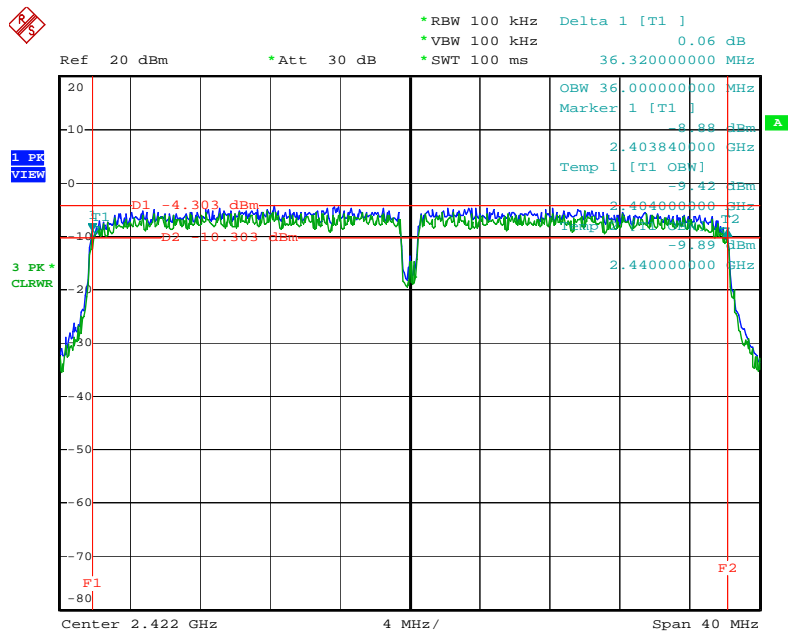

Date: 16.OCT.2007 15:56:51

### 6 dB Bandwidth Plot on Configuration Draft n MCS0 40MHz Ant. A / 2437 MHz

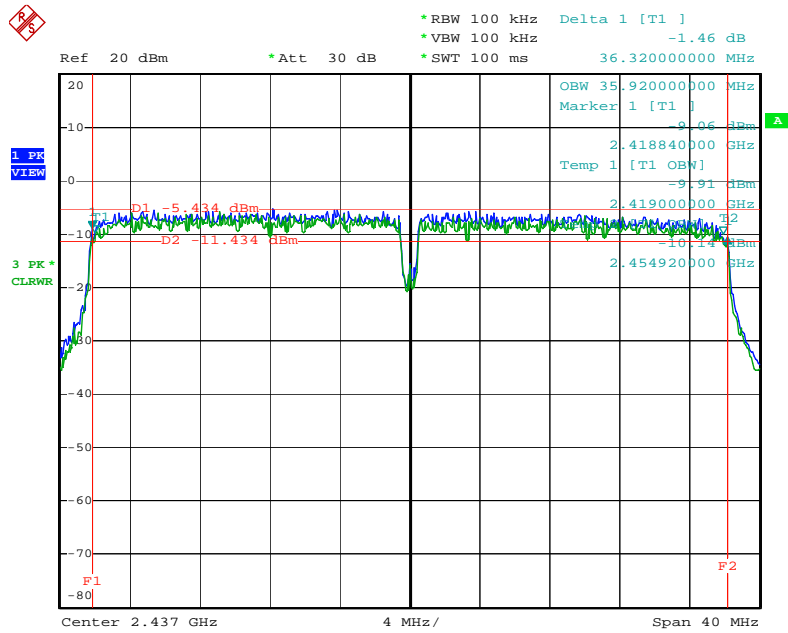

Date: 16.OCT.2007 15:58:15

### 6 dB Bandwidth Plot on Configuration Draft n MCS0 40MHz Ant. A / 2452 MHz

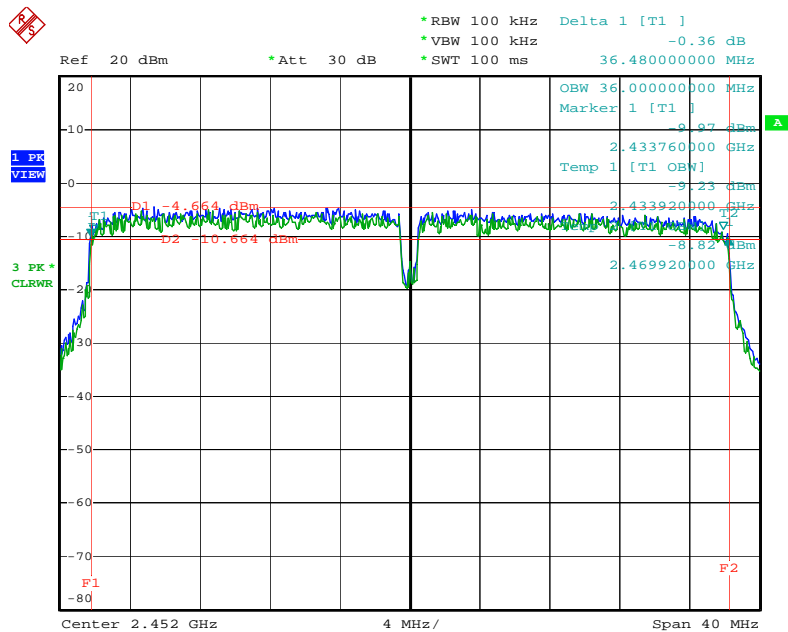

Date: 16.OCT.2007 15:59:37

## 4.5. Radiated Emissions Measurement

### 4.5.1. Limit

20dBc in any 100 kHz bandwidth outside the operating frequency band. In case the emission fall within the restricted band specified on 15.205(a), then the 15.209(a) limit in the table below has to be followed.

Frequencies (MHz)	Field Strength (micorvolts/meter)	Measurement Distance (meters)
0.009~0.490	2400/F(KHz)	300
0.490~1.705	24000/F(KHz)	30
1.705~30.0	30	30
30~88	100	3
88~216	150	3
216~960	200	3
Above 960	500	3

### 4.5.2. Measuring Instruments and Setting

Please refer to section 5 of equipments list in this report. The following table is the setting of spectrum analyzer and receiver.

Spectrum Parameter	Setting
Attenuation	Auto
Start Frequency	1000 MHz
Stop Frequency	10th carrier harmonic
RB / VB (Emission in restricted band)	1MHz / 1MHz for Peak, 1 MHz / 10Hz for Average
RB / VB (Emission in non-restricted band)	1000KHz / 1000KHz for peak

Receiver Parameter	Setting
Attenuation	Auto
Start ~ Stop Frequency	9kHz~150kHz / RB 200Hz for QP
Start ~ Stop Frequency	150kHz~30MHz / RB 9kHz for QP
Start ~ Stop Frequency	30MHz~1000MHz / RB 120kHz for QP

#### 4.5.3. Test Procedures

1. Configure the EUT according to ANSI C63.4. The EUT was placed on the top of the turntable 0.8 meter above ground. The phase center of the receiving antenna mounted on the top of a height-variable antenna tower was placed 3 meters far away from the turntable.
2. Power on the EUT and all the supporting units. The turntable was rotated by 360 degrees to determine the position of the highest radiation.
3. The height of the broadband receiving antenna was varied between one meter and four meters above ground to find the maximum emissions field strength of both horizontal and vertical polarization.
4. For each suspected emissions, the antenna tower was scan (from 1 m to 4 m) and then the turntable was rotated (from 0 degree to 360 degrees) to find the maximum reading.
5. Set the test-receiver system to Peak or CISPR quasi-peak Detect Function with specified bandwidth under Maximum Hold Mode.
6. For emissions above 1GHz, use 1MHz VBW and RBW for peak reading. Then 1MHz RBW and 10Hz VBW for average reading in spectrum analyzer.
7. When the radiated emissions limits are expressed in terms of the average value of the emissions, and pulsed operation is employed, the measurement field strength shall be determined by averaging over one complete pulse train, including blanking intervals, as long as the pulse train does not exceed 0.1 seconds. As an alternative (provided the transmitter operates for longer than 0.1 seconds) or in cases where the pulse train exceeds 0.1 seconds, the measured field strength shall be determined from the average absolute voltage during a 0.1 second interval during which the field strength is at its maximum value.
8. If the emissions level of the EUT in peak mode was 3 dB lower than the average limit specified, then testing will be stopped and peak values of EUT will be reported, otherwise, the emissions which do not have 3 dB margin will be repeated one by one using the quasi-peak method for below 1GHz.
9. For testing above 1GHz, the emissions level of the EUT in peak mode was lower than average limit (that means the emissions level in peak mode also complies with the limit in average mode), then testing will be stopped and peak values of EUT will be reported, otherwise, the emissions will be measured in average mode again and reported.
10. In case the emission is lower than 30MHz, loop antenna has to be used for measurement and the recorded data should be QP measured by receiver. High – Low scan is not required in this case.

#### 4.5.4. Test Setup Layout

For radiated emissions below 30MHz

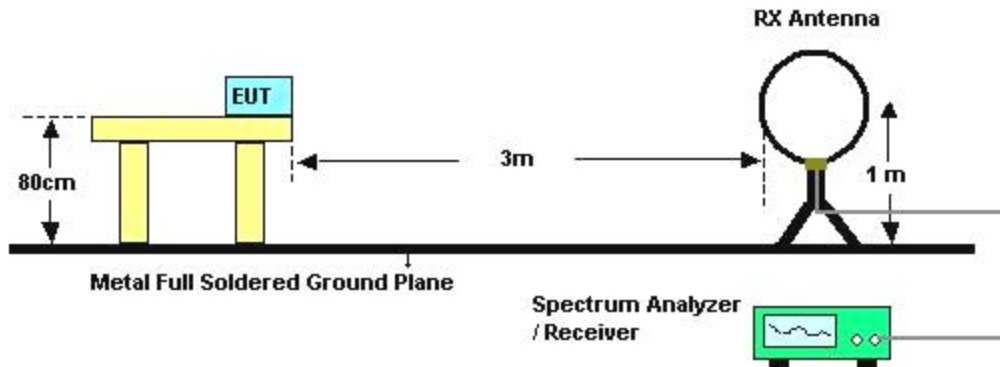

For radiated emissions above 30MHz

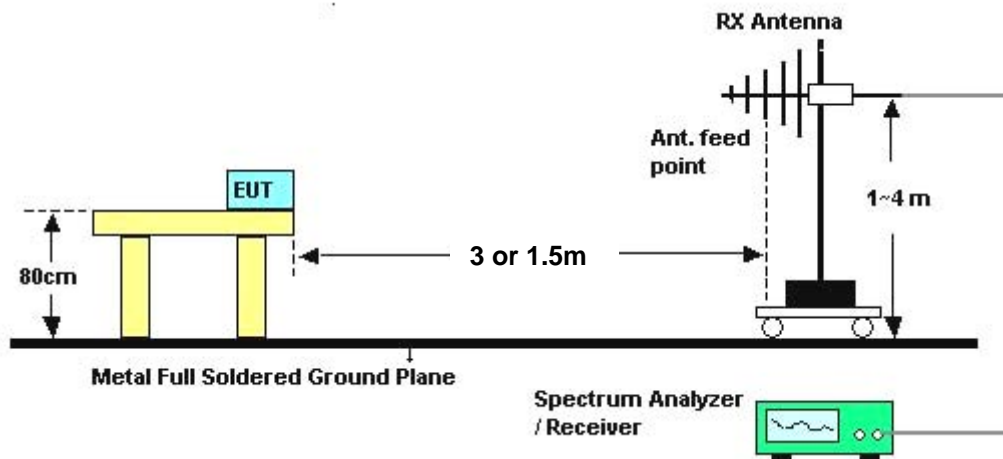

Above 10 GHz shall be extrapolated to the specified distance using an extrapolation factor of 20 dB/decade from 3m to 1.5m.

Distance extrapolation factor =  $20 \log (\text{specific distance [3m]} / \text{test distance [1.5m]})$  (dB);

Limit line = specific limits (dBuV) + distance extrapolation factor [6 dB].

#### 4.5.5. Test Deviation

There is no deviation with the original standard.

#### 4.5.6. EUT Operation during Test

The EUT was programmed to be in continuously transmitting mode.

#### 4.5.7. Results of Radiated Emissions (9kHz~30MHz)

<b>Temperature</b>	23°C	<b>Humidity</b>	56%
<b>Test Engineer</b>	Aric Lee	<b>Configurations</b>	Normal Link

Freq. (MHz)	Level (dBuV)	Over Limit (dB)	Limit Line (dBuV)	Remark
-	-	-	-	See Note

Note:

The amplitude of spurious emissions which are attenuated by more than 20 dB below the permissible value has no need to be reported.

Distance extrapolation factor =  $40 \log(\text{specific distance} / \text{test distance})$  (dB);

Limit line = specific limits (dBuV) + distance extrapolation factor.

## 4.5.8. Results of Radiated Emissions (30MHz~1GHz)

Temperature	23°C	Humidity	56%
Test Engineer	Aric Lee	Configurations	Normal Link / Mode 1

## Horizontal

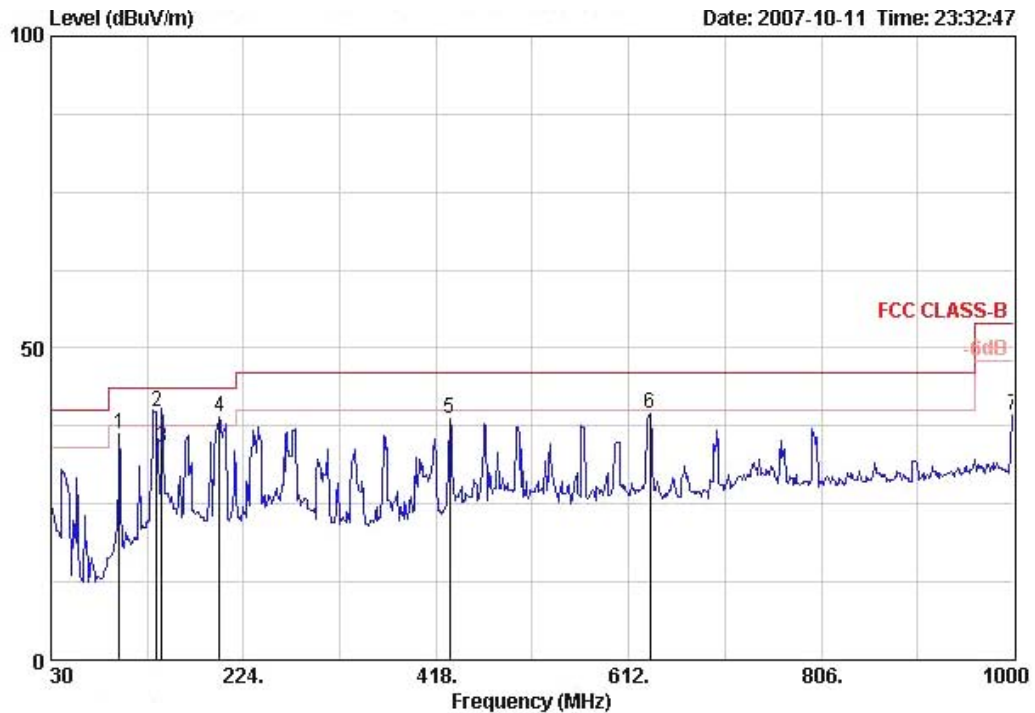

	Freq	Level	Over Limit	Limit Line	ReadAntenna	Cable	Preamp	Remark	Ant Pos	Table Pos
	MHz	dBuV/m	dB	dBuV/m	dBuV	dB	dB		cm	deg
1	98.870	36.28	-7.22	43.50	50.88	11.01	0.36	25.96 Peak	100	0
2 !	136.700	39.77	-3.73	43.50	52.92	12.15	0.53	25.84 Peak	100	158
3	141.550	34.11	-9.39	43.50	47.56	11.85	0.49	25.80 QP	100	278
4 !	199.750	38.84	-4.66	43.50	53.04	10.30	0.96	25.46 Peak	100	0
5	431.580	38.63	-7.37	46.00	45.99	16.94	1.49	25.79 Peak	100	0
6	633.340	39.40	-6.60	46.00	44.09	19.40	2.13	26.21 Peak	100	0
7	1000.000	39.21	-14.79	54.00	39.02	22.30	3.11	25.22 Peak	100	0



**Vertical**

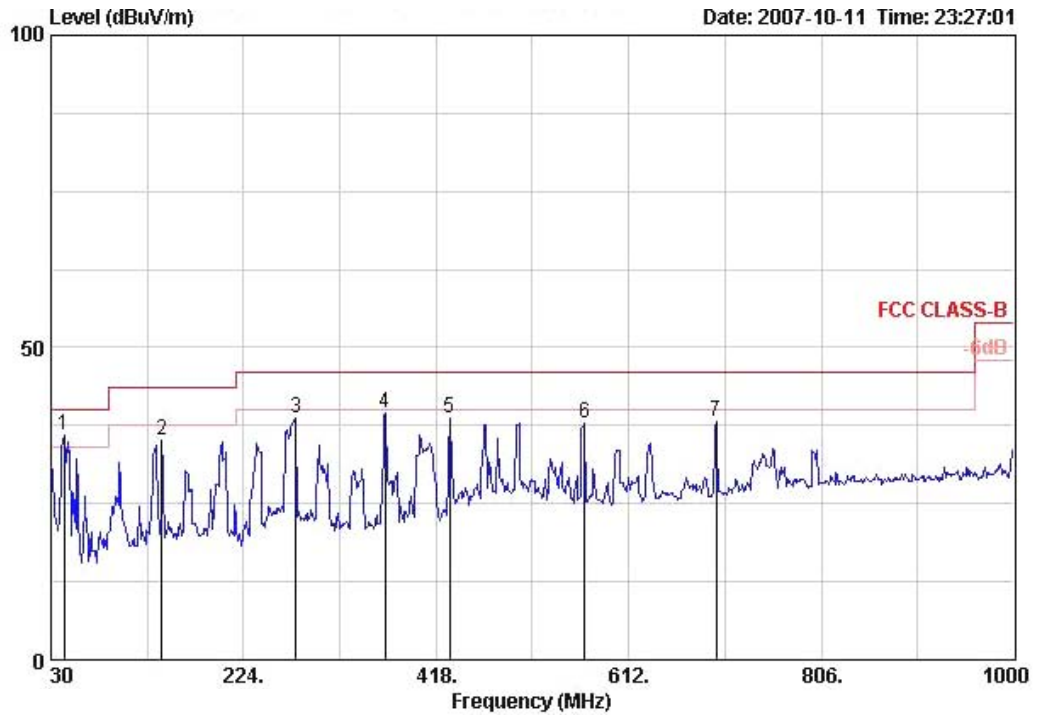

	Freq	Level	Over Limit	Limit Line	ReadAntenna Level	Antenna Factor	Cable Loss	Preamp Factor	Remark	Ant Pos	Table Pos
	MHz	dBUV/m	dB	dBUV/m	dBUV	dB/m	dB	dB		cm	deg
1 !	43.580	35.96	-4.04	40.00	49.91	12.02	0.53	26.50	Peak	400	0
2	141.550	35.16	-8.34	43.50	48.62	11.85	0.49	25.80	Peak	400	0
3	276.380	38.71	-7.29	46.00	49.23	13.50	1.14	25.17	Peak	400	0
4	366.590	39.45	-6.55	46.00	47.61	15.70	1.31	25.17	Peak	400	0
5	431.580	38.71	-7.29	46.00	46.07	16.94	1.49	25.79	Peak	400	0
6	567.380	37.79	-8.21	46.00	43.53	18.74	1.77	26.26	Peak	400	0
7	700.270	38.13	-7.87	46.00	42.23	19.70	2.13	25.93	Peak	400	0

**Note:**

The amplitude of spurious emissions that are attenuated by more than 20dB below the permissible value has no need to be reported.

Emission level (dBUV/m) = 20 log Emission level (uV/m).

Corrected Reading: Antenna Factor + Cable Loss + Read Level - Preamp Factor = Level.

Temperature	23°C	Humidity	56%
Test Engineer	Aric Lee	Configurations	Normal Link / Mode 2

**Horizontal**

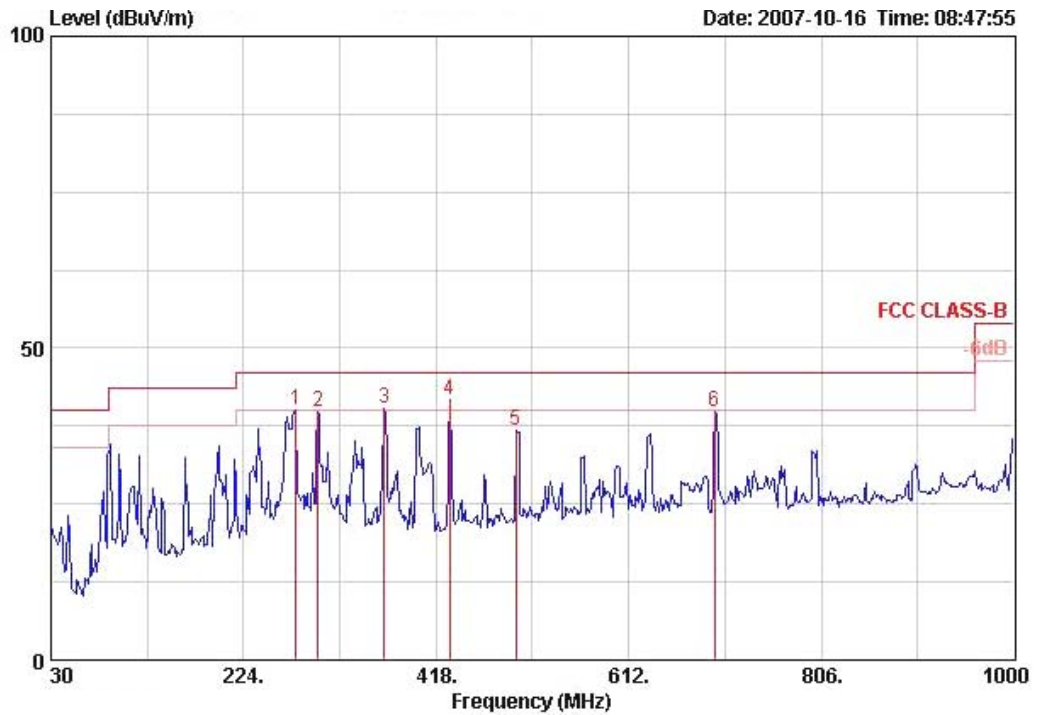

	Freq	Level	Over Limit	Limit Line	Read Level	Antenna Factor	Cable Loss	Preamp Factor	Remark	Ant Pos	Table Pos
	MHz	dBUV/m	dB	dBUV/m	dBuV	dB/m	dB	dB		cm	deg
1 !	276.380	40.07	-5.93	46.00	50.60	13.50	1.14	25.17	Peak	100	0
2	298.690	39.78	-6.22	46.00	49.71	13.88	1.14	24.95	Peak	100	0
3 !	365.620	40.25	-5.75	46.00	48.43	15.68	1.30	25.16	Peak	100	0
4 @	431.580	41.68	-4.32	46.00	49.04	16.94	1.49	25.79	Peak	100	48
5	498.510	36.69	-9.31	46.00	43.45	17.78	1.80	26.33	Peak	100	0
6	698.330	39.80	-6.20	46.00	43.91	19.70	2.13	25.94	Peak	100	0

**Vertical**

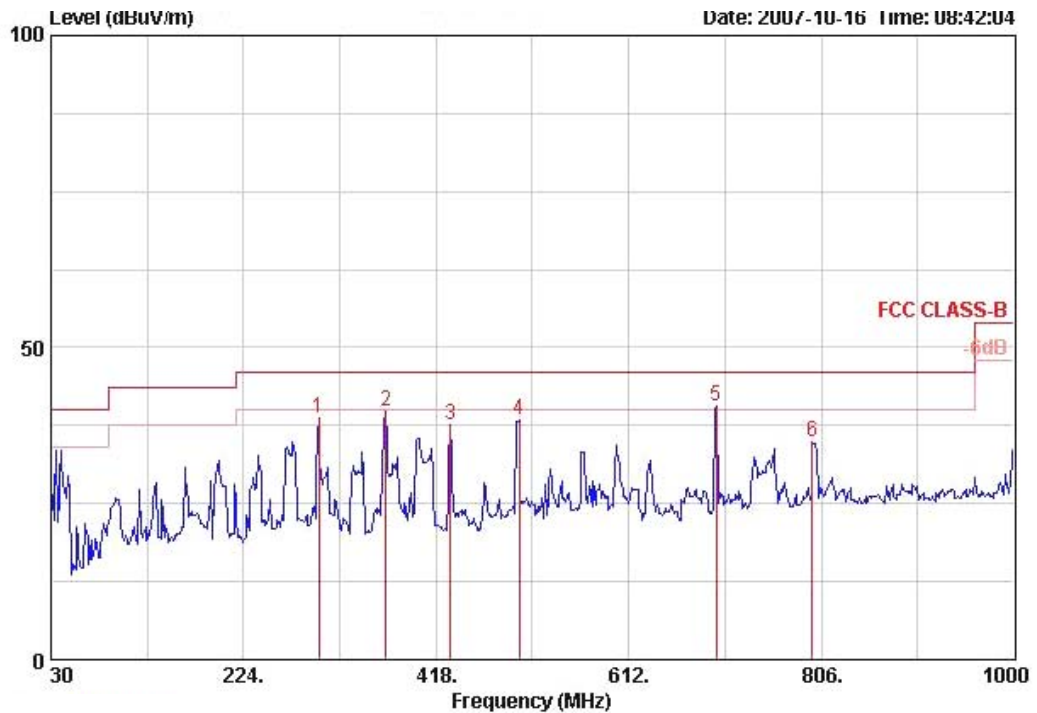

	Freq	Level	Over Limit	Limit Line	Read Level	Antenna Factor	Cable Loss	Preamp Factor	Remark	Ant Pos	Table Pos
	MHz	dBuV/m	dB	dBuV/m	dBuV	dB/m	dB	dB		cm	deg
1	299.660	38.82	-7.18	46.00	48.72	13.90	1.14	24.94	Peak	400	0
2	367.560	39.66	-6.34	46.00	47.80	15.72	1.32	25.18	Peak	100	241
3	432.550	37.49	-8.51	46.00	44.85	16.96	1.49	25.80	Peak	400	0
4	501.420	38.39	-7.61	46.00	45.12	17.82	1.81	26.35	Peak	400	0
5 @	700.270	40.50	-5.50	46.00	44.60	19.70	2.13	25.93	Peak	400	0
6	797.270	34.80	-11.20	46.00	36.82	20.67	2.50	25.18	Peak	400	0

**Note:**

The amplitude of spurious emissions that are attenuated by more than 20dB below the permissible value has no need to be reported.

Emission level (dBuV/m) = 20 log Emission level (uV/m).

Corrected Reading: Antenna Factor + Cable Loss + Read Level - Preamp Factor = Level.

Temperature	23°C	Humidity	56%
Test Engineer	Aric Lee	Configurations	Normal Link / Mode 3

**Horizontal**

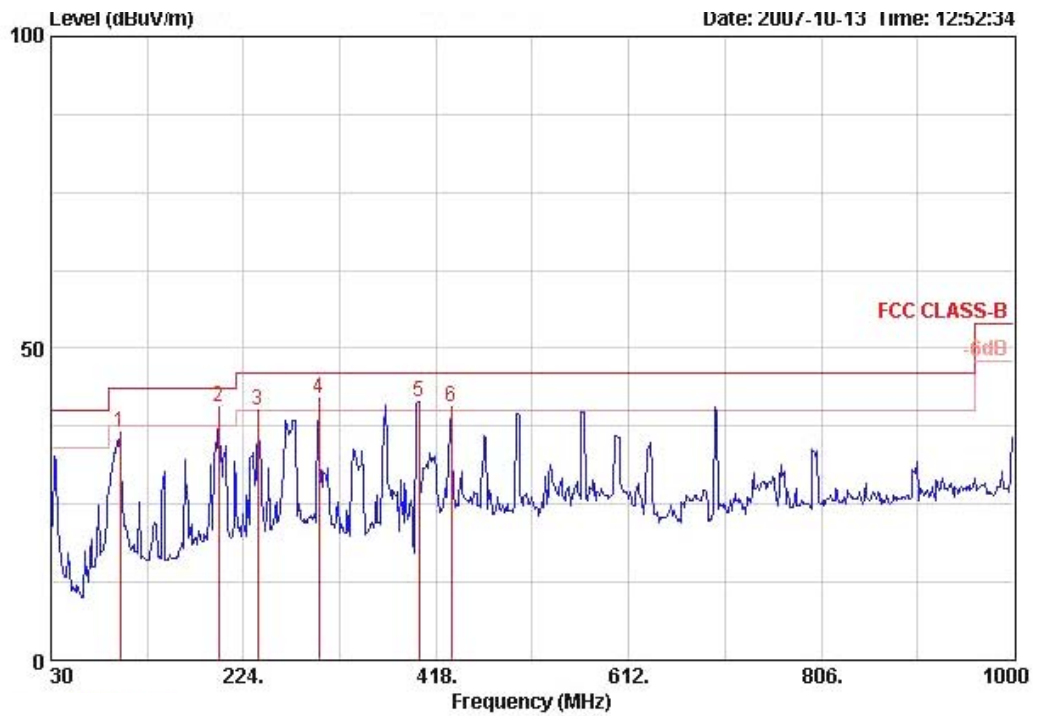

	Over	Limit	Read	Antenna	Cable	Preamp		Ant	Table
1	2	3	4	5	6	7	8	Pos	Pos
MHz	dBuV/m	dB	dBuV/m	dBuV	dB/m	dB	dB	cm	deg
99.840	36.60	-6.90	43.50	51.03	11.20	0.30	25.93	Peak	100 0
198.780	40.47	-3.03	43.50	54.76	10.22	0.95	25.45	Peak	100 0
238.550	40.07	-5.93	46.00	52.28	12.11	1.11	25.43	Peak	100 0
299.660	42.03	-3.97	46.00	51.93	13.90	1.14	24.94	Peak	100 0
400.540	41.45	-4.55	46.00	48.88	16.51	1.61	25.55	Peak	100 0
433.520	40.67	-5.33	46.00	48.03	16.97	1.48	25.81	Peak	100 0

**Vertical**

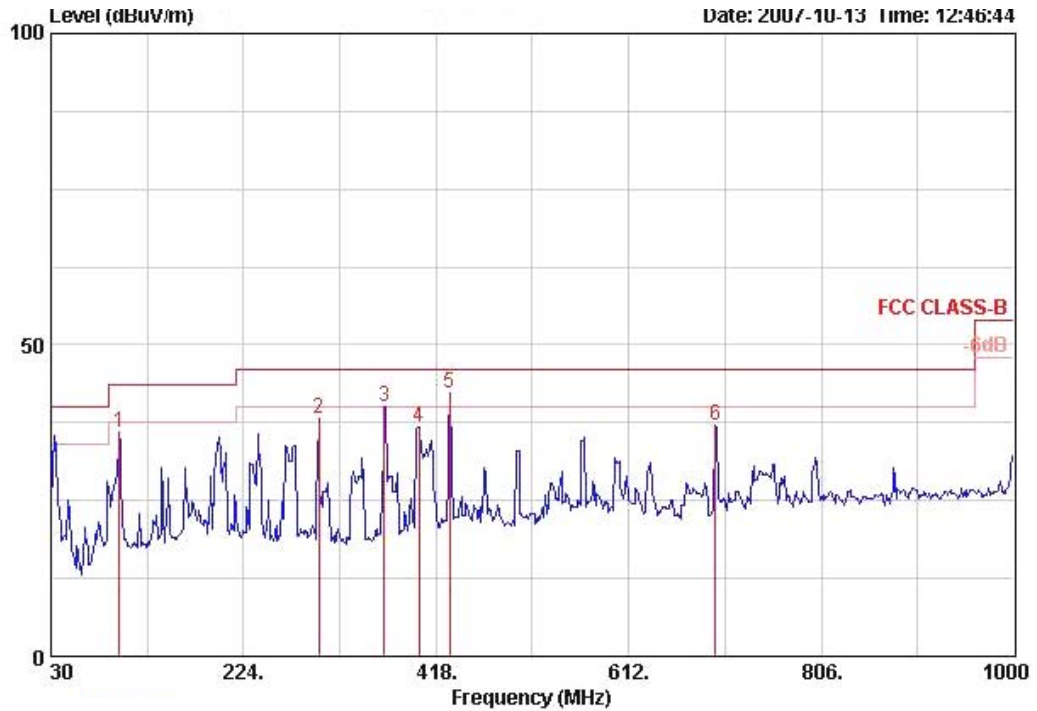

	Freq	Level	Over Limit	Limit Line	Read Level	Antenna Factor	Cable Loss	Preamp Factor	Remark	Ant Pos	Table Pos
	MHz	dBUV/m	dB	dBUV/m	dBuV	dB/m	dB	dB		cm	deg
1	98.870	35.87	-7.63	43.50	50.46	11.01	0.36	25.96	Peak	400	0
2	299.660	38.04	-7.96	46.00	47.94	13.90	1.14	24.94	Peak	400	0
3 !	365.620	40.15	-5.85	46.00	48.33	15.68	1.30	25.16	Peak	400	0
4	400.540	36.85	-9.15	46.00	44.28	16.51	1.61	25.55	Peak	400	0
5 @	431.580	42.16	-3.84	46.00	49.52	16.94	1.49	25.79	Peak	400	0
6	699.300	36.97	-9.03	46.00	41.08	19.70	2.13	25.94	Peak	400	0

**Note:**

The amplitude of spurious emissions that are attenuated by more than 20dB below the permissible value has no need to be reported.

Emission level (dBUV/m) = 20 log Emission level (uV/m).

Corrected Reading: Antenna Factor + Cable Loss + Read Level - Preamp Factor = Level.

Temperature	23°C	Humidity	56%
Test Engineer	Aric Lee	Configurations	Normal Link / Mode 4

**Horizontal**

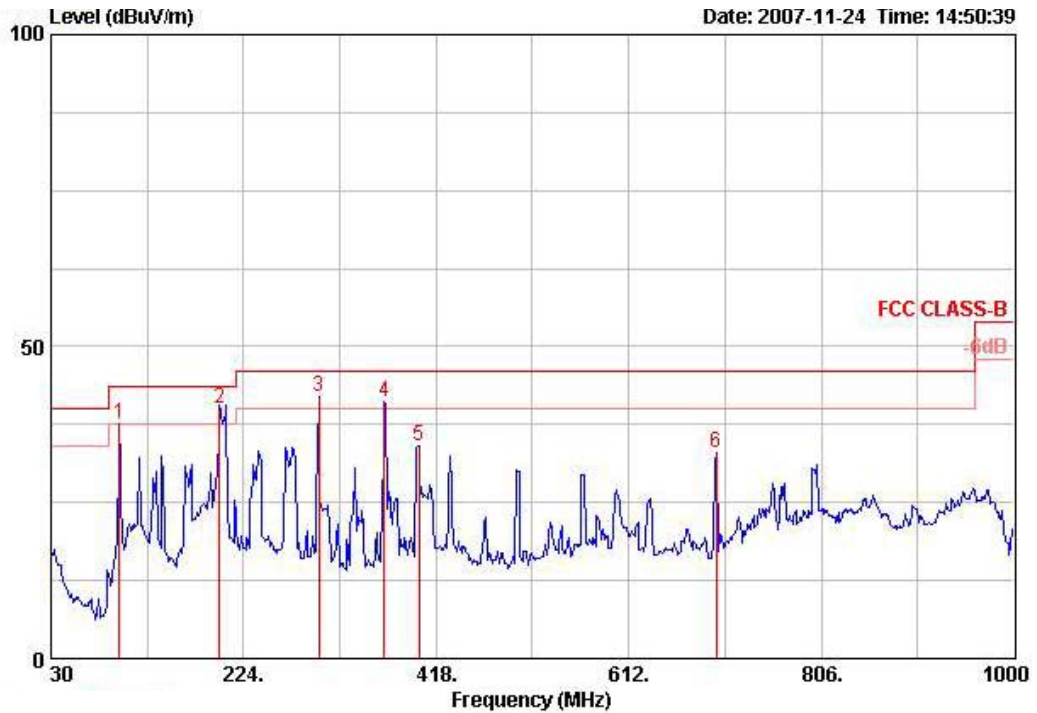

	Freq	Level	Over Limit	Limit Line	Read Level	Antenna Factor	Cable Loss	Preamp Factor	Remark	Ant Pos	Table Pos
	MHz	dBUV/m	dB	dBUV/m	dBuV	dB/m	dB	dB		cm	deg
1	98.870	37.49	-6.01	43.50	52.09	11.01	0.36	25.96	Peak	100	0
2 @	199.700	40.12	-3.38	43.50	54.32	10.30	0.96	25.46	QP	100	248
3 !	299.660	41.91	-4.09	46.00	51.81	13.90	1.14	24.94	Peak	100	0
4 !	365.620	41.15	-4.85	46.00	49.34	15.68	1.30	25.16	Peak	100	0
5	400.540	34.09	-11.91	46.00	41.52	16.51	1.61	25.55	Peak	100	0
6	700.270	32.94	-13.06	46.00	37.04	19.70	2.13	25.93	Peak	100	0

**Vertical**

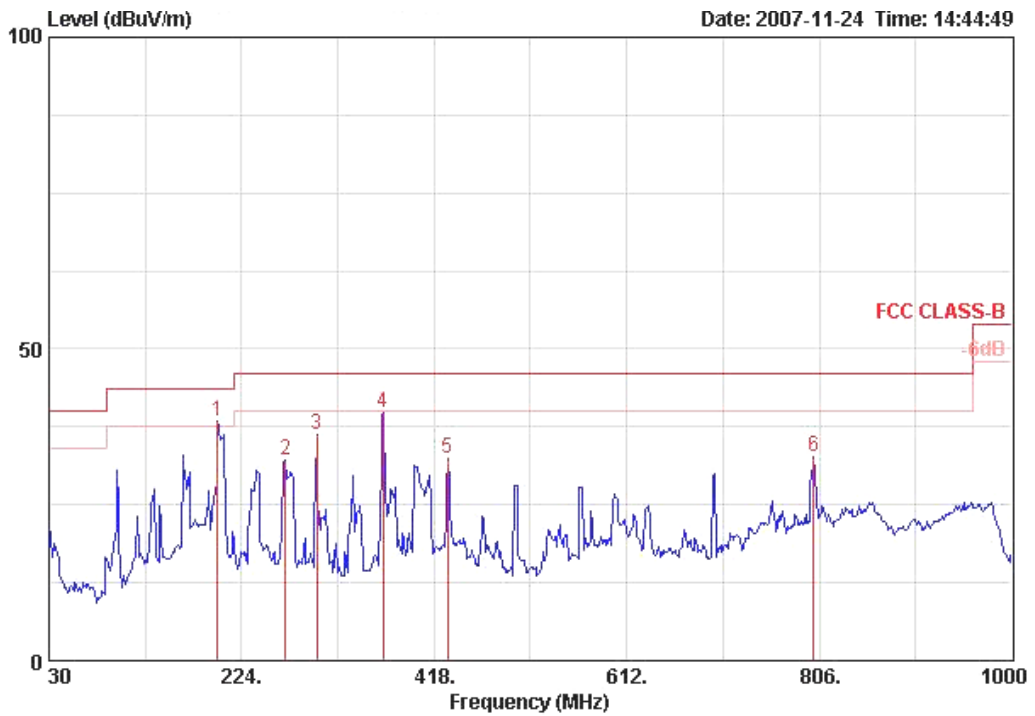

	Freq	Level	Over Limit	Limit Line	Read Level	Antenna Factor	Cable Loss	Preamp Factor	Remark	Ant Pos	Table Pos
	MHz	dBuV/m	dB	dBuV/m	dBuV	dB/m	dB	dB		cm	deg
1 !	199.750	38.34	-5.16	43.50	52.54	10.30	0.96	25.46	Peak	100	46
2	268.620	32.16	-13.84	46.00	42.71	13.55	1.15	25.24	Peak	400	0
3	299.660	36.11	-9.89	46.00	46.01	13.90	1.14	24.94	Peak	400	0
4	366.590	39.70	-6.30	46.00	47.87	15.70	1.31	25.17	Peak	400	0
5	431.580	32.44	-13.56	46.00	39.80	16.94	1.49	25.79	Peak	400	0
6	800.180	32.63	-13.37	46.00	34.62	20.70	2.50	25.19	Peak	400	0

**Note:**

The amplitude of spurious emissions that are attenuated by more than 20dB below the permissible value has no need to be reported.

Emission level (dBuV/m) = 20 log Emission level (uV/m).

Corrected Reading: Antenna Factor + Cable Loss + Read Level - Preamp Factor = Level.



4.5.9. Results for Radiated Emissions (1GHz~10<sup>th</sup> Harmonic)

Temperature	23°C	Humidity	56%
Test Engineer	Aric Lee	Configurations	Draft n MCS0 20MHz Ch 1 Ant. A -1/ Mode 1

Horizontal

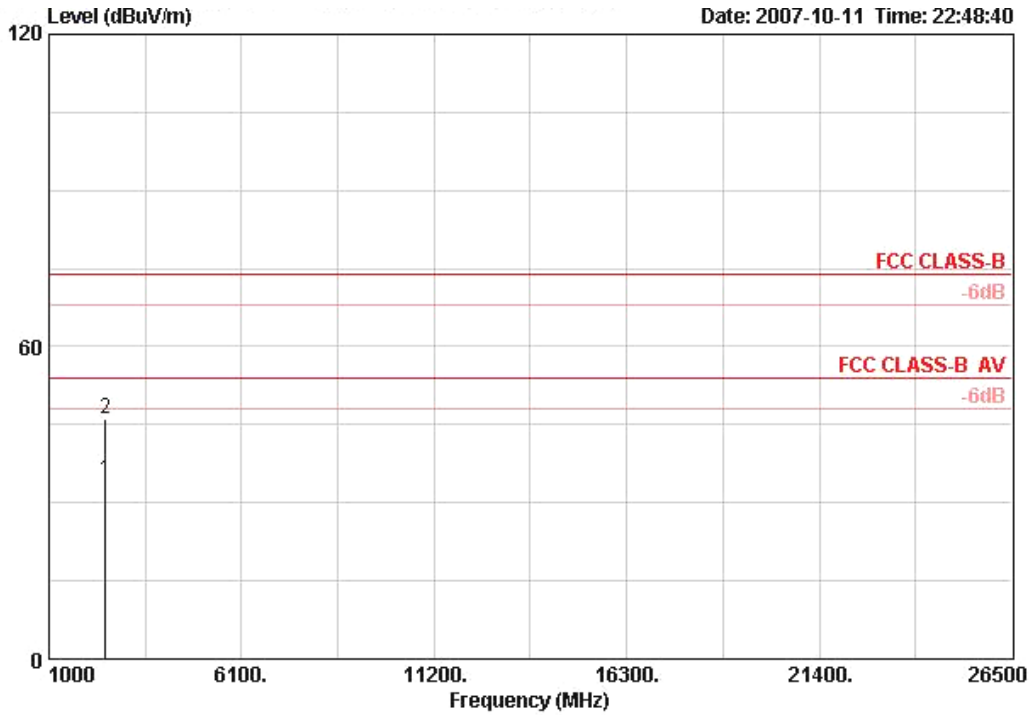

	Freq	Level	Over Limit	Limit Line	ReadAntenna Level	Antenna Factor	Cable Loss	Preamp Factor	Remark	Ant Pos	Table Pos
	MHz	dBuV/m	dB	dBuV/m	dBuV	dB/m	dB	dB		cm	deg
1	2499.920	34.30	-19.70	54.00	34.35	28.30	5.15	33.50	AVERAGE	122	189
2	2499.920	45.98	-28.02	74.00	46.02	28.30	5.15	33.50	PEAK	122	189



**Vertical**

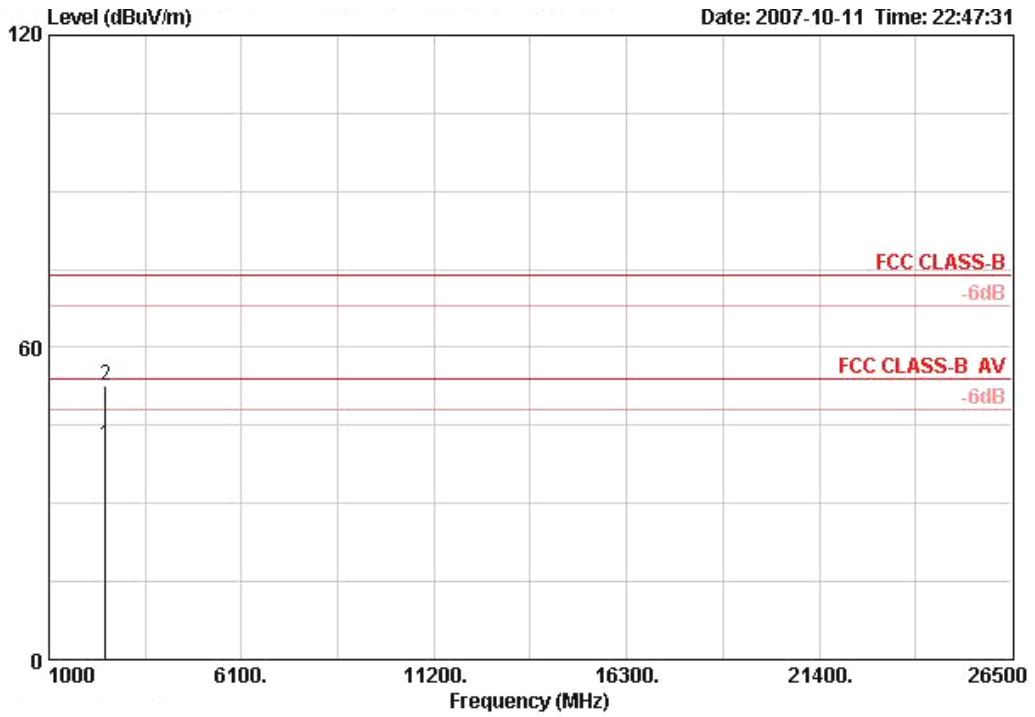

	Freq	Level	Over Limit	Limit Line	ReadAntenna Level	Antenna Factor	Cable Loss	Preamp Factor	Remark	Ant Pos	Table Pos
	MHz	dBuV/m	dB	dBuV/m	dBuV	dB/m	dB	dB		cm	deg
1	2499.920	41.34	-12.66	54.00	41.39	28.30	5.15	33.50	AVERAGE	100	260
2	2499.920	52.75	-21.25	74.00	52.80	28.30	5.15	33.50	PEAK	100	260



Temperature	23°C	Humidity	56%
Test Engineer	Aric Lee	Configurations	Draft n MCS0 20MHz Ch 6 Ant. A -1 / Mode 1

Horizontal

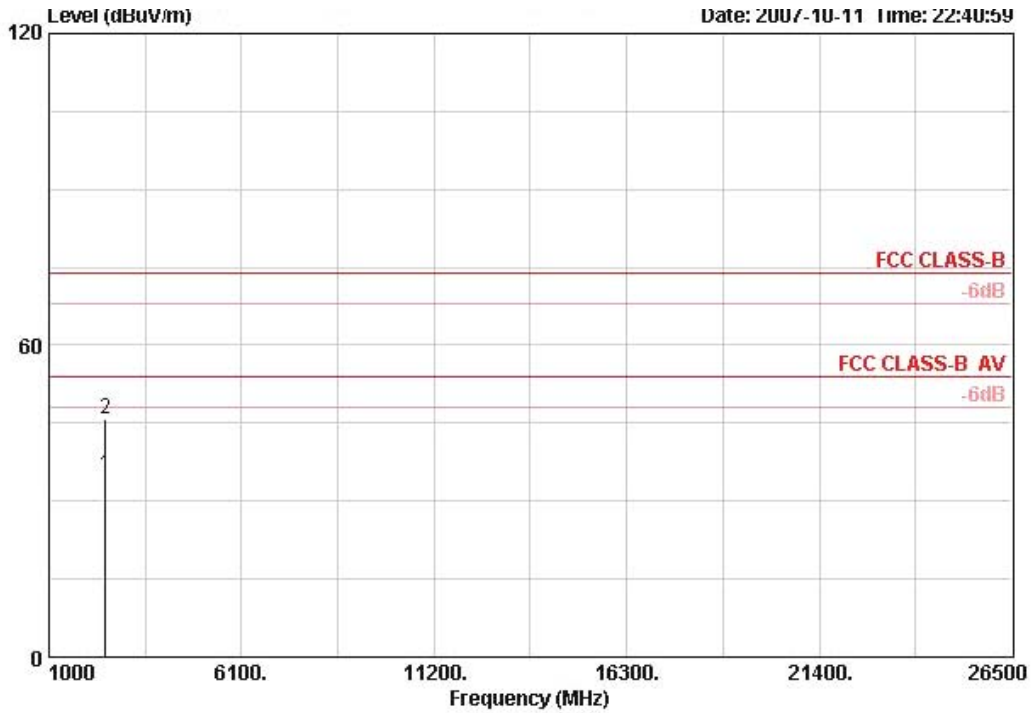

	Freq	Level	Over Limit	Limit Line	Read Level	Antenna Factor	Cable Loss	Preamp Factor	Remark	Ant Pos	Table Pos
	MHz	dBuV/m	dB	dBuV/m	dBuV	dB/m	dB	dB		cm	deg
1	2499.920	35.00	-19.00	54.00	35.04	28.30	5.15	33.50	AVERAGE	123	188
2	2499.920	45.88	-28.12	74.00	45.93	28.30	5.15	33.50	PEAK	123	188

**Vertical**

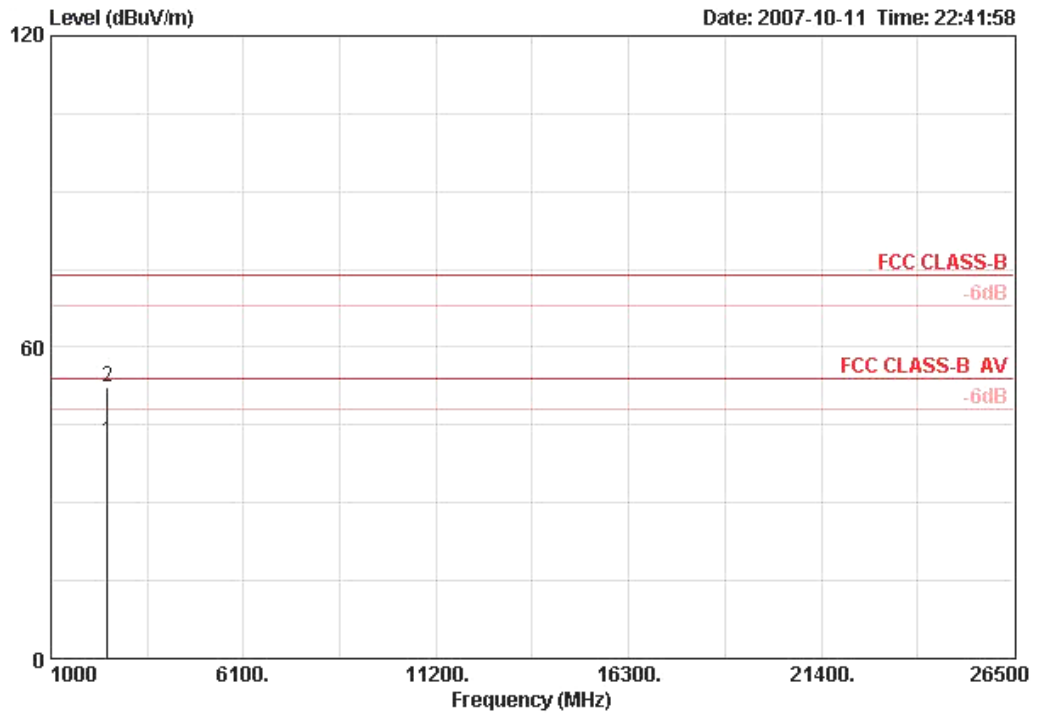

	Freq	Level	Over Limit	Limit Line	ReadAntenna Level	Antenna Factor	Cable Loss	Preamp Factor	Remark	Ant Pos	Table Pos
	MHz	dBuV/m	dB	dBuV/m	dBuV	dB/m	dB	dB		cm	deg
1	2499.920	41.73	-12.27	54.00	41.77	28.30	5.15	33.50	AVERAGE	100	262
2	2499.920	52.47	-21.53	74.00	52.52	28.30	5.15	33.50	PEAK	100	262



Temperature	23°C	Humidity	56%
Test Engineer	Aric Lee	Configurations	Draft n MCS0 20MHz Ch11 Ant. A -1 / Mode 1

Horizontal

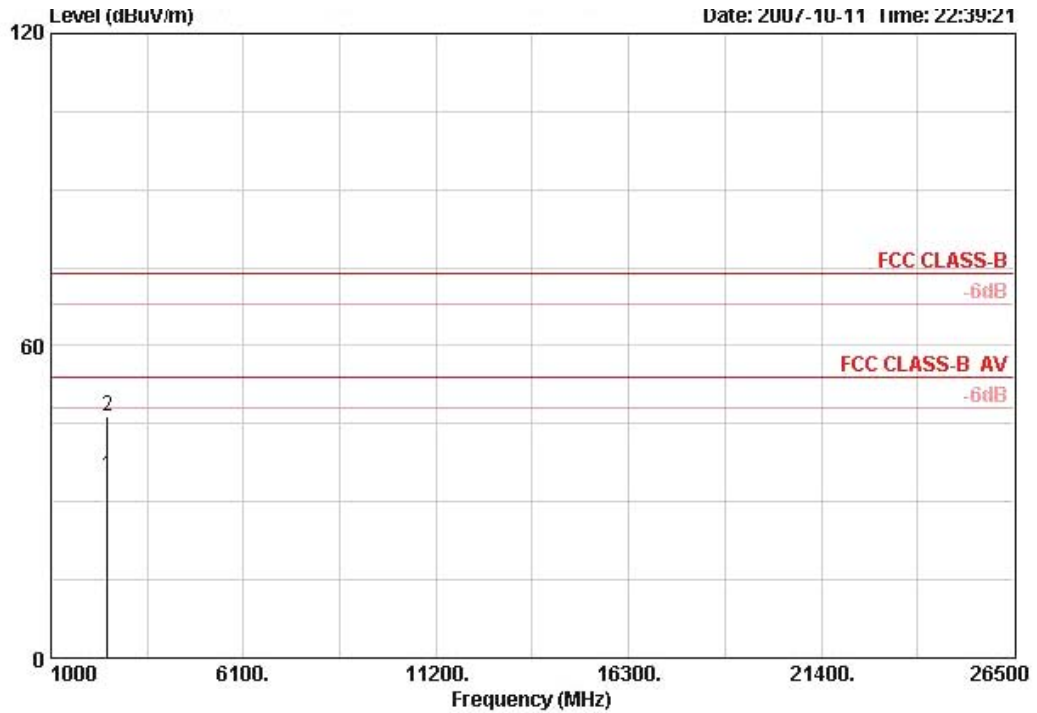

	Freq	Level	Over Limit	Limit Line	Read Level	Antenna Factor	Cable Loss	Preamp Factor	Remark	Ant Pos	Table Pos
	MHz	dBuV/m	dB	dBuV/m	dBuV	dB/m	dB	dB		cm	deg
1	2499.920	34.89	-19.11	54.00	34.93	28.30	5.15	33.50	AVERAGE	124	187
2	2499.920	46.29	-27.71	74.00	46.33	28.30	5.15	33.50	PEAK	124	187

**Vertical**

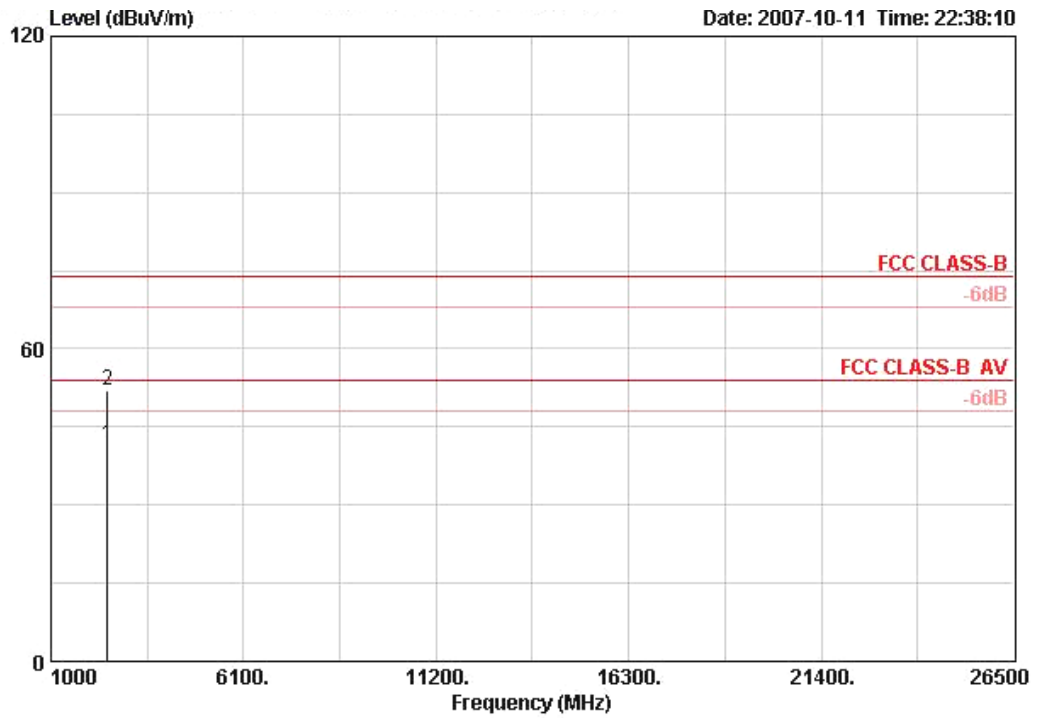

	Freq	Level	Over Limit	Limit Line	Read Level	Antenna Factor	Cable Loss	Preamp Factor	Remark	Ant Pos	Table Pos
	MHz	dBuV/m	dB	dBuV/m	dBuV	dB/m	dB	dB		cm	deg
1	2499.920	41.68	-12.32	54.00	41.72	28.30	5.15	33.50	AVERAGE	100	260
2	2499.920	52.07	-21.93	74.00	52.12	28.30	5.15	33.50	PEAK	100	260



Temperature	23°C	Humidity	56%
Test Engineer	Aric Lee	Configurations	Draft n MCS0 40MHz Ch 3 Ant. A -1 / Mode 1

**Horizontal**

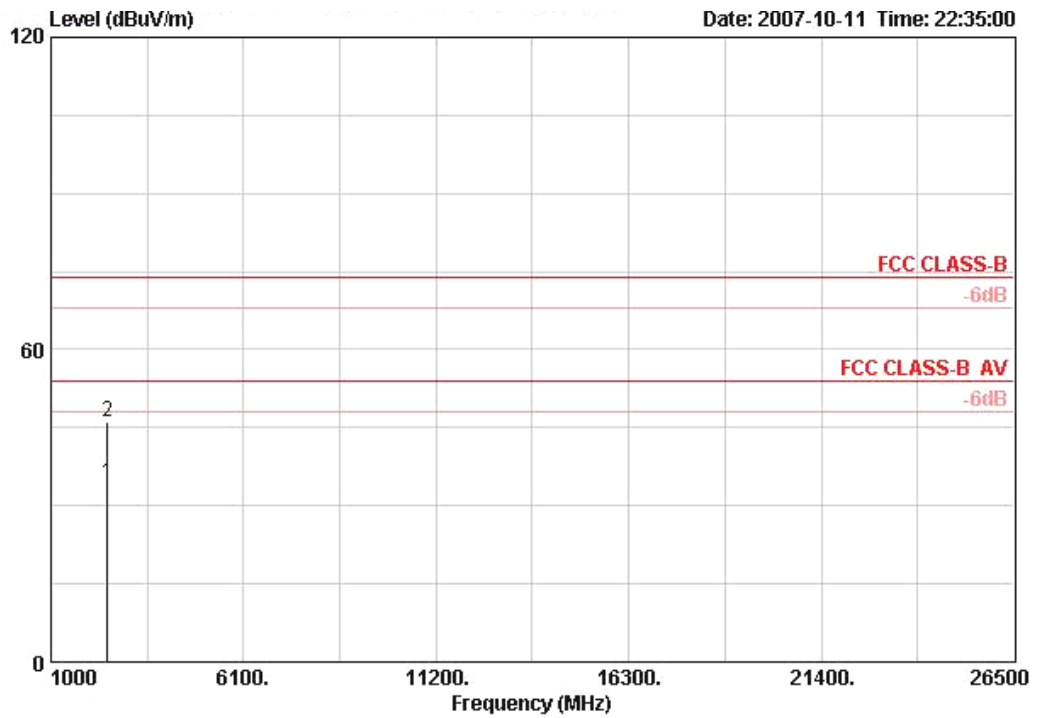

	Freq	Level	Over Limit	Limit Line	Read Level	Antenna Factor	Cable Loss	Preamp Factor	Remark	Ant Pos	Table Pos
	MHz	dBUV/m	dB	dBUV/m	dBuV	dB/m	dB	dB		cm	deg
1	2498.320	34.25	-19.75	54.00	34.30	28.30	5.15	33.50	AVERAGE	126	187
2	2498.320	46.16	-27.84	74.00	46.20	28.30	5.15	33.50	PEAK	126	187

**Vertical**

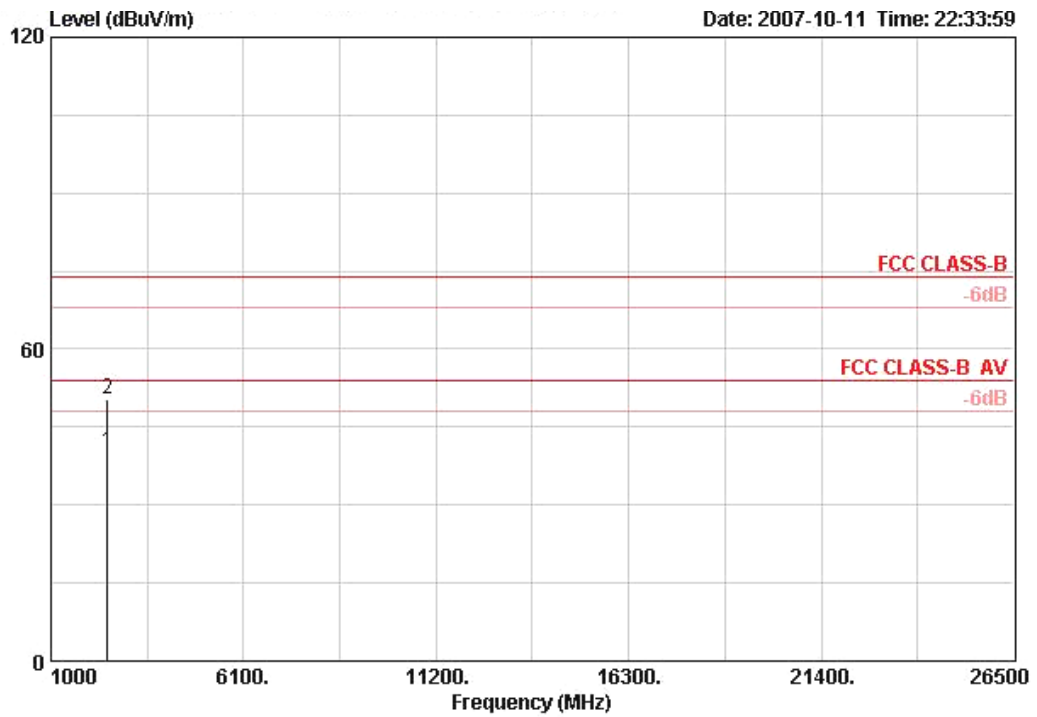

	Freq	Level	Over Limit	Limit Line	Read Level	Antenna Factor	Cable Loss	Preamp Factor	Remark	Ant Pos	Table Pos
	MHz	dBuV/m	dB	dBuV/m	dBuV	dB/m	dB	dB		cm	deg
1	2499.720	40.27	-13.73	54.00	40.31	28.30	5.15	33.50	AVERAGE	100	261
2	2499.720	50.19	-23.81	74.00	50.24	28.30	5.15	33.50	PEAK	100	261



Temperature	23°C	Humidity	56%
Test Engineer	Aric Lee	Configurations	Draft n MCS0 40MHz Ch 6 Ant. A -1 / Mode 1

Horizontal

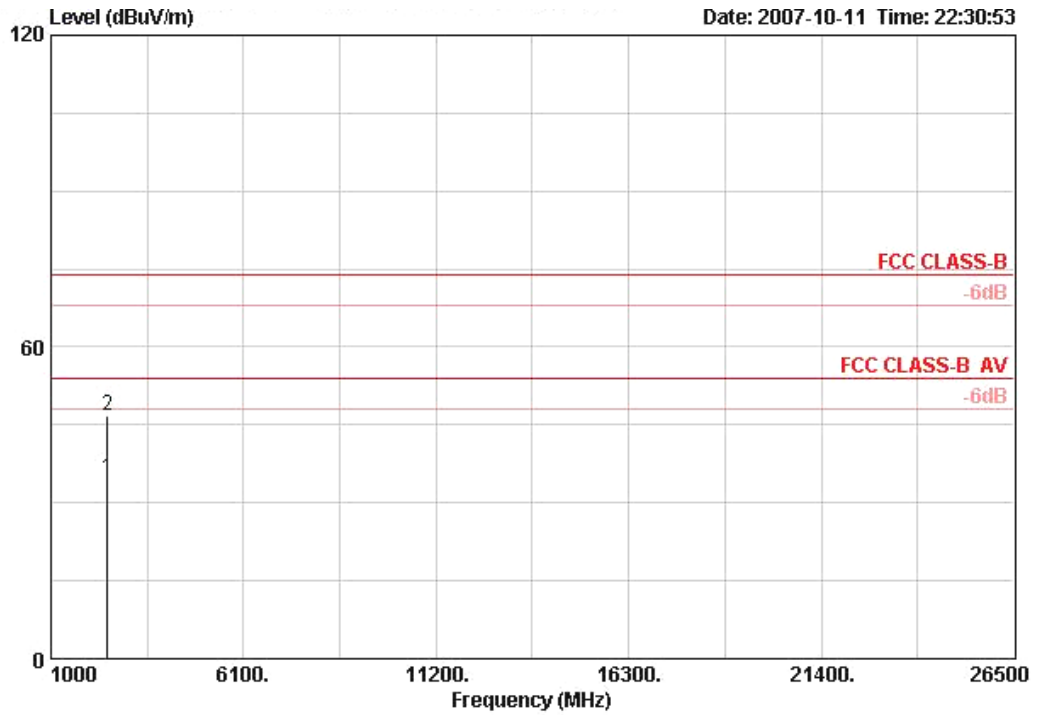

	Freq	Level	Over Limit	Limit Line	Read Level	Antenna Factor	Cable Loss	Preamp Factor	Remark	Ant Pos	Table Pos
	MHz	dBUV/m	dB	dBUV/m	dBuV	dB/m	dB	dB		cm	deg
1	2498.420	34.66	-19.34	54.00	34.71	28.30	5.15	33.50	AVERAGE	128	188
2	2498.420	46.68	-27.32	74.00	46.72	28.30	5.15	33.50	PEAK	128	188



**Vertical**

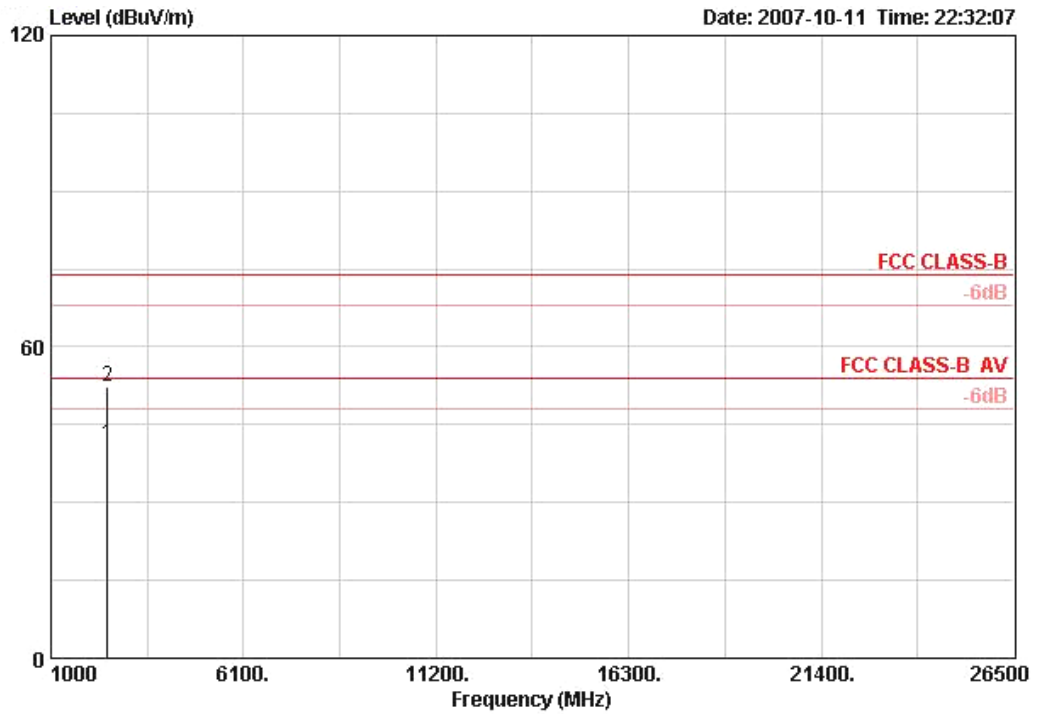

	Freq	Level	Over Limit	Limit Line	ReadAntenna Level	Antenna Factor	Cable Loss	Preamp Factor	Remark	Ant Pos	Table Pos
	MHz	dBuV/m	dB	dBuV/m	dBuV	dB/m	dB	dB		cm	deg
1	2499.520	41.05	-12.95	54.00	41.10	28.30	5.15	33.50	AVERAGE	100	260
2	2499.520	52.40	-21.60	74.00	52.44	28.30	5.15	33.50	PEAK	100	260



Temperature	23°C	Humidity	56%
Test Engineer	Aric Lee	Configurations	Draft n MCS0 40MHz Ch 9 Ant. A -1 / Mode 1

Horizontal

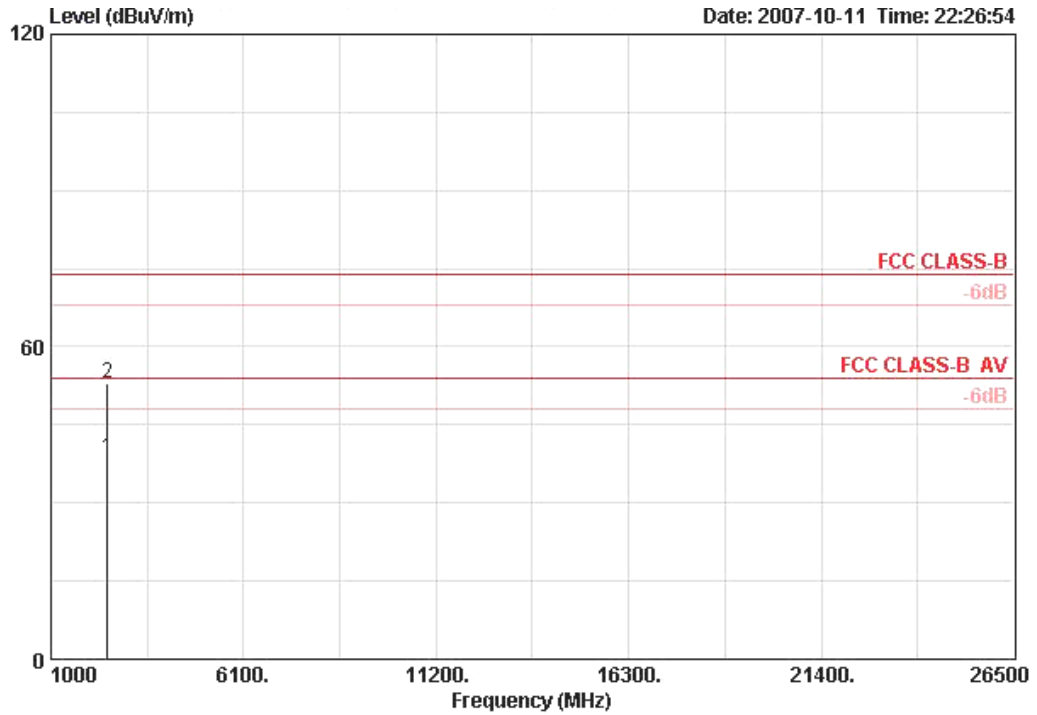

	Freq	Level	Over Limit	Limit Line	Read Level	Antenna Factor	Cable Loss	Preamp Factor	Remark	Ant Pos	Table Pos
	MHz	dBuV/m	dB	dBuV/m	dBuV	dB/m	dB	dB		cm	deg
1	2496.720	38.58	-15.42	54.00	38.63	28.30	5.15	33.50	AVERAGE	126	187
2	2496.720	53.02	-20.98	74.00	53.07	28.30	5.15	33.50	PEAK	126	187

**Vertical**

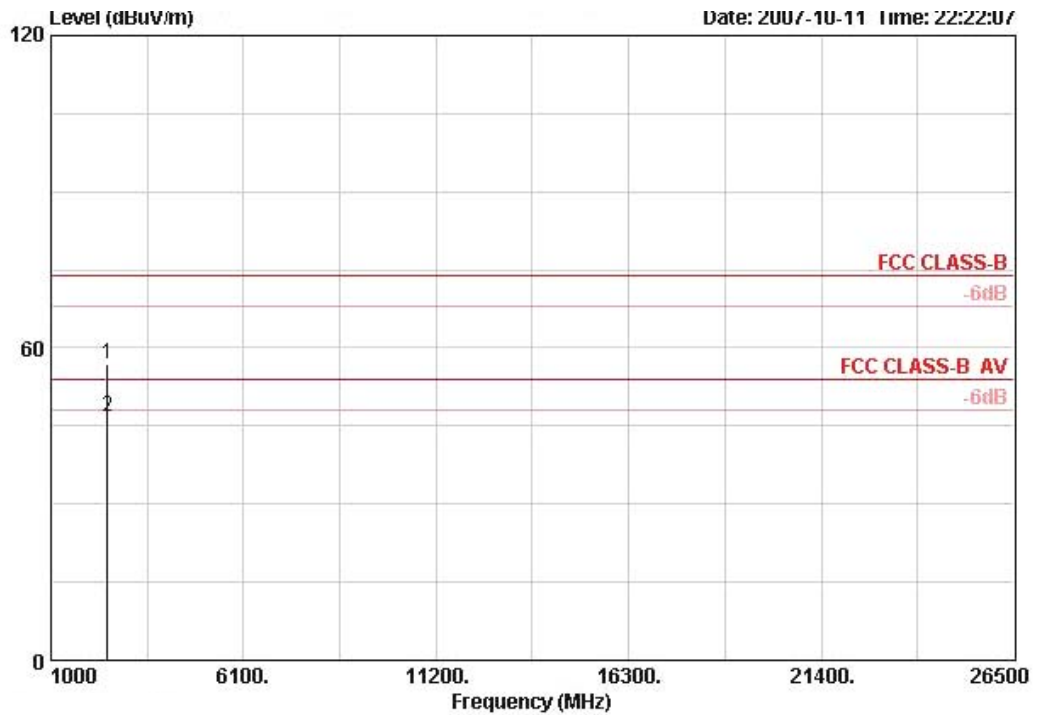

	Over	Limit	Read	Antenna	Cable	Preamp		Ant	Table
Freq	Level	Limit	Level	Factor	Loss	Factor	Remark	Pos	Pos
MHz	dBuV/m	dB	dBuV/m	dBuV	dB/m	dB	dB	cm	deg
1	2497.320	56.99	-17.01	74.00	57.04	28.30	5.15 33.50	PEAK	100 261
2	2498.560	46.86	-7.14	54.00	46.90	28.30	5.15 33.50	AVERAGE	100 261

**Note:**

The amplitude of spurious emissions which are attenuated by more than 20 dB below the permissible value has no need to be reported.

Emission level (dBUV/m) = 20 log Emission level (uV/m).

Corrected Reading: Antenna Factor + Cable Loss + Read Level - Preamp Factor = Level.

<b>Temperature</b>	23°C	<b>Humidity</b>	56%
<b>Test Engineer</b>	Aric Lee	<b>Configurations</b>	Draft n MCS0 20MHz Ch 1 Ant. B-1 / Mode 2

**Horizontal**

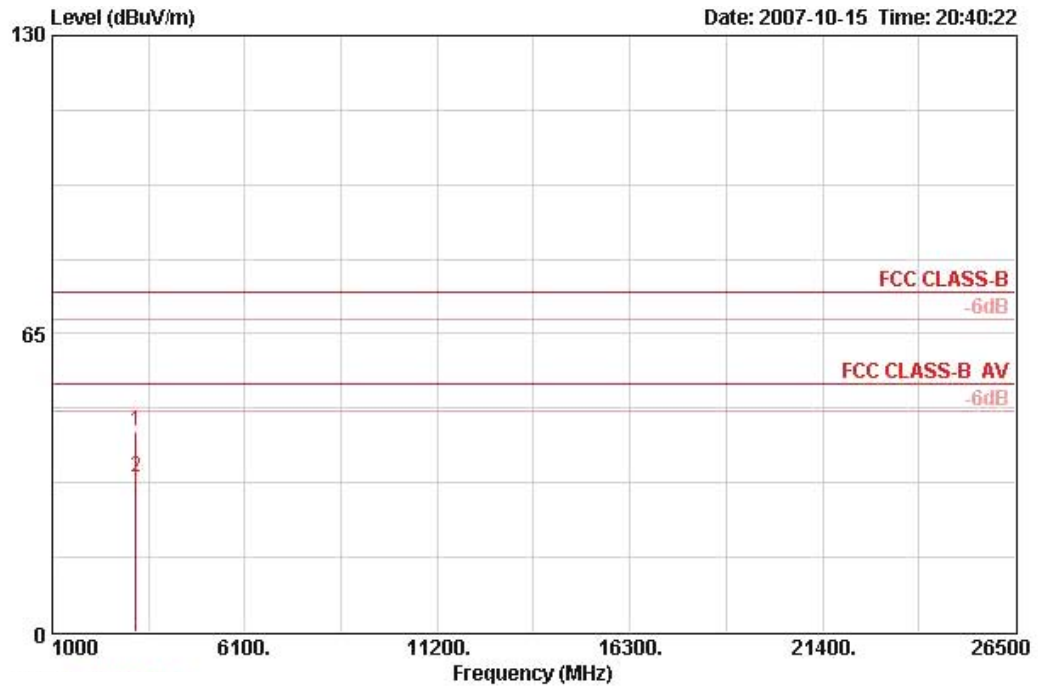

	Freq	Level	Over Limit	Limit Line	Remark	Pol/Phase	Distance	ReadAntenna Level	Antenna Factor	Cable Loss	Preamp Factor
	MHz	dBuV/m	dB	dBuV/m			m	dBuV	dB/m	dB	dB
1	3215.680	43.82	-30.18	74.00	PEAK	HORIZONTAL	3	45.32	30.00	3.63	35.12
2	3216.020	33.88	-20.12	54.00	AVERAGE	HORIZONTAL	3	35.37	30.00	3.63	35.12