



Ecom Sertech Corp.

Rm. 258, Bldg. 17, NO.195, Sec. 4 Chung Hsing Rd., ChuTung Chen, Hsinchu, Taiwan 310, R.O.C
TEL:886-3-5918012 FAX : 886-3-5825720

FCC ID : JCK-GN-WPKG
Report No. : ER04-04-003FRF
Page 1 of 64



TEST REPORT

Product Name : PCI Wireless LAN Card
Model Number : GN-WPKG
Brand Name : GIGABYTE

Applicant : GIGA-BYTE TECHNOLOGY CO., LTD.
Address : No. 6, Bau Chiang Road, Hsin-Tien, Taipei Hsien, Taiwan, R.O.C.

Received Date : Apr. 05, 2004
Tested Date : Apr. 05~08, 2004

Notes :

1. This report will be invalid if duplicated or photocopied in part.
2. This report refers only to the specimen(s) submitted to testing, and be invalid as seperately used.
3. This report is invalid without examination stamp and signature of this institute.
4. The tested specimen(s) will be preserved for thirty days from the data issued.
5. The report must not be used to claim product certification, approval, or endorsement by NVLAP, NIST, or any agency of the federal government.





Ecom Sertech Corp.

Rm. 258, Bldg. 17, NO.195, Sec. 4 Chung Hsing Rd., ChuTung Chen, Hsinchu, Taiwan 310, R.O.C
TEL:886-3-5918012 FAX: 886-3-5825720

FCC ID : JCK-GN-WPKG
Report No. : ER04-04-003FRF
Page 2 of 64

Test Report Certification

Product Name : PCI Wireless LAN Card
Model Number : GN-WPKG
Applicant : GIGA-BYTE TECHNOLOGY CO., LTD.

Measurement Standard :

FCC 47 C.F.R. Part 15, Subpart B and Subpart C (Section 15.247),
ANSI C63.4 (2001)

Tested By : Stan Peng Date: Apr. 08, 2004
 (Stan Peng)

Reviewed By : Roger Shen Date: Apr. 08, 2004
 (Roger Shen)

Approved By : Chieh-De Tsai Date: Apr. 08, 2004
 (Chieh-De Tsai, Manager)



WE HEREBY CERTIFY THAT: The measurements shown in the attachment were made in accordance with the procedures indicated, and the energy emitted by the equipment was found to be within the limits applicable. We assume full responsibility for the accuracy and completeness of these measurements and vouch for the qualifications of all persons taking them.



TABLE OF CONTENTS

| TITLE | PAGE NO. |
|---|-----------|
| 1. GENERAL INFORMATION..... | 5 |
| 1.1 General Statement..... | 5 |
| 1.2 General Description of EUT & Power..... | 5 |
| 1.3 Description of Peripherals..... | 6 |
| 1.4 EUT & Peripherals Setup Diagram..... | 7 |
| 1.5 EUT Operating Procedure..... | 8 |
| 1.6 Description of Test Site..... | 8 |
| 1.7 Summary of Test Results..... | 9 |
| 2. CONDUCTED POWERLINE TEST | 10 |
| 2.1 Test Equipments..... | 10 |
| 2.2 Test Setup..... | 10 |
| 2.3 Conducted Power Line Emission Limit..... | 11 |
| 2.4 Test Procedure..... | 11 |
| 2.5 Uncertainty of Conducted Emission..... | 11 |
| 2.6 Conducted RF Voltage Measurement..... | 12-13 |
| 2.7 Photos of Conduction Test..... | 14 |
| 3. RADIATED EMISSION TEST..... | 15 |
| 3.1 Test Equipments..... | 15 |
| 3.2 Test Setup..... | 15 |
| 3.3 Radiation Limit..... | 16 |
| 3.4 Test Procedures..... | 17 |
| 3.5 Uncertainty of Radiated Emission..... | 17 |
| 3.6 Radiated RF Noise Measurement..... | 18-42 |
| 3.7 Photos of Open Site..... | 43-44 |
| 4. 6dB BANDWIDTH MEASUREMENT..... | 45 |
| 4.1 Test Equipments..... | 45 |
| 4.2 Test Setup..... | 45 |
| 4.3 Limits of 6dB Bandwidth Measurement..... | 45 |
| 4.4 Test Procedure..... | 45 |
| 4.5 Uncertainty of Conducted Emission..... | 45 |
| 4.6 Test Results..... | 46 |
| 4.7 Photo of 6db Bandwidth Measurement..... | 47-48 |
| 5. MAXIMUM PEAK OUTPUT POWER..... | 49 |
| 5.1 Test Equipments..... | 49 |
| 5.2 Test Setup..... | 49 |
| 5.3 Limits of Maximum Peak Output Power..... | 49 |
| 5.4 Test Procedure..... | 50 |
| 5.5 Uncertainty of Conducted Emission..... | 50 |
| 5.6 Test Results..... | 50 |
| 6. POWER SPECTRAL DENSITY MEASUREMENT | 51 |
| 6.1 Test Equipments..... | 51 |
| 6.2 Test Setup..... | 51 |
| 6.3 Limits of Power Spectral Density Measurement..... | 51 |
| 6.4 Test Procedure..... | 52 |
| 6.5 Uncertainty of Conducted Emission..... | 52 |
| 6.6 Test Results..... | 52 |
| 6.7 Photo of Power Spectral Density Measurement..... | 53-54 |



Ecom Sertech Corp.

Rm. 258, Bldg. 17, NO.195, Sec. 4 Chung Hsing Rd., ChuTung Chen, Hsinchu, Taiwan 310, R.O.C
TEL:886-3-5918012 FAX : 886-3-5825720

FCC ID : JCK-GN-WPKG
Report No. : ER04-04-003FRF
Page 4 of 64

TABLE OF CONTENTS

| TITLE | PAGE NO. |
|---|-----------|
| 7. BAND EDGE MEASUREMENT..... | 55 |
| 7.1 Test Equipments | 55 |
| 7.2 Test Setup | 55 |
| 7.3 Limits of Band Edge Emissions Measurement | 55 |
| 7.4 Test Procedure | 56 |
| 7.5 Uncertainty of Conducted Emission | 56 |
| 7.6 Test Results | 56-57 |
| 7.7 Photo of Band edge Measurement | 58-61 |
| 8. ANTENNA REQUIREMENT | 62 |
| 8.1 Standard Applicable..... | 62 |
| 8.2 Antenna Connected Construction | 62 |
| 9. RF EXPOSURE EVALUATION | 63 |
| 9.1 Friis Formula..... | 63 |
| 9.2 EUT Operating Condition..... | 63 |
| 9.3 Test Result of RF Exposure Evaluation..... | 64 |
| 9.3.1 Antenna Gain | 64 |
| 9.3.2 Output Power into Antenna & RF Exposure Evaluation Distance | 64 |



1. GENERAL INFORMATION

1.1 General Statement

MEASUREMENT DEVIATION : Comply with standard in full

TRACEABILITY : This test result is traceable to National or International std.

1.2 General Description of EUT & Power

MANUFACTURER : GIGA-BYTE TECHNOLOGY CO., LTD.
SAMPLE NAME : PCI Wireless LAN Card
MODEL NAME : GN-WPKG
FREQUENCY RANGE : 2412 MHz to 2462MHz
CHANNEL NUMBER : 1~11CH
AIR DATA RATE : 11Mbps(802.11b mode), 54Mbps (802.11g mode)
TYPE OF MODULATION : Direct Sequence Spread Spectrum
and Orthogonal Frequency Division Multiplex
FREQUENCY SELECTION : BY SOFTWARE
EUT DESCRIPTION : 2.4GHz (Direct Sequence Spread Spectrum
and Orthogonal Frequency Division Multiplex) data
transceiver for PCI Wireless LAN Card
ANTENNA TYPE : Dipole Antenna , Antenna Gain : 2dBi.
POWER SOURCE : 5VDC (From PC)



1.3 Description of Peripherals

(1) PC

MANUFACTURER : HP CORP.
MODEL NUMBER : t123d
SERIAL NUMBER : TW31720190
FCC : DOC

(2) Notebook PC

MANUFACTURER : COMPAQ CORP.
MODEL NUMBER : N800V
SERIAL NUMBER : 5Y33KSQZMOYL
FCC : DOC

(3) PRINTER

MANUFACTURER : HP CORP.
MODEL NUMBER : C6431D
SERIAL NUMBER : CN19T6S011
FCC ID : DOC
POWER SOURCE : 100-240VAC,50/60Hz,0.7A
SIGNAL CABLE : Shielded , Undetachable , 1.8m

(4) MODEM

MANUFACTURER : ZYXEL communication Corp.
MODEL NUMBER : Omni 56K
SERIAL NUMBER : S1Z4107729
FCC ID : 1880MN156K
POWER SOURCE : 9VAC(From Power Adapter)
SIGNAL CABLE : Shielded , Undetachable , 1.8m

(5) MOUSE

MANUFACTURER : HP CORP.
MODEL NUMBER : M-S34
SERIAL NUMBER : LZE95050431
FCC ID : DZL211029
SIGNAL CABLE : Shielded , Undetachable , 1.8m
POWER SOURCE : 5VDC (from PC)

(6) KEYBOARD

MANUFACTURER : Genuine Company INC.
MODEL NUMBER : K288
SERIAL NUMBER : 206628619
FCC ID : FKD46AK288
POWER SOURCE : 5VDC (from PC)
SIGNAL CABLE : Shielded , Undetachable , 1.8m

(7) MONITOR

MANUFACTURER : HP CORP.
MODEL NUMBER : D8894A
SERIAL NUMBER : CN00905269
FCC ID : ARSCM569N
POWER CORD : UnShielded , Detachable , 1.8m
SIGNAL CABLE : Shielded , Undetachable , 1.8m

1.4 EUT & Peripherals Setup Diagram

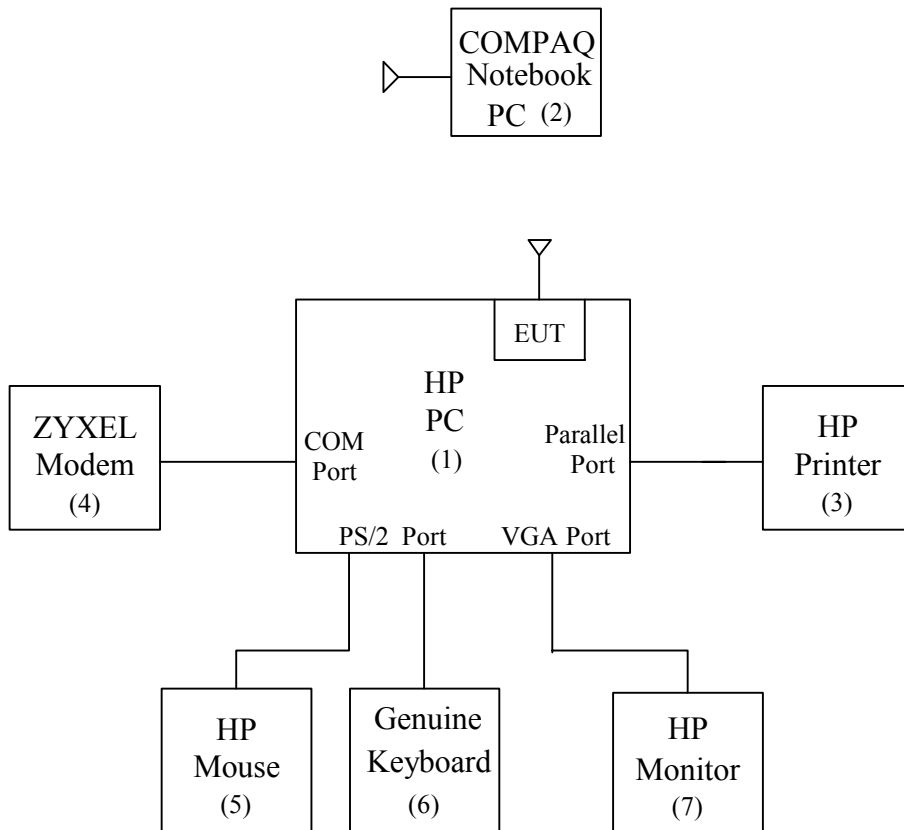

The indicated numbers (1)(2)....., please refer to item 1.3



Ecom Sertech Corp.

Rm. 258, Bldg. 17, NO.195, Sec. 4 Chung Hsing Rd., ChuTung Chen, Hsinchu, Taiwan 310, R.O.C
TEL:886-3-5918012 FAX: 886-3-5825720

FCC ID : JCK-GN-WPKG
Report No. : ER04-04-003FRF
Page 8 of 64

1.5 EUT Operating Procedure

1. Install Ralink QA test program for RT2500.
2. Press RT2500 QA run TX/RX continue test program.
3. Preamble set LONG, rate set 11 is for 802.1b mode.
4. Preamble set OFDM, rate set 54 is for 802.11g test.
5. Choice conti, TX option, press start TX, start test.
6. Press start RX, start RX test.

1.6 Description of Test Site

SITE DESCRIPTION

FCC Certificate NO. : 90585
BSMI Certificate NO. : SL2-IN-E-0002
NVLAP Lab code : 200118-0
CNLA Certificate NO. : CNLA-ZL97018
VCCI Certificate NO. : R-1189, C-1250
TÜV Certificate NO. : 10008375

NAME OF SITE : Ecom Sertech Corp. Hsin-Chu Lab.
(Spin-off from ITRI / ERSO on Apr. 01, 2003)

SITE LOCATION : Rm.258, Bldg.17, NO.195 , Sec. 4, Chung Hsing Rd.,
Chu-Tung Chen. Hsin-Chu, Taiwan 310 R.O.C.



Ecom Sertech Corp.

Rm. 258, Bldg. 17, NO.195, Sec. 4 Chung Hsing Rd., ChuTung Chen, Hsinchu, Taiwan 310, R.O.C
TEL:886-3-5918012 FAX: 886-3-5825720

FCC ID : JCK-GN-WPKG
Report No. : ER04-04-003FRF
Page 9 of 64

1.7 Summary of Test Results

The EUT has been tested according to the following specifications :

APPLIED STANDARD : FCC 47 C.F.R. Part 15, Subpart B and Subpart C

| Standard Section | Test Type and Limit | Result | REMARK |
|----------------------------|--|--------|-------------------------------|
| 15.107 15.207 | AC Power Conducted Emission Limit : 15.107 | PASS | Meet the requirement of limit |
| 15.247(a)(2) | Spectrum Bandwidth of a Orthogonal Frequency Division Multiplex System Limit : 6dB bandwidth > 500KHz | PASS | Meet the requirement of limit |
| 15.247(b) | Maximum Peak Output Power Limit : max. 30dBm | PASS | Meet the requirement of limit |
| 15.109 15.205 15.209 | Transmitter Radiated Emissions Limit : Table 15.209 | PASS | Meet the requirement of limit |
| 15.247(d) | Power Spectral Density Limit : max. 8dBm | PASS | Meet the requirement of limit |
| 15.247(c) | Out of Band Emission and Restricted Band Radiation Limit:20dB less than peak value of fundamental frequency Restricted band Limit:Table 15.209 | PASS | Meet the requirement of limit |



2. CONDUCTED POWERLINE TEST

2.1 Test Equipments

The following test equipments are used during the conducted powerline tests :

| Manufacturer or Type | Model No. | Serial No. | Date of Calibration | Calibration Period | Remark |
|--------------------------------|-----------|------------------------|---|--------------------|---------|
| HP SPECTRUM ANALYZER & DISPLAY | 8568A | 2235A02320 | NOV. 14, 2003 | 1 Year | PRETEST |
| HP QUASI-PEAK ADAPTER | 85650 A | 2341A00672 | NOV. 14, 2003 | 1 Year | PRETEST |
| SOLAR ISOLATION TRANSFORMER | 7032-1 | N/A | N/A | N/A | FINAL |
| EMCO L.I.S.N. | 3850/2 | 9311-1025 9401-1028 | JAN. 08, 2004 For Characteristic impedance | 1 Year | FINAL |
| | | | MAY. 18, 2003 For Insertion loss | | |
| R & S TEST RECEIVER | ESHS 30 | 838550/003 | FEB. 11, 2004 | 1 Year | FINAL |
| KEENE SHIELDED ROOM | 5983 | No.1 | N/A | N/A | FINAL |
| R & S PULSE LIMIT | EHS3Z2 | 357.8810.52 | JUL. 10, 2003 | 1 Year | FINAL |
| N TYPE COAXIAL CABLE | ----- | ----- | JUL. 10, 2003 | 1 Year | FINAL |
| 50Ω TERMINATOR | ----- | ----- | JUL. 10, 2003 | 1 Year | FINAL |

2.2 Test Setup

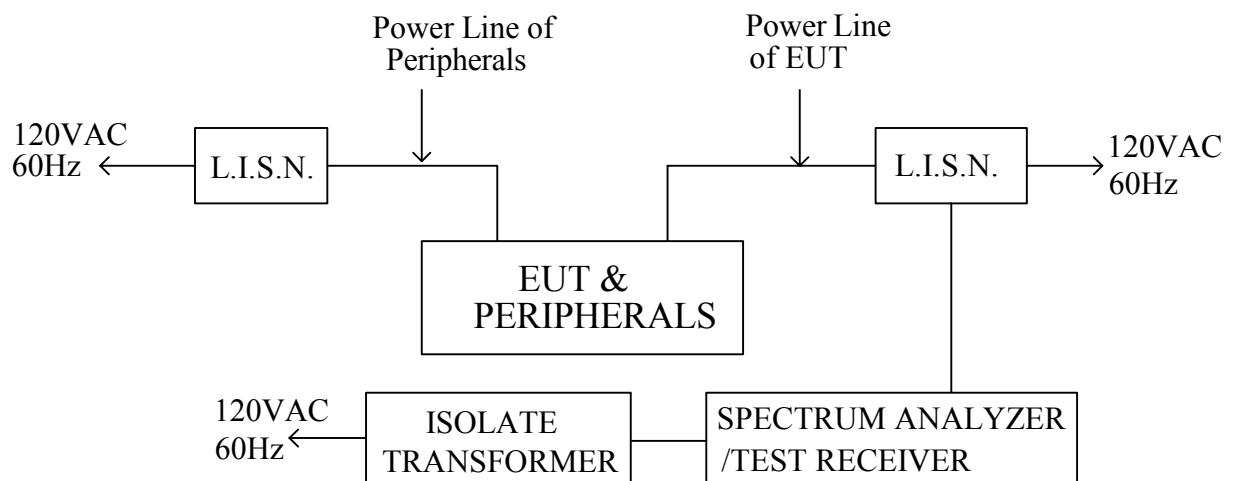



2.3 Conducted Power Line Emission Limit

For unintentional device, according to § 15.107(a) Line Conducted Emission Limits is as following :

| Frequency (MHz) | Maximum RF Line Voltage (dB μ v) | | | |
|-----------------|--------------------------------------|------|---------|-------|
| | CLASS A | | CLASS B | |
| | Q.P. | Ave. | Q.P. | Ave. |
| 0.15 - 0.50 | 79 | 66 | 66-56 | 56-46 |
| 0.50 - 5.00 | 73 | 60 | 56 | 46 |
| 5.00 - 30.0 | 73 | 60 | 60 | 50 |

For intentional device, according to § 15.207(a) Line Conducted Emission Limit is same as above table.

2.4 Test Procedure

The test procedure is performed in a 12ft×12ft×8ft(L×W×H) shielded room. the EUT along with its peripherals were placed on a 1.0m(W)× 1.5m(L) and 0.8m in height wooden table and the EUT was adjusted to maintain a 0.4 meter space from a vertical reference plane. The EUT was connected to power mains through a line impedance stabilization network (LISN) which provides 50 ohm coupling impedance for measuring instrument and the chasis ground was bounded to the horizontal ground plane of shielded room. All peripherals were connected to the second LISN and the chasis ground also bounded to the horizontal ground plane of shielded room. The excess power cable between the EUT and the LISN was bundled. The power cables of peripherals were unbundled. All connecting cables of EUT and peripherals were moved to find the maximum emission.

2.5 Uncertainty of Conducted Emission

The uncertainty of conducted emission is ±1.36dB.



2.6 Conducted RF Voltage Measurement

The frequency spectrum from 0.15 MHz to 30 MHz was investigated. All emissions not reported below are more than 30 dB below the prescribed limits.

Temperature : 26 °C

Humidity : 65 % RH

| Frequency (MHz) | Loss(dB) | | Measurement | | | | L1 Emission (dBμV) | | L2 Emission (dBμV) | | Limits (dBμV) | |
|-----------------|----------|------|-------------|------|----------|------|--------------------|------|--------------------|------|---------------|-------|
| | | | L1(dBμV) | | L2(dBμV) | | Q.P. | Ave. | Q.P. | Ave. | Q.P. | Ave. |
| | L1 | L2 | Q.P. | Ave. | Q.P. | Ave. | | | | | | |
| 0.150 | 0.10 | 0.20 | 45.10 | * | 44.70 | * | 45.20 | * | 44.90 | * | 66.00 | 56.00 |
| 0.498 | 0.10 | 0.20 | 39.30 | * | 38.90 | * | 39.40 | * | 39.10 | * | 56.03 | 46.03 |
| 0.597 | 0.10 | 0.20 | * | * | 35.10 | * | * | * | 35.30 | * | 56.00 | 46.00 |
| 0.696 | 0.10 | 0.20 | 35.80 | * | * | * | 35.90 | * | * | * | 56.00 | 46.00 |
| 1.494 | 0.10 | 0.20 | 34.50 | * | * | * | 34.60 | * | * | * | 56.00 | 46.00 |
| 1.593 | 0.10 | 0.20 | * | * | 33.70 | * | * | * | 33.90 | * | 56.00 | 46.00 |
| 2.289 | 0.13 | 0.20 | 30.50 | * | * | * | 30.63 | * | * | * | 56.00 | 46.00 |
| 2.589 | 0.16 | 0.20 | * | * | 34.60 | * | * | * | 34.80 | * | 56.00 | 46.00 |
| 6.045 | 0.30 | 0.30 | 34.90 | * | * | * | 35.20 | * | * | * | 60.00 | 50.00 |
| 6.288 | 0.30 | 0.30 | * | * | 36.60 | * | * | * | 36.90 | * | 60.00 | 50.00 |
| 8.271 | 0.40 | 0.33 | 42.30 | * | 41.30 | * | 42.70 | * | 41.63 | * | 60.00 | 50.00 |
| 19.692 | 0.90 | 0.97 | 30.30 | * | * | * | 31.20 | * | * | * | 60.00 | 50.00 |
| 19.971 | 0.90 | 1.00 | * | * | 30.60 | * | * | * | 31.60 | * | 60.00 | 50.00 |
| 30.000 | 1.40 | 1.80 | * | * | * | * | * | * | * | * | 60.00 | 50.00 |

- REMARKS :
- * Undetectable or the Q.P.values is lower than the limits of Ave.
 - The EUT can be operated in TX and RX mode. After a preliminary test, the EUT in TX mode will have highest level of AC line conducted emission. The test results for EUT in TX mode are recorded in final test report as representative.
 - For 802.11b mode.



Ecom Sertech Corp.

Rm. 258, Bldg. 17, NO.195, Sec. 4 Chung Hsing Rd., ChuTung Chen, Hsinchu, Taiwan 310, R.O.C
 TEL:886-3-5918012 FAX : 886-3-5825720

FCC ID : JCK-GN-WPKG
 Report No. : ER04-04-003FRF
 Page 13 of 64

The frequency spectrum from 0.15 MHz to 30 MHz was investigated. All emissions not reported below are more than 30 dB below the prescribed limits.

Temperature : 26 °C

Humidity : 65 % RH

| Frequency (MHz) | Loss(dB) | | Measurement | | | | L1 Emission (dBμV) | | L2 Emission (dBμV) | | Limits (dBμV) | |
|-----------------|----------|------|-------------|------|----------|------|--------------------|------|--------------------|------|---------------|-------|
| | | | L1(dBμV) | | L2(dBμV) | | Q.P. | Ave. | Q.P. | Ave. | Q.P. | Ave. |
| | L1 | L2 | Q.P. | Ave. | Q.P. | Ave. | | | | | | |
| 0.150 | 0.10 | 0.20 | 45.60 | * | 44.70 | * | 45.70 | * | 44.90 | * | 66.00 | 56.00 |
| 0.498 | 0.10 | 0.20 | 39.30 | * | 38.90 | * | 39.40 | * | 39.10 | * | 56.03 | 46.03 |
| 0.597 | 0.10 | 0.20 | * | * | 35.10 | * | * | * | 35.30 | * | 56.00 | 46.00 |
| 0.696 | 0.10 | 0.20 | 35.80 | * | * | * | 35.90 | * | * | * | 56.00 | 46.00 |
| 1.593 | 0.10 | 0.20 | 34.70 | * | * | * | 34.80 | * | * | * | 56.00 | 46.00 |
| 1.695 | 0.10 | 0.20 | * | * | 32.80 | * | * | * | 33.00 | * | 56.00 | 46.00 |
| 2.289 | 0.13 | 0.20 | 31.10 | * | * | * | 31.23 | * | * | * | 56.00 | 46.00 |
| 2.589 | 0.16 | 0.20 | * | * | 34.50 | * | * | * | 34.70 | * | 56.00 | 46.00 |
| 6.285 | 0.30 | 0.30 | * | * | 35.70 | * | * | * | 36.00 | * | 60.00 | 46.00 |
| 6.288 | 0.30 | 0.30 | 35.20 | * | * | * | 35.50 | * | * | * | 60.00 | 50.00 |
| 8.223 | 0.40 | 0.32 | 42.00 | * | * | * | 42.40 | * | * | * | 60.00 | 50.00 |
| 8.271 | 0.40 | 0.33 | * | * | 41.40 | * | * | * | 41.73 | * | 60.00 | 50.00 |
| 19.779 | 0.90 | 0.98 | 31.30 | * | * | * | 32.20 | * | * | * | 60.00 | 50.00 |
| 19.893 | 0.90 | 0.99 | * | * | 30.70 | * | * | * | 31.69 | * | 60.00 | 50.00 |
| 30.000 | 1.40 | 1.80 | * | * | * | * | * | * | * | * | 60.00 | 50.00 |

- REMARKS :
- * Undetectable or the Q.P.values is lower than the limits of Ave.
 - The EUT can be operated in TX and RX mode. After a preliminary test, the EUT in TX mode will have highest level of AC line conducted emission. The test results for EUT in TX mode are recorded in final test report as representative.
 - For 802.11g mode.

2.7 Photos of Conduction Test



3. RADIATED EMISSION TEST

3.1 Test Equipments

The following test equipments are utilized in making the measurements contained in this report.

| Manufacturer or Type | Model No | Serial No | Date of Calibration | Calibration Period | Remark |
|-----------------------|-------------|------------|---------------------|--------------------|--------|
| CHASE BI-LOG ANTENNA | CBL6112B | 2421 | MAY. 07, 2003 | 1 Year | FINAL |
| R/S SPECTRUM ANALYZER | FSEK30 | 835253/002 | JUN. 17, 2003 | 1 Year | FINAL |
| OPEN SITE | ----- | No.2 | MAY. 09, 2003 | 1 Year | FINAL |
| N TYPE COAXIAL CABLE | CHA9525 | 4 | JUL. 13, 2003 | 1 Year | FINAL |
| Horn Antenna | AH-118 | 10089 | FEB. 25, 2004 | 1 Year | FINAL |
| HP Pre-amplifier | 8449B | 3008A01471 | OCT. 11, 2003 | 1 Year | FINAL |
| HP High pass filter | 84300/80038 | 011 | CAL. ON USE | 1 Year | FINAL |
| Horn Antenna | AH-840 | 03077 | FEB. 25, 2004 | 1 Year | FINAL |

3.2 Test Setup

The diagram below shows the test setup that is utilized to make the measurements for emission from 30 to 1GHz.

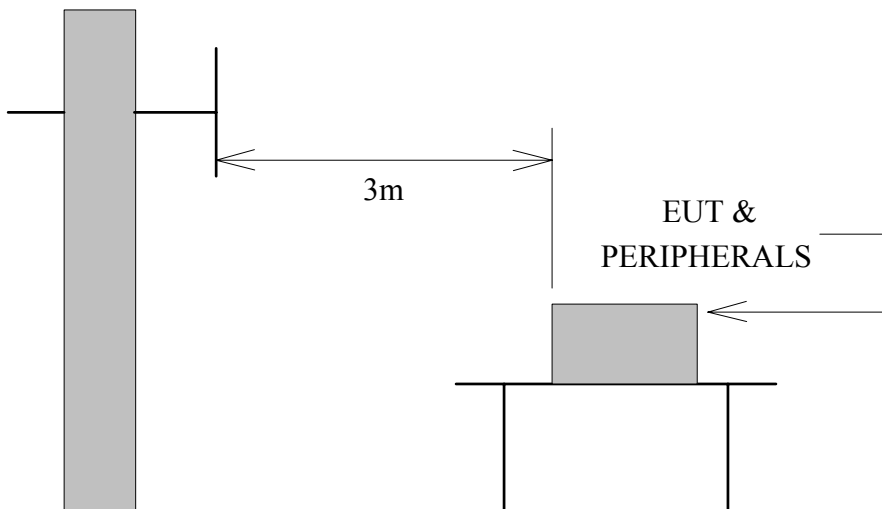

Antenna Elevation Variable

The diagram below shows the test setup that is utilized to make the measurements for emission above 1GHz.

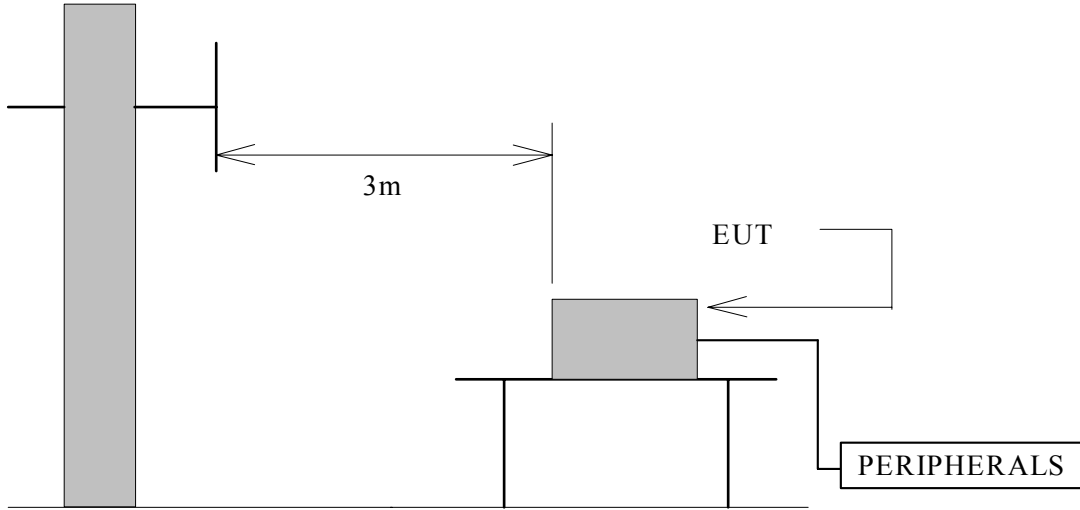

Antenna Elevation Variable

3.3 Radiation Limit

For unintentional device, according to § 15.109(a), except for Class A digital devices, the field strength of radiated emissions from unintentional radiators at a distance of 3 meters shall not exceed the following values :

| Frequency (MHz) | Distance (Meters) | Radiated (dB μ V/M) | Radiated (μ V/M) |
|-----------------|-------------------|-------------------------|-----------------------|
| 30-88 | 3 | 40.0 | 100 |
| 88-216 | 3 | 43.5 | 150 |
| 216-960 | 3 | 46.0 | 200 |
| Above 960 | 3 | 54.0 | 500 |

For intentional device, according to § 15.209(a), the general requirement of field strength of radiated emissions from intentional radiators at a distance of 3 meters shall not exceed the above table.



3.4 Test Procedures

- a. The EUT was placed on the top of a rotating table 0.8 meters above the ground at a 10 meter open area test site. The table was rotated 360 degrees to determine the position of the highest radiation.
- b. During performing radiated emission below 1GHz, the EUT was set 3 meters away from the interference-receiving antenna, which was mounted on the top of a variable-height antenna tower. During performing radiated emission above 1GHz, the EUT was set 1 meters away from the interference-receiving antenna
- c. The antenna is a broadband antenna, and its height is varied from one meter to four meters above the ground to determine the maximum value of the field strength. Both horizontal and vertical polarization of the antenna are set to make the measurement.
- d. For each suspected emission, the EUT was arranged to its worst case and then the antenna was tuned to heights from 1 meter to 4 meters and the table was turned from 0 degrees to 360 degrees to find the maximum reading.
- e. The test-receiver system was set to Peak Detect Function and Specified Bandwidth with Maximum Hold Mode.
- f. If the emission level of the EUT in peak mode was 10 dB lower than the limit specified, then testing could be stopped and the peak values of the EUT would be reported. Otherwise the emissions that did not have 10 dB margin would be re-tested one by one using peak, quasi-peak or average method as specified and then reported in a data sheet.

NOTE :

1. The resolution bandwidth and video bandwidth of test receiver/spectrum analyzer is 120 KHz for Peak detection (PK) and Quasi-peak detection (QP) at frequency below 1GHz.
2. The resolution bandwidth and video bandwidth of test receiver/spectrum analyzer is 1 MHz for Peak detection and frequency above 1GHz.
3. The resolution bandwidth of test receiver/spectrum analyzer is 1 MHz and the video bandwidth is 10 Hz for Average detection (AV) at frequency above 1GHz.

3.5 Uncertainty of Radiated Emission

The uncertainty of radiated emission is ± 2.72 dB.



3.6 Radiated RF Noise Measurement

Test Requirement: 15.109, 15.209

The frequency spectrum from 30 MHz to 1000 MHz was investigated. All emissions not reported below are more than 20 dB below the prescribed limits.

All readings are quasi-peak values.

Temperature : 17 °C

Humidity : 75 % RH

| Frequency (MHz) | Antenna Factor (dB) | Cable Loss (dB) | Meter Reading at 3m(dBμV/M) | | Limits at 3m (dBμV/M) | Emission Level at 3m(dBμV/M) | |
|-----------------|---------------------|-----------------|-----------------------------|----------|-----------------------|------------------------------|----------|
| | | | Horizontal | Vertical | | Horizontal | Vertical |
| 30.00 | 21.39 | 0.90 | * | * | 40.00 | * | * |
| 160.00 | 11.26 | 2.50 | 9.00 | 8.80 | 43.50 | 22.76 | 22.56 |
| 199.99 | 10.39 | 2.80 | 8.60 | 11.60 | 43.50 | 21.79 | 24.79 |
| 239.99 | 12.55 | 3.12 | 14.50 | 8.50 | 46.00 | 30.17 | 24.17 |
| 279.99 | 13.34 | 3.44 | 19.30 | 10.60 | 46.00 | 36.08 | 27.38 |
| 359.99 | 15.74 | 3.96 | 9.90 | 8.50 | 46.00 | 29.60 | 28.20 |
| 399.99 | 17.24 | 4.20 | 8.60 | 6.60 | 46.00 | 30.04 | 28.04 |
| 479.98 | 18.10 | 4.76 | 6.40 | 8.40 | 46.00 | 29.26 | 31.26 |
| 1000.00 | 21.58 | 7.00 | * | * | 54.00 | * | * |

- REMARKS :
- *Undetectable
 - Emission level (dBμV/M) =Antenna Factor (dB/M) + Cable loss (dB) + Meter Reading (dBμV/M).
 - The RF-Chip combined with 802.11b&g mode. It will auto-detect the radio environment and switch to the proper mode while enabling the WLAN function.
 - According to technical experience, all spurious emission at channel 1, 6 and 11 are almost the same below 1GHz, so the spurious emission test result of the channel 1 was chosen as representative in final test.



Ecom Sertech Corp.

Rm. 258, Bldg. 17, NO.195, Sec. 4 Chung Hsing Rd., ChuTung Chen, Hsinchu, Taiwan 310, R.O.C
 TEL:886-3-5918012 FAX : 886-3-5825720

FCC ID : JCK-GN-WPKG
 Report No. : ER04-04-003FRF
 Page 19 of 64

Test Requirement: 15.109 ,15.209

The frequency spectrum above 1 GHz was investigated. All emissions not reported below are more than 40 dB below the prescribed limits. Readings are both peak and average values.

| | | | |
|--------------|--------------------------------|-----------------|------------|
| Company | GIGA-BYTE TECHNOLOGY CO., LTD. | Test Date : | 2004/4/05 |
| Product Name | PCI Wireless LAN Card | Test By: | Stan Peng |
| Model Name | GN-WPKG | TEMP&Humidity : | 29°C , 37% |

| CH1 RX | | | | Measurement Distance at 1m | | | | Horizontal polarity | | | |
|---------|---------|--------|-------|----------------------------|------|--------|----------|---------------------|--------|---------|---------|
| Freq. | Reading | AF | Cable | Pre-amp | Dist | Filter | Level | Limit | Margin | Mark | Height |
| (MHz) | (dBuV) | (dBuV) | (dB) | (dB) | dB | dB | (dBuV/m) | (dBuV/m) | (dB) | (P/Q/A) | (Meter) |
| 4075.99 | 47.22 | 32.55 | 4.84 | 34.90 | 9.50 | 0.00 | 40.22 | 74 | -33.78 | P | 1.0 |
| 4075.99 | 38.45 | 32.55 | 4.84 | 34.90 | 9.50 | 0.00 | 31.45 | 54 | -22.55 | A | 1.0 |
| 6113.99 | 44.18 | 37.33 | 6.42 | 34.30 | 9.50 | 0.00 | 44.13 | 74 | -29.87 | P | 1.0 |
| 6113.99 | 33.78 | 37.33 | 6.42 | 34.30 | 9.50 | 0.00 | 33.73 | 54 | -20.27 | A | 1.0 |
| 8152.09 | 44.98 | 39.45 | 7.37 | 35.94 | 9.50 | 0.00 | 46.36 | 74 | -27.64 | P | 1.0 |
| 8152.09 | 33.43 | 39.45 | 7.37 | 35.94 | 9.50 | 0.00 | 34.81 | 54 | -19.19 | A | 1.0 |

1. AF: Antenna Factor, Cable: Cable Loss, Pre-Amp: Preamplifier gain, Filter: High Pass Filter Insertion Loss (3.5GHz)
2. Analyzer setting P(Peak): RBW=1MHz, VBW=1MHz, A(Average): RBW=1MHz,VBW=10Hz
3. Dist : correction to extra plate reading to 3m specification distance 1m measurement distance = -9.5dB
4. The result basic equation calculation as follow :

$$\text{Level} = \text{Reading} + \text{AF} + \text{Cable} - \text{Preamp} + \text{Filter} - \text{Dist}, \text{Margin} = \text{Level} - \text{Limit}$$
5. The test limit is 3M limit.
6. The frequency was searched to 18GHz.
7. The other emission levels were very low against the limit.
8. For 802.11b mode at 11Mbps.



Ecom Sertech Corp.

Rm. 258, Bldg. 17, NO.195, Sec. 4 Chung Hsing Rd., ChuTung Chen, Hsinchu, Taiwan 310, R.O.C
 TEL:886-3-5918012 FAX: 886-3-5825720

FCC ID : JCK-GN-WPKG
 Report No. : ER04-04-003FRF
 Page 20 of 64

Test Requirement: 15.109 ,15.209

The frequency spectrum above 1 GHz was investigated. All emissions not reported below are more than 40 dB below the prescribed limits. Readings are both peak and average values.

| | | | |
|--------------|--------------------------------|-----------------|------------|
| Company | GIGA-BYTE TECHNOLOGY CO., LTD. | Test Date : | 2004/4/05 |
| Product Name | PCI Wireless LAN Card | Test By: | Stan Peng |
| Model Name | GN-WPKG | TEMP&Humidity : | 29°C , 37% |

| CH1 RX | | | | Measurement Distance at 1m | | | | | Vertical polarity | | |
|-------------|----------------|-----------|------------|----------------------------|-----------|-------------|----------------|----------------|-------------------|--------------|----------------|
| Freq. (MHz) | Reading (dBuV) | AF (dBuV) | Cable (dB) | Pre-amp (dB) | Dist (dB) | Filter (dB) | Level (dBuV/m) | Limit (dBuV/m) | Margin (dB) | Mark (P/Q/A) | Height (Meter) |
| 4076.23 | 47.31 | 32.55 | 4.84 | 34.90 | 9.50 | 0.00 | 40.31 | 74 | -33.69 | P | 1.0 |
| 4076.23 | 38.56 | 32.55 | 4.84 | 34.90 | 9.50 | 0.00 | 31.56 | 54 | -22.44 | A | 1.0 |
| 6113.56 | 43.88 | 37.33 | 6.42 | 34.30 | 9.50 | 0.00 | 43.83 | 74 | -30.17 | P | 1.0 |
| 6113.56 | 32.17 | 37.33 | 6.42 | 34.30 | 9.50 | 0.00 | 32.12 | 54 | -21.88 | A | 1.0 |
| 8152.51 | 45.31 | 39.45 | 7.37 | 35.94 | 9.50 | 0.00 | 46.69 | 74 | -27.31 | P | 1.0 |
| 8152.51 | 33.39 | 39.45 | 7.37 | 35.94 | 9.50 | 0.00 | 34.77 | 54 | -19.23 | A | 1.0 |

1. AF: Antenna Factor, Cable: Cable Loss, Pre-Amp: Preamplifier gain, Filter: High Pass Filter Insertion Loss (3.5GHz)
2. Analyzer setting P(Peak): RBW=1MHz, VBW=1MHz, A(Average): RBW=1MHz,VBW=10Hz
3. Dist : correction to extra plate reading to 3m specification distance 1m measurement distance = -9.5dB
4. The result basic equation calculation as follow :

$$\text{Level} = \text{Reading} + \text{AF} + \text{Cable} - \text{Preamp} + \text{Filter} - \text{Dist}, \text{Margin} = \text{Level} - \text{Limit}$$
5. The test limit is 3M limit.
6. The frequency was searched to 18GHz.
7. The other emission levels were very low against the limit.
8. For 802.11b mode at 11Mbps.



Ecom Sertech Corp.

Rm. 258, Bldg. 17, NO.195, Sec. 4 Chung Hsing Rd., ChuTung Chen, Hsinchu, Taiwan 310, R.O.C
 TEL:886-3-5918012 FAX: 886-3-5825720

FCC ID : JCK-GN-WPKG
 Report No. : ER04-04-003FRF
 Page 21 of 64

Test Requirement: 15.109 ,15.209

The frequency spectrum above 1 GHz was investigated. All emissions not reported below are more than 40 dB below the prescribed limits. Readings are both peak and average values.

| | | | |
|--------------|--------------------------------|-----------------|------------|
| Company | GIGA-BYTE TECHNOLOGY CO., LTD. | Test Date : | 2004/4/05 |
| Product Name | PCI Wireless LAN Card | Test By: | Stan Peng |
| Model Name | GN-WPKG | TEMP&Humidity : | 29°C , 37% |

| CH6 RX | | | | Measurement Distance at 1m | | | | | Horizontal polarity | | |
|---------|---------|--------|-------|----------------------------|------|--------|----------|----------|---------------------|---------|---------|
| Freq. | Reading | AF | Cable | Pre-amp | Dist | Filter | Level | Limit | Margin | Mark | Height |
| (MHz) | (dBuV) | (dBuV) | (dB) | (dB) | dB | dB | (dBuV/m) | (dBuV/m) | (dB) | (P/Q/A) | (Meter) |
| 4126.05 | 46.28 | 32.52 | 4.86 | 34.90 | 9.50 | 0.00 | 39.26 | 74 | -34.74 | P | 1.0 |
| 4126.05 | 37.84 | 32.52 | 4.86 | 34.90 | 9.50 | 0.00 | 30.82 | 54 | -23.18 | A | 1.0 |
| 6189.01 | 44.00 | 37.48 | 6.43 | 34.30 | 9.50 | 0.00 | 44.11 | 74 | -29.89 | P | 1.0 |
| 6189.01 | 32.46 | 37.48 | 6.43 | 34.30 | 9.50 | 0.00 | 32.57 | 54 | -21.43 | A | 1.0 |
| 8251.77 | 45.82 | 39.35 | 7.45 | 35.19 | 9.50 | 0.00 | 47.93 | 74 | -26.07 | P | 1.0 |
| 8251.77 | 33.73 | 39.35 | 7.45 | 35.19 | 9.50 | 0.00 | 35.84 | 54 | -18.16 | A | 1.0 |

1. AF: Antenna Factor, Cable: Cable Loss, Pre-Amp: Preamplifier gain, Filter: High Pass Filter Insertion Loss (3.5GHz)
2. Analyzer setting P(Peak): RBW=1MHz, VBW=1MHz, A(Average): RBW=1MHz,VBW=10Hz
3. Dist : correction to extra plate reading to 3m specification distance 1m measurement distance = -9.5dB
4. The result basic equation calculation as follow :

$$\text{Level} = \text{Reading} + \text{AF} + \text{Cable} - \text{Preamp} + \text{Filter} - \text{Dist}, \text{Margin} = \text{Level} - \text{Limit}$$
5. The test limit is 3M limit.
6. The frequency was searched to 18GHz.
7. The other emission levels were very low against the limit.
8. For 802.11b mode at 11Mbps.



Ecom Sertech Corp.

Rm. 258, Bldg. 17, NO.195, Sec. 4 Chung Hsing Rd., ChuTung Chen, Hsinchu, Taiwan 310, R.O.C
 TEL:886-3-5918012 FAX: 886-3-5825720

FCC ID : JCK-GN-WPKG
 Report No. : ER04-04-003FRF
 Page 22 of 64

Test Requirement: 15.109 ,15.209

The frequency spectrum above 1 GHz was investigated. All emissions not reported below are more than 40 dB below the prescribed limits. Readings are both peak and average values.

| | | | |
|--------------|--------------------------------|-----------------|------------|
| Company | GIGA-BYTE TECHNOLOGY CO., LTD. | Test Date : | 2004/4/05 |
| Product Name | PCI Wireless LAN Card | Test By: | Stan Peng |
| Model Name | GN-WPKG | TEMP&Humidity : | 29°C , 37% |

| CH6 RX | | | | Measurement Distance at 1m | | | | | Vertical polarity | | |
|-------------|----------------|-----------|------------|----------------------------|-----------|-------------|----------------|----------------|-------------------|--------------|----------------|
| Freq. (MHz) | Reading (dBuV) | AF (dBuV) | Cable (dB) | Pre-amp (dB) | Dist (dB) | Filter (dB) | Level (dBuV/m) | Limit (dBuV/m) | Margin (dB) | Mark (P/Q/A) | Height (Meter) |
| 4126.26 | 47.62 | 32.52 | 4.86 | 34.90 | 9.50 | 0.00 | 40.60 | 74 | -33.40 | P | 1.0 |
| 4126.26 | 38.01 | 32.52 | 4.86 | 34.90 | 9.50 | 0.00 | 30.99 | 54 | -23.01 | A | 1.0 |
| 6189.11 | 44.05 | 37.48 | 6.43 | 34.30 | 9.50 | 0.00 | 44.16 | 74 | -29.84 | P | 1.0 |
| 6189.11 | 32.37 | 37.48 | 6.43 | 34.30 | 9.50 | 0.00 | 32.48 | 54 | -21.52 | A | 1.0 |
| 8252.46 | 45.26 | 39.35 | 7.45 | 35.18 | 9.50 | 0.00 | 47.38 | 74 | -26.62 | P | 1.0 |
| 8252.46 | 33.54 | 39.35 | 7.45 | 35.18 | 9.50 | 0.00 | 35.66 | 54 | -18.34 | A | 1.0 |

1. AF: Antenna Factor, Cable: Cable Loss, Pre-Amp: Preamplifier gain, Filter: High Pass Filter Insertion Loss (3.5GHz)
2. Analyzer setting P(Peak): RBW=1MHz, VBW=1MHz, A(Average): RBW=1MHz,VBW=10Hz
3. Dist : correction to extra plate reading to 3m specification distance 1m measurement distance = -9.5dB
4. The result basic equation calculation as follow :

$$\text{Level} = \text{Reading} + \text{AF} + \text{Cable} - \text{Preamp} + \text{Filter} - \text{Dist}, \text{Margin} = \text{Level} - \text{Limit}$$
5. The test limit is 3M limit.
6. The frequency was searched to 18GHz.
7. The other emission levels were very low against the limit.
8. For 802.11b mode at 11Mbps.



Ecom Sertech Corp.

Rm. 258, Bldg. 17, NO.195, Sec. 4 Chung Hsing Rd., ChuTung Chen, Hsinchu, Taiwan 310, R.O.C
 TEL:886-3-5918012 FAX: 886-3-5825720

FCC ID : JCK-GN-WPKG
 Report No. : ER04-04-003FRF
 Page 23 of 64

Test Requirement: 15.109 ,15.209

The frequency spectrum above 1 GHz was investigated. All emissions not reported below are more than 40 dB below the prescribed limits. Readings are both peak and average values.

| | | | |
|--------------|--------------------------------|-----------------|------------|
| Company | GIGA-BYTE TECHNOLOGY CO., LTD. | Test Date : | 2004/4/05 |
| Product Name | PCI Wireless LAN Card | Test By: | Stan Peng |
| Model Name | GN-WPKG | TEMP&Humidity : | 29°C , 37% |

| CH11 RX | | | | Measurement Distance at 1m | | | | | Horizontal polarity | | |
|---------|---------|--------|-------|----------------------------|------|--------|----------|----------|---------------------|---------|---------|
| Freq. | Reading | AF | Cable | Pre-amp | Dist | Filter | Level | Limit | Margin | Mark | Height |
| (MHz) | (dBuV) | (dBuV) | (dB) | (dB) | dB | dB | (dBuV/m) | (dBuV/m) | (dB) | (P/Q/A) | (Meter) |
| 4176.22 | 45.70 | 32.49 | 4.88 | 34.90 | 9.50 | 0.00 | 38.67 | 74 | -35.33 | P | 1.0 |
| 4176.22 | 36.54 | 32.49 | 4.88 | 34.90 | 9.50 | 0.00 | 29.51 | 54 | -24.49 | A | 1.0 |
| 6264.37 | 45.04 | 37.63 | 6.45 | 34.30 | 9.50 | 0.00 | 45.32 | 74 | -28.68 | P | 1.0 |
| 6264.37 | 32.41 | 37.63 | 6.45 | 34.30 | 9.50 | 0.00 | 32.69 | 54 | -21.31 | A | 1.0 |
| 8351.87 | 44.66 | 39.25 | 7.53 | 34.43 | 9.50 | 0.00 | 47.51 | 74 | -26.49 | P | 1.0 |
| 8351.87 | 33.96 | 39.25 | 7.53 | 34.43 | 9.50 | 0.00 | 36.81 | 54 | -17.19 | A | 1.0 |

1. AF: Antenna Factor, Cable: Cable Loss, Pre-Amp: Preamplifier gain, Filter: High Pass Filter Insertion Loss (3.5GHz)
2. Analyzer setting P(Peak): RBW=1MHz, VBW=1MHz, A(Average): RBW=1MHz,VBW=10Hz
3. Dist : correction to extra plate reading to 3m specification distance 1m measurement distance = -9.5dB
4. The result basic equation calculation as follow :

$$\text{Level} = \text{Reading} + \text{AF} + \text{Cable} - \text{Preamp} + \text{Filter} - \text{Dist}, \text{Margin} = \text{Level} - \text{Limit}$$
5. The test limit is 3M limit.
6. The frequency was searched to 18GHz.
7. The other emission levels were very low against the limit.
8. For 802.11b mode at 11Mbps.



Ecom Sertech Corp.

Rm. 258, Bldg. 17, NO.195, Sec. 4 Chung Hsing Rd., ChuTung Chen, Hsinchu, Taiwan 310, R.O.C
 TEL:886-3-5918012 FAX: 886-3-5825720

FCC ID : JCK-GN-WPKG
 Report No. : ER04-04-003FRF
 Page 24 of 64

Test Requirement: 15.109 ,15.209

The frequency spectrum above 1 GHz was investigated. All emissions not reported below are more than 40 dB below the prescribed limits. Readings are both peak and average values.

| | | | |
|--------------|--------------------------------|-----------------|------------|
| Company | GIGA-BYTE TECHNOLOGY CO., LTD. | Test Date : | 2004/4/05 |
| Product Name | PCI Wireless LAN Card | Test By: | Stan Peng |
| Model Name | GN-WPKG | TEMP&Humidity : | 29°C , 37% |

| CH11 RX | | | | Measurement Distance at 1m | | | | | Vertical polarity | | |
|---------|---------|--------|-------|----------------------------|------|--------|----------|----------|-------------------|---------|---------|
| Freq. | Reading | AF | Cable | Pre-amp | Dist | Filter | Level | Limit | Margin | Mark | Height |
| (MHz) | (dBuV) | (dBuV) | (dB) | (dB) | dB | dB | (dBuV/m) | (dBuV/m) | (dB) | (P/Q/A) | (Meter) |
| 4175.97 | 46.71 | 32.49 | 4.88 | 34.90 | 9.50 | 0.00 | 39.68 | 74 | -34.32 | P | 1.0 |
| 4175.97 | 38.55 | 32.49 | 4.88 | 34.90 | 9.50 | 0.00 | 31.52 | 54 | -22.48 | A | 1.0 |
| 6264.16 | 44.84 | 37.63 | 6.45 | 34.30 | 9.50 | 0.00 | 45.12 | 74 | -28.88 | P | 1.0 |
| 6264.16 | 32.49 | 37.63 | 6.45 | 34.30 | 9.50 | 0.00 | 32.77 | 54 | -21.23 | A | 1.0 |
| 8352.13 | 45.69 | 39.25 | 7.53 | 34.42 | 9.50 | 0.00 | 48.55 | 74 | -25.45 | P | 1.0 |
| 8352.13 | 33.92 | 39.25 | 7.53 | 34.42 | 9.50 | 0.00 | 36.78 | 54 | -17.22 | A | 1.0 |

1. AF: Antenna Factor, Cable: Cable Loss, Pre-Amp: Preamplifier gain, Filter: High Pass Filter Insertion Loss (3.5GHz)
2. Analyzer setting P(Peak): RBW=1MHz, VBW=1MHz, A(Average): RBW=1MHz,VBW=10Hz
3. Dist : correction to extra plate reading to 3m specification distance 1m measurement distance = -9.5dB
4. The result basic equation calculation as follow :

$$\text{Level} = \text{Reading} + \text{AF} + \text{Cable} - \text{Preamp} + \text{Filter} - \text{Dist}, \text{Margin} = \text{Level} - \text{Limit}$$
5. The test limit is 3M limit.
6. The frequency was searched to 18GHz.
7. The other emission levels were very low against the limit.
8. For 802.11b mode at 11Mbps.



Ecom Sertech Corp.

Rm. 258, Bldg. 17, NO.195, Sec. 4 Chung Hsing Rd., ChuTung Chen, Hsinchu, Taiwan 310, R.O.C
 TEL:886-3-5918012 FAX : 886-3-5825720

FCC ID : JCK-GN-WPKG
 Report No. : ER04-04-003FRF
 Page 25 of 64

Test Requirement: 15.109 ,15.209

The frequency spectrum above 1 GHz was investigated. All emissions not reported below are more than 40 dB below the prescribed limits. Readings are both peak and average values.

| | | | |
|--------------|--------------------------------|-----------------|------------|
| Company | GIGA-BYTE TECHNOLOGY CO., LTD. | Test Date : | 2004/4/05 |
| Product Name | PCI Wireless LAN Card | Test By: | Stan Peng |
| Model Name | GN-WPKG | TEMP&Humidity : | 29°C , 37% |

| CH1 RX | | | | Measurement Distance at 1m | | | | Horizontal polarity | | | |
|---------|---------|--------|-------|----------------------------|------|--------|----------|---------------------|--------|---------|---------|
| Freq. | Reading | AF | Cable | Pre-amp | Dist | Filter | Level | Limit | Margin | Mark | Height |
| (MHz) | (dBuV) | (dBuV) | (dB) | (dB) | dB | dB | (dBuV/m) | (dBuV/m) | (dB) | (P/Q/A) | (Meter) |
| 4075.89 | 46.94 | 32.55 | 4.84 | 34.90 | 9.50 | 0.00 | 39.94 | 74 | -34.06 | P | 1.0 |
| 4075.89 | 38.21 | 32.55 | 4.84 | 34.90 | 9.50 | 0.00 | 31.21 | 54 | -22.79 | A | 1.0 |
| 6113.96 | 43.58 | 37.33 | 6.42 | 34.30 | 9.50 | 0.00 | 43.53 | 74 | -30.47 | P | 1.0 |
| 6113.96 | 32.96 | 37.33 | 6.42 | 34.30 | 9.50 | 0.00 | 32.91 | 54 | -21.09 | A | 1.0 |
| 8151.63 | 45.99 | 39.45 | 7.37 | 35.95 | 9.50 | 0.00 | 47.36 | 74 | -26.64 | P | 1.0 |
| 8151.63 | 33.77 | 39.45 | 7.37 | 35.95 | 9.50 | 0.00 | 35.14 | 54 | -18.86 | A | 1.0 |

1. AF: Antenna Factor, Cable: Cable Loss, Pre-Amp: Preamplifier gain, Filter: High Pass Filter Insertion Loss (3.5GHz)
2. Analyzer setting P(Peak): RBW=1MHz, VBW=1MHz, A(Average): RBW=1MHz,VBW=10Hz
3. Dist : correction to extra plate reading to 3m specification distance 1m measurement distance = -9.5dB
4. The result basic equation calculation as follow :

$$\text{Level} = \text{Reading} + \text{AF} + \text{Cable} - \text{Preamp} + \text{Filter} - \text{Dist}, \text{Margin} = \text{Level} - \text{Limit}$$
5. The test limit is 3M limit.
6. The frequency was searched to 18GHz.
7. The other emission levels were very low against the limit.
8. For 802.11g mode at 54Mbps.



Ecom Sertech Corp.

Rm. 258, Bldg. 17, NO.195, Sec. 4 Chung Hsing Rd.,ChuTung Chen, Hsinchu, Taiwan 310, R.O.C
TEL:886-3-5918012 FAX : 886-3-5825720

FCC ID : JCK-GN-WPKG
Report No. : ER04-04-003FRF
Page 26 of 64

Test Requirement: 15.109 ,15.209

The frequency spectrum above 1 GHz was investigated. All emissions not reported below are more than 40 dB below the prescribed limits. Readings are both peak and average values.

| | | | |
|--------------|--------------------------------|-----------------|------------|
| Company | GIGA-BYTE TECHNOLOGY CO., LTD. | Test Date : | 2004/4/05 |
| Product Name | PCI Wireless LAN Card | Test By: | Stan Peng |
| Model Name | GN-WPKG | TEMP&Humidity : | 29°C , 37% |

| CH1 RX | | | | Measurement Distance at 1m | | | | | Vertical polarity | | | |
|-------------|----------------|-----------|------------|----------------------------|-----------|-------------|----------------|----------------|-------------------|--------------|----------------|--|
| Freq. (MHz) | Reading (dBuV) | AF (dBuV) | Cable (dB) | Pre-amp (dB) | Dist (dB) | Filter (dB) | Level (dBuV/m) | Limit (dBuV/m) | Margin (dB) | Mark (P/Q/A) | Height (Meter) | |
| 4075.88 | 47.47 | 32.55 | 4.84 | 34.90 | 9.50 | 0.00 | 40.47 | 74 | -33.53 | P | 1.0 | |
| 4075.88 | 39.07 | 32.55 | 4.84 | 34.90 | 9.50 | 0.00 | 32.07 | 54 | -21.93 | A | 1.0 | |
| 6114.69 | 43.61 | 37.33 | 6.42 | 34.30 | 9.50 | 0.00 | 43.56 | 74 | -30.44 | P | 1.0 | |
| 6114.69 | 32.58 | 37.33 | 6.42 | 34.30 | 9.50 | 0.00 | 32.53 | 54 | -21.47 | A | 1.0 | |
| 8150.87 | 45.99 | 39.45 | 7.37 | 35.95 | 9.50 | 0.00 | 47.36 | 74 | -26.64 | P | 1.0 | |
| 8150.87 | 33.41 | 39.45 | 7.37 | 35.95 | 9.50 | 0.00 | 34.78 | 54 | -19.22 | A | 1.0 | |

1. AF: Antenna Factor, Cable: Cable Loss, Pre-Amp: Preamplifier gain, Filter: High Pass Filter Insertion Loss (3.5GHz)
2. Analyzer setting P(Peak): RBW=1MHz, VBW=1MHz, A(Average): RBW=1MHz,VBW=10Hz
3. Dist : correction to extra plate reading to 3m specification distance 1m measurement distance = -9.5dB
4. The result basic equation calculation as follow :
Level = Reading + AF + Cable - Preamp + Filter - Dist, Margin = Level - Limit
5. The test limit is 3M limit.
6. The frequency was searched to 18GHz.
7. The other emission levels were very low against the limit.
8. For 802.11g mode at 54Mbps.



Ecom Sertech Corp.

Rm. 258, Bldg. 17, NO.195, Sec. 4 Chung Hsing Rd., ChuTung Chen, Hsinchu, Taiwan 310, R.O.C
TEL:886-3-5918012 FAX : 886-3-5825720

FCC ID : JCK-GN-WPKG
Report No. : ER04-04-003FRF
Page 27 of 64

Test Requirement: 15.109 ,15.209

The frequency spectrum above 1 GHz was investigated. All emissions not reported below are more than 40 dB below the prescribed limits. Readings are both peak and average values.

| | | | |
|--------------|--------------------------------|-----------------|--------------|
| Company | GIGA-BYTE TECHNOLOGY CO., LTD. | Test Date : | 2004/4/05 |
| Product Name | PCI Wireless LAN Card | Test By: | Stan Peng |
| Model Name | GN-WPKG | TEMP&Humidity : | 19.5°C , 75% |

| CH6 RX | | | | Measurement Distance at 1m | | | | Horizontal polarity | | | |
|---------|---------|--------|-------|----------------------------|------|--------|----------|---------------------|--------|---------|---------|
| Freq. | Reading | AF | Cable | Pre-amp | Dist | Filter | Level | Limit | Margin | Mark | Height |
| (MHz) | (dBuV) | (dBuV) | (dB) | (dB) | dB | dB | (dBuV/m) | (dBuV/m) | (dB) | (P/Q/A) | (Meter) |
| 4126.33 | 46.78 | 32.52 | 4.86 | 34.90 | 9.50 | 0.00 | 39.76 | 74 | -34.24 | P | 1.0 |
| 4126.33 | 37.45 | 32.52 | 4.86 | 34.90 | 9.50 | 0.00 | 30.43 | 54 | -23.57 | A | 1.0 |
| 6189.09 | 44.34 | 37.48 | 6.43 | 34.30 | 9.50 | 0.00 | 44.45 | 74 | -29.55 | P | 1.0 |
| 6189.09 | 32.92 | 37.48 | 6.43 | 34.30 | 9.50 | 0.00 | 33.03 | 54 | -20.97 | A | 1.0 |
| 8252.04 | 44.89 | 39.35 | 7.45 | 35.18 | 9.50 | 0.00 | 47.01 | 74 | -26.99 | P | 1.0 |
| 8252.04 | 33.98 | 39.35 | 7.45 | 35.18 | 9.50 | 0.00 | 36.10 | 54 | -17.90 | A | 1.0 |

1. AF: Antenna Factor, Cable: Cable Loss, Pre-Amp: Preamplifier gain, Filter: High Pass Filter Insertion Loss (3.5GHz)
2. Analyzer setting P(Peak): RBW=1MHz, VBW=1MHz, A(Average): RBW=1MHz,VBW=10Hz
3. Dist : correction to extra plate reading to 3m specification distance 1m measurement distance = -9.5dB
4. The result basic equation calculation as follow :
Level = Reading + AF + Cable - Preamp + Filter - Dist, Margin = Level - Limit
5. The test limit is 3M limit.
6. The frequency was searched to 18GHz.
7. The other emission levels were very low against the limit.
8. For 802.11g mode at 54Mbps.



Ecom Sertech Corp.

Rm. 258, Bldg. 17, NO.195, Sec. 4 Chung Hsing Rd., ChuTung Chen, Hsinchu, Taiwan 310, R.O.C
TEL:886-3-5918012 FAX : 886-3-5825720

FCC ID : JCK-GN-WPKG
Report No. : ER04-04-003FRF
Page 28 of 64

Test Requirement: 15.109 ,15.209

The frequency spectrum above 1 GHz was investigated. All emissions not reported below are more than 40 dB below the prescribed limits. Readings are both peak and average values.

| | | | |
|--------------|--------------------------------|-----------------|--------------|
| Company | GIGA-BYTE TECHNOLOGY CO., LTD. | Test Date : | 2004/4/05 |
| Product Name | PCI Wireless LAN Card | Test By: | Stan Peng |
| Model Name | GN-WPKG | TEMP&Humidity : | 19.5°C , 75% |

| CH6 RX | | | | Measurement Distance at 1m | | | | | Vertical polarity | | |
|---------|---------|--------|-------|----------------------------|------|--------|----------|----------|-------------------|---------|---------|
| Freq. | Reading | AF | Cable | Pre-amp | Dist | Filter | Level | Limit | Margin | Mark | Height |
| (MHz) | (dBuV) | (dBuV) | (dB) | (dB) | dB | dB | (dBuV/m) | (dBuV/m) | (dB) | (P/Q/A) | (Meter) |
| 4126.17 | 47.51 | 32.52 | 4.86 | 34.90 | 9.50 | 0.00 | 40.49 | 74 | -33.51 | P | 1.0 |
| 4126.17 | 38.19 | 32.52 | 4.86 | 34.90 | 9.50 | 0.00 | 31.17 | 54 | -22.83 | A | 1.0 |
| 6189.05 | 44.52 | 37.48 | 6.43 | 34.30 | 9.50 | 0.00 | 44.63 | 74 | -29.37 | P | 1.0 |
| 6189.05 | 32.68 | 37.48 | 6.43 | 34.30 | 9.50 | 0.00 | 32.79 | 54 | -21.21 | A | 1.0 |
| 8251.12 | 45.46 | 39.35 | 7.45 | 35.19 | 9.50 | 0.00 | 47.57 | 74 | -26.43 | P | 1.0 |
| 8251.12 | 33.61 | 39.35 | 7.45 | 35.19 | 9.50 | 0.00 | 35.72 | 54 | -18.28 | A | 1.0 |

1. AF: Antenna Factor, Cable: Cable Loss, Pre-Amp: Preamplifier gain, Filter: High Pass Filter Insertion Loss (3.5GHz)
2. Analyzer setting P(Peak): RBW=1MHz, VBW=1MHz, A(Average): RBW=1MHz,VBW=10Hz
3. Dist : correction to extra plate reading to 3m specification distance 1m measurement distance = -9.5dB
4. The result basic equation calculation as follow :
Level = Reading + AF + Cable - Preamp + Filter - Dist, Margin = Level - Limit
5. The test limit is 3M limit.
6. The frequency was searched to 18GHz.
7. The other emission levels were very low against the limit.
8. For 802.11g mode at 54Mbps.



Ecom Sertech Corp.

Rm. 258, Bldg. 17, NO.195, Sec. 4 Chung Hsing Rd., ChuTung Chen, Hsinchu, Taiwan 310, R.O.C
TEL:886-3-5918012 FAX : 886-3-5825720

FCC ID : JCK-GN-WPKG
Report No. : ER04-04-003FRF
Page 29 of 64

Test Requirement: 15.109 ,15.209

The frequency spectrum above 1 GHz was investigated. All emissions not reported below are more than 40 dB below the prescribed limits. Readings are both peak and average values.

| | | | |
|--------------|--------------------------------|-----------------|--------------|
| Company | GIGA-BYTE TECHNOLOGY CO., LTD. | Test Date : | 2004/4/05 |
| Product Name | PCI Wireless LAN Card | Test By: | Stan Peng |
| Model Name | GN-WPKG | TEMP&Humidity : | 19.5°C , 75% |

| CH11 RX | | | | Measurement Distance at 1m | | | | Horizontal polarity | | | |
|---------|---------|--------|-------|----------------------------|------|--------|----------|---------------------|--------|---------|---------|
| Freq. | Reading | AF | Cable | Pre-amp | Dist | Filter | Level | Limit | Margin | Mark | Height |
| (MHz) | (dBuV) | (dBuV) | (dB) | (dB) | dB | dB | (dBuV/m) | (dBuV/m) | (dB) | (P/Q/A) | (Meter) |
| 4176.23 | 47.24 | 32.49 | 4.88 | 34.90 | 9.50 | 0.00 | 40.21 | 74 | -33.79 | P | 1.0 |
| 4176.23 | 38.82 | 32.49 | 4.88 | 34.90 | 9.50 | 0.00 | 31.79 | 54 | -22.21 | A | 1.0 |
| 6263.29 | 44.09 | 37.63 | 6.45 | 34.30 | 9.50 | 0.00 | 44.36 | 74 | -29.64 | P | 1.0 |
| 6263.29 | 32.58 | 37.63 | 6.45 | 34.30 | 9.50 | 0.00 | 32.85 | 54 | -21.15 | A | 1.0 |
| 8352.02 | 46.28 | 39.25 | 7.53 | 34.42 | 9.50 | 0.00 | 49.13 | 74 | -24.87 | P | 1.0 |
| 8352.02 | 33.61 | 39.25 | 7.53 | 34.42 | 9.50 | 0.00 | 36.46 | 54 | -17.54 | A | 1.0 |

1. AF: Antenna Factor, Cable: Cable Loss, Pre-Amp: Preamplifier gain, Filter: High Pass Filter Insertion Loss (3.5GHz)
2. Analyzer setting P(Peak): RBW=1MHz, VBW=1MHz, A(Average): RBW=1MHz,VBW=10Hz
3. Dist : correction to extra plate reading to 3m specification distance 1m measurement distance = -9.5dB
4. The result basic equation calculation as follow :
Level = Reading + AF + Cable - Preamp + Filter - Dist, Margin = Level - Limit
5. The test limit is 3M limit.
6. The frequency was searched to 18GHz.
7. The other emission levels were very low against the limit.
8. For 802.11g mode at 54Mbps.



Ecom Sertech Corp.

Rm. 258, Bldg. 17, NO.195, Sec. 4 Chung Hsing Rd., ChuTung Chen, Hsinchu, Taiwan 310, R.O.C
 TEL:886-3-5918012 FAX : 886-3-5825720

FCC ID : JCK-GN-WPKG
 Report No. : ER04-04-003FRF
 Page 30 of 64

Test Requirement: 15.109 ,15.209

The frequency spectrum above 1 GHz was investigated. All emissions not reported below are more than 40 dB below the prescribed limits. Readings are both peak and average values.

| | | | |
|--------------|--------------------------------|-----------------|--------------|
| Company | GIGA-BYTE TECHNOLOGY CO., LTD. | Test Date : | 2004/4/05 |
| Product Name | PCI Wireless LAN Card | Test By: | Stan Peng |
| Model Name | GN-WPKG | TEMP&Humidity : | 19.5°C , 75% |

| CH11 RX | | | | Measurement Distance at 1m | | | | | Vertical polarity | | |
|-------------|----------------|-----------|------------|----------------------------|-----------|-------------|----------------|----------------|-------------------|--------------|----------------|
| Freq. (MHz) | Reading (dBuV) | AF (dBuV) | Cable (dB) | Pre-amp (dB) | Dist (dB) | Filter (dB) | Level (dBuV/m) | Limit (dBuV/m) | Margin (dB) | Mark (P/Q/A) | Height (Meter) |
| 4175.66 | 46.54 | 32.49 | 4.88 | 34.90 | 9.50 | 0.00 | 39.51 | 74 | -34.49 | P | 1.0 |
| 4175.66 | 35.17 | 32.49 | 4.88 | 34.90 | 9.50 | 0.00 | 28.14 | 54 | -25.86 | A | 1.0 |
| 6263.76 | 44.53 | 37.63 | 6.45 | 34.30 | 9.50 | 0.00 | 44.80 | 74 | -29.20 | P | 1.0 |
| 6263.76 | 32.58 | 37.63 | 6.45 | 34.30 | 9.50 | 0.00 | 32.85 | 54 | -21.15 | A | 1.0 |
| 8352.06 | 44.24 | 39.25 | 7.53 | 34.42 | 9.50 | 0.00 | 47.10 | 74 | -26.90 | P | 1.0 |
| 8352.06 | 33.94 | 39.25 | 7.53 | 34.42 | 9.50 | 0.00 | 36.80 | 54 | -17.20 | A | 1.0 |

1. AF: Antenna Factor, Cable: Cable Loss, Pre-Amp: Preamplifier gain, Filter: High Pass Filter Insertion Loss (3.5GHz)
2. Analyzer setting P(Peak): RBW=1MHz, VBW=1MHz, A(Average): RBW=1MHz,VBW=10Hz
3. Dist : correction to extra plate reading to 3m specification distance 1m measurement distance = -9.5dB
4. The result basic equation calculation as follow :

$$\text{Level} = \text{Reading} + \text{AF} + \text{Cable} - \text{Preamp} + \text{Filter} - \text{Dist}, \text{Margin} = \text{Level} - \text{Limit}$$
5. The test limit is 3M limit.
6. The frequency was searched to 18GHz.
7. The other emission levels were very low against the limit.
8. For 802.11g mode at 54Mbps.



Ecom Sertech Corp.

Rm. 258, Bldg. 17, NO.195, Sec. 4 Chung Hsing Rd., ChuTung Chen, Hsinchu, Taiwan 310, R.O.C
 TEL:886-3-5918012 FAX : 886-3-5825720

FCC ID : JCK-GN-WPKG
 Report No. : ER04-04-003FRF
 Page 31 of 64

Test Requirement: 15.205

The frequency spectrum above 1 GHz was investigated. All emissions not reported below are more than 40 dB below the prescribed limits. Readings are both peak and average values.

| | | | |
|--------------|--------------------------------|-----------------|------------|
| Company | GIGA-BYTE TECHNOLOGY CO., LTD. | Test Date : | 2004/4/05 |
| Product Name | PCI Wireless LAN Card | Test By: | Stan Peng |
| Model Name | GN-WPKG | TEMP&Humidity : | 20°C , 86% |

| CH1 TX | | | | Measurement Distance at 1m Horizontal polarity | | | | | | | |
|------------|---------|--------|-------|--|------|--------|----------|-----------------------|--------|---------|---------|
| Freq. | Reading | AF | Cable | Pre-amp | Dist | Filter | Level | Limit | Margin | Mark | Height |
| (MHz) | (dBuV) | (dBuV) | (dB) | (dB) | dB | dB | (dBuV/m) | (dBuV/m) | (dB) | (P/Q/A) | (Meter) |
| * 2385.69 | 30.12 | 31.81 | 3.57 | 0.00 | 9.50 | 0.00 | 56.00 | 74 | -18.00 | P | 1.04 |
| * 2385.69 | 18.34 | 31.81 | 3.57 | 0.00 | 9.50 | 0.00 | 44.22 | 54 | -9.78 | A | 1.04 |
| 2412.95 | 85.67 | 31.79 | 3.58 | 0.00 | 9.50 | 0.00 | 111.54 | Fundamental Frequency | | P | 1.04 |
| 2412.95 | 78.81 | 31.79 | 3.58 | 0.00 | 9.50 | 0.00 | 104.68 | | | A | 1.04 |
| * 4823.99 | 44.39 | 34.44 | 5.08 | 35.16 | 9.50 | 2.00 | 41.26 | 74 | -32.74 | P | 1.00 |
| * 4823.99 | 33.46 | 34.44 | 5.08 | 35.16 | 9.50 | 2.00 | 30.33 | 54 | -23.67 | A | 1.00 |
| 7234.69 | 45.63 | 39.81 | 6.74 | 35.65 | 9.50 | 2.00 | 49.02 | 74 | -24.98 | P | 1.10 |
| 7234.69 | 36.06 | 39.81 | 6.74 | 35.65 | 9.50 | 2.00 | 39.45 | 54 | -14.55 | A | 1.10 |
| 9647.89 | 50.70 | 38.54 | 8.29 | 36.44 | 9.50 | 0.61 | 52.20 | 74 | -21.80 | P | 1.00 |
| 9647.89 | 43.54 | 38.54 | 8.29 | 36.44 | 9.50 | 0.61 | 45.04 | 54 | -8.96 | A | 1.00 |
| * 12064.75 | ----- | ----- | ----- | ----- | 9.50 | 0.80 | ----- | ----- | ----- | ----- | 1.00 |
| * 14477.70 | ----- | ----- | ----- | ----- | 0.00 | 0.67 | ----- | ----- | ----- | ----- | 1.00 |
| 16890.65 | ----- | ----- | ----- | ----- | 0.00 | 0.43 | ----- | ----- | ----- | ----- | 1.00 |
| * 19303.60 | ----- | ----- | ----- | ----- | 0.00 | 1.96 | ----- | ----- | ----- | ----- | 1.00 |
| 21716.55 | ----- | ----- | ----- | ----- | 0.00 | 0.81 | ----- | ----- | ----- | ----- | 1.00 |
| 24129.50 | ----- | ----- | ----- | ----- | 0.00 | 2.89 | ----- | ----- | ----- | ----- | 1.00 |

Note :

- The measurement was searched to 10th harmonic, Remark “---” means that the emissions level is too low to be measured.
- AF: Antenna Factor, Cable: Cable Loss, Pre-Amp: Preamplifier gain, Filter: High Pass Filter Insertion Loss (3.5GHz)
- Analyzer setting P(Peak): RBW=1MHz, VBW=1MHz, A(Average): RBW=1MHz, VBW=10Hz
- Remark “*” means the Restricted band.
- Dist : correction to extra plate reading to 3m specification distance 1m measurement distance = -9.5dB
- The result basic equation calculation is as follow:
 $Level = Reading + AF + Cable - Preamp + Filter - Dist$, $Margin = Level - Limit$
- The other emission levels were very low against the limit
- The test limit distance is 3M limit.
- For 802.11b mode at 11Mbps.



Ecom Sertech Corp.

Rm. 258, Bldg. 17, NO.195, Sec. 4 Chung Hsing Rd., ChuTung Chen, Hsinchu, Taiwan 310, R.O.C
 TEL:886-3-5918012 FAX : 886-3-5825720

FCC ID : JCK-GN-WPKG
 Report No. : ER04-04-003FRF
 Page 32 of 64

Test Requirement: 15.205

The frequency spectrum above 1 GHz was investigated. All emissions not reported below are more than 40 dB below the prescribed limits. Readings are both peak and average values.

| | | | |
|--------------|--------------------------------|-----------------|------------|
| Company | GIGA-BYTE TECHNOLOGY CO., LTD. | Test Date : | 2004/4/05 |
| Product Name | PCI Wireless LAN Card | Test By: | Stan Peng |
| Model Name | GN-WPKG | TEMP&Humidity : | 20°C , 86% |

| CH1 TX | | | | Measurement Distance at 1m | | | | Vertical polarity | | | |
|------------|---------|--------|-------|----------------------------|------|--------|----------|-----------------------|--------|---------|---------|
| Freq. | Reading | AF | Cable | Pre-amp | Dist | Filter | Level | Limit | Margin | Mark | Height |
| (MHz) | (dBuV) | (dBuV) | (dB) | (dB) | dB | dB | (dBuV/m) | (dBuV/m) | (dB) | (P/Q/A) | (Meter) |
| * 2385.69 | 34.23 | 31.81 | 3.57 | 0.00 | 9.50 | 0.00 | 60.11 | 74 | -13.89 | P | 1.00 |
| * 2385.69 | 22.26 | 31.81 | 3.57 | 0.00 | 9.50 | 0.00 | 48.14 | 54 | -5.86 | A | 1.00 |
| 2413.05 | 90.88 | 31.79 | 3.58 | 0.00 | 9.50 | 0.00 | 116.75 | Fundamental Frequency | | P | 1.00 |
| 2413.05 | 84.08 | 31.79 | 3.58 | 0.00 | 9.50 | 0.00 | 109.95 | | | A | 1.00 |
| * 4823.93 | 45.86 | 34.44 | 5.08 | 35.16 | 9.50 | 2.00 | 42.73 | 74 | -31.27 | P | 1.00 |
| * 4823.93 | 33.39 | 34.44 | 5.08 | 35.16 | 9.50 | 2.00 | 30.26 | 54 | -23.74 | A | 1.00 |
| 7236.60 | 45.41 | 39.81 | 6.74 | 35.65 | 9.50 | 2.00 | 48.80 | 74 | -25.20 | P | 1.27 |
| 7236.60 | 35.19 | 39.81 | 6.74 | 35.65 | 9.50 | 2.00 | 38.58 | 54 | -15.42 | A | 1.27 |
| 9647.93 | 47.65 | 38.54 | 8.29 | 36.44 | 9.50 | 0.61 | 49.15 | 74 | -24.85 | P | 1.25 |
| 9647.93 | 40.71 | 38.54 | 8.29 | 36.44 | 9.50 | 0.61 | 42.21 | 54 | -11.79 | A | 1.25 |
| * 12065.25 | ----- | ----- | ----- | ----- | 9.50 | 0.80 | ----- | ----- | ----- | ----- | 1.00 |
| * 14478.30 | ----- | ----- | ----- | ----- | 0.00 | 0.67 | ----- | ----- | ----- | ----- | 1.00 |
| 16891.35 | ----- | ----- | ----- | ----- | 0.00 | 0.43 | ----- | ----- | ----- | ----- | 1.00 |
| * 19304.40 | ----- | ----- | ----- | ----- | 0.00 | 1.97 | ----- | ----- | ----- | ----- | 1.00 |
| 21717.45 | ----- | ----- | ----- | ----- | 0.00 | 0.81 | ----- | ----- | ----- | ----- | 1.00 |
| 24130.50 | ----- | ----- | ----- | ----- | 0.00 | 2.89 | ----- | ----- | ----- | ----- | 1.00 |

Note :

- The measurement was searched to 10th harmonic, Remark “---” means that the emissions level is too low to be measured.
- AF: Antenna Factor, Cable: Cable Loss, Pre-Amp: Preamplifier gain, Filter: High Pass Filter Insertion Loss (3.5GHz)
- Analyzer setting P(Peak): RBW=1MHz, VBW=1MHz, A(Average): RBW=1MHz, VBW=10Hz
- Remark “*” means the Restricted band.
- Dist : correction to extra plate reading to 3m specification distance 1m measurement distance = -9.5dB
- The result basic equation calculation is as follow:
 $Level = Reading + AF + Cable - Preamp + Filter - Dist$, $Margin = Level - Limit$
- The other emission levels were very low against the limit
- The test limit distance is 3M limit.
- For 802.11b mode at 11Mbps.



Ecom Sertech Corp.

Rm. 258, Bldg. 17, NO.195, Sec. 4 Chung Hsing Rd., ChuTung Chen, Hsinchu, Taiwan 310, R.O.C
 TEL:886-3-5918012 FAX : 886-3-5825720

FCC ID : JCK-GN-WPKG
 Report No. : ER04-04-003FRF
 Page 33 of 64

Test Requirement: 15.205

The frequency spectrum above 1 GHz was investigated. All emissions not reported below are more than 40 dB below the prescribed limits. Readings are both peak and average values.

| | | | |
|--------------|--------------------------------|-----------------|------------|
| Company | GIGA-BYTE TECHNOLOGY CO., LTD. | Test Date : | 2004/4/05 |
| Product Name | PCI Wireless LAN Card | Test By: | Stan Peng |
| Model Name | GN-WPKG | TEMP&Humidity : | 20°C , 86% |

| CH6 TX | | | | Measurement Distance at 1m | | | | Horizontal polarity | | | |
|------------|---------|--------|-------|----------------------------|------|--------|----------|-----------------------|--------|---------|---------|
| Freq. | Reading | AF | Cable | Pre-amp | Dist | Filter | Level | Limit | Margin | Mark | Height |
| (MHz) | (dBuV) | (dBuV) | (dB) | (dB) | dB | dB | (dBuV/m) | (dBuV/m) | (dB) | (P/Q/A) | (Meter) |
| 2438.05 | 86.97 | 31.76 | 3.59 | 0.00 | 9.50 | 0.00 | 112.82 | Fundamental Frequency | | P | 1.00 |
| 2438.05 | 80.52 | 31.76 | 3.59 | 0.00 | 9.50 | 0.00 | 106.37 | | | A | 1.00 |
| * 4874.01 | 45.07 | 34.77 | 5.10 | 35.20 | 9.50 | 1.80 | 42.04 | 74 | -31.96 | P | 1.00 |
| * 4874.01 | 33.39 | 34.77 | 5.10 | 35.20 | 9.50 | 1.80 | 30.36 | 54 | -23.64 | A | 1.00 |
| * 7310.89 | 44.54 | 39.78 | 6.79 | 35.64 | 9.50 | 2.00 | 47.97 | 74 | -26.03 | P | 1.00 |
| * 7310.89 | 33.08 | 39.78 | 6.79 | 35.64 | 9.50 | 2.00 | 36.51 | 54 | -17.49 | A | 1.00 |
| 9748.02 | 48.04 | 38.53 | 8.33 | 36.60 | 9.50 | 0.55 | 49.35 | 74 | -24.65 | P | 0.00 |
| 9748.02 | 39.07 | 38.53 | 8.33 | 36.60 | 9.50 | 0.55 | 40.38 | 54 | -13.62 | A | 0.00 |
| * 12190.25 | ----- | ----- | ----- | ----- | 9.50 | 0.80 | ----- | ----- | ----- | ----- | 1.00 |
| 14628.30 | ----- | ----- | ----- | ----- | 0.00 | 0.60 | ----- | ----- | ----- | ----- | 1.00 |
| 17066.35 | ----- | ----- | ----- | ----- | 0.00 | 0.53 | ----- | ----- | ----- | ----- | 1.00 |
| * 19504.40 | ----- | ----- | ----- | ----- | 0.00 | 2.20 | ----- | ----- | ----- | ----- | 1.00 |
| 21942.45 | ----- | ----- | ----- | ----- | 0.00 | 0.72 | ----- | ----- | ----- | ----- | 1.00 |
| 24380.50 | ----- | ----- | ----- | ----- | 0.00 | 2.49 | ----- | ----- | ----- | ----- | 1.00 |

Note :

- The measurement was searched to 10th harmonic, Remark “---” means that the emissions level is too low to be measured.
- AF: Antenna Factor, Cable: Cable Loss, Pre-Amp: Preamplifier gain, Filter: High Pass Filter Insertion Loss (3.5GHz)
- Analyzer setting P(Peak): RBW=1MHz, VBW=1MHz, A(Average): RBW=1MHz, VBW=10Hz
- Remark “*” means the Restricted band.
- Dist : correction to extra plate reading to 3m specification distance 1m measurement distance = -9.5dB
- The result basic equation calculation is as follow:
 $Level = Reading + AF + Cable - Preamp + Filter - Dist$, $Margin = Level - Limit$
- The other emission levels were very low against the limit
- The test limit distance is 3M limit.
- For 802.11b mode at 11Mbps.



Ecom Sertech Corp.

Rm. 258, Bldg. 17, NO.195, Sec. 4 Chung Hsing Rd., ChuTung Chen, Hsinchu, Taiwan 310, R.O.C
 TEL:886-3-5918012 FAX : 886-3-5825720

FCC ID : JCK-GN-WPKG
 Report No. : ER04-04-003FRF
 Page 34 of 64

Test Requirement: 15.205

The frequency spectrum above 1 GHz was investigated. All emissions not reported below are more than 40 dB below the prescribed limits. Readings are both peak and average values.

| | | | |
|--------------|--------------------------------|-----------------|------------|
| Company | GIGA-BYTE TECHNOLOGY CO., LTD. | Test Date : | 2004/4/05 |
| Product Name | PCI Wireless LAN Card | Test By: | Stan Peng |
| Model Name | GN-WPKG | TEMP&Humidity : | 20°C , 86% |

| CH6 TX | | | | Measurement Distance at 1m | | | | Vertical polarity | | | |
|------------|---------|--------|-------|----------------------------|------|--------|----------|-----------------------|--------|---------|---------|
| Freq. | Reading | AF | Cable | Pre-amp | Dist | Filter | Level | Limit | Margin | Mark | Height |
| (MHz) | (dBuV) | (dBuV) | (dB) | (dB) | dB | dB | (dBuV/m) | (dBuV/m) | (dB) | (P/Q/A) | (Meter) |
| 2435.04 | 88.78 | 31.76 | 3.59 | 0.00 | 9.50 | 0.00 | 114.64 | Fundamental Frequency | | P | 1.00 |
| 2435.04 | 82.22 | 31.76 | 3.59 | 0.00 | 9.50 | 0.00 | 108.08 | | | A | 1.00 |
| * 4874.07 | 44.21 | 34.77 | 5.10 | 35.20 | 9.50 | 1.80 | 41.18 | 74 | -32.82 | P | 1.00 |
| * 4874.07 | 33.52 | 34.77 | 5.10 | 35.20 | 9.50 | 1.80 | 30.49 | 54 | -23.51 | A | 1.00 |
| * 7296.07 | 46.00 | 39.78 | 6.78 | 35.64 | 9.50 | 2.00 | 49.42 | 74 | -24.58 | P | 1.00 |
| * 7296.07 | 34.12 | 39.78 | 6.78 | 35.64 | 9.50 | 2.00 | 37.54 | 54 | -16.46 | A | 1.00 |
| 9748.02 | 47.78 | 38.53 | 8.33 | 36.60 | 9.50 | 0.55 | 49.09 | 74 | -24.91 | P | 1.00 |
| 9748.02 | 38.75 | 38.53 | 8.33 | 36.60 | 9.50 | 0.55 | 40.06 | 54 | -13.94 | A | 1.00 |
| * 12175.20 | ----- | ----- | ----- | ----- | 9.50 | 0.80 | ----- | ----- | ----- | ----- | 1.00 |
| 14610.24 | ----- | ----- | ----- | ----- | 0.00 | 0.61 | ----- | ----- | ----- | ----- | 1.00 |
| 17045.28 | ----- | ----- | ----- | ----- | 0.00 | 0.52 | ----- | ----- | ----- | ----- | 1.00 |
| * 19480.32 | ----- | ----- | ----- | ----- | 0.00 | 2.18 | ----- | ----- | ----- | ----- | 1.00 |
| 21915.36 | ----- | ----- | ----- | ----- | 0.00 | 0.73 | ----- | ----- | ----- | ----- | 1.00 |
| 24350.40 | ----- | ----- | ----- | ----- | 0.00 | 2.54 | ----- | ----- | ----- | ----- | 1.00 |

- Note :
- The measurement was searched to 10th harmonic, Remark “---” means that the emissions level is too low to be measured.
 - AF: Antenna Factor, Cable: Cable Loss, Pre-Amp: Preamplifier gain, Filter: High Pass Filter Insertion Loss (3.5GHz)
 - Analyzer setting P(Peak): RBW=1MHz, VBW=1MHz, A(Average): RBW=1MHz, VBW=10Hz
 - Remark “*” means the Restricted band.
 - Dist : correction to extra plate reading to 3m specification distance 1m measurement distance = -9.5dB
 - The result basic equation calculation is as follow:
 $Level = Reading + AF + Cable - Preamp + Filter - Dist$, $Margin = Level - Limit$
 - The other emission levels were very low against the limit
 - The test limit distance is 3M limit.
 - For 802.11b mode at 11Mbps.



Ecom Sertech Corp.

Rm. 258, Bldg. 17, NO.195, Sec. 4 Chung Hsing Rd., ChuTung Chen, Hsinchu, Taiwan 310, R.O.C
 TEL:886-3-5918012 FAX : 886-3-5825720

FCC ID : JCK-GN-WPKG
 Report No. : ER04-04-003FRF
 Page 35 of 64

Test Requirement: 15.205

The frequency spectrum above 1 GHz was investigated. All emissions not reported below are more than 40 dB below the prescribed limits. Readings are both peak and average values.

| | | | |
|--------------|--------------------------------|-----------------|------------|
| Company | GIGA-BYTE TECHNOLOGY CO., LTD. | Test Date : | 2004/4/05 |
| Product Name | PCI Wireless LAN Card | Test By: | Stan Peng |
| Model Name | GN-WPKG | TEMP&Humidity : | 20°C , 86% |

| CH11 TX | | | | Measurement Distance at 1m | | | | Horizontal polarity | | | |
|------------|---------|--------|-------|----------------------------|------|--------|----------|-----------------------|--------|---------|---------|
| Freq. | Reading | AF | Cable | Pre-amp | Dist | Filter | Level | Limit | Margin | Mark | Height |
| (MHz) | (dBuV) | (dBuV) | (dB) | (dB) | dB | dB | (dBuV/m) | (dBuV/m) | (dB) | (P/Q/A) | (Meter) |
| 2462.99 | 86.83 | 31.74 | 3.60 | 0.00 | 9.50 | 0.00 | 112.67 | Fundamental Frequency | | P | 1.00 |
| 2462.99 | 79.85 | 31.74 | 3.60 | 0.00 | 9.50 | 0.00 | 105.69 | | | A | 1.00 |
| * 2487.74 | 31.29 | 31.71 | 3.61 | 0.00 | 9.50 | 0.00 | 57.12 | 74 | -16.88 | P | 1.00 |
| * 2487.74 | 19.50 | 31.71 | 3.61 | 0.00 | 9.50 | 0.00 | 45.33 | 54 | -8.67 | A | 1.00 |
| * 4923.90 | 43.09 | 35.10 | 5.12 | 35.24 | 9.50 | 1.60 | 40.17 | 74 | -33.83 | P | 1.00 |
| * 4923.90 | 34.65 | 35.10 | 5.12 | 35.24 | 9.50 | 1.60 | 31.73 | 54 | -22.27 | A | 1.00 |
| * 7386.85 | 42.89 | 39.75 | 6.84 | 35.62 | 9.50 | 2.00 | 46.36 | 74 | -27.64 | P | 1.00 |
| * 7386.85 | 33.57 | 39.75 | 6.84 | 35.62 | 9.50 | 2.00 | 37.04 | 54 | -16.96 | A | 1.00 |
| 9848.00 | 44.18 | 38.52 | 8.37 | 36.76 | 9.50 | 0.49 | 45.29 | 74 | -28.71 | P | 1.00 |
| 9848.00 | 34.25 | 38.52 | 8.37 | 36.76 | 9.50 | 0.49 | 35.36 | 54 | -18.64 | A | 1.00 |
| * 12314.95 | ----- | ----- | ----- | ----- | 9.50 | 0.80 | ----- | ----- | ----- | ----- | 1.00 |
| 14777.94 | ----- | ----- | ----- | ----- | 0.00 | 0.48 | ----- | ----- | ----- | ----- | 1.00 |
| 17240.93 | ----- | ----- | ----- | ----- | 0.00 | 0.60 | ----- | ----- | ----- | ----- | 1.00 |
| * 19703.92 | ----- | ----- | ----- | ----- | 0.00 | 2.40 | ----- | ----- | ----- | ----- | 1.00 |
| * 22166.91 | ----- | ----- | ----- | ----- | 0.00 | 0.70 | ----- | ----- | ----- | ----- | 1.00 |
| 24629.90 | ----- | ----- | ----- | ----- | 0.00 | 2.12 | ----- | ----- | ----- | ----- | 1.00 |

Note :

- The measurement was searched to 10th harmonic, Remark "---" means that the emissions level is too low to be measured.
- AF: Antenna Factor, Cable: Cable Loss, Pre-Amp: Preamplifier gain, Filter: High Pass Filter Insertion Loss (3.5GHz)
- Analyzer setting P(Peak): RBW=1MHz, VBW=1MHz, A(Average): RBW=1MHz, VBW=10Hz
- Remark "*" means the Restricted band.
- Dist : correction to extra plate reading to 3m specification distance 1m measurement distance = -9.5dB
- The result basic equation calculation is as follow:
 $Level = Reading + AF + Cable - Preamp + Filter - Dist$, $Margin = Level - Limit$
- The other emission levels were very low against the limit
- The test limit distance is 3M limit.
- For 802.11b mode at 11Mbps.



Ecom Sertech Corp.

Rm. 258, Bldg. 17, NO.195, Sec. 4 Chung Hsing Rd., ChuTung Chen, Hsinchu, Taiwan 310, R.O.C
 TEL:886-3-5918012 FAX : 886-3-5825720

FCC ID : JCK-GN-WPKG
 Report No. : ER04-04-003FRF
 Page 36 of 64

Test Requirement: 15.205

The frequency spectrum above 1 GHz was investigated. All emissions not reported below are more than 40 dB below the prescribed limits. Readings are both peak and average values.

| | | | |
|--------------|--------------------------------|-----------------|------------|
| Company | GIGA-BYTE TECHNOLOGY CO., LTD. | Test Date : | 2004/4/05 |
| Product Name | PCI Wireless LAN Card | Test By: | Stan Peng |
| Model Name | GN-WPKG | TEMP&Humidity : | 20°C , 86% |

| CH11 TX | | | | Measurement Distance at 1m | | | | Vertical polarity | | | |
|------------|---------|--------|-------|----------------------------|------|--------|----------|-----------------------|--------|---------|---------|
| Freq. | Reading | AF | Cable | Pre-amp | Dist | Filter | Level | Limit | Margin | Mark | Height |
| (MHz) | (dBuV) | (dBuV) | (dB) | (dB) | dB | dB | (dBuV/m) | (dBuV/m) | (dB) | (P/Q/A) | (Meter) |
| 2458.68 | 91.33 | 31.74 | 3.60 | 0.00 | 9.50 | 0.00 | 117.17 | Fundamental Frequency | | P | 1.00 |
| 2458.68 | 84.09 | 31.74 | 3.60 | 0.00 | 9.50 | 0.00 | 109.93 | | | A | 1.00 |
| * 2487.74 | 35.70 | 31.71 | 3.61 | 0.00 | 9.50 | 0.00 | 61.53 | 74 | -12.47 | P | 1.00 |
| * 2487.74 | 23.02 | 31.71 | 3.61 | 0.00 | 9.50 | 0.00 | 48.85 | 54 | -5.15 | A | 1.00 |
| * 4923.97 | 44.02 | 35.10 | 5.12 | 35.24 | 9.50 | 1.60 | 41.10 | 74 | -32.90 | P | 1.00 |
| * 4923.97 | 34.87 | 35.10 | 5.12 | 35.24 | 9.50 | 1.60 | 31.95 | 54 | -22.05 | A | 1.00 |
| * 7384.89 | 44.50 | 39.75 | 6.84 | 35.62 | 9.50 | 2.00 | 47.96 | 74 | -26.04 | P | 1.00 |
| * 7384.89 | 34.28 | 39.75 | 6.84 | 35.62 | 9.50 | 2.00 | 37.74 | 54 | -16.26 | A | 1.00 |
| 9848.00 | 43.29 | 38.52 | 8.37 | 36.76 | 9.50 | 0.49 | 44.40 | 74 | -29.60 | P | 1.00 |
| 9848.00 | 32.87 | 38.52 | 8.37 | 36.76 | 9.50 | 0.49 | 33.98 | 54 | -20.02 | A | 1.00 |
| * 12293.40 | ----- | ----- | ----- | ----- | 9.50 | 0.80 | ----- | ----- | ----- | ----- | 1.00 |
| 14752.08 | ----- | ----- | ----- | ----- | 0.00 | 0.50 | ----- | ----- | ----- | ----- | 1.00 |
| 17210.76 | ----- | ----- | ----- | ----- | 0.00 | 0.58 | ----- | ----- | ----- | ----- | 1.00 |
| * 19669.44 | ----- | ----- | ----- | ----- | 0.00 | 2.37 | ----- | ----- | ----- | ----- | 1.00 |
| * 22128.12 | ----- | ----- | ----- | ----- | 0.00 | 0.70 | ----- | ----- | ----- | ----- | 1.00 |
| 24586.80 | ----- | ----- | ----- | ----- | 0.00 | 2.18 | ----- | ----- | ----- | ----- | 1.00 |

Note :

- The measurement was searched to 10th harmonic, Remark “---” means that the emissions level is too low to be measured.
- AF: Antenna Factor, Cable: Cable Loss, Pre-Amp: Preamplifier gain, Filter: High Pass Filter Insertion Loss (3.5GHz)
- Analyzer setting P(Peak): RBW=1MHz, VBW=1MHz, A(Average): RBW=1MHz, VBW=10Hz
- Remark “*” means the Restricted band.
- Dist : correction to extra plate reading to 3m specification distance 1m measurement distance = -9.5dB
- The result basic equation calculation is as follow:
 $Level = Reading + AF + Cable - Preamp + Filter - Dist$, $Margin = Level - Limit$
- The other emission levels were very low against the limit
- The test limit distance is 3M limit.
- For 802.11b mode at 11Mbps.



Ecom Sertech Corp.

Rm. 258, Bldg. 17, NO.195, Sec. 4 Chung Hsing Rd., ChuTung Chen, Hsinchu, Taiwan 310, R.O.C
 TEL:886-3-5918012 FAX : 886-3-5825720

FCC ID : JCK-GN-WPKG
 Report No. : ER04-04-003FRF
 Page 37 of 64

Test Requirement: 15.205

The frequency spectrum above 1 GHz was investigated. All emissions not reported below are more than 40 dB below the prescribed limits. Readings are both peak and average values.

| | | | |
|--------------|--------------------------------|-----------------|------------|
| Company | GIGA-BYTE TECHNOLOGY CO., LTD. | Test Date : | 2004/4/05 |
| Product Name | PCI Wireless LAN Card | Test By: | Stan Peng |
| Model Name | GN-WPKG | TEMP&Humidity : | 20°C , 86% |

| CH1 TX | | | | Measurement Distance at 1m | | | | Horizontal polarity | | | |
|------------|---------|--------|-------|----------------------------|------|--------|----------|-----------------------|--------|---------|---------|
| Freq. | Reading | AF | Cable | Pre-amp | Dist | Filter | Level | Limit | Margin | Mark | Height |
| (MHz) | (dBuV) | (dBuV) | (dB) | (dB) | dB | dB | (dBuV/m) | (dBuV/m) | (dB) | (P/Q/A) | (Meter) |
| * 2389.65 | 34.54 | 31.81 | 3.57 | 0.00 | 9.50 | 0.00 | 60.42 | 74 | -13.58 | P | 1.19 |
| * 2389.65 | 19.50 | 31.81 | 3.57 | 0.00 | 9.50 | 0.00 | 45.38 | 54 | -8.62 | A | 1.19 |
| 2413.70 | 84.16 | 31.79 | 3.58 | 0.00 | 9.50 | 0.00 | 110.03 | Fundamental Frequency | | P | 1.19 |
| 2413.70 | 74.35 | 31.79 | 3.58 | 0.00 | 9.50 | 0.00 | 100.22 | | | A | 1.19 |
| * 4824.11 | 43.56 | 34.44 | 5.08 | 35.16 | 9.50 | 2.00 | 40.43 | 74 | -33.57 | P | 1.00 |
| * 4824.11 | 33.89 | 34.44 | 5.08 | 35.16 | 9.50 | 2.00 | 30.76 | 54 | -23.24 | A | 1.00 |
| 7236.04 | 43.68 | 39.81 | 6.74 | 35.65 | 9.50 | 2.00 | 47.07 | 74 | -26.93 | P | 1.00 |
| 7236.04 | 34.78 | 39.81 | 6.74 | 35.65 | 9.50 | 2.00 | 38.17 | 54 | -15.83 | A | 1.00 |
| 9648.02 | 44.56 | 38.54 | 8.29 | 36.44 | 9.50 | 0.61 | 46.06 | 74 | -27.94 | P | 1.00 |
| 9648.02 | 34.01 | 38.54 | 8.29 | 36.44 | 9.50 | 0.61 | 35.51 | 54 | -18.49 | A | 1.00 |
| * 12068.50 | ----- | ----- | ----- | ----- | 9.50 | 0.80 | ----- | ----- | ----- | ----- | 1.00 |
| * 14482.20 | ----- | ----- | ----- | ----- | 0.00 | 0.68 | ----- | ----- | ----- | ----- | 1.00 |
| 16895.90 | ----- | ----- | ----- | ----- | 0.00 | 0.44 | ----- | ----- | ----- | ----- | 1.00 |
| * 19309.60 | ----- | ----- | ----- | ----- | 0.00 | 1.97 | ----- | ----- | ----- | ----- | 1.00 |
| 21723.30 | ----- | ----- | ----- | ----- | 0.00 | 0.81 | ----- | ----- | ----- | ----- | 1.00 |
| 24137.00 | ----- | ----- | ----- | ----- | 0.00 | 2.88 | ----- | ----- | ----- | ----- | 1.00 |

Note :

- The measurement was searched to 10th harmonic, Remark “---” means that the emissions level is too low to be measured.
- AF: Antenna Factor, Cable: Cable Loss, Pre-Amp: Preamplifier gain, Filter: High Pass Filter Insertion Loss (3.5GHz)
- Analyzer setting P(Peak): RBW=1MHz, VBW=1MHz, A(Average): RBW=1MHz, VBW=10Hz
- Remark “*” means the Restricted band.
- Dist : correction to extra plate reading to 3m specification distance 1m measurement distance = -9.5dB
- The result basic equation calculation is as follow:
 $Level = Reading + AF + Cable - Preamp + Filter - Dist$, $Margin = Level - Limit$
- The other emission levels were very low against the limit
- The test limit distance is 3M limit.
- For 802.11g mode at 54Mbps.



Ecom Sertech Corp.

Rm. 258, Bldg. 17, NO.195, Sec. 4 Chung Hsing Rd., ChuTung Chen, Hsinchu, Taiwan 310, R.O.C
 TEL:886-3-5918012 FAX : 886-3-5825720

FCC ID : JCK-GN-WPKG
 Report No. : ER04-04-003FRF
 Page 38 of 64

Test Requirement: 15.205

The frequency spectrum above 1 GHz was investigated. All emissions not reported below are more than 40 dB below the prescribed limits. Readings are both peak and average values.

| | | | |
|--------------|--------------------------------|-----------------|------------|
| Company | GIGA-BYTE TECHNOLOGY CO., LTD. | Test Date : | 2004/4/05 |
| Product Name | PCI Wireless LAN Card | Test By: | Stan Peng |
| Model Name | GN-WPKG | TEMP&Humidity : | 20°C , 86% |

| CH1 TX | | | | Measurement Distance at 1m | | | | Vertical polarity | | | |
|------------|---------|--------|-------|----------------------------|------|--------|----------|-----------------------|--------|---------|---------|
| Freq. | Reading | AF | Cable | Pre-amp | Dist | Filter | Level | Limit | Margin | Mark | Height |
| (MHz) | (dBuV) | (dBuV) | (dB) | (dB) | dB | dB | (dBuV/m) | (dBuV/m) | (dB) | (P/Q/A) | (Meter) |
| * 2389.65 | 38.54 | 31.81 | 3.57 | 0.00 | 9.50 | 0.00 | 64.42 | 74 | -9.58 | P | 1.21 |
| * 2389.65 | 23.02 | 31.81 | 3.57 | 0.00 | 9.50 | 0.00 | 48.90 | 54 | -5.10 | A | 1.21 |
| 2413.70 | 87.28 | 31.79 | 3.58 | 0.00 | 9.50 | 0.00 | 113.15 | Fundamental Frequency | | P | 1.21 |
| 2413.70 | 77.53 | 31.79 | 3.58 | 0.00 | 9.50 | 0.00 | 103.40 | | | A | 1.21 |
| * 4824.01 | 43.22 | 34.44 | 5.08 | 35.16 | 9.50 | 2.00 | 40.09 | 74 | -33.91 | P | 1.00 |
| * 4824.01 | 34.19 | 34.44 | 5.08 | 35.16 | 9.50 | 2.00 | 31.06 | 54 | -22.94 | A | 1.00 |
| 7236.10 | 44.17 | 39.81 | 6.74 | 35.65 | 9.50 | 2.00 | 47.56 | 74 | -26.44 | P | 1.00 |
| 7236.10 | 33.85 | 39.81 | 6.74 | 35.65 | 9.50 | 2.00 | 37.24 | 54 | -16.76 | A | 1.00 |
| 9648.02 | 45.05 | 38.54 | 8.29 | 36.44 | 9.50 | 0.61 | 46.55 | 74 | -27.45 | P | 1.00 |
| 9648.02 | 34.18 | 38.54 | 8.29 | 36.44 | 9.50 | 0.61 | 35.68 | 54 | -18.32 | A | 1.00 |
| * 12068.50 | ----- | ----- | ----- | ----- | 9.50 | 0.80 | ----- | ----- | ----- | ----- | 1.00 |
| * 14482.20 | ----- | ----- | ----- | ----- | 0.00 | 0.68 | ----- | ----- | ----- | ----- | 1.00 |
| 16895.90 | ----- | ----- | ----- | ----- | 0.00 | 0.44 | ----- | ----- | ----- | ----- | 1.00 |
| * 19309.60 | ----- | ----- | ----- | ----- | 0.00 | 1.97 | ----- | ----- | ----- | ----- | 1.00 |
| 21723.30 | ----- | ----- | ----- | ----- | 0.00 | 0.81 | ----- | ----- | ----- | ----- | 1.00 |
| 24137.00 | ----- | ----- | ----- | ----- | 0.00 | 2.88 | ----- | ----- | ----- | ----- | 1.00 |

- Note :
- The measurement was searched to 10th harmonic, Remark “---” means that the emissions level is too low to be measured.
 - AF: Antenna Factor, Cable: Cable Loss, Pre-Amp: Preamplifier gain, Filter: High Pass Filter Insertion Loss (3.5GHz)
 - Analyzer setting P(Peak): RBW=1MHz, VBW=1MHz, A(Average): RBW=1MHz, VBW=10Hz
 - Remark “*” means the Restricted band.
 - Dist : correction to extra plate reading to 3m specification distance 1m measurement distance = -9.5dB
 - The result basic equation calculation is as follow:
 $Level = Reading + AF + Cable - Preamp + Filter - Dist, Margin = Level - Limit$
 - The other emission levels were very low against the limit
 - The test limit distance is 3M limit.
 - For 802.11g mode at 54Mbps.



Ecom Sertech Corp.

Rm. 258, Bldg. 17, NO.195, Sec. 4 Chung Hsing Rd., ChuTung Chen, Hsinchu, Taiwan 310, R.O.C
 TEL:886-3-5918012 FAX : 886-3-5825720

FCC ID : JCK-GN-WPKG
 Report No. : ER04-04-003FRF
 Page 39 of 64

Test Requirement: 15.205

The frequency spectrum above 1 GHz was investigated. All emissions not reported below are more than 40 dB below the prescribed limits. Readings are both peak and average values.

| | | | |
|--------------|--------------------------------|-----------------|------------|
| Company | GIGA-BYTE TECHNOLOGY CO., LTD. | Test Date : | 2004/4/05 |
| Product Name | PCI Wireless LAN Card | Test By: | Stan Peng |
| Model Name | GN-WPKG | TEMP&Humidity : | 20°C , 86% |

| CH6 TX | | | | Measurement Distance at 1m | | | | Horizontal polarity | | | |
|------------|---------|--------|-------|----------------------------|------|--------|----------|-----------------------|--------|---------|---------|
| Freq. | Reading | AF | Cable | Pre-amp | Dist | Filter | Level | Limit | Margin | Mark | Height |
| (MHz) | (dBuV) | (dBuV) | (dB) | (dB) | dB | dB | (dBuV/m) | (dBuV/m) | (dB) | (P/Q/A) | (Meter) |
| 2429.83 | 83.18 | 31.77 | 3.59 | 0.00 | 9.50 | 0.00 | 109.04 | Fundamental Frequency | | P | 1.00 |
| 2429.83 | 75.38 | 31.77 | 3.59 | 0.00 | 9.50 | 101.24 | A | | | 1.00 | |
| * 4875.17 | 44.48 | 34.78 | 5.10 | 35.20 | 9.50 | 1.80 | 41.46 | 74 | -32.54 | P | 1.00 |
| * 4875.17 | 33.36 | 34.78 | 5.10 | 35.20 | 9.50 | 1.80 | 30.34 | 54 | -23.66 | A | 1.00 |
| * 7311.08 | 44.70 | 39.78 | 6.79 | 35.64 | 9.50 | 2.00 | 48.13 | 74 | -25.87 | P | 1.00 |
| * 7311.08 | 33.82 | 39.78 | 6.79 | 35.64 | 9.50 | 2.00 | 37.25 | 54 | -16.75 | A | 1.00 |
| 9748.03 | 46.26 | 38.53 | 8.33 | 36.60 | 9.50 | 0.55 | 47.57 | 74 | -26.43 | P | 1.00 |
| 9748.03 | 34.73 | 38.53 | 8.33 | 36.60 | 9.50 | 0.55 | 36.04 | 54 | -17.96 | A | 1.00 |
| * 12149.15 | ----- | ----- | ----- | ----- | 9.50 | 0.80 | ----- | ----- | ----- | ----- | 1.00 |
| 14578.98 | ----- | ----- | ----- | ----- | 0.00 | 0.64 | ----- | ----- | ----- | ----- | 1.00 |
| 17008.81 | ----- | ----- | ----- | ----- | 0.00 | 0.50 | ----- | ----- | ----- | ----- | 1.00 |
| * 19438.64 | ----- | ----- | ----- | ----- | 0.00 | 2.13 | ----- | ----- | ----- | ----- | 1.00 |
| 21868.47 | ----- | ----- | ----- | ----- | 0.00 | 0.75 | ----- | ----- | ----- | ----- | 1.00 |
| 24298.30 | ----- | ----- | ----- | ----- | 0.00 | 2.62 | ----- | ----- | ----- | ----- | 1.00 |

Note :

- The measurement was searched to 10th harmonic, Remark “---” means that the emissions level is too low to be measured.
- AF: Antenna Factor, Cable: Cable Loss, Pre-Amp: Preamplifier gain, Filter: High Pass Filter Insertion Loss (3.5GHz)
- Analyzer setting P(Peak): RBW=1MHz, VBW=1MHz, A(Average): RBW=1MHz, VBW=10Hz
- Remark “*” means the Restricted band.
- Dist : correction to extra plate reading to 3m specification distance 1m measurement distance = -9.5dB
- The result basic equation calculation is as follow:
 $Level = Reading + AF + Cable - Preamp + Filter - Dist$, $Margin = Level - Limit$
- The other emission levels were very low against the limit
- The test limit distance is 3M limit.
- For 802.11g mode at 54Mbps.



Ecom Sertech Corp.

Rm. 258, Bldg. 17, NO.195, Sec. 4 Chung Hsing Rd., ChuTung Chen, Hsinchu, Taiwan 310, R.O.C
 TEL:886-3-5918012 FAX : 886-3-5825720

FCC ID : JCK-GN-WPKG
 Report No. : ER04-04-003FRF
 Page 40 of 64

Test Requirement: 15.205

The frequency spectrum above 1 GHz was investigated. All emissions not reported below are more than 40 dB below the prescribed limits. Readings are both peak and average values.

| | | | |
|--------------|--------------------------------|-----------------|------------|
| Company | GIGA-BYTE TECHNOLOGY CO., LTD. | Test Date : | 2004/4/05 |
| Product Name | PCI Wireless LAN Card | Test By: | Stan Peng |
| Model Name | GN-WPKG | TEMP&Humidity : | 20°C , 86% |

| CH6 TX | | | | Measurement Distance at 1m | | | | Vertical polarity | | | |
|------------|---------|--------|-------|----------------------------|------|--------|----------|-----------------------|--------|---------|---------|
| Freq. | Reading | AF | Cable | Pre-amp | Dist | Filter | Level | Limit | Margin | Mark | Height |
| (MHz) | (dBuV) | (dBuV) | (dB) | (dB) | dB | dB | (dBuV/m) | (dBuV/m) | (dB) | (P/Q/A) | (Meter) |
| 2429.93 | 85.15 | 31.77 | 3.59 | 0.00 | 9.50 | 0.00 | 111.01 | Fundamental Frequency | | P | 1.00 |
| 2429.93 | 77.11 | 31.77 | 3.59 | 0.00 | 9.50 | 0.00 | 102.97 | | | A | 1.00 |
| * 4870.44 | 44.41 | 34.74 | 5.10 | 35.20 | 9.50 | 1.82 | 41.38 | 74 | -32.62 | P | 1.00 |
| * 4870.44 | 33.67 | 34.74 | 5.10 | 35.20 | 9.50 | 1.82 | 30.64 | 54 | -23.36 | A | 1.00 |
| * 7313.05 | 45.93 | 39.77 | 6.79 | 35.64 | 9.50 | 2.00 | 49.36 | 74 | -24.64 | P | 1.00 |
| * 7313.05 | 32.94 | 39.77 | 6.79 | 35.64 | 9.50 | 2.00 | 36.37 | 54 | -17.63 | A | 1.00 |
| 9745.84 | 46.47 | 38.53 | 8.33 | 36.59 | 9.50 | 0.55 | 47.78 | 74 | -26.22 | P | 1.00 |
| 9745.84 | 34.16 | 38.53 | 8.33 | 36.59 | 9.50 | 0.55 | 35.47 | 54 | -18.53 | A | 1.00 |
| * 12149.65 | ----- | ----- | ----- | ----- | 9.50 | 0.80 | ----- | ----- | ----- | ----- | 1.00 |
| 14579.58 | ----- | ----- | ----- | ----- | 0.00 | 0.64 | ----- | ----- | ----- | ----- | 1.00 |
| 17009.51 | ----- | ----- | ----- | ----- | 0.00 | 0.50 | ----- | ----- | ----- | ----- | 1.00 |
| * 19439.44 | ----- | ----- | ----- | ----- | 0.00 | 2.13 | ----- | ----- | ----- | ----- | 1.00 |
| 21869.37 | ----- | ----- | ----- | ----- | 0.00 | 0.75 | ----- | ----- | ----- | ----- | 1.00 |
| 24299.30 | ----- | ----- | ----- | ----- | 0.00 | 2.62 | ----- | ----- | ----- | ----- | 1.00 |

Note :

- The measurement was searched to 10th harmonic, Remark “---” means that the emissions level is too low to be measured.
- AF: Antenna Factor, Cable: Cable Loss, Pre-Amp: Preamplifier gain, Filter: High Pass Filter Insertion Loss (3.5GHz)
- Analyzer setting P(Peak): RBW=1MHz, VBW=1MHz, A(Average): RBW=1MHz, VBW=10Hz
- Remark “*” means the Restricted band.
- Dist : correction to extra plate reading to 3m specification distance 1m measurement distance = -9.5dB
- The result basic equation calculation is as follow:
 $Level = Reading + AF + Cable - Preamp + Filter - Dist$, $Margin = Level - Limit$
- The other emission levels were very low against the limit
- The test limit distance is 3M limit.
- For 802.11g mode at 54Mbps.



Ecom Sertech Corp.

Rm. 258, Bldg. 17, NO.195, Sec. 4 Chung Hsing Rd., ChuTung Chen, Hsinchu, Taiwan 310, R.O.C
 TEL:886-3-5918012 FAX : 886-3-5825720

FCC ID : JCK-GN-WPKG
 Report No. : ER04-04-003FRF
 Page 41 of 64

Test Requirement: 15.205

The frequency spectrum above 1 GHz was investigated. All emissions not reported below are more than 40 dB below the prescribed limits. Readings are both peak and average values.

| | | | |
|--------------|--------------------------------|-----------------|------------|
| Company | GIGA-BYTE TECHNOLOGY CO., LTD. | Test Date : | 2004/4/05 |
| Product Name | PCI Wireless LAN Card | Test By: | Stan Peng |
| Model Name | GN-WPKG | TEMP&Humidity : | 20°C , 86% |

| CH11 TX | | | | Measurement Distance at 1m | | | | Horizontal polarity | | | |
|------------|---------|--------|-------|----------------------------|------|--------|----------|-----------------------|--------|---------|---------|
| Freq. | Reading | AF | Cable | Pre-amp | Dist | Filter | Level | Limit | Margin | Mark | Height |
| (MHz) | (dBuV) | (dBuV) | (dB) | (dB) | dB | dB | (dBuV/m) | (dBuV/m) | (dB) | (P/Q/A) | (Meter) |
| 2463.80 | 85.34 | 31.74 | 3.60 | 0.00 | 9.50 | 0.00 | 111.18 | Fundamental Frequency | | P | 1.02 |
| 2463.80 | 75.02 | 31.74 | 3.60 | 0.00 | 9.50 | 0.00 | 100.86 | | | A | 1.02 |
| * 2483.94 | 38.92 | 31.72 | 3.61 | 0.00 | 9.50 | 0.00 | 64.75 | 74 | -9.25 | P | 1.02 |
| * 2483.94 | 22.26 | 31.72 | 3.61 | 0.00 | 9.50 | 0.00 | 48.09 | 54 | -5.91 | A | 1.02 |
| * 4923.24 | 44.12 | 35.09 | 5.12 | 35.24 | 9.50 | 1.61 | 41.20 | 74 | -32.80 | P | 1.00 |
| * 4923.24 | 32.59 | 35.09 | 5.12 | 35.24 | 9.50 | 1.61 | 29.67 | 54 | -24.33 | A | 1.00 |
| * 7386.11 | 44.01 | 39.75 | 6.84 | 35.62 | 9.50 | 2.00 | 47.48 | 74 | -26.52 | P | 1.00 |
| * 7386.11 | 33.64 | 39.75 | 6.84 | 35.62 | 9.50 | 2.00 | 37.11 | 54 | -16.89 | A | 1.00 |
| 9848.00 | 43.59 | 38.52 | 8.37 | 36.76 | 9.50 | 0.49 | 44.70 | 74 | -29.30 | P | 1.00 |
| 9848.00 | 33.89 | 38.52 | 8.37 | 36.76 | 9.50 | 0.49 | 35.00 | 54 | -19.00 | A | 1.00 |
| * 12319.00 | ----- | ----- | ----- | ----- | 9.50 | 0.80 | ----- | ----- | ----- | ----- | 1.00 |
| 14782.80 | ----- | ----- | ----- | ----- | 0.00 | 0.47 | ----- | ----- | ----- | ----- | 1.00 |
| 17246.60 | ----- | ----- | ----- | ----- | 0.00 | 0.60 | ----- | ----- | ----- | ----- | 1.00 |
| * 19710.40 | ----- | ----- | ----- | ----- | 0.00 | 2.41 | ----- | ----- | ----- | ----- | 1.00 |
| * 22174.20 | ----- | ----- | ----- | ----- | 0.00 | 0.70 | ----- | ----- | ----- | ----- | 1.00 |
| 24638.00 | ----- | ----- | ----- | ----- | 0.00 | 2.11 | ----- | ----- | ----- | ----- | 1.00 |

- Note :
- The measurement was searched to 10th harmonic, Remark “---” means that the emissions level is too low to be measured.
 - AF: Antenna Factor, Cable: Cable Loss, Pre-Amp: Preamplifier gain, Filter: High Pass Filter Insertion Loss (3.5GHz)
 - Analyzer setting P(Peak): RBW=1MHz, VBW=1MHz, A(Average): RBW=1MHz, VBW=10Hz
 - Remark “*” means the Restricted band.
 - Dist : correction to extra plate reading to 3m specification distance 1m measurement distance = -9.5dB
 - The result basic equation calculation is as follow:
 $Level = Reading + AF + Cable - Preamp + Filter - Dist$, $Margin = Level - Limit$
 - The other emission levels were very low against the limit
 - The test limit distance is 3M limit.
 - For 802.11g mode at 54Mbps.



Ecom Sertech Corp.

Rm. 258, Bldg. 17, NO.195, Sec. 4 Chung Hsing Rd., ChuTung Chen, Hsinchu, Taiwan 310, R.O.C
 TEL:886-3-5918012 FAX : 886-3-5825720

FCC ID : JCK-GN-WPKG
 Report No. : ER04-04-003FRF
 Page 42 of 64

Test Requirement: 15.205

The frequency spectrum above 1 GHz was investigated. All emissions not reported below are more than 40 dB below the prescribed limits. Readings are both peak and average values.

| | | | |
|--------------|--------------------------------|-----------------|------------|
| Company | GIGA-BYTE TECHNOLOGY CO., LTD. | Test Date : | 2004/4/05 |
| Product Name | PCI Wireless LAN Card | Test By: | Stan Peng |
| Model Name | GN-WPKG | TEMP&Humidity : | 20°C , 86% |

| CH11 TX | | | | Measurement Distance at 1m | | | | Vertical polarity | | | |
|------------|---------|--------|-------|----------------------------|------|--------|----------|-----------------------|--------|---------|---------|
| Freq. | Reading | AF | Cable | Pre-amp | Dist | Filter | Level | Limit | Margin | Mark | Height |
| (MHz) | (dBuV) | (dBuV) | (dB) | (dB) | dB | dB | (dBuV/m) | (dBuV/m) | (dB) | (P/Q/A) | (Meter) |
| 2463.60 | 88.46 | 31.74 | 3.60 | 0.00 | 9.50 | 0.00 | 114.30 | Fundamental Frequency | | P | 1.00 |
| 2463.60 | 78.09 | 31.74 | 3.60 | 0.00 | 9.50 | 0.00 | 103.93 | | | A | 1.00 |
| * 2483.94 | 41.16 | 31.72 | 3.61 | 0.00 | 9.50 | 0.00 | 66.99 | 74 | -7.01 | P | 1.00 |
| * 2483.94 | 24.96 | 31.72 | 3.61 | 0.00 | 9.50 | 0.00 | 50.79 | 54 | -3.21 | A | 1.00 |
| * 4924.01 | 43.45 | 35.10 | 5.12 | 35.24 | 9.50 | 1.60 | 40.53 | 74 | -33.47 | P | 1.00 |
| * 4924.01 | 34.12 | 35.10 | 5.12 | 35.24 | 9.50 | 1.60 | 31.20 | 54 | -22.80 | A | 1.00 |
| * 7386.14 | 42.93 | 39.75 | 6.84 | 35.62 | 9.50 | 2.00 | 46.40 | 74 | -27.60 | P | 1.00 |
| * 7386.14 | 33.01 | 39.75 | 6.84 | 35.62 | 9.50 | 2.00 | 36.48 | 54 | -17.52 | A | 1.00 |
| 9848.00 | 44.56 | 38.52 | 8.37 | 36.76 | 9.50 | 0.49 | 45.67 | 74 | -28.33 | P | 1.00 |
| 9848.00 | 33.77 | 38.52 | 8.37 | 36.76 | 9.50 | 0.49 | 34.88 | 54 | -19.12 | A | 1.00 |
| * 12318.00 | ----- | ----- | ----- | ----- | 9.50 | 0.80 | ----- | ----- | ----- | ----- | 1.00 |
| 14781.60 | ----- | ----- | ----- | ----- | 0.00 | 0.47 | ----- | ----- | ----- | ----- | 1.00 |
| 17245.20 | ----- | ----- | ----- | ----- | 0.00 | 0.60 | ----- | ----- | ----- | ----- | 1.00 |
| * 19708.80 | ----- | ----- | ----- | ----- | 0.00 | 2.41 | ----- | ----- | ----- | ----- | 1.00 |
| * 22172.40 | ----- | ----- | ----- | ----- | 0.00 | 0.70 | ----- | ----- | ----- | ----- | 1.00 |
| 24636.00 | ----- | ----- | ----- | ----- | 0.00 | 2.11 | ----- | ----- | ----- | ----- | 1.00 |

Note :

- The measurement was searched to 10th harmonic, Remark “---” means that the emissions level is too low to be measured.
- AF: Antenna Factor, Cable: Cable Loss, Pre-Amp: Preamplifier gain, Filter: High Pass Filter Insertion Loss (3.5GHz)
- Analyzer setting P(Peak): RBW=1MHz, VBW=1MHz, A(Average): RBW=1MHz, VBW=10Hz
- Remark “*” means the Restricted band.
- Dist : correction to extra plate reading to 3m specification distance 1m measurement distance = -9.5dB
- The result basic equation calculation is as follow:
 $Level = Reading + AF + Cable - Preamp + Filter - Dist$, $Margin = Level - Limit$
- The other emission levels were very low against the limit
- The test limit distance is 3M limit.
- For 802.11g mode at 54Mbps.

3.7 Photos of Open Site





Ecom Sertech Corp.

Rm. 258, Bldg. 17, NO.195, Sec. 4 Chung Hsing Rd., ChuTung Chen, Hsinchu, Taiwan 310, R.O.C
TEL:886-3-5918012 FAX : 886-3-5825720

FCC ID : JCK-GN-WPKG
Report No. : ER04-04-003FRF
Page 44 of 64





4. 6dB BANDWIDTH MEASUREMENT

4.1 Test Equipments

| Description & Manufacturer | Model No. | Serial No. | Date Of Calibration |
|-----------------------------------|-----------|-------------|---------------------|
| ROHDE & SCHWARZ SPECTRUM ANALYZER | FSEK30 | 835253/002 | JUN. 17, 2003 |
| HP ATTENUATOR | 8496B | 3247A18505 | Cal. on use |
| HP PLOTTER | 7750A | 725A 852141 | N/A |

- Note : 1. The measurement uncertainty is less than +/- 2.6dB, which is calculated as per the NAMAS document NIS81.
2. The calibration interval of the above test instruments is 12 months and the calibrations are traceable to NML/ROC and NIST/USA.

4.2 Test Setup

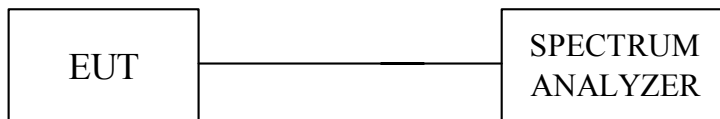

4.3 Limits of 6dB Bandwidth Measurement

The minimum of 6dB Bandwidth Measurement is >500KHz

4.4 Test Procedure

The transmitter output was connected to the spectrum analyzer through an attenuator. The bandwidth of the fundamental frequency was measured by spectrum analyzer with 100 KHz RBW and 10MHz VBW. The 6dB bandwidth is defined as the total spectrum the power of which is higher than peak power minus 6dB.

4.5 Uncertainty of Conducted Emission

The uncertainty of conducted emission is ± 200KHz.



4.6 Test Results

| | | | |
|-----------------------------|-------------------|---------------------------------|------------------|
| Input Power (System) | 5VDC (From PC) | Environmental Conditions | 22.1°C, 80%RH |
| Tested By | Stan Peng | | |

| Channel | Channel Frequency (MHz) | 6dB Bandwidth (MHz) | Minimum Limit (MHz) | Pass / Fail |
|----------------|--------------------------------|----------------------------|----------------------------|--------------------|
| 1 | 2412 | 12.14 | 0.5 | PASS |
| 6 | 2437 | 12.38 | 0.5 | PASS |
| 11 | 2462 | 12.38 | 0.5 | PASS |

Note: For 802.11b mode.

| Channel | Channel Frequency (MHz) | 6dB Bandwidth (MHz) | Minimum Limit (MHz) | Pass / Fail |
|----------------|--------------------------------|----------------------------|----------------------------|--------------------|
| 1 | 2412 | 16.63 | 0.5 | PASS |
| 6 | 2437 | 16.63 | 0.5 | PASS |
| 11 | 2462 | 16.59 | 0.5 | PASS |

Note: For 802.11g mode.



4.7 Photo of 6db Bandwidth Measurement

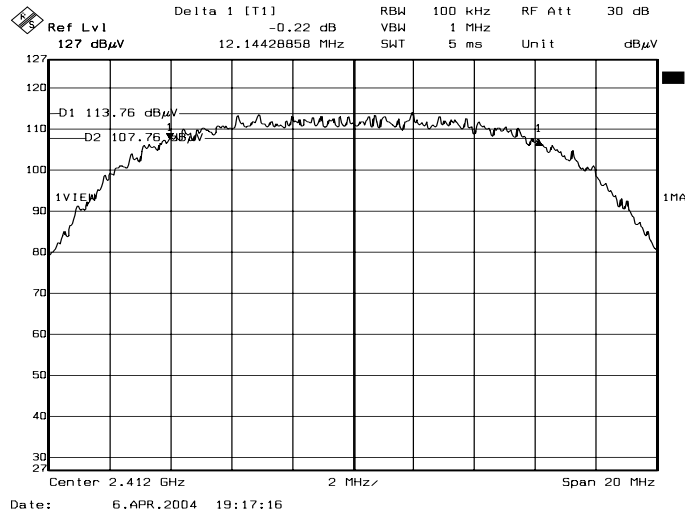

Channel 1

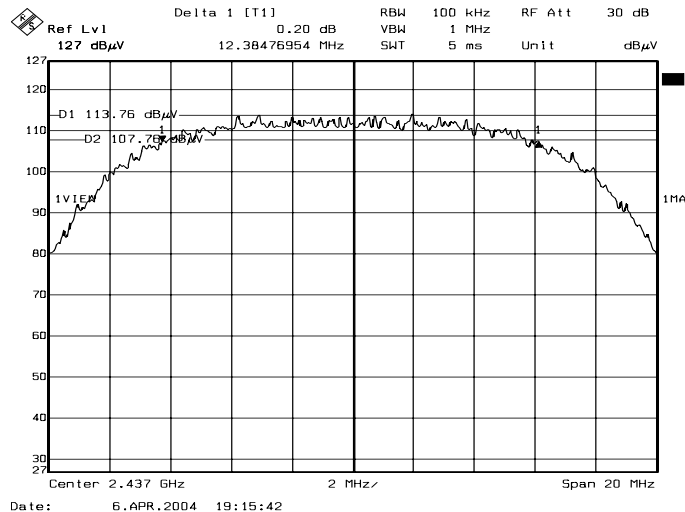

Channel 6

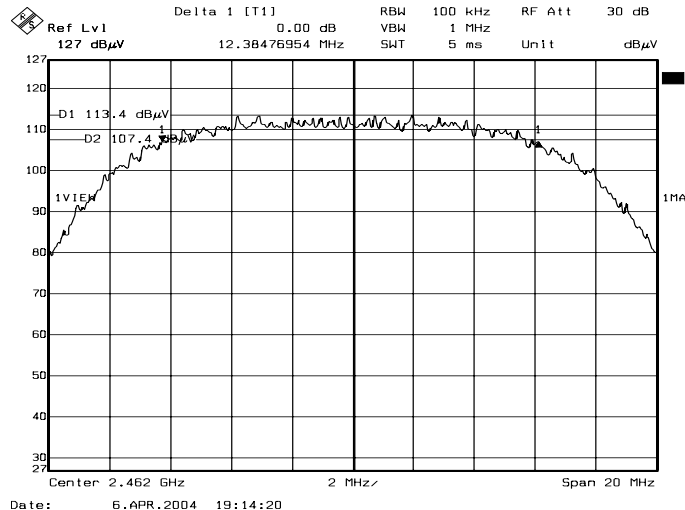

Channel 11

Note: For 802.11b mode



Ecom Sertech Corp.

Rm. 258, Bldg. 17, NO.195, Sec. 4 Chung Hsing Rd., ChuTung Chen, Hsinchu, Taiwan 310, R.O.C
TEL:886-3-5918012 FAX : 886-3-5825720

FCC ID : JCK-GN-WPKG

Report No. : ER04-04-003FRF

Page 48 of 64

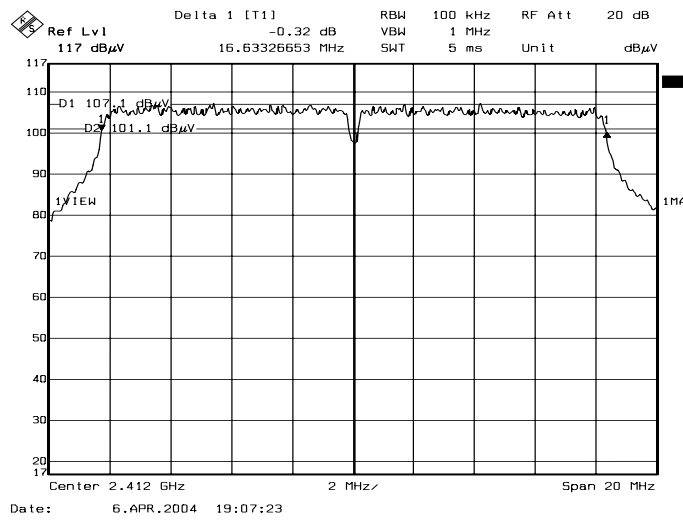

Channel 1

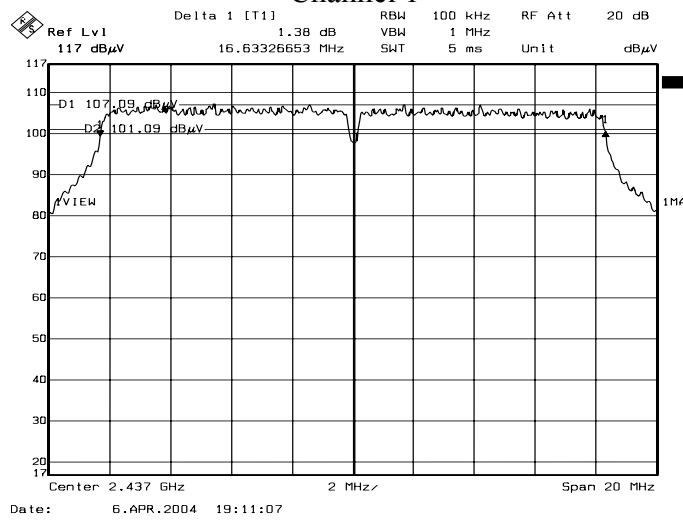

Channel 6

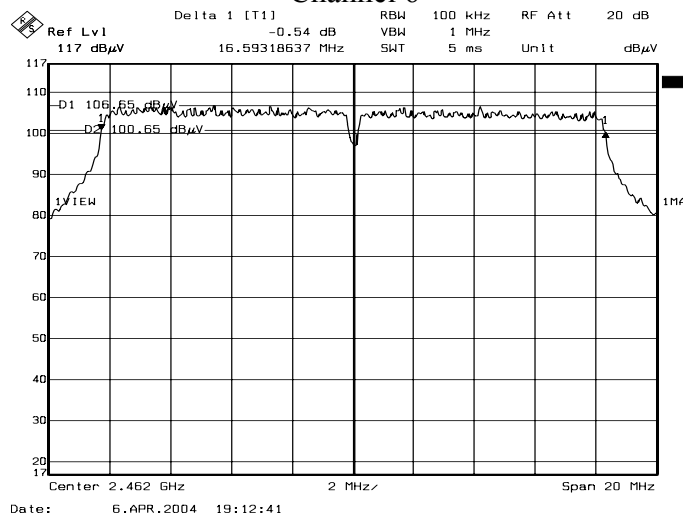

Channel 11

Note: For 802.11g mode

5. MAXIMUM PEAK OUTPUT POWER

5.1 Test Equipments

| Description & Manufacturer | Model No. | Serial No. | Date Of Calibration |
|-----------------------------------|-----------|-------------|---------------------|
| ROHDE & SCHWARZ SPECTRUM ANALYZER | FSEK30 | 835253/002 | JUN. 17, 2003 |
| HP ATTENUATOR | 8496B | 3247A18505 | Cal. on use |
| HP PLOTTER | 7750A | 725A 852141 | N/A |
| GIGASTRONICS POWER METER | 8542 | 1828329 | SEPT.19, 2003 |

Note : 1. The measurement uncertainty is less than +/- 2.6dB, which is calculated as per the NAMAS document NIS81.

2. The calibration interval of the above test instruments is 12 months and the calibrations are traceable to NML/ROC and NIST/USA.

5.2 Test Setup

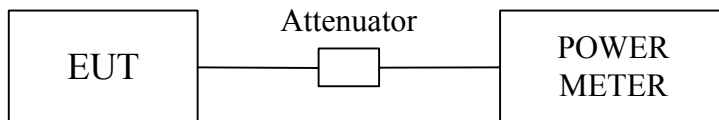

5.3 Limits of Maximum Peak Output Power

The Maximum Peak Output Power Measurement is 30dBm.



5.4 Test Procedure

The RF power output was measured with a Power meter connected to the RF Antenna connector (conducted measurement) while EUT was operating in transmit mode at the appropriate center frequency.

5.5 Uncertainty of Conducted Emission

The uncertainty of conducted emission is $\pm 1.82\text{dB}$.

5.6 Test Results

| | | | |
|-----------------------------|-------------------|---------------------------------|------------------|
| Input Power (System) | 5VDC (From PC) | Environmental Conditions | 22.1°C, 80%RH |
| Tested By | Stan Peng | | |

| Channel | Channel Frequency (MHz) | Peak Power Output (dBm) | Peak Power Limit (dBm) | Pass / Fail |
|---------|-------------------------|-------------------------|------------------------|-------------|
| 1 | 2412 | 19.84 | 30 | PASS |
| 6 | 2437 | 19.86 | 30 | PASS |
| 11 | 2462 | 19.30 | 30 | PASS |

- Note : 1. For 802.11b mode.
 2. At final test to get the worst-case emission at 11Mbps.
 3. The results are calculated as the following equation :
 Peak Power Output = Peak Power Reading + Cable loss + Attenuator

| Channel | Channel Frequency (MHz) | Peak Power Output (dBm) | Peak Power Limit (dBm) | Pass / Fail |
|---------|-------------------------|-------------------------|------------------------|-------------|
| 1 | 2412 | 15.64 | 30 | PASS |
| 6 | 2437 | 15.97 | 30 | PASS |
| 11 | 2462 | 15.38 | 30 | PASS |

- Note : 1. For 802.11g mode.
 2. At final test to get the worst-case emission at 54Mbps.
 3. The results are calculated as the following equation :
 Peak Power Output = Peak Power Reading + Cable loss + Attenuator



6. POWER SPECTRAL DENSITY MEASUREMENT

6.1 Test Equipments

| Description & Manufacturer | Model No. | Serial No. | Date Of Calibration |
|-----------------------------------|-----------|-------------|---------------------|
| ROHDE & SCHWARZ SPECTRUM ANALYZER | FSEK30 | 835253/002 | JUN. 17, 2003 |
| HP ATTENUATOR | 8496B | 3247A18505 | Cal. on use |
| HP PLOTTER | 7750A | 725A 852141 | N/A |

- Note : 1. The measurement uncertainty is less than +/- 2.6dB, which is calculated as per the NAMAS document NIS81.
2. The calibration interval of the above test instruments is 12 months and the calibrations are traceable to NML/ROC and NIST/USA.

6.2 Test Setup

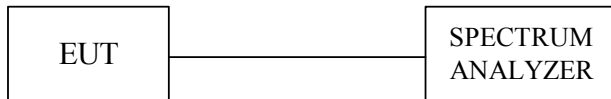

6.3 Limits of Power Spectral Density Measurement

The Maximum Power Spectral Density Measurement is 8dBm/3KHz.



6.4 Test Procedure

The transmitter output was connected to the spectrum analyzer through an attenuator, the bandwidth of the fundamental frequency was measured with the spectrum analyzer using 3KHz RBW and 30KHz VBW, set sweep time=span / 3KHz.

The power spectral density was measured and recorded.

The sweep time is allowed to be longer than span / 3KHz for a full response of the mixer in the spectrum analyzer.

6.5 Uncertainty of Conducted Emission

The uncertainty of conducted emission is ± 1.82 dB.

6.6 Test Results

| | | | |
|-----------------------------|-------------------|---------------------------------|------------------|
| Input Power (System) | 5VDC (From PC) | Environmental Conditions | 22.1°C, 80%RH |
| Tested By | Stan Peng | | |

| Channel | Channel Frequency (MHz) | Final RF Power Level in 3KHz BW (dBm) | Maxmum Limit (dBm) | Pass / Fail |
|---------|-------------------------|---------------------------------------|--------------------|-------------|
| 1 | 2412 | -8.13 | 8 | PASS |
| 6 | 2437 | -7.53 | 8 | PASS |
| 11 | 2462 | -8.28 | 8 | PASS |

Note: For 11Mbps (802.11b mode) at finial test to get the worst-case emission at 11Mbps.

| Channel | Channel Frequency (MHz) | Final RF Power Level in 3KHz BW (dBm) | Maxmum Limit (dBm) | Pass / Fail |
|---------|-------------------------|---------------------------------------|--------------------|-------------|
| 1 | 2412 | -16.40 | 8 | PASS |
| 6 | 2437 | -15.39 | 8 | PASS |
| 11 | 2462 | -16.17 | 8 | PASS |

Note: For 54Mbps (802.11g mode) at finial test to get the worst-case emission at 54Mbps.



6.7 Photo of Power Spectral Density Measurement

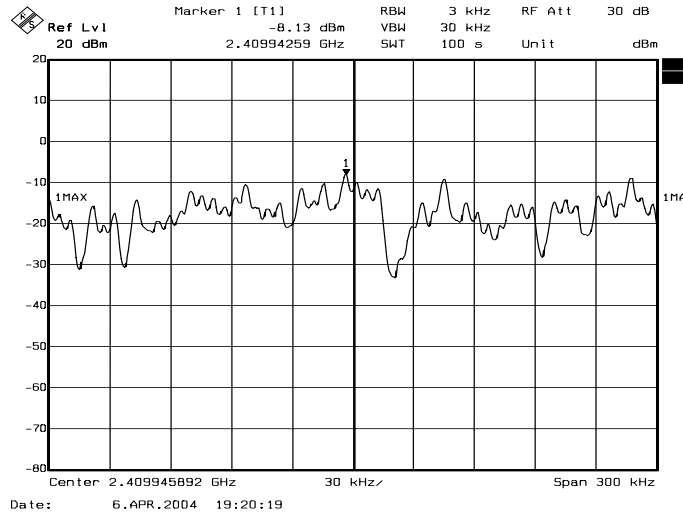

Channel 1

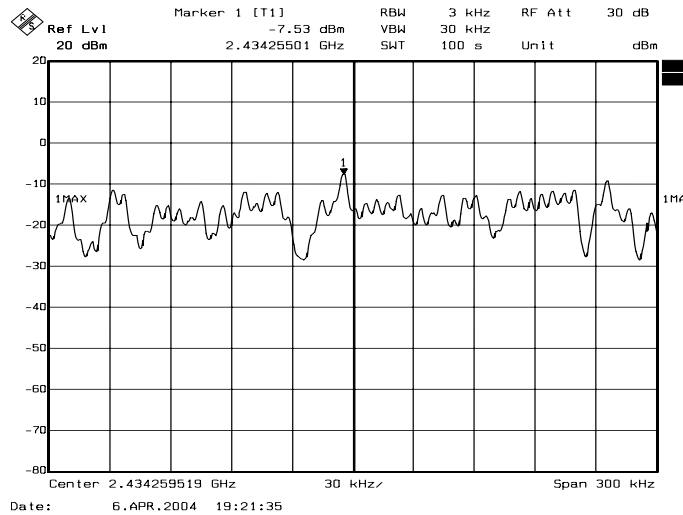

Channel 6

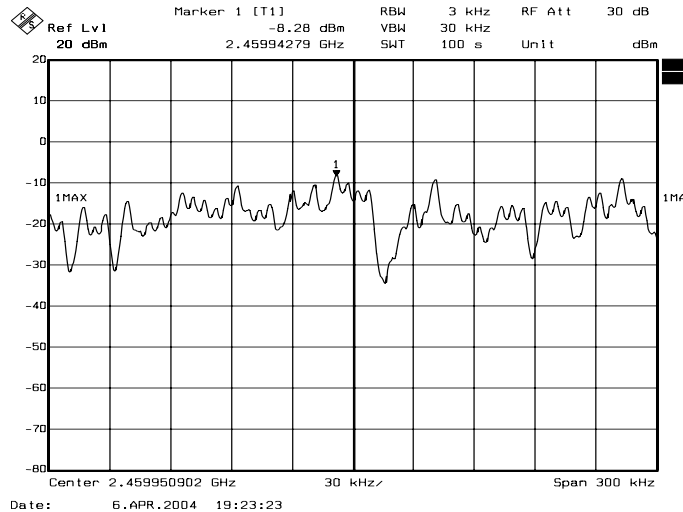

Channel 11

Note: For 802.11b mode



Ecom Sertech Corp.

Rm. 258, Bldg. 17, NO.195, Sec. 4 Chung Hsing Rd., ChuTung Chen, Hsinchu, Taiwan 310, R.O.C
TEL:886-3-5918012 FAX: 886-3-5825720

FCC ID : JCK-GN-WPKG
Report No. : ER04-04-003FRF
Page 54 of 64

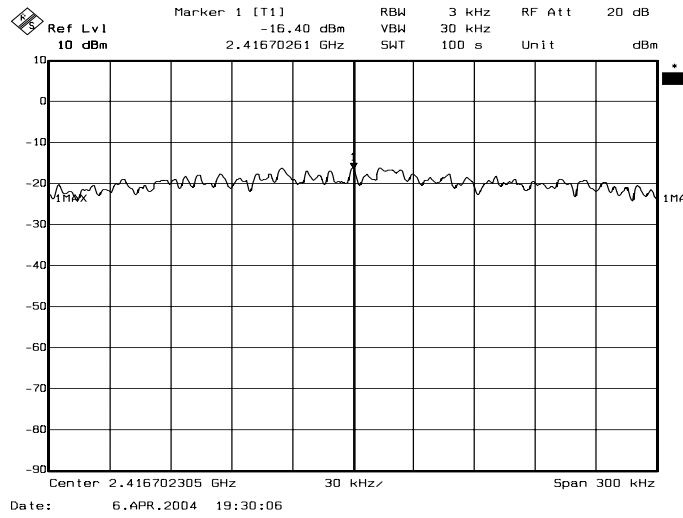

Channel 1

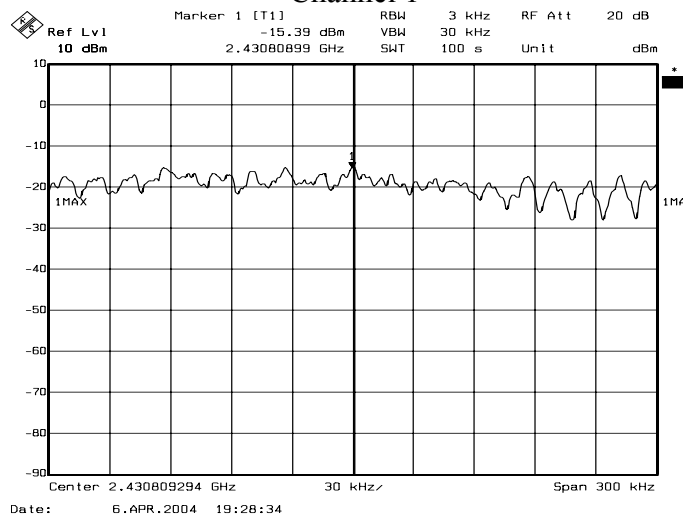

Channel 6

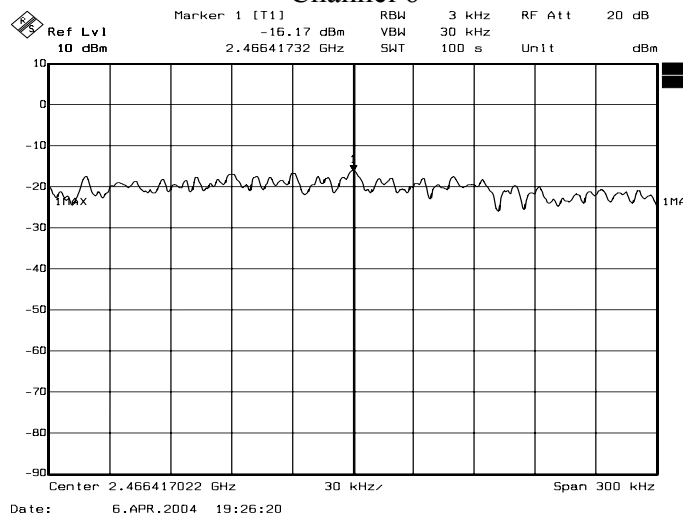

Channel 11

Note: For 802.11g mode

7. BAND EDGE MEASUREMENT

7.1 Test Equipments

| Description & Manufacturer | Model No. | Serial No. | Date Of Calibration |
|-----------------------------------|-----------|-------------|---------------------|
| ROHDE & SCHWARZ SPECTRUM ANALYZER | FSEK30 | 835253/002 | JUN. 17, 2003 |
| HP ATTENUATOR | 8496B | 3247A18505 | Cal. on use |
| HP PLOTTER | 7750A | 725A 852141 | N/A |

- Note : 1. The measurement uncertainty is less than +/- 2.6dB, which is calculated as per the NAMAS document NIS81.
 2. The calibration interval of the above test instruments is 12 months and the calibrations are traceable to NML/ROC and NIST/USA.

7.2 Test Setup

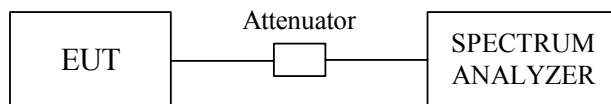

7.3 Limits of Band Edge Emissions Measurement

1. Below -20dB of the highest emission level of operating band.
2. Fall in the restricted bands listed in section 15.205. The maximum permitted average field strength is listed in section 15.209.



7.4 Test Procedure

The transmitter output was connected to the spectrum analyzer via a low lose cable. Set both RBW and VBW of spectrum analyzer with suitable frequency span including 100KHz bandwidth from band edge. The band edges was measured and recorded.

7.5 Uncertainty of Conducted Emission

The uncertainty of conducted emission is ± 1.82 dB.

7.6 Test Results

A. Conducted

Refer to 7.7 photo of band edge Emission measurement

B. Radiated

Refer to the section 3.6, the measured radiated band edge emissions are listed below :

| | | | |
|-----------------------------|-------------------|---------------------------------|----------------|
| Input Power (System) | 5VDC (From PC) | Environmental Conditions | 22.1°C , 80%RH |
| Tested By | Stan Peng | | |

For 802.11b mode

| Band edge | | Measured radiated band edge field strength (dBuV/m) | | Radiated band edge field strength limit (dBuV/m) | | Test result |
|----------------|-----|---|----------|--|----------|-------------|
| | | Horizontal | Vertical | Horizontal | Vertical | |
| 2399.90 | PK | 66.54 | 71.75 | 91.54 | 96.75 | pass |
| | AVG | 56.19 | 61.46 | 84.68 | 89.95 | |
| 2483.50 | PK | 56.78 | 61.28 | 74.00 | 74.00 | pass |
| | AVG | 44.42 | 48.66 | 54.00 | 54.00 | |

- Note :
1. Radiated band edge field strength is measured with mark-delta method.
 2. Measured radiated band edge field strength Test Results = Radiated fundamental emission field strength - DELTA.
 3. DELTA = Relative measurement between conducted measured peak level of fundamental emission and relevant band edge emission. Please refer to 7.7 photo of band edge Measurement.

**Ecom Sertech Corp.**

Rm. 258, Bldg. 17, NO.195, Sec. 4 Chung Hsing Rd., ChuTung Chen, Hsinchu, Taiwan 310, R.O.C
 TEL:886-3-5918012 FAX: 886-3-5825720

FCC ID : JCK-GN-WPKG
 Report No. : ER04-04-003FRF
 Page 57 of 64

Refer to the section 3.6, the measured radiated band edge emissions are listed below :

| | | | |
|-----------------------------|-------------------|---------------------------------|---------------|
| Input Power (System) | 5VDC (From PC) | Environmental Conditions | 22.1°C, 80%RH |
| Tested By | Stan Peng | | |

For 802.11g mode

| Band edge | | Measured radiated band edge field strength (dBuV/m) | | Radiated band edge field strength limit (dBuV/m) | | Test result |
|----------------|-----|---|----------|--|----------|-------------|
| | | Horizontal | Vertical | Horizontal | Vertical | |
| 2399.90 | PK | 71.39 | 74.51 | 90.03 | 93.15 | pass |
| | AVG | 54.97 | 58.15 | 80.22 | 83.40 | |
| 2483.50 | PK | 58.57 | 61.69 | 74.00 | 74.00 | pass |
| | AVG | 46.30 | 49.37 | 54.00 | 54.00 | |

- Note :
1. Radiated band edge field strength is measured with mark-delta method.
 2. Measured radiated band edge field strength Test Results = Radiated fundamental emission field strength - DELTA.
 3. DELTA = Relative measurement between conducted measured peak level of fundamental emission and relevant band edge emission. Please refer to 7.7 photo of band edge Measurement.



7.7 Photo of Band edge Measurement

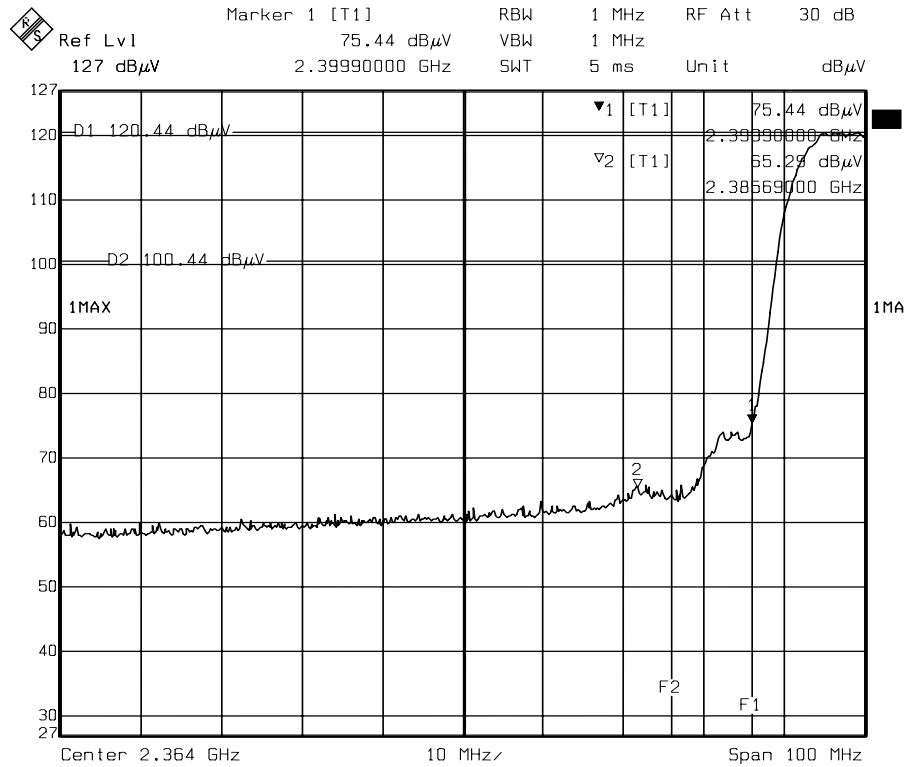

Date: 20.MAR.2004 20:38:27

Lower Band edge (Peak)

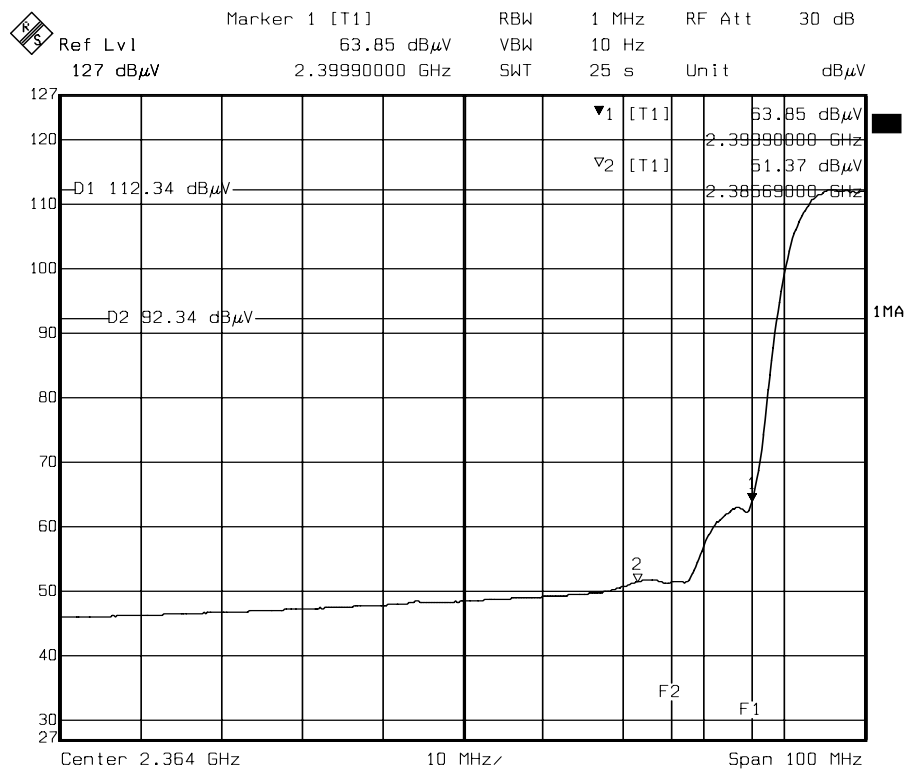

Date: 20.MAR.2004 20:41:40

Lower Band edge (Average)

Note: For 802.11b mode



Ecom Sertech Corp.

Rm. 258, Bldg. 17, NO.195, Sec. 4 Chung Hsing Rd., ChuTung Chen, Hsinchu, Taiwan 310, R.O.C
 TEL:886-3-5918012 FAX: 886-3-5825720

FCC ID : JCK-GN-WPKG
 Report No. : ER04-04-003FRF
 Page 59 of 64

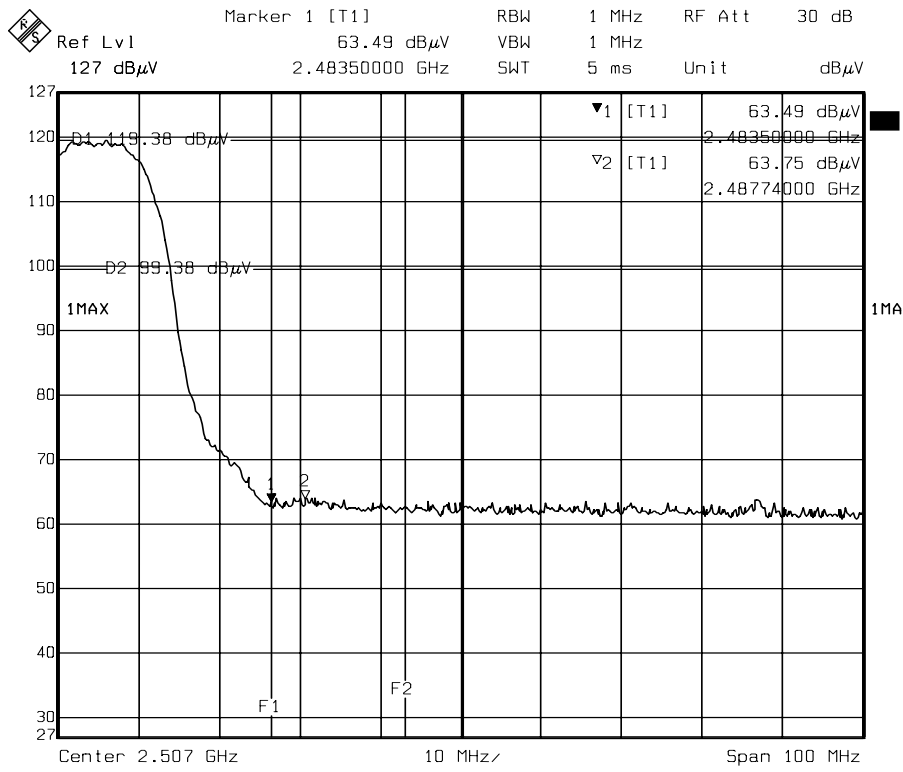

Date: 20.MAR.2004 21:03:49

Higher Band edge (Peak)

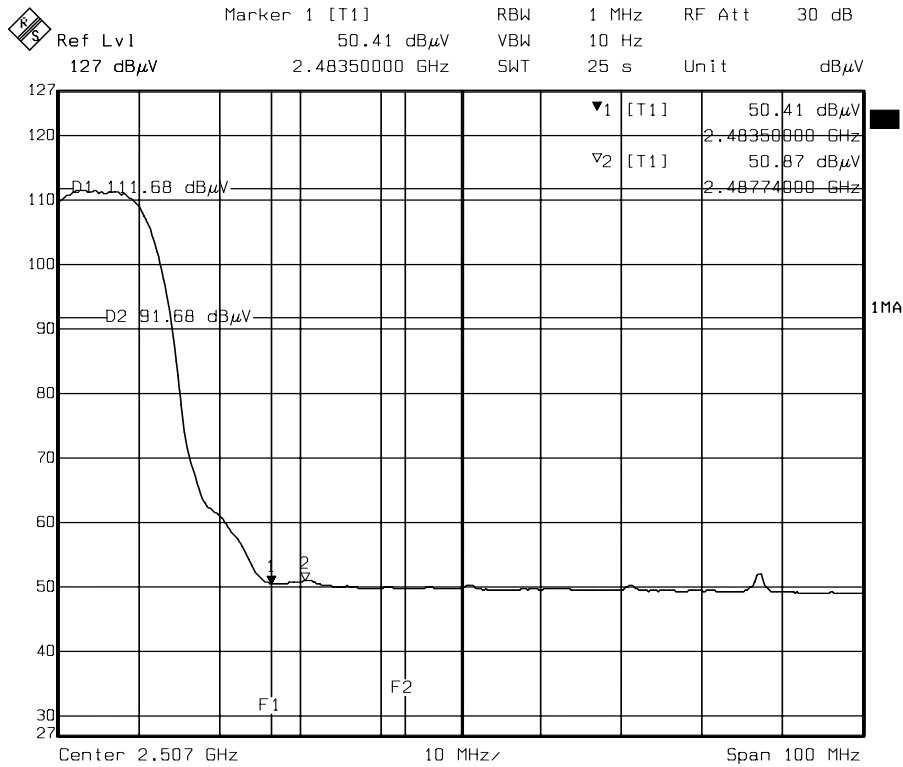

Date: 20.MAR.2004 21:06:01

Higher Band edge (Average)

Note: For 802.11b mode



Ecom Sertech Corp.

Rm. 258, Bldg. 17, NO.195, Sec. 4 Chung Hsing Rd., ChuTung Chen, Hsinchu, Taiwan 310, R.O.C
TEL:886-3-5918012 FAX: 886-3-5825720

FCC ID : JCK-GN-WPKG
Report No. : ER04-04-003FRF
Page 60 of 64

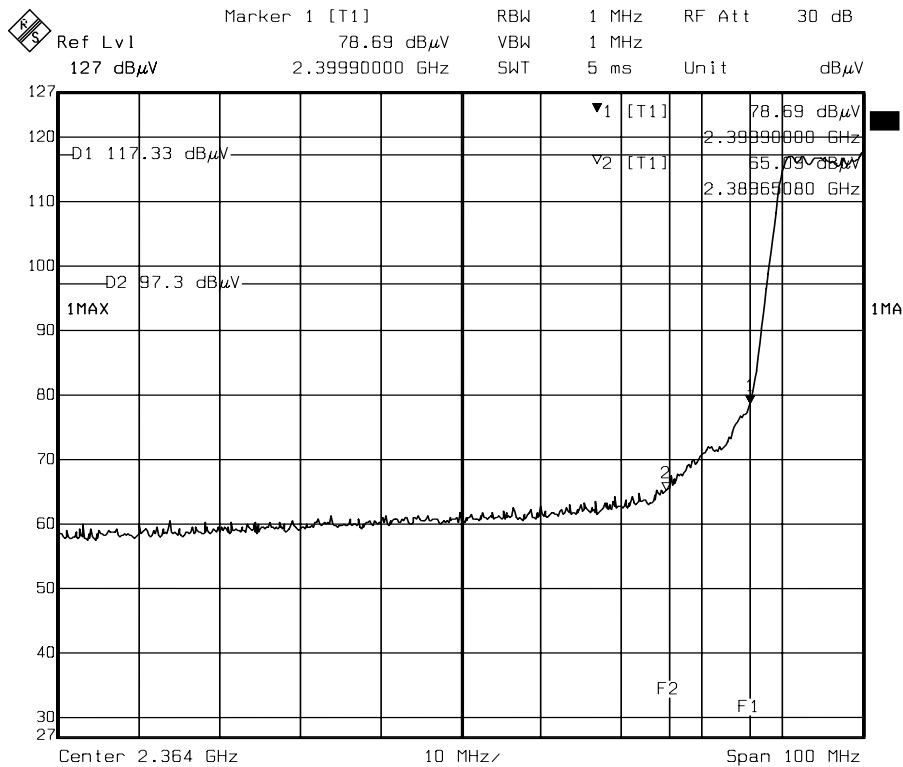

Date: 20.MAR.2004 20:50:39

Lower Band edge (Peak)

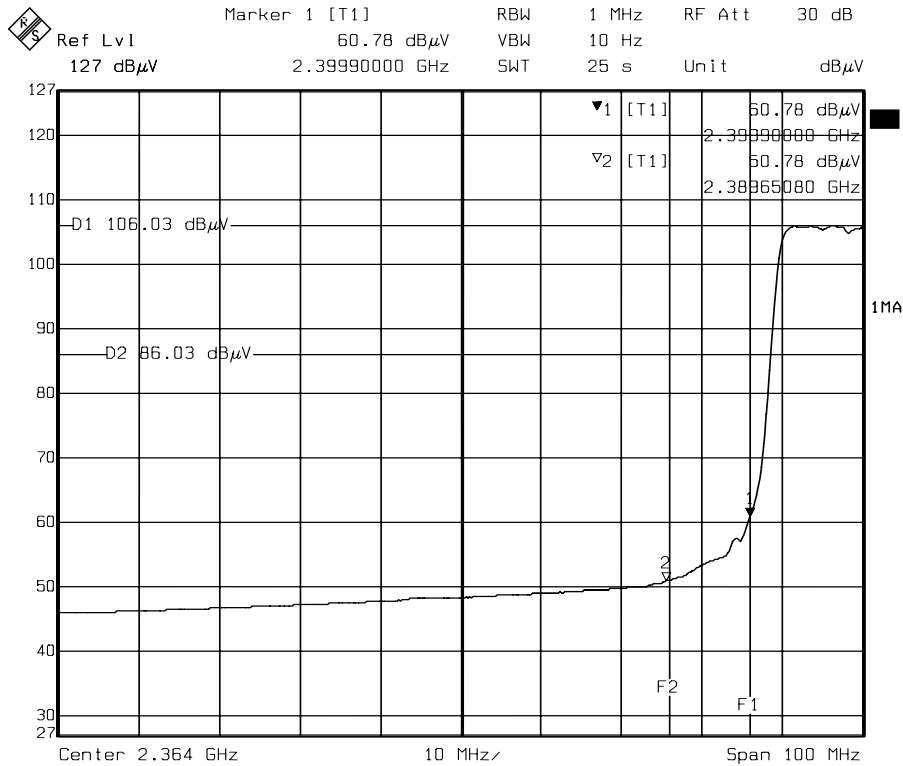

Date: 20.MAR.2004 20:54:23

Lower Band edge (Average)

Note: For 802.11g mode



Ecom Sertech Corp.

Rm. 258, Bldg. 17, NO.195, Sec. 4 Chung Hsing Rd., ChuTung Chen, Hsinchu, Taiwan 310, R.O.C
 TEL:886-3-5918012 FAX: 886-3-5825720

FCC ID : JCK-GN-WPKG
 Report No. : ER04-04-003FRF
 Page 61 of 64

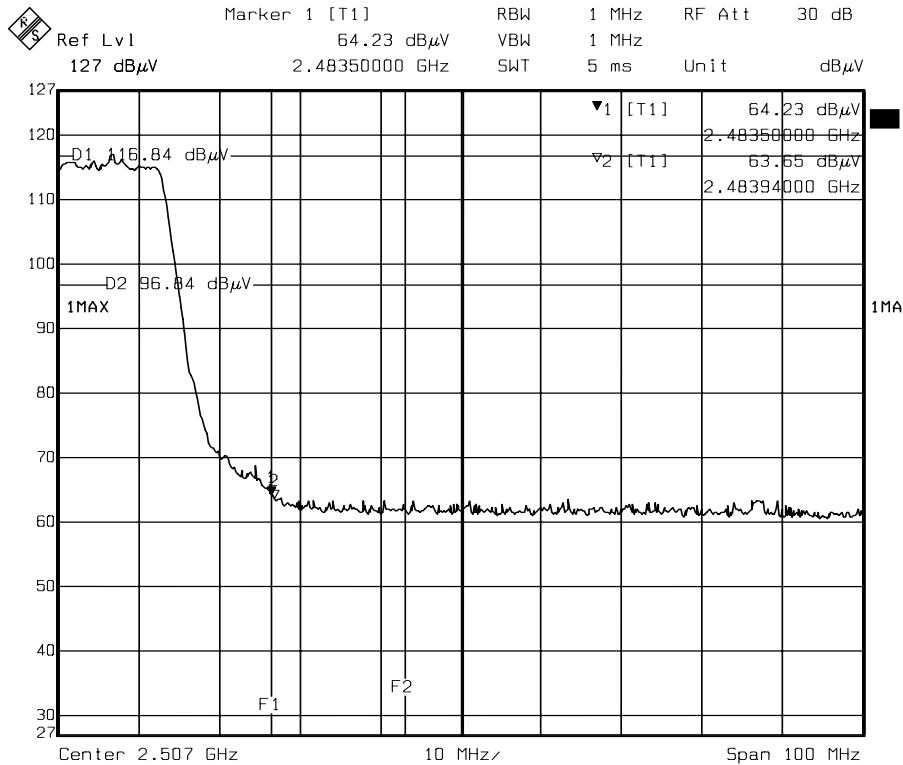

Date: 20.MAR.2004 20:57:39

Higher Band edge (Peak)

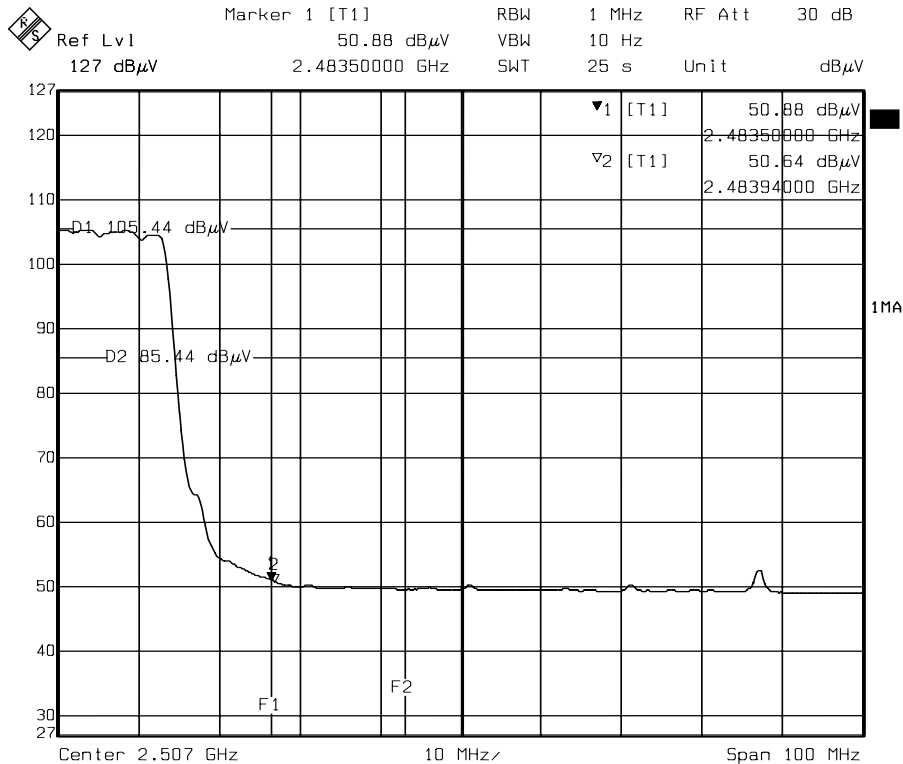

Date: 20.MAR.2004 20:59:48

Higher Band edge (Average)

Note: For 802.11g mode



8. ANTENNA REQUIREMENT

8.1 Standard Applicable

For intentional device, according to FCC 47 CFR Section 15.203, an intentional radiator shall be designed to ensure that no antenna other than that furnished by the responsible party shall be used with the device.

And according to FCC 47 CFR Section 15.247 (b), if transmitting antennas of directional gain greater than 6dBi are used, the power shall be reduced by the amount in dB that the directional gain of the antenna exceeds 6dBi.

8.2 Antenna Connected Construction

The antenna used in this product is Dipole antenna. The maximum Gain of this antenna is only 2dBi.



9. RF EXPOSURE EVALUATION

According to FCC 1.1310 : The criteria listed in the following table shall be used to evaluate the environment impact of human exposure to radio frequency (RF) radiation as specified in 1.1307(b)
LIMITS FOR MAXIMUM PERMISSIBLE EXPOSURE (MPE)

| Frequency Range (MHz) | Electric Field Strength (V/m) | Magnetic Field Strength (A/m) | Power Density (mW/cm ²) | Average Time |
|---|-------------------------------|-------------------------------|-------------------------------------|--------------|
| (A) Limits for Occupational / Control Exposures | | | | |
| 300-1,500 | -- | -- | F/300 | 6 |
| 1,500-100,000 | -- | -- | 5 | 6 |
| (B) Limits for General Population / Uncontrol Exposures | | | | |
| 300-1,500 | -- | -- | F/1500 | 6 |
| 1,500-100,000 | -- | -- | 1 | 30 |

9.1 Friis Formula

Friis transmission formula : $P_d = (P_{out} * G) / (4 * \pi * r^2)$

Where

P_d = power density in mW/cm²

P_{out} = output power to antenna in mW

G = gain of antenna in linear scale

π = 3.1416

r = distance between observation point and center of the radiator in cm

P_d is the limit of MPE, 1 mW/cm². If we know the maximum gain of the antenna and the total power input to the antenna, through the calculation, we will know the distance r where the MPE limit is reached.

9.2 EUT Operating Condition

A software provided by client enabled the EUT to transmit and receive data at lowest, middle and highest channel individually.



9.3 Test Result of RF Exposure Evaluation

Test Item : RF Exposure Evaluation Data
Test Mode : Normal Operation

9.3.1 Antenna Gain

Antenna Gain : The maximum Gain measured in fully anechoic chamber is 2dBi linear scale.

9.3.2 Output Power into Antenna & RF Exposure Evaluation Distance

| Channel | Channel Frequency (MHz) | Output Power to Antenna (dBm) | Power Density at 20cm (mW/cm ²) | LIMITS (mW/cm ²) |
|---------|-------------------------|-------------------------------|---|------------------------------|
| CH1 | 2412.00 | 19.84 | 0.030390 | 1 |
| CH6 | 2437.00 | 19.86 | 0.030530 | 1 |
| CH11 | 2462.00 | 19.30 | 0.026837 | 1 |

Note : 1. For Antenna 802.11b Mode (11Mbps).
2. The power density Pd (4th column) at a distance of 20cm calculated from the Friis transmission formula is far below the limit of 1 mW/cm² . The EUT is classified as mobile product. So, RF exposure limit warning or SAR test are not required.

| Channel | Channel Frequency (MHz) | Output Power to Antenna (dBm) | Power Density at 20cm (mW/cm ²) | LIMITS (mW/cm ²) |
|---------|-------------------------|-------------------------------|---|------------------------------|
| CH1 | 2412.00 | 15.64 | 0.011554 | 1 |
| CH6 | 2437.00 | 15.97 | 0.012466 | 1 |
| CH11 | 2462.00 | 15.38 | 0.010883 | 1 |

Note : 1. For Antenna 802.11g Mode (54Mbps).
2. The power density Pd (4th column) at a distance of 20cm calculated from the Friis transmission formula is far below the limit of 1 mW/cm² . The EUT is classified as mobile product. So, RF exposure limit warning or SAR test are not required.