



# FCC TEST REPORT

**REPORT NO.:** RF921011R04  
**MODEL NO.:** GN-WLBZ201  
**RECEIVED:** Oct. 11, 2003  
**TESTED:** Oct. 18 ~ Oct. 22, 2003

**APPLICANT:** GIGA-BYTE TECHNOLOGY CO., LTD.

**ADDRESS:** No. 6, Bau Chiang Road, Hsin-Tien, Taipei  
Hsien, Taiwan, R.O.C.

**ISSUED BY:** Advance Data Technology Corporation

**LAB LOCATION:** 47 14th Lin, Chiapau Tsun, Linko, Taipei,  
Taiwan, R.O.C.

This test report consists of 48 pages in total. It may be duplicated completely for legal use with the approval of the applicant. It should not be reproduced except in full, without the written approval of our laboratory. The client should not use it to claim product endorsement by CNLA, NVLAP or any government agencies. The test results in the report only apply to the tested sample.



0528  
ILAC MRA



Lab Code: 200102-0



## Table of Contents

1	CERTIFICATION .....	4
2	SUMMARY OF TEST RESULTS .....	5
3	GENERAL INFORMATION.....	6
3.1	GENERAL DESCRIPTION OF EUT .....	6
3.2	DESCRIPTION OF TEST MODES .....	7
3.3	GENERAL DESCRIPTION OF APPLIED STANDARDS .....	7
3.4	DESCRIPTION OF SUPPORT UNITS .....	8
3.5	CONFIGURATION OF SYSTEM UNDER TEST .....	8
4	TEST TYPES AND RESULTS .....	9
4.1	CONDUCTED EMISSION MEASUREMENT .....	9
4.1.1	LIMITS OF CONDUCTED EMISSION MEASUREMENT .....	9
4.1.2	TEST INSTRUMENTS .....	9
4.1.3	TEST PROCEDURES .....	10
4.1.4	DEVIATION FROM TEST STANDARD .....	10
4.1.5	TEST SETUP .....	11
4.1.6	EUT OPERATING CONDITIONS .....	11
4.1.7	TEST RESULTS .....	12
4.2	RADIATED EMISSION MEASUREMENT .....	18
4.2.1	LIMITS OF RADIATED EMISSION MEASUREMENT .....	18
4.2.2	TEST INSTRUMENTS .....	19
4.2.3	TEST PROCEDURES .....	20
4.2.4	DEVIATION FROM TEST STANDARD .....	20
4.2.5	TEST SETUP .....	21
4.2.6	EUT OPERATING CONDITIONS .....	21
4.2.7	TEST RESULTS .....	22
4.3	6dB BANDWIDTH MEASUREMENT.....	26
4.3.1	LIMITS OF 6dB BANDWIDTH MEASUREMENT .....	26
4.3.2	TEST INSTRUMENTS .....	26
4.3.3	TEST PROCEDURE .....	27
4.3.4	DEVIATION FROM TEST STANDARD .....	27
4.3.5	TEST SETUP .....	27
4.3.6	EUT OPERATING CONDITIONS .....	27



4.3.7 TEST RESULTS ..... 28

4.4 MAXIMUM PEAK OUTPUT POWER ..... 32

4.4.1 LIMITS OF MAXIMUM PEAK OUTPUT POWER MEASUREMENT ..... 32

4.4.2 TEST INSTRUMENTS ..... 32

4.4.3 TEST PROCEDURES ..... 33

4.4.4 DEVIATION FROM TEST STANDARD ..... 33

4.4.5 TEST SETUP ..... 33

4.4.6 EUT OPERATING CONDITIONS ..... 33

4.4.7 TEST RESULTS ..... 34

4.5 POWER SPECTRAL DENSITY MEASUREMENT ..... 35

4.5.1 LIMITS OF POWER SPECTRAL DENSITY MEASUREMENT ..... 35

4.5.2 TEST INSTRUMENTS ..... 35

4.5.3 TEST PROCEDURE ..... 36

4.5.4 DEVIATION FROM TEST STANDARD ..... 36

4.5.5 TEST SETUP ..... 36

4.5.6 EUT OPERATING CONDITIONS ..... 36

4.5.7 TEST RESULTS ..... 37

4.6 BAND EDGES MEASUREMENT ..... 41

4.6.1 LIMITS OF BAND EDGES MEASUREMENT ..... 41

4.6.2 TEST INSTRUMENTS ..... 41

4.6.3 TEST PROCEDURE ..... 41

4.6.4 DEVIATION FROM TEST STANDARD ..... 41

4.6.5 EUT OPERATING CONDITION ..... 42

4.6.6 TEST RESULTS ..... 42

4.7 ANTENNA REQUIREMENT ..... 45

4.7.1 STANDARD APPLICABLE ..... 45

4.7.2 ANTENNA CONNECTED CONSTRUCTION ..... 45

5 PHOTOGRAPHS OF THE TEST CONFIGURATION ..... 46

6 INFORMATION ON THE TESTING LABORATORIES ..... 48



## 1 CERTIFICATION

**PRODUCT :** IEEE 802.11b USB STICK Storage / Wireless LAN Card  
**MODEL NO.:** GN-WLBZ201  
**BRAND:** GIGABYTE  
**APPLICANT :** GIGA-BYTE TECHNOLOGY CO., LTD.  
**TEST ITEM:** R&D SAMPLE  
**STANDARDS :** 47 CFR Part 15, Subpart C (Section 15.247), ANSI C63.4-1992

We, **Advance Data Technology Corporation**, hereby certify that one sample of the designation has been tested in our facility from Oct. 18 to Oct. 22, 2003. The test record, data evaluation and Equipment Under Test (EUT) configurations represented herein are true and accurate accounts of the measurements of the sample's EMC characteristics under the conditions herein specified.

**PREPARED BY:** Landy Soong, **DATE:** Oct. 28, 2003  
Landy Soong

**APPROVED BY:** Ellis Wu, **DATE:** Oct. 28, 2003  
Ellis Wu /  
Technical Manager



## 2 SUMMARY OF TEST RESULTS

The EUT has been tested according to the following specifications:

<b>APPLIED STANDARD: 47 CFR Part 15, Subpart C</b>			
<b>Standard Section</b>	<b>Test Type and Limit</b>	<b>Result</b>	<b>REMARK</b>
15.207	AC Power Conducted Emission	PASS	Meet the requirement of limit Minimum passing margin is -12.56dB at 0.173MHz
15.247(a)(2)	Spectrum Bandwidth of a Direct Sequence Spread Spectrum System Limit : min. 500kHz	PASS	Meet the requirement of limit
15.247(b)	Maximum Peak Output Power Limit: max. 30dBm	PASS	Meet the requirement of limit
15.247(c)	Transmitter Radiated Emissions Limit: Table 15.209	PASS	Meet the requirement of limit Minimum passing margin is -7.0dB at 2390.00MHz
15.247(d)	Power Spectral Density Limit: max. 8dBm	PASS	Meet the requirement of limit
15.247(c)	Band Edge Measurement Limit: 20 dB less than the peak value of fundamental frequency	PASS	Meet the requirement of limit

**NOTE:** The information of measurement uncertainty is available upon the customer's request.



### 3 GENERAL INFORMATION

#### 3.1 GENERAL DESCRIPTION OF EUT

<b>PRODUCT</b>	IEEE 802.11b USB STICK Storage / Wireless LAN Card
<b>MODEL NO.</b>	GN-WLBZ201
<b>POWER SUPPLY</b>	5VDC from host equipment
<b>MODULATION TYPE</b>	BPSK, QPSK, CCK
<b>MODULATION TECHNOLOGY</b>	DSSS
<b>TRANSFER RATE</b>	1/2/5.5/11Mbps
<b>FREQUENCY RANGE</b>	2412MHz ~ 2462MHz
<b>NUMBER OF CHANNEL</b>	11
<b>OUTPUT POWER</b>	15.0dBm
<b>ANTENNA TYPE</b>	Patch antenna with 0dBi gain
<b>DATA CABLE</b>	NA
<b>I/O PORTS</b>	USB
<b>ASSOCIATED DEVICES</b>	NA

**NOTE:** For a more detailed features description, please refer to the manufacturer's specifications or User's Manual.



### 3.2 DESCRIPTION OF TEST MODES

Eleven channels are provided to this EUT.

Channel	Frequency	Channel	Frequency
1	2412 MHz	7	2442 MHz
2	2417 MHz	8	2447 MHz
3	2422 MHz	9	2452 MHz
4	2427 MHz	10	2457 MHz
5	2432 MHz	11	2462 MHz
6	2437 MHz		

**NOTE:**

1. Below 1GHz, the channel 1, 6, and 11 were pre-tested in chamber. The channel 11, worst case one, was chosen for final test.
2. Above 1GHz, the channel 1, 6, and 11 were tested individually.
3. Data rate with 11Mbps, the worst case, was chosen for final test.
4. Antenna in the vertical position, the worst case was chosen for final test.

### 3.3 GENERAL DESCRIPTION OF APPLIED STANDARDS

The EUT is a IEEE 802.11b USB STICK Storage / Wireless LAN Card. According to the specifications of the manufacturer, it must comply with the requirements of the following standards:

**FCC 47 CFR Part 15, Subpart C. (15.247)**  
**ANSI C63.4: 1992**

All tests have been performed and recorded as per the above standards.

**NOTE:** The EUT is also considered as a kind of computer peripheral, because the connection to computer is necessary for typical use. It has been verified to comply with the requirements of FCC Part 15, Subpart B, Class B (DoC). The test report has been issued separately.



### 3.4 DESCRIPTION OF SUPPORT UNITS

The EUT has been tested as an independent unit together with other necessary accessories or support units. The following support units or accessories were used to form a representative test configuration during the tests.

NO.	PRODUCT	BRAND	MODEL NO.	SERIAL NO.	FCC ID
1	NOTEBOOK	COMPAQ	N800C	470048-515	FCC DoC Approved
2	PRINTER	EPSON	LQ-300+	DCGY017057	FCC DoC Approved

NO.	SIGNAL CABLE DESCRIPTION OF THE ABOVE SUPPORT UNITS
1	NA
2	1.2m braid shielded wire, terminated with DB25 and Centronics connector via metallic frame, w/o core

**NOTE:** All power cords of the above support units are non shielded (1.8m).

### 3.5 CONFIGURATION OF SYSTEM UNDER TEST

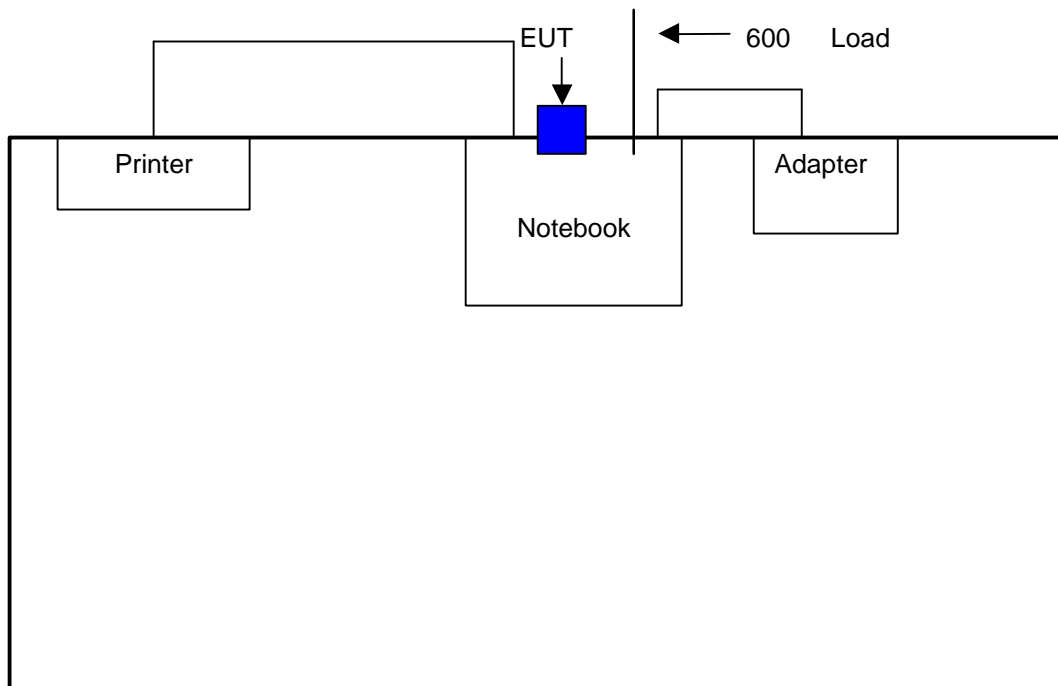





## 4 TEST TYPES AND RESULTS

### 4.1 CONDUCTED EMISSION MEASUREMENT

#### 4.1.1 LIMITS OF CONDUCTED EMISSION MEASUREMENT

FREQUENCY OF EMISSION (MHz)	CONDUCTED LIMIT (dB $\mu$ V)	
	Quasi-peak	Average
0.15-0.5	66 to 56	56 to 46
0.5-5	56	46
5-30	60	50

- NOTE:**
1. The lower limit shall apply at the transition frequencies.
  2. The limit decreases in line with the logarithm of the frequency in the range of 0.15 to 0.50 MHz.
  3. All emanations from a class A/B digital device or system, including any network of conductors and apparatus connected thereto, shall not exceed the level of field strengths specified above.

#### 4.1.2 TEST INSTRUMENTS

DESCRIPTION & MANUFACTURER	MODEL NO.	SERIAL NO.	CALIBRATED UNTIL
ROHDE & SCHWARZ Test Receiver	ESCS 30	838251/021	Jan. 20, 2004
ROHDE & SCHWARZ Artificial Mains Network (for EUT)	ESH3-Z5	100218	Dec. 18, 2003
ROHDE & SCHWARZ Artificial Mains Network (for peripherals)	ESH3-Z5	100219	Dec. 18, 2003
ROHDE & SCHWARZ Artificial Mains Network (for peripherals)	ESH3-Z5	100220	Dec. 18, 2003
ROHDE & SCHWARZ 4-wire ISN	ENY41	837032/016	Nov. 29 2003
ROHDE & SCHWARZ 2-wire ISN	ENY22	837497/016	Nov. 29 2003
Software	Cond-V2M3	NA	NA
RF cable (JYEBAO)	5D-FB	Cable-C10.01	May 01, 2004
SUHNER Terminator (For ROHDE & SCHWARZ LISN)	65BNC-5001	E1-010770	Mar. 24, 2004
SUHNER Terminator (For ROHDE & SCHWARZ LISN)	65BNC-5001	E1-010773	Apr. 06, 2004

- NOTE:**
1. The calibration interval of the above test instruments is 12 months and the calibrations are traceable to NML/ROC and NIST/USA.
  2. “\*”: These equipment are used for conducted telecom port test only (if tested).
  3. The test was performed in ADT Shielded Room No. 10.
  4. The VCCI Site Registration No. is C-1312.



#### 4.1.3 TEST PROCEDURES

- a. The EUT was placed 0.4 meters from the conducting wall of the shielded room with EUT being connected to the power mains through a line impedance stabilization network (LISN). Other support units were connected to the power mains through another LISN. The two LISNs provide 50 ohm/ 50uH of coupling impedance for the measuring instrument.
- b. Both lines of the power mains connected to the EUT were checked for maximum conducted interference.
- c. The frequency range from 150kHz to 30MHz was searched. Emission levels over 10dB under the prescribed limits could not be reported

#### 4.1.4 DEVIATION FROM TEST STANDARD

No deviation

#### 4.1.5 TEST SETUP

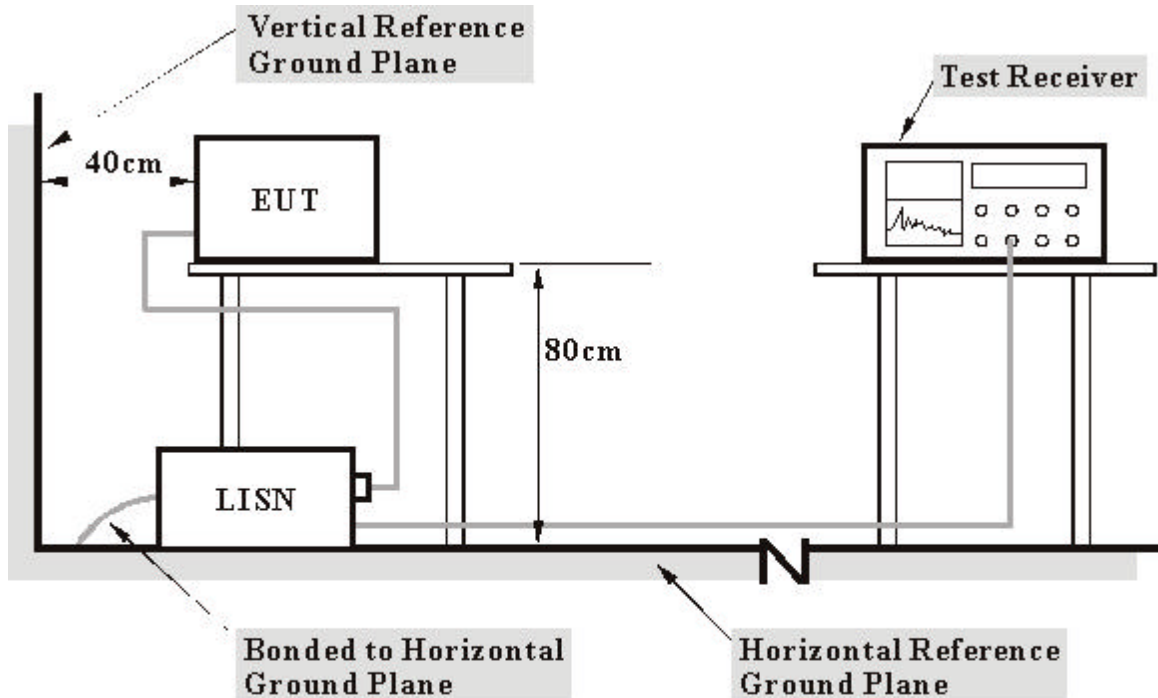

- Note:**
1. Support units were connected to second LISN.
  2. Both of LISNs (AMN) 80 cm from EUT and at the least 80 cm from other units and other metal planes support units.

For the actual test configuration, please refer to the related item – Photographs of the Test Configuration.

#### 4.1.6 EUT OPERATING CONDITIONS

- a. Plug the EUT a notebook computer system placed on a testing table.
- b. The computer system ran a test program to enable EUT under transmission/receiving condition continuously at specific channel frequency.
- c. The computer system sent "H" messages to its screen.
- d. The computer system sent "H" messages to modem.
- e. The computer system sent "H" messages to printer, and the printer prints them on paper.



4.1.7 TEST RESULTS

<b>EUT</b>	IEEE 802.11b USB STICK Storage / Wireless LAN Card	<b>MODEL</b>	GN-WLBZ201
<b>MODE</b>	Channel 1	<b>6dB BANDWIDTH</b>	9kHz
<b>INPUT POWER (SYSTEM)</b>	120Vac, 60 Hz	<b>PHASE</b>	Line (L)
<b>ENVIRONMENTAL CONDITIONS</b>	30deg. C, 60%RH, 991hPa	<b>TESTED BY:</b> Hardway Lee	

No	Freq. [MHz]	Corr. Factor (dB)	Reading Value [dB (uV)]		Emission Level [dB (uV)]		Limit [dB (uV)]		Margin (dB)	
			Q.P.	AV.	Q.P.	AV.	Q.P.	AV.	Q.P.	AV.
			1	0.173	0.06	52.18	-	52.24	-	64.79
2	0.232	0.06	46.15	-	46.21	-	62.38	52.38	-16.17	-
3	0.345	0.06	37.05	-	37.11	-	59.07	49.07	-21.96	-
4	3.406	0.21	25.46	-	25.67	-	56.00	46.00	-30.33	-
5	13.672	0.52	23.63	-	24.15	-	60.00	50.00	-35.85	-
6	19.406	0.63	30.02	-	30.65	-	60.00	50.00	-29.35	-

- REMARKS:**
1. Q.P. and AV. are abbreviations of quasi-peak and average individually.
  2. "-": The Quasi-peak reading value also meets average limit and measurement with the average detector is unnecessary.
  3. The emission levels of other frequencies were very low against the limit.
  4. Margin value = Emission level - Limit value
  5. Correction factor = Insertion loss + Cable loss
  6. Emission Level = Correction Factor + Reading Value.

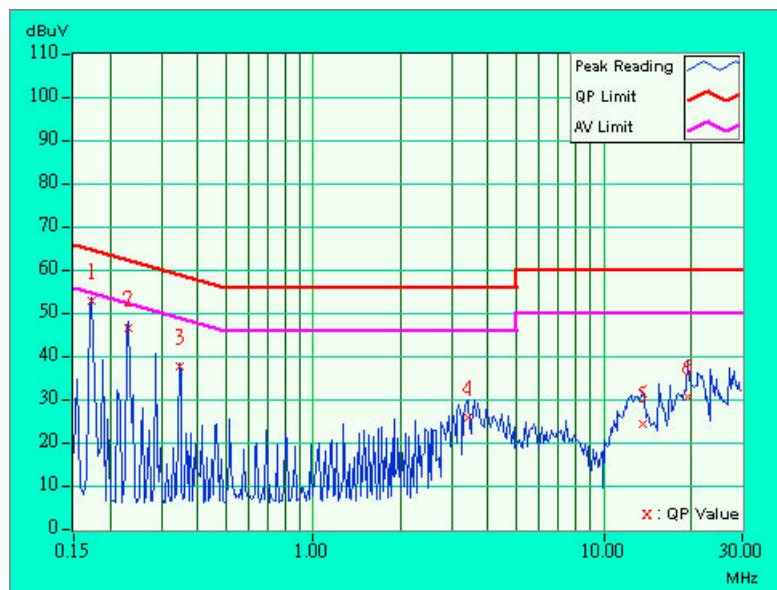



<b>EUT</b>	IEEE 802.11b USB STICK Storage / Wireless LAN Card	<b>MODEL</b>	GN-WLBZ201
<b>MODE</b>	Channel 1	<b>6dB BANDWIDTH</b>	9kHz
<b>INPUT POWER (SYSTEM)</b>	120Vac, 60 Hz	<b>PHASE</b>	Neutral (N)
<b>ENVIRONMENTAL CONDITIONS</b>	30deg. C, 60%RH, 991hPa	<b>TESTED BY:</b> Hardway Lee	

No	Freq. [MHz]	Corr. Factor (dB)	Reading Value		Emission Level		Limit		Margin	
			[dB (uV)]		[dB (uV)]		[dB (uV)]		(dB)	
			Q.P.	AV.	Q.P.	AV.	Q.P.	AV.	Q.P.	AV.
1	0.173	0.05	50.55	-	50.60	-	64.79	54.79	-14.19	-
2	0.232	0.05	44.84	-	44.89	-	62.38	52.38	-17.49	-
3	0.291	0.05	37.90	-	37.95	-	60.51	50.51	-22.56	-
4	3.996	0.21	33.75	-	33.96	-	56.00	46.00	-22.04	-
5	11.980	0.43	22.40	-	22.83	-	60.00	50.00	-37.17	-
6	20.113	0.51	30.01	-	30.52	-	60.00	50.00	-29.48	-

- REMARKS:**
1. Q.P. and AV. are abbreviations of quasi-peak and average individually.
  2. "-": The Quasi-peak reading value also meets average limit and measurement with the average detector is unnecessary.
  3. The emission levels of other frequencies were very low against the limit.
  4. Margin value = Emission level - Limit value
  5. Correction factor = Insertion loss + Cable loss
  6. Emission Level = Correction Factor + Reading Value.

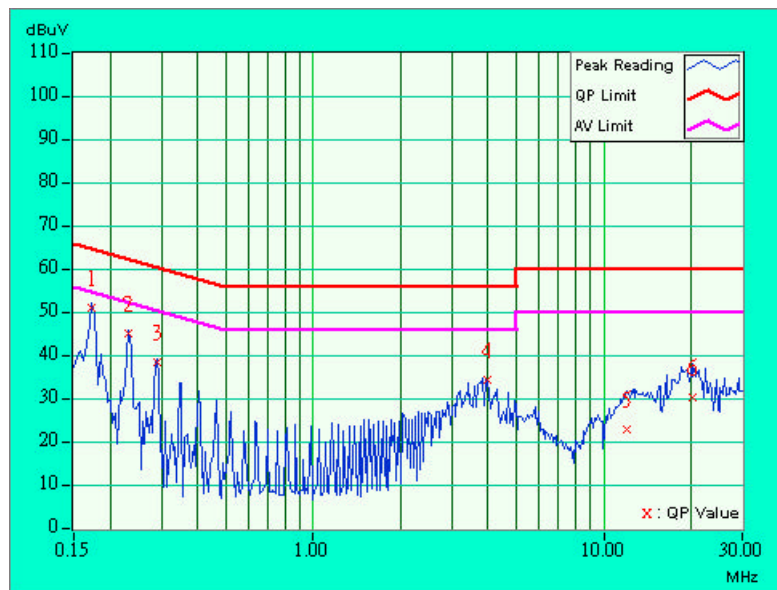



<b>EUT</b>	IEEE 802.11b USB STICK Storage / Wireless LAN Card	<b>MODEL</b>	GN-WLBZ201
<b>MODE</b>	Channel 6	<b>6dB BANDWIDTH</b>	9kHz
<b>INPUT POWER (SYSTEM)</b>	120Vac, 60 Hz	<b>PHASE</b>	Line (L)
<b>ENVIRONMENTAL CONDITIONS</b>	30deg. C, 60%RH, 991hPa	<b>TESTED BY:</b> Hardway Lee	

No	Freq. [MHz]	Corr. Factor (dB)	Reading Value		Emission Level		Limit		Margin	
			[dB (uV)]		[dB (uV)]		[dB (uV)]		(dB)	
			Q.P.	AV.	Q.P.	AV.	Q.P.	AV.	Q.P.	AV.
1	0.177	0.06	48.54	-	48.60	-	64.61	54.61	-16.01	-
2	0.236	0.06	41.63	-	41.69	-	62.24	52.24	-20.55	-
3	0.291	0.06	39.08	-	39.14	-	60.51	50.51	-21.37	-
4	3.842	0.22	30.42	-	30.64	-	56.00	46.00	-25.36	-
5	13.797	0.52	25.18	-	25.70	-	60.00	50.00	-34.30	-
6	19.797	0.64	29.37	-	30.01	-	60.00	50.00	-29.99	-

- REMARKS:**
1. Q.P. and AV. are abbreviations of quasi-peak and average individually.
  2. "-": The Quasi-peak reading value also meets average limit and measurement with the average detector is unnecessary.
  3. The emission levels of other frequencies were very low against the limit.
  4. Margin value = Emission level - Limit value
  5. Correction factor = Insertion loss + Cable loss
  6. Emission Level = Correction Factor + Reading Value.

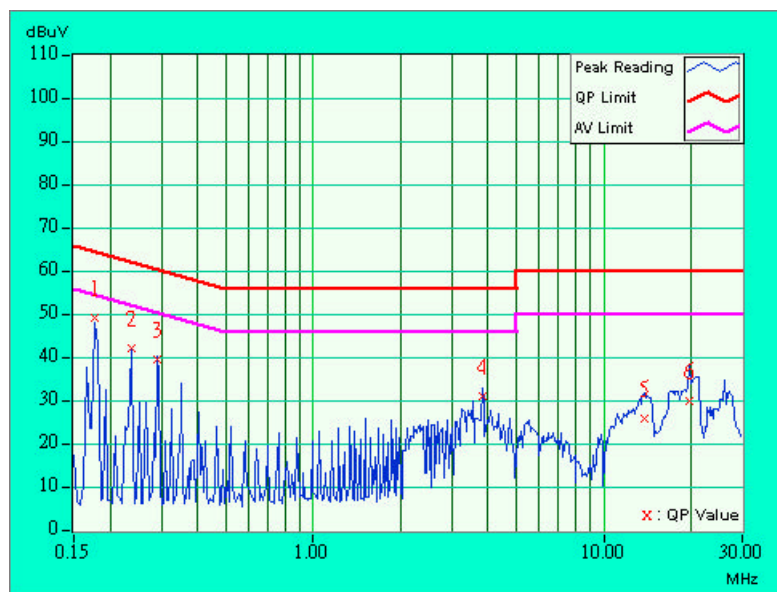



<b>EUT</b>	IEEE 802.11b USB STICK Storage / Wireless LAN Card	<b>MODEL</b>	GN-WLBZ201
<b>MODE</b>	Channel 6	<b>6dB BANDWIDTH</b>	9kHz
<b>INPUT POWER (SYSTEM)</b>	120Vac, 60 Hz	<b>PHASE</b>	Neutral (N)
<b>ENVIRONMENTAL CONDITIONS</b>	30deg. C, 60%RH, 991hPa	<b>TESTED BY:</b> Hardway Lee	

No	Freq. [MHz]	Corr. Factor (dB)	Reading Value		Emission Level		Limit		Margin	
			[dB (uV)]		[dB (uV)]		[dB (uV)]		(dB)	
			Q.P.	AV.	Q.P.	AV.	Q.P.	AV.	Q.P.	AV.
1	0.177	0.05	46.96	-	47.01	-	64.61	54.61	-17.60	-
2	0.236	0.05	38.28	-	38.33	-	62.24	52.24	-23.91	-
3	0.295	0.05	34.37	-	34.42	-	60.40	50.40	-25.98	-
4	3.844	0.20	32.89	-	33.09	-	56.00	46.00	-22.91	-
5	14.574	0.48	25.89	-	26.37	-	60.00	50.00	-33.63	-
6	27.535	0.72	23.51	-	24.23	-	60.00	50.00	-35.77	-

- REMARKS:**
1. Q.P. and AV. are abbreviations of quasi-peak and average individually.
  2. "-": The Quasi-peak reading value also meets average limit and measurement with the average detector is unnecessary.
  3. The emission levels of other frequencies were very low against the limit.
  4. Margin value = Emission level - Limit value
  5. Correction factor = Insertion loss + Cable loss
  6. Emission Level = Correction Factor + Reading Value.

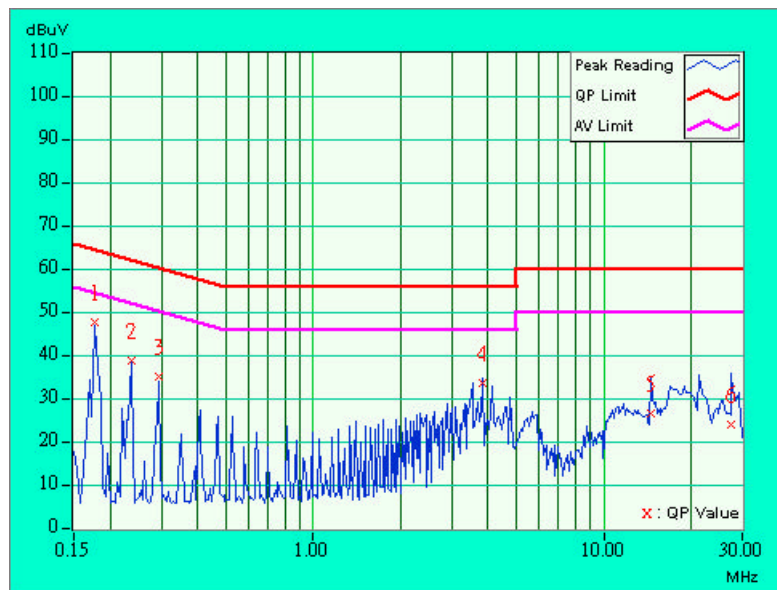



<b>EUT</b>	IEEE 802.11b USB STICK Storage / Wireless LAN Card	<b>MODEL</b>	GN-WLBZ201
<b>MODE</b>	Channel 11	<b>6dB BANDWIDTH</b>	9kHz
<b>INPUT POWER (SYSTEM)</b>	120Vac, 60 Hz	<b>PHASE</b>	Line (L)
<b>ENVIRONMENTAL CONDITIONS</b>	30deg. C, 60%RH, 991hPa	<b>TESTED BY:</b> Hardway Lee	

No	Freq. [MHz]	Corr. Factor (dB)	Reading Value		Emission Level		Limit		Margin	
			[dB (uV)]		[dB (uV)]		[dB (uV)]		(dB)	
			Q.P.	AV.	Q.P.	AV.	Q.P.	AV.	Q.P.	AV.
1	0.173	0.06	50.08	-	50.14	-	64.79	54.79	-14.66	-
2	0.232	0.06	42.98	-	43.04	-	62.38	52.38	-19.34	-
3	0.349	0.06	34.52	-	34.58	-	58.98	48.98	-24.40	-
4	3.887	0.22	17.46	-	17.68	-	56.00	46.00	-38.32	-
5	18.648	0.62	29.43	-	30.05	-	60.00	50.00	-29.95	-
6	21.621	0.72	25.20	-	25.92	-	60.00	50.00	-34.08	-

- REMARKS:**
1. Q.P. and AV. are abbreviations of quasi-peak and average individually.
  2. "-": The Quasi-peak reading value also meets average limit and measurement with the average detector is unnecessary.
  3. The emission levels of other frequencies were very low against the limit.
  4. Margin value = Emission level - Limit value
  5. Correction factor = Insertion loss + Cable loss
  6. Emission Level = Correction Factor + Reading Value.

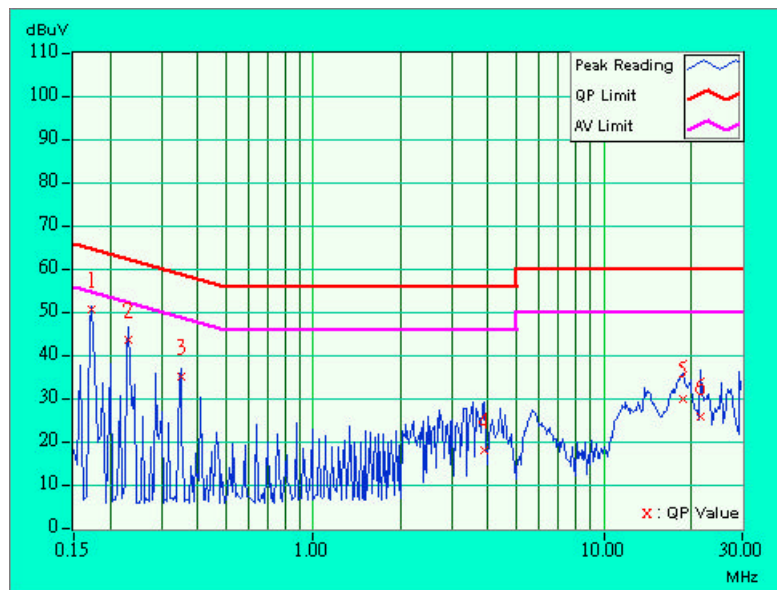





<b>EUT</b>	IEEE 802.11b USB STICK Storage / Wireless LAN Card	<b>MODEL</b>	GN-WLBZ201
<b>MODE</b>	Channel 11	<b>6dB BANDWIDTH</b>	9kHz
<b>INPUT POWER (SYSTEM)</b>	120Vac, 60 Hz	<b>PHASE</b>	Neutral (N)
<b>ENVIRONMENTAL CONDITIONS</b>	30deg. C, 60%RH, 991hPa	<b>TESTED BY:</b> Hardway Lee	

No	Freq. [MHz]	Corr. Factor (dB)	Reading Value		Emission Level		Limit		Margin	
			[dB (uV)]		[dB (uV)]		[dB (uV)]		(dB)	
			Q.P.	AV.	Q.P.	AV.	Q.P.	AV.	Q.P.	AV.
1	0.170	0.05	44.40	-	44.45	-	64.98	54.98	-20.53	-
2	0.236	0.05	41.06	-	41.11	-	62.24	52.24	-21.13	-
3	0.287	0.05	35.00	-	35.05	-	60.62	50.62	-25.57	-
4	3.887	0.21	32.03	-	32.24	-	56.00	46.00	-23.76	-
5	18.672	0.50	29.63	-	30.13	-	60.00	50.00	-29.87	-
6	21.305	0.57	29.97	-	30.54	-	60.00	50.00	-29.46	-

- REMARKS:**
1. Q.P. and AV. are abbreviations of quasi-peak and average individually.
  2. "-": The Quasi-peak reading value also meets average limit and measurement with the average detector is unnecessary.
  3. The emission levels of other frequencies were very low against the limit.
  4. Margin value = Emission level - Limit value
  5. Correction factor = Insertion loss + Cable loss
  6. Emission Level = Correction Factor + Reading Value.

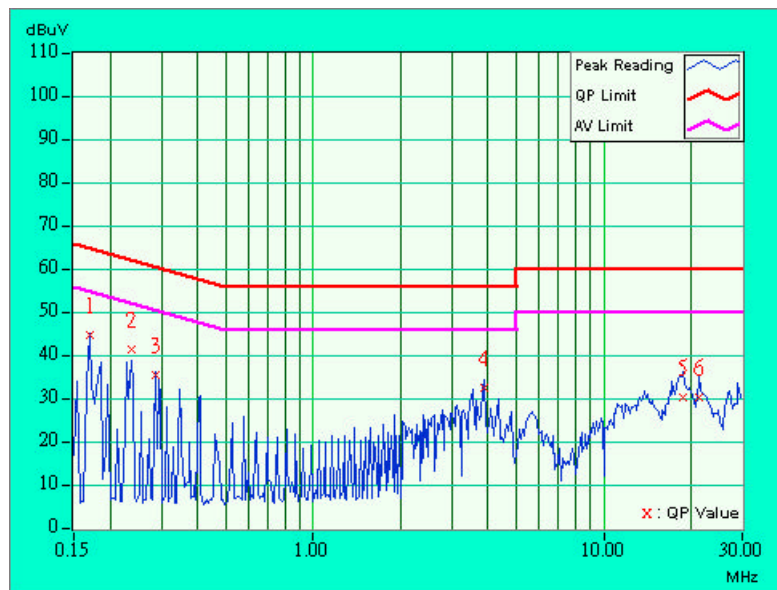



## 4.2 RADIATED EMISSION MEASUREMENT

### 4.2.1 LIMITS OF RADIATED EMISSION MEASUREMENT

Emissions radiated outside of the specified bands, shall be according to the general radiated limits in 15.209 as following:

Frequencies (MHz)	Field strength (microvolts/meter)	Measurement distance (meters)
0.009-0.490	2400/F(kHz)	300
0.490-1.705	24000/F(kHz)	30
1.705-30.0	30	30
30-88	100	3
88-216	150	3
216-960	200	3
Above 960	500	3

**NOTE:**

1. The lower limit shall apply at the transition frequencies.
2. Emission level (dBuV/m) = 20 log Emission level (uV/m).
3. As shown in 15.35(b), for frequencies above 1000MHz, the field strength limits are based on average detector, however, the peak field strength of any emission shall not exceed the maximum permitted average limits, specified above by more than 20dB under any condition of modulation.



## 4.2.2 TEST INSTRUMENTS

DESCRIPTION & MANUFACTURER	MODEL NO.	SERIAL NO.	CALIBRATED UNTIL
* HP Spectrum Analyzer	8590L	3544A01176	Jun. 10, 2004
* HP Preamplifier	8447D	2944A08485	May. 01, 2004
* HP Preamplifier	8449B	3008A01201	Dec. 01, 2003
* HP Preamplifier	8449B	3008A01292	Aug. 13, 2004
ROHDE & SCHWARZ TEST RECEIVER	ESI7	838496/016	Feb. 23, 2004
* ROHDE & SCHWARZ TEST RECEIVER	ESMI	839013/007 839379/002	Feb. 13, 2004
SCHAFFNER Tunable Dipole Antenna	VHBA 9123	459	Nov. 22, 2003
SCHWARZBECK Tunable Dipole Antenna	UHA 9105	977	
* CHASE BILOG Antenna	CBL6112A	2221	July 26, 2004
* SCHWARZBECK Horn Antenna	BBHA9120-D1	D130	Jun. 30, 2004
* EMCO Horn Antenna	3115	9312-4192	Mar. 23 2004
* EMCO Turn Table	1060	1115	NA
* CHANCE Tower	CM-AT40	CM-A010	NA
* Software	ADT_Radiated_V5.14	NA	NA
* ANRITSU RF Switches	MP59B	M35046	Jan. 05, 2004
* TIMES RF cable	LMR-600	CABLE-ST5-01	Jan. 05, 2004

**NOTE:** 1. The calibration interval of the above test instruments is 12 months. And the calibrations are traceable to NML/ROC and NIST/USA.

2. "\*" = These equipment are used for the final measurement.
3. The horn antenna and HP preamplifier (model: 8449B) are used only for the measurement of emission frequency above 1GHz if tested.
4. The test was performed in ADT Open Site No. 5.
5. The VCCI Site Registration No. is R-1039.



### 4.2.3 TEST PROCEDURES

- a. The EUT was placed on the top of a rotating table 0.8 meters above the ground at a 10 meter open area test site. The table was rotated 360 degrees to determine the position of the highest radiation.
- b. The EUT was set 3 meters away from the interference-receiving antenna, which was mounted on the top of a variable-height antenna tower.
- c. The antenna is a broadband antenna, and its height is varied from one meter to four meters above the ground to determine the maximum value of the field strength. Both horizontal and vertical polarizations of the antenna are set to make the measurement.
- d. For each suspected emission, the EUT was arranged to its worst case and then the antenna was tuned to heights from 1 meter to 4 meters and the rotatable table was turned from 0 degrees to 360 degrees to find the maximum reading.
- e. The test-receiver system was set to Peak Detect Function and Specified Bandwidth with Maximum Hold Mode.
- f. If the emission level of the EUT in peak mode was 10 dB lower than the limit specified, then testing could be stopped and the peak values of the EUT would be reported. Otherwise the emissions that did not have 10 dB margin would be re-tested one by one using peak, quasi-peak or average method as specified and then reported in a data sheet.

**NOTE:**

1. The resolution bandwidth and video bandwidth of test receiver/spectrum analyzer is 120kHz for Peak detection (PK) and Quasi-peak detection (QP) at frequency below 1GHz.
2. The resolution bandwidth and video bandwidth of test receiver/spectrum analyzer is 1 MHz for Peak detection at frequency above 1GHz.
3. The resolution bandwidth of test receiver/spectrum analyzer is 1 MHz and the video bandwidth is 300 Hz for Average detection (AV) at frequency above 1GHz.

### 4.2.4 DEVIATION FROM TEST STANDARD

No deviation

#### 4.2.5 TEST SETUP

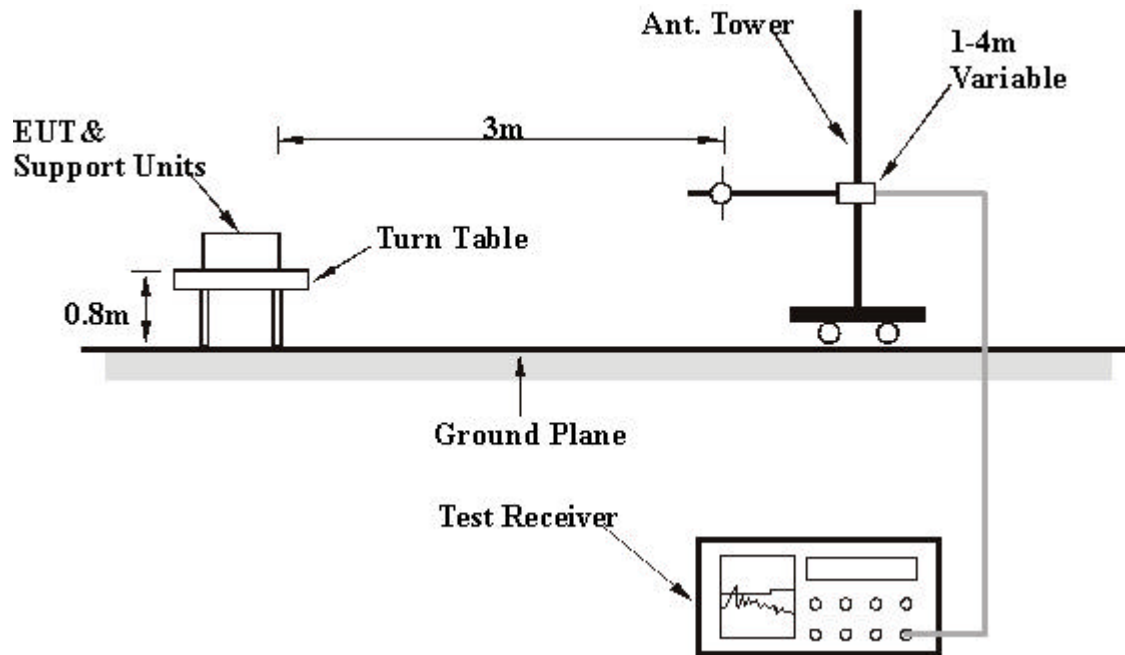

For the actual test configuration, please refer to the related item – Photographs of the Test Configuration.

#### 4.2.6 EUT OPERATING CONDITIONS

Same as 4.1.6



4.2.7. TEST RESULTS

<b>EUT</b>	IEEE 802.11b USB STICK Storage / Wireless LAN Card	<b>MODEL</b>	GN-WLBZ201
<b>MODE</b>	Channel 11	<b>FREQUENCY RANGE</b>	Below 1000MHz
<b>INPUT POWER (SYSTEM)</b>	120Vac, 60 Hz	<b>DETECTOR FUNCTION</b>	Quasi-Peak
<b>ENVIRONMENTAL CONDITIONS</b>	30 deg. C, 60 % RH, 991hPa	<b>TESTED BY:</b> Hardaway Lee	

**ANTENNA POLARITY & TEST DISTANCE: HORIZONTAL AT 3 M**

No.	Freq. (MHz)	Emission Level (dBuV/m)	Limit (dBuV/m)	Margin (dB)	Antenna Height (m)	Table Angle (Degree)	Raw Value (dBuV)	Correction Factor (dB/m)
1	240.00	30.70 QP	46.00	-15.30	1.04 H	319	17.60	13.00
2	280.00	29.00 QP	46.00	-17.00	1.66 H	218	13.70	15.30
3	363.00	21.10 QP	46.00	-24.90	1.40 H	27	4.20	16.90
4	396.00	29.80 QP	46.00	-16.20	1.32 H	209	11.70	18.10
5	433.52	28.00 QP	46.00	-18.00	1.18 H	305	9.30	18.70
6	542.25	28.80 QP	46.00	-17.20	1.33 H	236	8.00	20.70
7	720.00	30.10 QP	46.00	-15.90	1.27 H	73	7.00	23.20

**ANTENNA POLARITY & TEST DISTANCE: VERTICAL AT 3 M**

No.	Freq. (MHz)	Emission Level (dBuV/m)	Limit (dBuV/m)	Margin (dB)	Antenna Height (m)	Table Angle (Degree)	Raw Value (dBuV)	Correction Factor (dB/m)
1	199.99	26.40 QP	43.50	-17.10	1.19 V	359	15.60	10.80
2	225.01	34.30 QP	46.00	-11.70	1.56 V	286	22.20	12.20
3	240.01	30.20 QP	46.00	-15.80	1.29 V	25	17.20	13.00
4	280.01	28.20 QP	46.00	-17.80	1.07 V	1	12.80	15.30
5	396.03	29.60 QP	46.00	-16.40	1.46 V	359	11.50	18.10
6	432.01	28.40 QP	46.00	-17.60	1.98 V	83	9.80	18.60
7	443.55	25.80 QP	46.00	-20.20	2.25 V	236	7.00	18.80
8	458.64	23.90 QP	46.00	-22.10	1.00 V	122	4.80	19.10
9	542.35	23.70 QP	46.00	-22.30	1.00 V	19	3.00	20.70
10	720.00	33.50 QP	46.00	-12.50	1.94 V	132	10.30	23.20

- REMARKS:**
1. Emission level(dBuV/m)=Raw Value(dBuV) + Correction Factor(dB)
  2. Correction Factor(dB/m) = Antenna Factor (dB/m) + Cable Factor (dB)
  3. The other emission levels were very low against the limit.
  4. Margin value = Emission level – Limit value.



<b>EUT</b>	IEEE 802.11b USB STICK Storage / Wireless LAN Card	<b>MODEL</b>	GN-WLBZ201
<b>CHANNEL</b>	Channel 1	<b>FREQUENCY RANGE</b>	Above 1000MHz
<b>INPUT POWER (SYSTEM)</b>	120Vac, 60 Hz		
<b>ENVIRONMENTAL CONDITIONS</b>	30 deg. C, 60 % RH, 991hPa	<b>DETECTOR FUNCTION</b>	Peak (PK) Average (AV)
<b>TESTED BY</b>	Hardaway Lee		

<b>ANTENNA POLARITY &amp; TEST DISTANCE: HORIZONTAL AT 3 M</b>								
No.	Freq. (MHz)	Emission Level (dBuV/m)	Limit (dBuV/m)	Margin (dB)	Antenna Height (m)	Table Angle (Degree)	Raw Value (dBuV)	Correction Factor (dB/m)
1	2390.00	48.00 PK	74.00	-26.00	1.44 H	105	18.50	29.60
<b>1</b>	<b>2390.00</b>	<b>47.00 AV</b>	<b>54.00</b>	<b>-7.00</b>	<b>1.44 H</b>	<b>105</b>	<b>17.50</b>	<b>29.60</b>
2	*2412.00	102.20 PK			1.44 H	105	72.60	29.70
2	*2412.00	95.10 AV			1.44 H	105	65.40	29.70
3	4824.00	50.40 PK	74.00	-23.60	1.29 H	0	15.20	35.30

<b>ANTENNA POLARITY &amp; TEST DISTANCE: VERTICAL AT 3 M</b>								
No.	Freq. (MHz)	Emission Level (dBuV/m)	Limit (dBuV/m)	Margin (dB)	Antenna Height (m)	Table Angle (Degree)	Raw Value (dBuV)	Correction Factor (dB/m)
1	2390.00	53.10 PK	74.00	-20.90	1.15 V	20	23.60	29.60
1	2390.00	45.80 AV	54.00	-8.20	1.15 V	20	16.20	29.60
2	*2412.00	107.30 PK			1.15 V	20	77.60	29.70
2	*2412.00	100.00 AV			1.15 V	20	70.30	29.70
3	4824.00	50.40 PK	74.00	-23.60	1.00 V	320	15.20	35.30
4	9648.00	54.60 PK	74.00	-19.40	1.66 V	105	11.00	43.60
4	9648.00	41.20 AV	54.00	-12.80	1.66 V	105	-2.40	43.60

- REMARKS:**
1. Emission level(dBuV/m)=Raw Value(dBuV) + Correction Factor(dB)
  2. Correction Factor(dB/m) = Antenna Factor (dB/m) + Cable Factor (dB)
  3. The other emission levels were very low against the limit.
  4. Margin value = Emission level – Limit value.
  5. “ \* “ : Fundamental frequency.



<b>EUT</b>	IEEE 802.11b USB STICK Storage / Wireless LAN Card	<b>MODEL</b>	GN-WLBZ201
<b>CHANNEL</b>	Channel 6	<b>FREQUENCY RANGE</b>	Above 1000MHz
<b>INPUT POWER (SYSTEM)</b>	120Vac, 60 Hz		
<b>ENVIRONMENTAL CONDITIONS</b>	30 deg. C, 60 % RH, 991hPa	<b>DETECTOR FUNCTION</b>	Peak (PK) Average (AV)
<b>TESTED BY</b>	Hardaway Lee		

<b>ANTENNA POLARITY &amp; TEST DISTANCE: HORIZONTAL AT 3M</b>								
No.	Freq. (MHz)	Emission Level (dBuV/m)	Limit (dBuV/m)	Margin (dB)	Antenna Height (m)	Table Angle (Degree)	Raw Value (dBuV)	Correction Factor (dB/m)
1	*2437.00	104.40 PK			1.14 H	353	74.70	29.70
1	*2437.00	97.00 AV			1.14 H	353	67.20	29.70
2	4874.00	51.70 PK	74.00	-22.30	1.47 H	118	16.30	35.50

<b>ANTENNA POLARITY &amp; TEST DISTANCE: VERTICAL AT 3M</b>								
No.	Freq. (MHz)	Emission Level (dBuV/m)	Limit (dBuV/m)	Margin (dB)	Antenna Height (m)	Table Angle (Degree)	Raw Value (dBuV)	Correction Factor (dB/m)
1	*2437.00	106.70 PK			1.14 V	114	77.00	29.70
1	*2437.00	99.50 AV			1.14 V	114	69.80	29.70
2	4874.00	49.60 PK	74.00	-24.40	1.51 V	324	14.10	35.50
3	7311.00	55.10 PK	74.00	-18.90	1.08 V	208	13.80	41.30
3	7311.00	41.80 AV	54.00	-12.20	1.08 V	208	0.60	41.30

- REMARKS:**
1. Emission level(dBuV/m)=Raw Value(dBuV) + Correction Factor(dB)
  2. Correction Factor(dB/m) = Antenna Factor (dB/m) + Cable Factor (dB)
  3. The other emission levels were very low against the limit.
  4. Margin value = Emission level – Limit value.
  5. " \* " : Fundamental frequency.





<b>EUT</b>	IEEE 802.11b USB STICK Storage / Wireless LAN Card	<b>MODEL</b>	GN-WLBZ201
<b>CHANNEL</b>	Channel 11	<b>FREQUENCY RANGE</b>	Above 1000MHz
<b>INPUT POWER (SYSTEM)</b>	120Vac, 60 Hz		
<b>ENVIRONMENTAL CONDITIONS</b>	30 deg. C, 60 % RH, 991hPa	<b>DETECTOR FUNCTION</b>	Peak (PK) Average (AV)
<b>TESTED BY</b>	Hardaway Lee		

**ANTENNA POLARITY & TEST DISTANCE: HORIZONTAL AT 3M**

No.	Freq. (MHz)	Emission Level (dBuV/m)	Limit (dBuV/m)	Margin (dB)	Antenna Height (m)	Table Angle (Degree)	Raw Value (dBuV)	Correction Factor (dB/m)
1	*2462.00	104.30 PK			1.46 H	348	74.40	29.80
1	*2462.00	97.10 AV			1.46 H	348	67.30	29.80
2	2483.50	47.00 PK	74.00	-27.00	1.46 H	348	17.10	29.90
3	4924.00	50.70 PK	74.00	-23.30	1.08 H	154	15.00	35.70
4	7386.00	53.30 PK	74.00	-20.70	1.61 H	255	11.80	41.50
4	7386.00	42.80 AV	54.00	-11.20	1.61 H	255	1.30	41.50
5	9847.00	54.50 PK	74.00	-19.50	1.19 H	133	10.80	43.80
5	9847.00	42.90 AV	54.00	-11.10	1.19 H	133	-0.90	43.80

**ANTENNA POLARITY & TEST DISTANCE: VERTICAL AT 3M**

No.	Freq. (MHz)	Emission Level (dBuV/m)	Limit (dBuV/m)	Margin (dB)	Antenna Height (m)	Table Angle (Degree)	Raw Value (dBuV)	Correction Factor (dB/m)
1	*2462.00	105.50 PK			1.29 V	223	75.70	29.80
1	*2462.00	97.60 AV			1.29 V	223	67.80	29.80
2	2483.50	48.20 PK	74.00	-25.80	1.29 V	223	18.30	29.90
3	4921.00	49.00 PK	74.00	-25.00	1.52 V	200	13.30	35.70
4	7386.00	55.20 PK	74.00	-18.80	1.63 V	114	13.80	41.50
4	7386.00	42.50 AV	54.00	-11.50	1.63 V	114	1.10	41.50
5	9847.00	55.10 PK	74.00	-18.90	1.73 V	33	11.30	43.80
5	9847.00	44.80 AV	54.00	-9.20	1.73 V	33	1.10	43.80

- REMARKS:**
1. Emission level(dBuV/m)=Raw Value(dBuV) + Correction Factor(dB)
  2. Correction Factor(dB/m) = Antenna Factor (dB/m) + Cable Factor (dB)
  3. The other emission levels were very low against the limit.
  4. Margin value = Emission level – Limit value.
  5. “ \* “ : Fundamental frequency.



### 4.3 6dB BANDWIDTH MEASUREMENT

#### 4.3.1 LIMITS OF 6dB BANDWIDTH MEASUREMENT

The minimum of 6dB Bandwidth Measurement is 0.5 MHz.

#### 4.3.2 TEST INSTRUMENTS

Description & Manufacturer	Model No.	Serial No.	Calibrated Until
SPECTRUM ANALYZER	FSEK30	100049	Aug. 12, 2004

**NOTE:** The calibration interval of the above test instruments is 12 months and the calibrations are traceable to NML/ROC and NIST/USA.

#### 4.3.3 TEST PROCEDURE

The transmitter output was connected to the spectrum analyzer through an attenuator. The bandwidth of the fundamental frequency was measured by spectrum analyzer with 100 kHz RBW and 100kHz VBW. The 6dB bandwidth is defined as the total spectrum the power of which is higher than peak power minus 6dB.

#### 4.3.4 DEVIATION FROM TEST STANDARD

No deviation

#### 4.3.5 TEST SETUP

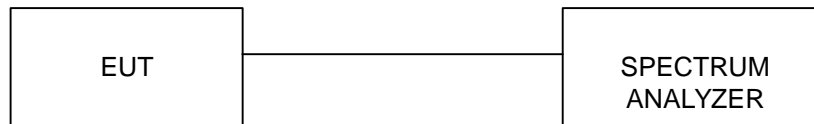

For the actual test configuration, please refer to the related Item – Photographs of the Test Configuration.

#### 4.3.6 EUT OPERATING CONDITIONS

The software provided by client to enable the EUT under transmission condition continuously at lowest, middle and highest channel frequencies individually.



## 4.3.7 TEST RESULTS

<b>EUT</b>	IEEE 802.11b USB STICK Storage / Wireless LAN Card	<b>MODEL</b>	GN-WLBZ201
<b>INPUT POWER (SYSTEM)</b>	120Vac, 60 Hz	<b>ENVIRONMENTAL CONDITIONS</b>	28deg. C, 60%RH, 991hPa
<b>TESTED BY:</b> Steven Lu			

<b>CHANNEL</b>	<b>CHANNEL FREQUENCY (MHz)</b>	<b>6dB BANDWIDTH (MHz)</b>	<b>MINIMUM LIMIT (MHz)</b>	<b>PASS/FAIL</b>
1	2412	11.12	0.5	PASS
6	2437	11.12	0.5	PASS
11	2462	11.12	0.5	PASS



CH1

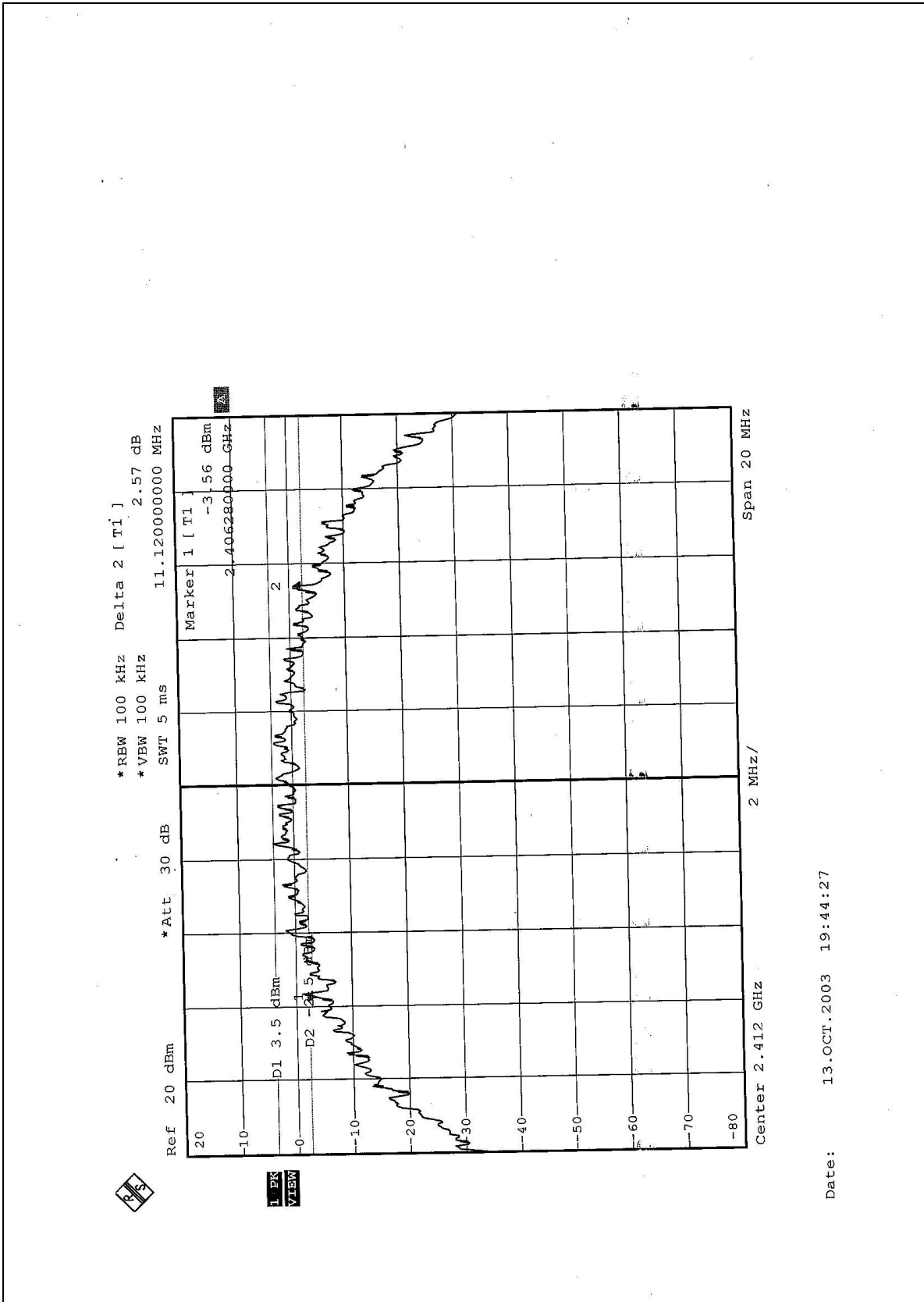

Date: 13.OCT.2003 19:44:27



CH6

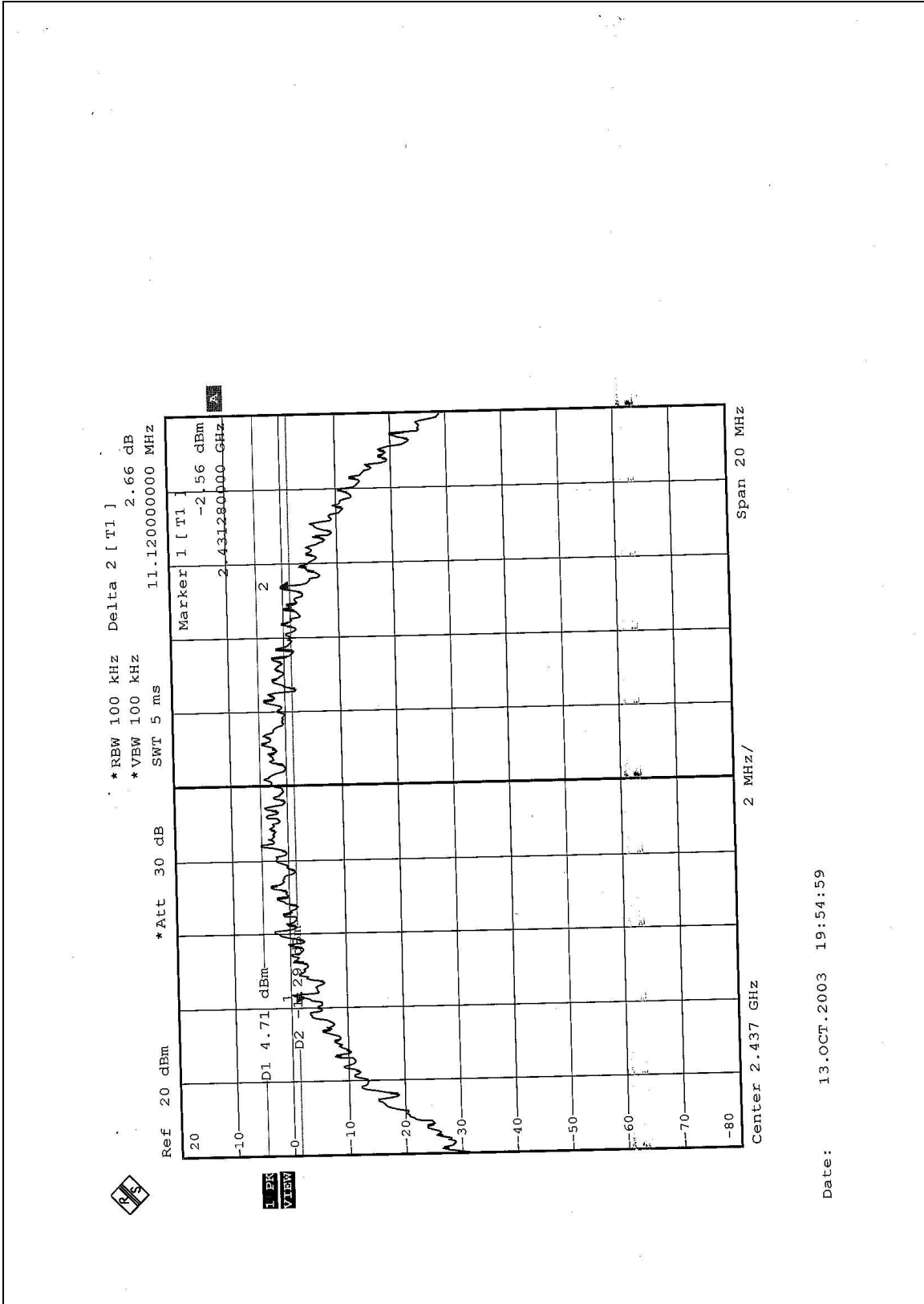

Date: 13.OCT.2003 19:54:59



CH11

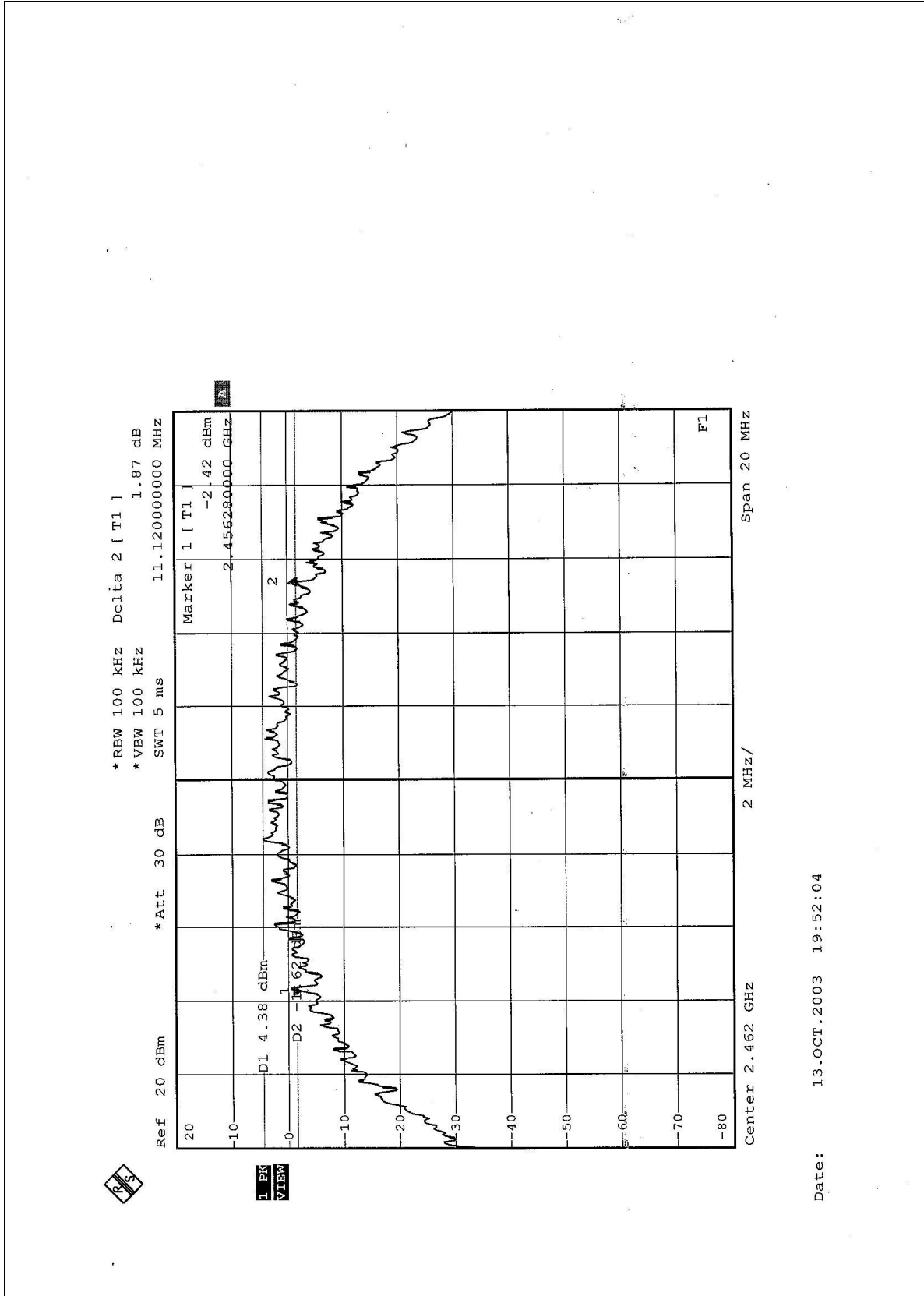

Date: 13.OCT.2003 19:52:04



#### 4.4 MAXIMUM PEAK OUTPUT POWER

##### 4.4.1 LIMITS OF MAXIMUM PEAK OUTPUT POWER MEASUREMENT

The Maximum Peak Output Power Measurement is 30dBm.

##### 4.4.2 TEST INSTRUMENTS

Description & Manufacturer	Model No.	Serial No.	Calibrated Until
R&S SPECTRUM ANALYZER	FSEK30	100049	Aug. 12, 2004
R&S SIGNAL GENERATOR	SMP04	100011	May 28, 2004
TEKTRONIX OSCILLOSCOPE	TDS 220	B048470	Mar. 05, 2004
NARDA DETECTOR	4503A	FSCM99899	NA

**NOTE:**

The calibration interval of the above test instruments is 12 months and the calibrations are traceable to NML/ROC and NIST/USA..





#### 4.4.3 TEST PROCEDURES

1. A detector was used on the output port of the EUT. An oscilloscope was used to read the response of the detector.
2. Replaced the EUT by the signal generator . The center frequency of the S.G was adjusted to the center frequency of the measured channel.
3. Adjusted the power to have the same reading on oscilloscope. Record the power level.

#### 4.4.4 DEVIATION FROM TEST STANDARD

No deviation

#### 4.4.5 TEST SETUP



#### 4.4.6 EUT OPERATING CONDITIONS

Same as Item 4.3.6



## 4.4.7 TEST RESULTS

<b>EUT</b>	IEEE 802.11b USB STICK Storage / Wireless LAN Card	<b>MODEL</b>	GN-WLBZ201
<b>INPUT POWER (SYSTEM)</b>	120Vac, 60 Hz	<b>ENVIRONMENTAL CONDITIONS</b>	28deg. C, 60%RH, 991hPa
<b>TESTED BY:</b> Steven Lu			

<b>CHANNEL</b>	<b>CHANNEL FREQUENCY (MHz)</b>	<b>PEAK POWER OUTPUT (dBm)</b>	<b>PEAK POWER LIMIT (dBm)</b>	<b>PASS/FAIL</b>
1	2412	14.7	30	PASS
6	2437	15.0	30	PASS
11	2462	14.8	30	PASS



## 4.5 POWER SPECTRAL DENSITY MEASUREMENT

### 4.5.1 LIMITS OF POWER SPECTRAL DENSITY MEASUREMENT

The Maximum of Power Spectral Density Measurement is 8dBm.

### 4.5.2 TEST INSTRUMENTS

Description & Manufacturer	Model No.	Serial No.	Calibrated Until
SPECTRUM ANALYZER	FSEK30	100049	Aug. 12, 2004

**NOTE:** The calibration interval of the above test instruments is 12 months and the calibrations are traceable to NML/ROC and NIST/USA.

#### 4.5.3 TEST PROCEDURE

The transmitter output was connected to the spectrum analyzer through an attenuator, the bandwidth of the fundamental frequency was measured with the spectrum analyzer using 3kHz RBW and 30kHz VBW, set sweep time=span/3kHz. The power spectral density was measured and recorded. The sweep time is allowed to be longer than span/3KHz for a full response of the mixer in the spectrum analyzer.

#### 4.5.4 DEVIATION FROM TEST STANDARD

No deviation

#### 4.5.5 TEST SETUP

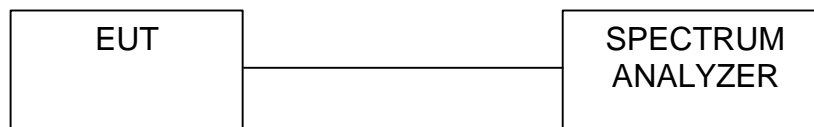

#### 4.5.6 EUT OPERATING CONDITIONS

Same as 4.3.6



## 4.5.7 TEST RESULTS

<b>EUT</b>	IEEE 802.11b USB STICK Storage / Wireless LAN Card	<b>MODEL</b>	GN-WLBZ201
<b>INPUT POWER (SYSTEM)</b>	120Vac, 60 Hz	<b>ENVIRONMENTAL CONDITIONS</b>	28deg. C, 60%RH, 991hPa
<b>TESTED BY:</b> Steven Lu			

<b>CHANNEL</b>	<b>CHANNEL FREQUENCY (MHz )</b>	<b>RF POWER LEVEL IN 3 kHz BW (dBm)</b>	<b>MAXIMUM LIMIT (dBm)</b>	<b>PASS/FAIL</b>
1	2412	-10.45	8	PASS
6	2437	-9.59	8	PASS
11	2462	-9.73	8	PASS



CH1

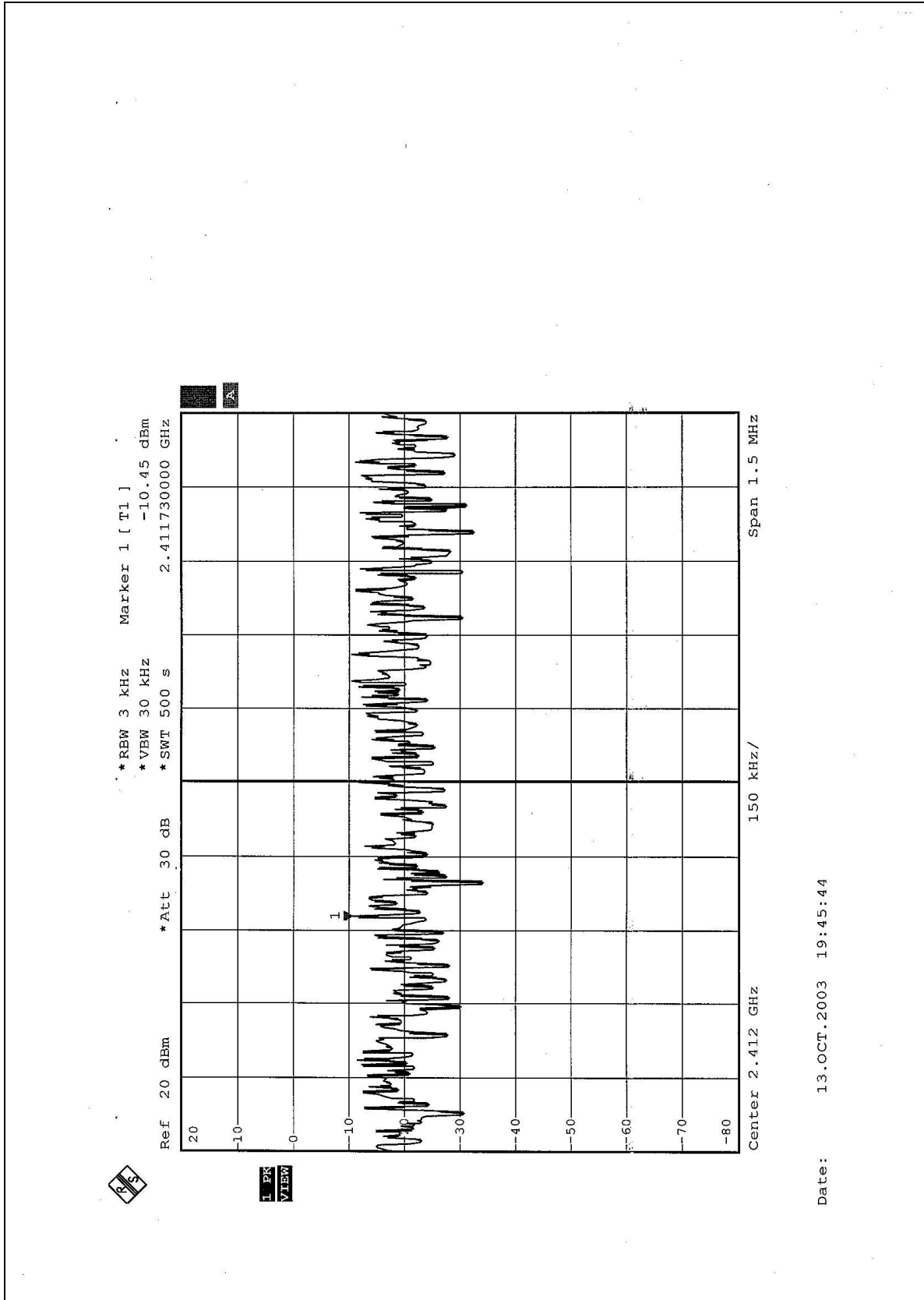

Date: 13.OCT.2003 19:45:44



CH6

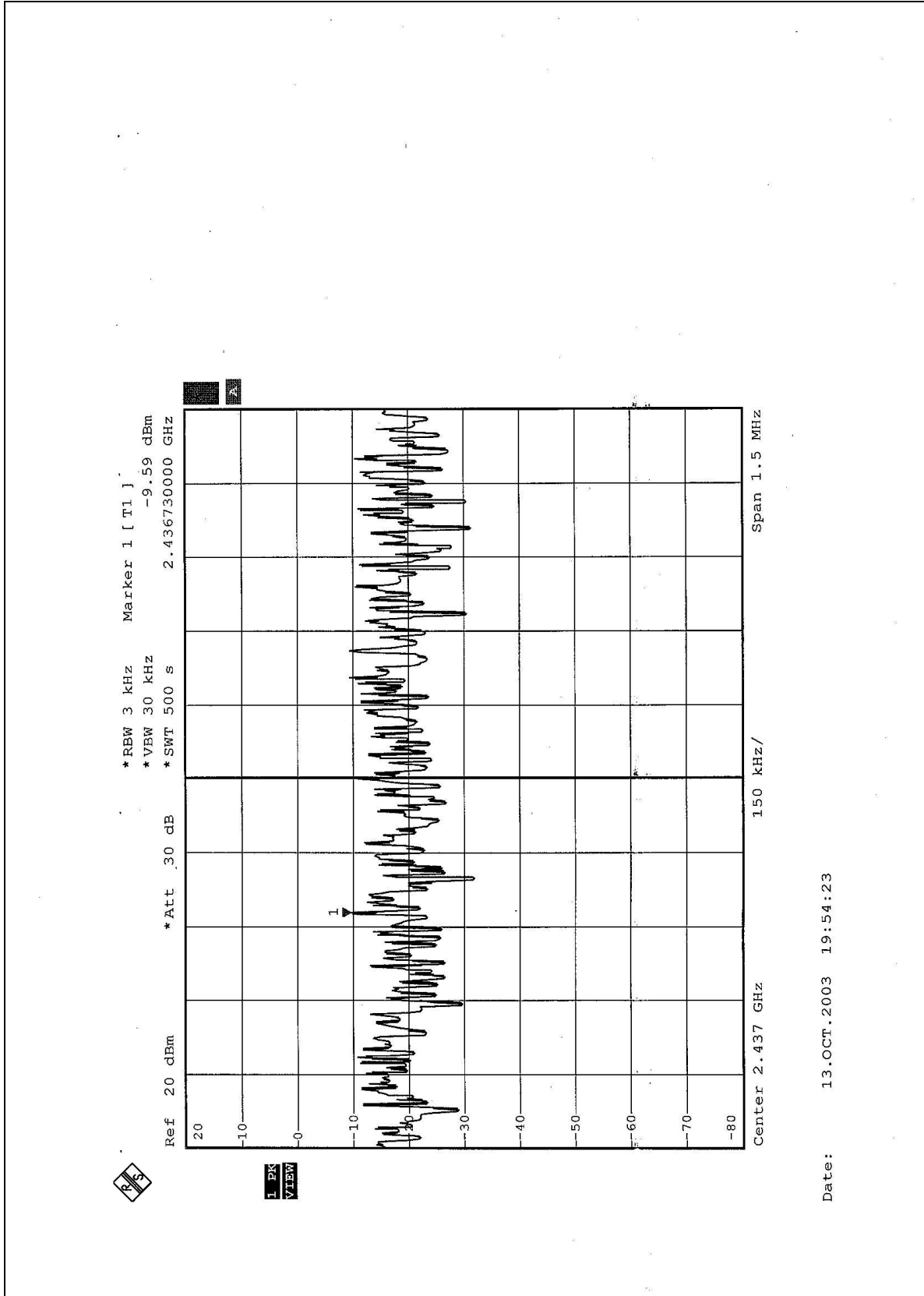

Date: 13.OCT.2003 19:54:23



CH11

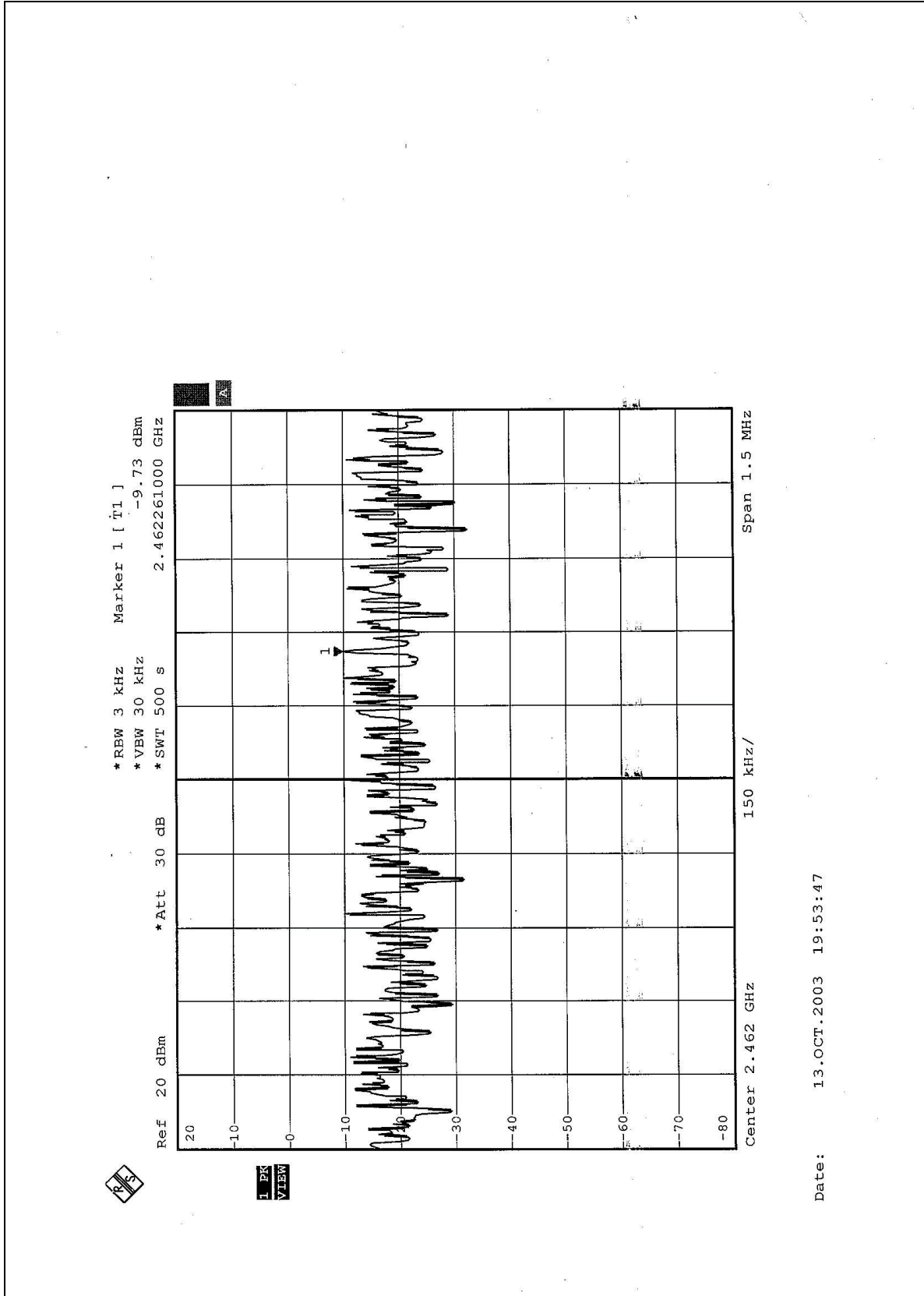

1 PK VIEW

Date: 13.OCT.2003 19:53:47





**4.6 BAND EDGES MEASUREMENT**

**4.6.1 LIMITS OF BAND EDGES MEASUREMENT**

Below -20dB of the highest emission level of operating band (in 100KHz Resolution Bandwidth).

**4.6.2 TEST INSTRUMENTS**

Description & Manufacturer	Model No.	Serial No.	Calibrated Until
SPECTRUM ANALYZER	FSEK30	100049	Aug. 12, 2004

**NOTE:** The calibration interval of the above test instruments is 12 months and the calibrations are traceable to NML/ROC and NIST/USA.

**4.6.3 TEST PROCEDURE**

The transmitter output was connected to the spectrum analyzer via a low lose cable. Set both RBW and VBW of spectrum analyzer to 100kHz with suitable frequency span including 100MHz bandwidth from band edge. The band edges was measured and recorded.

**4.6.4 DEVIATION FROM TEST STANDARD**

No deviation



#### 4.6.5 EUT OPERATING CONDITION

Same as Item 4.3.6

#### 4.6.6 TEST RESULTS

The spectrum plots are attached on the following 2 pages. D2 line indicates the highest level, D1 line indicates the 20dB offset below D2. It shows compliance with the requirement in part 15.247(C).

**NOTE 1:**

The band edge emission plot on the following first pages shows 50.72dB delta between carrier maximum power and local maximum emission in restrict band (2.386GHz). The emission of carrier strength list in the test result of channel 1 at the item 4.2.7 is 100.0dBuV/m, so the maximum field strength in restrict band is  $100.0 - 50.72 = 49.28$ dBuV/m, which is under 54dBuV/m limit.

**NOTE 2:**

The band edge emission plot on the following second pages shows 53.12dB delta between carrier maximum power and local maximum emission in restrict band (2.497GHz). The emission of carrier strength list in the test result of channel 11 at the item 4.2.7 is 97.6dBuV/m, so the maximum field strength in restrict band is  $97.6 - 53.12 = 44.48$ dBuV/m which is under 54dBuV/m limit.

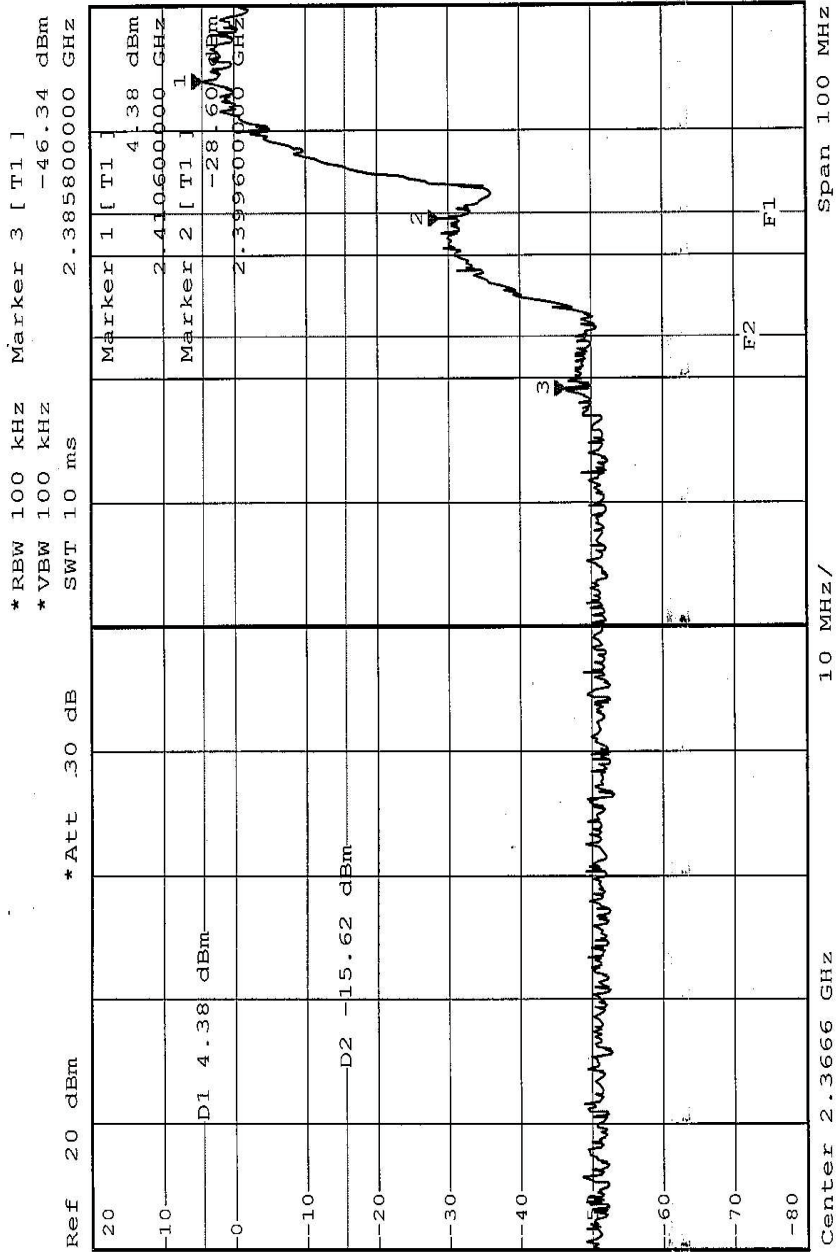

1 PK VIEW

Date: 13.OCT.2003 19:42:33



1 PK VIEW

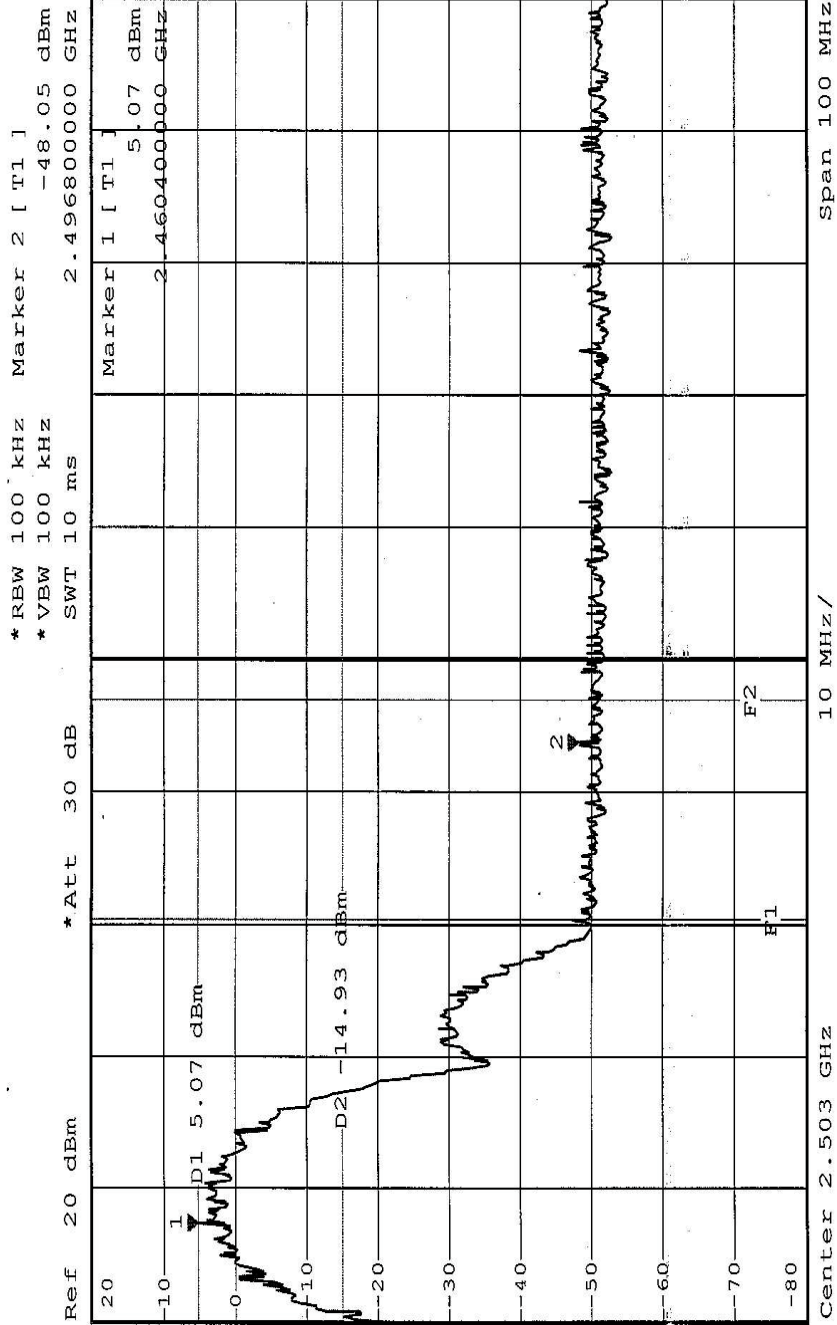

Date: 13.OCT.2003 19:49:01



## **4.7 ANTENNA REQUIREMENT**

### **4.7.1 STANDARD APPLICABLE**

For intentional device, according to FCC 47 CFR Section 15.203, an intentional radiator shall be designed to ensure that no antenna other than that furnished by the responsible party shall be used with the device.

And according to FCC 47 CFR Section 15.247 (b), if transmitting antennas of directional gain greater than 6dBi are used, the power shall be reduced by the amount in dB that the directional gain of the antenna exceeds 6dBi.

### **4.7.2 ANTENNA CONNECTED CONSTRUCTION**

The antenna type used in this product is Patch Antenna without antenna connector. The maximum Gain of this antenna is only 0dBi.

## 5 PHOTOGRAPHS OF THE TEST CONFIGURATION

### CONDUCTED EMISSION TEST

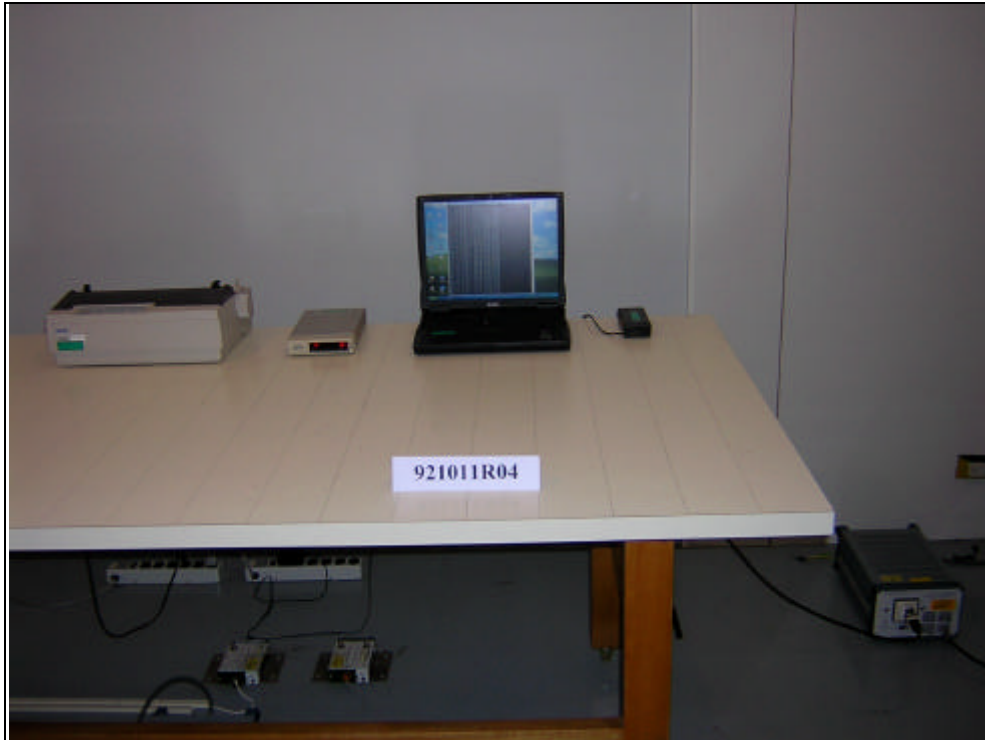

### RADIATED EMISSION TEST

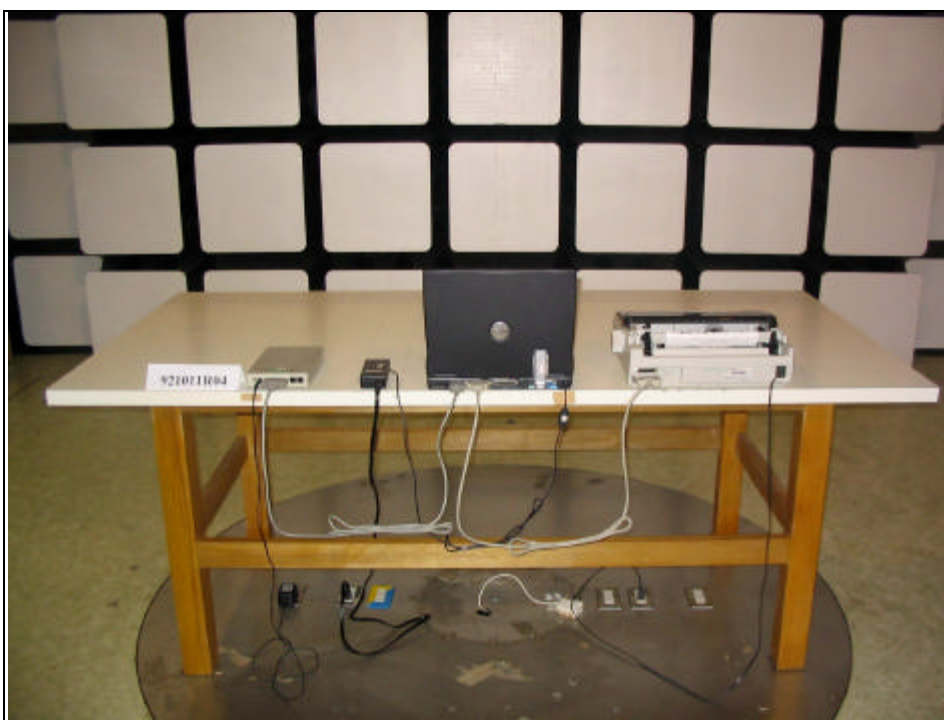



## 6 INFORMATION ON THE TESTING LABORATORIES

We, ADT Corp., were founded in 1988 to provide our best service in EMC and Safety consultation. Our laboratories are accredited and approved by the following approval agencies according to ISO/IEC 17025, Guide 25 or EN 45001:

<b>USA</b>	FCC, NVLAP
<b>Germany</b>	TUV Rheinland
<b>Japan</b>	VCCI
<b>New Zealand</b>	MoC
<b>Norway</b>	NEMKO
<b>R.O.C.</b>	BSMI, DGT, CNLA

Copies of accreditation certificates of our laboratories obtained from approval agencies can be downloaded from our web site:

[www.adt.com.tw/index.5/phtml](http://www.adt.com.tw/index.5/phtml).

If you have any comments, please feel free to contact us at the following:

**Lin Kou EMC Lab:**

Tel: 886-2-26052180

Fax: 886-2-26052943

**Hsin Chu EMC Lab:**

Tel: 886-35-935343

Fax: 886-35-935342

**Lin Kou Safety Lab:**

Tel: 886-2-26093195

Fax: 886-2-26093184

**Lin Kou RF&Telecom Lab**

Tel: 886-3-3270910

Fax: 886-3-3270892

**Email:** [service@mail.adt.com.tw](mailto:service@mail.adt.com.tw)

**Web Site:** [www.adt.com.tw](http://www.adt.com.tw)

The address and road map of all our labs can be found in our web site also.