

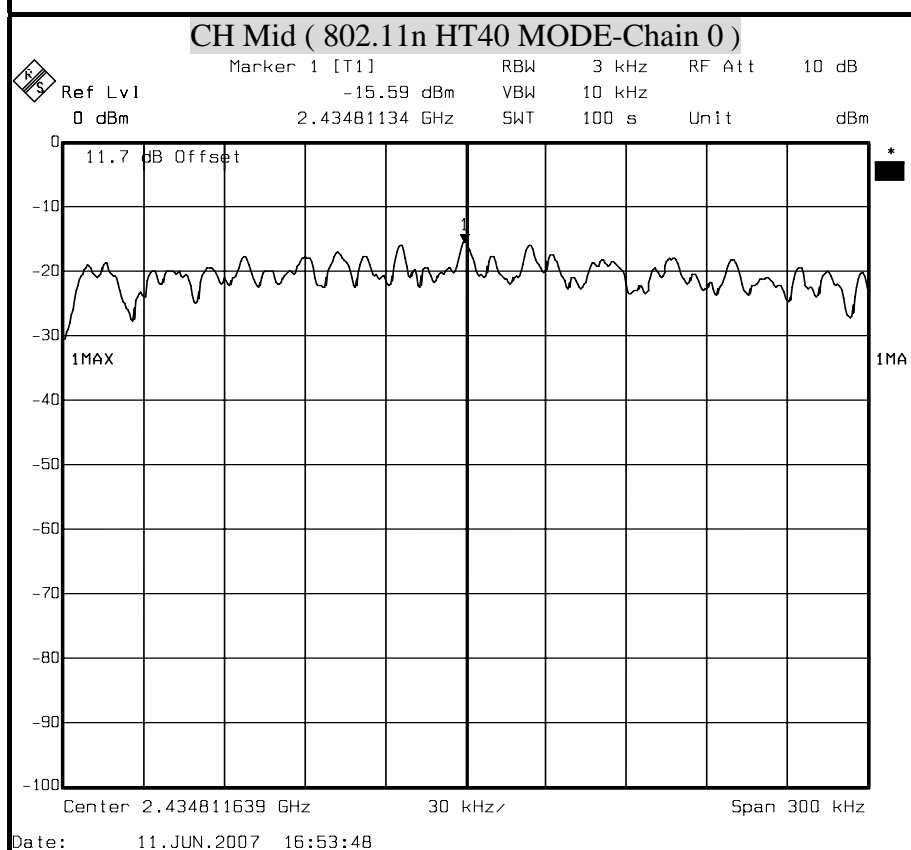

POWER SPECTRAL DENSITY (IEEE 802.11n HT40 MODE)

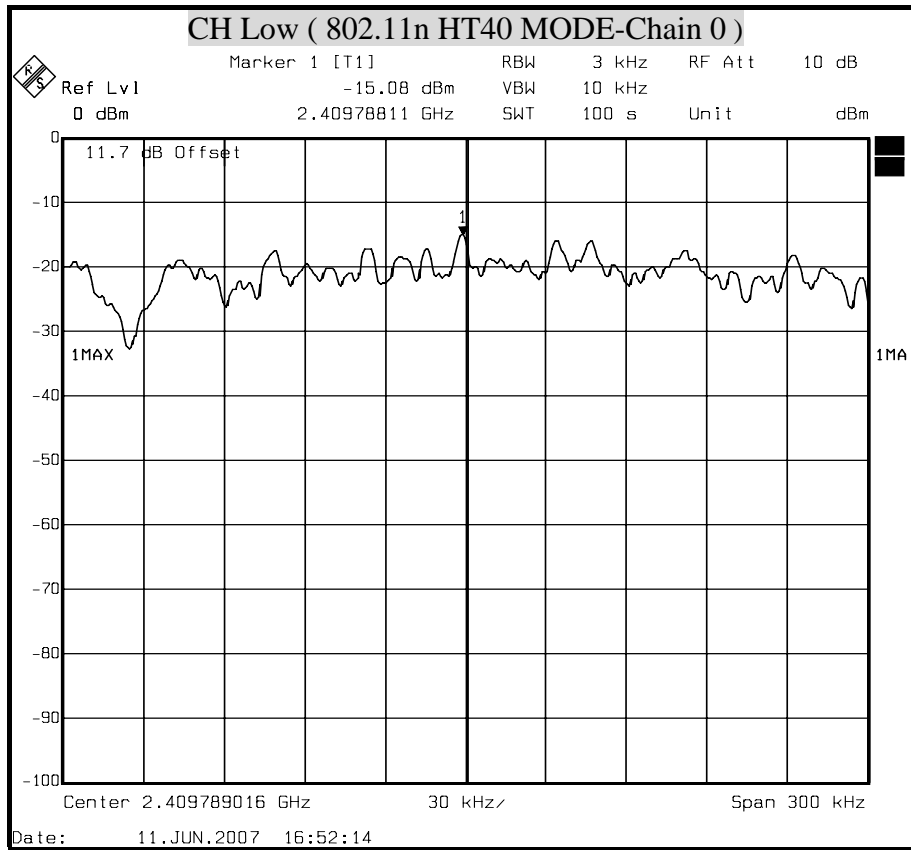

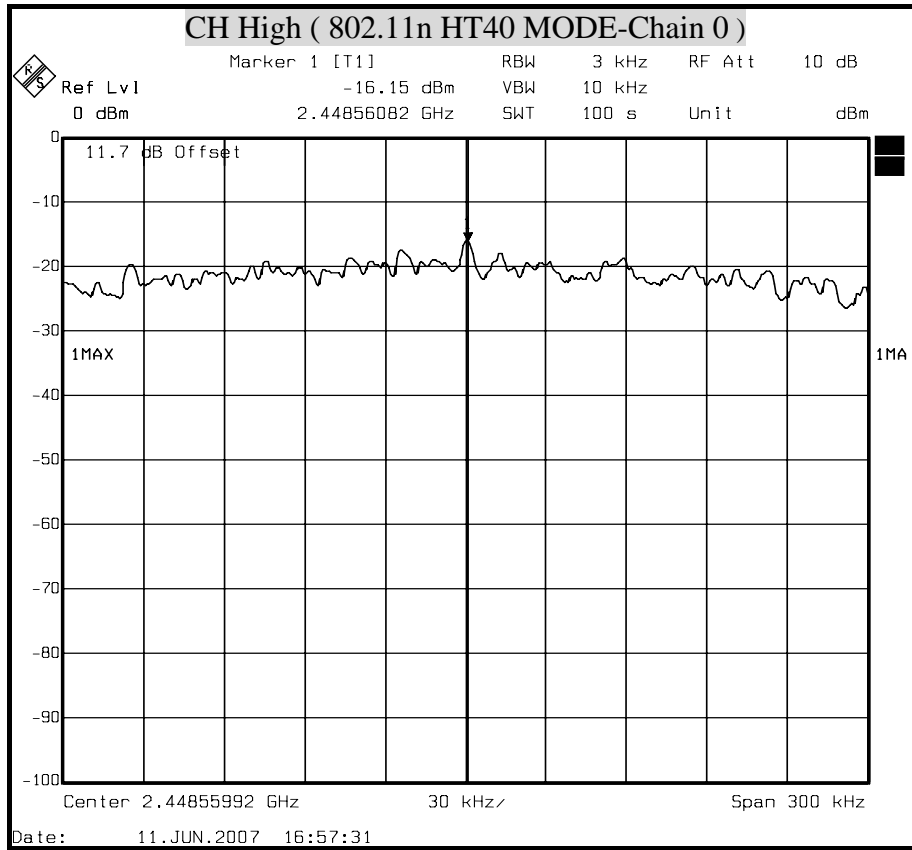

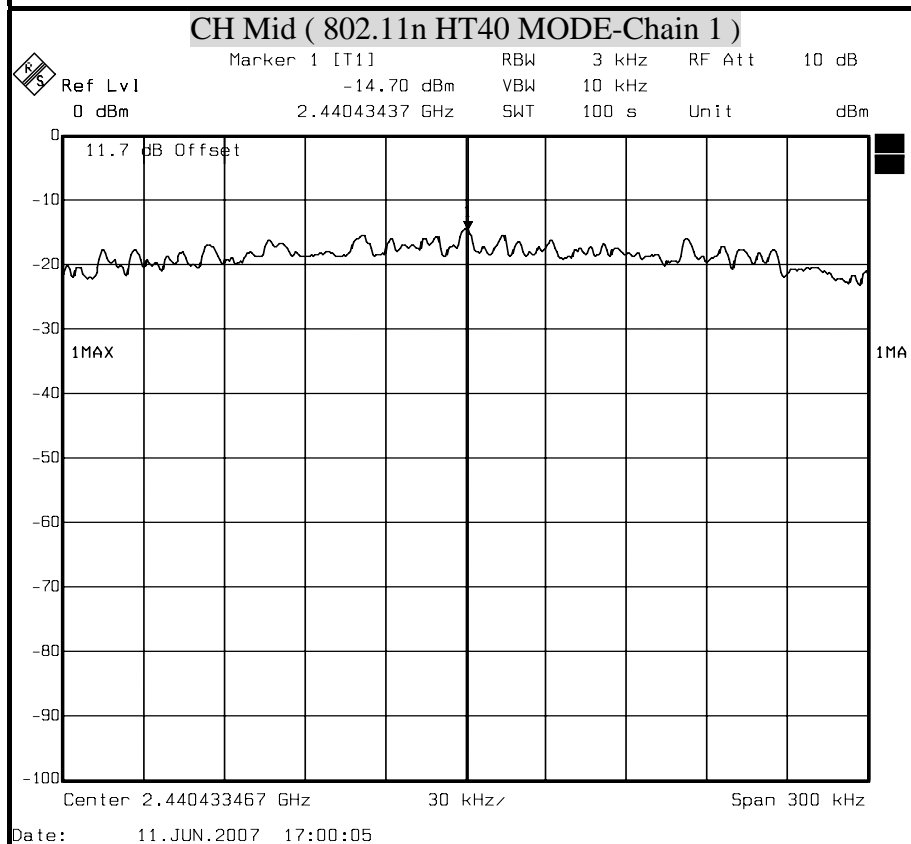
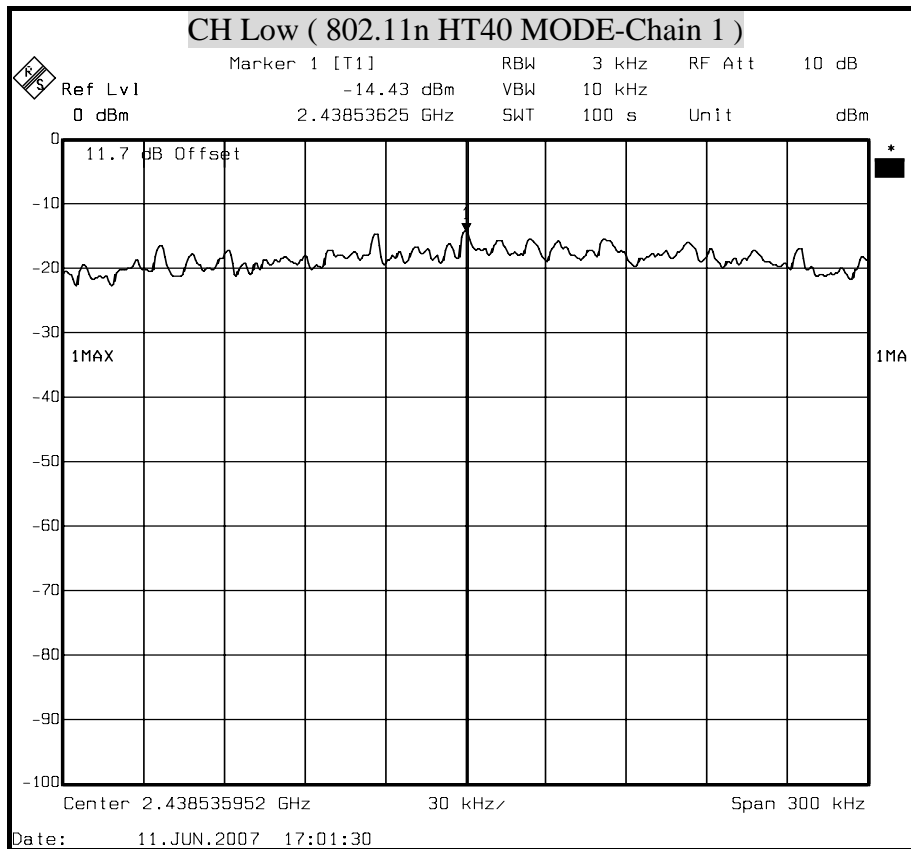

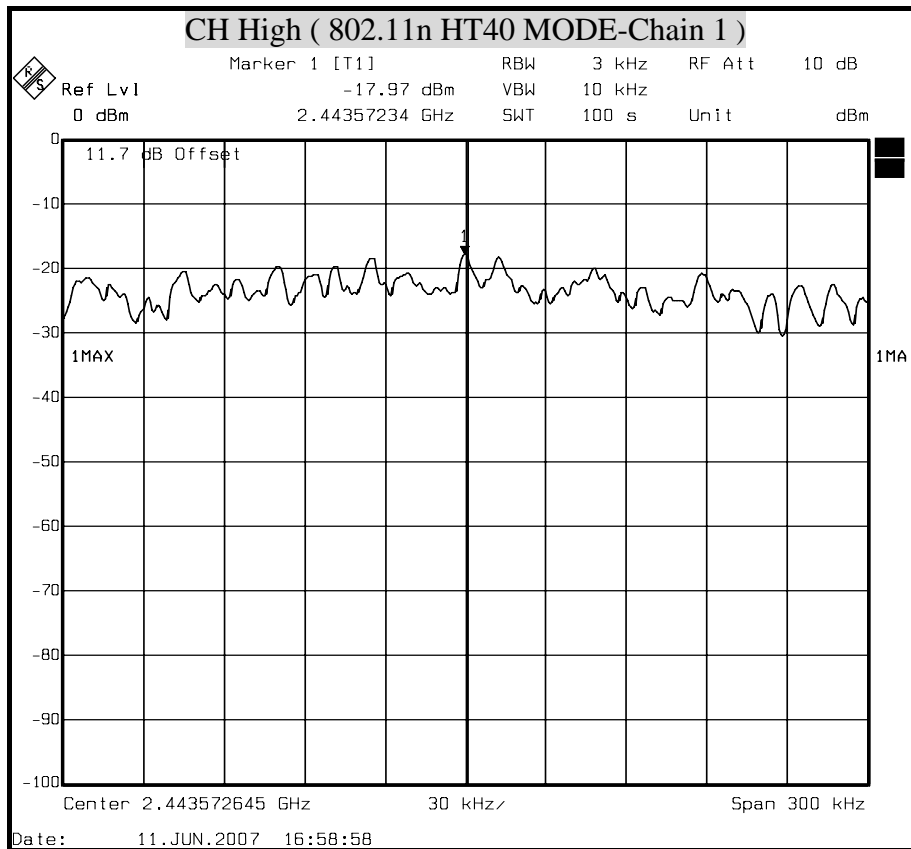

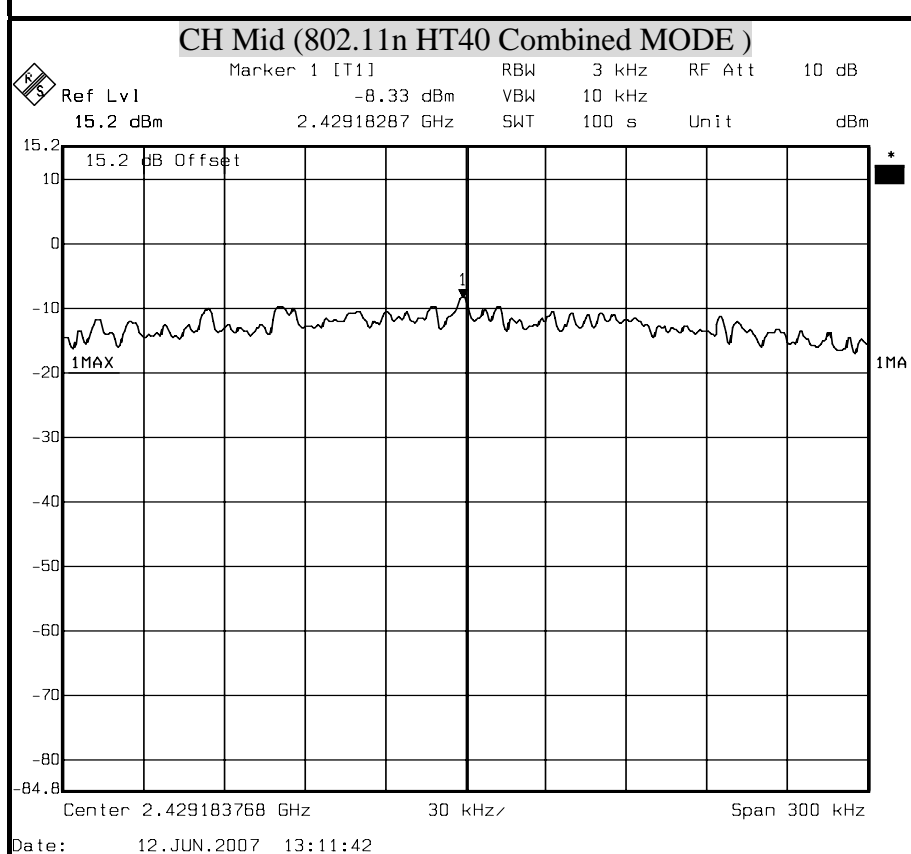
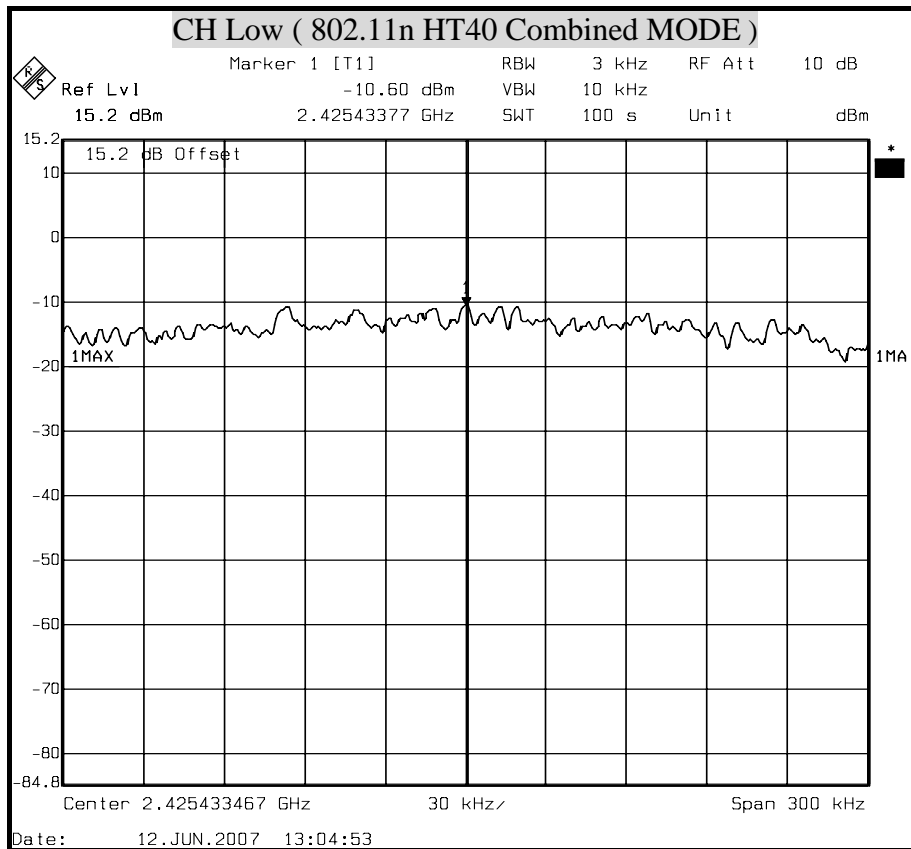

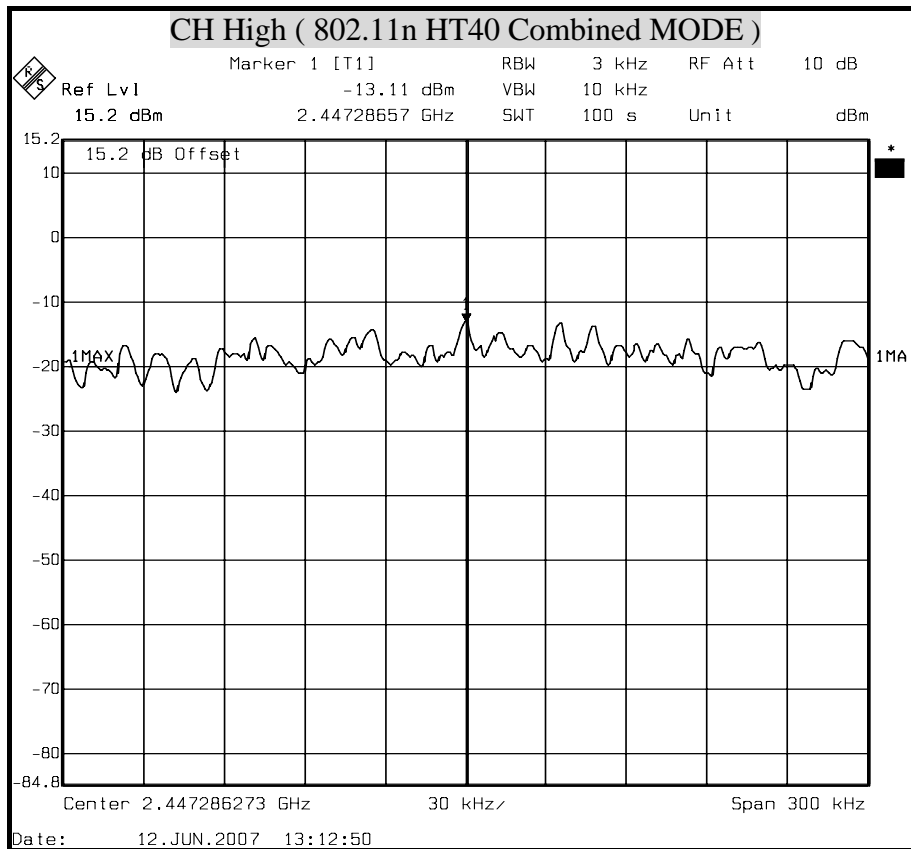

8.7 CONDUCTED SPURIOUS EMISSION

LIMITS

§ 15.247(d) In any 100 kHz bandwidth outside the frequency band in which the spread spectrum intentional radiator is operating, the radio frequency power that is produced by the intentional radiator shall be at least 20 dB below that in the 100 kHz bandwidth within the and that contains the highest level of the desired power, based on either an RF conducted or a radiated measurement. Attenuation below the general limits specified in § 15.209(a) is not required. In addition, radiated emissions which fall in the restricted bands, as defined in § 15.205(a), must also comply with the radiated emission limits specified in § 15.209(a) (see § 15.205(c)).

TEST PROCEDURE

The transmitter output is connected to a spectrum analyzer. The resolution bandwidth is set to 100 kHz. The video bandwidth is set to 300 kHz.

The spectrum from 30 MHz to 26 GHz is investigated with the transmitter set to the lowest, middle, and highest channels in the 2.4 GHz band.

TEST SETUP

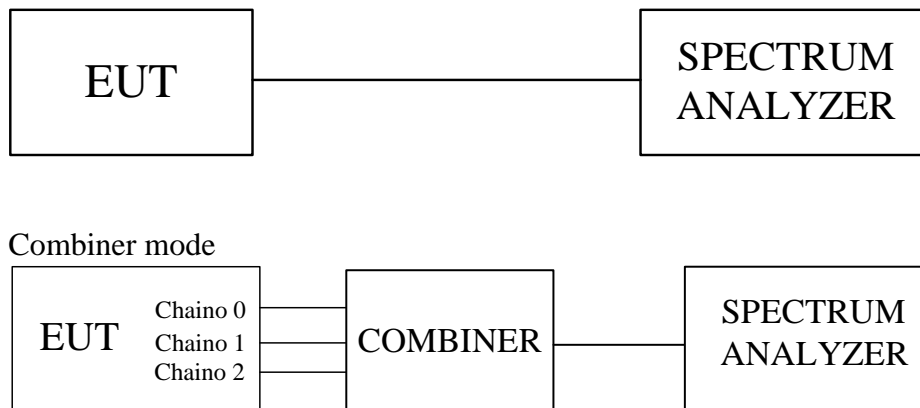

TEST RESULTS

No non-compliance noted



OUT-OF-BAND SPURIOUS EMISSIONS-CONDUCTED MEASUREMENT (IEEE 802.11b MODE)

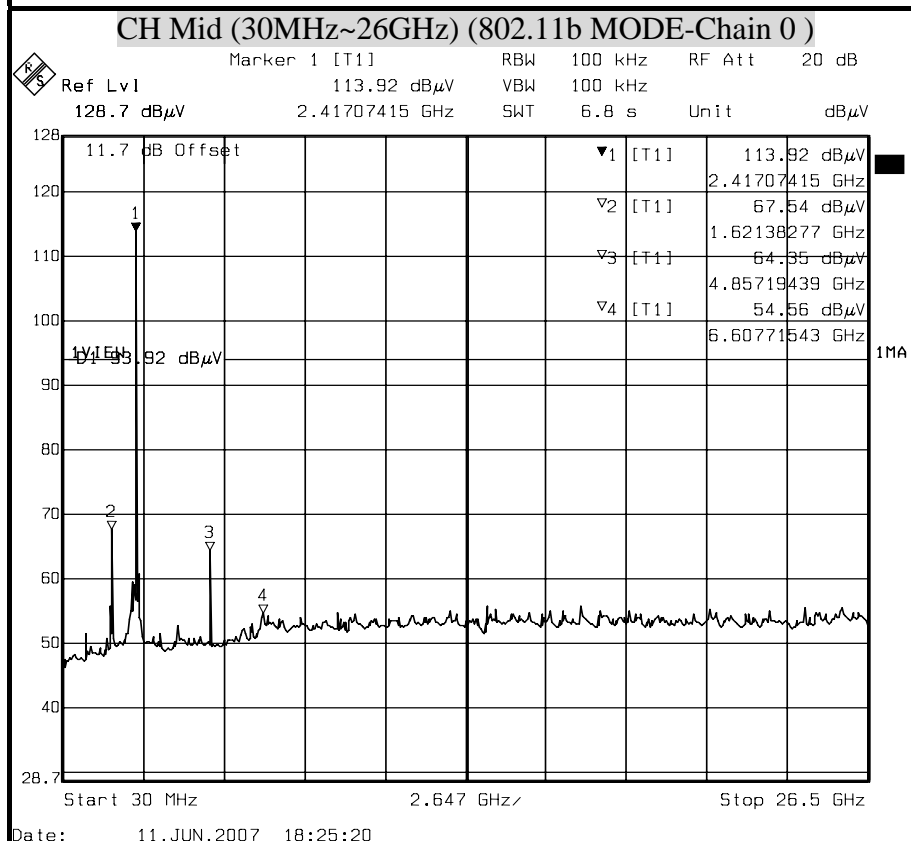
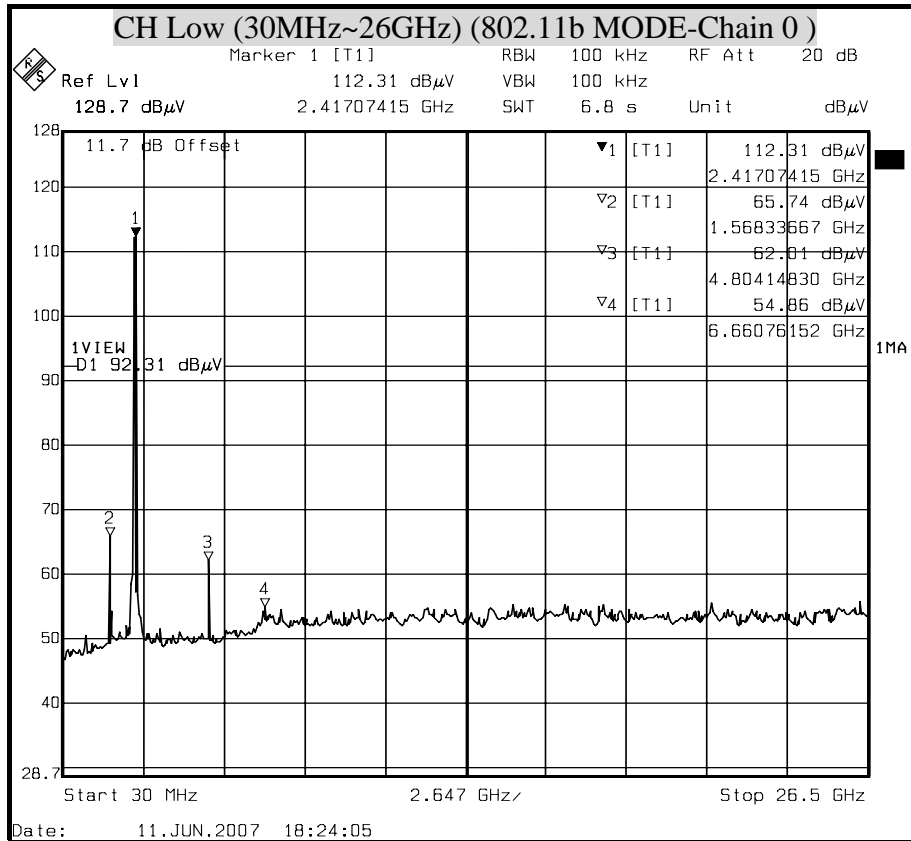

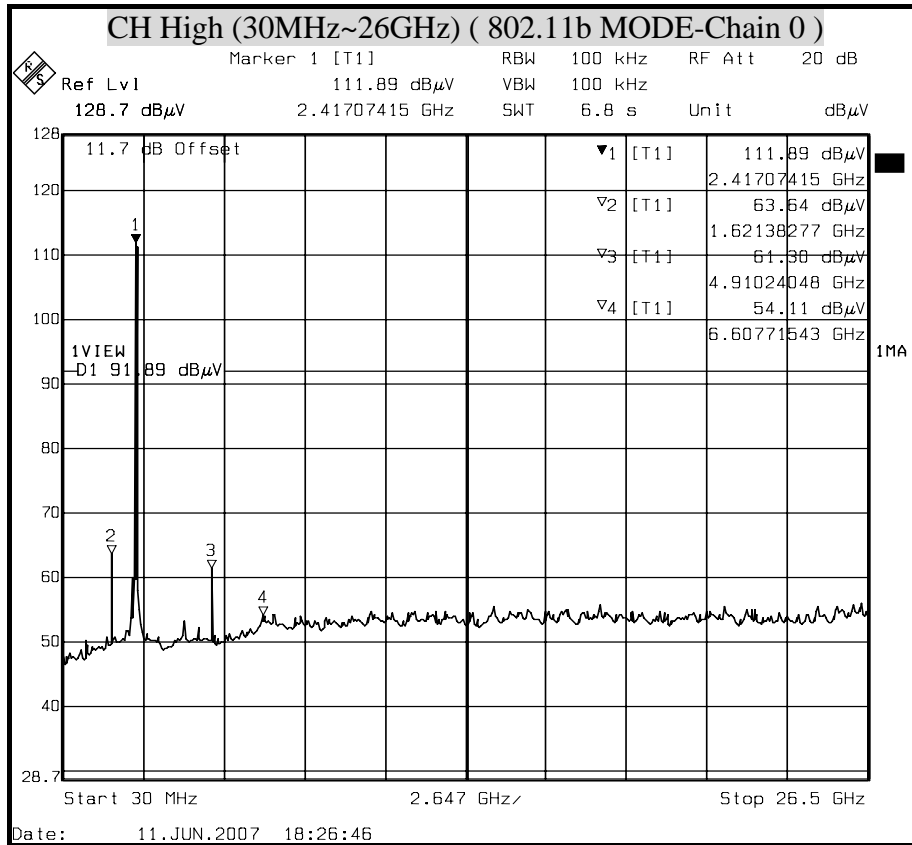

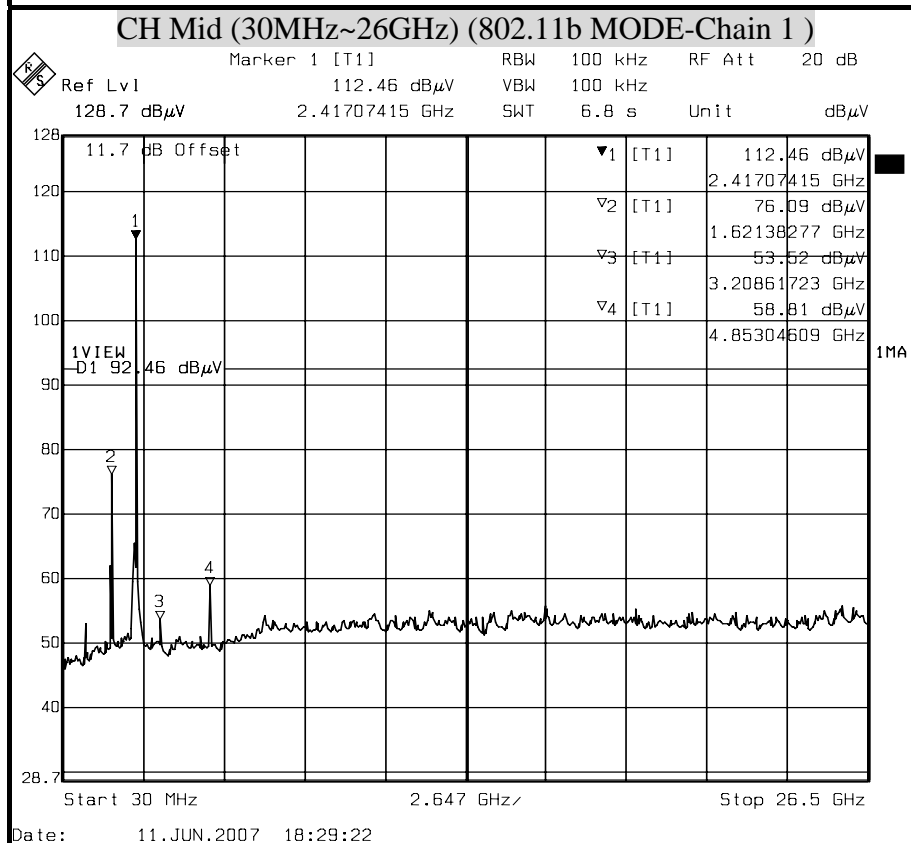
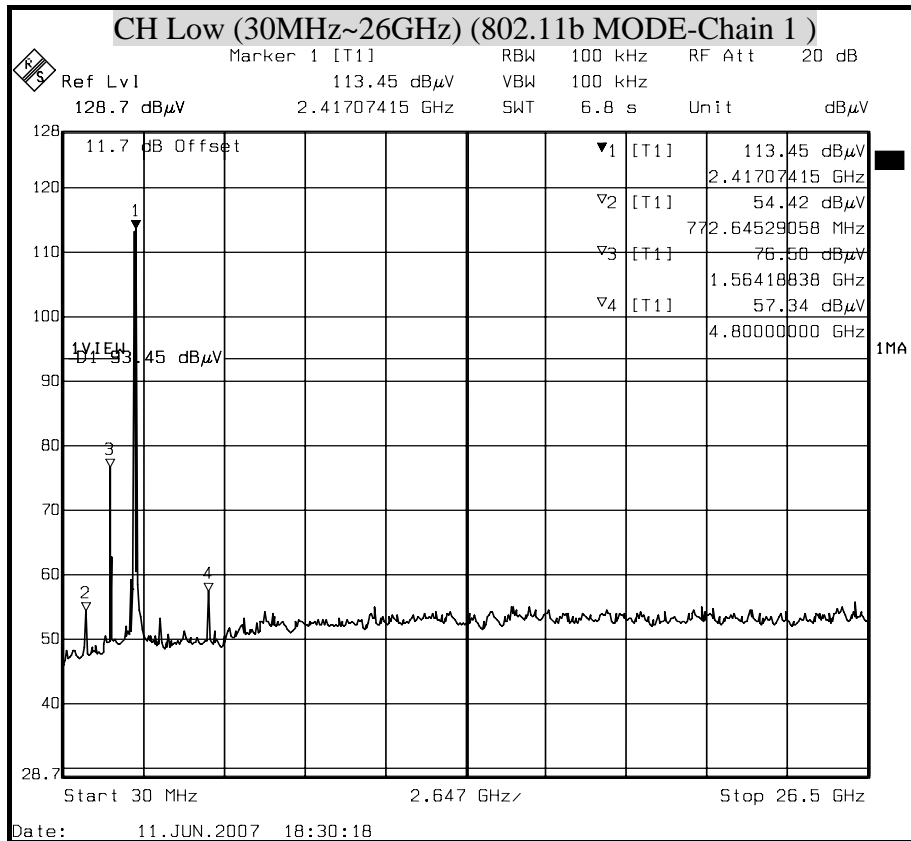

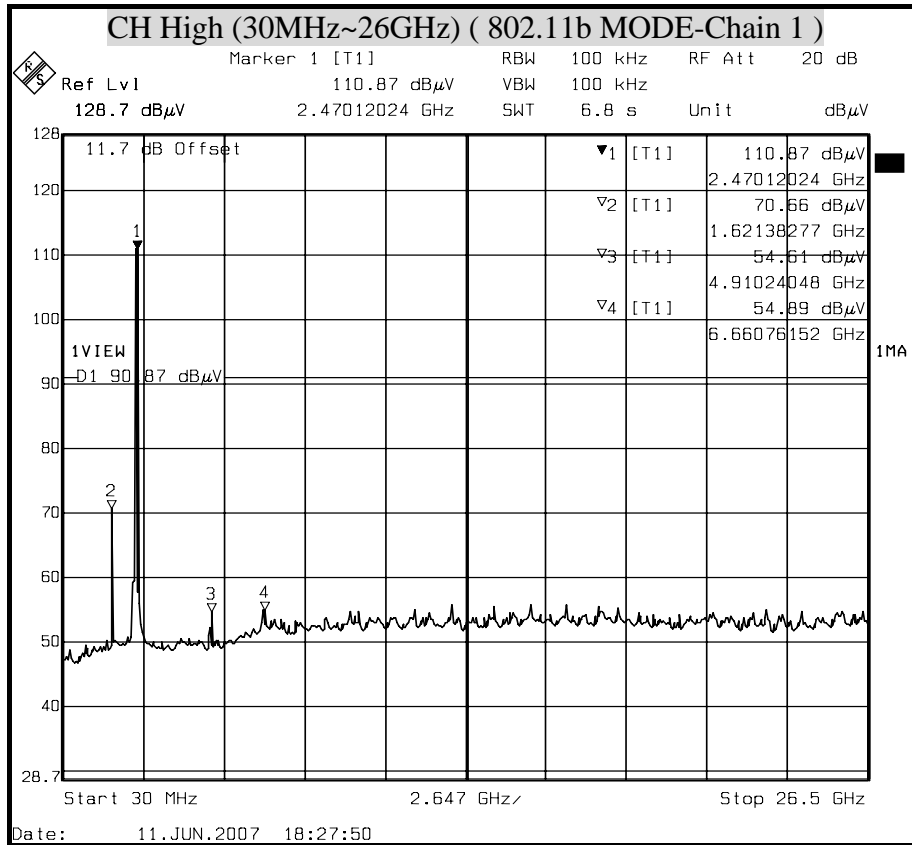



OUT-OF-BAND SPURIOUS EMISSIONS-CONDUCTED MEASUREMENT

(IEEE 802.11g MODE)

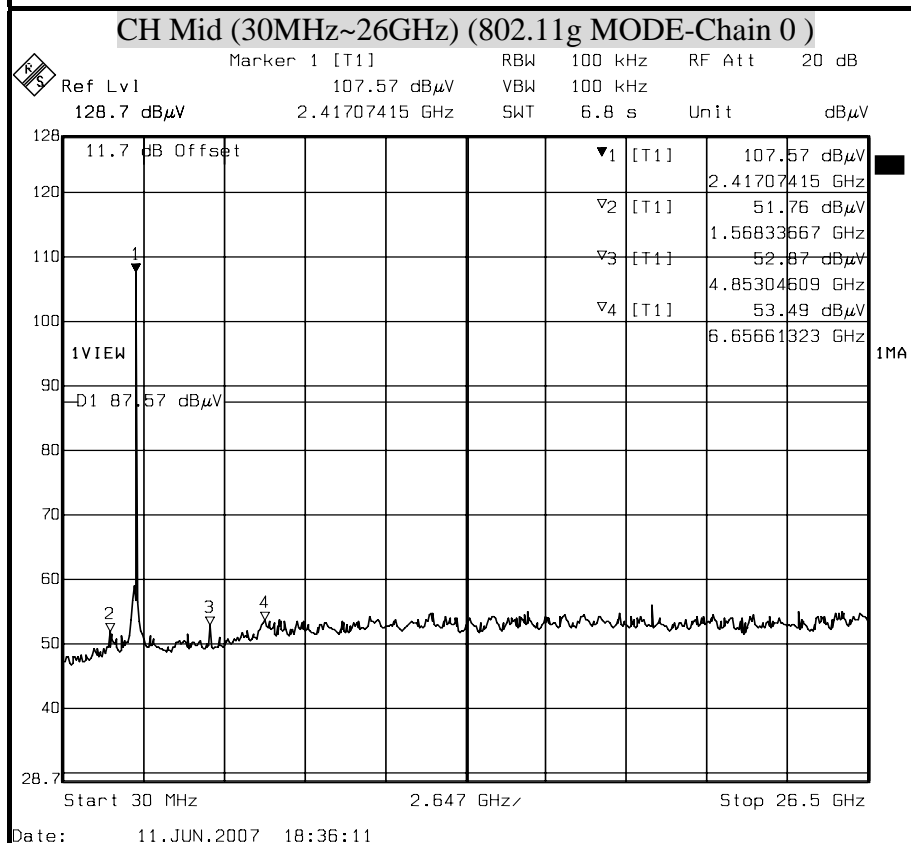
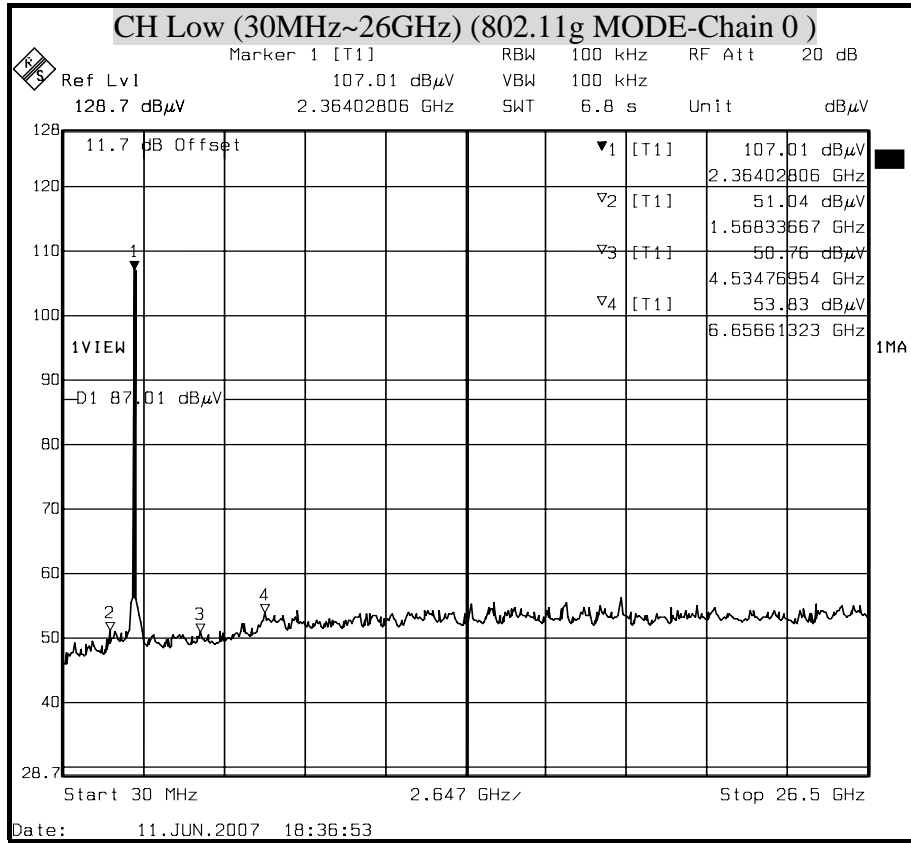

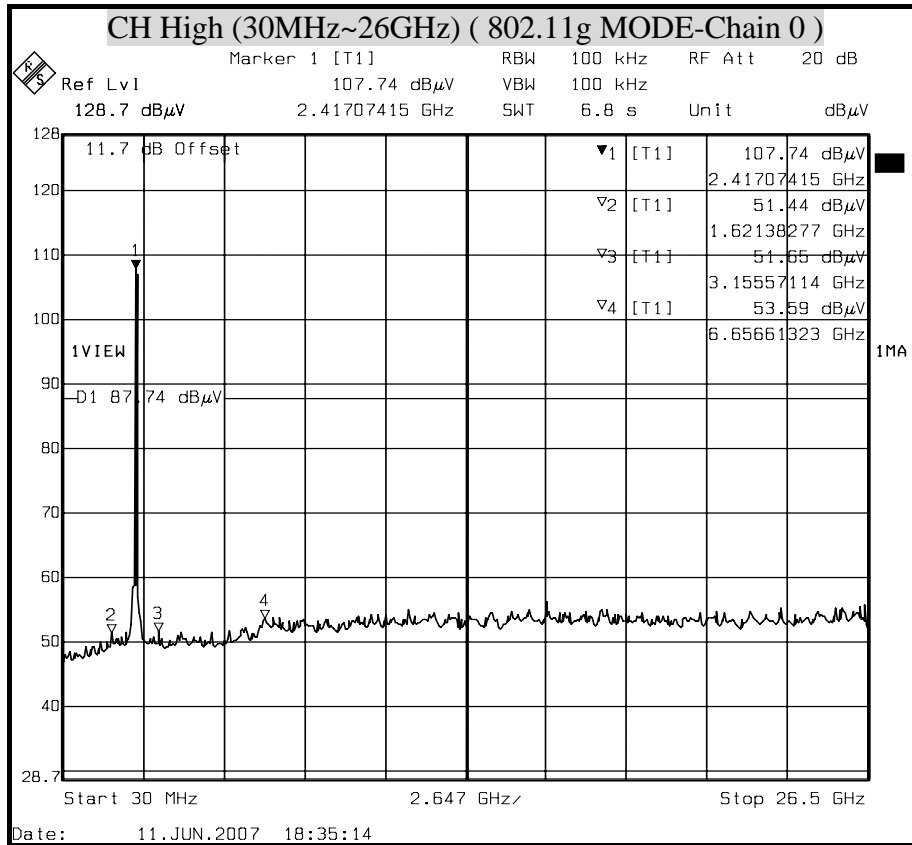

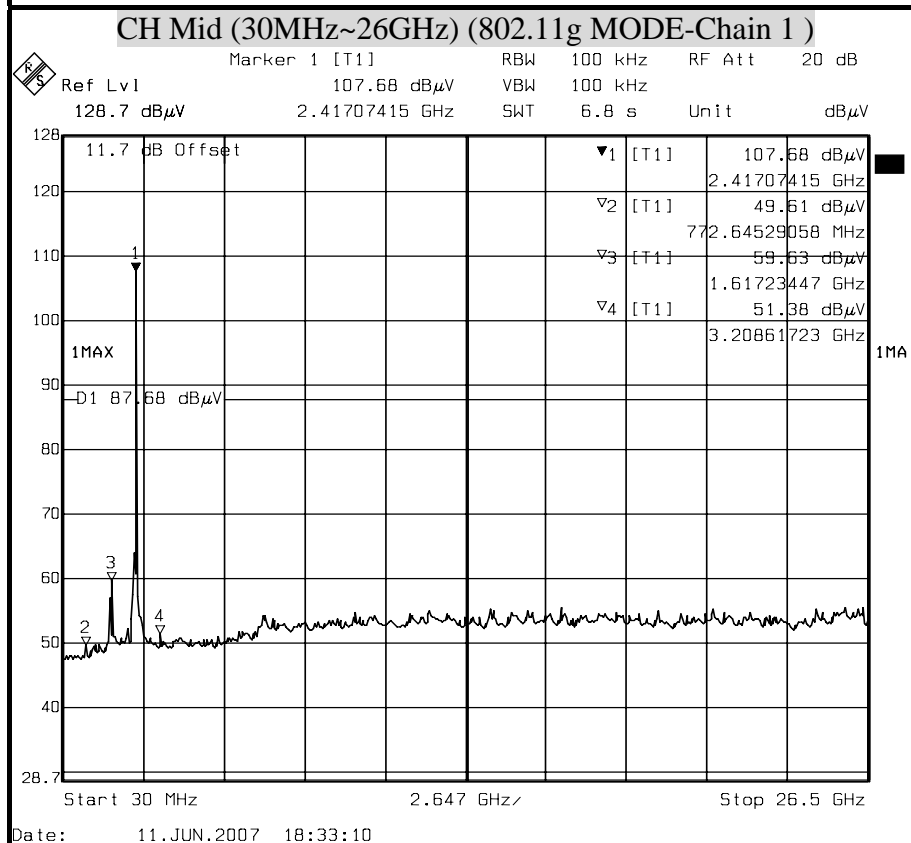
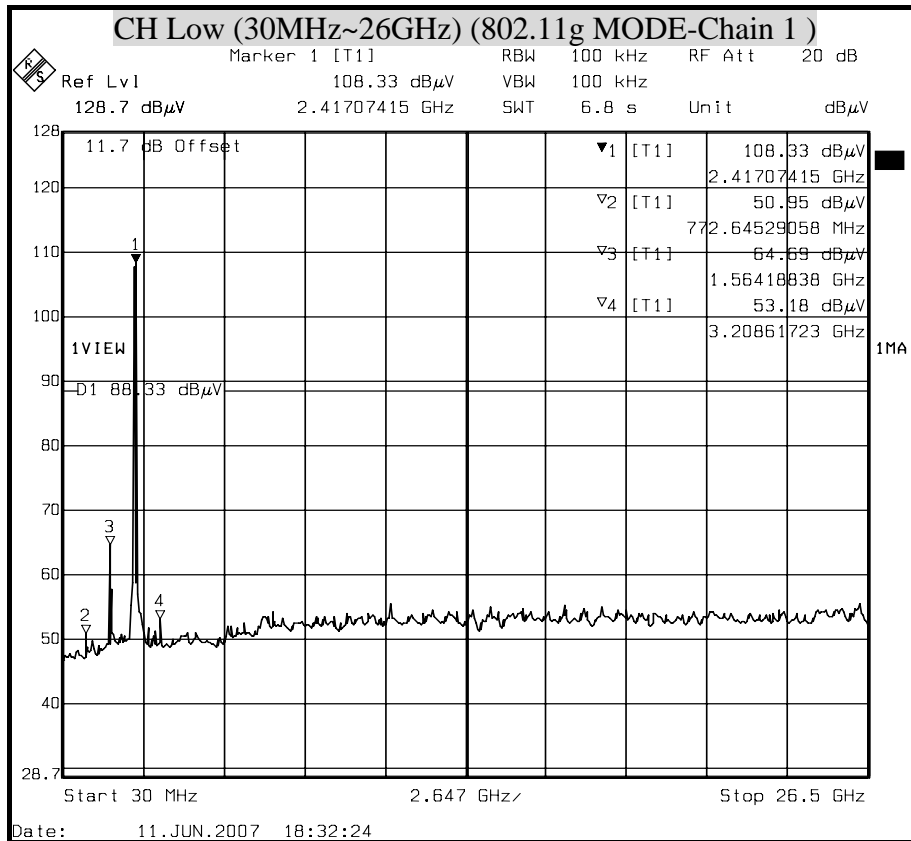

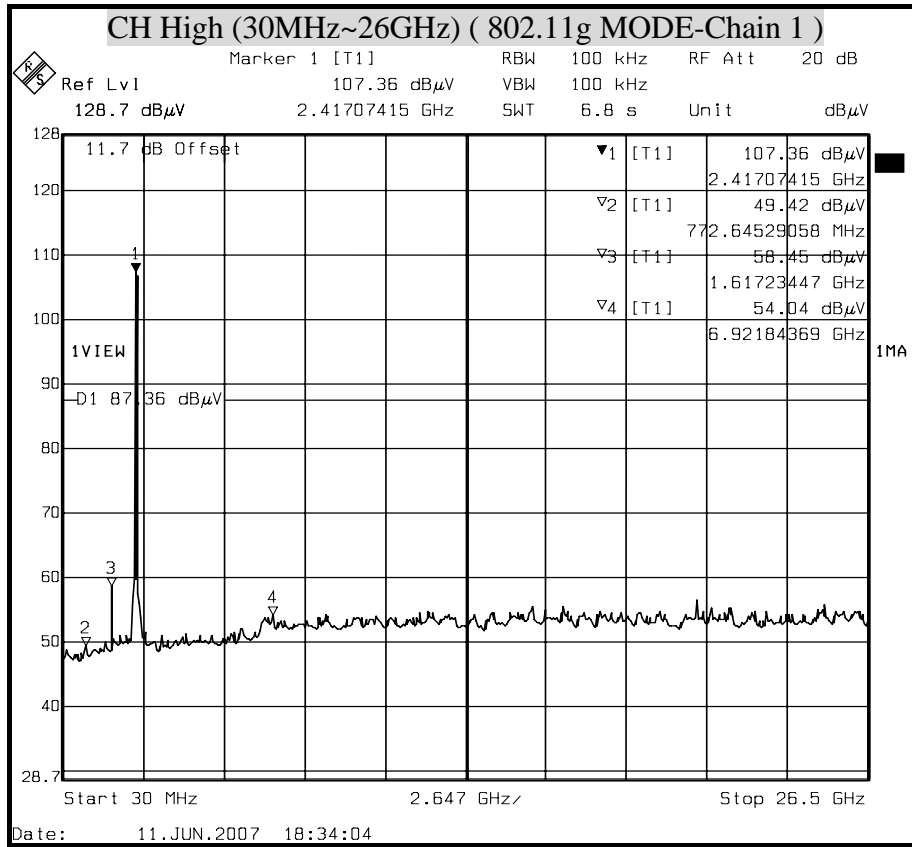



OUT-OF-BAND SPURIOUS EMISSIONS-CONDUCTED MEASUREMENT

(IEEE 802.11n HT20 MODE)

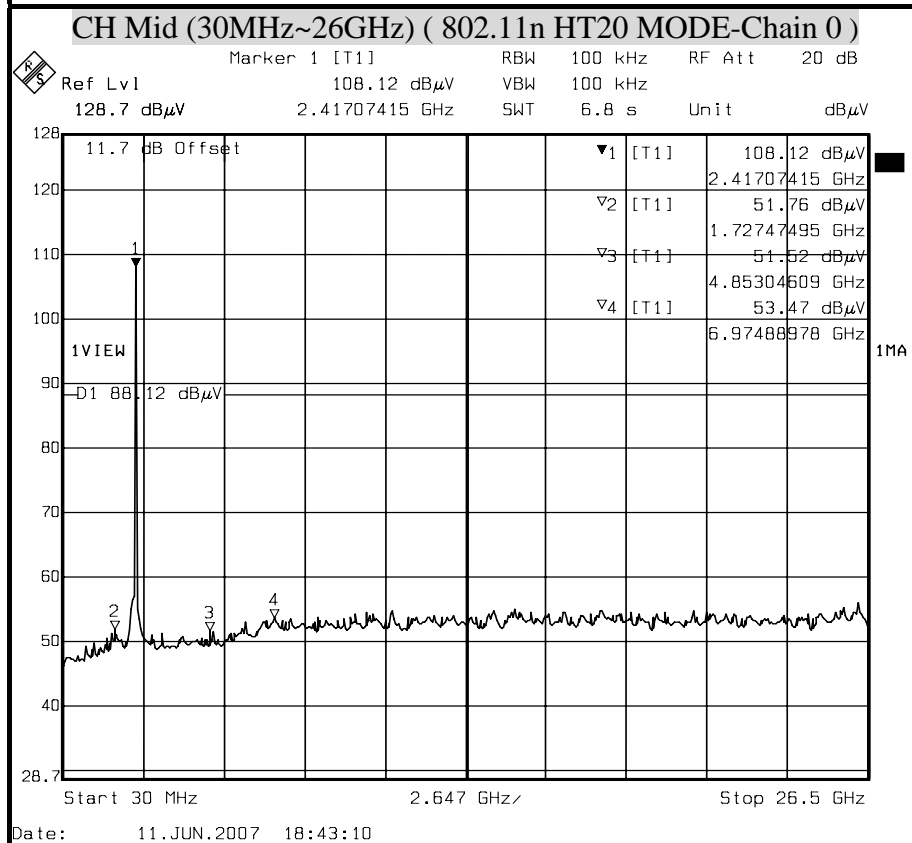
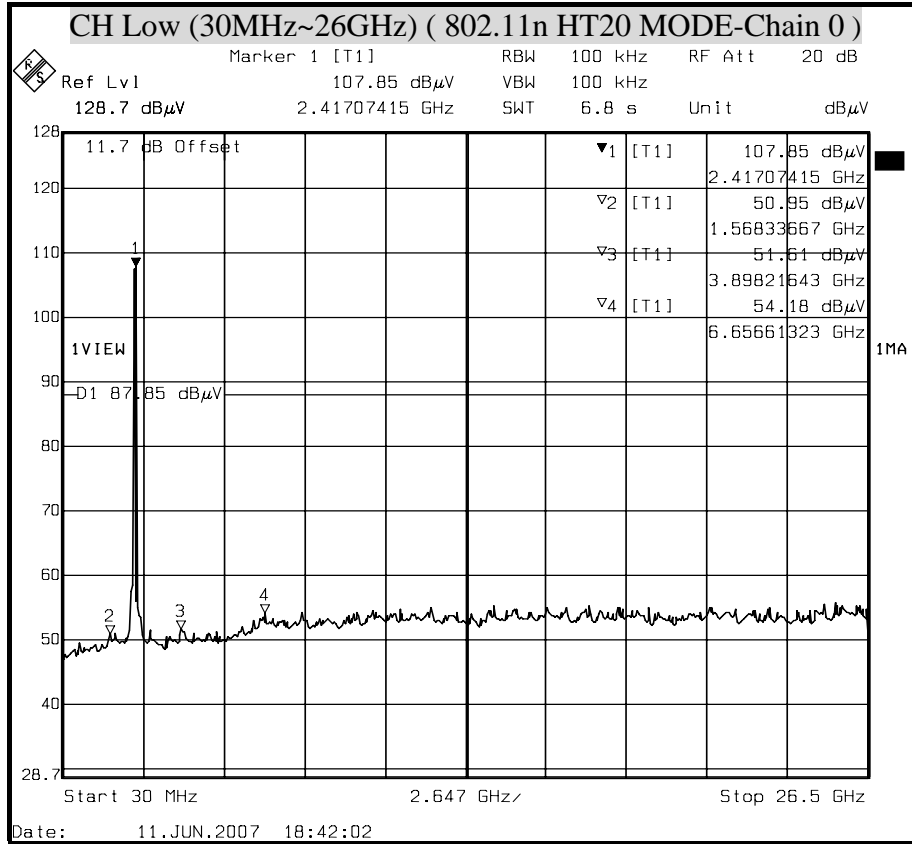

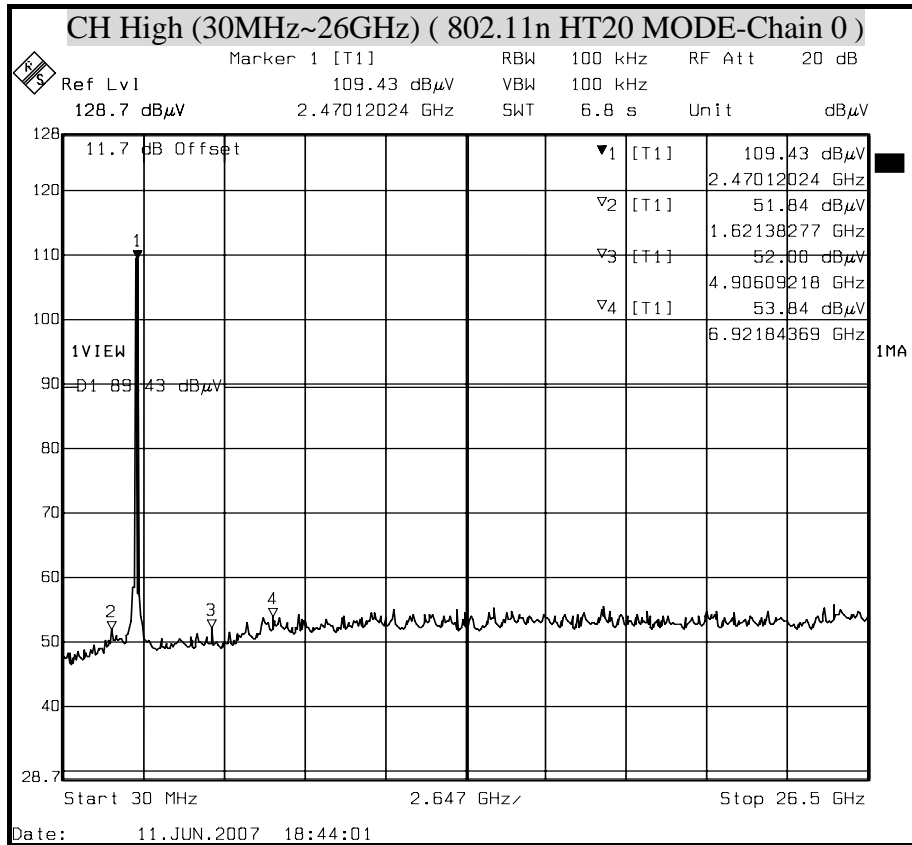

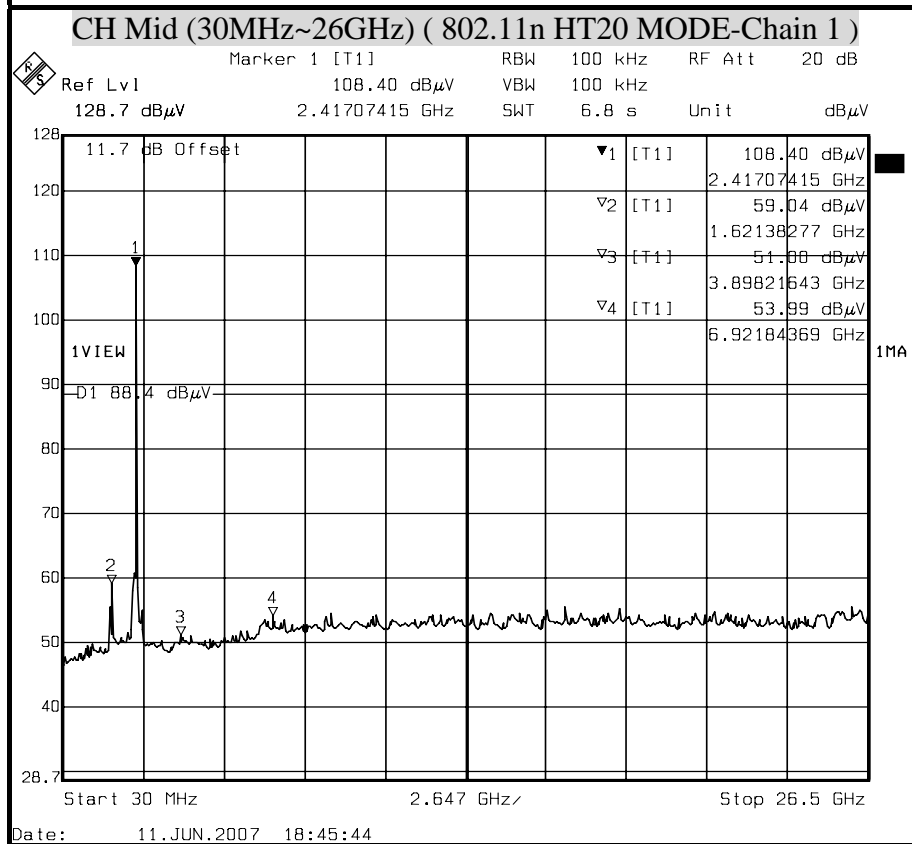
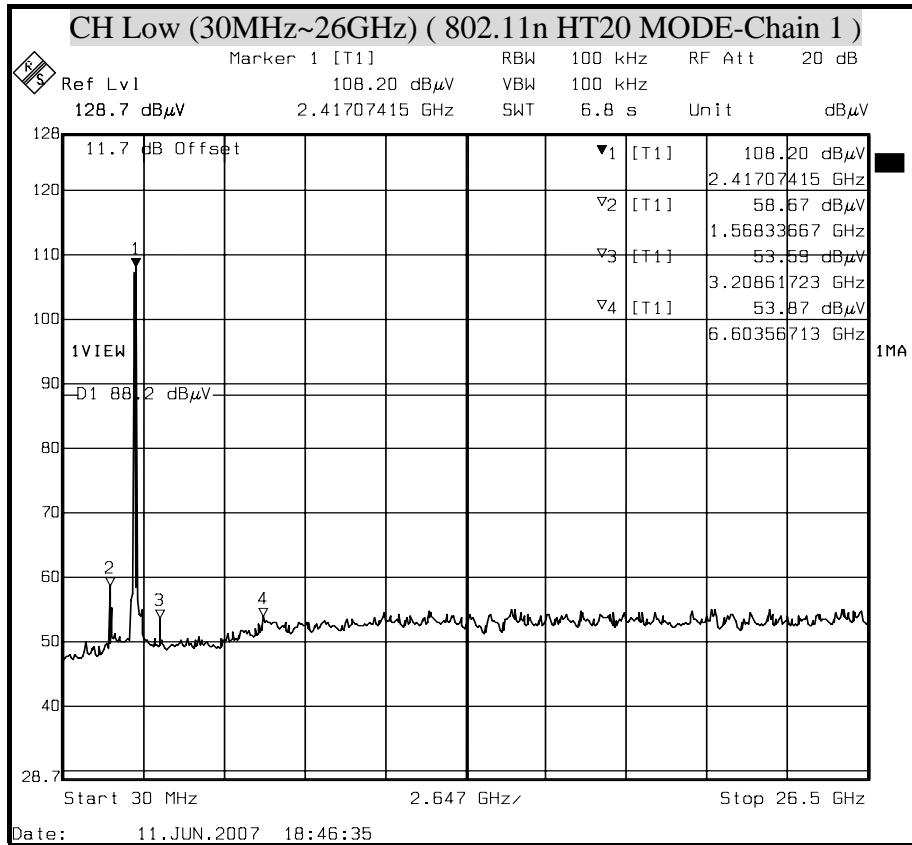

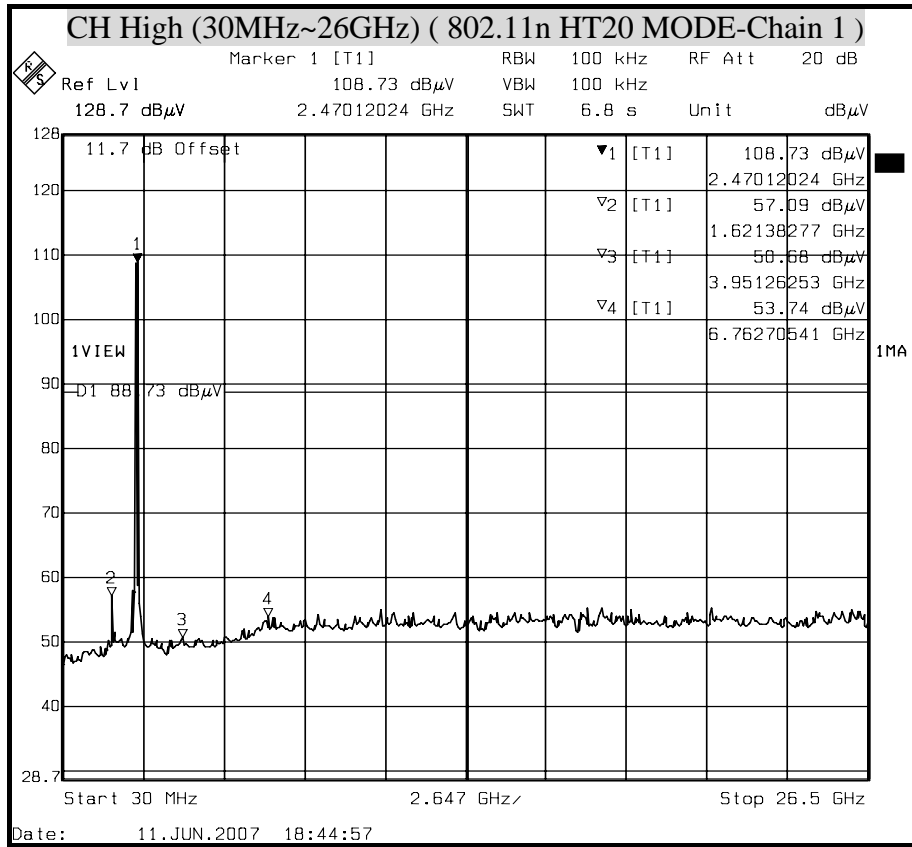



OUT-OF-BAND SPURIOUS EMISSIONS-CONDUCTED MEASUREMENT (IEEE 802.11n HT40 MODE)

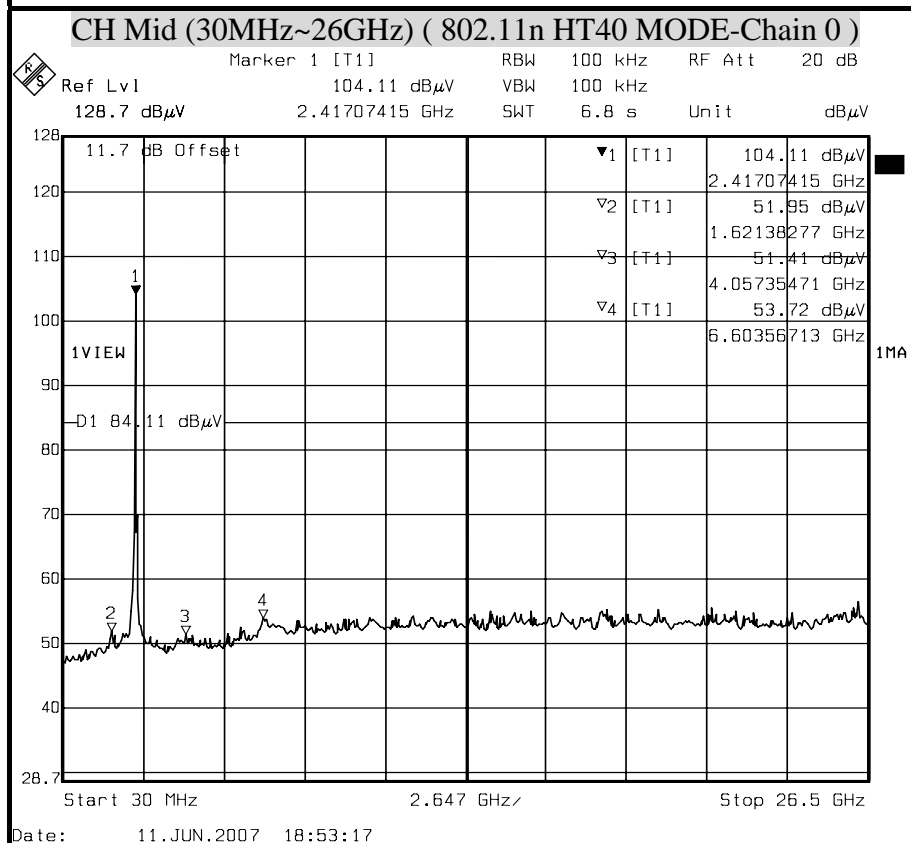
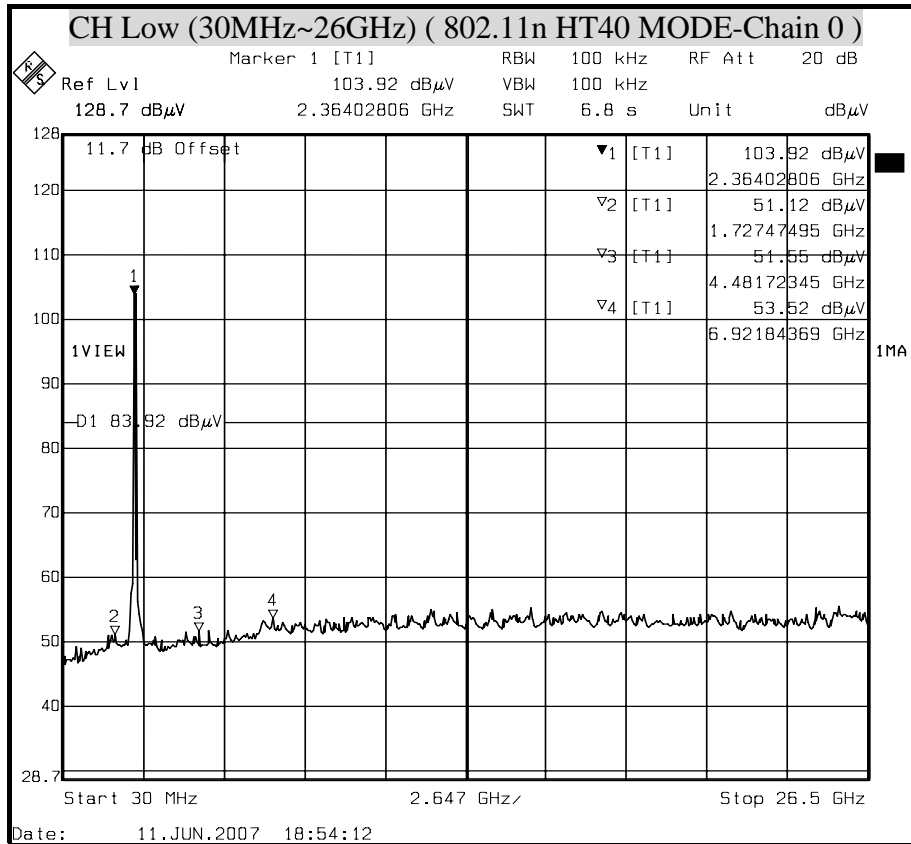

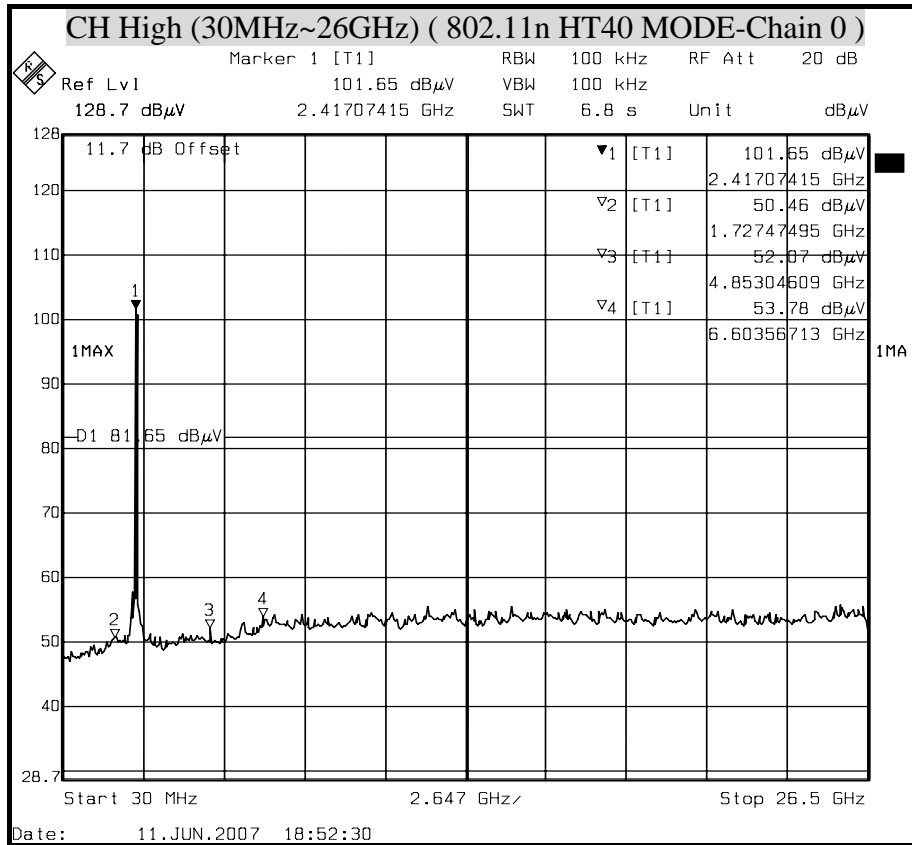

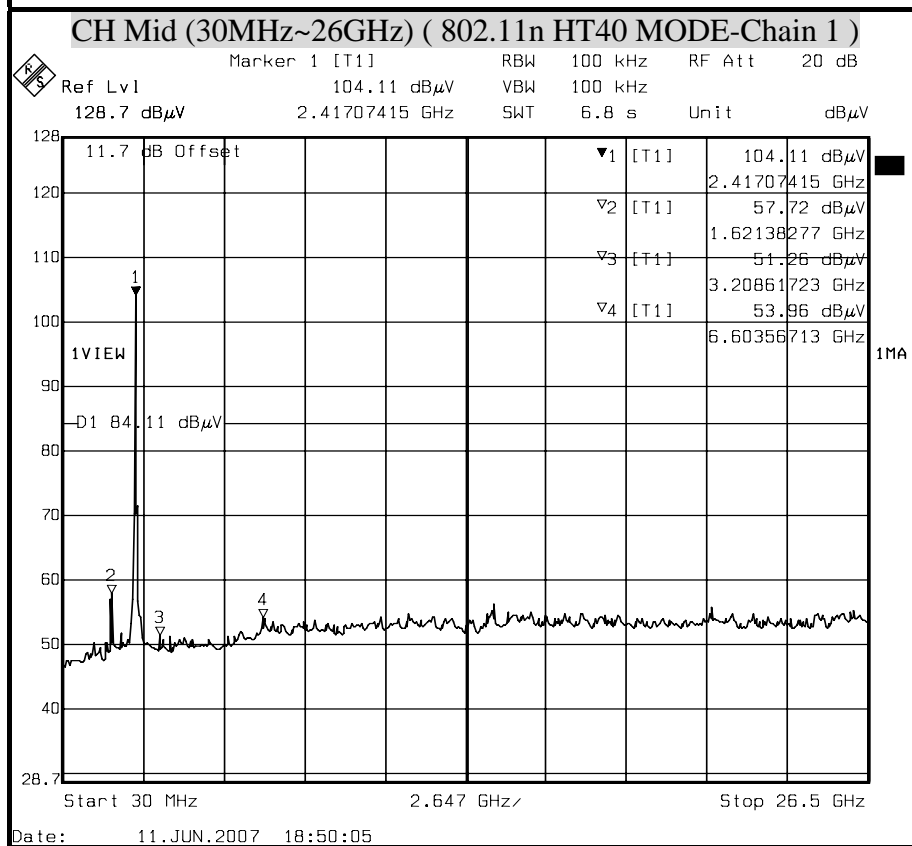
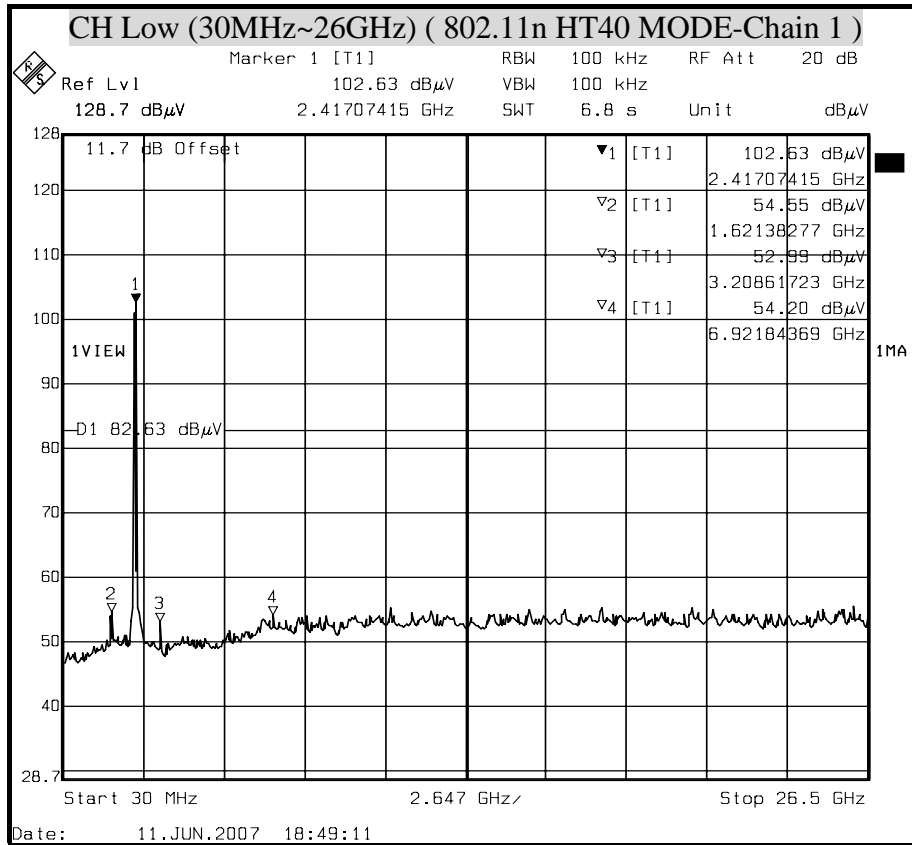

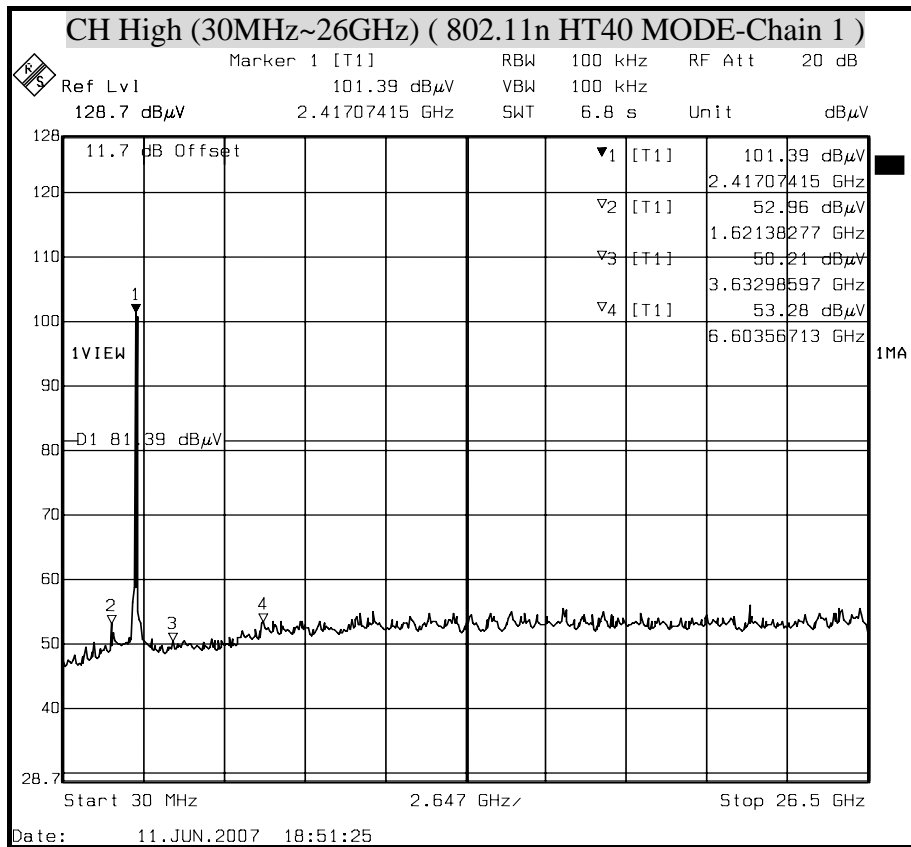



OUT-OF-BAND COMBINED SPURIOUS EMISSIONS-CONDUCTED MEASUREMENT

(IEEE 802.11b MODE Combined)

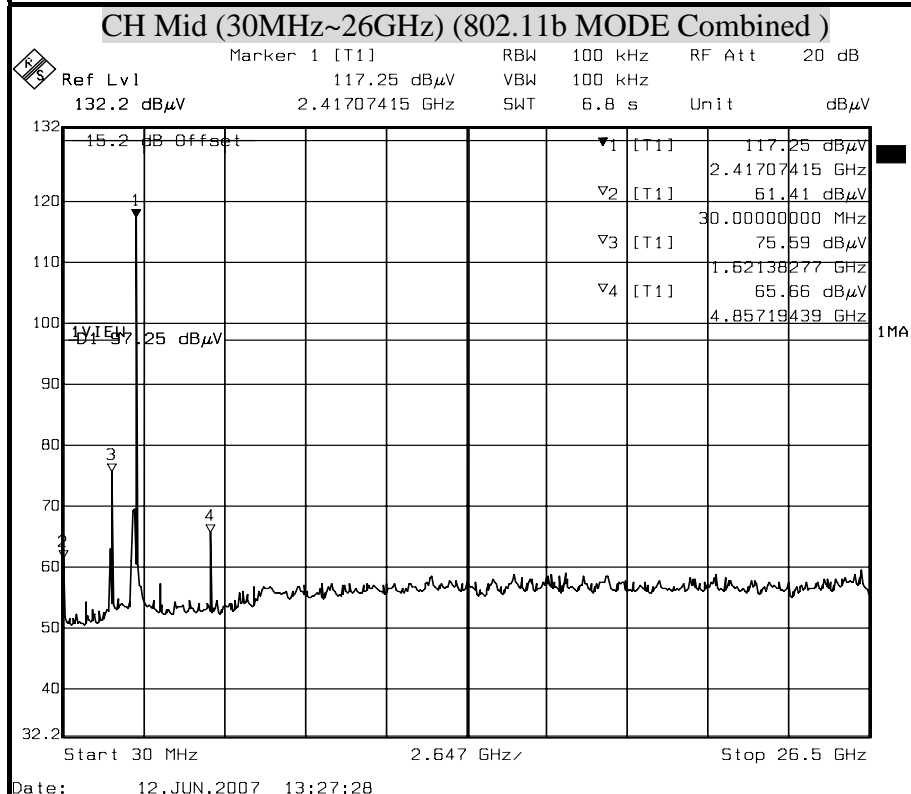
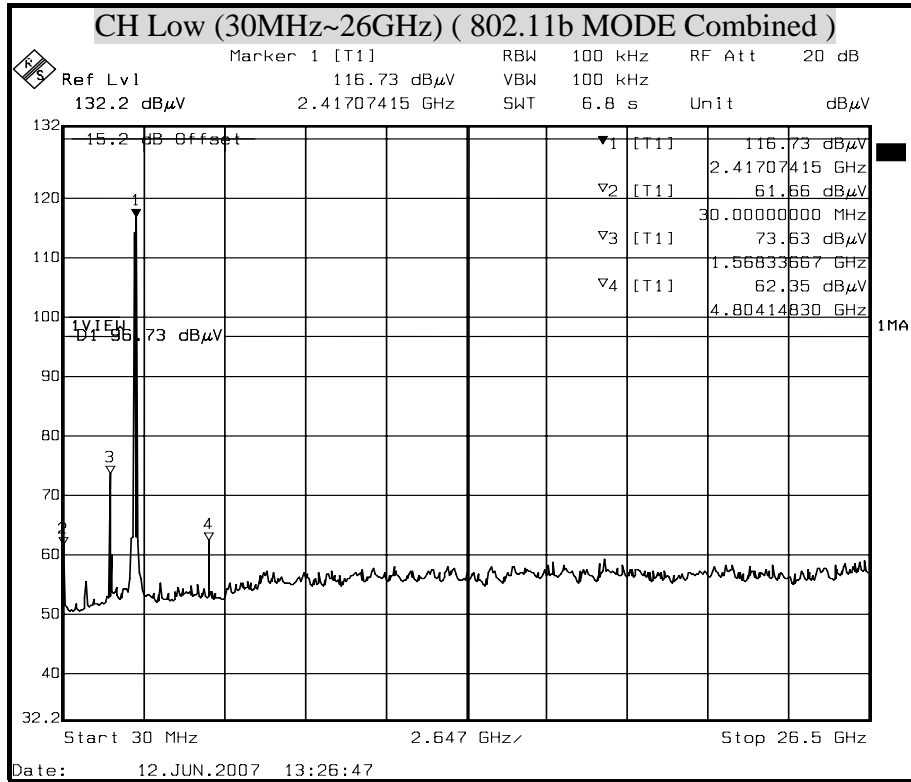

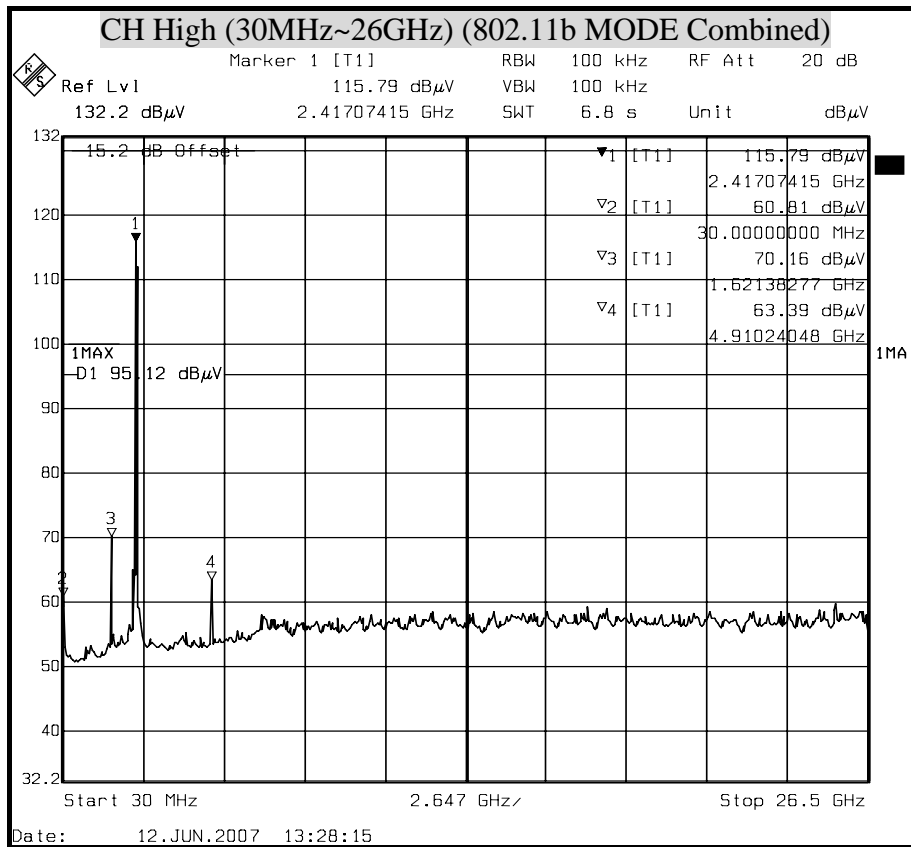



OUT-OF-BAND COMBINED SPURIOUS EMISSIONS-CONDUCTED MEASUREMENT (IEEE 802.11g MODE Combined)

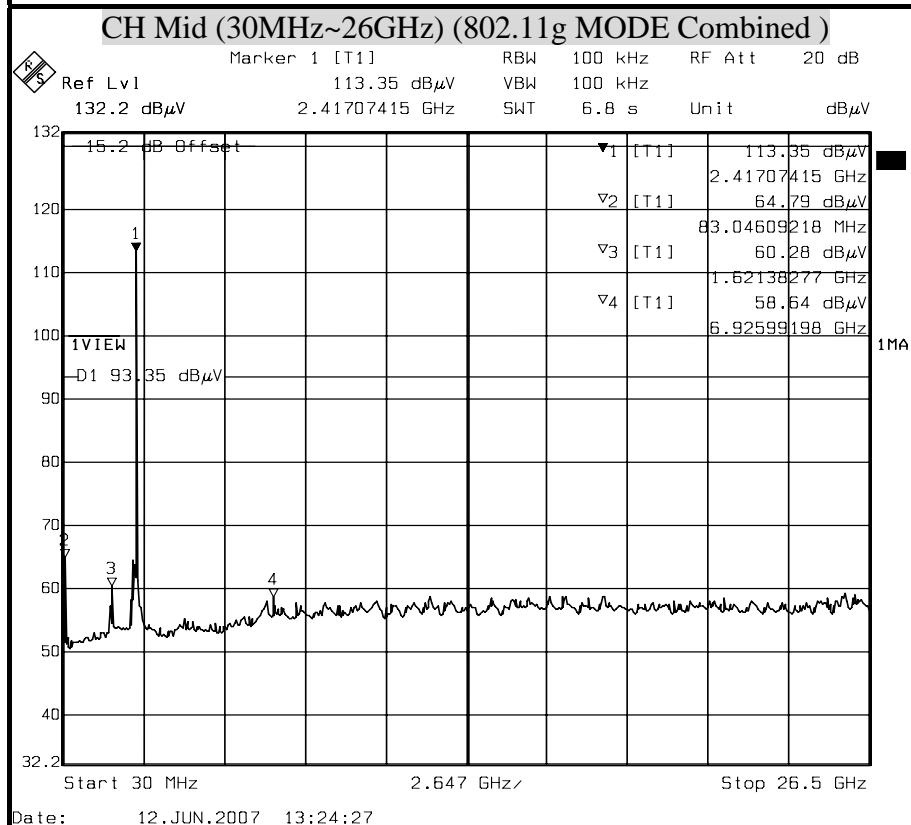
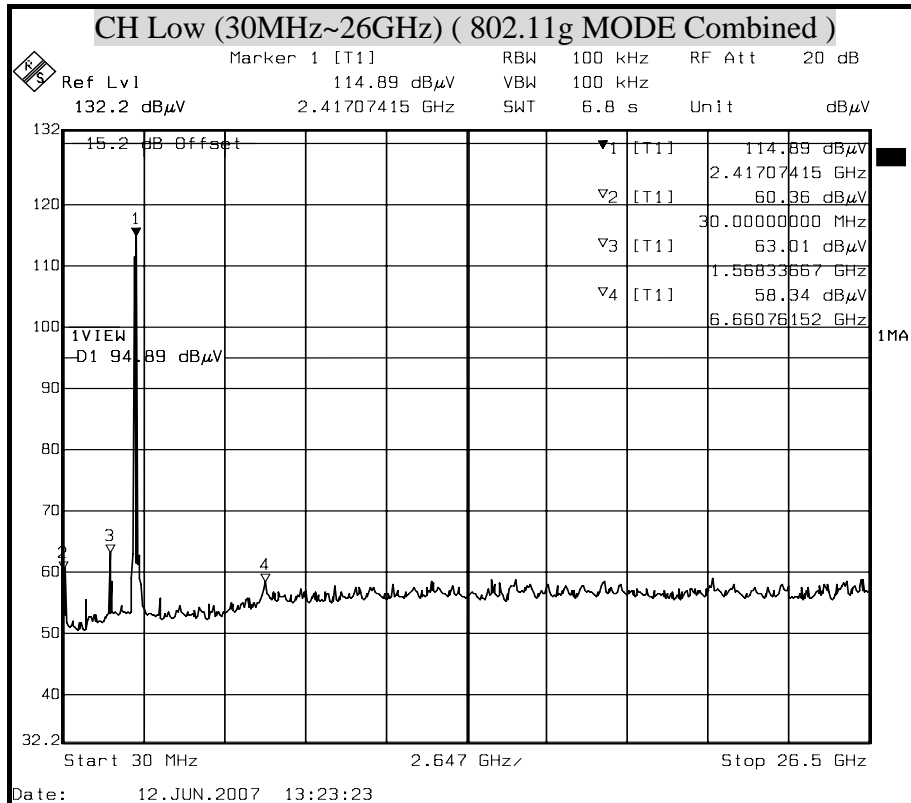

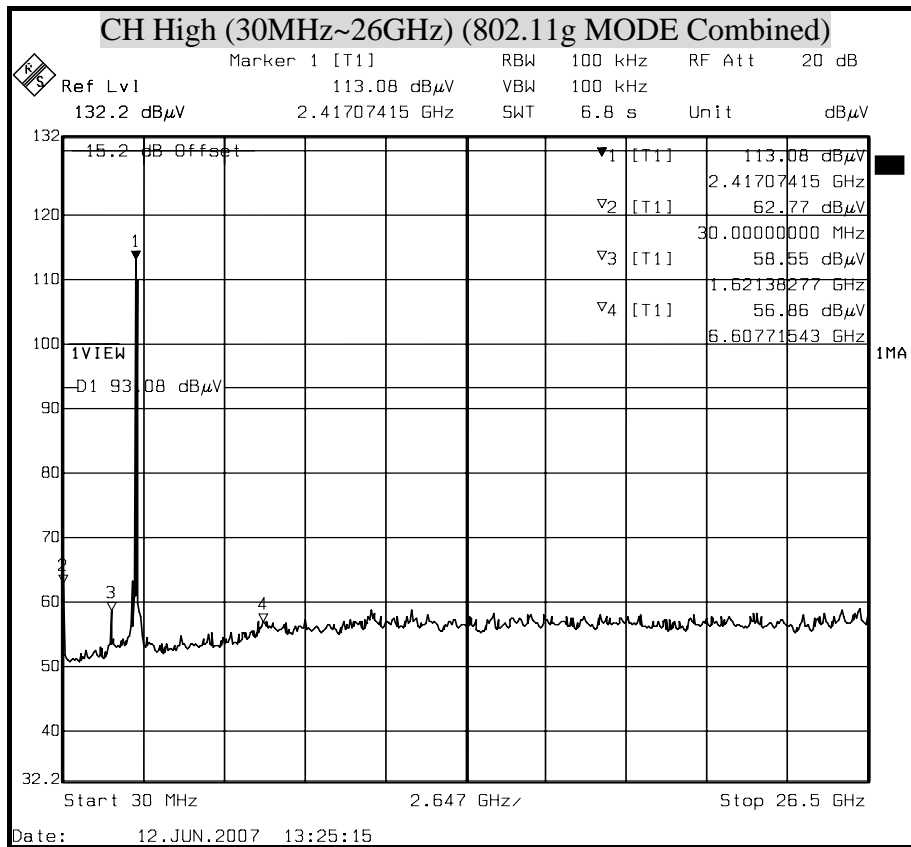



OUT-OF-BAND COMBINED SPURIOUS EMISSIONS-CONDUCTED MEASUREMENT (IEEE 802.11n HT20 MODE Combined)

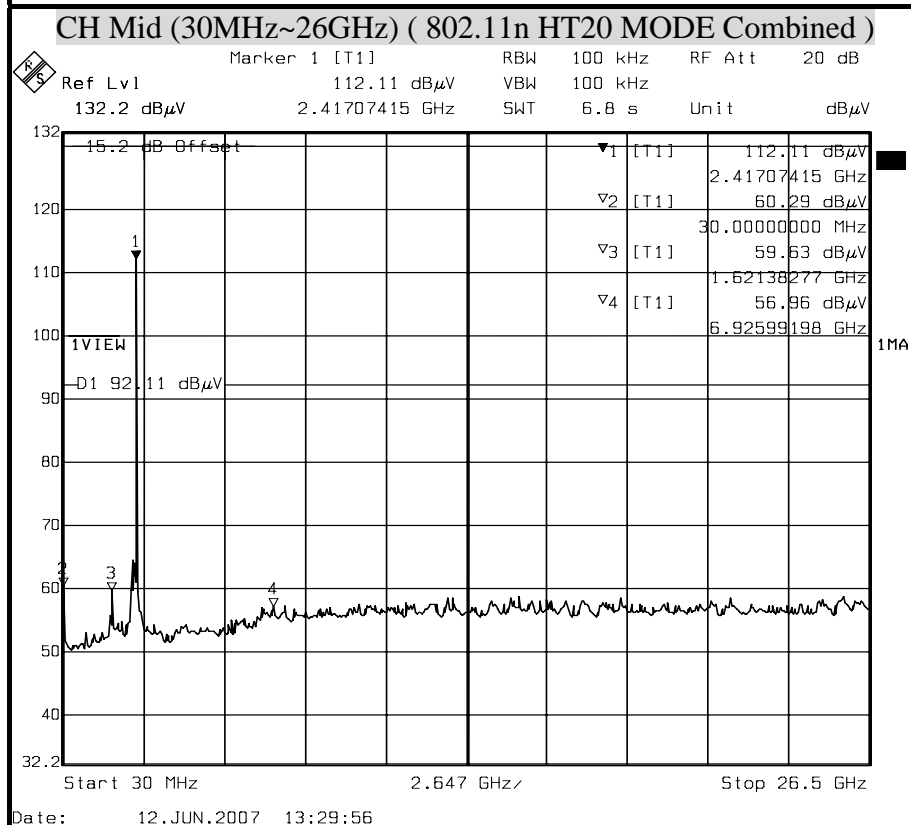
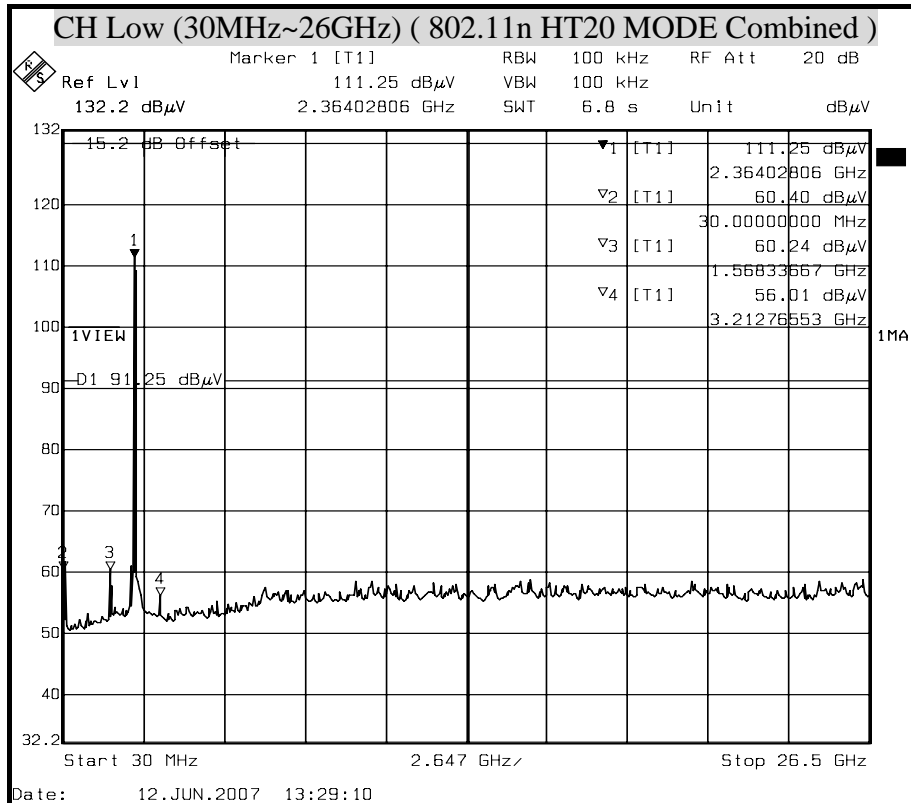

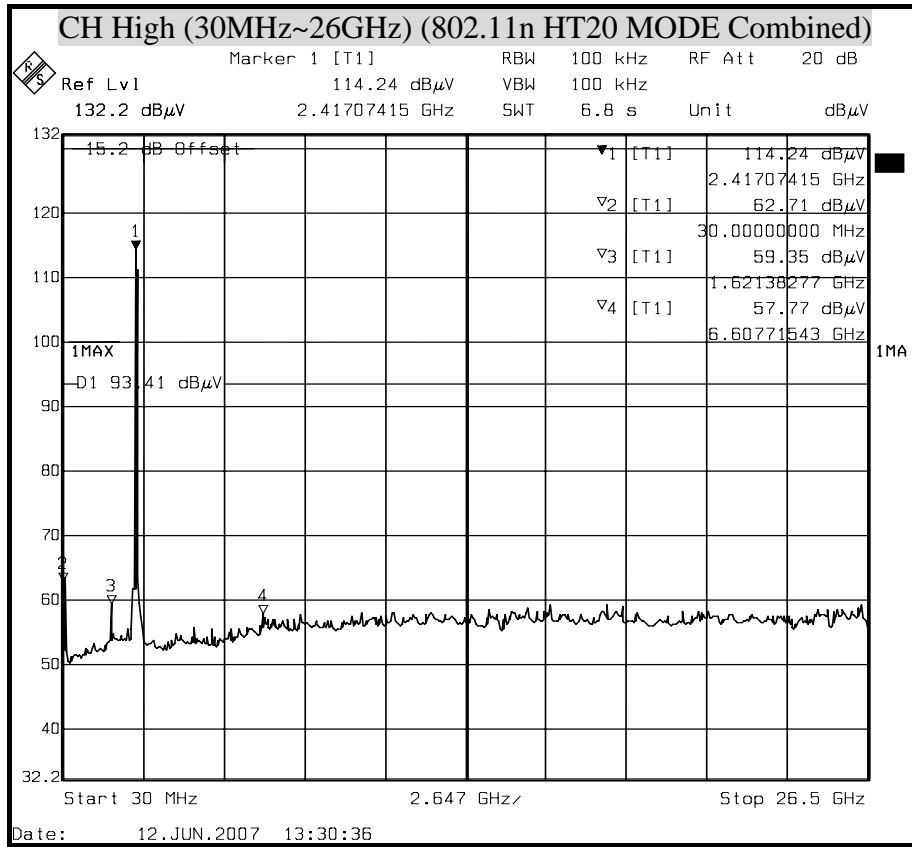



OUT-OF-BAND COMBINED SPURIOUS EMISSIONS-CONDUCTED MEASUREMENT (IEEE 802.11n HT40 MODE Combined)

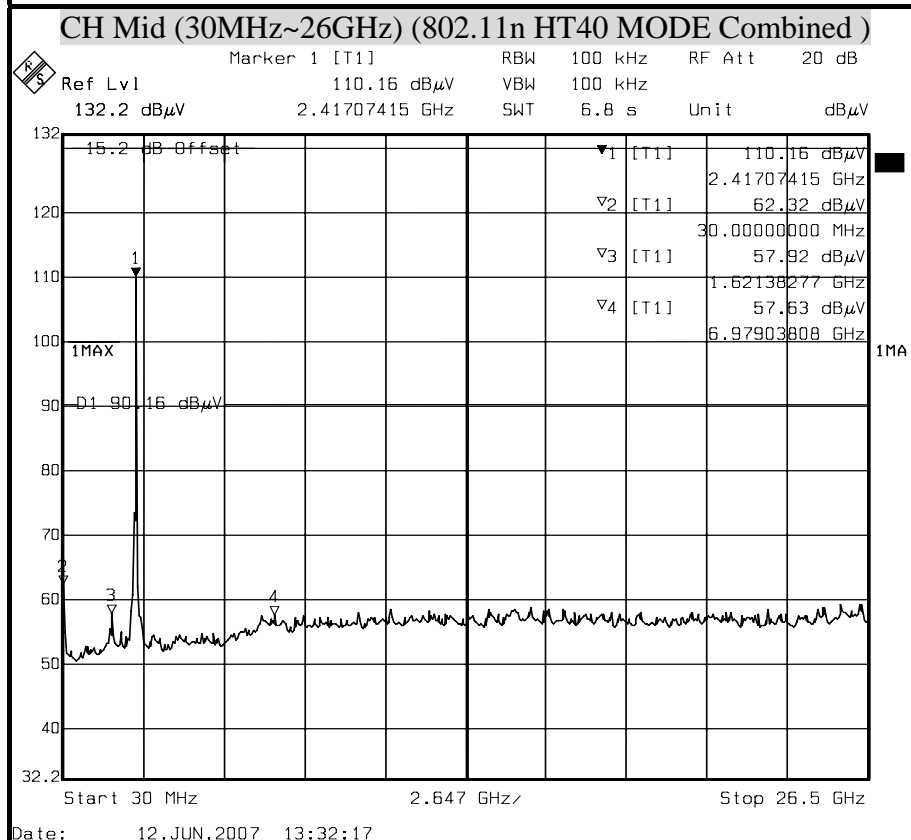
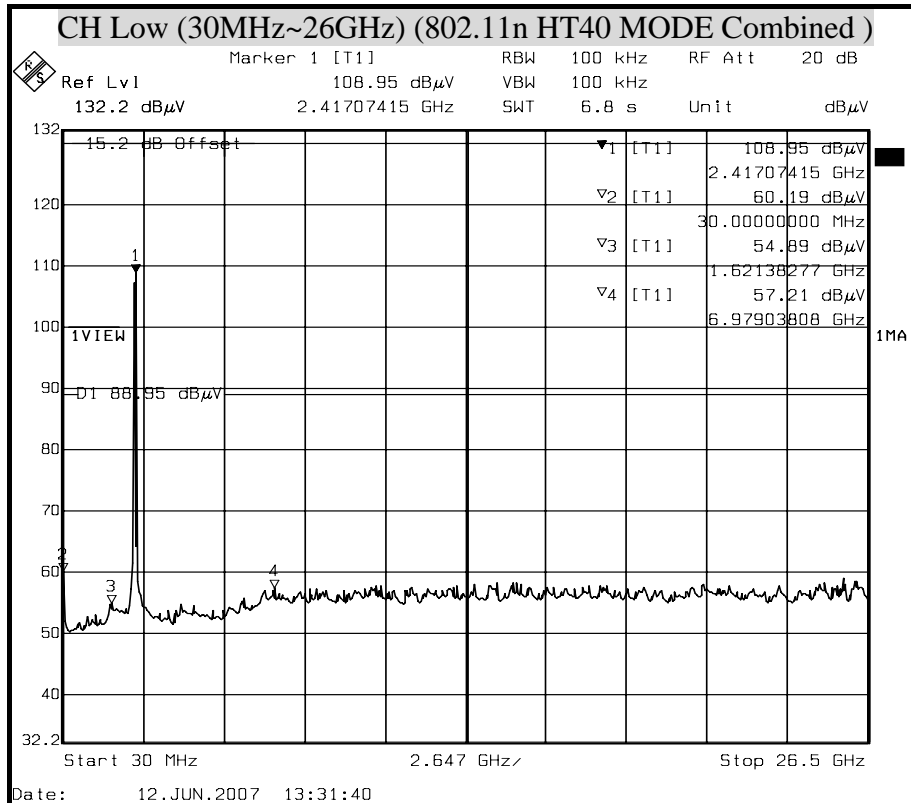

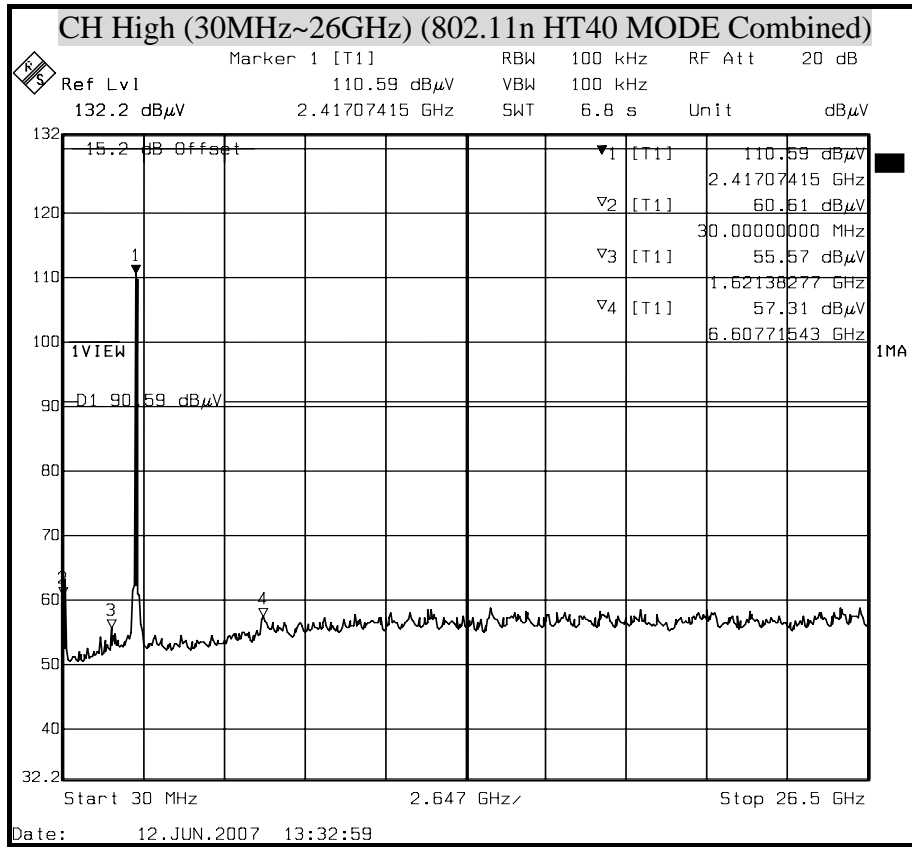



8.8 RADIATED EMISSIONS

8.8.1 TRANSMITTER RADIATED SUPURIOUS EMSSIONS

LIMITS

§ 15.205 (a) Except as shown in paragraph (d) of this section, only spurious emissions are permitted in any of the frequency bands listed below:

MHz	MHz	MHz	GHz
0.090 - 0.110	16.42 - 16.423	399.9 - 410	4.5 - 5.15
¹ 0.495 - 0.505	16.69475 - 16.69525	608 - 614	5.35 - 5.46
2.1735 - 2.1905	16.80425 - 16.80475	960 - 1240	7.25 - 7.75
4.125 - 4.128	25.5 - 25.67	1300 - 1427	8.025 - 8.5
4.17725 - 4.17775	37.5 - 38.25	1435 - 1626.5	9.0 - 9.2
4.20725 - 4.20775	73 - 74.6	1645.5 - 1646.5	9.3 - 9.5
6.215 - 6.218	74.8 - 75.2	1660 -1710	10.6 -12.7
6.26775 - 6.26825	108 -121.94	1718.8 - 1722.2	13.25 -13.4
6.31175 - 6.31225	123 - 138	2200 - 2300	14.47 – 14.5
8.291 - 8.294	149.9 - 150.05	2310 - 2390	15.35 -16.2
8.362 - 8.366	156.52475 - 156.52525	2483.5 - 2500	17.7 - 21.4
8.37625 - 8.38675	156.7 - 156.9	2655 - 2900	22.01 - 23.12
8.41425 - 8.41475	162.0125 - 167.17	3260 - 3267	23.6 - 24.0
12.29 - 12.293	167.72 - 173.2	3332 - 3339	31.2 - 31.8
12.51975 - 12.52025	240 - 285	3345.8 - 3338	36.43 - 36.5
12.57675 - 12.57725	322 -335.4	3600 - 4400	(²)
13.36 - 13.41			

¹ Until February 1, 1999, this restricted band shall be 0.490-0.510 MHz.

² Above 38.6

§ 15.205 (b) Except as provided in paragraphs (d) and (e), the field strength of emissions appearing within these frequency bands shall not exceed the limits shown in Section 15.209. At frequencies equal to or less than 1000 MHz, compliance with the limits in Section 15.209 shall be demonstrated using measurement instrumentation employing a CISPR quasi-peak detector. Above 1000 MHz, compliance with the emission limits in Section 15.209 shall be demonstrated based on the average value of the measured emissions. The provisions in Section 15.35 apply to these measurements.



§ 15.209 (a) Except as provided elsewhere in this Subpart, the emissions from an intentional radiator shall not exceed the field strength levels specified in the following table :

Frequency (MHz)	Field Strength (microvolts/meter)	Measurement Distance (meters)
30 - 88	100 **	3
88 - 216	150 **	3
216 - 960	200 **	3
Above 960	500	3

** Except as provided in paragraph (g), fundamental emissions from intentional radiators operating under this Section shall not be located in the frequency bands 54-72 MHz, 76-88 MHz, 174-216 MHz or 470-806 MHz, However, operation within these frequency bands is permitted under other sections of this Part, e-g, Sections 15.231 and 15.241.

§ 15.209 (b) In the emission table above, the tighter limit applies at the band edges.

TEST EQUIPMENTS

The following test equipments are utilized in making the measurements contained in this report.

Open Area Test Site # 6				
Name of Equipment	Manufacturer	Model	Serial Number	Calibration Due
O.A.T.S	-----	-----	No.6	NOV. 07, 2007
EMI Receiver	R&S	ESCI	100005	FEB.13, 2008
Spectrum Analyzer	R&S	FSEM	829054/017	MAR. 13, 2008
BI-LOG Antenna	Sunol	JB1	A070506-2	JUL. 11, 2007
Horn Antenna	Com-Power	AH-118	071032	NOV. 21, 2007
SMA RF CABLE	SUHNER	SUCOFLEX104PEA	20520/4PEA	NOV. 22, 2007
Pre-Amplifier	MITEQ	AFS44-00102650-42-10P-44	1073264	AUG. 15, 2007
Signal Generator	HP	8673C	2938A00663	JUN 22, 2008
Pre-Amplifier	HP	8447F	2944A03817	SEP. 04, 2007
Turn Table	Yo Chen	001	-----	N.C.R.
Antenna Tower	AR	TP1000A	309874	N.C.R.
Controller	CT	SC101	-----	N.C.R.
Test S/W	e-3 (5.04303e)			

TEST SETUP

The diagram below shows the test setup that is utilized to make the measurements for emission from 30 to 1GHz.

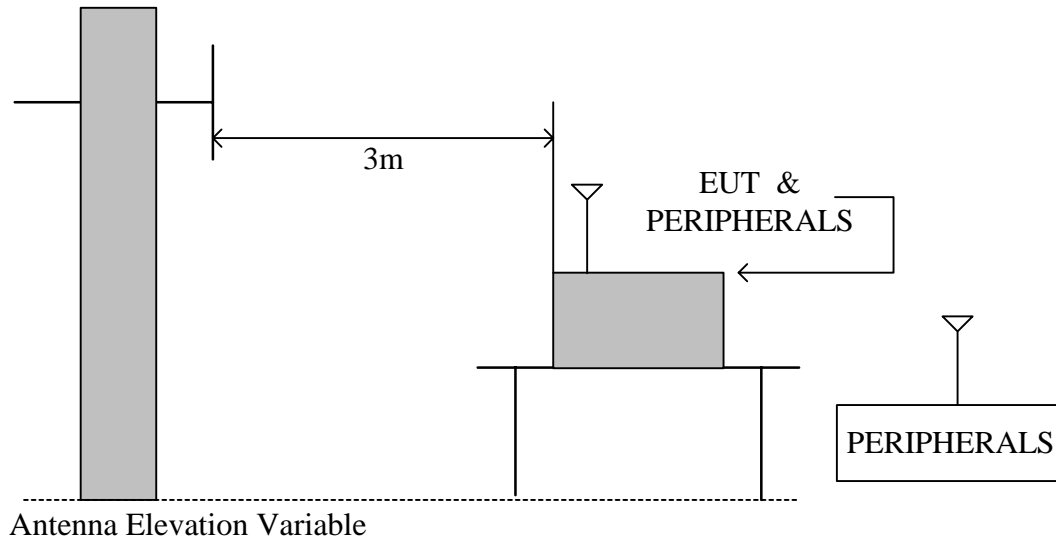

The diagram below shows the test setup that is utilized to make the measurements for emission above 1GHz.

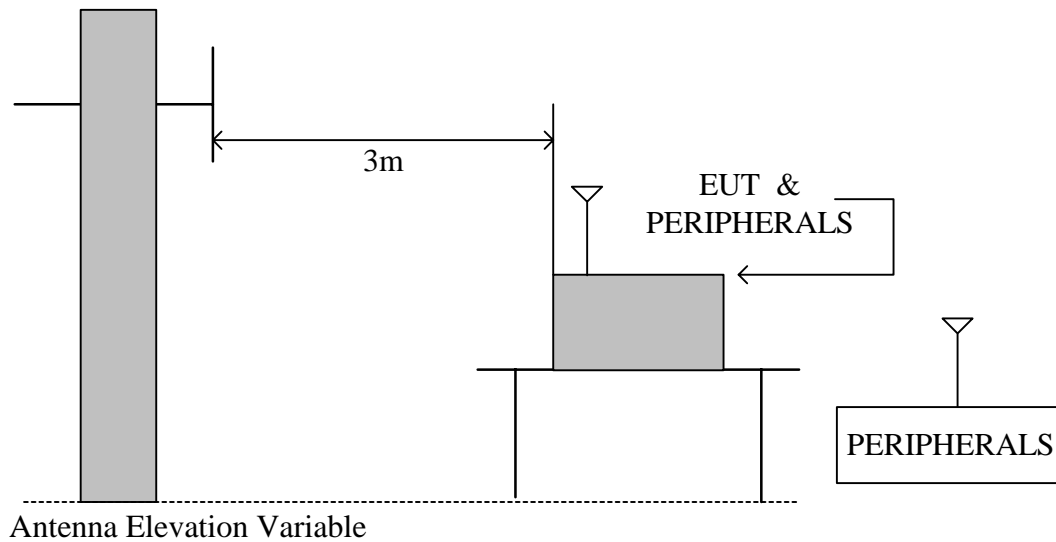



TEST PROCEDURE

- a. The EUT was placed on the top of a rotating table 0.8 meters above the ground at a 10 meter open area test site. The table was rotated 360 degrees to determine the position of the highest radiation.
- b. While measuring the radiated emission below 1GHz, the EUT was set 3 meters away from the interference-receiving antenna, which was mounted on the top of a variable-height antenna tower. While measuring the radiated emission above 1GHz, the EUT was set 3 meters away from the interference-receiving antenna
- c. The antenna is a broadband antenna, and its height is varied from one meter to four meters above the ground to determine the maximum value of the field strength. Both horizontal and vertical polarization of the antenna are set to make the measurement.
- d. For each suspected emission, the EUT was arranged to its worst case and then the antenna was tuned to heights from 1 meter to 4 meters and the table was turned from 0 degrees to 360 degrees to find the maximum reading.
- e. The test-receiver system was set to Peak Detect Function and Specified Bandwidth with Maximum Hold Mode.
- f. If the emission level of the EUT in peak mode was 10 dB lower than the limit specified, then testing could be stopped and the peak values of the EUT would be reported. Otherwise the emissions that did not have 10 dB margin would be re-tested one by one using peak, quasi-peak or average method as specified and then reported in a data sheet.

Note:

1. The resolution bandwidth and video bandwidth of test receiver/spectrum analyzer is 120 KHz for Peak detection (PK) and Quasi-peak detection (QP) at frequency below 1GHz.
2. The resolution bandwidth and video bandwidth of test receiver/spectrum analyzer is 1 MHz for Peak detection and frequency above 1GHz.
3. The resolution bandwidth of test receiver/spectrum analyzer is 1 MHz and the video bandwidth is 10 Hz for Average detection (AV) at frequency above 1GHz.

TEST RESULTS

No non-compliance noted

**8.8.2 WORST-CASE RADIATED EMISSION BELOW 1 GHz**

Product Name	AirCruiser N300 Mini-PCI Adapter	Test Date	2007/6/12
Model	GN-WI30N-RH	Test By	Eric Yang
Test Mode	Normal operating (worst case)	TEMP& Humidity	28.9°C, 57%

Horizontal

Frequency	Meter Reading	Antenna Factor	Cable Loss	Emission Level	Limits	Margin	Detector Mode
(MHz)	(dB μ V)	(dB/M)	(dB)	(dB μ V/M)	(dB μ V/M)	(dB)	PK/QP
52.48	18.64	8.15	0.96	27.76	40.00	-12.24	PK
165.24	12.47	12.29	1.63	26.38	43.50	-17.12	PK
200.00	15.24	13.50	1.79	30.53	43.50	-12.97	PK
367.82	13.28	15.49	3.31	32.08	46.00	-13.92	PK
450.02	11.47	17.10	3.38	31.95	46.00	-14.05	PK
500.00	6.57	18.00	3.05	27.62	46.00	-18.38	PK
800.00	7.45	21.80	4.14	33.39	46.00	-12.61	PK
N/A	-----	-----	-----	-----	-----	-----	-----

Vertical

Frequency	Meter Reading	Antenna Factor	Cable Loss	Emission Level	Limits	Margin	Detector Mode
(MHz)	(dB μ V)	(dB/M)	(dB)	(dB μ V/M)	(dB μ V/M)	(dB)	PK/QP
59.24	13.47	7.75	0.98	22.19	40.00	-17.81	PK
165.34	13.59	12.28	1.63	27.50	43.50	-16.00	PK
200.00	15.47	13.50	1.79	30.76	43.50	-12.74	PK
267.65	15.96	12.84	2.18	30.97	46.00	-15.03	PK
333.70	12.54	14.74	2.89	30.17	46.00	-15.83	PK
500.00	5.82	18.00	3.05	26.87	46.00	-19.13	PK
666.67	8.54	20.17	3.70	32.41	46.00	-13.59	PK
N/A	-----	-----	-----	-----	-----	-----	-----

Remark: Emission level (dB μ V/m) = Antenna Factor (dB/m) + Cable loss (dB) + Meter Reading (dB μ V).



8.8.3 TRANSMITTER RADIATED EMISSION ABOVE 1 GHz

Product Name	AirCruiser N300 Mini-PCI Adapter	Test Date	2007/6/9
Model	GN-WI30N-RH	Test By	Eric Yang
Test Mode	IEEE 802.11b TX (CH Low)	TEMP& Humidity	28.1°C, 60%

Horizontal

TX / IEEE 802.11b mode / CH Low				Measurement Distance at 3m				Horizontal polarity		
Freq.	Reading	AF	Cable Loss	Pre-amp	Filter	Level	Limit	Margin	Mark	
(MHz)	(dBµV)	(dB/m)	(dB)	(dB)	(dB)	(dBµV/m)	(dBµV/m)	(dB)	(P/Q/A)	
2414.70	112.52	30.05	2.34	39.79	0.00	105.12	Fundamental Frequency		P	
2414.70	109.41	30.05	2.34	39.79	0.00	102.01			A	
* 1607.95	62.66	27.32	2.11	39.86	0.84	53.07	74.00	-20.93	P	
* 1607.95	59.84	27.32	2.11	39.86	0.84	50.25	54.00	-3.75	A	
3216.57	48.29	30.03	2.77	40.22	1.26	42.13	85.12	-42.99	P	
3216.57	39.51	30.03	2.77	40.22	1.26	33.35	82.01	-48.66	A	
* 4825.47	58.21	32.82	3.71	41.34	0.69	54.09	74.00	-19.91	P	
* 4825.47	54.96	32.82	3.71	41.34	0.69	50.84	54.00	-3.16	A	
7238.44	48.29	38.83	4.93	41.42	1.44	52.07	85.12	-33.05	P	
7238.44	38.61	38.83	4.93	41.42	1.44	42.39	82.01	-39.62	A	
N/A	-----	-----	-----	-----	-----	-----	-----	-----	P	
N/A	-----	-----	-----	-----	-----	-----	-----	-----	A	

Remark:

1. AF: Antenna Factor, Cable: Cable Loss, Pre-Amp: Preamplifier gain, Filter: High Pass Filter Insertion Loss (3.5GHz)
2. Spectrum analyzer setting P(Peak): RBW=1MHz, VBW=1MHz, A(Average): RBW=1MHz, VBW=10Hz
3. The result basic equation calculation is as follow:
 $Level = Reading + AF + Cable - Preamp + Filter - Dist, Margin = Level - Limit$
4. The other emission levels were 20dB below the limit
5. The test limit distance is 3M limit.



Product Name	AirCruiser N300 Mini-PCI Adapter	Test Date	2007/6/9
Model	GN-WI30N-RH	Test By	Eric Yang
Test Mode	IEEE 802.11b TX (CH Low)	TEMP& Humidity	28.1°C, 60%

Vertical

TX / IEEE 802.11b mode / CH Low				Measurement Distance at 3m				Vertical polarity		
Freq.	Reading	AF	Cable Loss	Pre-amp	Filter	Level	Limit	Margin	Mark	
(MHz)	(dBµV)	(dB/m)	(dB)	(dB)	(dB)	(dBµV/m)	(dBµV/m)	(dB)	(P/Q/A)	
2414.67	115.52	30.05	2.34	39.79	0.00	108.12	Fundamental Frequency		P	
2414.67	112.72	30.05	2.34	39.79	0.00	105.32			A	
* 1607.96	66.46	27.32	2.11	39.86	0.84	56.87	74.00	-17.13	P	
* 1607.96	62.14	27.32	2.11	39.86	0.84	52.55	54.00	-1.45	A	
3215.85	49.60	30.03	2.77	40.22	1.26	43.44	88.12	-44.68	P	
3215.85	46.09	30.03	2.77	40.22	1.26	39.93	85.32	-45.39	A	
* 4823.96	60.37	32.81	3.70	41.34	0.69	56.24	74.00	-17.76	P	
* 4823.96	56.86	32.81	3.70	41.34	0.69	52.73	54.00	-1.27	A	
7237.69	49.67	38.83	4.93	41.42	1.44	53.45	88.12	-34.67	P	
7237.69	40.90	38.83	4.93	41.42	1.44	44.68	85.32	-40.64	A	
N/A	-----	-----	-----	-----	-----	-----	-----	-----	P	
N/A	-----	-----	-----	-----	-----	-----	-----	-----	A	

Remark:

1. AF: Antenna Factor, Cable: Cable Loss, Pre-Amp: Preamplifier gain, Filter: High Pass Filter Insertion Loss (3.5GHz)
2. Spectrum analyzer setting P(Peak): RBW=1MHz, VBW=1MHz, A(Average): RBW=1MHz, VBW=10Hz
3. The result basic equation calculation is as follow:
 $Level = Reading + AF + Cable - Preamp + Filter - Dist, Margin = Level - Limit$
4. The other emission levels were 20dB below the limit
5. The test limit distance is 3M limit.



Product Name	AirCruiser N300 Mini-PCI Adapter	Test Date	2007/6/9
Model	GN-WI30N-RH	Test By	Eric Yang
Test Mode	IEEE 802.11b TX (CH Middle)	TEMP& Humidity	28.1 °C, 60%

Horizontal

TX / IEEE 802.11b mode / CH Middle				Measurement Distance at 3m				Horizontal polarity		
Freq.	Reading	AF	Cable Loss	Pre-amp	Filter	Level	Limit	Margin	Mark	
(MHz)	(dBµV)	(dB/m)	(dB)	(dB)	(dB)	(dBµV/m)	(dBµV/m)	(dB)	(P/Q/A)	
2440.54	112.74	30.04	2.34	39.77	0.00	105.35	Fundamental Frequency		P	
2440.54	109.88	30.04	2.34	39.77	0.00	102.49			A	
* 1622.58	64.57	27.43	2.12	39.87	0.85	55.10	74.00	-18.90	P	
* 1622.58	60.57	27.43	2.12	39.87	0.85	51.10	54.00	-2.90	A	
3250.47	47.81	30.05	2.82	40.25	1.21	41.65	85.35	-43.70	P	
3250.47	37.96	30.05	2.82	40.25	1.21	31.80	82.49	-50.69	A	
* 4872.69	61.49	32.92	3.73	41.41	0.71	57.44	74.00	-16.56	P	
* 4872.69	54.37	32.92	3.73	41.41	0.71	50.32	54.00	-3.68	A	
* 7311.18	52.49	38.94	4.96	41.32	1.60	56.66	74.00	-17.34	P	
* 7311.18	43.68	38.94	4.96	41.32	1.60	47.85	54.00	-6.15	A	
N/A	-----	-----	-----	-----	-----	-----	-----	-----	P	
N/A	-----	-----	-----	-----	-----	-----	-----	-----	A	

Remark:

1. AF: Antenna Factor, Cable: Cable Loss, Pre-Amp: Preamplifier gain, Filter: High Pass Filter Insertion Loss (3.5GHz)
2. Spectrum analyzer setting P(Peak): RBW=1MHz, VBW=1MHz, A(Average): RBW=1MHz, VBW=10Hz
3. The result basic equation calculation is as follow:
 $Level = Reading + AF + Cable - Preamp + Filter - Dist$, $Margin = Level - Limit$
4. The other emission levels were 20dB below the limit
5. The test limit distance is 3M limit.



Product Name	AirCruiser N300 Mini-PCI Adapter	Test Date	2007/6/9
Model	GN-WI30N-RH	Test By	Eric Yang
Test Mode	IEEE 802.11b TX (CH Middle)	TEMP& Humidity	28.1 °C, 60%

Vertical

TX / IEEE 802.11b mode / CH Middle				Measurement Distance at 3m Vertical polarity						
Freq.	Reading	AF	Cable Loss	Pre-amp	Filter	Level	Limit	Margin	Mark	
(MHz)	(dBµV)	(dB/m)	(dB)	(dB)	(dB)	(dBµV/m)	(dBµV/m)	(dB)	(P/Q/A)	
2440.58	115.33	30.04	2.34	39.77	0.00	107.94	Fundamental Frequency		P	
2440.58	112.45	30.04	2.34	39.77	0.00	105.06			A	
* 1624.65	66.84	27.45	2.12	39.87	0.85	57.39	74.00	-16.61	P	
* 1624.65	62.15	27.45	2.12	39.87	0.85	52.70	54.00	-1.30	A	
3249.40	46.82	30.05	2.82	40.24	1.22	40.66	87.94	-47.28	P	
3249.40	40.71	30.05	2.82	40.24	1.22	34.55	85.06	-50.51	A	
* 4873.96	62.05	32.92	3.73	41.41	0.71	58.01	74.00	-15.99	P	
* 4873.96	56.52	32.92	3.73	41.41	0.71	52.48	54.00	-1.52	A	
* 7309.27	53.39	38.93	4.96	41.32	1.59	57.55	74.00	-16.45	P	
* 7309.27	45.52	38.93	4.96	41.32	1.59	49.68	54.00	-4.32	A	
N/A	-----	-----	-----	-----	-----	-----	-----	-----	P	
N/A	-----	-----	-----	-----	-----	-----	-----	-----	A	

Remark:

1. AF: Antenna Factor, Cable: Cable Loss, Pre-Amp: Preamplifier gain, Filter: High Pass Filter Insertion Loss (3.5GHz)
2. Spectrum analyzer setting P(Peak): RBW=1MHz, VBW=1MHz, A(Average): RBW=1MHz, VBW=10Hz
3. The result basic equation calculation is as follow:
 $Level = Reading + AF + Cable - Preamp + Filter - Dist$, $Margin = Level - Limit$
4. The other emission levels were 20dB below the limit
5. The test limit distance is 3M limit.



Product Name	AirCruiser N300 Mini-PCI Adapter	Test Date	2007/6/9
Model	GN-WI30N-RH	Test By	Eric Yang
Test Mode	IEEE 802.11b TX (CH High)	TEMP& Humidity	28.1 °C, 60%

Horizontal

TX / IEEE 802.11b mode / CH High				Measurement Distance at 3m				Horizontal polarity		
Freq.	Reading	AF	Cable Loss	Pre-amp	Filter	Level	Limit	Margin	Mark	
(MHz)	(dBµV)	(dB/m)	(dB)	(dB)	(dB)	(dBµV/m)	(dBµV/m)	(dB)	(P/Q/A)	
2464.76	111.39	30.02	2.34	39.75	0.00	104.00	Fundamental Frequency		P	
2464.76	108.44	30.02	2.34	39.75	0.00	101.05			A	
1643.57	64.82	27.59	2.13	39.88	0.86	55.52	84.00	-28.48	P	
1643.57	63.57	27.59	2.13	39.88	0.86	54.27	81.05	-26.78	A	
3279.84	46.93	30.07	2.87	40.27	1.18	40.77	84.00	-43.23	P	
3279.84	38.17	30.07	2.87	40.27	1.18	32.01	81.05	-49.04	A	
* 4925.17	58.63	33.04	3.76	41.49	0.73	54.67	74.00	-19.33	P	
* 4925.17	53.78	33.04	3.76	41.49	0.73	49.82	54.00	-4.18	A	
* 7381.49	49.68	39.03	4.99	41.22	1.75	54.23	74.00	-19.77	P	
* 7381.49	39.25	39.03	4.99	41.22	1.75	43.80	54.00	-10.20	A	
N/A	-----	-----	-----	-----	-----	-----	-----	-----	P	
N/A	-----	-----	-----	-----	-----	-----	-----	-----	A	

Remark:

1. AF: Antenna Factor, Cable: Cable Loss, Pre-Amp: Preamplifier gain, Filter: High Pass Filter Insertion Loss (3.5GHz)
2. Spectrum analyzer setting P(Peak): RBW=1MHz, VBW=1MHz, A(Average): RBW=1MHz, VBW=10Hz
3. The result basic equation calculation is as follow:
 $Level = Reading + AF + Cable - Preamp + Filter - Dist, Margin = Level - Limit$
4. The other emission levels were 20dB below the limit
5. The test limit distance is 3M limit.



Product Name	AirCruiser N300 Mini-PCI Adapter	Test Date	2007/6/9
Model	GN-WI30N-RH	Test By	Eric Yang
Test Mode	IEEE 802.11b TX (CH High)	TEMP& Humidity	28.1 °C, 60%

Vertical

TX / IEEE 802.11b mode / CH High				Measurement Distance at 3m				Vertical polarity		
Freq.	Reading	AF	Cable Loss	Pre-amp	Filter	Level	Limit	Margin	Mark	
(MHz)	(dBµV)	(dB/m)	(dB)	(dB)	(dB)	(dBµV/m)	(dBµV/m)	(dB)	(P/Q/A)	
2464.70	115.05	30.02	2.34	39.75	0.00	107.66	Fundamental Frequency		P	
2464.70	112.17	30.02	2.34	39.75	0.00	104.78			A	
1641.34	67.28	27.57	2.13	39.88	0.86	57.96	87.66	-29.70	P	
1641.34	66.65	27.57	2.13	39.88	0.86	57.33	84.78	-27.45	A	
3282.53	45.84	30.07	2.87	40.27	1.17	39.68	87.66	-47.98	P	
3282.53	39.65	30.07	2.87	40.27	1.17	33.49	84.78	-51.29	A	
* 4923.90	60.25	33.03	3.76	41.49	0.73	56.29	74.00	-17.71	P	
* 4923.90	56.74	33.03	3.76	41.49	0.73	52.78	54.00	-1.22	A	
* 7383.15	50.82	39.04	4.99	41.22	1.75	55.38	74.00	-18.62	P	
* 7383.15	41.52	39.04	4.99	41.22	1.75	46.08	54.00	-7.92	A	
N/A	-----	-----	-----	-----	-----	-----	-----	-----	P	
N/A	-----	-----	-----	-----	-----	-----	-----	-----	A	

Remark:

1. AF: Antenna Factor, Cable: Cable Loss, Pre-Amp: Preamplifier gain, Filter: High Pass Filter Insertion Loss (3.5GHz)
2. Spectrum analyzer setting P(Peak): RBW=1MHz, VBW=1MHz, A(Average): RBW=1MHz, VBW=10Hz
3. The result basic equation calculation is as follow:
 $Level = Reading + AF + Cable - Preamp + Filter - Dist, Margin = Level - Limit$
4. The other emission levels were 20dB below the limit
5. The test limit distance is 3M limit.



Product Name	AirCruiser N300 Mini-PCI Adapter	Test Date	2007/6/9
Model	GN-WI30N-RH	Test By	Eric Yang
Test Mode	IEEE 802.11g TX (CH Low)	TEMP& Humidity	28.1°C, 60%

Horizontal

TX / IEEE 802.11g mode / CH Low				Measurement Distance at 3m			Horizontal polarity		
Freq.	Reading	AF	Cable Loss	Pre-amp	Filter	Level	Limit	Margin	Mark
(MHz)	(dBµV)	(dB/m)	(dB)	(dB)	(dB)	(dBµV/m)	(dBµV/m)	(dB)	(P/Q/A)
2415.02	114.86	30.05	2.34	39.79	0.00	107.46	Fundamental Frequency		P
2415.02	106.81	30.05	2.34	39.79	0.00	99.41			A
* 1607.84	67.52	27.32	2.11	39.86	0.84	57.93	74.00	-16.07	P
* 1607.84	54.36	27.32	2.11	39.86	0.84	44.77	54.00	-9.23	A
3218.57	46.28	30.03	2.77	40.22	1.26	40.12	87.46	-47.34	P
3218.57	40.19	30.03	2.77	40.22	1.26	34.03	79.41	-45.38	A
* 4827.24	56.34	32.82	3.71	41.34	0.69	52.22	74.00	-21.78	P
* 4827.24	43.28	32.82	3.71	41.34	0.69	39.16	54.00	-14.84	A
7233.48	50.18	38.83	4.93	41.43	1.43	53.94	87.46	-33.53	P
7233.48	37.98	38.83	4.93	41.43	1.43	41.74	79.41	-37.68	A
N/A	-----	-----	-----	-----	-----	-----	-----	-----	P
N/A	-----	-----	-----	-----	-----	-----	-----	-----	A

Remark:

1. AF: Antenna Factor, Cable: Cable Loss, Pre-Amp: Preamplifier gain, Filter: High Pass Filter Insertion Loss (3.5GHz)
2. Spectrum analyzer setting P(Peak): RBW=1MHz, VBW=1MHz, A(Average): RBW=1MHz, VBW=10Hz
3. The result basic equation calculation is as follow:
 $Level = Reading + AF + Cable - Preamp + Filter - Dist, Margin = Level - Limit$
4. The other emission levels were 20dB below the limit
5. The test limit distance is 3M limit.



Product Name	AirCruiser N300 Mini-PCI Adapter	Test Date	2007/6/9
Model	GN-WI30N-RH	Test By	Eric Yang
Test Mode	IEEE 802.11g TX (CH Low)	TEMP& Humidity	28.1°C, 60%

Vertical

TX / IEEE 802.11g mode / CH Low				Measurement Distance at 3m				Vertical polarity	
Freq.	Reading	AF	Cable Loss	Pre-amp	Filter	Level	Limit	Margin	Mark
(MHz)	(dBμV)	(dB/m)	(dB)	(dB)	(dB)	(dBμV/m)	(dBμV/m)	(dB)	(P/Q/A)
2414.85	116.54	30.05	2.34	39.79	0.00	109.14	Fundamental Frequency		P
2414.85	108.61	30.05	2.34	39.79	0.00	101.21			A
* 1612.63	67.95	27.36	2.11	39.86	0.85	58.40	74.00	-15.60	P
* 1612.63	56.75	27.36	2.11	39.86	0.85	47.20	54.00	-6.80	A
3216.02	47.56	30.03	2.77	40.22	1.26	41.40	89.14	-47.74	P
3216.02	42.34	30.03	2.77	40.22	1.26	36.18	81.21	-45.03	A
* 4826.19	59.07	32.82	3.71	41.34	0.69	54.95	74.00	-19.05	P
* 4826.19	47.41	32.82	3.71	41.34	0.69	43.29	54.00	-10.71	A
7235.18	53.50	38.83	4.93	41.43	1.43	57.27	89.14	-31.88	P
7235.18	40.90	38.83	4.93	41.43	1.43	44.67	81.21	-36.55	A
N/A	-----	-----	-----	-----	-----	-----	-----	-----	P
N/A	-----	-----	-----	-----	-----	-----	-----	-----	A

Remark:

1. AF: Antenna Factor, Cable: Cable Loss, Pre-Amp: Preamplifier gain, Filter: High Pass Filter Insertion Loss (3.5GHz)
2. Spectrum analyzer setting P(Peak): RBW=1MHz, VBW=1MHz, A(Average): RBW=1MHz, VBW=10Hz
3. The result basic equation calculation is as follow:
 $Level = Reading + AF + Cable - Preamp + Filter - Dist, Margin = Level - Limit$
4. The other emission levels were 20dB below the limit
5. The test limit distance is 3M limit.



Product Name	AirCruiser N300 Mini-PCI Adapter	Test Date	2007/6/9
Model	GN-WI30N-RH	Test By	Eric Yang
Test Mode	IEEE 802.11g TX (CH Middle)	TEMP& Humidity	28.1 °C, 60%

Horizontal

TX / IEEE 802.11g mode / CH Middle				Measurement Distance at 3m				Horizontal polarity		
Freq.	Reading	AF	Cable Loss	Pre-amp	Filter	Level	Limit	Margin	Mark	
(MHz)	(dBµV)	(dB/m)	(dB)	(dB)	(dB)	(dBµV/m)	(dBµV/m)	(dB)	(P/Q/A)	
2429.98	113.47	30.04	2.34	39.78	0.00	106.07	Fundamental Frequency		P	
2429.98	105.88	30.04	2.34	39.78	0.00	98.48			A	
1628.87	65.48	27.48	2.12	39.88	0.85	56.06	86.07	-30.01	P	
1628.87	52.17	27.48	2.12	39.88	0.85	42.75	78.48	-35.73	A	
3250.87	46.28	30.05	2.82	40.25	1.21	40.12	86.07	-45.95	P	
3250.87	38.14	30.05	2.82	40.25	1.21	31.98	78.48	-46.50	A	
* 7308.19	50.28	38.93	4.96	41.32	1.59	54.44	74.00	-19.56	P	
* 7308.19	38.49	38.93	4.96	41.32	1.59	42.65	54.00	-11.35	A	
N/A	-----	-----	-----	-----	-----	-----	-----	-----	P	
N/A	-----	-----	-----	-----	-----	-----	-----	-----	A	

Remark:

1. AF: Antenna Factor, Cable: Cable Loss, Pre-Amp: Preamplifier gain, Filter: High Pass Filter Insertion Loss (3.5GHz)
 2. Spectrum analyzer setting P(Peak): RBW=1MHz, VBW=1MHz, A(Average): RBW=1MHz, VBW=10Hz
 3. The result basic equation calculation is as follow:
 $Level = Reading + AF + Cable - Preamp + Filter - Dist$, $Margin = Level - Limit$
 4. The other emission levels were 20dB below the limit
 5. The test limit distance is 3M limit.
- it.



Product Name	AirCruiser N300 Mini-PCI Adapter	Test Date	2007/6/9
Model	GN-WI30N-RH	Test By	Eric Yang
Test Mode	IEEE 802.11g TX (CH Middle)	TEMP& Humidity	28.1 °C, 60%

Vertical

TX / IEEE 802.11g mode / CH Middle				Measurement Distance at 3m Vertical polarity						
Freq.	Reading	AF	Cable Loss	Pre-amp	Filter	Level	Limit	Margin	Mark	
(MHz)	(dBµV)	(dB/m)	(dB)	(dB)	(dB)	(dBµV/m)	(dBµV/m)	(dB)	(P/Q/A)	
2443.70	115.93	30.03	2.34	39.77	0.00	108.54	Fundamental Frequency		P	
2443.70	107.87	30.03	2.34	39.77	0.00	100.48			A	
1629.15	67.42	27.48	2.12	39.88	0.85	58.00	88.54	-30.53	P	
1629.15	55.31	27.48	2.12	39.88	0.85	45.89	80.48	-34.58	A	
3249.34	48.92	30.05	2.82	40.24	1.22	42.76	88.54	-45.78	P	
3249.34	38.52	30.05	2.82	40.24	1.22	32.36	80.48	-48.12	A	
* 4873.93	59.57	32.92	3.73	41.41	0.71	55.53	74.00	-18.47	P	
* 4873.93	47.46	32.92	3.73	41.41	0.71	43.42	54.00	-10.58	A	
* 7310.31	51.24	38.93	4.96	41.32	1.59	55.41	74.00	-18.59	P	
* 7310.31	40.58	38.93	4.96	41.32	1.59	44.75	54.00	-9.25	A	
N/A	-----	-----	-----	-----	-----	-----	-----	-----	P	
N/A	-----	-----	-----	-----	-----	-----	-----	-----	A	

Remark:

1. AF: Antenna Factor, Cable: Cable Loss, Pre-Amp: Preamplifier gain, Filter: High Pass Filter Insertion Loss (3.5GHz)
2. Spectrum analyzer setting P(Peak): RBW=1MHz, VBW=1MHz, A(Average): RBW=1MHz, VBW=10Hz
3. The result basic equation calculation is as follow:
 $Level = Reading + AF + Cable - Preamp + Filter - Dist$, $Margin = Level - Limit$
4. The other emission levels were 20dB below the limit
5. The test limit distance is 3M limit.



Product Name	AirCruiser N300 Mini-PCI Adapter	Test Date	2007/6/9
Model	GN-WI30N-RH	Test By	Eric Yang
Test Mode	IEEE 802.11g TX (CH High)	TEMP& Humidity	28.1 °C, 60%

Horizontal

TX / IEEE 802.11g mode / CH High				Measurement Distance at 3m				Horizontal polarity		
Freq.	Reading	AF	Cable Loss	Pre-amp	Filter	Level	Limit	Margin	Mark	
(MHz)	(dBµV)	(dB/m)	(dB)	(dB)	(dB)	(dBµV/m)	(dBµV/m)	(dB)	(P/Q/A)	
2469.39	113.90	30.02	2.34	39.74	0.00	106.51	Fundamental Frequency		P	
2469.39	106.25	30.02	2.34	39.74	0.00	98.86			A	
1646.87	66.34	27.62	2.13	39.89	0.86	57.06	86.51	-29.45	P	
1646.87	55.28	27.62	2.13	39.89	0.86	46.00	78.86	-32.86	A	
3279.46	47.82	30.07	2.87	40.27	1.18	41.66	86.51	-44.85	P	
3279.46	39.52	30.07	2.87	40.27	1.18	33.36	78.86	-45.50	A	
* 4928.57	57.41	33.04	3.76	41.49	0.73	53.45	74.00	-20.55	P	
* 4928.57	43.69	33.04	3.76	41.49	0.73	39.73	54.00	-14.27	A	
* 7384.52	50.98	39.04	4.99	41.21	1.75	55.55	74.00	-18.45	P	
* 7384.52	38.51	39.04	4.99	41.21	1.75	43.08	54.00	-10.92	A	
N/A	-----	-----	-----	-----	-----	-----	-----	-----	P	
N/A	-----	-----	-----	-----	-----	-----	-----	-----	A	

Remark:

1. AF: Antenna Factor, Cable: Cable Loss, Pre-Amp: Preamplifier gain, Filter: High Pass Filter Insertion Loss (3.5GHz)
2. Spectrum analyzer setting P(Peak): RBW=1MHz, VBW=1MHz, A(Average): RBW=1MHz, VBW=10Hz
3. The result basic equation calculation is as follow:
 $Level = Reading + AF + Cable - Preamp + Filter - Dist$, $Margin = Level - Limit$
4. The other emission levels were 20dB below the limit
5. The test limit distance is 3M limit.



Product Name	AirCruiser N300 Mini-PCI Adapter	Test Date	2007/6/9
Model	GN-WI30N-RH	Test By	Eric Yang
Test Mode	IEEE 802.11g TX (CH High)	TEMP& Humidity	28.1 °C, 60%

Vertical

TX / IEEE 802.11g mode / CH High				Measurement Distance at 3m				Vertical polarity		
Freq.	Reading	AF	Cable Loss	Pre-amp	Filter	Level	Limit	Margin	Mark	
(MHz)	(dBµV)	(dB/m)	(dB)	(dB)	(dB)	(dBµV/m)	(dBµV/m)	(dB)	(P/Q/A)	
2464.93	116.73	30.02	2.34	39.75	0.00	109.34	Fundamental Frequency		P	
2464.93	108.85	30.02	2.34	39.75	0.00	101.46			A	
1647.79	68.20	27.62	2.13	39.89	0.86	58.93	89.34	-30.41	P	
1647.79	56.87	27.62	2.13	39.89	0.86	47.60	81.46	-33.86	A	
3282.46	46.68	30.07	2.87	40.27	1.17	40.52	89.34	-48.82	P	
3282.46	41.52	30.07	2.87	40.27	1.17	35.36	81.46	-46.10	A	
* 4924.31	59.16	33.03	3.76	41.49	0.73	55.20	74.00	-18.80	P	
* 4924.31	47.24	33.03	3.76	41.49	0.73	43.28	54.00	-10.72	A	
* 7382.23	52.68	39.04	4.99	41.22	1.75	57.24	74.00	-16.76	P	
* 7382.23	41.26	39.04	4.99	41.22	1.75	45.82	54.00	-8.18	A	
N/A	-----	-----	-----	-----	-----	-----	-----	-----	P	
N/A	-----	-----	-----	-----	-----	-----	-----	-----	A	

Remark:

1. AF: Antenna Factor, Cable: Cable Loss, Pre-Amp: Preamplifier gain, Filter: High Pass Filter Insertion Loss (3.5GHz)
2. Spectrum analyzer setting P(Peak): RBW=1MHz, VBW=1MHz, A(Average): RBW=1MHz, VBW=10Hz
3. The result basic equation calculation is as follow:
 $Level = Reading + AF + Cable - Preamp + Filter - Dist, Margin = Level - Limit$
4. The other emission levels were 20dB below the limit
5. The test limit distance is 3M limit.



Product Name	AirCruiser N300 Mini-PCI Adapter	Test Date	2007/6/9
Model	GN-WI30N-RH	Test By	Eric Yang
Test Mode	IEEE 802.11n HT20 TX (CH Low)	TEMP& Humidity	28.1°C, 60%

Horizontal

TX / IEEE 802.11n HT20 mode / CH Low				Measurement Distance at 3m				Horizontal polarity		
Freq.	Reading	AF	Cable Loss	Pre-amp	Filter	Level	Limit	Margin	Mark	
(MHz)	(dBµV)	(dB/m)	(dB)	(dB)	(dB)	(dBµV/m)	(dBµV/m)	(dB)	(P/Q/A)	
2413.27	113.17	30.05	2.34	39.79	0.00	105.77	Fundamental Frequency		P	
2413.27	104.90	30.05	2.34	39.79	0.00	97.50			A	
* 1608.09	53.75	27.32	2.11	39.86	0.84	44.16	74.00	-29.84	P	
* 1608.09	50.32	27.32	2.11	39.86	0.84	40.73	54.00	-13.27	A	
3215.96	45.52	30.03	2.77	40.22	1.26	39.36	85.77	-46.41	P	
3215.96	37.84	30.03	2.77	40.22	1.26	31.68	77.50	-45.82	A	
* 4824.09	48.52	32.81	3.71	41.34	0.69	44.40	74.00	-29.60	P	
* 4824.09	36.52	32.81	3.71	41.34	0.69	32.40	54.00	-21.60	A	
7242.63	49.60	38.84	4.93	41.42	1.45	53.41	85.77	-32.37	P	
7242.63	37.58	38.84	4.93	41.42	1.45	41.39	77.50	-36.12	A	
N/A	-----	-----	-----	-----	-----	-----	-----	-----	P	
N/A	-----	-----	-----	-----	-----	-----	-----	-----	A	

Remark:

1. AF: Antenna Factor, Cable: Cable Loss, Pre-Amp: Preamplifier gain, Filter: High Pass Filter Insertion Loss (3.5GHz)
2. Spectrum analyzer setting P(Peak): RBW=1MHz, VBW=1MHz, A(Average): RBW=1MHz, VBW=10Hz
3. The result basic equation calculation is as follow:
 $Level = Reading + AF + Cable - Preamp + Filter - Dist$, $Margin = Level - Limit$
4. The other emission levels were 20dB below the limit
5. The test limit distance is 3M limit.



Product Name	AirCruiser N300 Mini-PCI Adapter	Test Date	2007/6/9
Model	GN-WI30N-RH	Test By	Eric Yang
Test Mode	IEEE 802.11n HT20 TX (CH Low)	TEMP& Humidity	28.1°C, 60%

Vertical

TX / IEEE 802.11n HT20 mode / CH Low				Measurement Distance at 3m				Vertical polarity	
Freq.	Reading	AF	Cable Loss	Pre-amp	Filter	Level	Limit	Margin	Mark
(MHz)	(dBµV)	(dB/m)	(dB)	(dB)	(dB)	(dBµV/m)	(dBµV/m)	(dB)	(P/Q/A)
2415.94	115.81	30.05	2.34	39.79	0.00	108.41	Fundamental Frequency		P
2415.94	107.81	30.05	2.34	39.79	0.00	100.41			A
* 1609.84	66.08	27.33	2.11	39.86	0.84	56.51	74.00	-17.49	P
* 1609.84	52.49	27.33	2.11	39.86	0.84	42.92	54.00	-11.08	A
3215.93	48.24	30.03	2.77	40.22	1.26	42.08	88.41	-46.33	P
3215.93	44.36	30.03	2.77	40.22	1.26	38.20	80.41	-42.21	A
* 4821.87	58.48	32.81	3.70	41.33	0.69	54.35	74.00	-19.65	P
* 4821.87	46.15	32.81	3.70	41.33	0.69	42.02	54.00	-11.98	A
7240.19	45.27	38.84	4.93	41.42	1.44	49.06	88.41	-39.35	P
7240.19	38.64	38.84	4.93	41.42	1.44	42.43	80.41	-37.98	A
N/A	-----	-----	-----	-----	-----	-----	-----	-----	P
N/A	-----	-----	-----	-----	-----	-----	-----	-----	A

Remark:

1. AF: Antenna Factor, Cable: Cable Loss, Pre-Amp: Preamplifier gain, Filter: High Pass Filter Insertion Loss (3.5GHz)
2. Spectrum analyzer setting P(Peak): RBW=1MHz, VBW=1MHz, A(Average): RBW=1MHz, VBW=10Hz
3. The result basic equation calculation is as follow:
 $Level = Reading + AF + Cable - Preamp + Filter - Dist, Margin = Level - Limit$
4. The other emission levels were 20dB below the limit
5. The test limit distance is 3M limit.



Product Name	AirCruiser N300 Mini-PCI Adapter	Test Date	2007/6/9
Model	GN-WI30N-RH	Test By	Eric Yang
Test Mode	IEEE 802.11n HT20 TX (CH Middle)	TEMP& Humidity	28.1 °C, 60%

Horizontal

TX / IEEE 802.11n HT20 mode / CH Middle				Measurement Distance at 3m				Horizontal polarity		
Freq.	Reading	AF	Cable Loss	Pre-amp	Filter	Level	Limit	Margin	Mark	
(MHz)	(dBμV)	(dB/m)	(dB)	(dB)	(dB)	(dBμV/m)	(dBμV/m)	(dB)	(P/Q/A)	
2430.19	113.36	30.04	2.34	39.78	0.00	105.96	Fundamental Frequency		P	
2430.19	105.39	30.04	2.34	39.78	0.00	97.99			A	
* 1624.40	52.85	27.45	2.12	39.87	0.85	43.40	74.00	-30.60	P	
* 1624.40	49.15	27.45	2.12	39.87	0.85	39.70	54.00	-14.30	A	
3249.40	45.78	30.05	2.82	40.24	1.22	39.62	85.96	-46.34	P	
3249.40	39.08	30.05	2.82	40.24	1.22	32.92	77.99	-45.07	A	
* 4872.96	47.25	32.92	3.73	41.41	0.71	43.20	74.00	-30.80	P	
* 4872.96	35.98	32.92	3.73	41.41	0.71	31.93	54.00	-22.07	A	
* 7273.92	49.07	38.88	4.95	41.37	1.52	53.04	74.00	-20.96	P	
* 7273.92	36.98	38.88	4.95	41.37	1.52	40.95	54.00	-13.05	A	
N/A	-----	-----	-----	-----	-----	-----	-----	-----	P	
N/A	-----	-----	-----	-----	-----	-----	-----	-----	A	

Remark:

1. AF: Antenna Factor, Cable: Cable Loss, Pre-Amp: Preamplifier gain, Filter: High Pass Filter Insertion Loss (3.5GHz)
2. Spectrum analyzer setting P(Peak): RBW=1MHz, VBW=1MHz, A(Average): RBW=1MHz, VBW=10Hz
3. The result basic equation calculation is as follow:
 $Level = Reading + AF + Cable - Preamp + Filter - Dist$, $Margin = Level - Limit$
4. The other emission levels were 20dB below the limit
5. The test limit distance is 3M limit.



Product Name	AirCruiser N300 Mini-PCI Adapter	Test Date	2007/6/9
Model	GN-WI30N-RH	Test By	Eric Yang
Test Mode	IEEE 802.11n HT20 TX (CH Middle)	TEMP& Humidity	28.1 °C, 60%

Vertical

TX / IEEE 802.11n HT20 mode / CH Middle				Measurement Distance at 3m			Vertical polarity		
Freq.	Reading	AF	Cable Loss	Pre-amp	Filter	Level	Limit	Margin	Mark
(MHz)	(dBµV)	(dB/m)	(dB)	(dB)	(dB)	(dBµV/m)	(dBµV/m)	(dB)	(P/Q/A)
2442.24	115.98	30.03	2.34	39.77	0.00	108.59	Fundamental Frequency		P
2442.24	107.91	30.03	2.34	39.77	0.00	100.52			A
1627.50	66.34	27.47	2.12	39.87	0.85	56.91	88.59	-31.68	P
1627.50	53.21	27.47	2.12	39.87	0.85	43.78	80.52	-36.74	A
3249.34	46.39	30.05	2.82	40.24	1.22	40.23	88.59	-48.36	P
3249.34	41.78	30.05	2.82	40.24	1.22	35.62	80.52	-44.90	A
* 4874.18	58.80	32.92	3.73	41.41	0.71	54.76	74.00	-19.24	P
* 4874.18	46.25	32.92	3.73	41.41	0.71	42.21	54.00	-11.79	A
* 7312.56	49.53	38.94	4.96	41.32	1.60	53.71	74.00	-20.29	P
* 7312.56	39.24	38.94	4.96	41.32	1.60	43.42	54.00	-10.58	A
N/A	-----	-----	-----	-----	-----	-----	-----	-----	P
N/A	-----	-----	-----	-----	-----	-----	-----	-----	A

Remark:

1. AF: Antenna Factor, Cable: Cable Loss, Pre-Amp: Preamplifier gain, Filter: High Pass Filter Insertion Loss (3.5GHz)
2. Spectrum analyzer setting P(Peak): RBW=1MHz, VBW=1MHz, A(Average): RBW=1MHz, VBW=10Hz
3. The result basic equation calculation is as follow:
 $Level = Reading + AF + Cable - Preamp + Filter - Dist$, $Margin = Level - Limit$
4. The other emission levels were 20dB below the limit
5. The test limit distance is 3M limit.



Product Name	AirCruiser N300 Mini-PCI Adapter	Test Date	2007/6/9
Model	GN-WI30N-RH	Test By	Eric Yang
Test Mode	IEEE 802.11n HT20 TX (CH High)	TEMP& Humidity	28.1°C, 60%

Horizontal

TX / IEEE 802.11n HT20 mode / CH High				Measurement Distance at 3m				Horizontal polarity		
Freq.	Reading	AF	Cable Loss	Pre-amp	Filter	Level	Limit	Margin	Mark	
(MHz)	(dBμV)	(dB/m)	(dB)	(dB)	(dB)	(dBμV/m)	(dBμV/m)	(dB)	(P/Q/A)	
2469.84	113.46	30.02	2.34	39.74	0.00	106.07	Fundamental Frequency		P	
2469.84	105.66	30.02	2.34	39.74	0.00	98.27			A	
1647.48	67.82	27.62	2.13	39.89	0.86	58.55	86.07	-27.52	P	
1647.48	55.31	27.62	2.13	39.89	0.86	46.04	78.27	-32.23	A	
3282.72	45.01	30.07	2.87	40.27	1.17	38.85	86.07	-47.22	P	
3282.72	36.52	30.07	2.87	40.27	1.17	30.36	78.27	-47.91	A	
* 4922.86	52.48	33.03	3.76	41.48	0.73	48.52	74.00	-25.48	P	
* 4922.86	39.25	33.03	3.76	41.48	0.73	35.29	54.00	-18.71	A	
* 7385.29	47.95	39.04	4.99	41.21	1.75	52.53	74.00	-21.47	P	
* 7386.33	37.11	39.37	3.83	41.50	1.76	40.57	54.00	-13.43	A	
N/A	-----	-----	-----	-----	-----	-----	-----	-----	P	
N/A	-----	-----	-----	-----	-----	-----	-----	-----	A	

Remark:

1. AF: Antenna Factor, Cable: Cable Loss, Pre-Amp: Preamplifier gain, Filter: High Pass Filter Insertion Loss (3.5GHz)
2. Spectrum analyzer setting P(Peak): RBW=1MHz, VBW=1MHz, A(Average): RBW=1MHz, VBW=10Hz
3. The result basic equation calculation is as follow:
 $Level = Reading + AF + Cable - Preamp + Filter - Dist, Margin = Level - Limit$
4. The other emission levels were 20dB below the limit
5. The test limit distance is 3M limit.



Product Name	AirCruiser N300 Mini-PCI Adapter	Test Date	2007/6/9
Model	GN-WI30N-RH	Test By	Eric Yang
Test Mode	IEEE 802.11n HT20 TX (CH High)	TEMP& Humidity	28.1°C, 60%

Vertical

TX / IEEE 802.11n HT20 mode / CH High				Measurement Distance at 3m				Vertical polarity	
Freq.	Reading	AF	Cable Loss	Pre-amp	Filter	Level	Limit	Margin	Mark
(MHz)	(dBμV)	(dB/m)	(dB)	(dB)	(dB)	(dBμV/m)	(dBμV/m)	(dB)	(P/Q/A)
2466.26	116.54	30.02	2.34	39.75	0.00	109.15	Fundamental Frequency		P
2466.26	108.51	30.02	2.34	39.75	0.00	101.12			A
1647.73	63.28	27.62	2.13	39.89	0.86	54.01	89.15	-35.14	P
1647.73	52.12	27.62	2.13	39.89	0.86	42.85	81.12	-38.27	A
3282.73	46.82	30.07	2.87	40.27	1.17	40.66	89.15	-48.49	P
3282.73	41.94	30.07	2.87	40.27	1.17	35.78	81.12	-45.34	A
* 4922.18	59.97	33.03	3.76	41.48	0.73	56.00	74.00	-18.00	P
* 4922.18	44.84	33.03	3.76	41.48	0.73	40.87	54.00	-13.13	A
* 7383.80	49.67	39.04	4.99	41.22	1.75	54.23	74.00	-19.77	P
* 7383.80	39.64	39.04	4.99	41.22	1.75	44.20	54.00	-9.80	A
N/A	-----	-----	-----	-----	-----	-----	-----	-----	P
N/A	-----	-----	-----	-----	-----	-----	-----	-----	A

Remark:

1. AF: Antenna Factor, Cable: Cable Loss, Pre-Amp: Preamplifier gain, Filter: High Pass Filter Insertion Loss (3.5GHz)
2. Spectrum analyzer setting P(Peak): RBW=1MHz, VBW=1MHz, A(Average): RBW=1MHz, VBW=10Hz
3. The result basic equation calculation is as follow:
 $Level = Reading + AF + Cable - Preamp + Filter - Dist, Margin = Level - Limit$
4. The other emission levels were 20dB below the limit
5. The test limit distance is 3M limit.



Product Name	AirCruiser N300 Mini-PCI Adapter	Test Date	2007/6/9
Model	GN-WI30N-RH	Test By	Eric Yang
Test Mode	IEEE 802.11n HT40 TX (CH Low)	TEMP& Humidity	28.1°C, 60%

Horizontal

TX / IEEE 802.11n HT40 mode / CH Low				Measurement Distance at 3m				Horizontal polarity		
Freq.	Reading	AF	Cable Loss	Pre-amp	Filter	Level	Limit	Margin	Mark	
(MHz)	(dBµV)	(dB/m)	(dB)	(dB)	(dB)	(dBµV/m)	(dBµV/m)	(dB)	(P/Q/A)	
2430.92	110.52	30.04	2.34	39.78	0.00	103.12	Fundamental Frequency		P	
2430.92	102.30	30.04	2.34	39.78	0.00	94.90			A	
* 1615.85	58.62	27.38	2.11	39.87	0.85	49.10	74.00	-24.90	P	
* 1615.85	48.72	27.38	2.11	39.87	0.85	39.20	54.00	-14.80	A	
3229.28	46.04	30.04	2.79	40.23	1.24	39.88	83.12	-43.24	P	
3229.28	38.21	30.04	2.79	40.23	1.24	32.05	74.90	-42.85	A	
* 4843.29	49.58	32.86	3.72	41.36	0.70	45.49	74.00	-28.51	P	
* 4843.29	37.94	32.86	3.72	41.36	0.70	33.85	54.00	-20.15	A	
* 7275.99	50.28	38.89	4.95	41.37	1.52	54.26	74.00	-19.74	P	
* 7275.99	38.54	38.89	4.95	41.37	1.52	42.52	54.00	-11.48	A	
N/A	-----	-----	-----	-----	-----	-----	-----	-----	P	
N/A	-----	-----	-----	-----	-----	-----	-----	-----	A	

Remark:

1. AF: Antenna Factor, Cable: Cable Loss, Pre-Amp: Preamplifier gain, Filter: High Pass Filter Insertion Loss (3.5GHz)
2. Spectrum analyzer setting P(Peak): RBW=1MHz, VBW=1MHz, A(Average): RBW=1MHz, VBW=10Hz
3. The result basic equation calculation is as follow:
 $Level = Reading + AF + Cable - Preamp + Filter - Dist, Margin = Level - Limit$
4. The other emission levels were 20dB below the limit
5. The test limit distance is 3M limit.



Product Name	AirCruiser N300 Mini-PCI Adapter	Test Date	2007/6/9
Model	GN-WI30N-RH	Test By	Eric Yang
Test Mode	IEEE 802.11n HT40 TX (CH Low)	TEMP& Humidity	28.1°C, 60%

Vertical

TX / IEEE 802.11n HT40 mode / CH Low				Measurement Distance at 3m				Vertical polarity	
Freq.	Reading	AF	Cable Loss	Pre-amp	Filter	Level	Limit	Margin	Mark
(MHz)	(dBµV)	(dB/m)	(dB)	(dB)	(dB)	(dBµV/m)	(dBµV/m)	(dB)	(P/Q/A)
2414.90	112.58	30.05	2.34	39.79	0.00	105.18	Fundamental Frequency		P
2414.90	104.33	30.05	2.34	39.79	0.00	96.93			A
* 1620.58	62.18	27.42	2.12	39.87	0.85	52.69	74.00	-21.31	P
* 1620.58	51.49	27.42	2.12	39.87	0.85	42.00	54.00	-12.00	A
3229.24	49.32	30.04	2.79	40.23	1.24	43.16	85.18	-42.02	P
3229.24	45.07	30.04	2.79	40.23	1.24	38.91	76.93	-38.02	A
* 4843.38	50.83	32.86	3.72	41.37	0.70	46.74	74.00	-27.26	P
* 4843.38	39.16	32.86	3.72	41.37	0.70	35.07	54.00	-18.93	A
* 7265.38	49.62	38.87	4.94	41.38	1.50	53.55	74.00	-20.45	P
* 7265.38	38.52	38.87	4.94	41.38	1.50	42.45	54.00	-11.55	A
N/A	-----	-----	-----	-----	-----	-----	-----	-----	P
N/A	-----	-----	-----	-----	-----	-----	-----	-----	A

Remark:

1. AF: Antenna Factor, Cable: Cable Loss, Pre-Amp: Preamplifier gain, Filter: High Pass Filter Insertion Loss (3.5GHz)
2. Spectrum analyzer setting P(Peak): RBW=1MHz, VBW=1MHz, A(Average): RBW=1MHz, VBW=10Hz
3. The result basic equation calculation is as follow:
 $Level = Reading + AF + Cable - Preamp + Filter - Dist, Margin = Level - Limit$
4. The other emission levels were 20dB below the limit
5. The test limit distance is 3M limit.



Product Name	AirCruiser N300 Mini-PCI Adapter	Test Date	2007/6/9
Model	GN-WI30N-RH	Test By	Eric Yang
Test Mode	IEEE 802.11n HT40 TX (CH Middle)	TEMP& Humidity	28.1°C, 60%

Horizontal

TX / IEEE 802.11n HT40 mode / CH Middle				Measurement Distance at 3m				Horizontal polarity		
Freq.	Reading	AF	Cable Loss	Pre-amp	Filter	Level	Limit	Margin	Mark	
(MHz)	(dBμV)	(dB/m)	(dB)	(dB)	(dB)	(dBμV/m)	(dBμV/m)	(dB)	(P/Q/A)	
2429.77	110.89	30.04	2.34	39.78	0.00	103.49	Fundamental Frequency		P	
2429.77	102.45	30.04	2.34	39.78	0.00	95.05			A	
1627.31	63.61	27.47	2.12	39.87	0.85	54.18	83.49	-29.32	P	
1627.31	51.88	27.47	2.12	39.87	0.85	42.45	75.05	-32.61	A	
3249.32	44.72	30.05	2.82	40.24	1.22	38.56	83.49	-44.93	P	
3249.32	36.55	30.05	2.82	40.24	1.22	30.39	75.05	-44.66	A	
* 4875.44	49.18	32.93	3.73	41.41	0.71	45.14	74.00	-28.86	P	
* 4875.44	38.08	32.93	3.73	41.41	0.71	34.04	54.00	-19.96	A	
* 7313.06	50.24	38.94	4.96	41.32	1.60	54.42	74.00	-19.58	P	
* 7313.06	38.95	38.94	4.96	41.32	1.60	43.13	54.00	-10.87	A	
N/A	-----	-----	-----	-----	-----	-----	-----	-----	P	
N/A	-----	-----	-----	-----	-----	-----	-----	-----	A	

Remark:

1. AF: Antenna Factor, Cable: Cable Loss, Pre-Amp: Preamplifier gain, Filter: High Pass Filter Insertion Loss (3.5GHz)
2. Spectrum analyzer setting P(Peak): RBW=1MHz, VBW=1MHz, A(Average): RBW=1MHz, VBW=10Hz
3. The result basic equation calculation is as follow:
 $Level = Reading + AF + Cable - Preamp + Filter - Dist$, $Margin = Level - Limit$
4. The other emission levels were 20dB below the limit
5. The test limit distance is 3M limit.



Product Name	AirCruiser N300 Mini-PCI Adapter	Test Date	2007/6/9
Model	GN-WI30N-RH	Test By	Eric Yang
Test Mode	IEEE 802.11n HT40 TX (CH Middle)	TEMP& Humidity	28.1 °C, 60%

Vertical

TX / IEEE 802.11n HT40 mode / CH Middle				Measurement Distance at 3m			Vertical polarity		
Freq.	Reading	AF	Cable Loss	Pre-amp	Filter	Level	Limit	Margin	Mark
(MHz)	(dBµV)	(dB/m)	(dB)	(dB)	(dB)	(dBµV/m)	(dBµV/m)	(dB)	(P/Q/A)
2442.14	113.30	30.03	2.34	39.77	0.00	105.91	Fundamental Frequency		P
2442.14	104.79	30.03	2.34	39.77	0.00	97.40			A
1627.63	63.68	27.47	2.12	39.87	0.85	54.25	85.91	-31.66	P
1627.63	52.78	27.47	2.12	39.87	0.85	43.35	77.40	-34.05	A
3249.34	47.16	30.05	2.82	40.24	1.22	41.00	85.91	-44.91	P
3249.34	41.17	30.05	2.82	40.24	1.22	35.01	77.40	-42.39	A
* 4874.12	56.35	32.92	3.73	41.41	0.71	52.31	74.00	-21.69	P
* 4874.12	45.57	32.92	3.73	41.41	0.71	41.53	54.00	-12.47	A
* 7313.12	49.58	38.94	4.96	41.32	1.60	53.76	74.00	-20.24	P
* 7313.12	37.96	38.94	4.96	41.32	1.60	42.14	54.00	-11.86	A
N/A	-----	-----	-----	-----	-----	-----	-----	-----	P
N/A	-----	-----	-----	-----	-----	-----	-----	-----	A

Remark:

1. AF: Antenna Factor, Cable: Cable Loss, Pre-Amp: Preamplifier gain, Filter: High Pass Filter Insertion Loss (3.5GHz)
2. Spectrum analyzer setting P(Peak): RBW=1MHz, VBW=1MHz, A(Average): RBW=1MHz, VBW=10Hz
3. The result basic equation calculation is as follow:
 $Level = Reading + AF + Cable - Preamp + Filter - Dist$, $Margin = Level - Limit$
4. The other emission levels were 20dB below the limit
5. The test limit distance is 3M limit.



Product Name	AirCruiser N300 Mini-PCI Adapter	Test Date	2007/6/9
Model	GN-WI30N-RH	Test By	Eric Yang
Test Mode	IEEE 802.11n HT40 TX (CH High)	TEMP&Humidity	28.1 °C, 60%

Horizontal

TX / IEEE 802.11n HT40 mode / CH High				Measurement Distance at 3m			Horizontal polarity		
Freq.	Reading	AF	Cable Loss	Pre-amp	Filter	Level	Limit	Margin	Mark
(MHz)	(dBµV)	(dB/m)	(dB)	(dB)	(dB)	(dBµV/m)	(dBµV/m)	(dB)	(P/Q/A)
2445.03	107.84	30.03	2.34	39.76	0.00	100.45	Fundamental Frequency		P
2445.03	99.81	30.03	2.34	39.76	0.00	92.42			A
1643.47	56.92	27.59	2.13	39.88	0.86	47.62	80.45	-32.83	P
1643.47	47.10	27.59	2.13	39.88	0.86	37.80	72.42	-34.62	A
3269.02	44.48	30.06	2.85	40.26	1.19	38.32	80.45	-42.13	P
3269.02	36.40	30.06	2.85	40.26	1.19	30.24	72.42	-42.18	A
* 4899.19	48.40	32.98	3.75	41.45	0.72	44.40	74.00	-29.60	P
* 4899.19	36.97	32.98	3.75	41.45	0.72	32.97	54.00	-21.03	A
* 7362.31	46.82	39.01	4.98	41.25	1.71	51.27	74.00	-22.73	P
* 7386.33	37.11	39.37	3.83	41.50	1.76	40.57	54.00	-13.43	A
N/A	-----	-----	-----	-----	-----	-----	-----	-----	P
N/A	-----	-----	-----	-----	-----	-----	-----	-----	A

Remark:

1. AF: Antenna Factor, Cable: Cable Loss, Pre-Amp: Preamplifier gain, Filter: High Pass Filter Insertion Loss (3.5GHz)
2. Spectrum analyzer setting P(Peak): RBW=1MHz, VBW=1MHz, A(Average): RBW=1MHz, VBW=10Hz
3. The result basic equation calculation is as follow:
Level = Reading + AF + Cable – Preamp + Filter – Dist, Margin = Level-Limit
4. The other emission levels were 20dB below the limit
5. The test limit distance is 3M limit.



Product Name	AirCruiser N300 Mini-PCI Adapter	Test Date	2007/6/9
Model	GN-WI30N-RH	Test By	Eric Yang
Test Mode	IEEE 802.11n HT40 TX (CH High)	TEMP& Humidity	28.1°C, 60%

Vertical

TX / IEEE 802.11n HT40 mode / CH High				Measurement Distance at 3m				Vertical polarity	
Freq.	Reading	AF	Cable Loss	Pre-amp	Filter	Level	Limit	Margin	Mark
(MHz)	(dBμV)	(dB/m)	(dB)	(dB)	(dB)	(dBμV/m)	(dBμV/m)	(dB)	(P/Q/A)
2455.45	111.33	30.03	2.34	39.76	0.00	103.94	Fundamental Frequency		P
2455.45	103.69	30.03	2.34	39.76	0.00	96.30			A
1643.41	58.70	27.59	2.13	39.88	0.86	49.40	83.94	-34.54	P
1643.41	48.24	27.59	2.13	39.88	0.86	38.94	76.30	-37.36	A
3269.06	48.16	30.06	2.85	40.26	1.19	42.00	83.94	-41.94	P
3269.06	42.95	30.06	2.85	40.26	1.19	36.79	76.30	-39.51	A
* 4898.86	51.98	32.98	3.75	41.45	0.72	47.98	74.00	-26.02	P
* 4898.86	42.65	32.98	3.75	41.45	0.72	38.65	54.00	-15.35	A
* 7344.36	48.19	38.98	4.97	41.27	1.67	52.54	74.00	-21.46	P
* 7344.36	37.98	38.98	4.97	41.27	1.67	42.33	54.00	-11.67	A
N/A	-----	-----	-----	-----	-----	-----	-----	-----	P
N/A	-----	-----	-----	-----	-----	-----	-----	-----	A

Remark:

1. AF: Antenna Factor, Cable: Cable Loss, Pre-Amp: Preamplifier gain, Filter: High Pass Filter Insertion Loss (3.5GHz)
2. Spectrum analyzer setting P(Peak): RBW=1MHz, VBW=1MHz, A(Average): RBW=1MHz, VBW=10Hz
3. The result basic equation calculation is as follow:
 $Level = Reading + AF + Cable - Preamp + Filter - Dist, Margin = Level - Limit$
4. The other emission levels were 20dB below the limit
5. The test limit distance is 3M limit.



8.8.4 RESTRICTED BAND EDGES

Detector mode : Peak **Polarity : Horizontal**

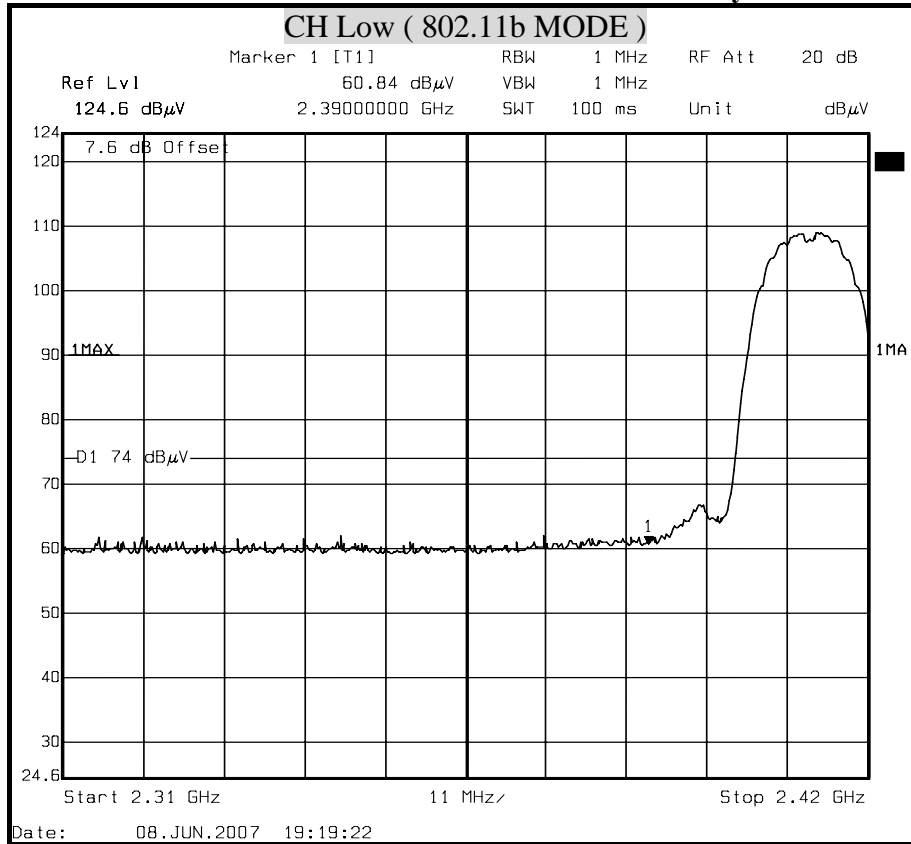

Detector mode : Average **Polarity : Horizontal**

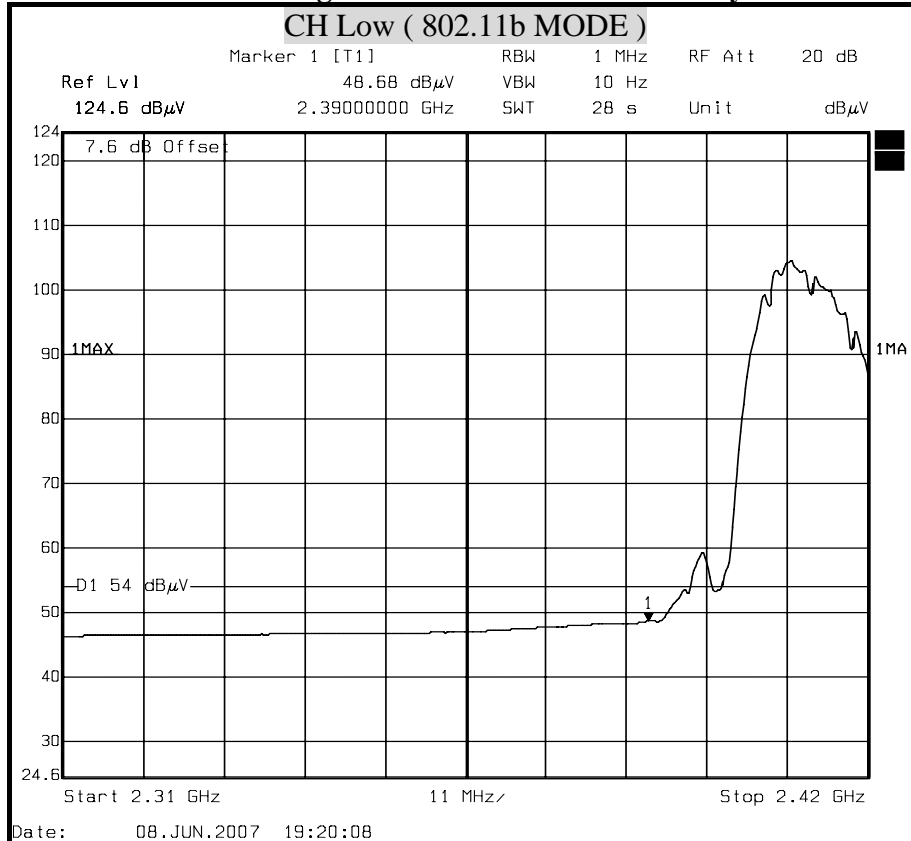



Detector mode : Peak

Polarity : Vertical

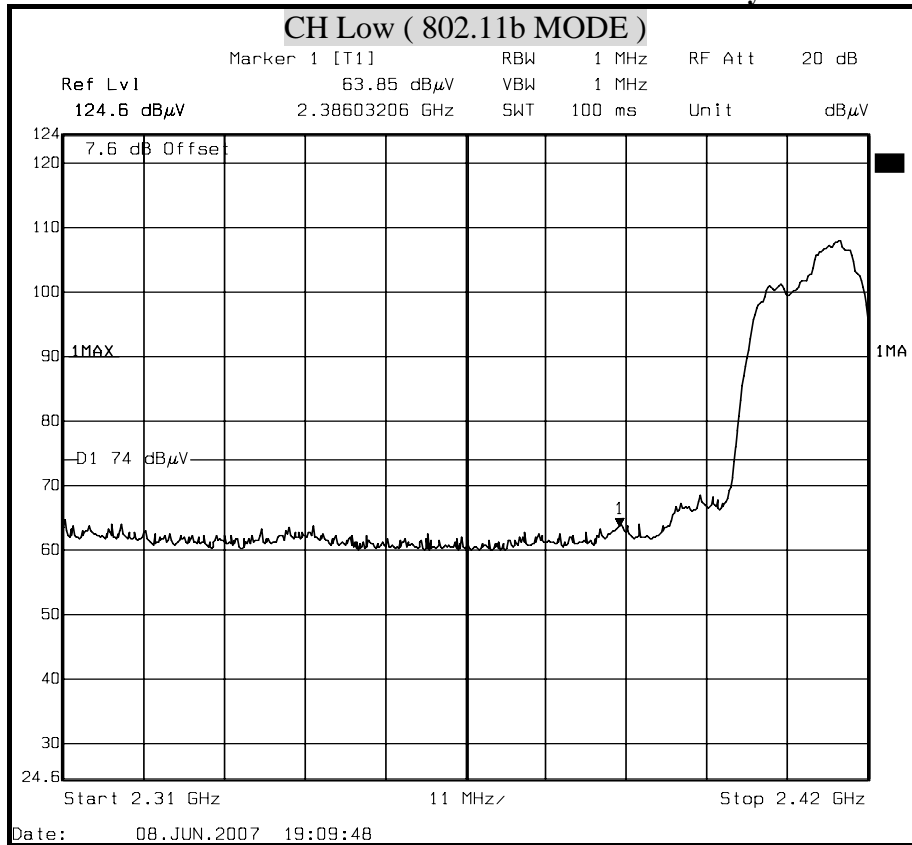

Detector mode : Average

Polarity : Vertical

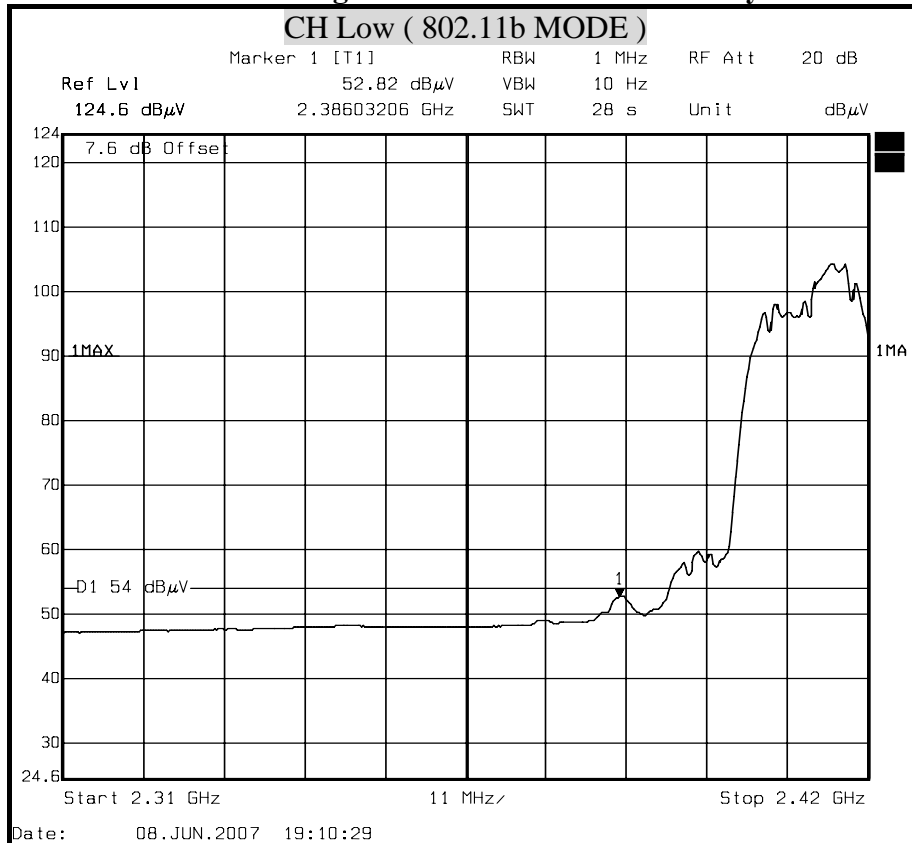



Detector mode : Peak

Polarity : Horizontal

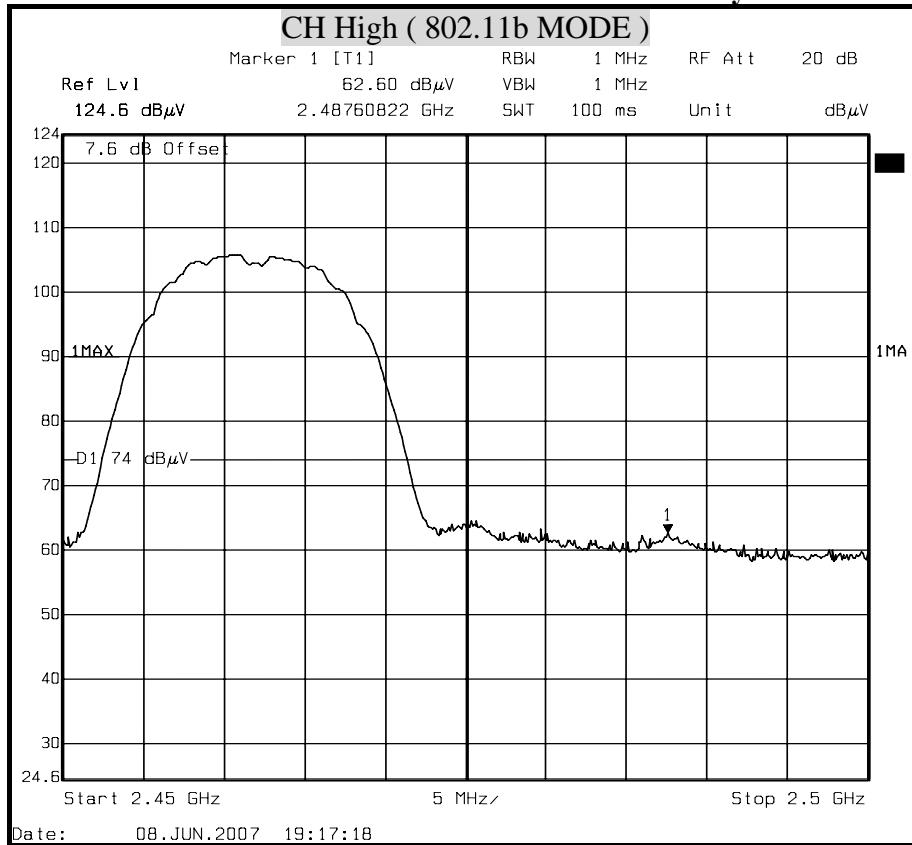

Detector mode : Average

Polarity : Horizontal

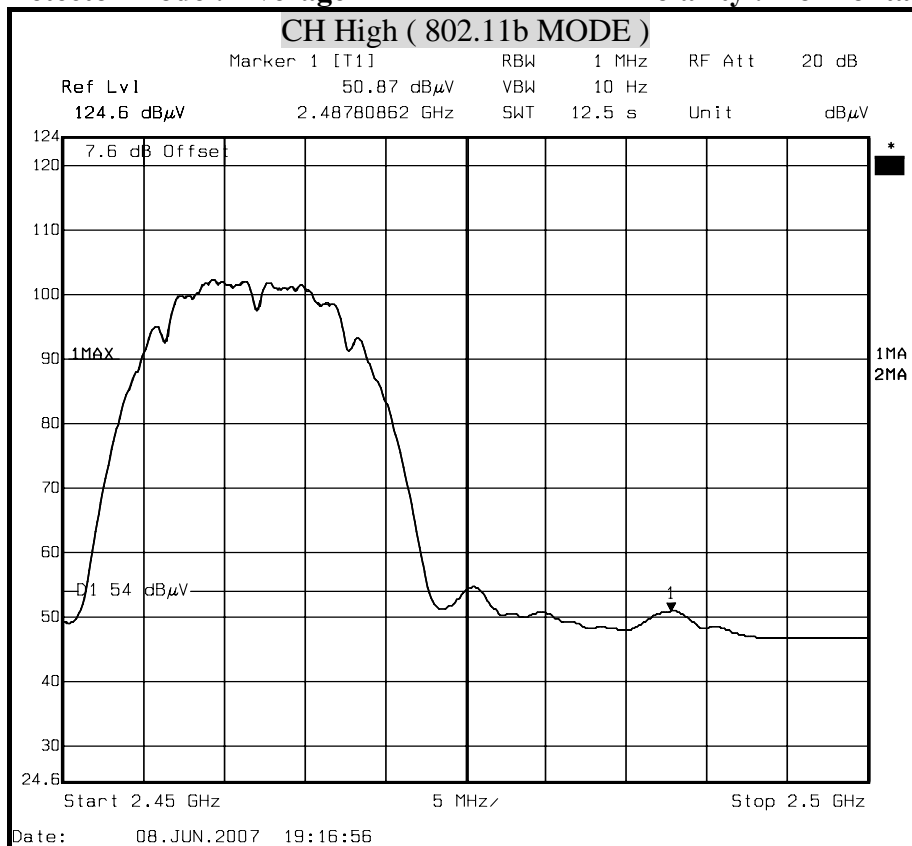



Detector mode : Peak

Polarity : Vertical

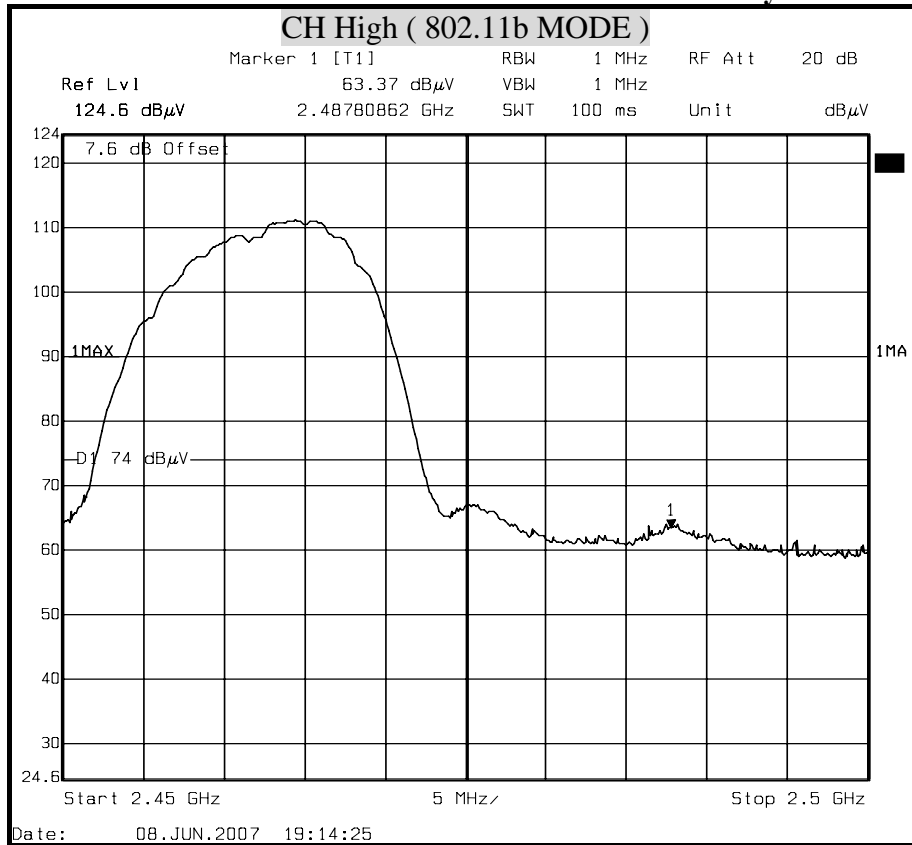

Detector mode : Average

Polarity : Vertical

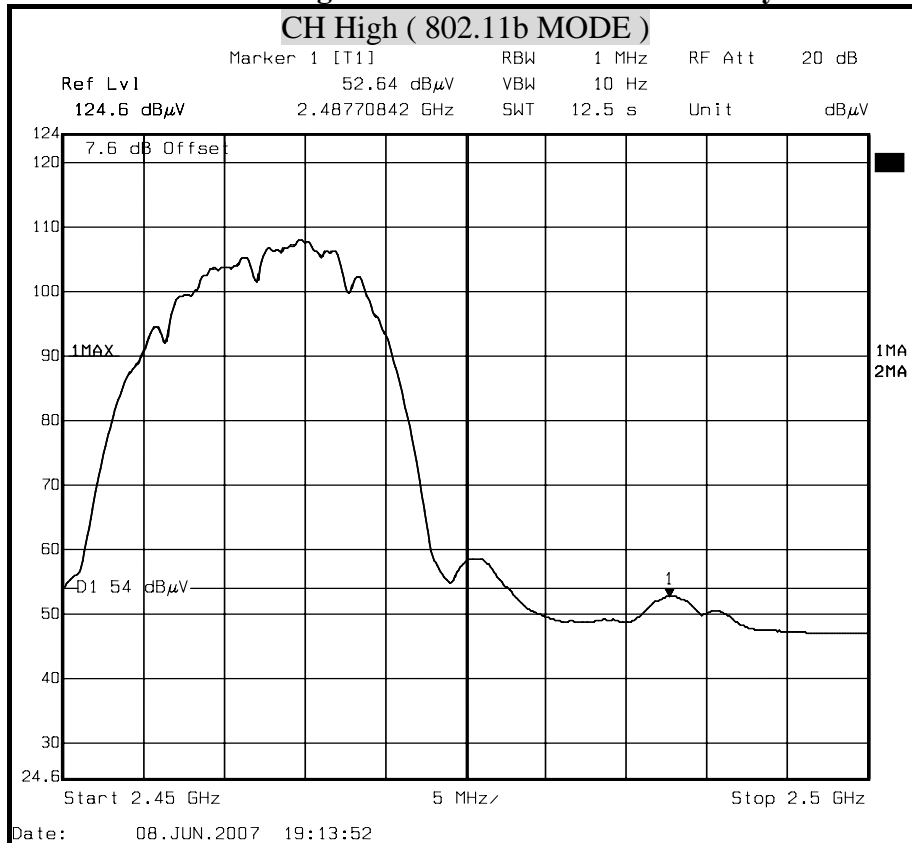



Detector mode : Peak

Polarity : Horizontal

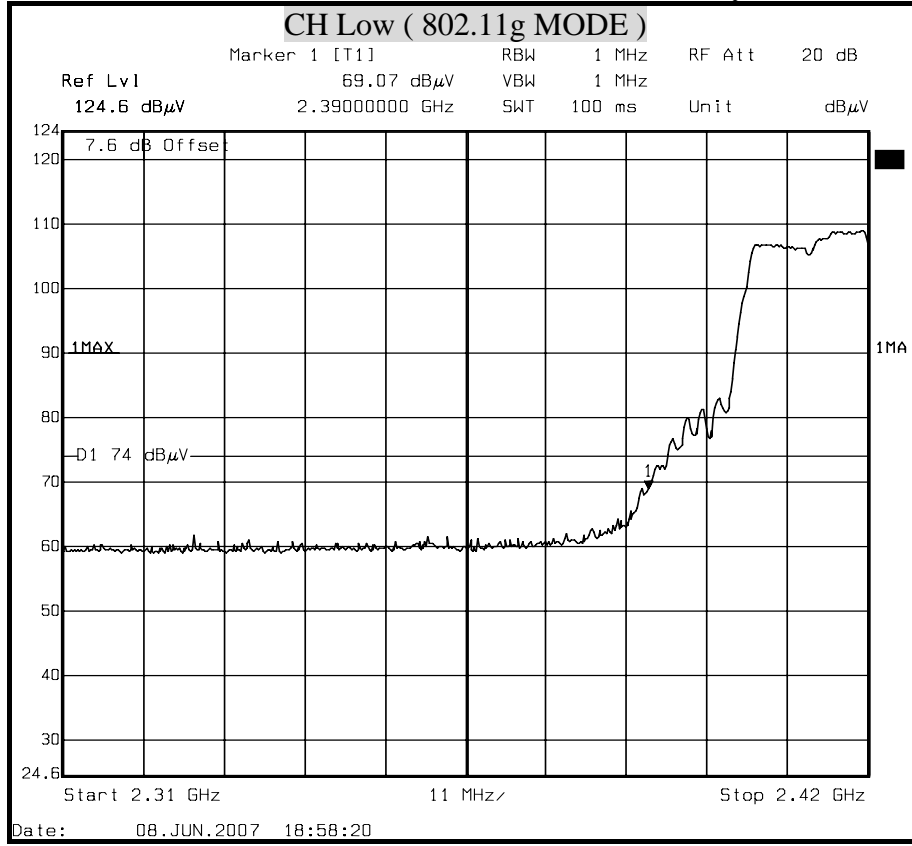

Detector mode : Average

Polarity : Horizontal

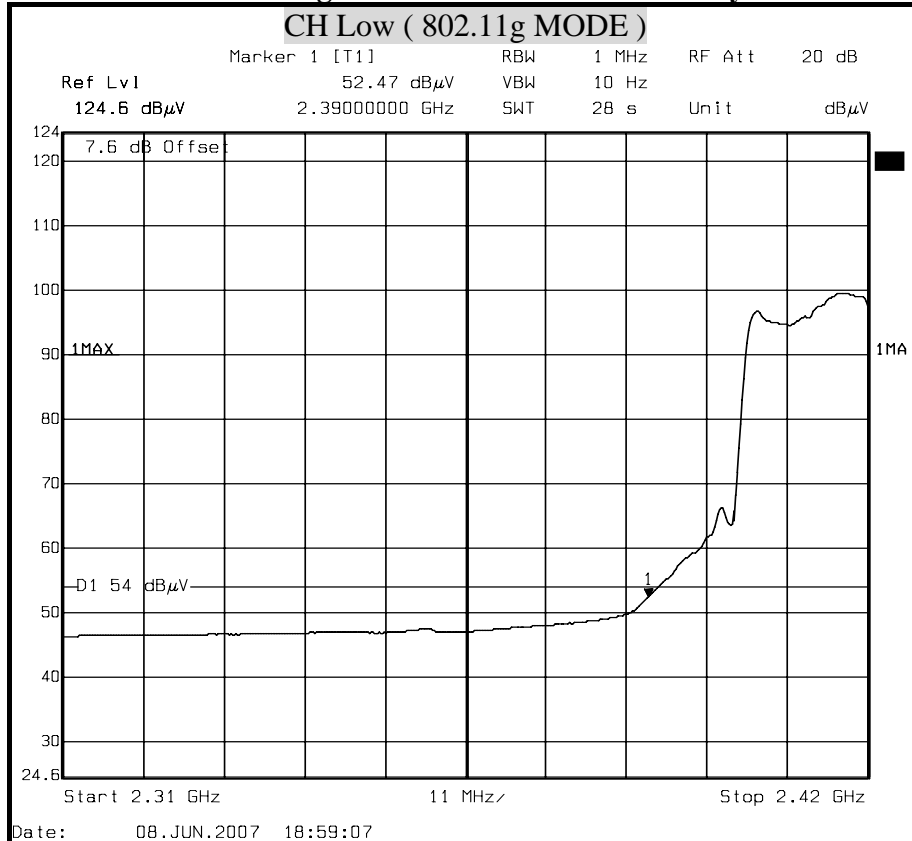



Detector mode : Peak

Polarity : Vertical

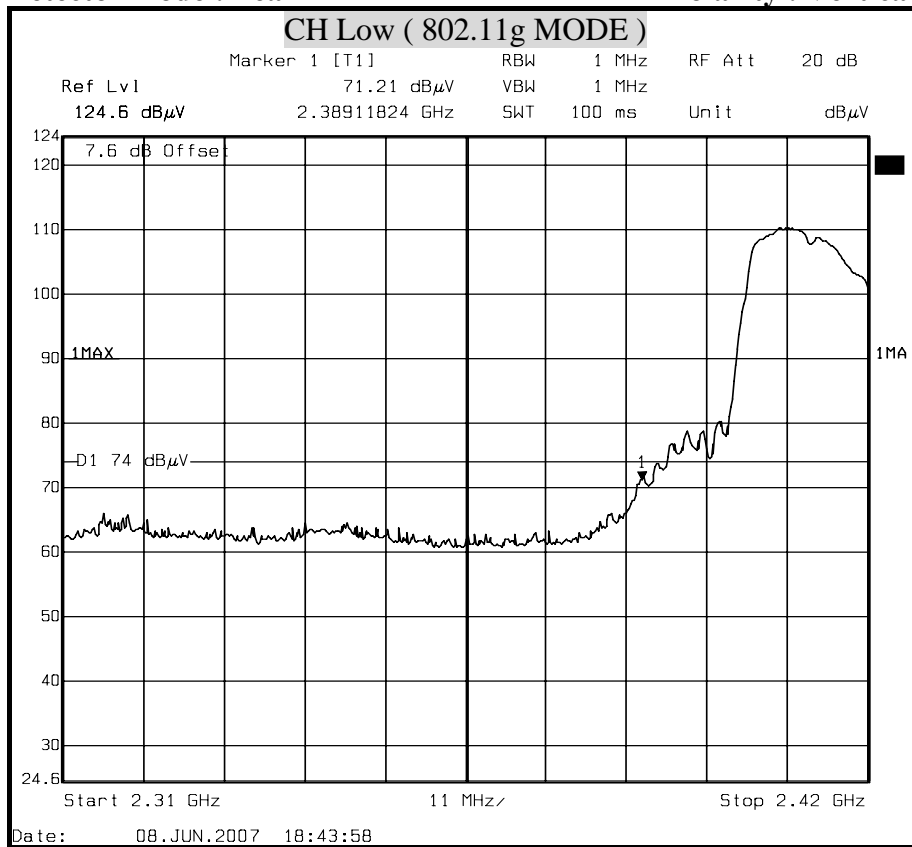

Detector mode : Average

Polarity : Vertical

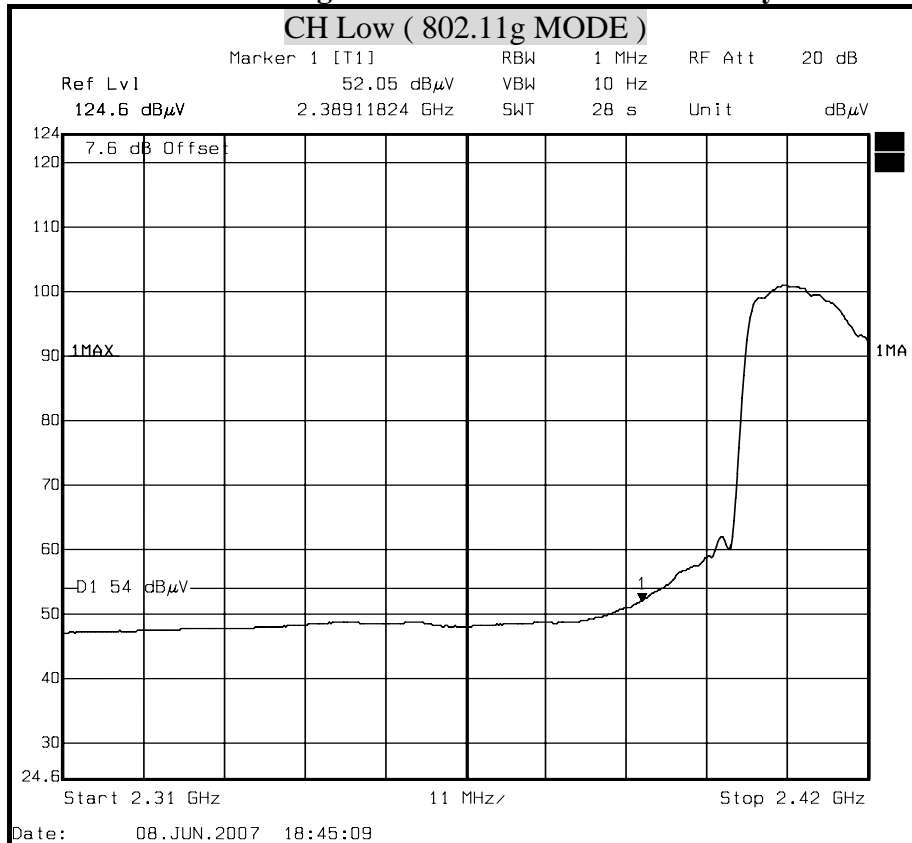



Detector mode : Peak **Polarity : Horizontal**

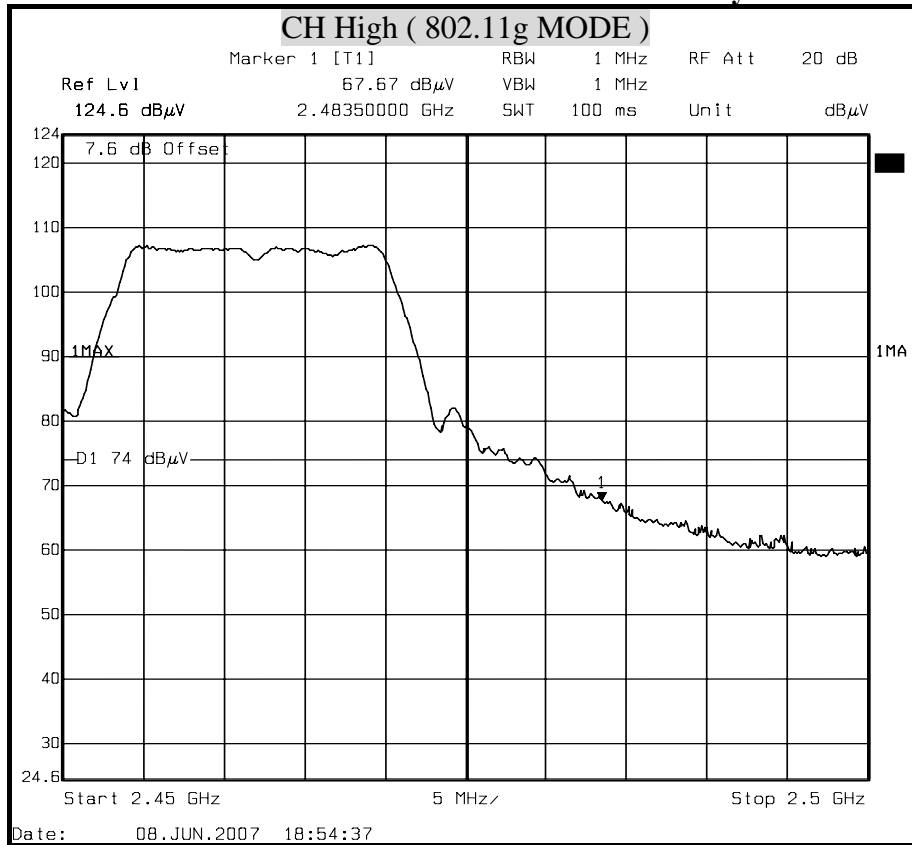

Detector mode : Average **Polarity : Horizontal**

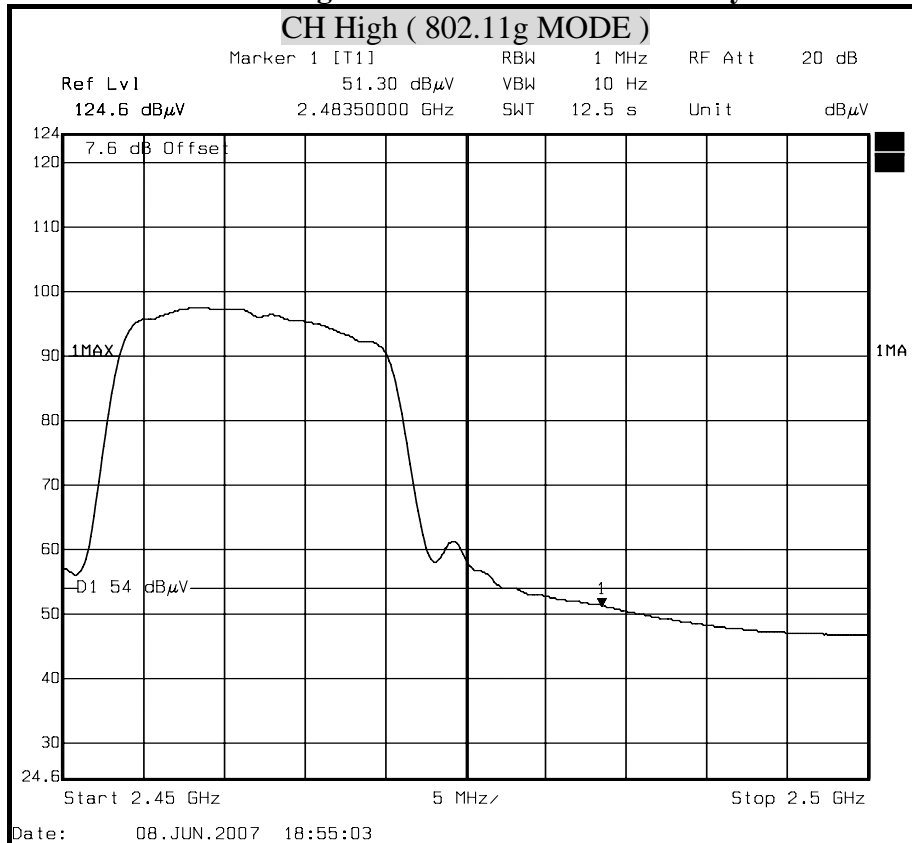



Detector mode : Peak

Polarity : Vertical

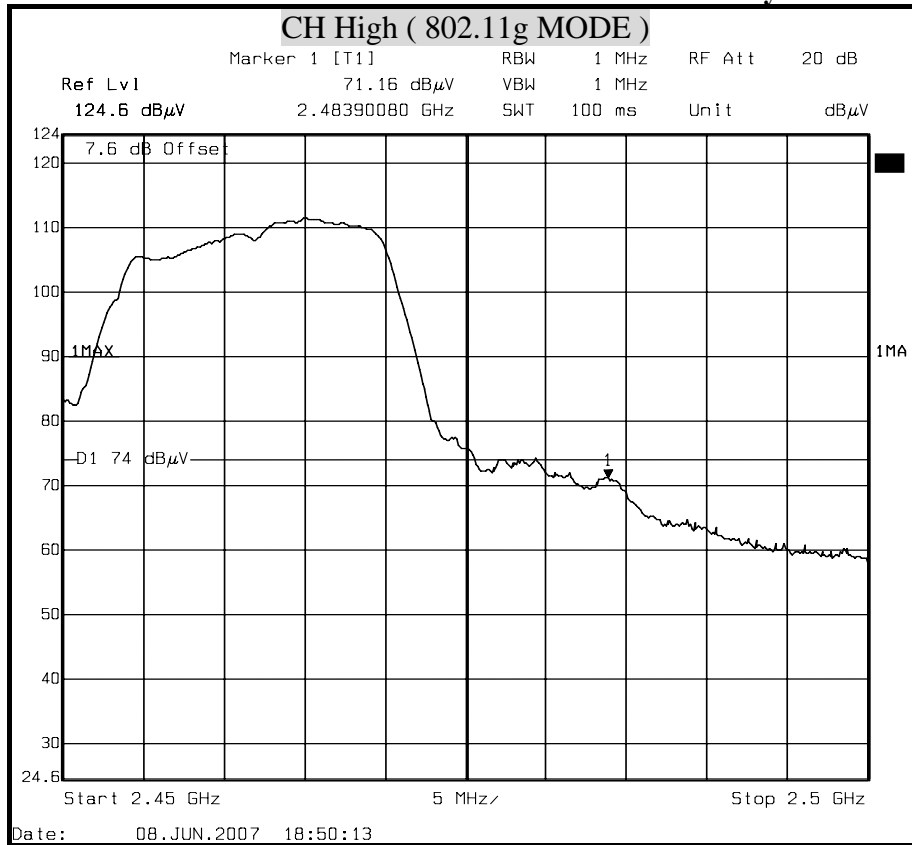

Detector mode : Average

Polarity : Vertical

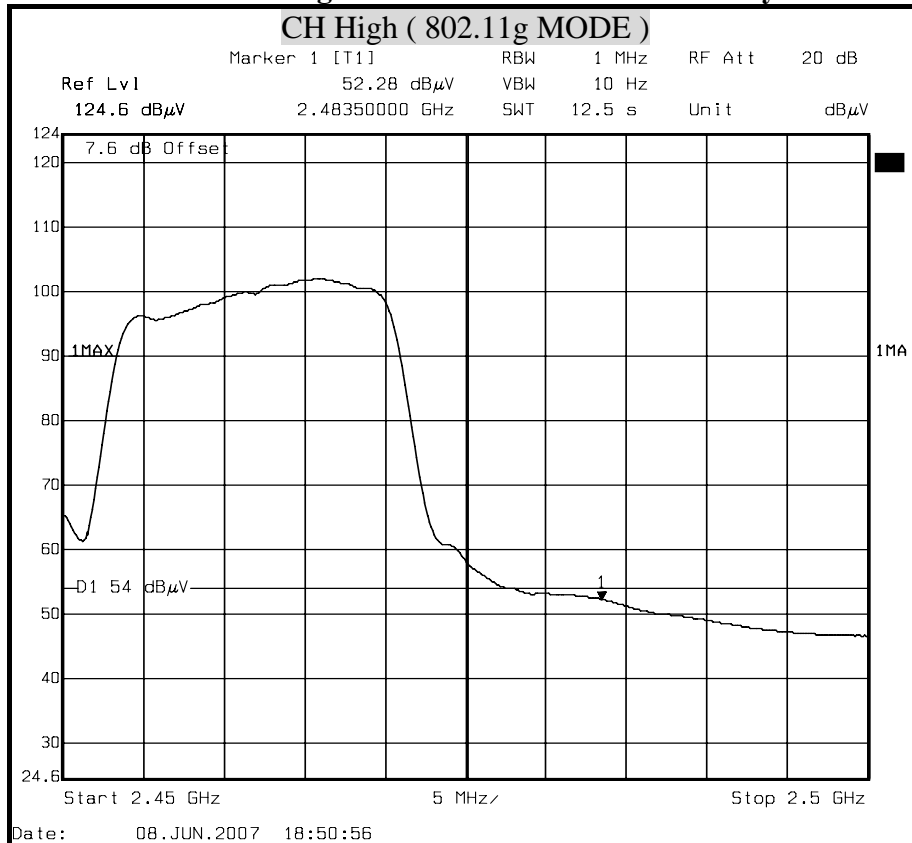



Detector mode : Peak **Polarity : Horizontal**

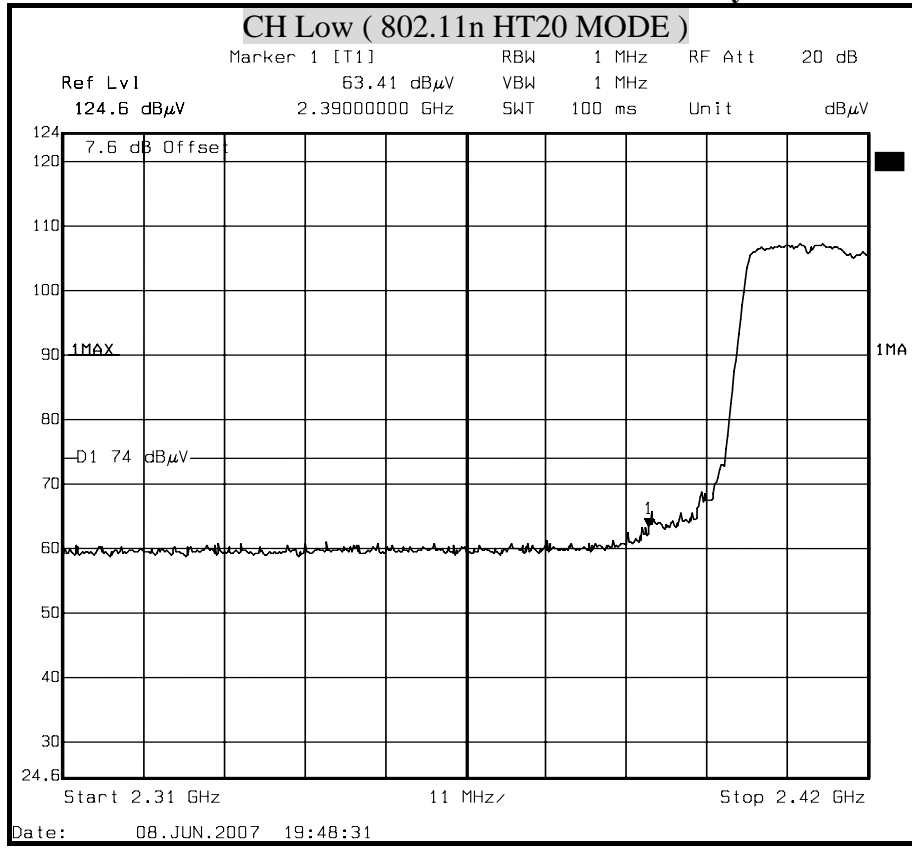

Detector mode : Average **Polarity : Horizontal**





Detector mode : Peak **Polarity : Vertical**

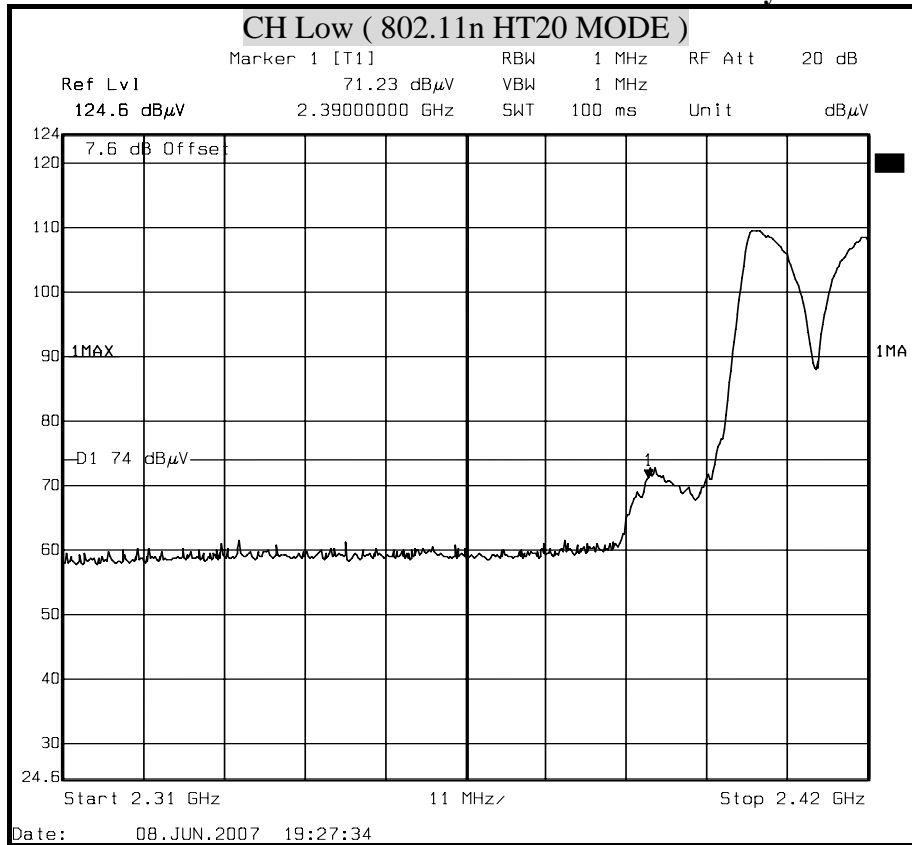

Detector mode : Average **Polarity : Vertical**

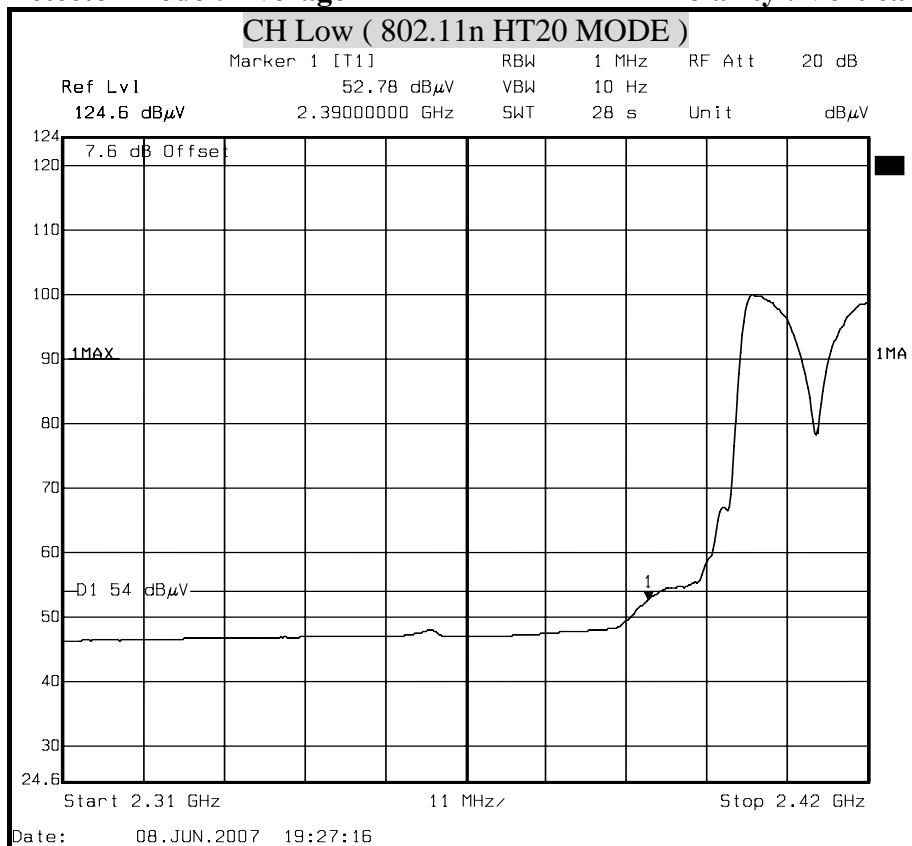



Detector mode : Peak **Polarity : Horizontal**

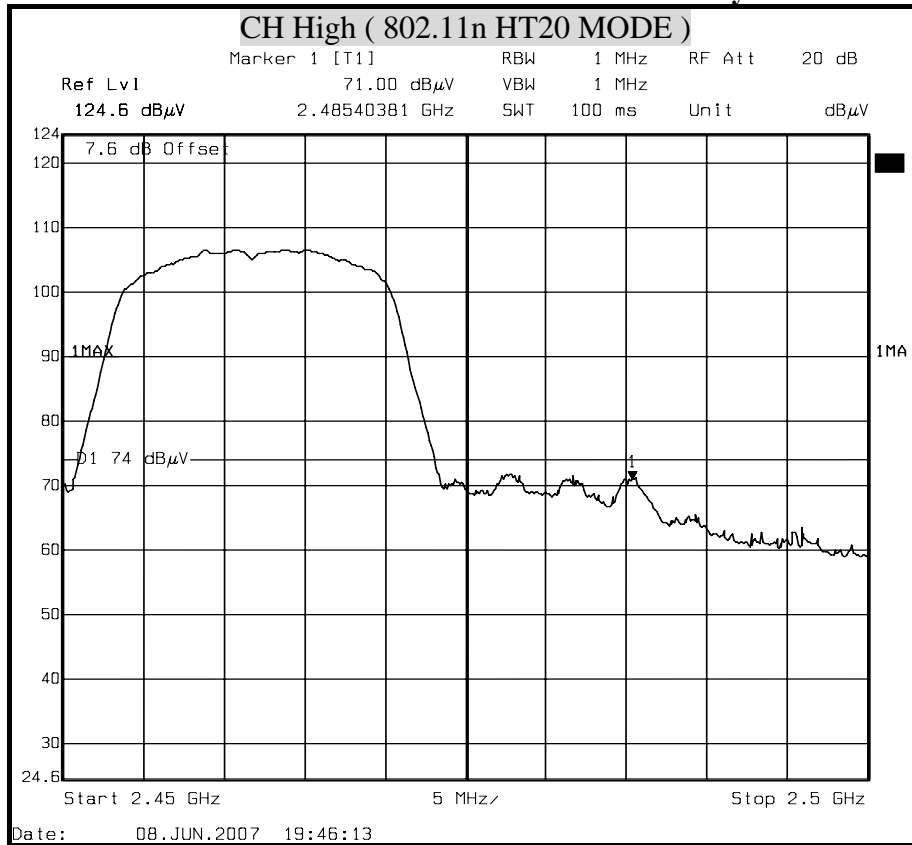

Detector mode : Average **Polarity : Horizontal**

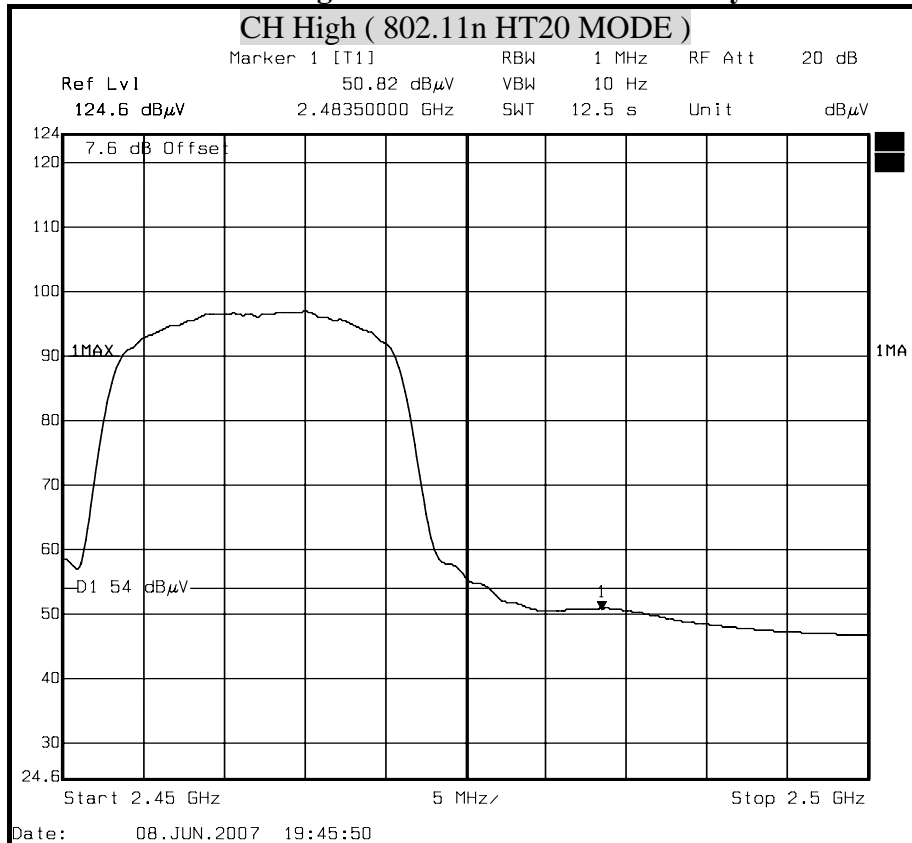



Detector mode : Peak

Polarity : Vertical

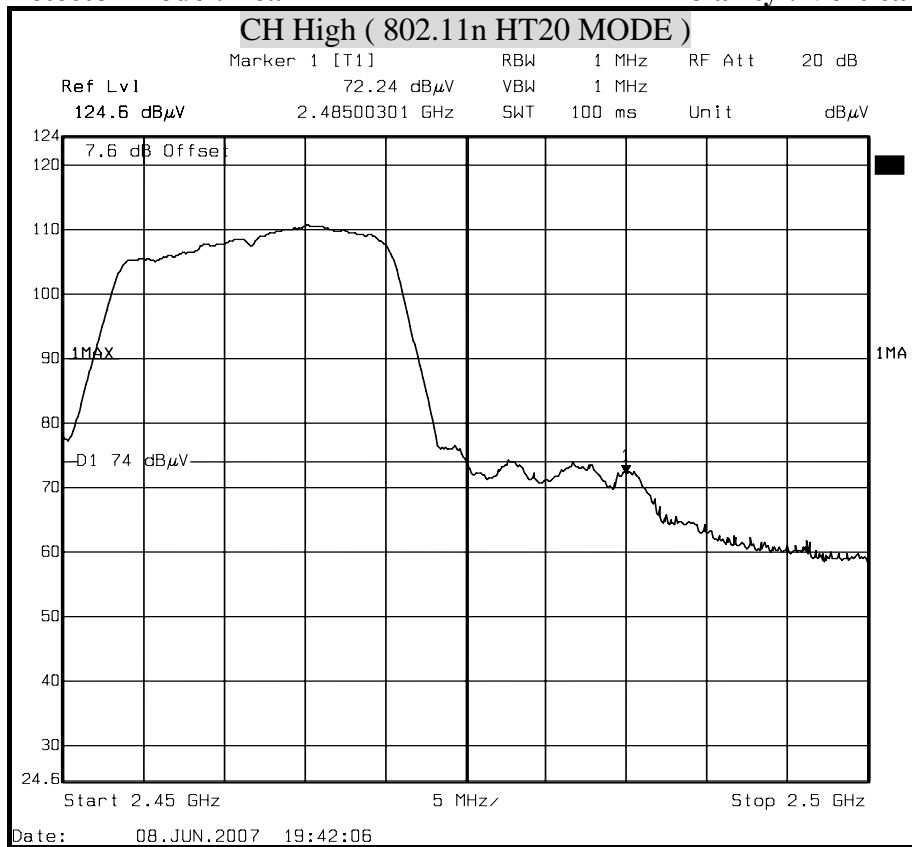

Detector mode : Average

Polarity : Vertical

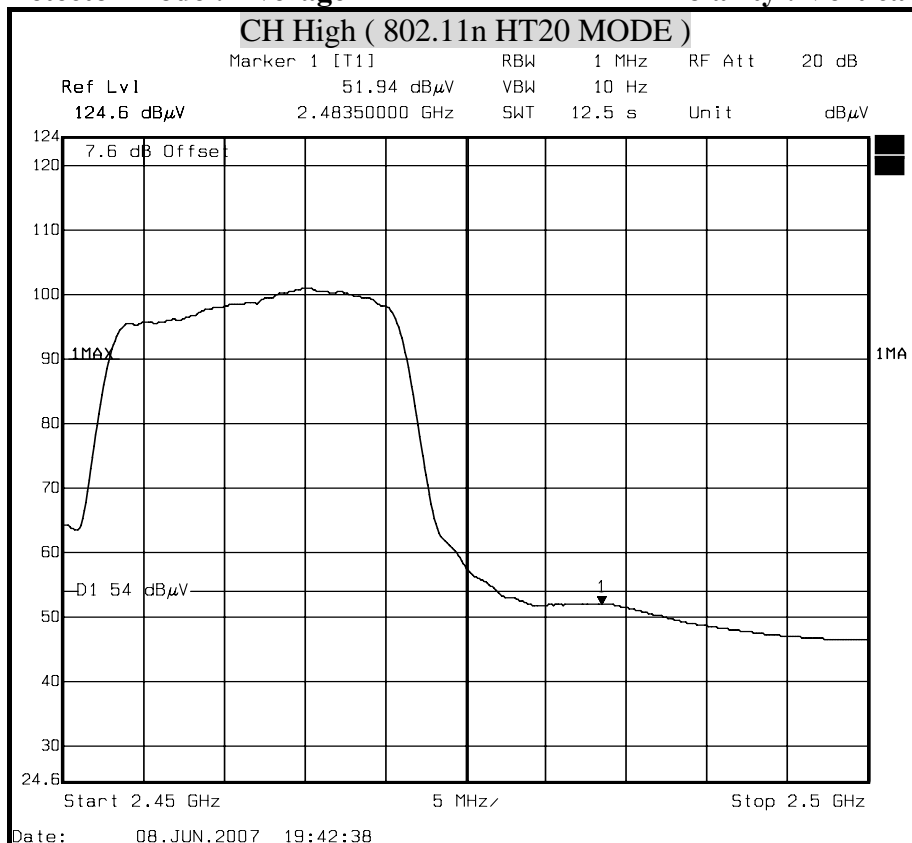



Detector mode : Peak **Polarity : Horizontal**

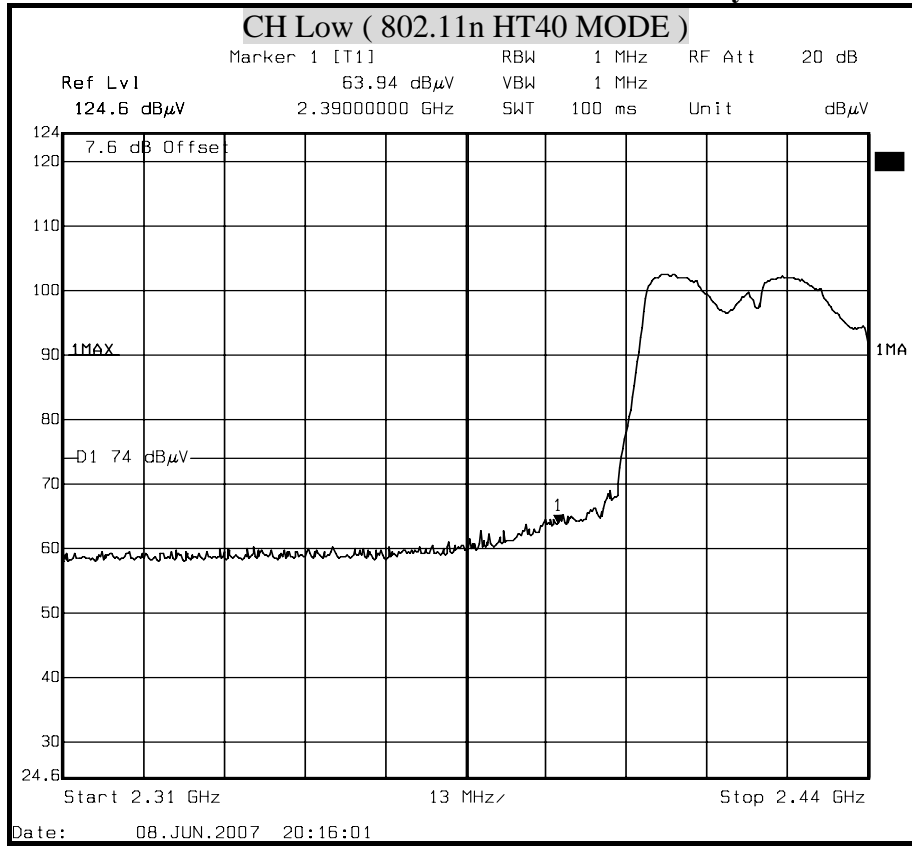

Detector mode : Average **Polarity : Horizontal**

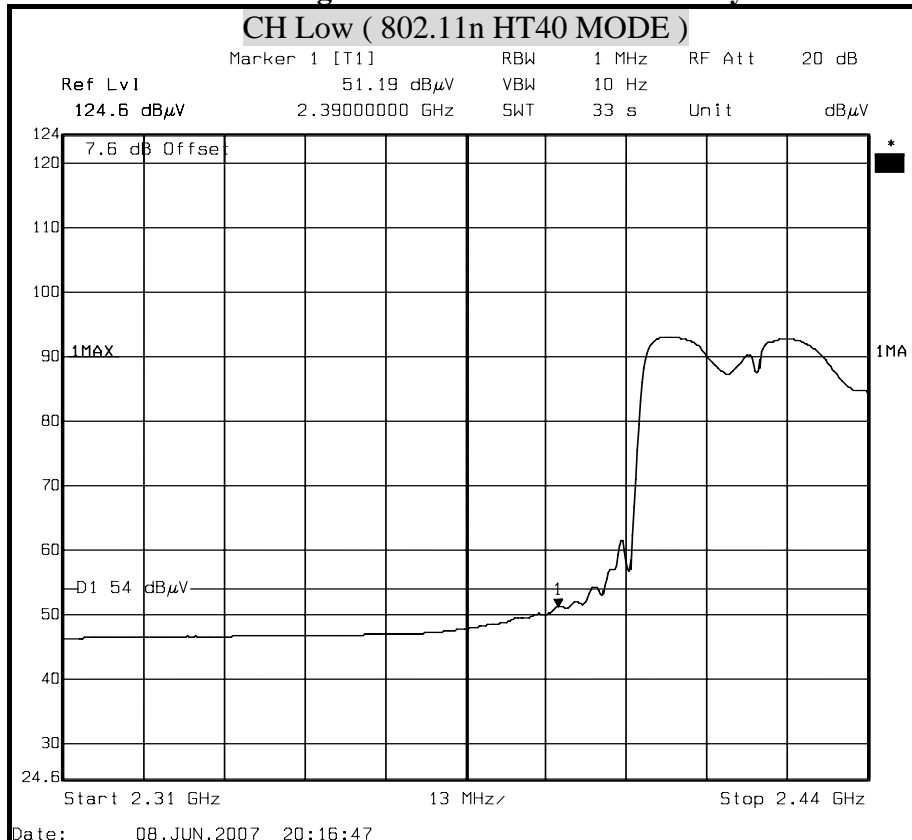



Detector mode : Peak **Polarity : Vertical**

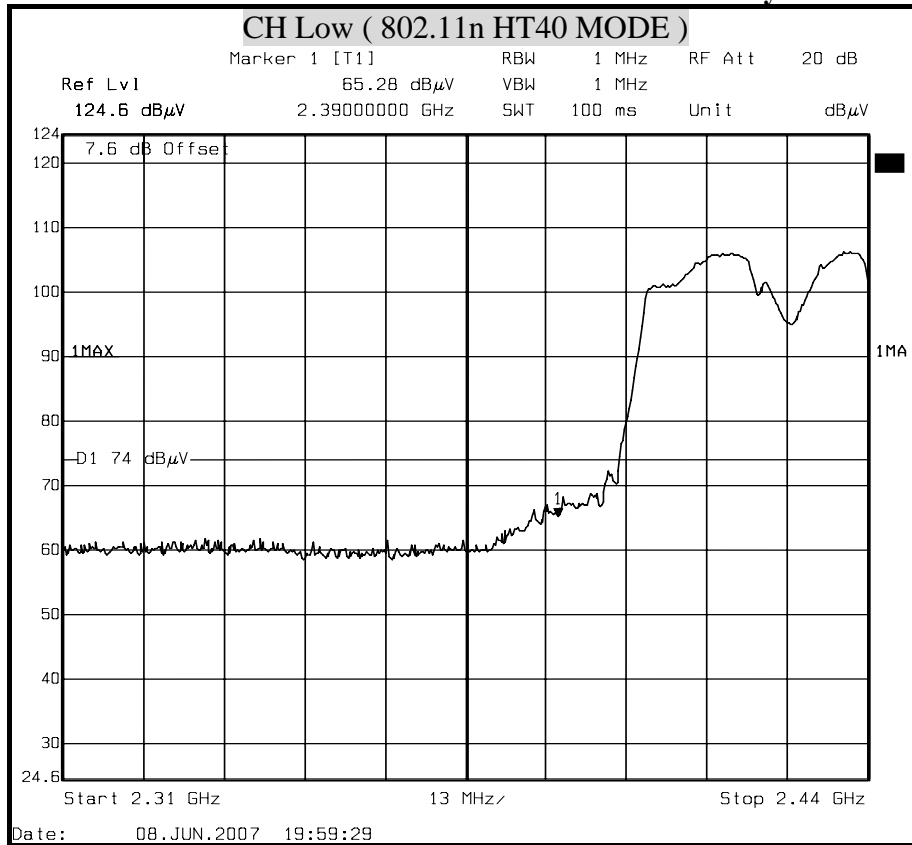

Detector mode : Average **Polarity : Vertical**

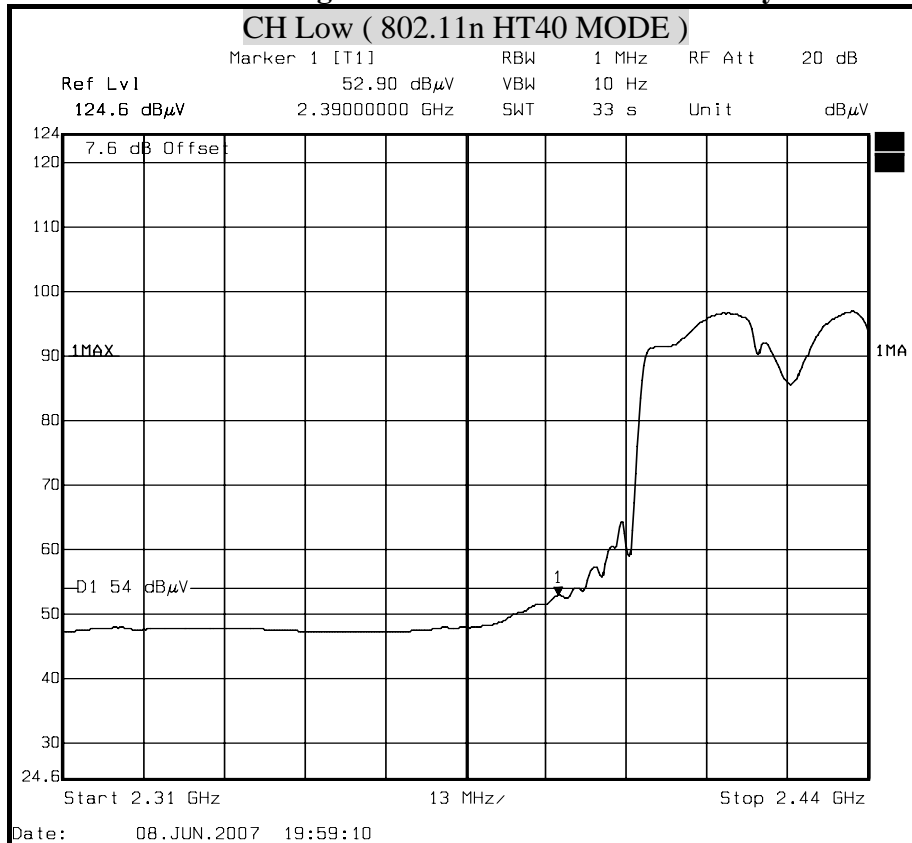



Detector mode : Peak

Polarity : Horizontal

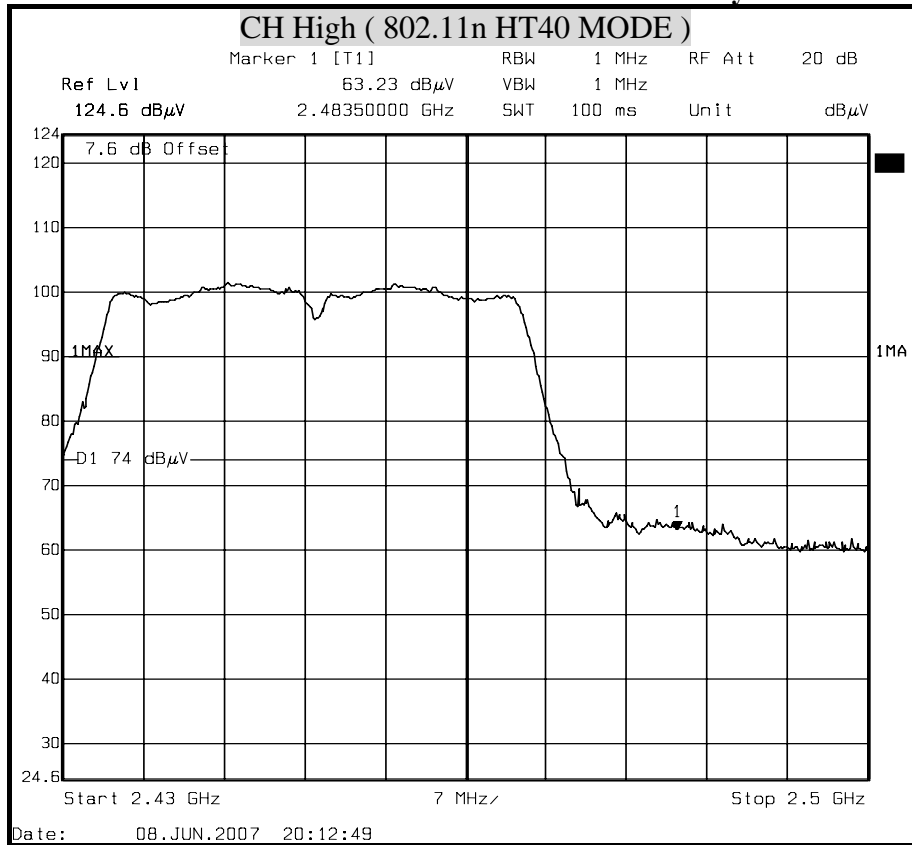

Detector mode : Average

Polarity : Horizontal

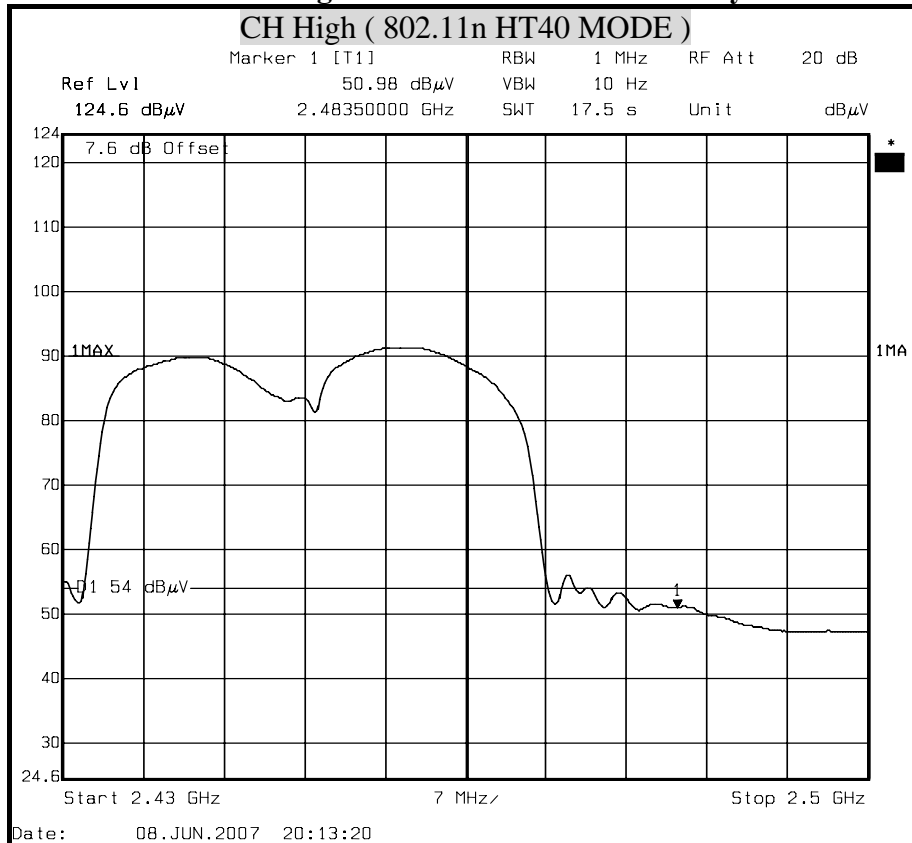



Detector mode : Peak

Polarity : Vertical

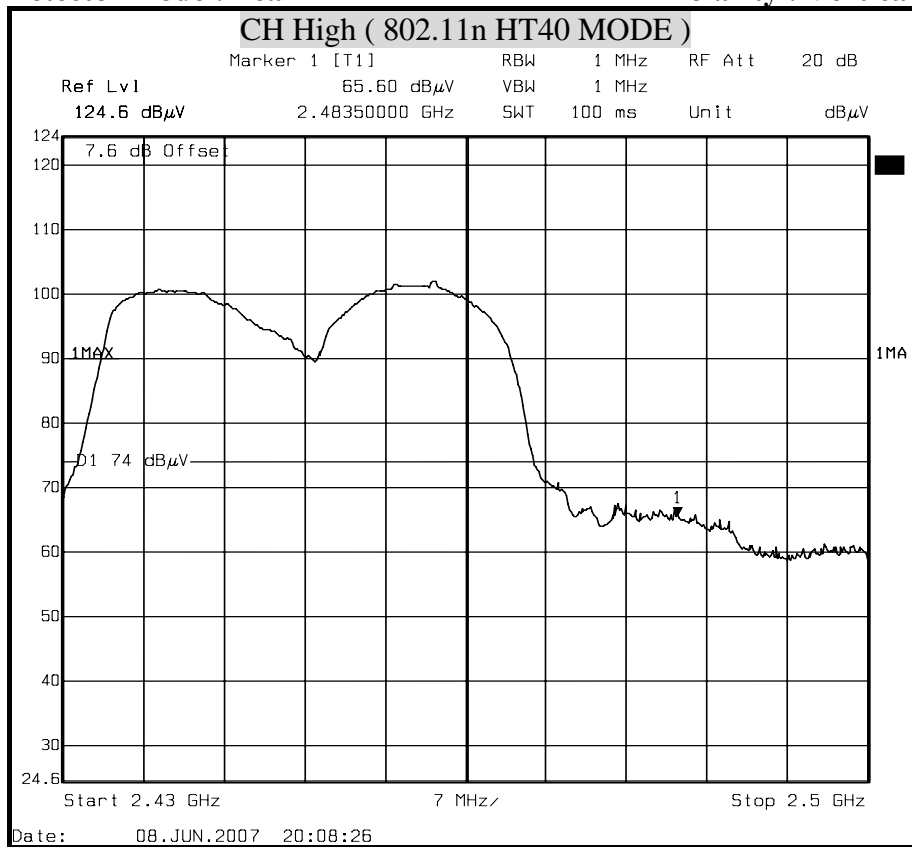

Detector mode : Average

Polarity : Vertical

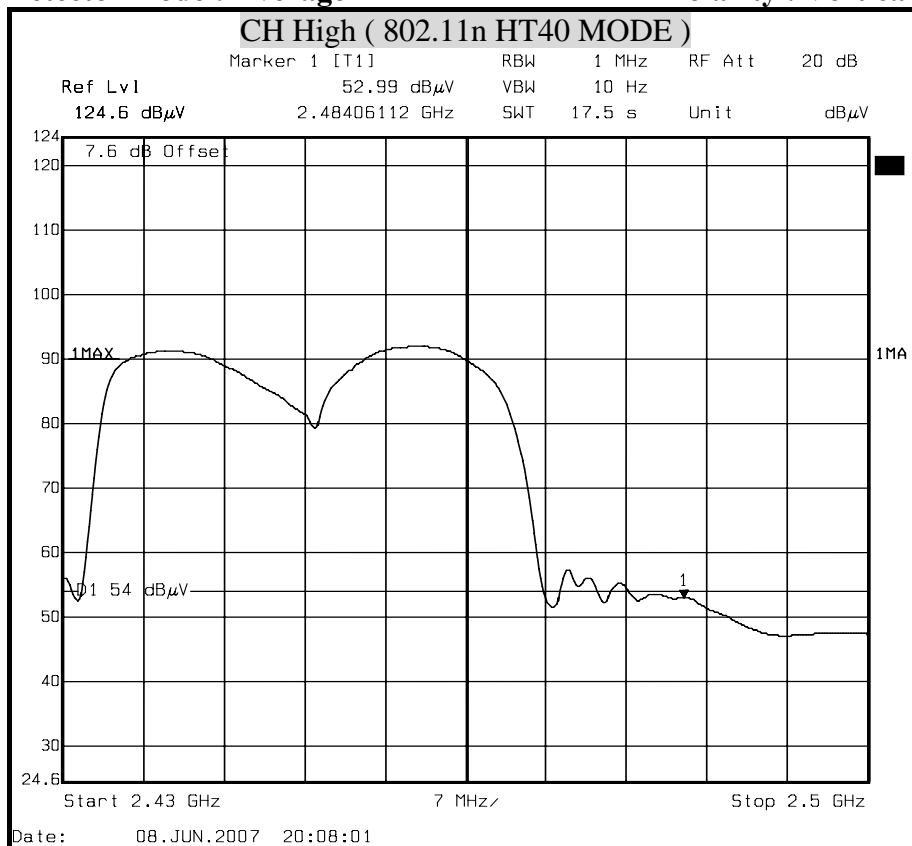



8.9 POWERLINE CONDUCTED EMISSIONS

LIMITS

§ 15.207 (a) Except as shown in paragraph (b) and (c) this section, for an intentional radiator that is designed to be connected to the public utility (AC) power line, the radio frequency voltage that is conducted back onto the AC power line on any frequency or frequencies within the band 150 kHz to 30 MHz shall not exceed the limits in the following table, as measured using a 50 μH/50 ohms line impedance stabilization network (LISN). Compliance with the provisions of this paragraph shall be based on the measurement of the radio frequency voltage between each power line and ground at the power terminal.

The lower limit applies at the boundary between the frequency ranges.

Frequency of Emission (MHz)	Conducted limit (dBμv)	
	Quasi-peak	Average
0.15 - 0.5	66 to 56	56 to 46
0.5 - 5	56	46
5 - 30	60	50

TEST EQUIPMENTS

The following test equipments are used during the conducted powerline tests:

Conducted Emission room				
Name of Equipment	Manufacturer	Model	Serial Number	Calibration Due
L.I.S.N.	SCHWARZBECK	NNLK 8121	8121-446	OCT. 31, 2007 For Insertion loss
	Rohde & Schwarz	ESH-Z5	840062/021	SEP. 21 , 2007
TEST RECEIVER	Rohde & Schwarz	ESCS 30	100348	JUN. 27, 2008
TYPE N COAXIAL CABLE	SUHNER	-----	-----	FEB. 26, 2008
Test S/W	e-3 (5.04211c) R&S (2.27)			



TEST SETUP

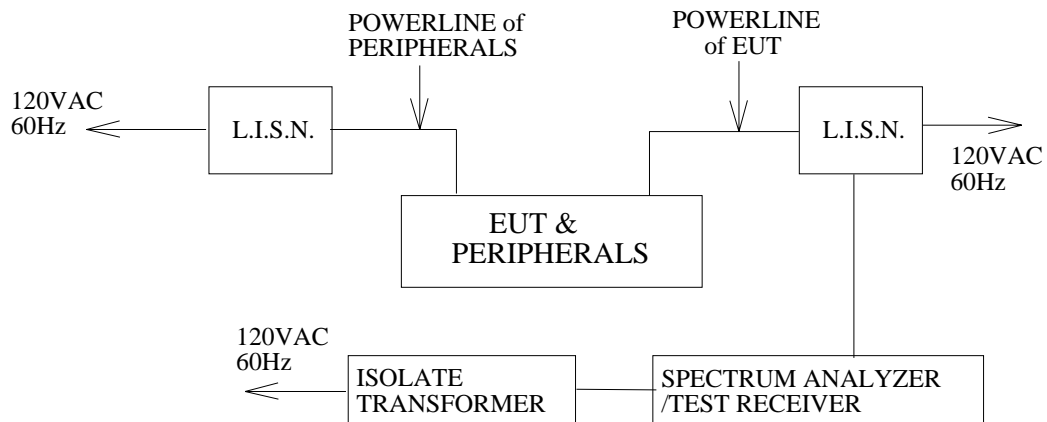

TEST PROCEDURE

The EUT is placed on a non-conducting table 40 cm from the vertical ground plane and 80cm above the horizontal ground plane. The EUT IS CONFIGURED IN ACCORDANCE WITH ANSI C63.4.

The resolution bandwidth is set to 9 kHz for both quasi-peak detection and average detection measurements.

Line conducted data is recorded for both NEUTRAL and LINE.

TEST RESULTS

No non-compliance noted



CONDUCTED RF VOLTAGE MEASUREMENT

Product Name	AirCruiser N300 Mini-PCI Adapter	Test Date	2007/06/13
Model	GN-WI30N-RH	Test By	Hanks Tsai
Test Mode	Normal operating (worst case)	TEMP & Humidity	27.9°C, 56%

LINE

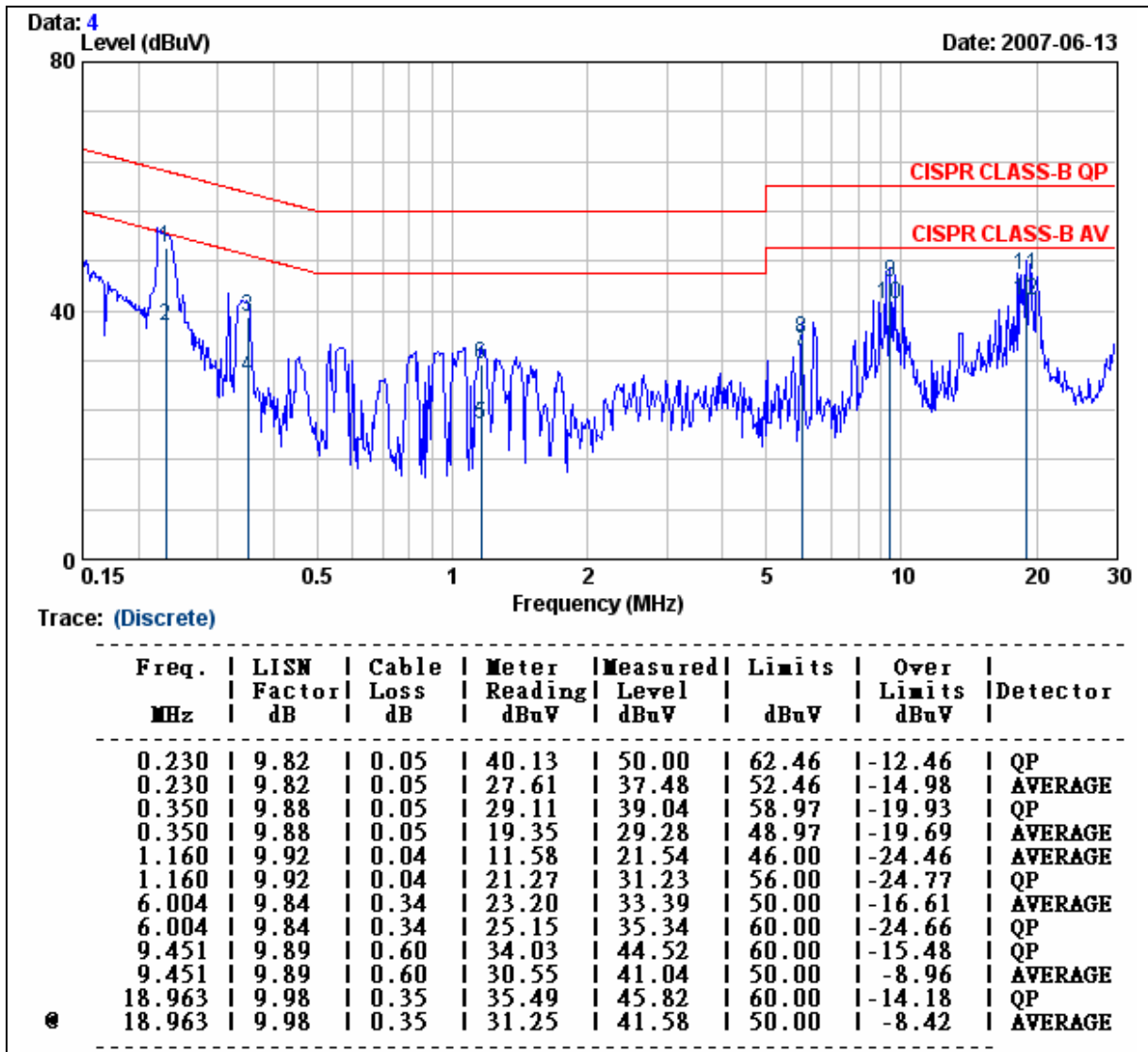

Remark:

1. Correction Factor = Insertion loss + cable loss
2. Margin value = Emission level – Limit value



Product Name	AirCruiser N300 Mini-PCI Adapter	Test Date	2007/06/13
Model	GN-WI30N-RH	Test By	Hanks Tsai
Test Mode	Normal operating (worst case)	TEMP & Humidity	27.9°C, 56%

NEUTRAL

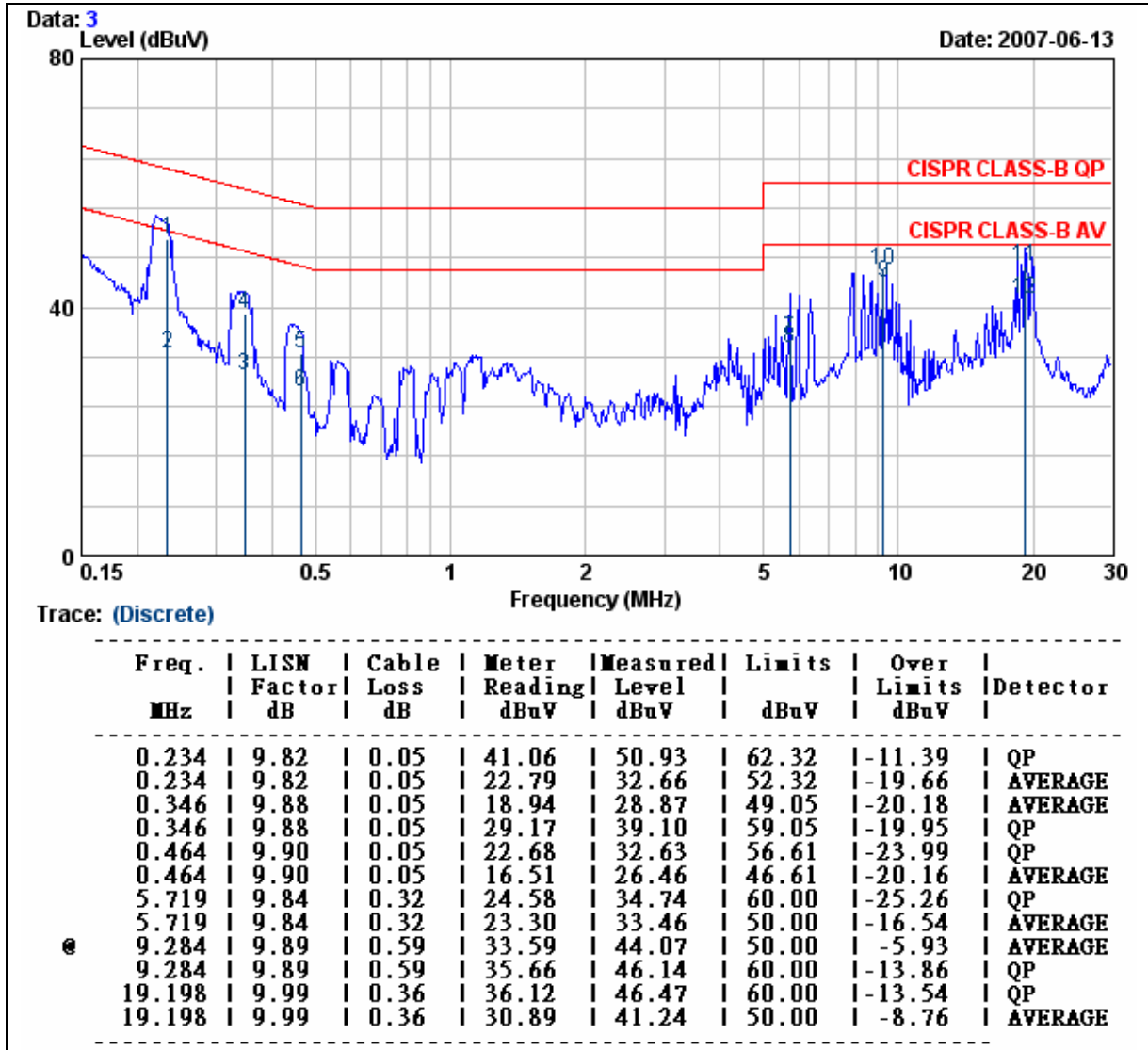

Remark:

1. Correction Factor = Insertion loss + cable loss
2. Margin value = Emission level - Limit value



9. ANTENNA REQUIREMENT

9.1 STANDARD APPLICABLE

For intentional device, according to FCC 47 CFR Section 15.203, an intentional radiator shall be designed to ensure that no antenna other than that furnished by the responsible party shall be used with the device.

And according to FCC 47 CFR Section 15.247 (b), if transmitting antennas of directional gain greater than 6dBi are used, the power shall be reduced by the amount in dB that the directional gain of the antenna exceeds 6dBi.

9.2 ANTENNA CONNECTED CONSTRUCTION

The antenna used for this product is Dipole antenna. The peak Gain of this antenna is 4.5dBi at 2.4GHz.



APPENDIX SETUP PHOTOS

RADIATED EMISSION MEASUREMENT SETUP





RADIATED RF MEASUREMENT SETUP







POWERLINE CONDUCTED EMISSIONS MEASUREMENT SETUP

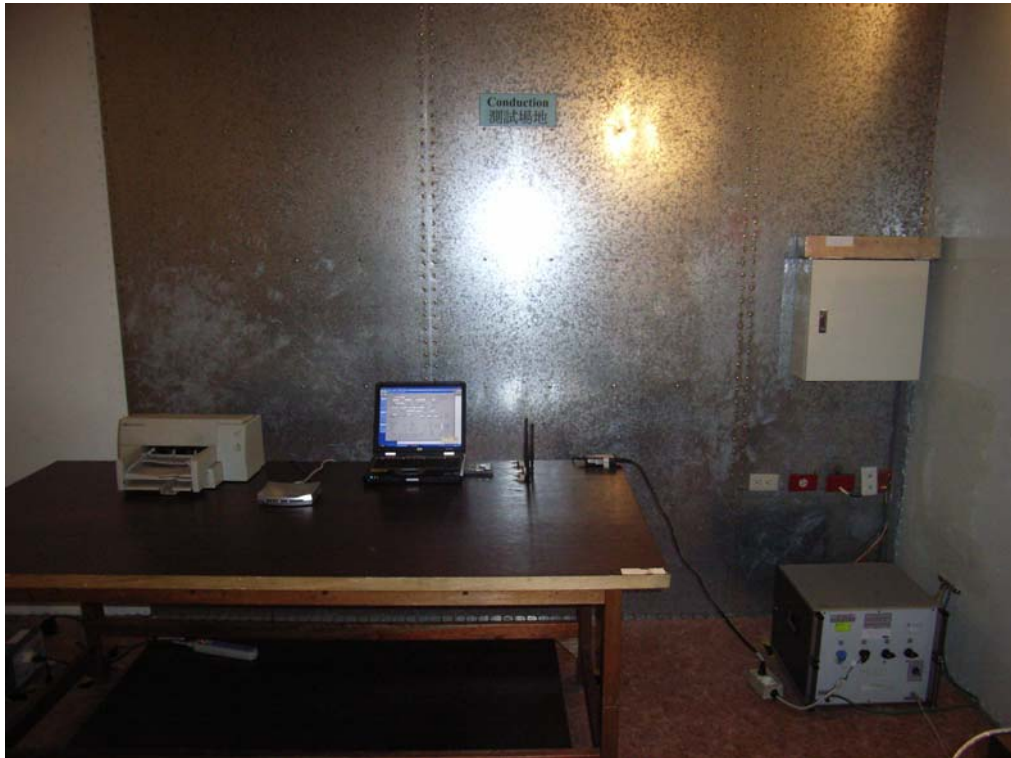

End of report