



FCC 47 CFR PART 15 SUBPART C AND ANSI C63.4 : 2003

TEST REPORT

For

AirCruiser N300 Mini-PCI Adapter

Model : GN-WI30N-RH

Trade Name : GIGA-BYTE

Issued for

GIGA-BYTE TECHNOLOGY CO., LTD.

No.6, Bau Chiang Road, Hsin-Tien, Taipei Hsien, Taiwan, R.O.C.

Issued by

Compliance Certification Services Inc.

Tainan Lab.

**No. 8, Jiu Cheng Ling, Jiaokeng Village, Sinhua
Township, Tainan Hsien 712, Taiwan R.O.C.**

TEL: 886-6-580-2201

FAX: 886-6-580-2202



NVLAP LAB CODE 200627-0



Note: This report shall not be reproduced except in full, without the written approval of Compliance Certification Services Inc. Ltd. This document may be altered or revised by Compliance Certification Services Inc. personnel only, and shall be noted in the revision section of the document

Total Page: 176



Revision History

Rev.	Issue Date	Revisions	Effect Page	Revised By
00	July 20, 2007	Initial Issue	ALL	Leah Peng



TABLE OF CONTENTS

1. TEST REPORT CERTIFICATION..... 5

2. EUT DESCRIPTION..... 6

 2.1 DESCRIPTION OF EUT & POWER 6

3. DESCRIPTION OF TEST MODES 7

4. TEST METHODOLOGY..... 8

5. FACILITIES AND ACCREDITATIONS 8

 5.1 FACILITIES..... 8

 5.2 EQUIPMENT 8

 5.3 LABORATORY ACCREDITATIONS LISTINGS..... 8

 5.4 TABLE OF ACCREDITATIONS AND LISTINGS 9

6. CALIBRATION AND UNCERTAINTY 10

 6.1 MEASURING INSTRUMENT CALIBRATION..... 10

 6.2 MEASUREMENT UNCERTAINTY 10

7. SETUP OF EQUIPMENT UNDER TEST..... 11

 7.1 SETUP CONFIGURATION OF EUT 11

 7.2 SUPPORT EQUIPMENT 11

 7.3 EUT OPERATING CONDITION..... 12

8. APPLICABLE LIMITS AND TEST RESULTS..... 14

 8.1 6dB BANDWIDTH..... 14

 8.2 99% BANDWIDTH 32

 8.3 MAXIMUM PEAK OUTPUT POWER 50

 8.4 MAXIMUM PERMISSIBLE EXPOSURE 69

 8.4 MAXIMUM PERMISSIBLE EXPOSURE 69

 8.5 AVERAGE POWER..... 71

 8.6 POWER SPECTRAL DENSITY 73

 8.7 CONDUCTED SPURIOUS EMISSION 100

 OUT-OF-BAND COMBINED SPURIOUS EMISSIONS-CONDUCTED MEASUREMENT 117

 8.8 RADIATED EMISSIONS..... 125

 8.8.1 TRANSMITTER RADIATED SUPURIOUS EMSSIONS 125

 8.8.2 WORST-CASE RADIATED EMISSION BELOW 1 GHz..... 129

 8.8.3 TRANSMITTER RADIATED EMISSION ABOVE 1 GHz..... 130

 8.8.4 RESTRICTED BAND EDGES 154

 8.9 POWERLINE CONDUCTED EMISSIONS 170



9. ANTENNA REQUIREMENT 174

 9.1 STANDARD APPLICABLE 174

 9.2 ANTENNA CONNECTED CONSTRUCTION 174

APPENDIX SETUP PHOTOS 175



1. TEST REPORT CERTIFICATION

Applicant : GIGA-BYTE TECHNOLOGY CO., LTD.
Address : No.6, Bau Chiang Road, Hsin-Tien, Taipei Hsien, Taiwan, R.O.C.
Manufacture : GIGA-BYTE TECHNOLOGY CO., LTD.
Address : No.6, Bau Chiang Road, Hsin-Tien, Taipei Hsien, Taiwan, R.O.C.
Equipment Under Test : AirCruiser N300 Mini-PCI Adapter
Model Number : GN-WI30N-RH
Trade Name : GIGA-BYTE
Date of Test : June 8, 2007 ~ June 12, 2007

APPLICABLE STANDARD	
STANDARD	TEST RESULT
FCC Part 15 Subpart C : 2004 AND ANSI C63.4 : 2003	No non-compliance noted

Approved by:

July 20, 2007

Jeter Wu

Section Manager
Compliance Certification Services Inc.

Reviewed by:

July 20, 2007

Eric Yang

Engineer
Compliance Certification Services Inc.



2. EUT DESCRIPTION

2.1 DESCRIPTION OF EUT & POWER

Product Name	AirCruiser N300 Mini-PCI Adapter
Model Number	GN-WI30N-RH
Trade Name	GIGA-BYTE
Frequency Range	IEEE 802.11b/g, 802.11n HT20 (DTS Band):2412MHz~2462MHz IEEE 802.11n HT40 (DTS Band):2422MHz~2452MHz
Transmit Power (ERP)	IEEE 802.11b: 25.49dBm (DTS Band) (354.03mW) IEEE 802.11g: 28.00dBm (DTS Band) (631.543mW) IEEE 802.11n HT20: 27.08dBm (DTS Band) (510.574mW) IEEE 802.11n HT40: 26.93dBm (DTS Band) (492.696mW)
Channel Spacing	IEEE 802.11b/g, 802.11n HT20/HT40: 5MHz
Channel Number	IEEE 802.11b/g, 802.11n HT20:11 Channels IEEE 802.11n HT40 :7 Channels
Transmit Data Rate	IEEE 802.11b:11, 5.5, 2, 1Mbps IEEE 802.11g : 54, 48, 36, 24, 18, 12, 11, 9, 6Mbps IEEE 802.11n HT20 : 130, 117, 104, 78, 65, 58.5, 52, 39, 26, 19.5, 13, 6.5 Mbps IEEE 802.11n HT40 : 130, 117, 104, 78, 65, 58.5, 52, 39, 26, 19.5, 13, 6.5 Mbps
Type of Modulation	IEEE 802.11b : DSSS (CCK, DQPSK, DBPSK) IEEE 802.11g : OFDM (64QAM, 16QAM, QPSK, BPSK) IEEE 802.11n HT20/40 : OFDM (64QAM, 16QAM, QPSK, BPSK)
Frequency Selection	by software / firmware
Antenna Type	Manufacture: ARISTOTLE ENTERPRISES INC. M/N: RFA-02-5-C7M314B3 Gain: 4.5dBi Connector Type: RP-SMA PLUG Dipole Antenna (× 3).
Power Source	3.3Vdc (Powered from host device or Notebook)

- Remark :**
1. The sample selected for test was engineering sample that approximated to production product and was provided by manufacturer.
 2. This submittal(s) (test report) is intended for FCC ID: JCK-GN-WI30N-RH filing to comply with Section 15.207, 15.209 and 15.247 of the FCC Part 15, Subpart C Rules.



3. DESCRIPTION OF TEST MODES

The EUT is an 802.11n MIMO transceiver in Mini-PCI module form factor. It has two transmitter chains and three receive chains (2x3 configurations). The 2x3 configuration is implemented with three outside chains (Chain 0 and 1).

The RF chipset is manufactured by Ralink Technology, Corp.

The antenna peak gain 4.5dBi (highest gain) were chosen for full testing.

IEEE 802.11 b ,802.11g ,802.11n HT20 mode (DTS Band)

The EUT had been tested under operating condition.

There are three channels have been tested as following :

Channel	Frequency (MHz)
Low	2412
Middle	2437
High	2462

IEEE 802.11b mode : 11Mbps data rate (worst case) were chosen for full testing.

IEEE 802.11g mode : 6Mbps data rate (worst case) were chosen for full testing.

IEEE 802.11n HT20 mode : 6.5Mbps data rate (worst case) were chosen for full testing.

IEEE 802.11n HT40 mode (DTS Band)

The EUT had been tested under operating condition.

There are three channels have been tested as following :

Channel	Frequency (MHz)
Low	2422
Middle	2437
High	2452

IEEE 802.11n HT40 mode : 6.5Mbps data rate (worst case) were chosen for full testing.

The worst-case data rates are determined according to the description above, based on the investigations by measuring the PSD, peak power and average power across all the data rates, bandwidths, modulations and spatial stream modes.

The worst-case channel is determined as the channel with the highest output power. The highest measured output power was at 2437 MHz.



4. TEST METHODOLOGY

The tests documented in this report were performed in accordance with ANSI C63.4 and FCC CFR 47 2.1046, 2046, 2.1047, 2.1049, 2.1051, 2.1053, 2.1055, 2.1057, 15.207, 15.209 and 15.247.

5. FACILITIES AND ACCREDITATIONS

5.1 FACILITIES

All measurement facilities used to collect the measurement data are located at No. 8, Jiu Cheng Ling, Jiaokeng Village, Sinhua Township, Tainan Hsien 712, Taiwan R.O.C. The sites are constructed in conformance with the requirements of ANSI C63.7, ANSI C63.4 and CISPR Publication 22.

5.2 EQUIPMENT

Radiated emissions are measured with one or more of the following types of linearly polarized antennas: tuned dipole, biconical, log periodic, bi-log, and/or ridged waveguide, horn. Spectrum analyzers with preselectors and quasi-peak detectors are used to perform radiated measurements.

Conducted emissions are measured with Line Impedance Stabilization Networks and EMI Test Receivers.







Calibrated wideband preamplifiers, coaxial cables, and coaxial attenuators are also used for making measurements.

All receiving equipment conforms to CISPR Publication 16-1, "Radio Interference Measuring Apparatus and Measurement Methods."

5.3 LABORATORY ACCREDITATIONS LISTINGS

The test facilities used to perform radiated and conducted emissions tests are accredited by National Voluntary Laboratory Accreditation Program for the specific scope of accreditation under Lab Code: 200627-0 to perform Electromagnetic Interference tests according to FCC PART 15 AND CISPR 22 requirements. No part of this report may be used to claim or imply product endorsement by NVLAP or any agency of the US Government. In addition, the test facilities are listed with Federal Communications Commission (registration no: 228014).

5.4 TABLE OF ACCREDITATIONS AND LISTINGS

Country	Agency	Scope of Accreditation	Logo
USA	NVLAP	EN 55014-1, AS/NZS 1044, CNS 13783-1, IEC/CISPR 14-1, IEC/CISPR 22, EN 55022, EN 61000-3-2, EN 61000-3-3, ANSI C63.4, AS/NZS CISPR 22, AS/NZS 3548, IEC 61000-4-2/3/4/5/6/8/11	 NVLAP LAB CODE 200627-0 200627-0
USA	FCC	3/10 meter Open Area Test Sites to perform FCC Part 15/18 measurements	 228014
Japan	VCCI	3/10 meter Open Area Test Sites and conducted test sites to perform radiated/conducted measurements	 R-1989 C-2142
Taiwan	TAF	CISPR 11 FCC METHOD-47 CFR Part 18 EN 55011 CNS 13803, CISPR 14 EN 55014 CNS 13783-1, CISPR 22 EN 55022 VCCI FCC Method-47 CFR Part 15 Subpart B CNS 13438	 Testing Laboratory 1109
Taiwan	BSMI	CNS 13438, CNS 13783-1, CNS 13803, CNS13439	 SL2-IS-E-0039 SL2-IN-E-0039 SL2-R1/R2-0039 SL2-A1-E-0039
Canada	Industry Canada	RSS212, Issue 1	 IC 6192

* No part of this report may be used to claim or imply product endorsement by NVLAP or any agency of the US Government.



6. CALIBRATION AND UNCERTAINTY

6.1 MEASURING INSTRUMENT CALIBRATION

The measuring equipment utilized to perform the tests documented in this report has been calibrated in accordance with the manufacturer's recommendations, and is traceable to recognized national standards.

6.2 MEASUREMENT UNCERTAINTY

Where relevant, the following measurement uncertainty levels have been estimated for tests performed on the apparatus:

PARAMETER	UNCERTAINTY
Radiated Emission, 30 to 1000 MHz	+/- 3.2 dB
Radiated Emission, 1 to 26.5 GHz	+/- 3.2 dB
Power Line Conducted Emission	+/- 2.1 dB

Uncertainty figures are valid to a confidence level of 95%

7. SETUP OF EQUIPMENT UNDER TEST

7.1 SETUP CONFIGURATION OF EUT

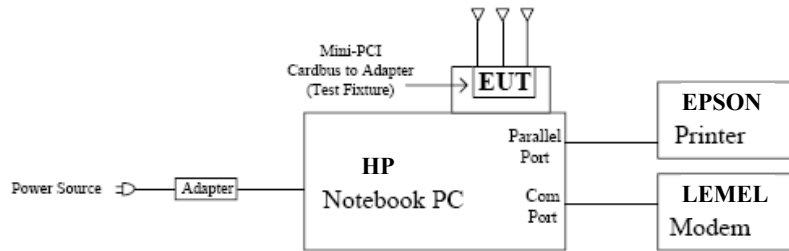

On table

7.2 SUPPORT EQUIPMENT

No.	Product	Manufacturer	Model No.	Certify No.	Signal cable
1	Modem	LEMEL	MD-56K	DoC	RS232 cable, shd, 1.1m
2	Printer	EPSON	EPSON C43UX	DoC	Printer cable, shd, 1.8m
3	Note Book	HP	CNC 6000	CNTPP2090	Power cable, unshd, 1.6m

Remark:

1. All the above equipment/cables were placed in worse case positions to maximize emission signals during emission test.
2. Grounding was established in accordance with the manufacturer's requirements and conditions for the intended use.



7.3 EUT OPERATING CONDITION

1. Set up all computers like the setup diagram.
2. The “**Ralink QA Test Program for RT2860**” software was used for testing.
The EUT driver software installed in the host support equipment during testing was Ralink QA Test Program for RT2860 Drive.

(1) **TX Mode:**

⇒ **Tx Mode:**CCK 、OFDM 、 HT MixMode (Bandwidth: 20 、40)

⇒ **Tx Data Rate:**LP 1Mbps (IEEE 802.11b mode, chain 0/1 TX)

6Mbps (IEEE 802.11g mode, chain 0/1 TX)

6.5Mbps (IEEE 802.11n HT20 mode, chain 0/1 TX)

6.5Mbps (IEEE 802.11n HT40 mode, chain 0/1 TX)

⇒

⇒ **Power control mode**

Target Power: IEEE 802.11b Channel Low (2412MHz) = **10 (Chain 0)**

IEEE 802.11b Channel Low (2412MHz) = **15 (Chain 1)**

IEEE 802.11b Channel Middle (2437MHz) = **11 (Chain 0)**

IEEE 802.11b Channel Middle (2437MHz) = **8 (Chain 1)**

IEEE 802.11b Channel High (2462MHz) = **13 (Chain 0)**

IEEE 802.11b Channel High (2462MHz) = **13 (Chain 1)**

Target Power: IEEE 802.11g Channel Low (2412MHz) = **16 (Chain 0)**

IEEE 802.11g Channel Low (2412MHz) = **18 (Chain 1)**

IEEE 802.11g Channel Middle (2437MHz) = **15 (Chain 0)**

IEEE 802.11g Channel Middle (2437MHz) = **16 (Chain 1)**

IEEE 802.11g Channel High (2462MHz) = **18 (Chain 0)**

IEEE 802.11g Channel High (2462MHz) = **18 (Chain 1)**

Target Power: IEEE 802.11n HT20 Channel Low (2412MHz) = **12 (Chain 0)**

IEEE 802.11n HT20 Channel Low (2412MHz) = **17 (Chain 1)**

IEEE 802.11n HT20 Channel Middle (2437MHz) = **13 (Chain 0)**

IEEE 802.11n HT20 Channel Middle (2437MHz) = **12 (Chain 1)**

IEEE 802.11n HT20 Channel High (2462MHz) = **18 (Chain 0)**

IEEE 802.11n HT20 Channel High (2462MHz) = **18 (Chain 1)**



Target Power: IEEE 802.11n HT40 Channel Low (2422MHz) = **11 (Chain 0)**
IEEE 802.11n HT40 Channel Low (2422MHz) = **14 (Chain 1)**
IEEE 802.11n HT40 Channel Middle (2437MHz) = **9 (Chain 0)**
IEEE 802.11n HT40 Channel Middle (2437MHz) = **14 (Chain 1)**
IEEE 802.11n HT40 Channel High (2452MHz) = **10 (Chain 0)**
IEEE 802.11n HT40 Channel High (2452MHz) = **11 (Chain 1)**

(2) RX Mode :

MAC Address: FFFFFFFFFF

Start RX

3. All of the function are under run.
4. Start test.

For Normal operating :

1. Set up all computers like the setup diagram.
2. Notebook PC (2) ping 192.168.0.10 –t to Notebook PC(1).
3. Notebook PC (1) ping 192.168.0.20 –t to Notebook PC(2).
4. Notebook PC (1) (2) ping 192.168.0.50 –t to AP.
5. All of the function are under run.
6. Start test.



8. APPLICABLE LIMITS AND TEST RESULTS

8.1 6dB BANDWIDTH

LIMIT

§ 15.207(a) (2) For direct sequence systems, the minimum 6dB bandwidth shall be at least 500kHz

TEST EQUIPMENTS

Name of Equipment	Manufacturer	Model	Serial Number	Calibration Due
Spectrum Analyzer	R&S	FSEM	829054/017	MAR. 13, 2008

TEST SETUP

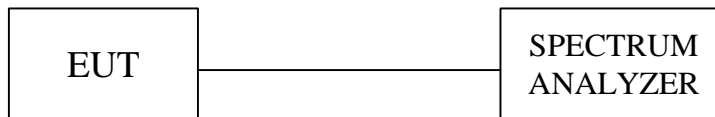

TEST PROCEDURE

The transmitter output was connected to a spectrum analyzer. The bandwidth of the fundamental frequency was measured by spectrum analyzer with 100 KHz RBW and 300 KHz VBW. The 6dB bandwidth is defined as the total spectrum the power of which is higher than peak power minus 6dB.

**TEST RESULTS**

No non-compliance noted

IEEE 802.11b mode (Two TX)

Channel	Channel Frequency (MHz)	6dB Bandwidth (kHz)		Minimum Limit (kHz)	Pass / Fail
		Chain 0	Chain 1		
Low	2412	12925	12825	500	PASS
Middle	2437	12825	12825	500	PASS
High	2462	12825	12825	500	PASS

IEEE 802.11g mode (Two TX)

Channel	Channel Frequency (MHz)	6dB Bandwidth (kHz)		Minimum Limit (kHz)	Pass / Fail
		Chain 0	Chain 1		
Low	2412	16733	16633	500	PASS
Middle	2437	16733	16733	500	PASS
High	2462	16733	16733	500	PASS

IEEE 802.11n HT20 mode (Two TX)

Channel	Channel Frequency (MHz)	6dB Bandwidth (kHz)		Minimum Limit (kHz)	Pass / Fail
		Chain 0	Chain 1		
Low	2412	17835	17835	500	PASS
Middle	2437	17835	17835	500	PASS
High	2462	17835	17835	500	PASS

IEEE 802.11n HT40 mode (Two TX)

Channel	Channel Frequency (MHz)	6dB Bandwidth (kHz)		Minimum Limit (kHz)	Pass / Fail
		Chain 0	Chain 1		
Low	2422	36673	36472	500	PASS
Middle	2437	36673	36673	500	PASS
High	2452	36673	36673	500	PASS



6dB BANDWIDTH (802.11b MODE)

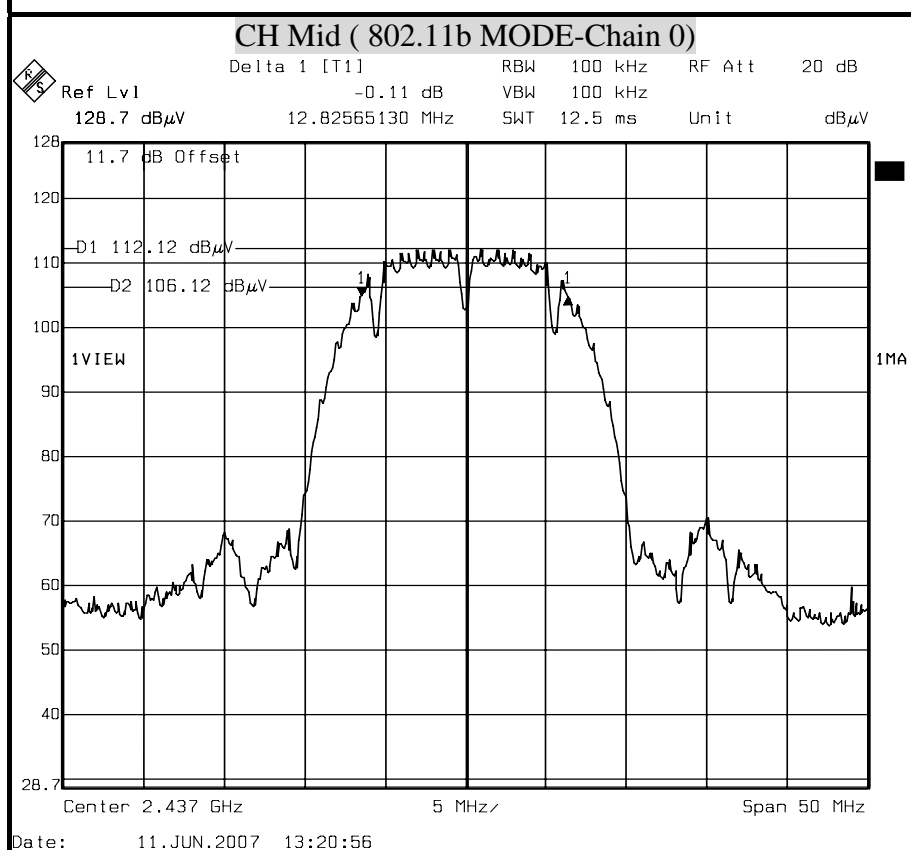
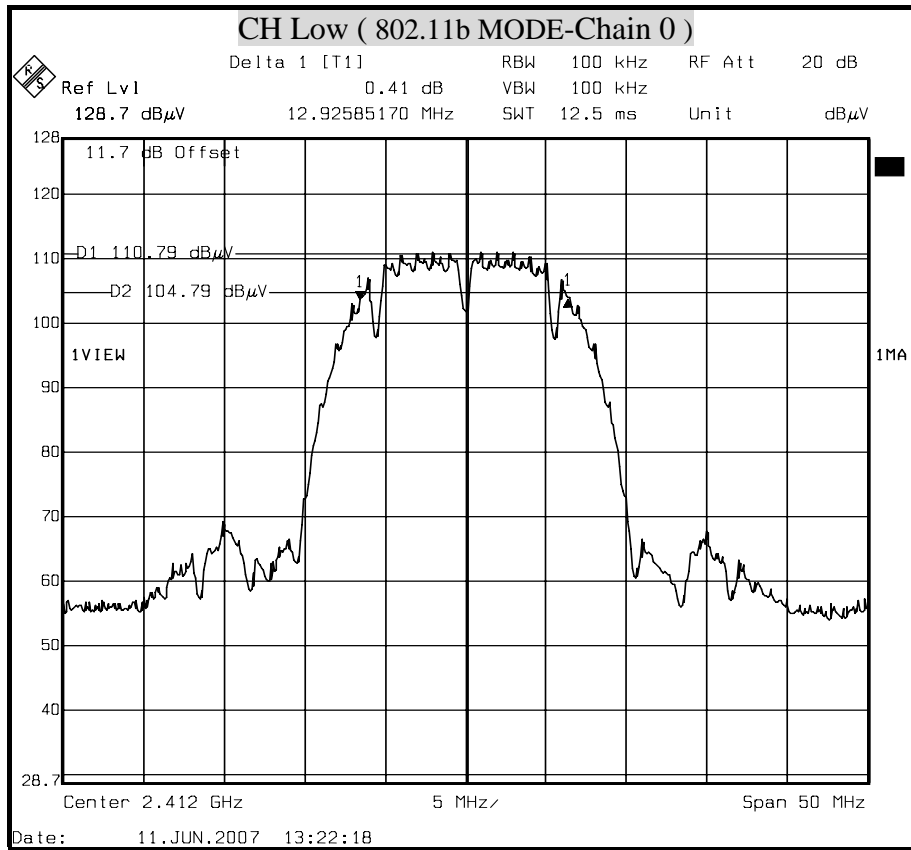

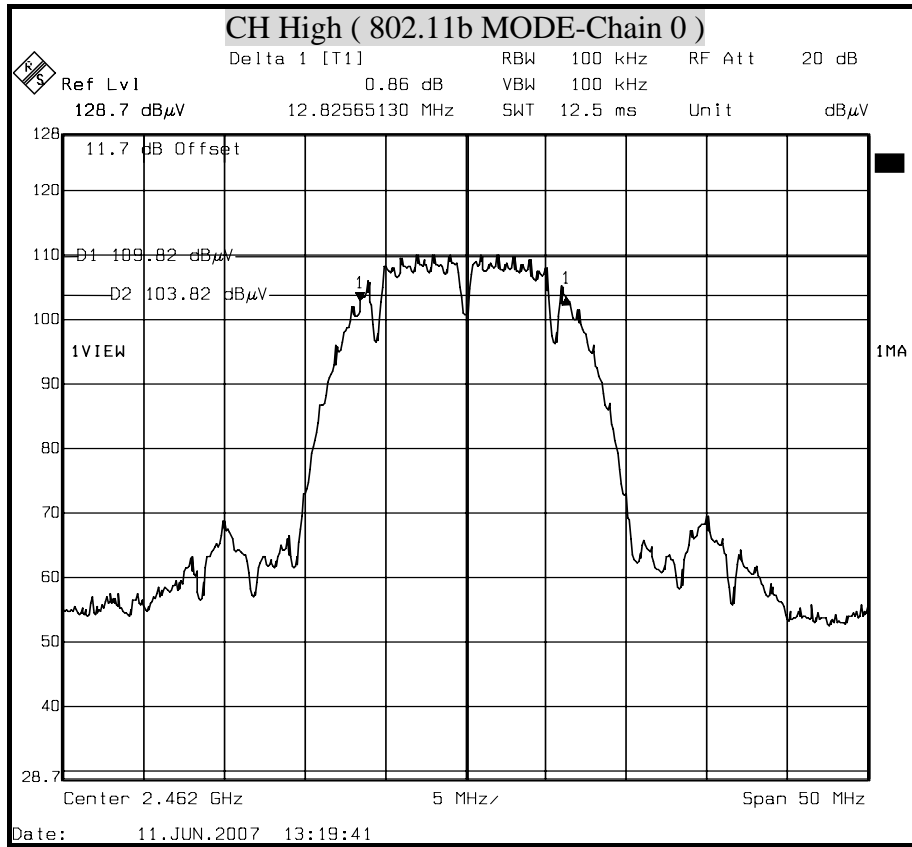

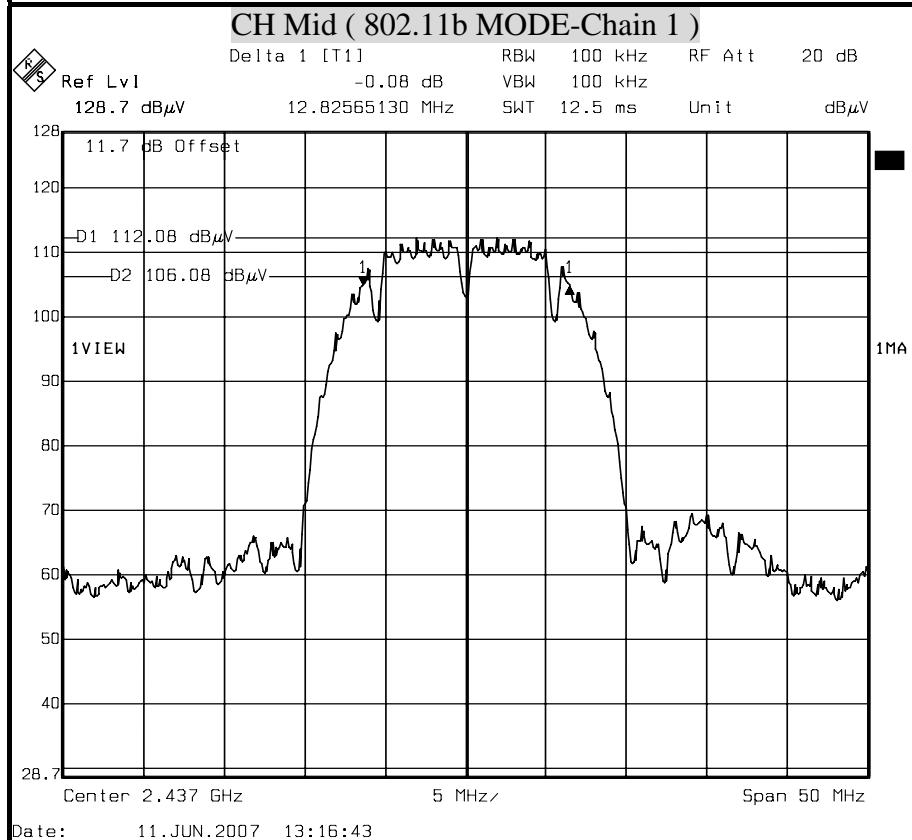
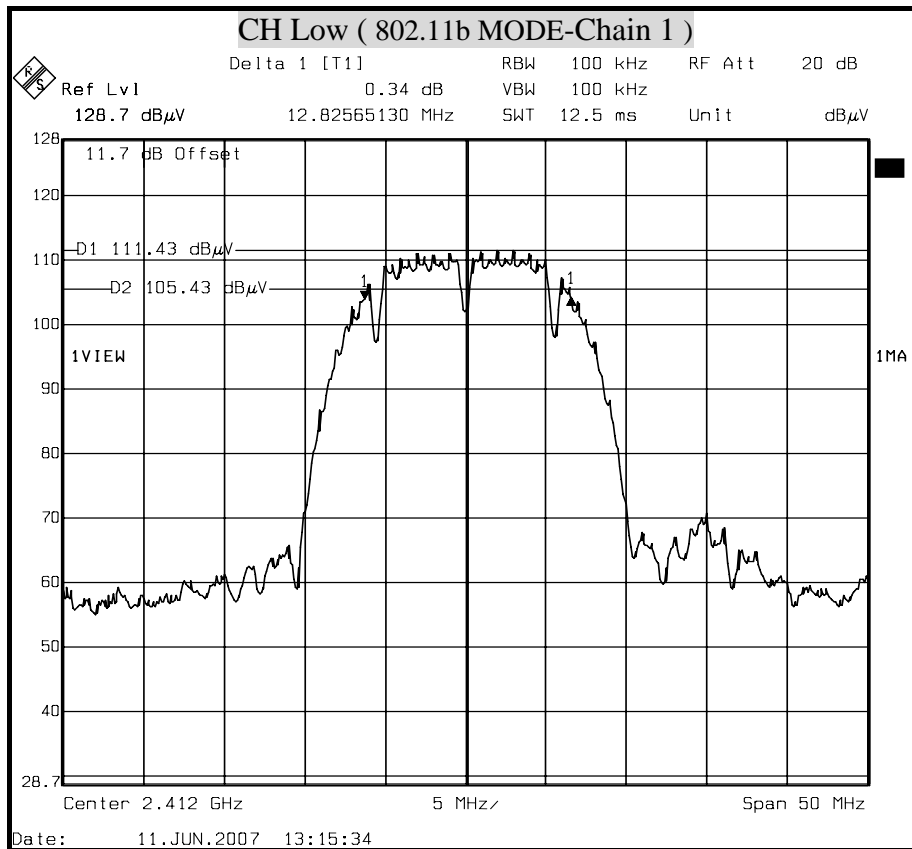

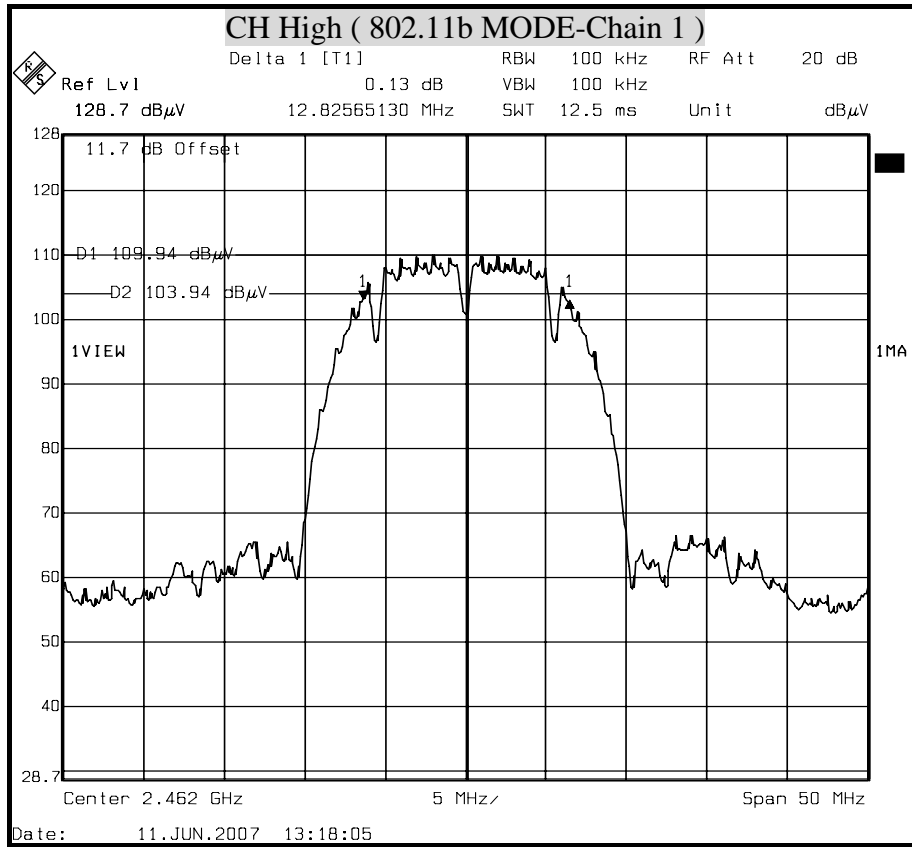



6dB BANDWIDTH (802.11g MODE)

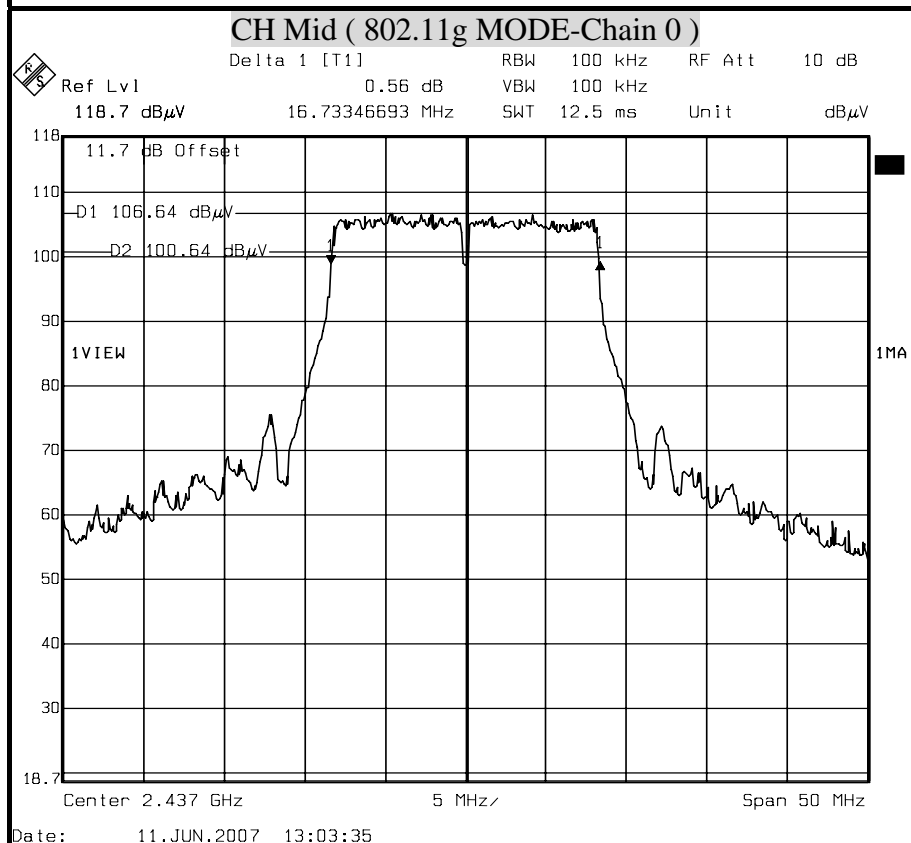
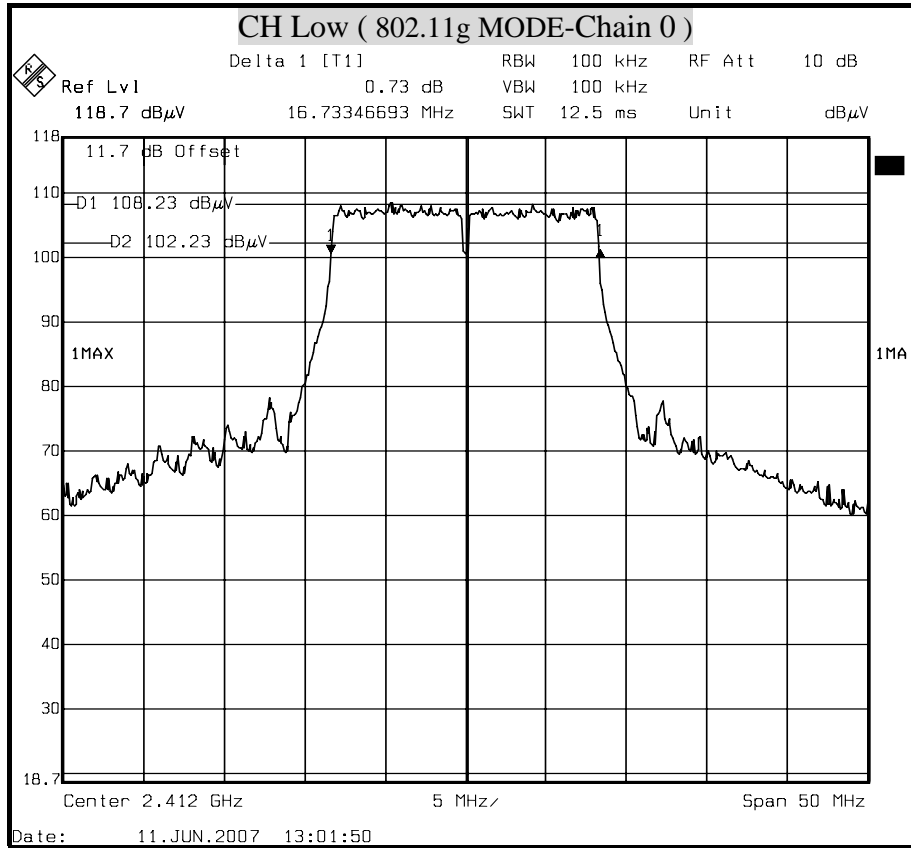

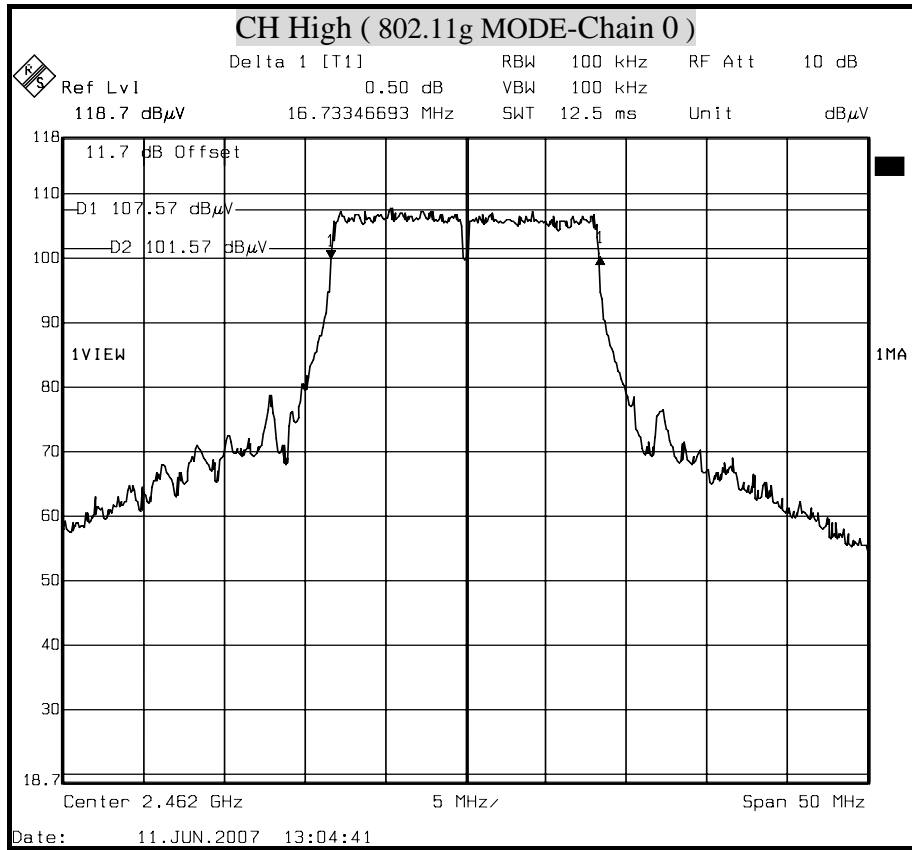

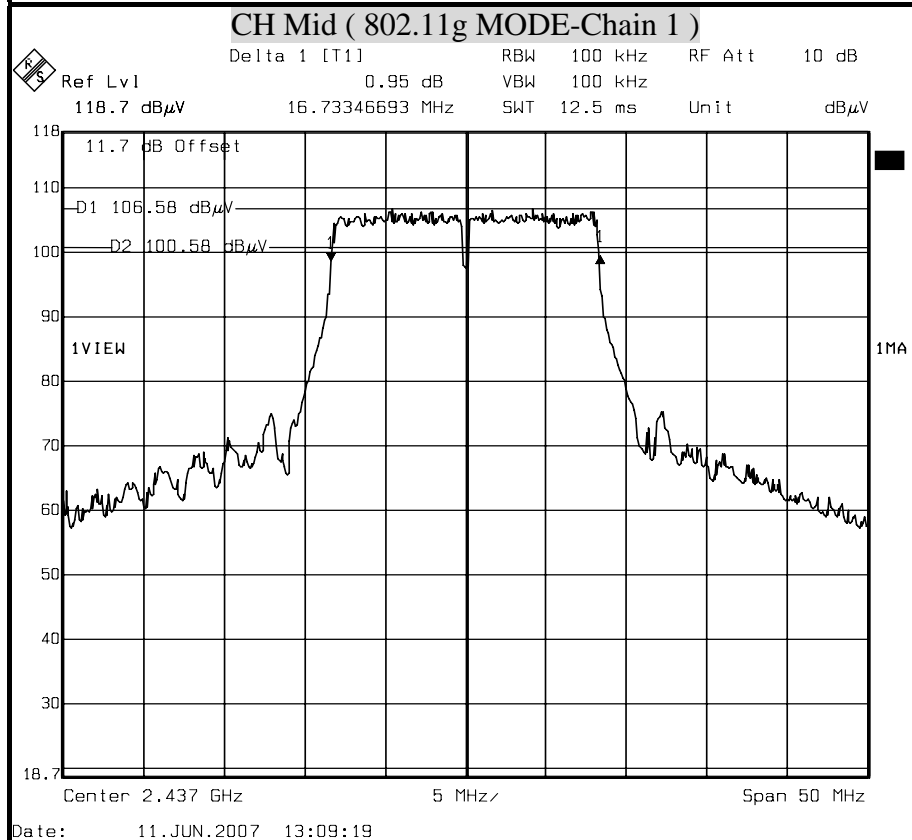
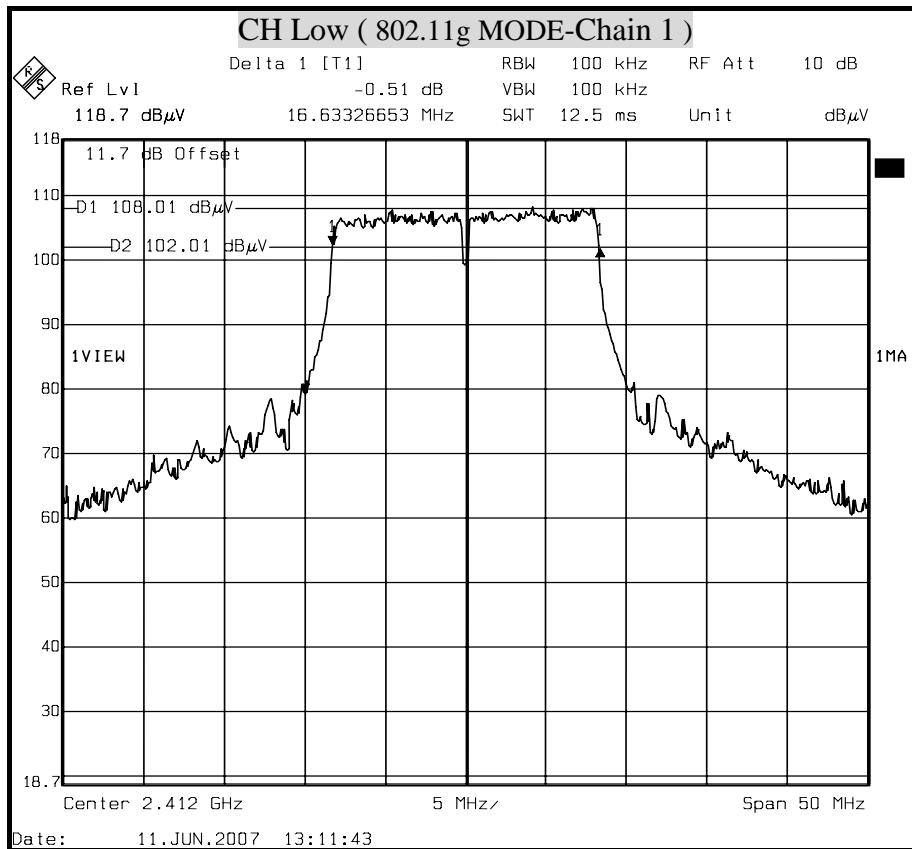

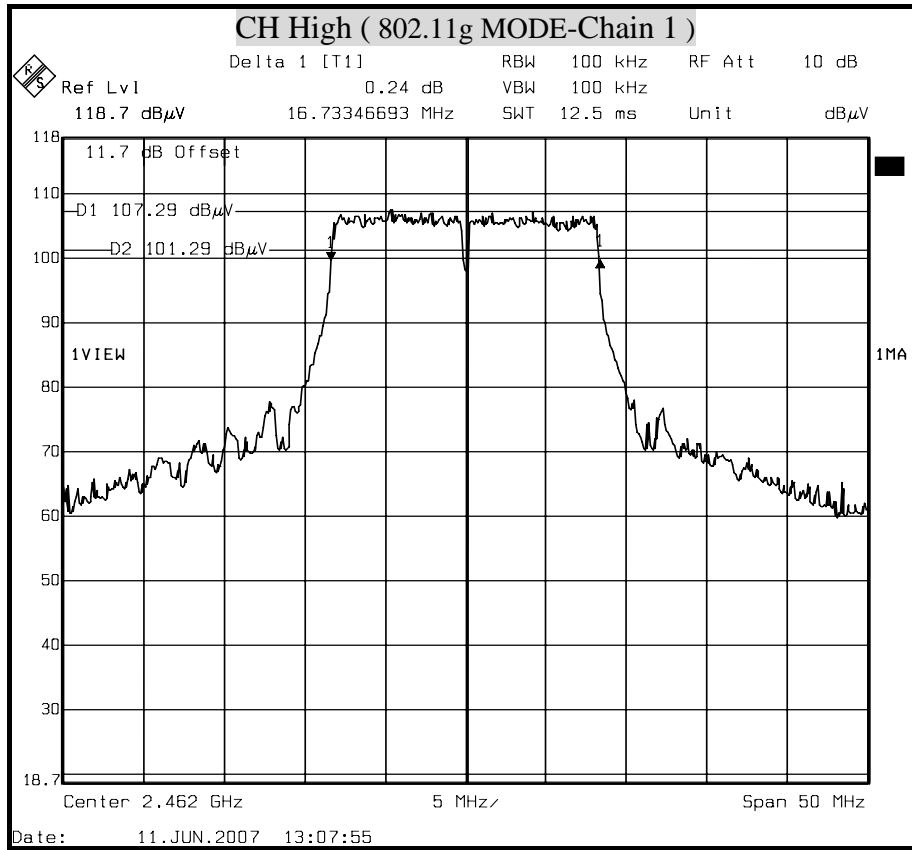



6dB BANDWIDTH (802.11n HT20 MODE)

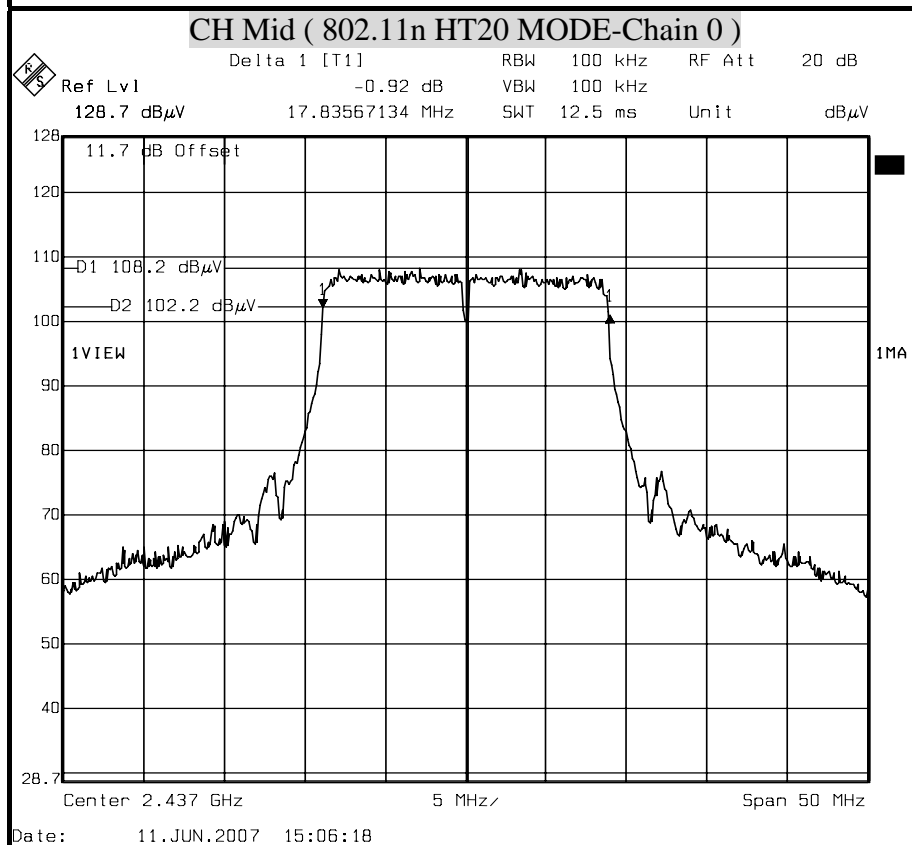
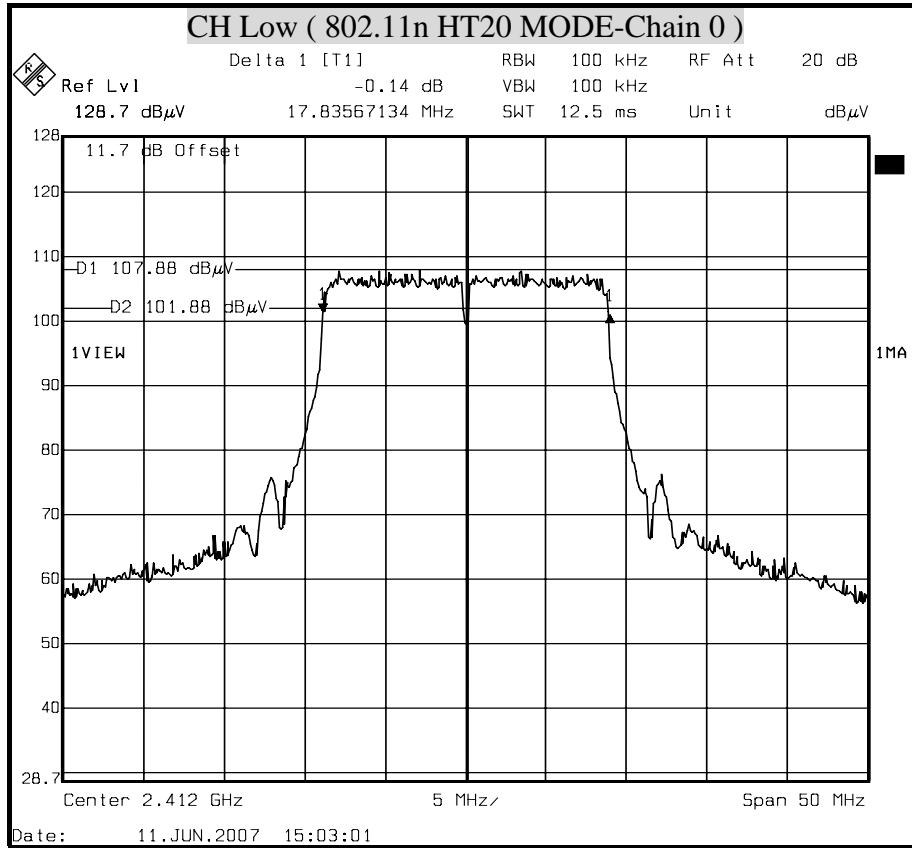

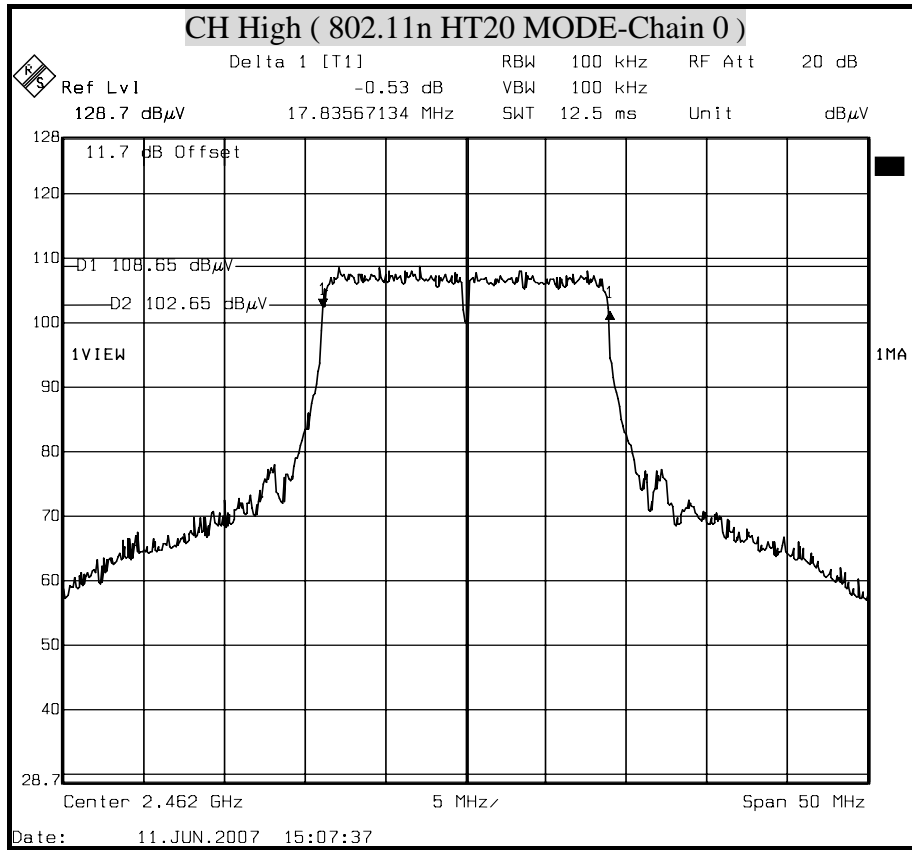

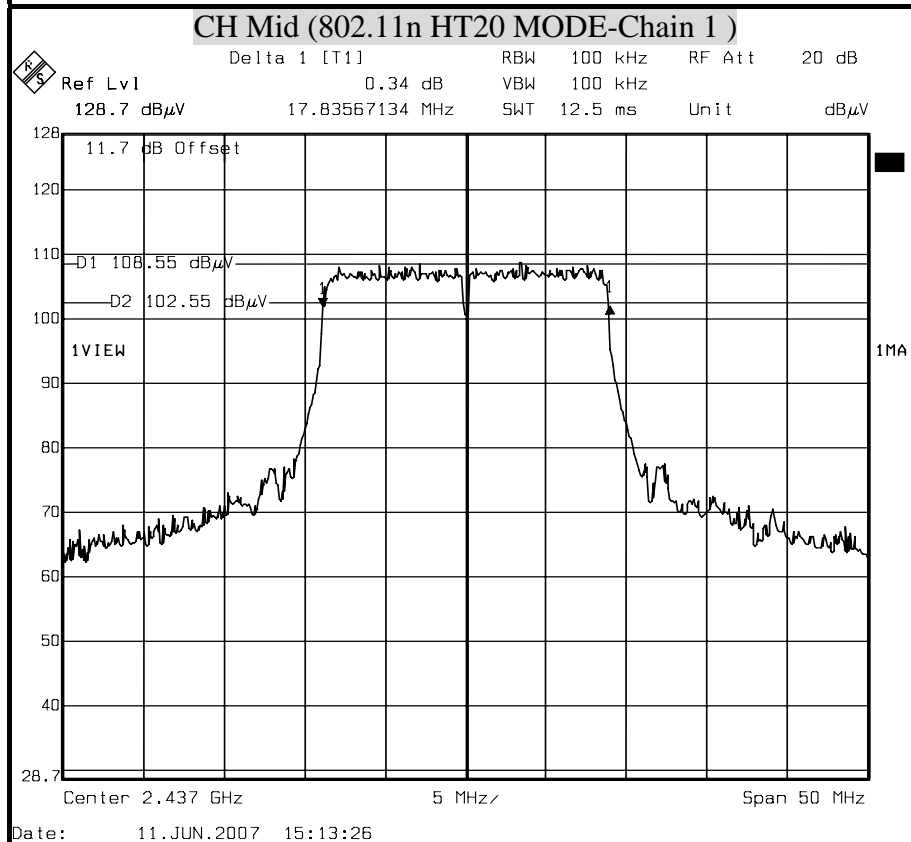
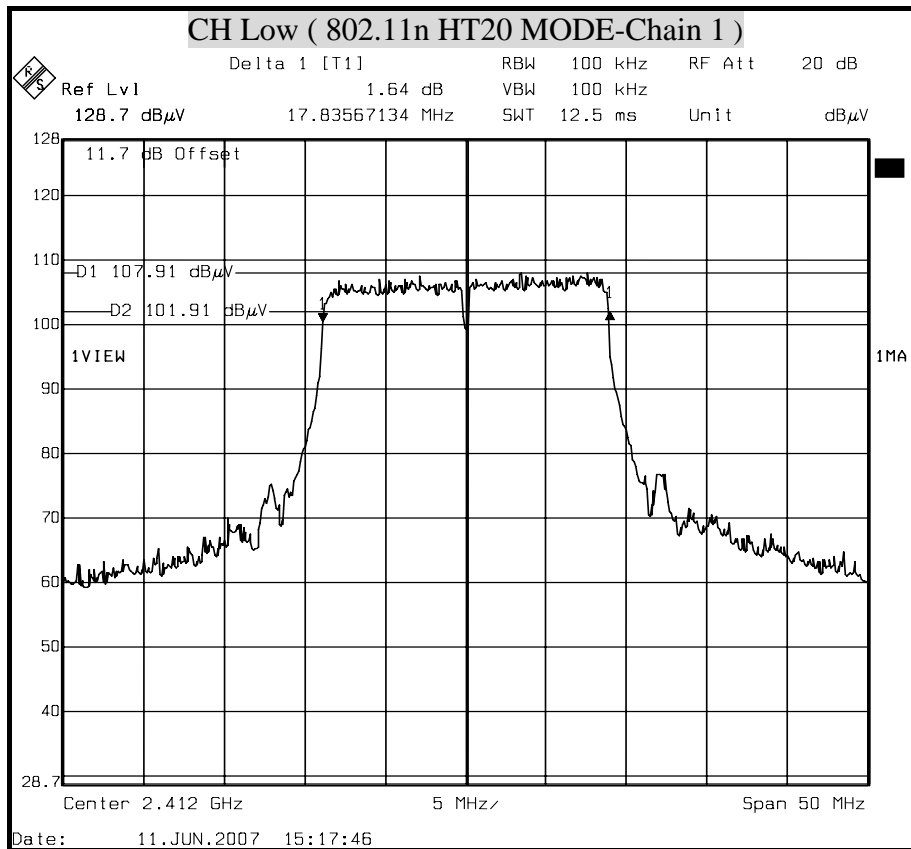

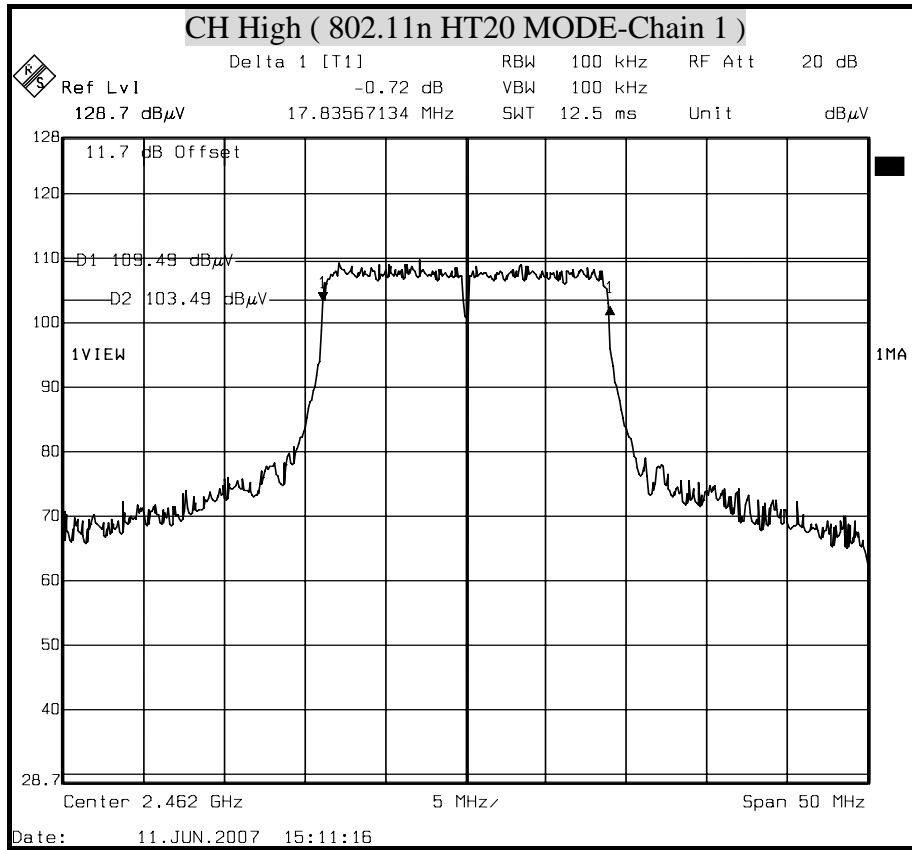



6dB BANDWIDTH (802.11n HT40 MODE)

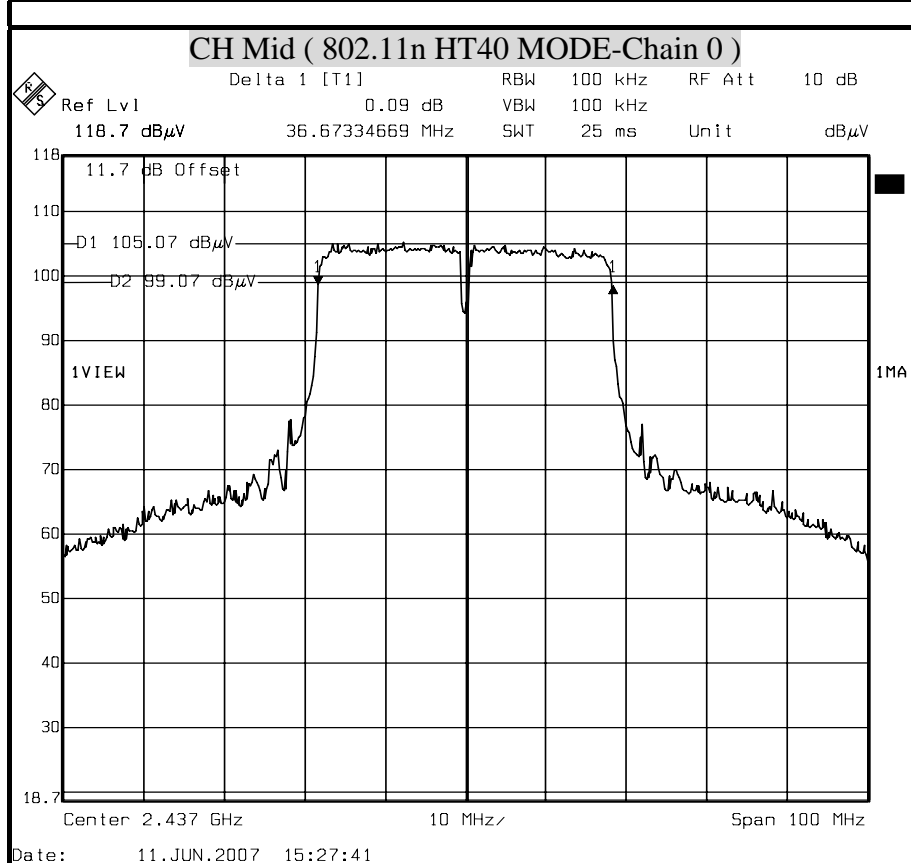
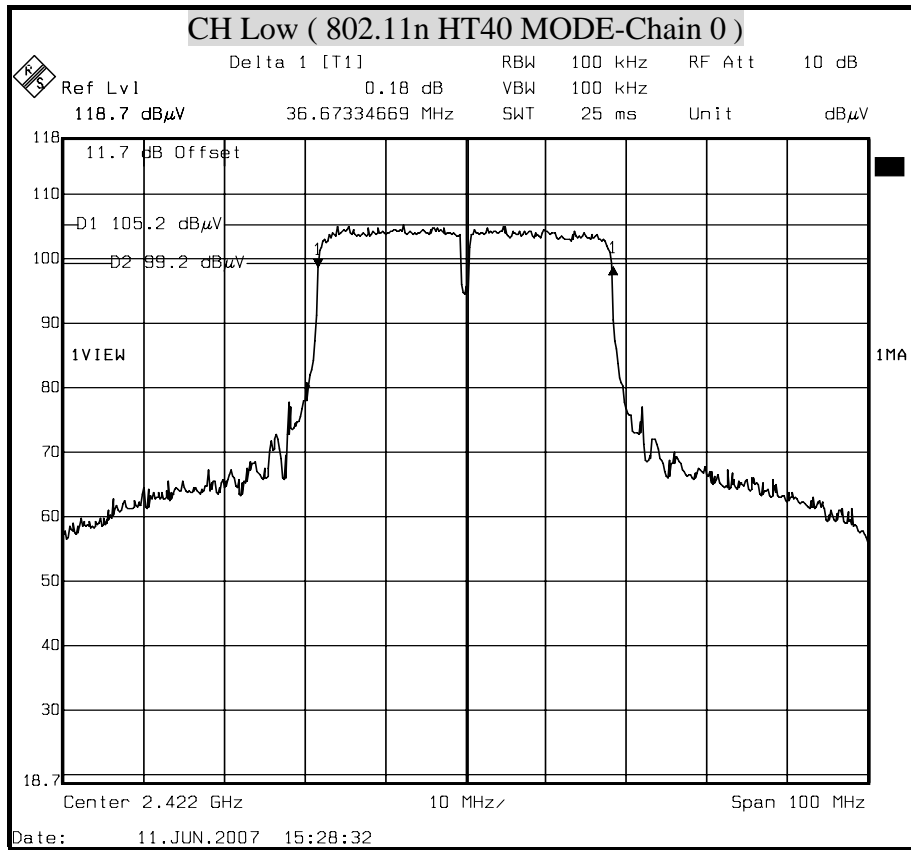

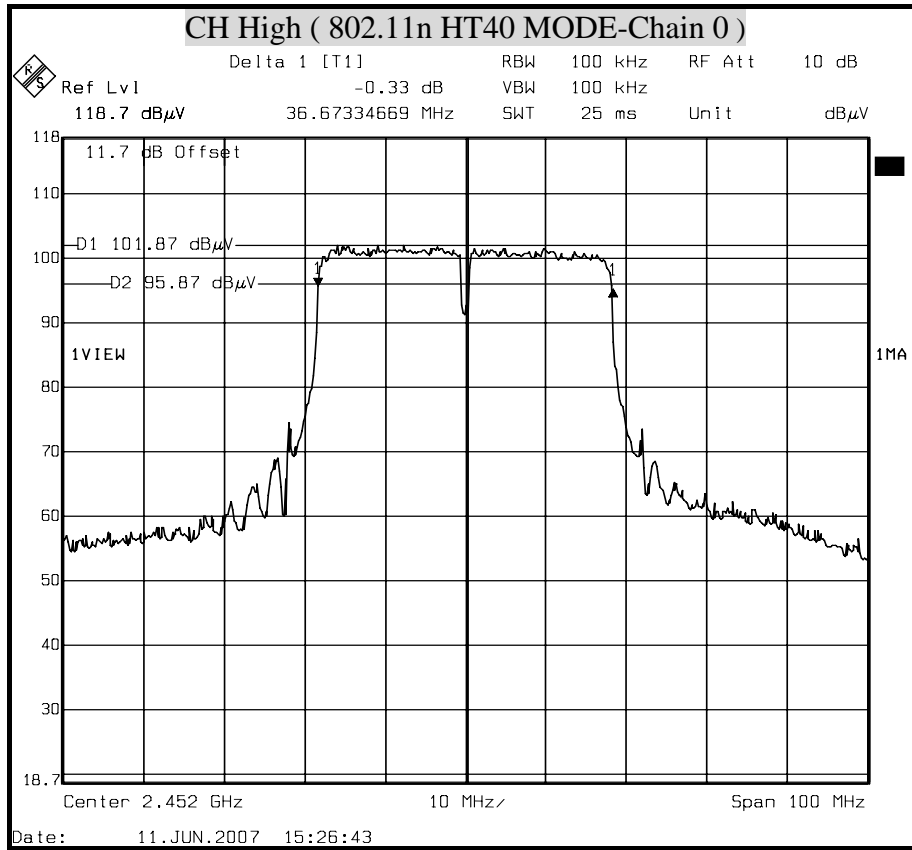

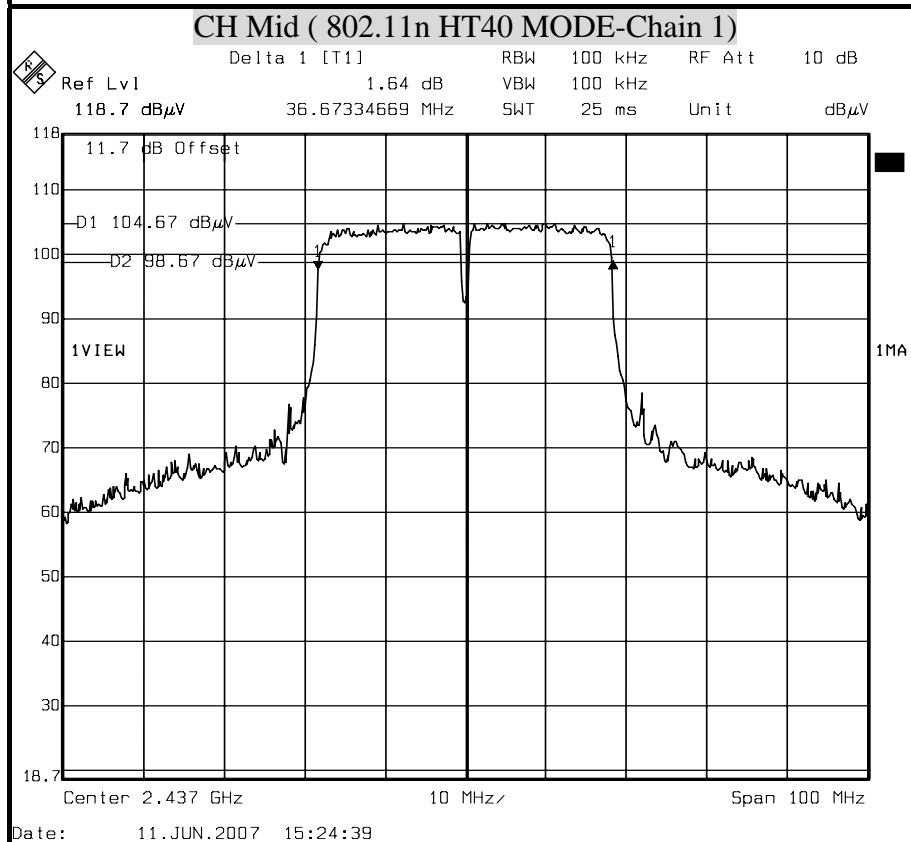
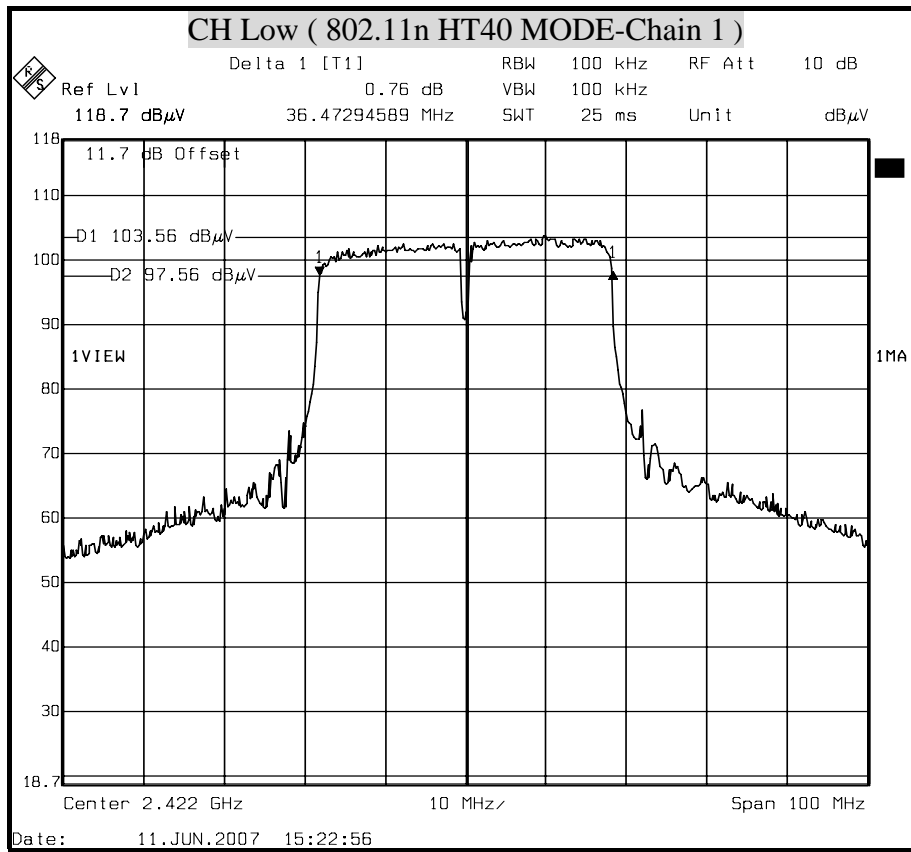

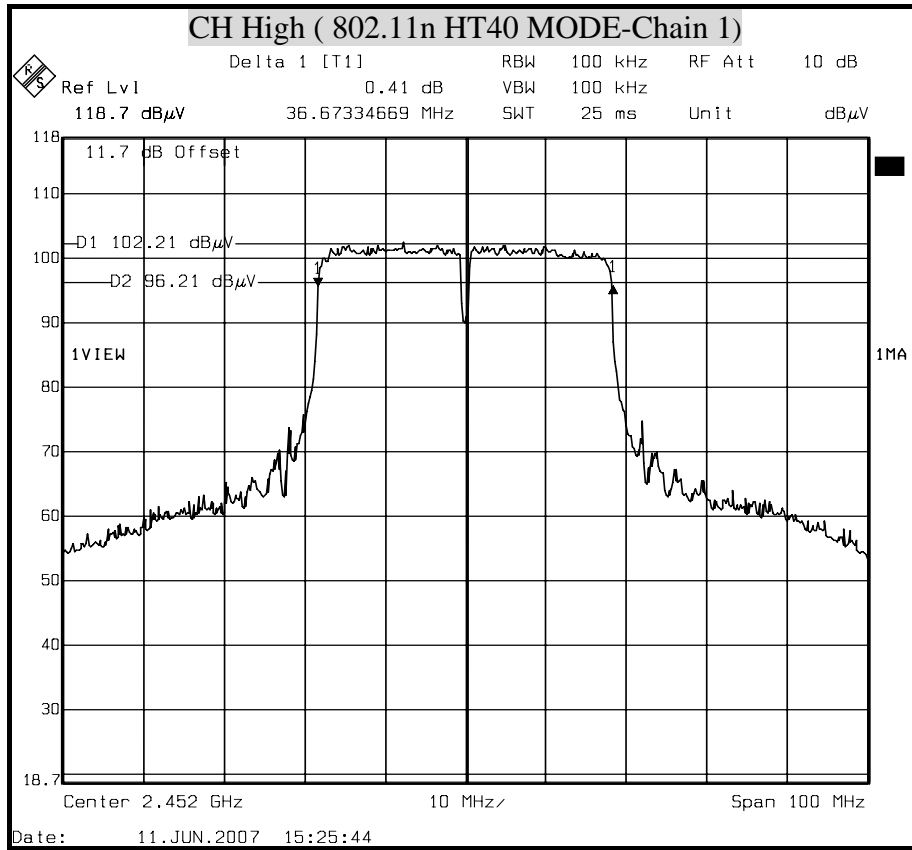



8.2 99% BANDWIDTH

LIMIT

None; for reporting purposes only.

TEST EQUIPMENTS

Name of Equipment	Manufacturer	Model	Serial Number	Calibration Due
Spectrum Analyzer	R&S	FSEM	829054/017	MAR. 13, 2008

TEST SETUP



TEST PROCEDURE

1. The spectrum shall be set as follows :

Span : The minimum span to fully display the emission and approximately 20dB below peak level.

RBW : The set to 1% to 3% of the approximate emission width.

2. Compute the combined power of all signal responses contained in the trace by covering all the data points.

3. For 99% occupied BW, place the markers at the frequency at which 0.5% of the power lies to the right of the right marker and 0.5% of the power lies to the left of the left marker.

4. The 99% BW is the bandwidth between the right and left markers.

**TEST RESULTS**

No non-compliance noted

IEEE 802.11b mode (Two TX)

Channel	Channel Frequency (MHz)	99% Occupied power bandwidth (MHz)	
		Chain 0	Chain 1
Low	2412	14.929	14.929
Middle	2437	14.929	15.030
High	2462	15.130	14.929

IEEE 802.11g mode (Two TX)

Channel	Channel Frequency (MHz)	99% Occupied power bandwidth (MHz)	
		Chain 0	Chain 1
Low	2412	17.234	17.134
Middle	2437	17.034	17.134
High	2462	17.234	17.134

IEEE 802.11n HT20 mode (Two TX)

Channel	Channel Frequency (MHz)	99% Occupied power bandwidth (MHz)	
		Chain 0	Chain 1
Low	2412	17.735	17.735
Middle	2437	17.735	17.735
High	2462	17.735	17.735

IEEE 802.11n HT40 mode (Two TX)

Channel	Channel Frequency (MHz)	99% Occupied power bandwidth (MHz)	
		Chain 0	Chain 1
Low	2422	36.272	35.871
Middle	2437	36.072	36.072
High	2452	36.072	36.072



99% BANDWIDTH (802.11b MODE)

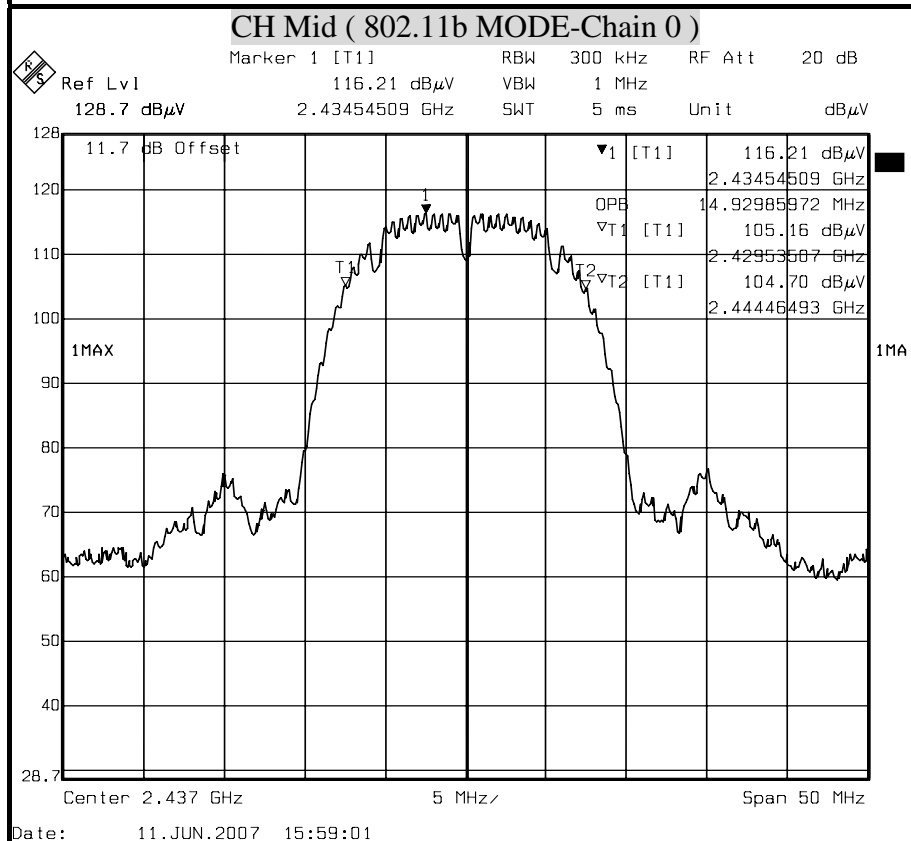
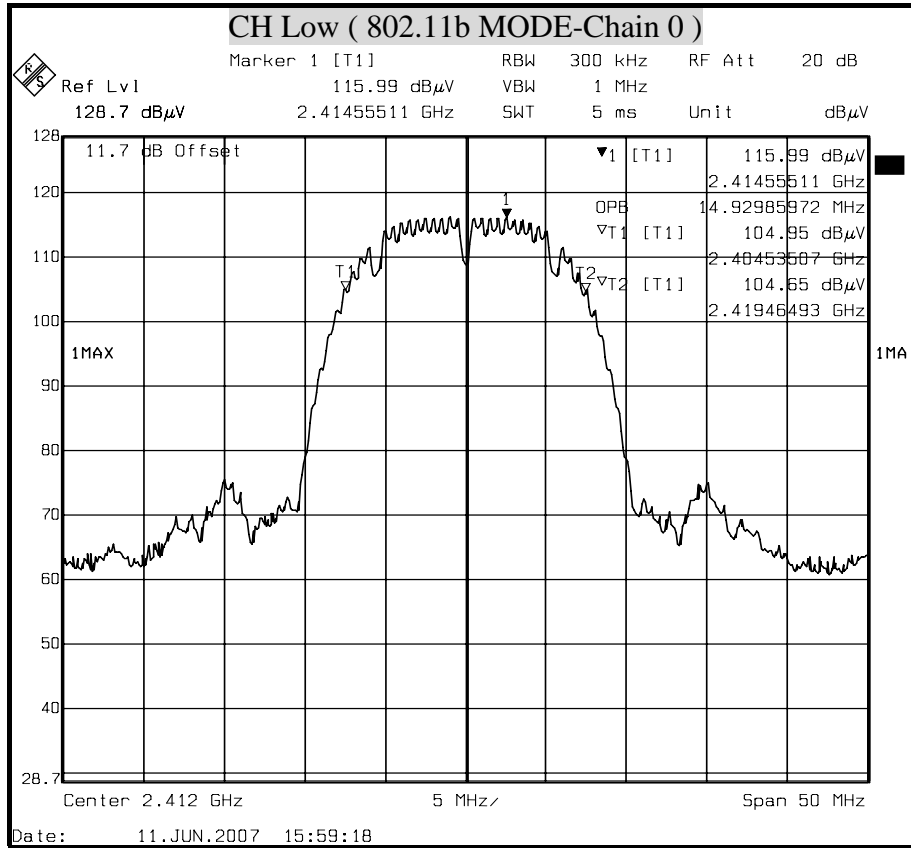

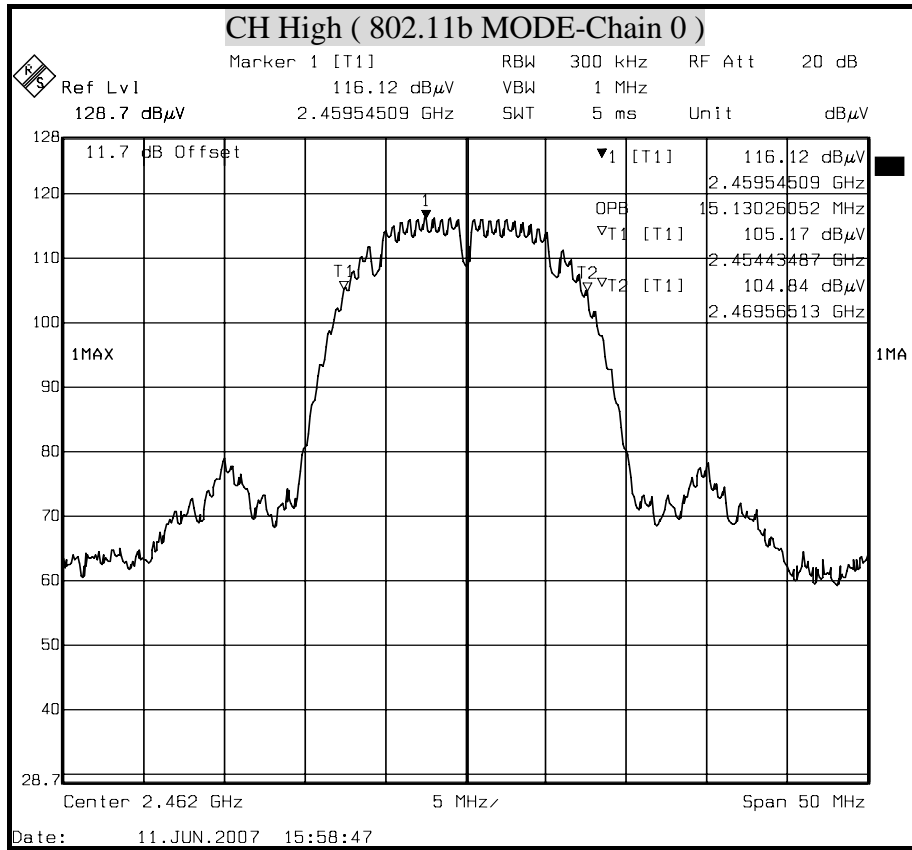

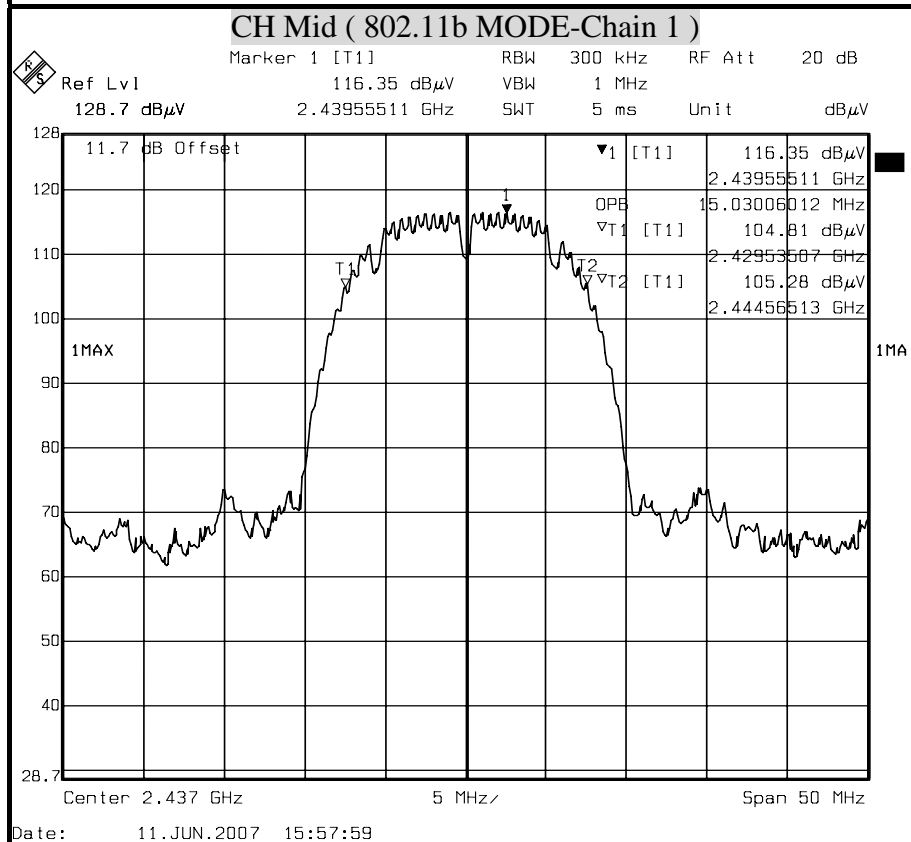
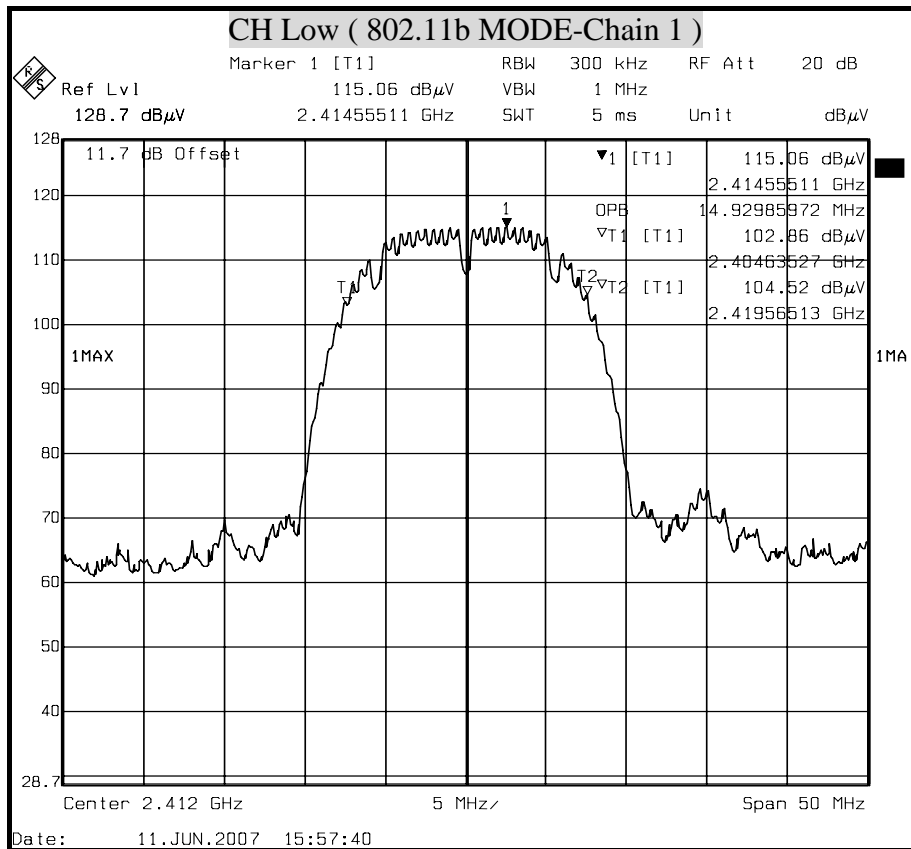

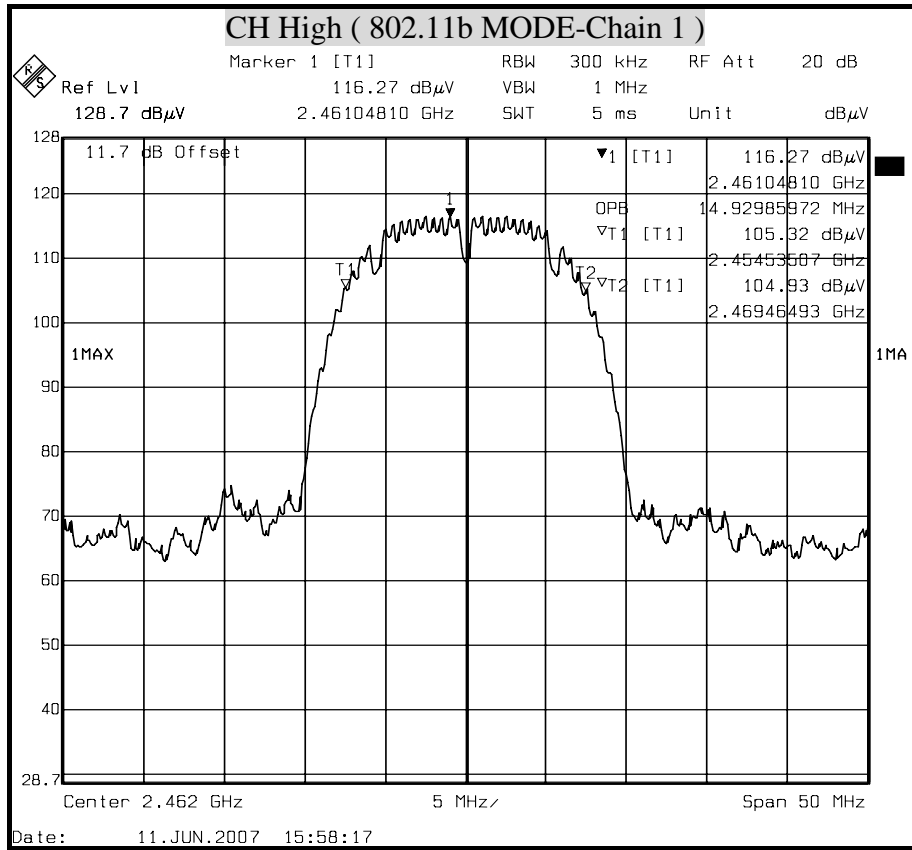



99% BANDWIDTH (802.11g MODE)

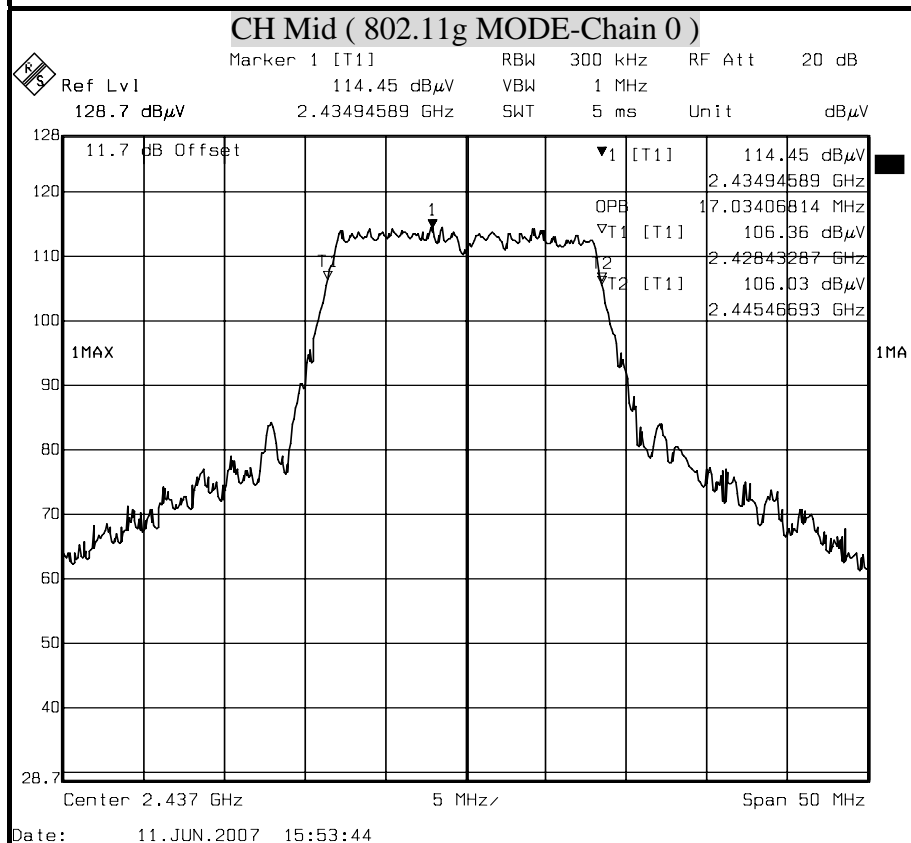
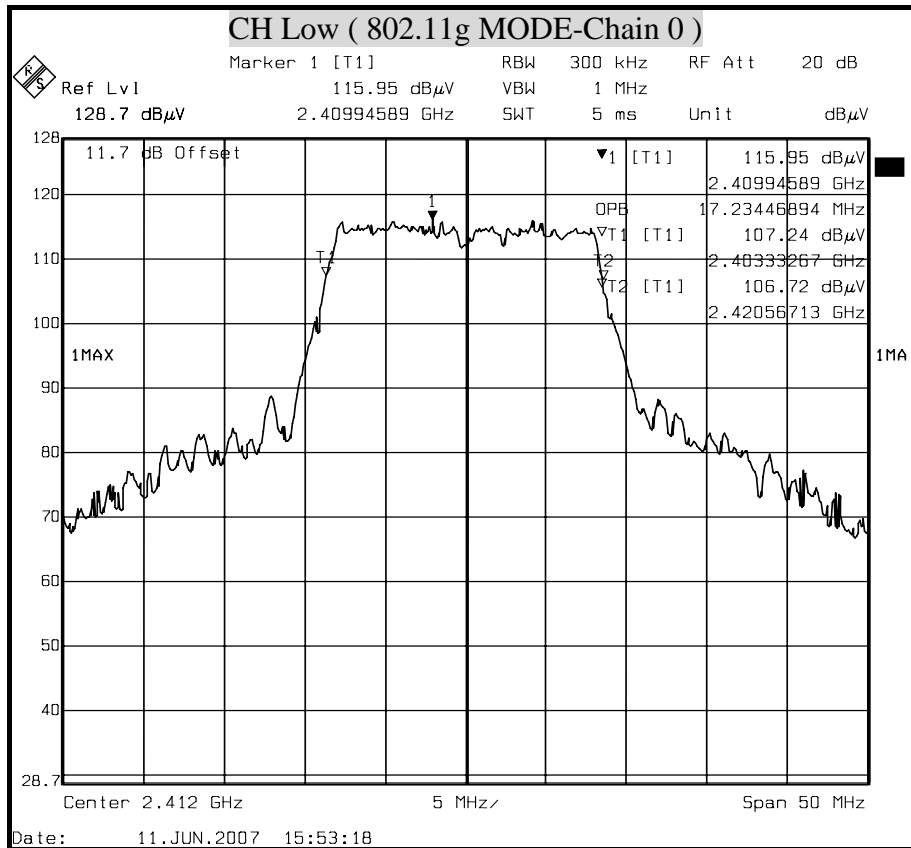

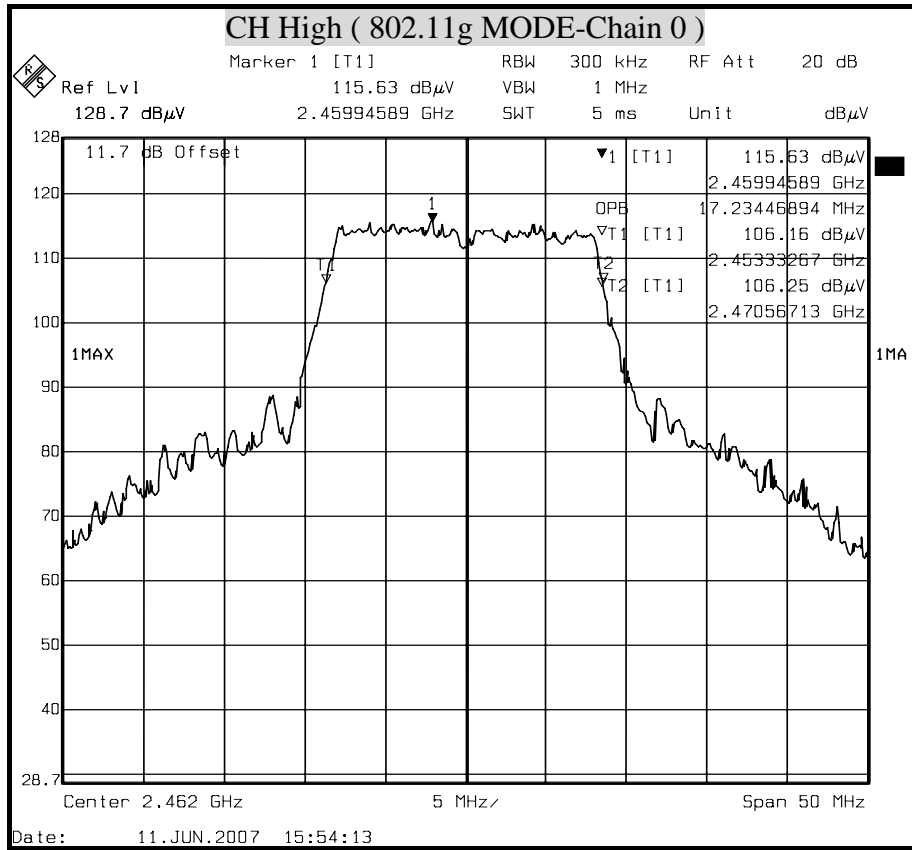

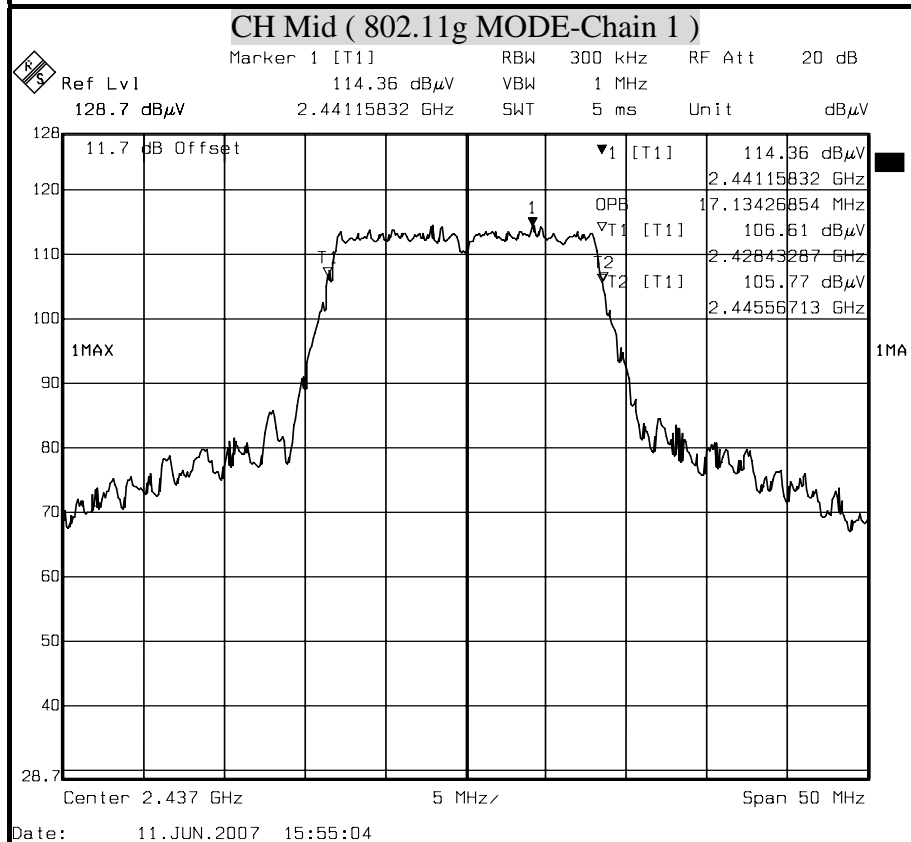
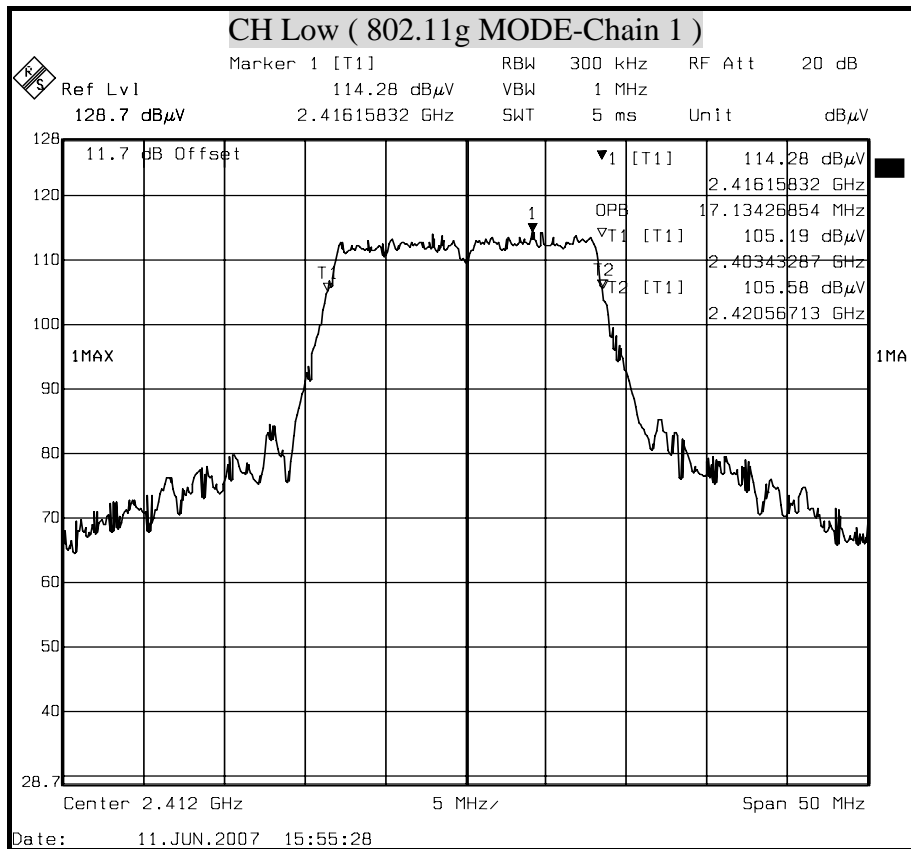

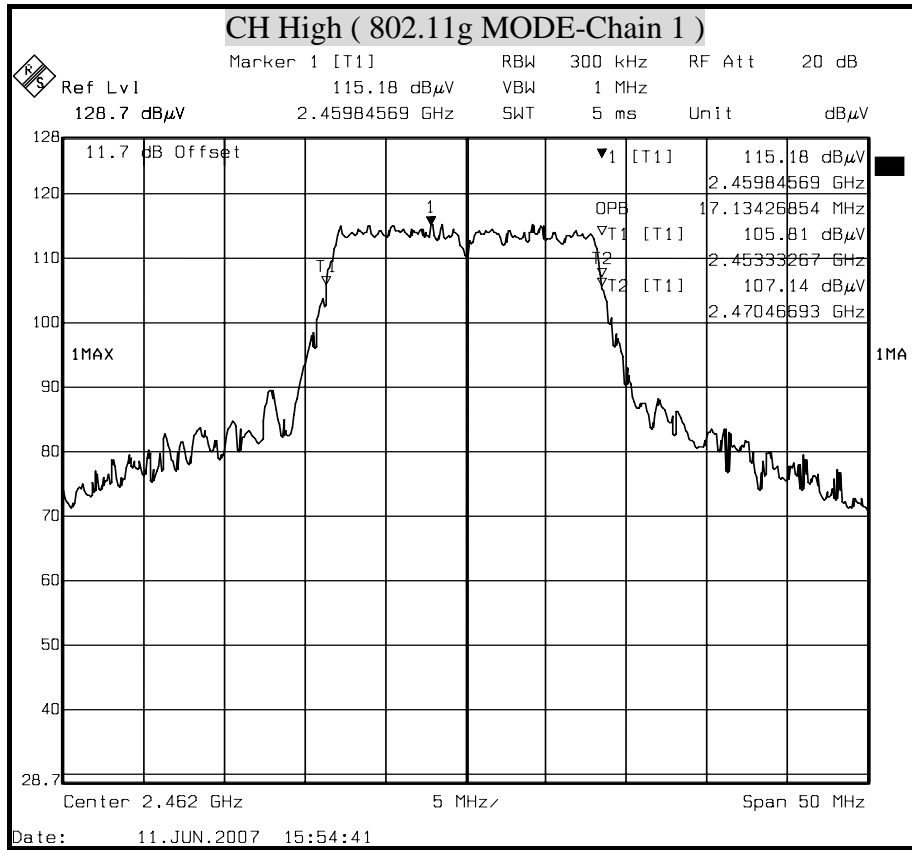



99% BANDWIDTH (802.11n HT20 MODE)

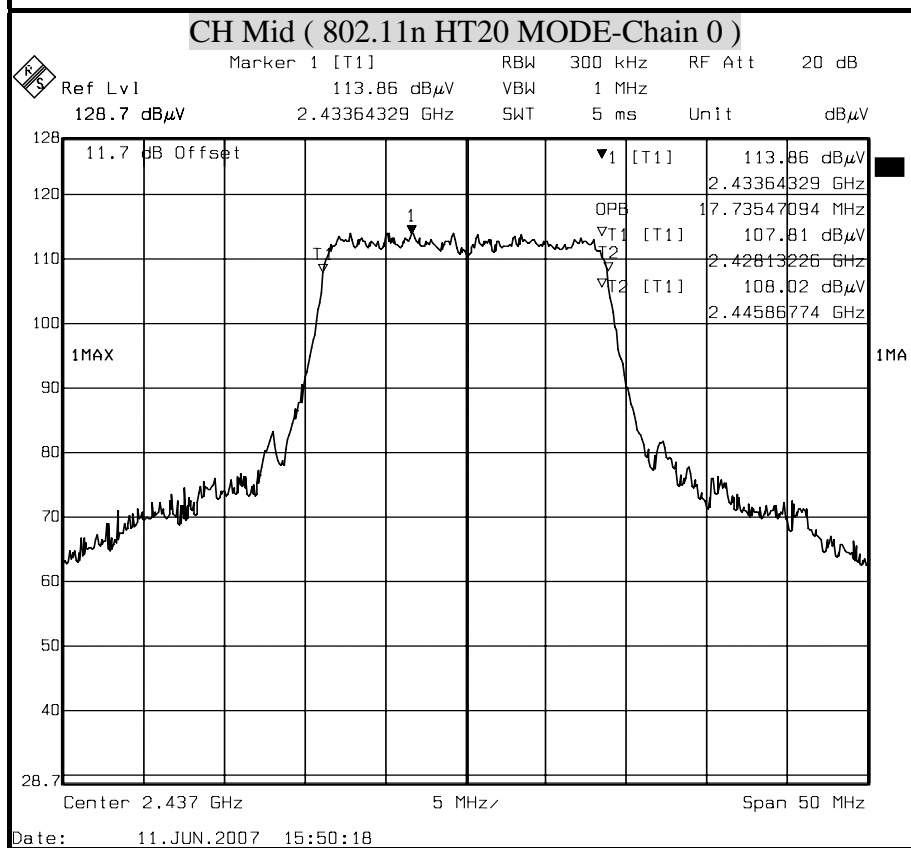
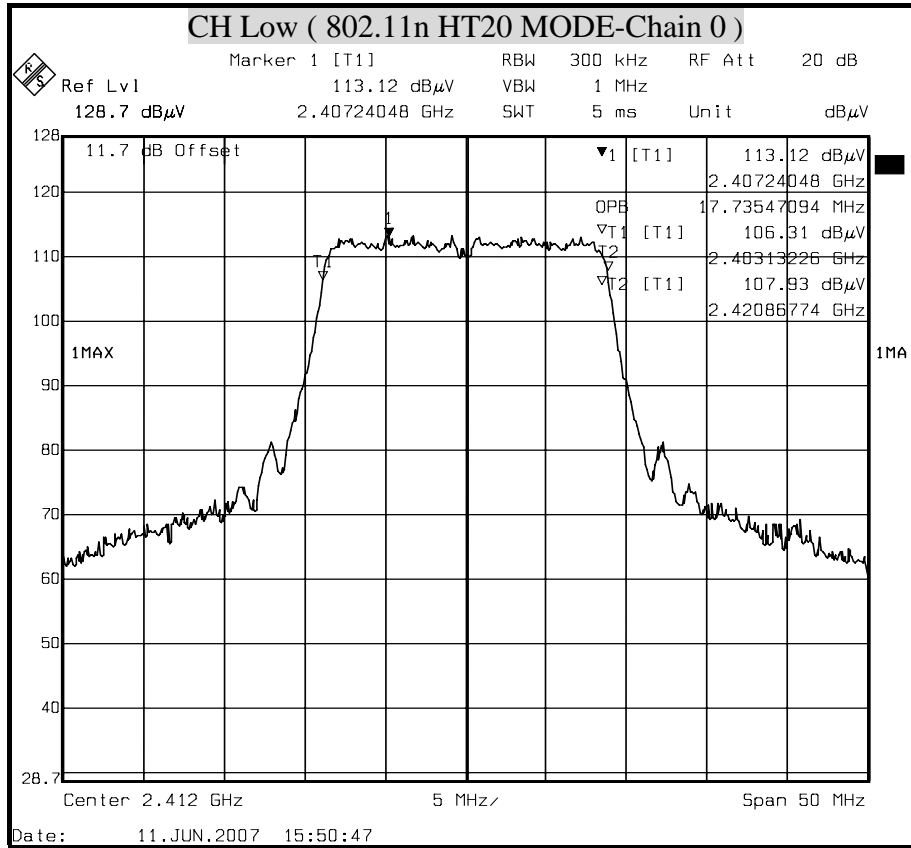

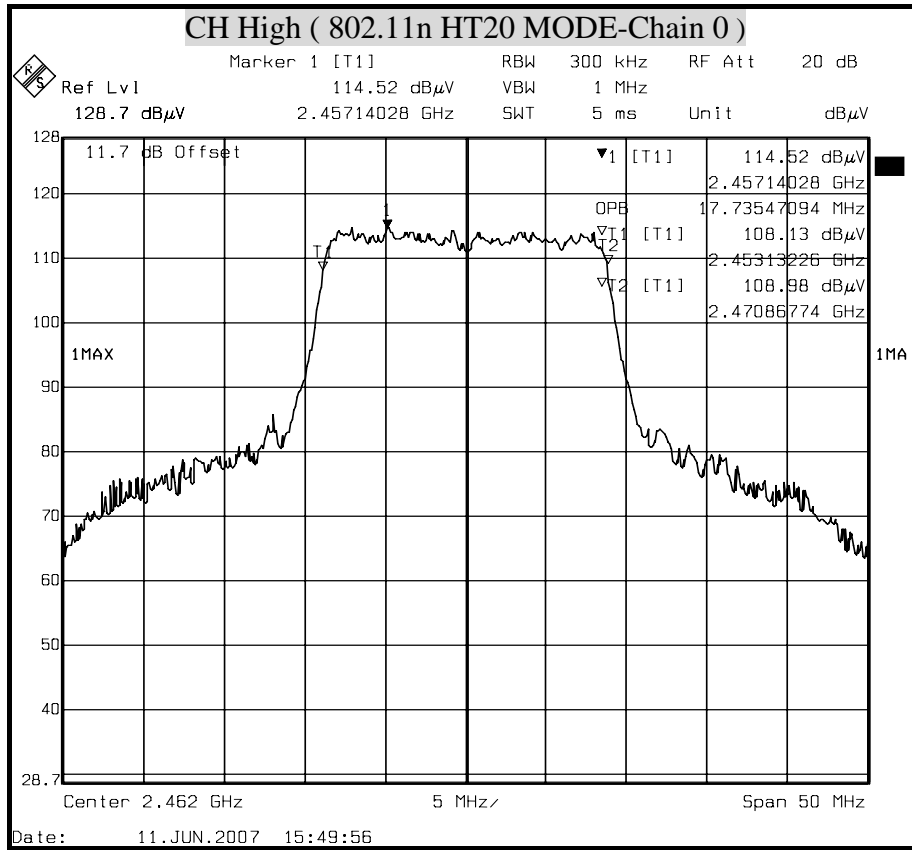

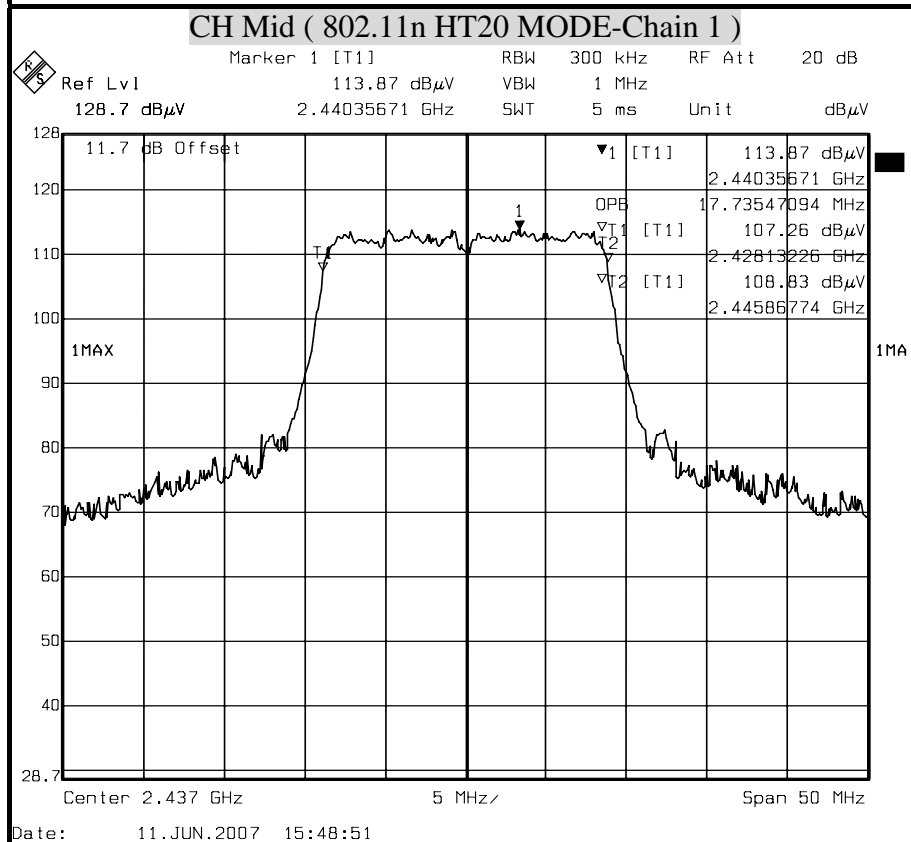
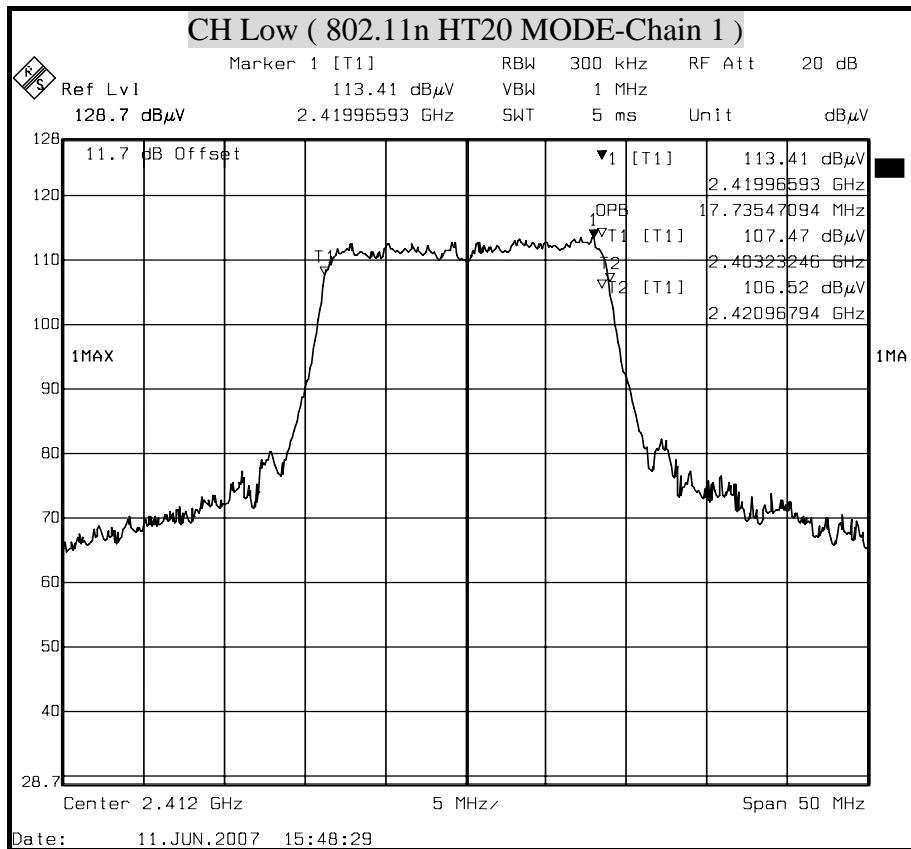

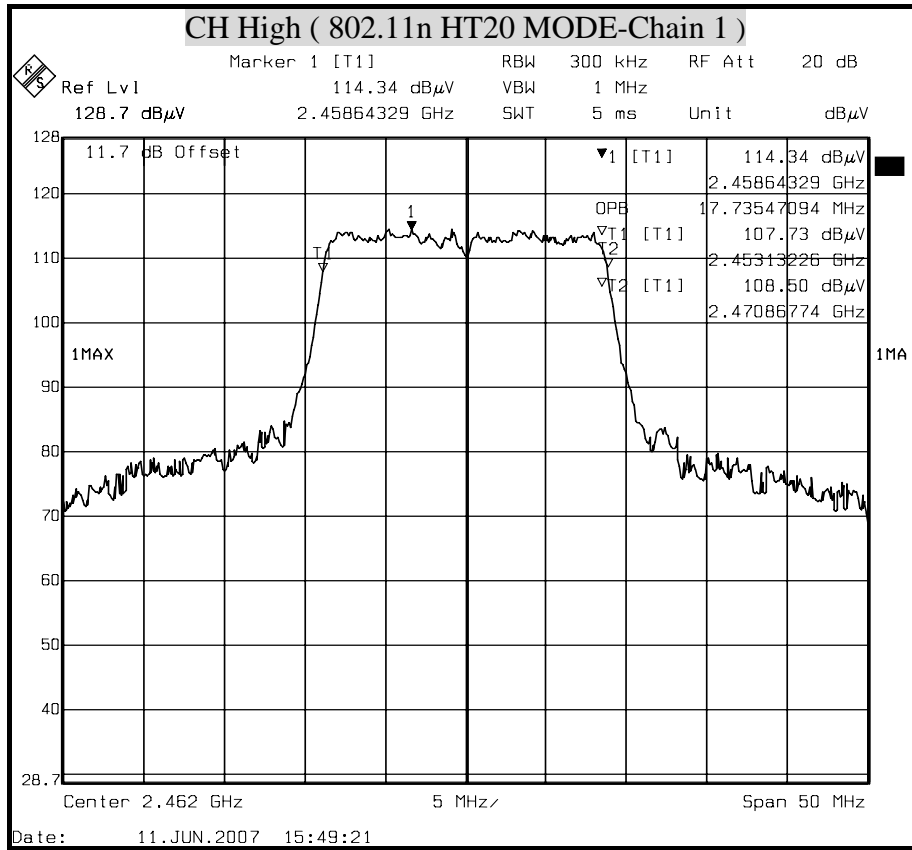



99% BANDWIDTH (802.11n HT40 MODE)

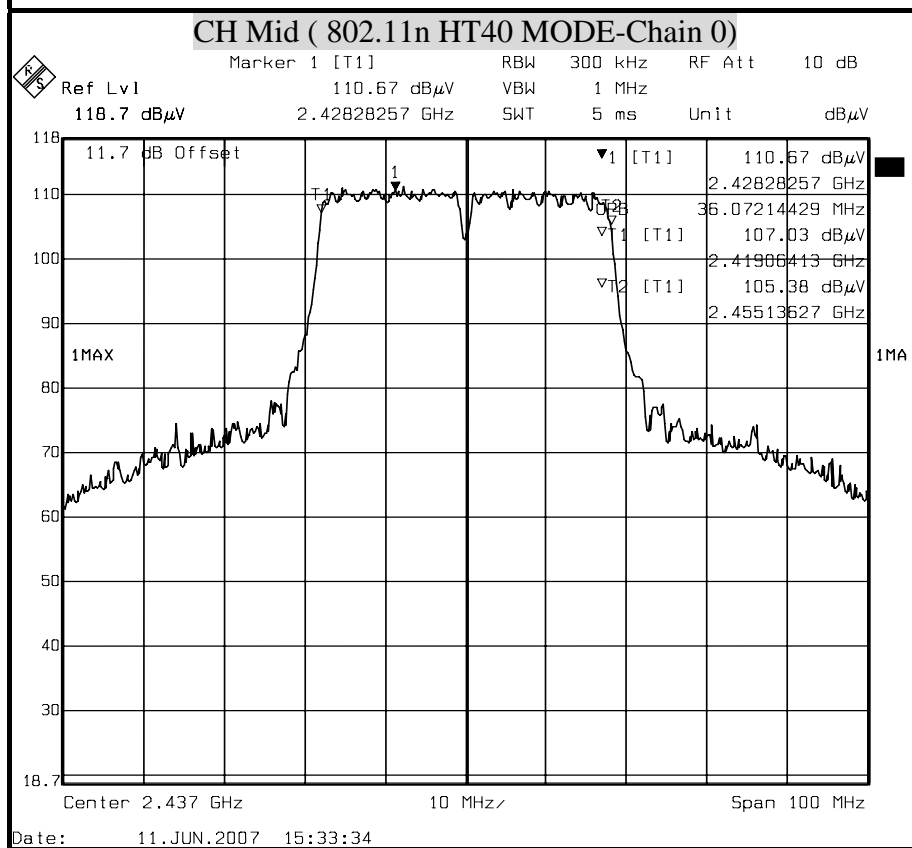
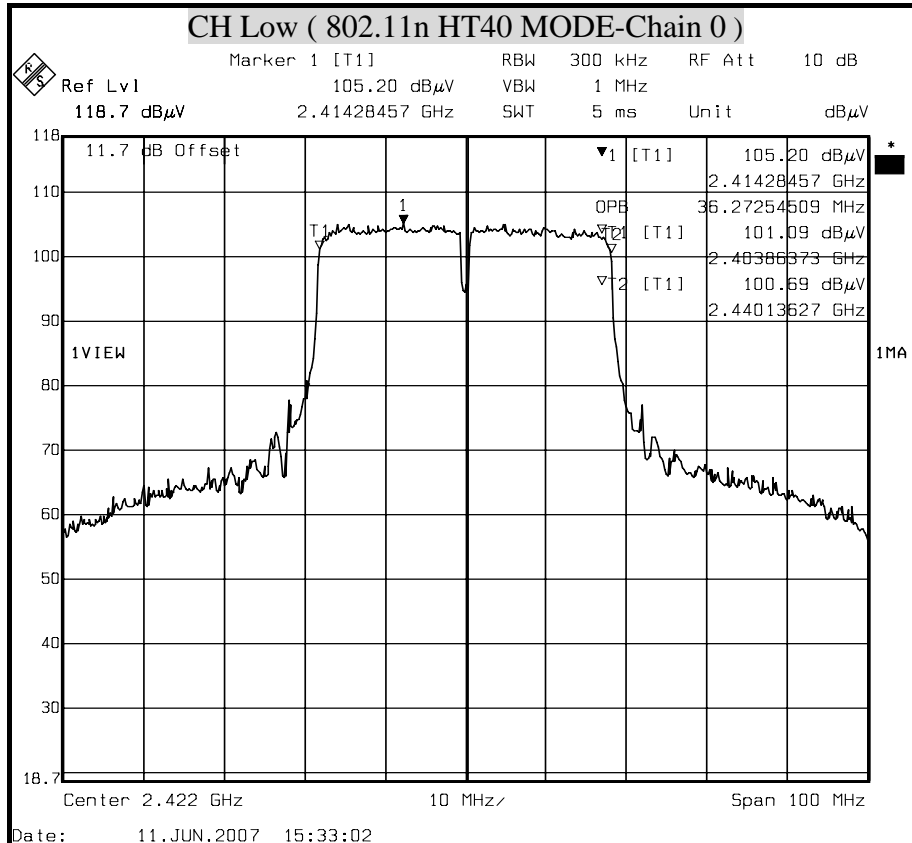

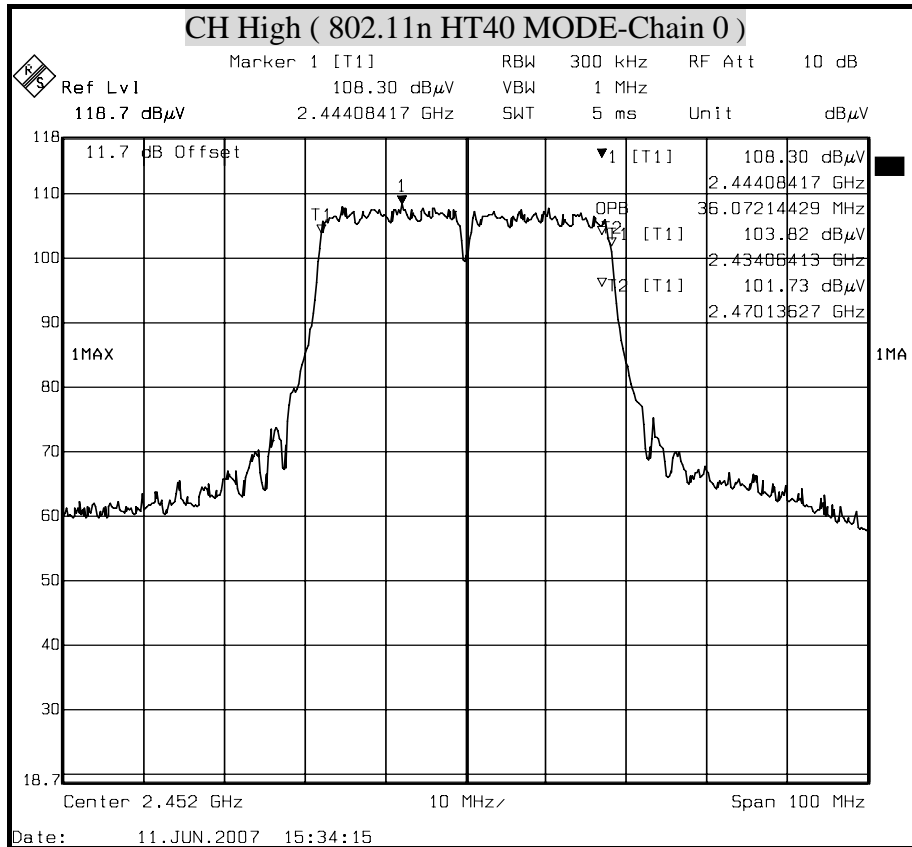

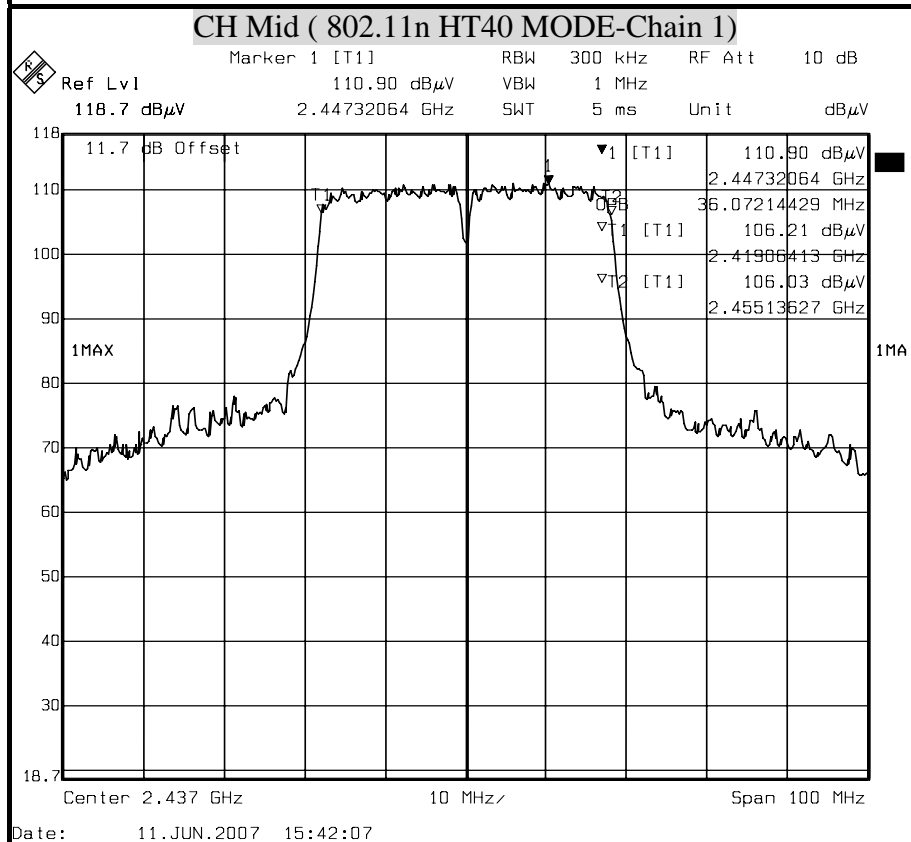
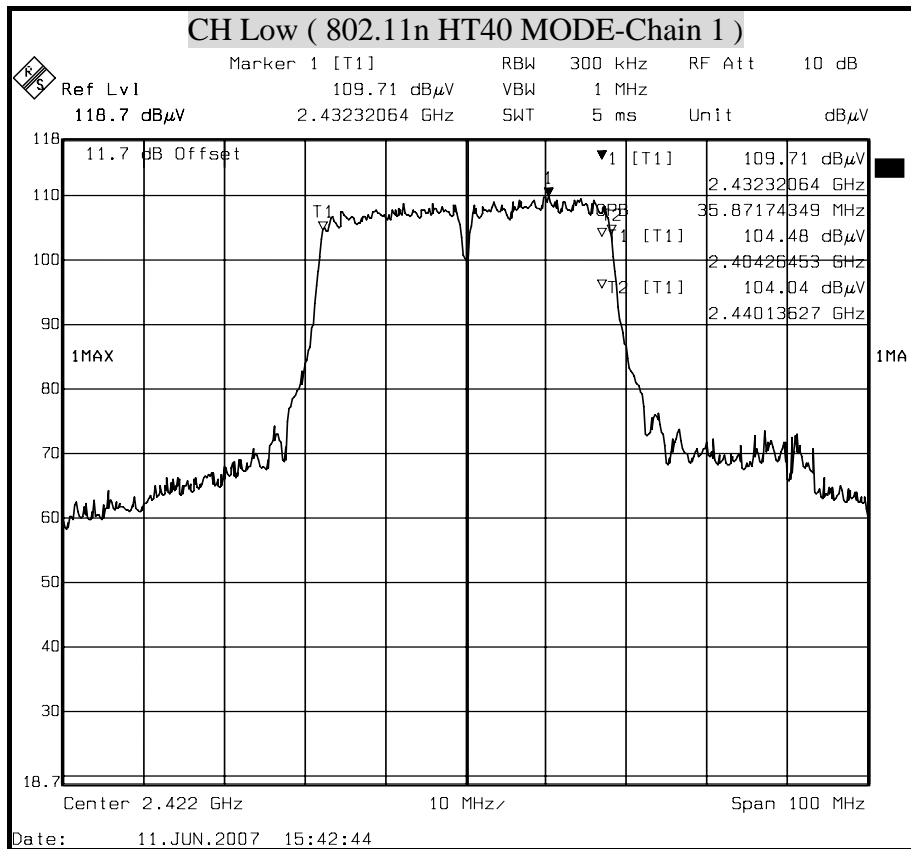

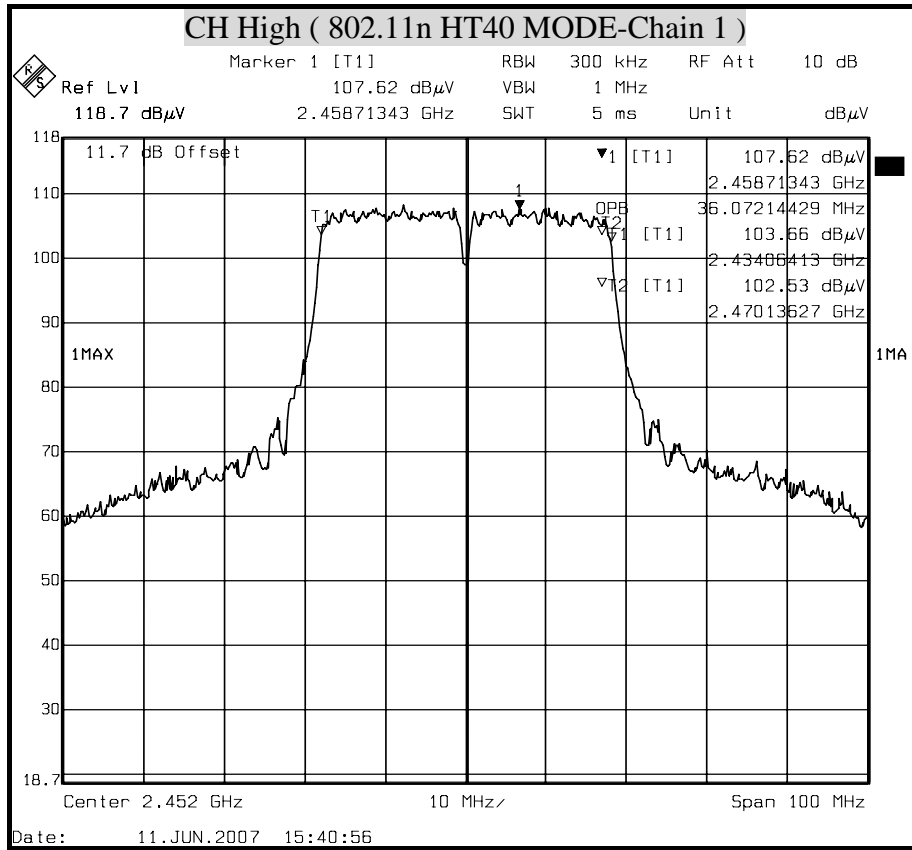



8.3 MAXIMUM PEAK OUTPUT POWER

LIMIT

§ 15.247(b) The maximum peak output power of the intentional radiator shall not exceed the following :

§ 15.247(b) (3) For systems using digital modulation in the 902-928 MHz, 2400-2483.5 MHz, and 5725-5850 MHz bands : 1 watt.

§ 15.247(b) (4) Except as shown in paragraphs (c) of this section , if transmitting antennas of directional gain greater than 6 dBi are used the peak output power from the intentional radiator shall be reduced below the stated values in paragraphs (b)(1) or (b)(2), and (b)(3) of this section , as appropriate, by the amount in dB that the directional gain of the antenna exceeds 6 dBi.

TEST EQUIPMENTS

Name of Equipment	Manufacturer	Model	Serial Number	Calibration Due
Spectrum Analyzer	R&S	FSEM	829054/017	MAR. 13, 2008

TEST SETUP

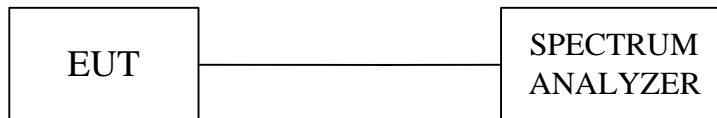

TEST PROCEDURE

- The spectrum shall be set as follows :
 - Span : 1.5 times channel integration bandwidth.
 - RBW : 1MHz
 - VBW : 3MHz
 - Detector : Peak
 - Sweep : Single trace
- Compute the combined power of all signal responses contained in the trace by covering all the data points.
- For 99% occupied BW, place the markers at the frequency at which 0.5% of the power lies to the right of the right marker and 0.5% of the power lies to the left of the left marker.
- The peak output power is the channel power integrated over 99% bandwidth.



TEST RESULTS

No non-compliance noted

Total peak power calculation formula:

$$10 \log (10^{(Chain\ 0\ Power / 10)} + 10^{(Chain\ 1\ Power / 10)})$$

The maximum antenna gain is 4.5dBi for other than fixed, point-to-point operations, therefore the limit is 30 dBm. In the legacy mode, the effective antenna gain is $4.5 + 10 \times \log(2) = 7.51\text{dBi}$. $7.51\text{dBi} - 6\text{dBi} = 1.51\text{dB}$; Peak power limit = $30 - 1.51 = 28.49\text{dBm}$

IEEE 802.11b mode (Two TX)

Channel	Channel Frequency (MHz)	Peak Power (dBm)		Peak Power Total (dBm)	Peak Power Limit (dBm)	Pass / Fail
		Chain 0	Chain 1			
Low	2412	21.31	22.10	24.73	28.49	PASS
Middle	2437	22.51	22.45	25.49	28.49	PASS
High	2462	20.46	20.26	23.37	28.49	PASS

- Note :
1. At final test to get the worst-case emission at 1Mbps.
 2. The cable assembly insertion loss of 11.7dB (including 10 dB pad and 1.7 dB cable) was Entered as an offset in the spectrum analyzer to allow for direct reading of power.

IEEE 802.11g mode (Two TX)

Channel	Channel Frequency (MHz)	Peak Power (dBm)		Peak Power Total (dBm)	Peak Power Limit (dBm)	Pass / Fail
		Chain 0	Chain 1			
Low	2412	25.17	24.81	28.00	28.49	PASS
Middle	2437	23.80	23.84	26.83	28.49	PASS
High	2462	24.67	24.85	27.77	28.49	PASS

- Note :
1. At final test to get the worst-case emission at 6Mbps.
 2. The cable assembly insertion loss of 11.7dB (including 10 dB pad and 1.7 dB cable) was Entered as an offset in the spectrum analyzer to allow for direct reading of power.



IEEE 802.11n HT20 mode (Two TX)

Channel	Channel Frequency (MHz)	Peak Power (dBm)		Peak Power Total (dBm)	Peak Power Limit (dBm)	Pass / Fail
		Chain 0	Chain 1			
Low	2412	23.51	23.71	26.62	28.49	PASS
Middle	2437	24.10	24.03	27.08	28.49	PASS
High	2462	24.12	24.02	27.08	28.49	PASS

- Note :
1. At final test to get the worst-case emission at 6.5Mbps.
 2. The cable assembly insertion loss of 11.7dB (including 10 dB pad and 1.7 dB cable) was Entered as an offset in the spectrum analyzer to allow for direct reading of power.

IEEE 802.11n HT40 mode (Two TX)

Channel	Channel Frequency (MHz)	Peak Power (dBm)		Peak Power Total (dBm)	Peak Power Limit (dBm)	Pass / Fail
		Chain 0	Chain 1			
Low	2422	24.06	22.18	26.23	28.49	PASS
Middle	2437	23.98	23.85	26.93	28.49	PASS
High	2452	20.92	21.15	24.05	28.49	PASS

- Note :
1. At final test to get the worst-case emission at 6.5Mbps.
 2. The cable assembly insertion loss of 11.7dB (including 10 dB pad and 1.7 dB cable) was Entered as an offset in the spectrum analyzer to allow for direct reading of power.



MAXIMUM PEAK OUTPUT POWER (802.11b MODE)

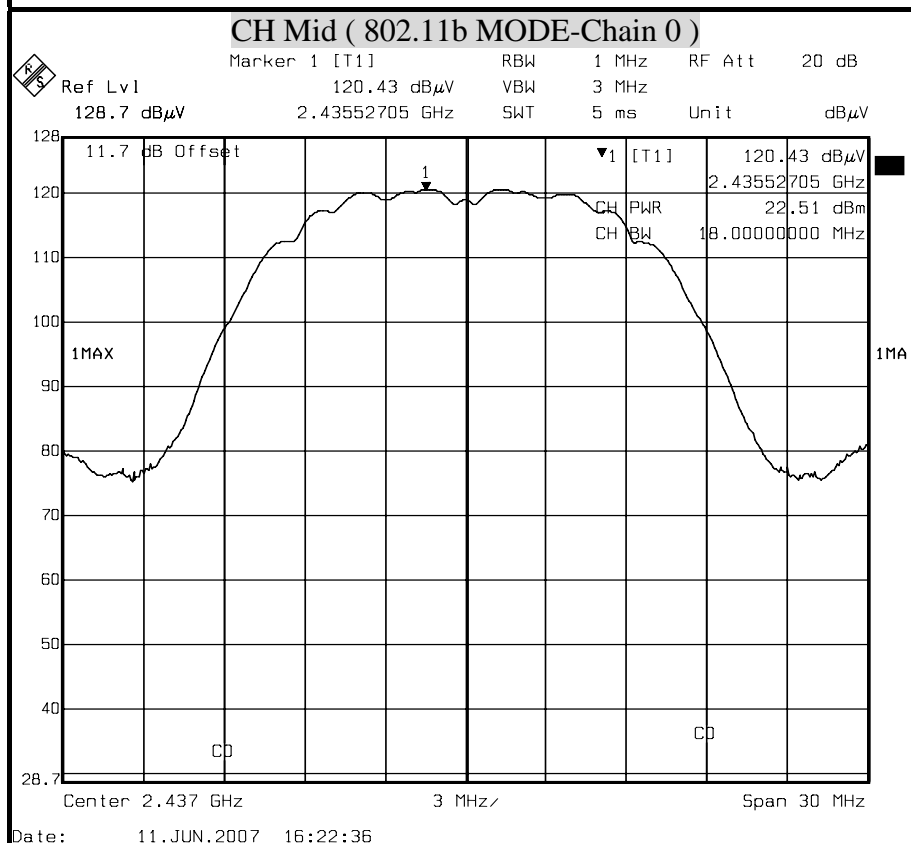
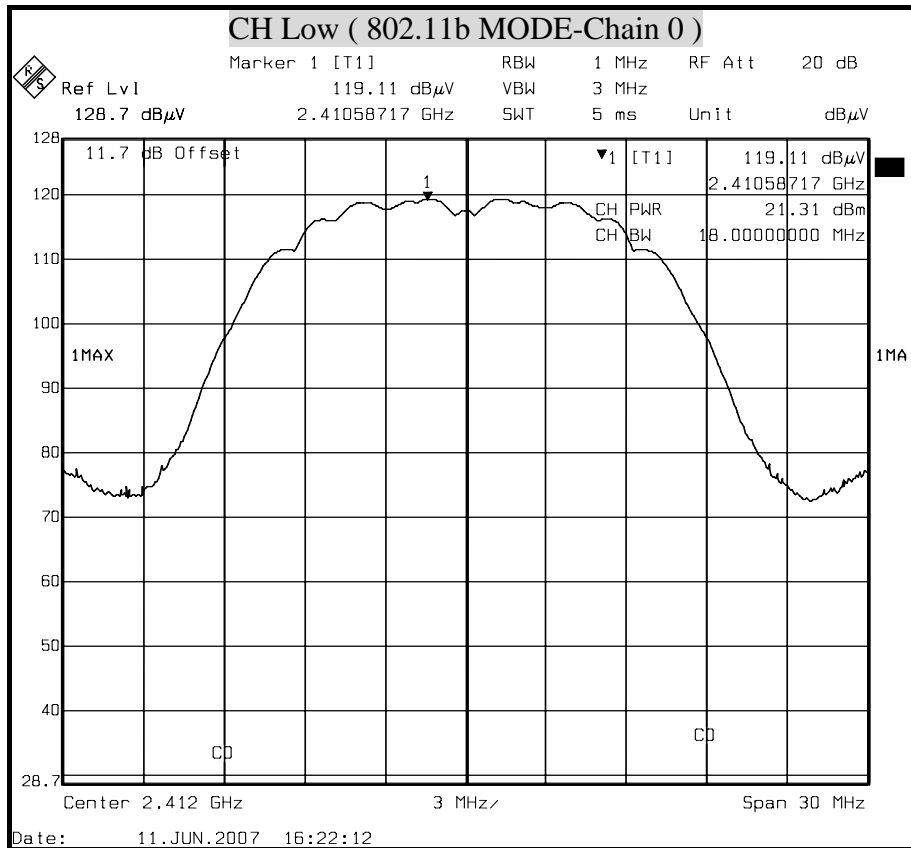

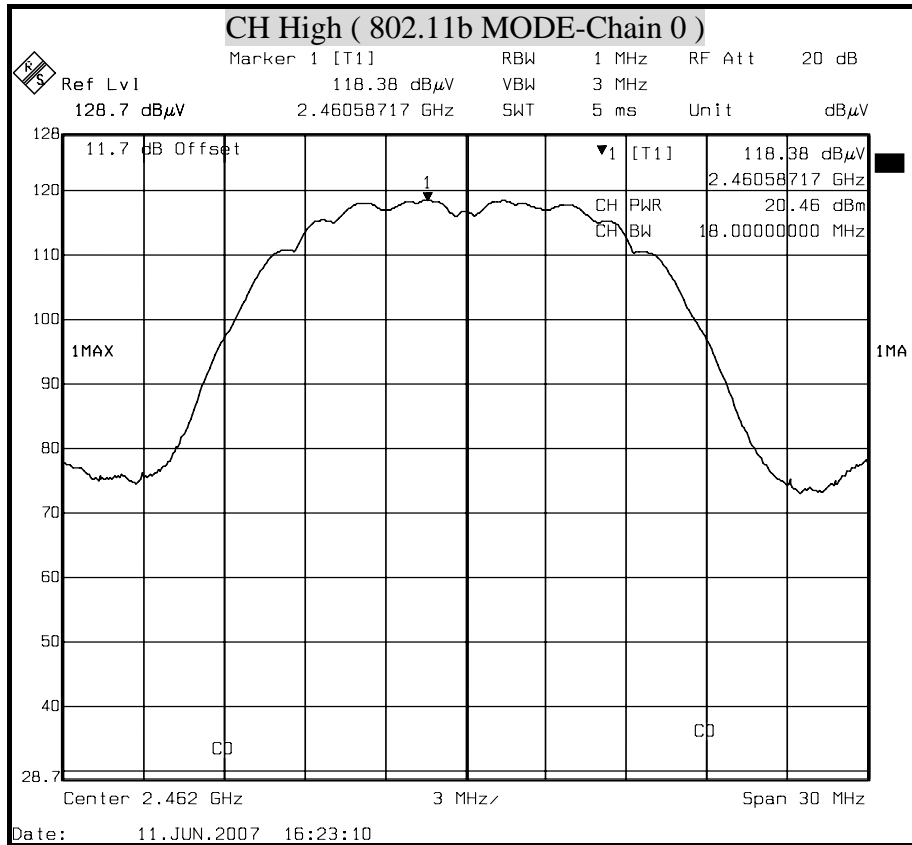

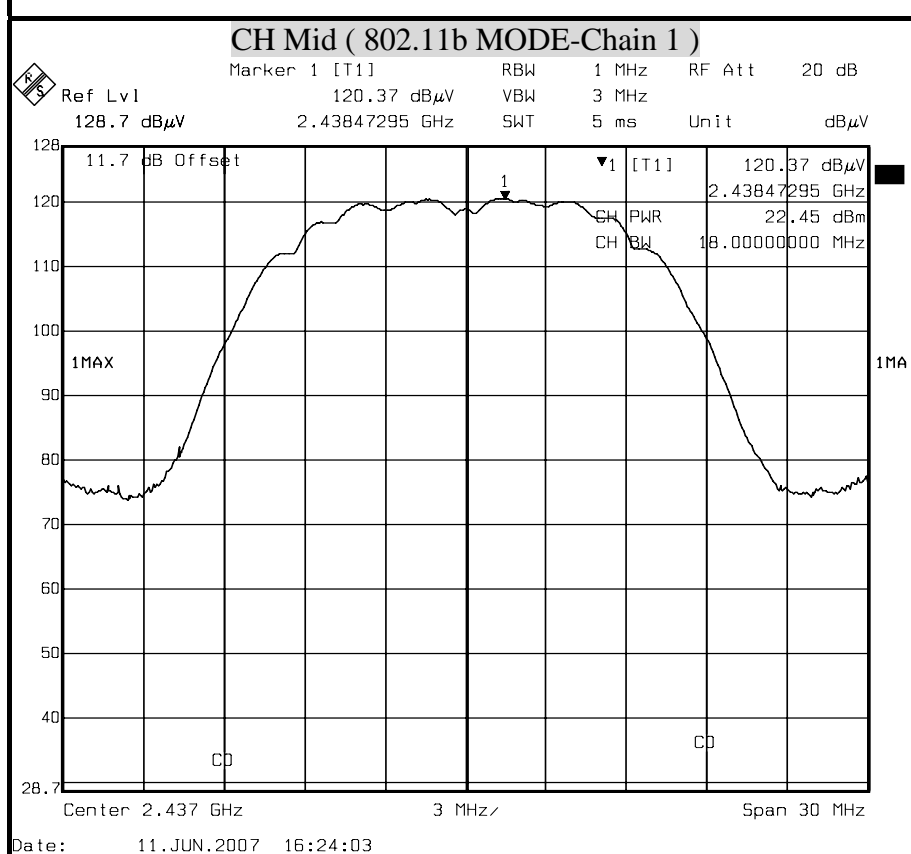
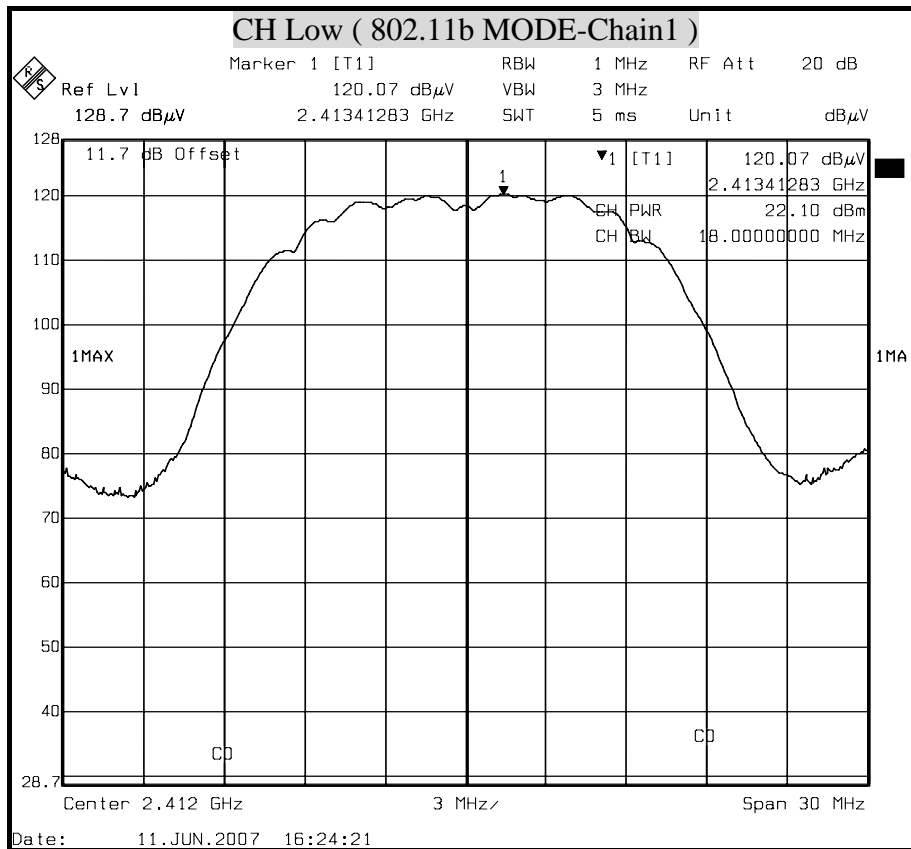

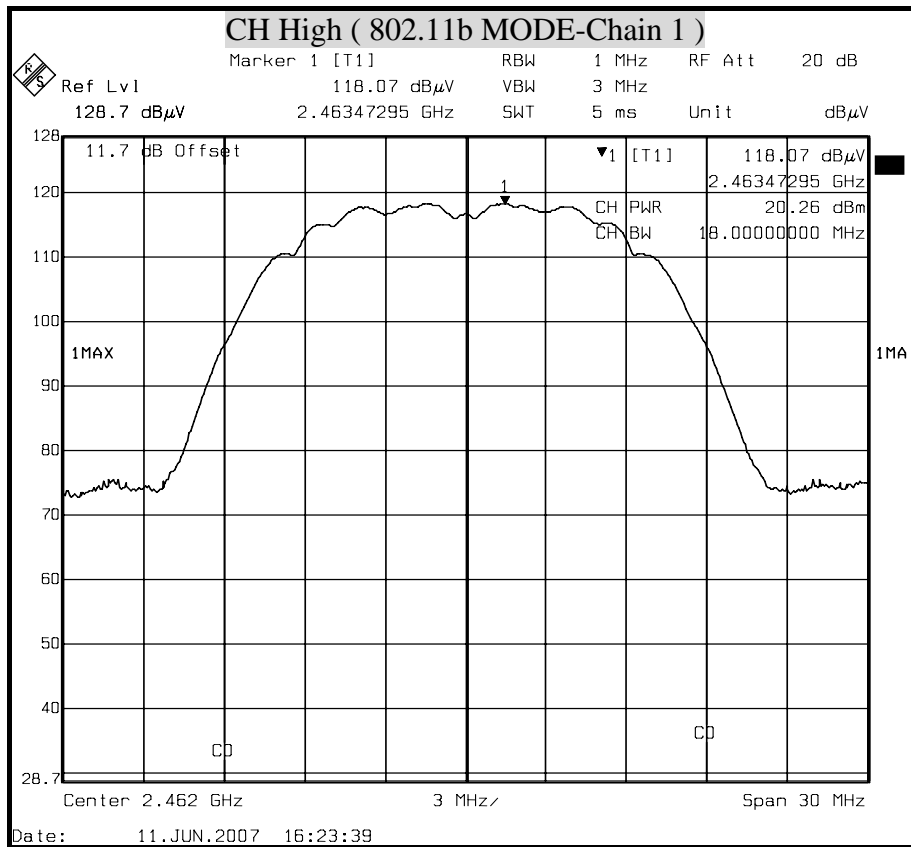



MAXIMUM PEAK OUTPUT POWER (802.11g MODE)

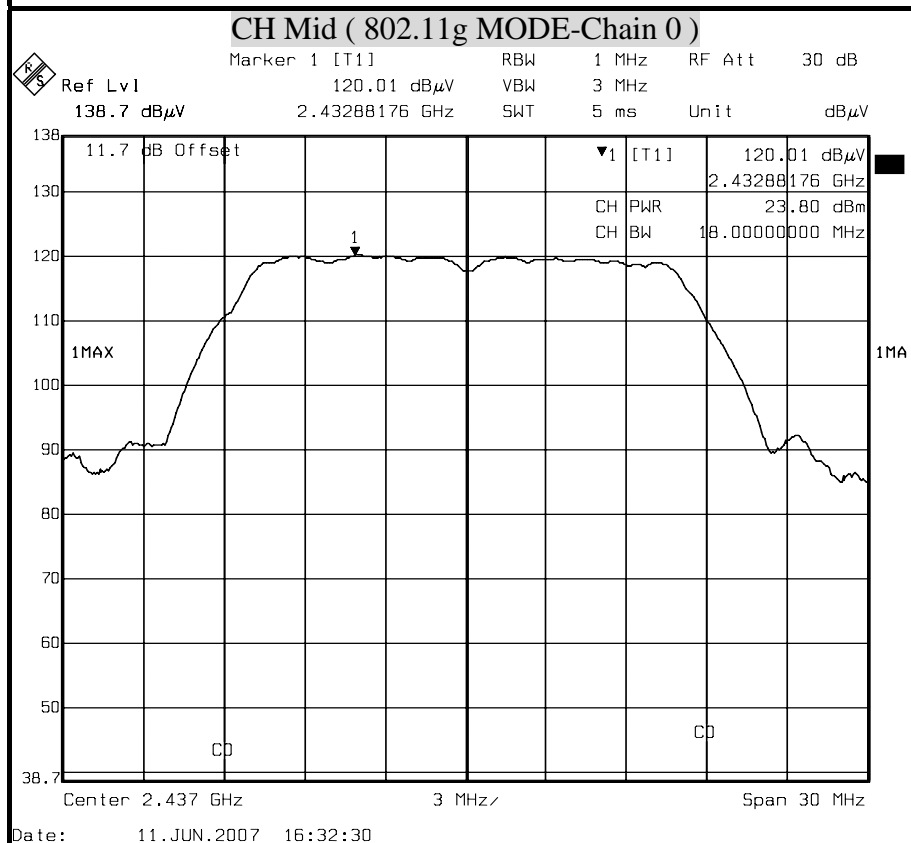
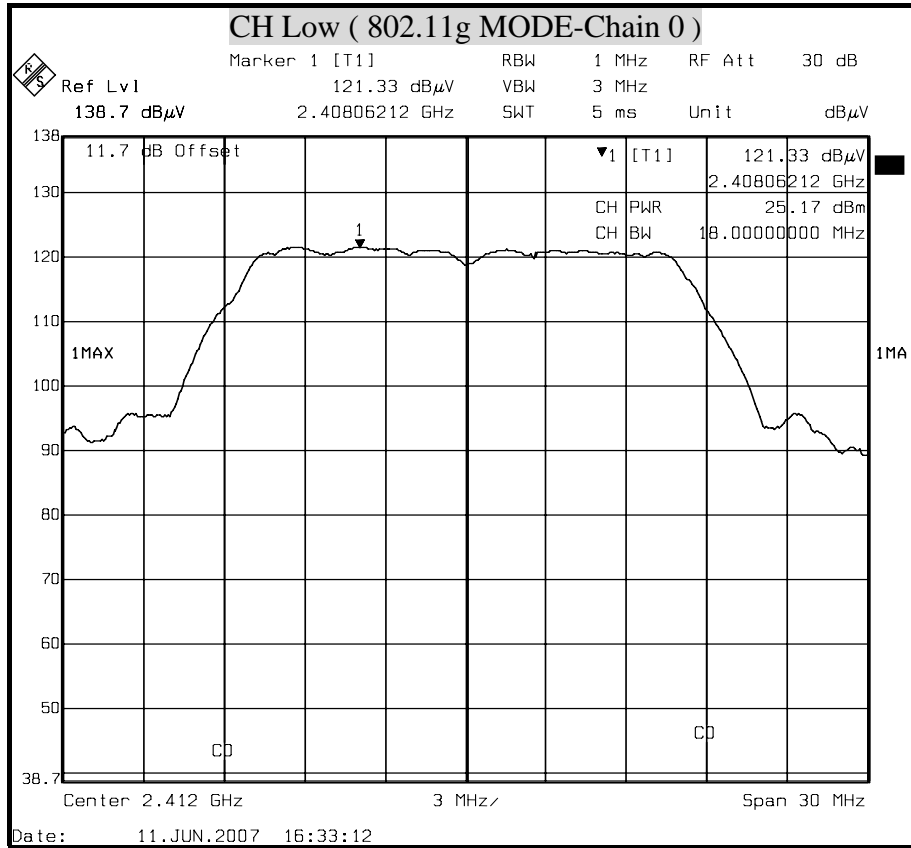

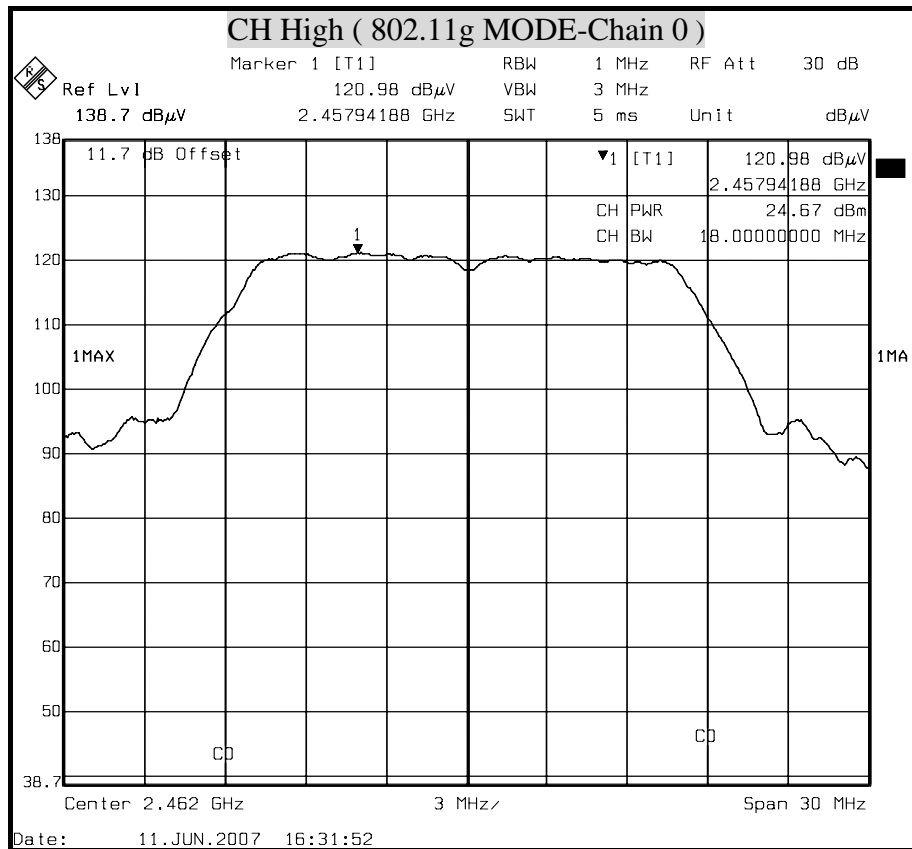

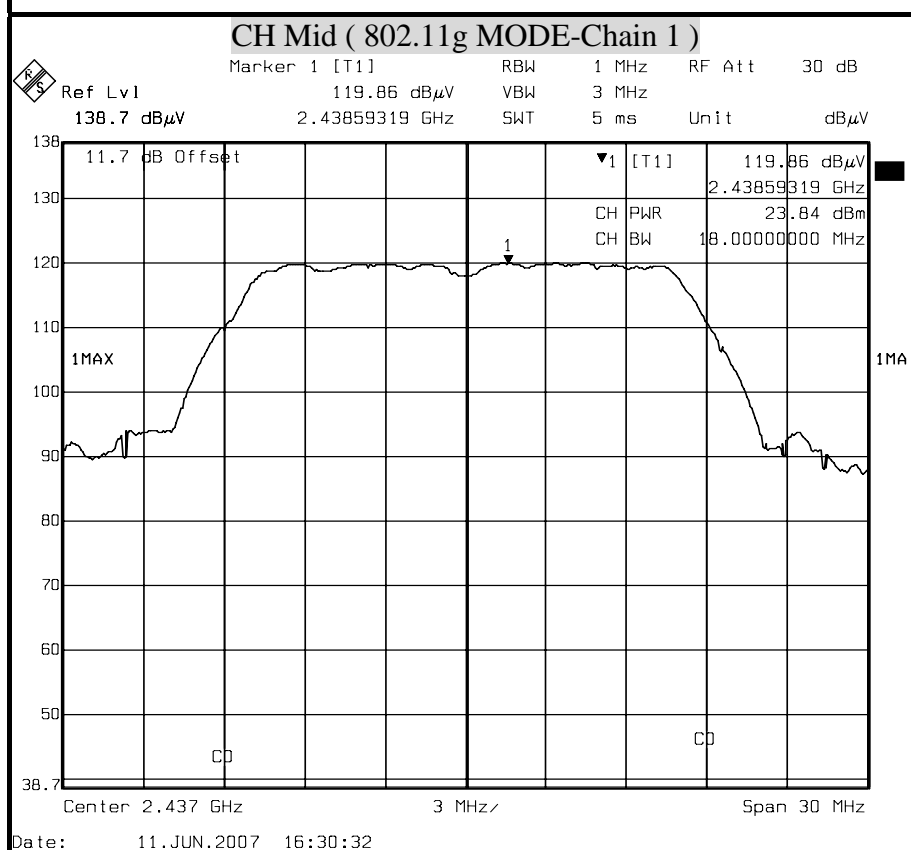
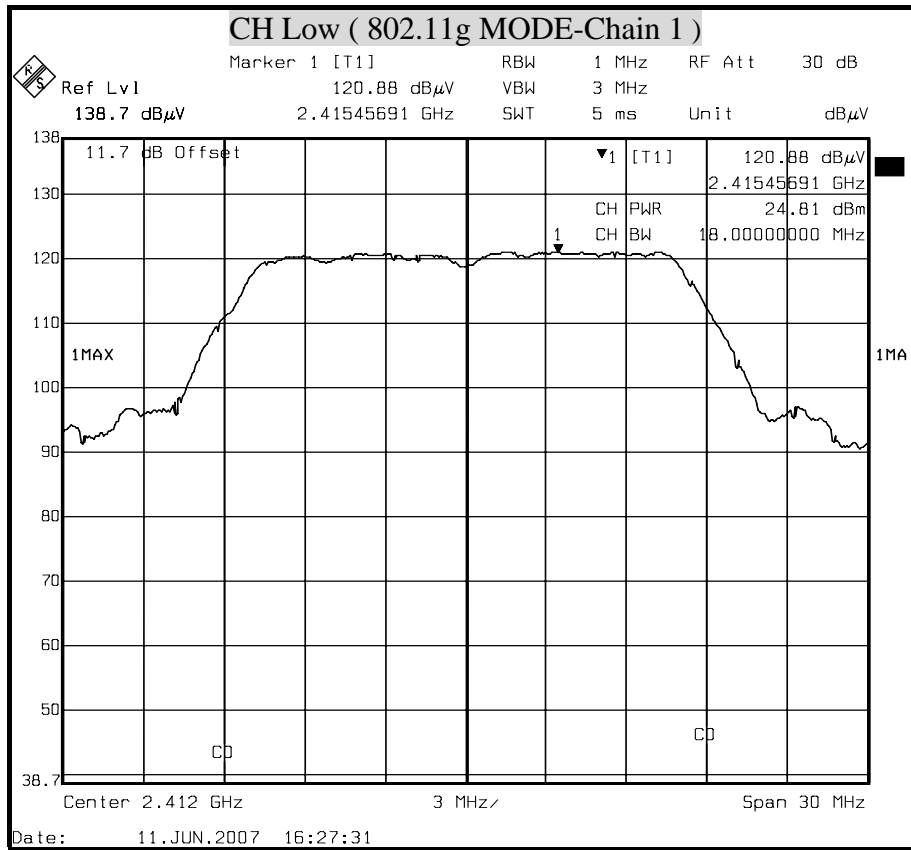

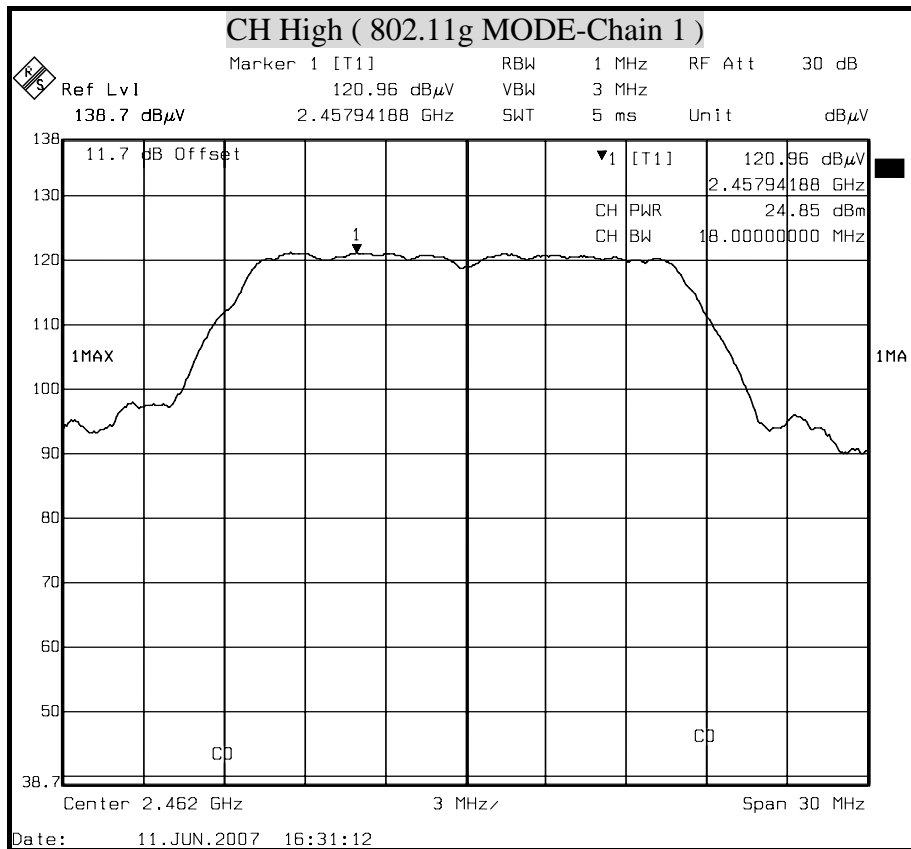



MAXIMUM PEAK OUTPUT POWER (802.11n HT20 MODE)

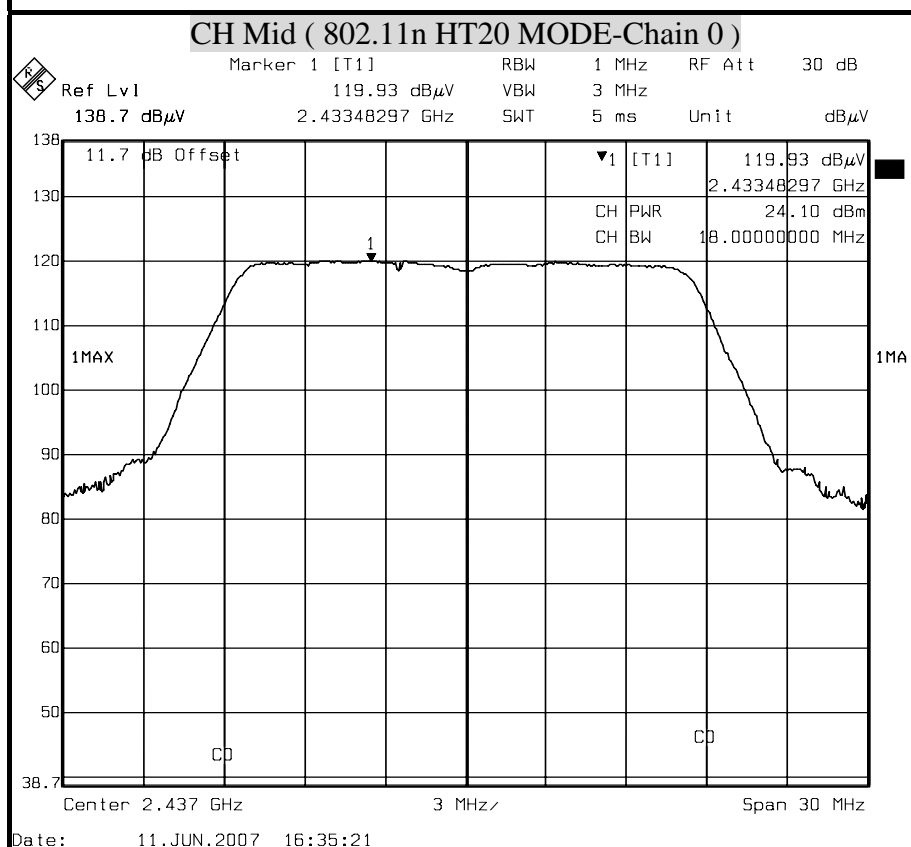
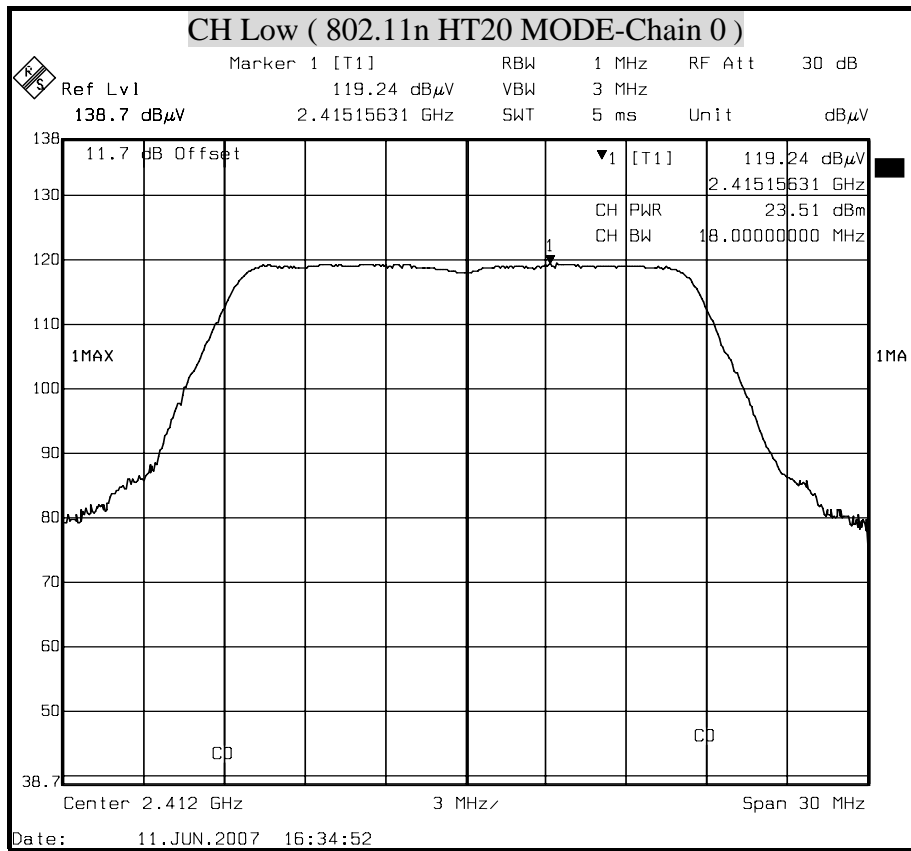

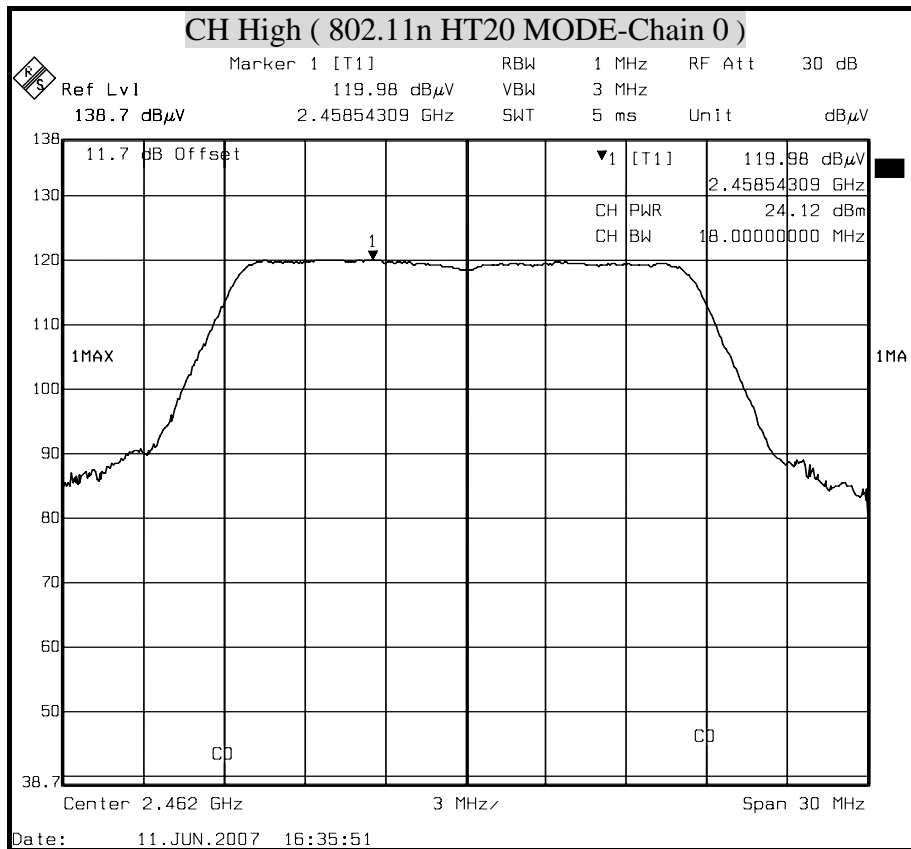

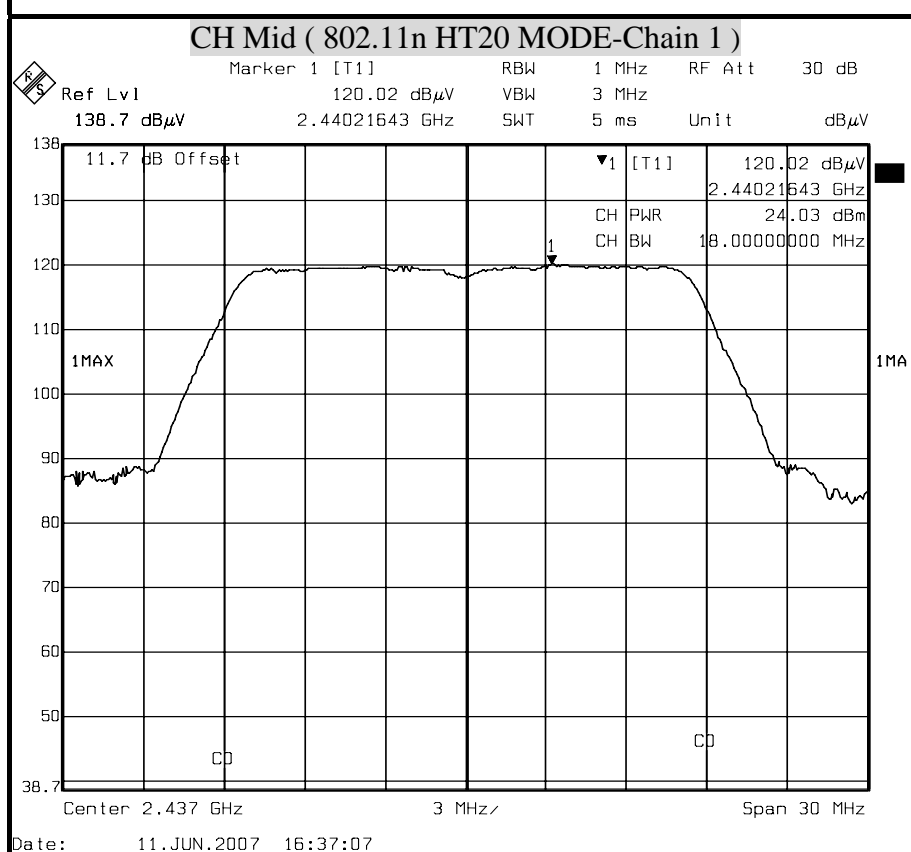
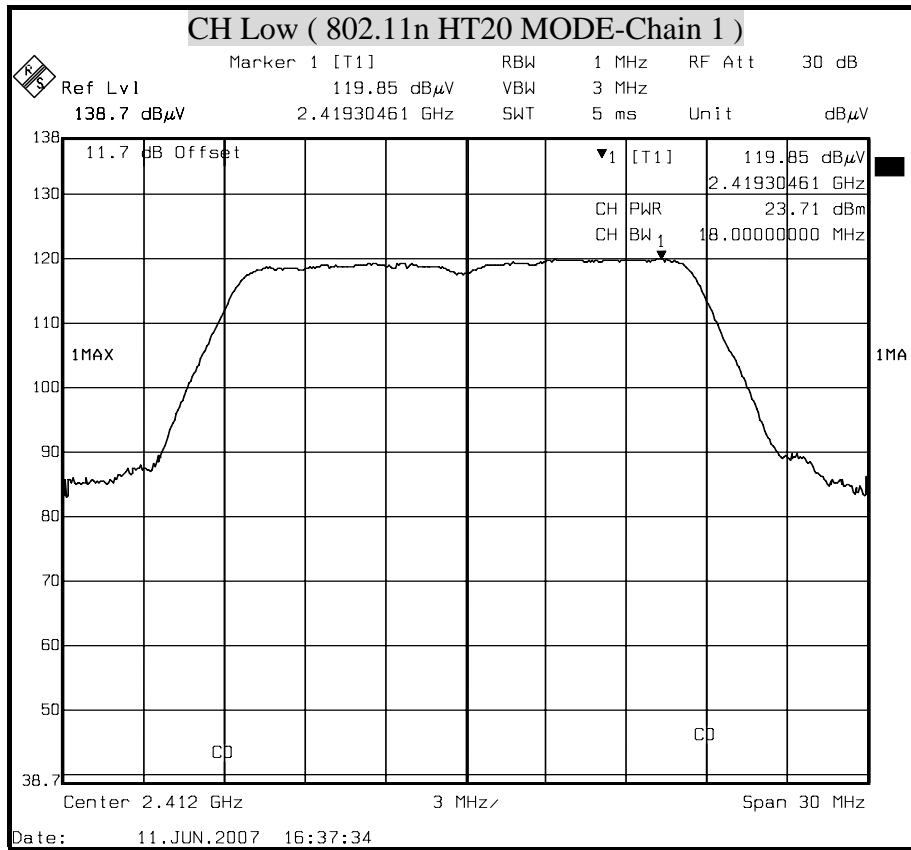

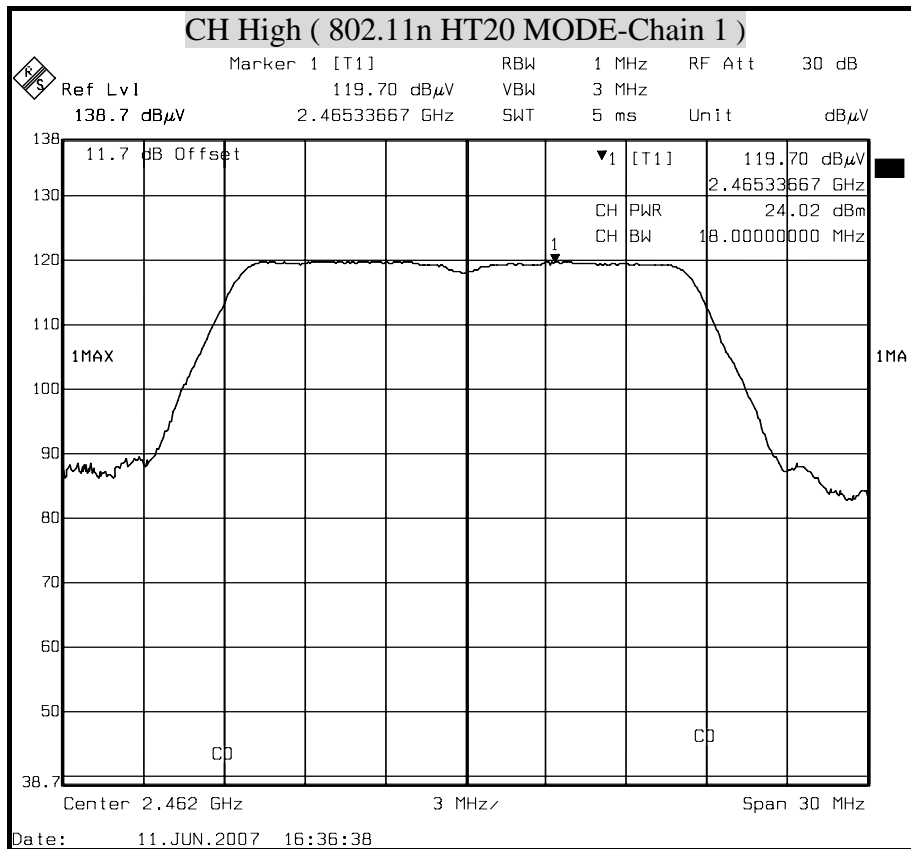



MAXIMUM PEAK OUTPUT POWER (802.11n HT40 MODE)

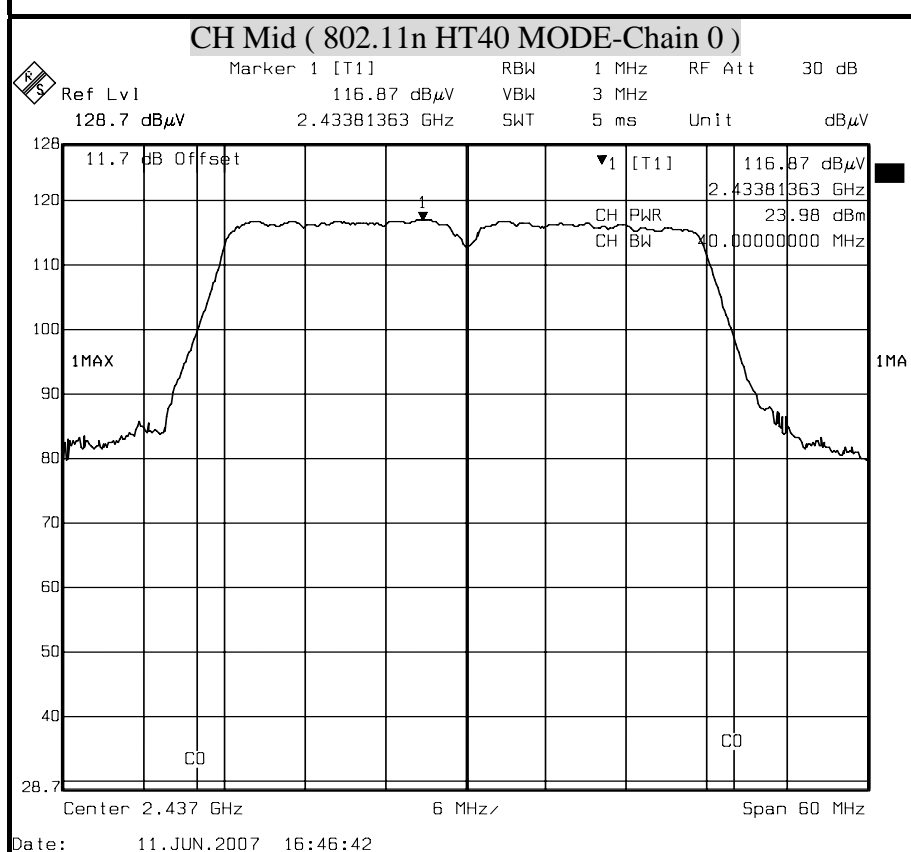
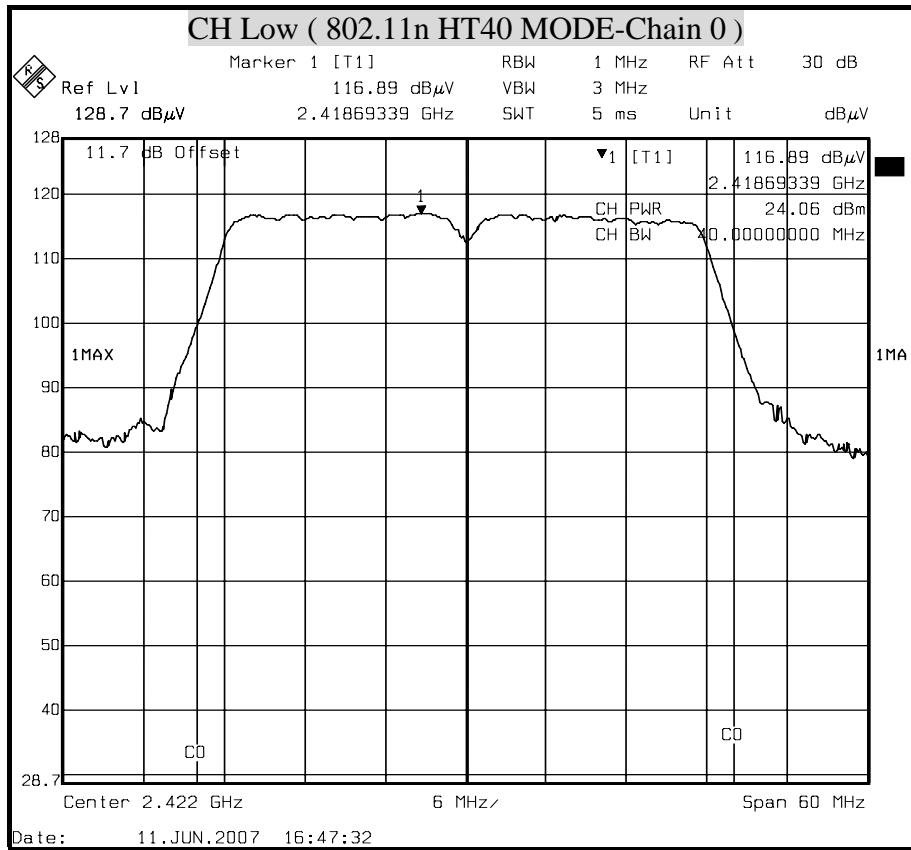

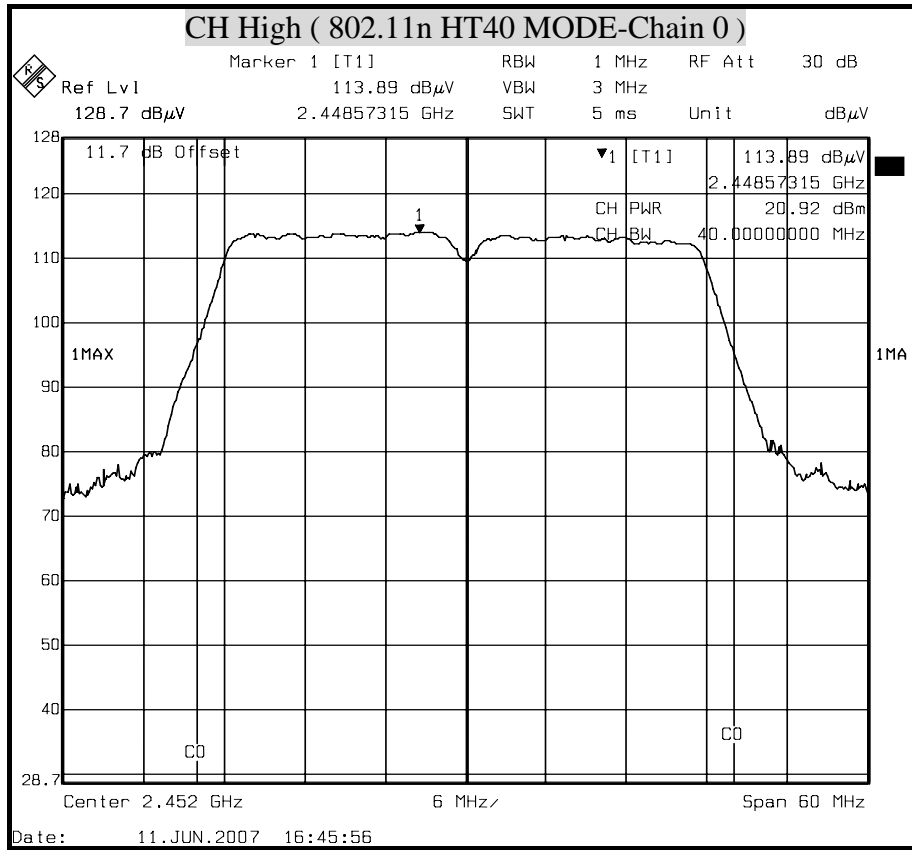

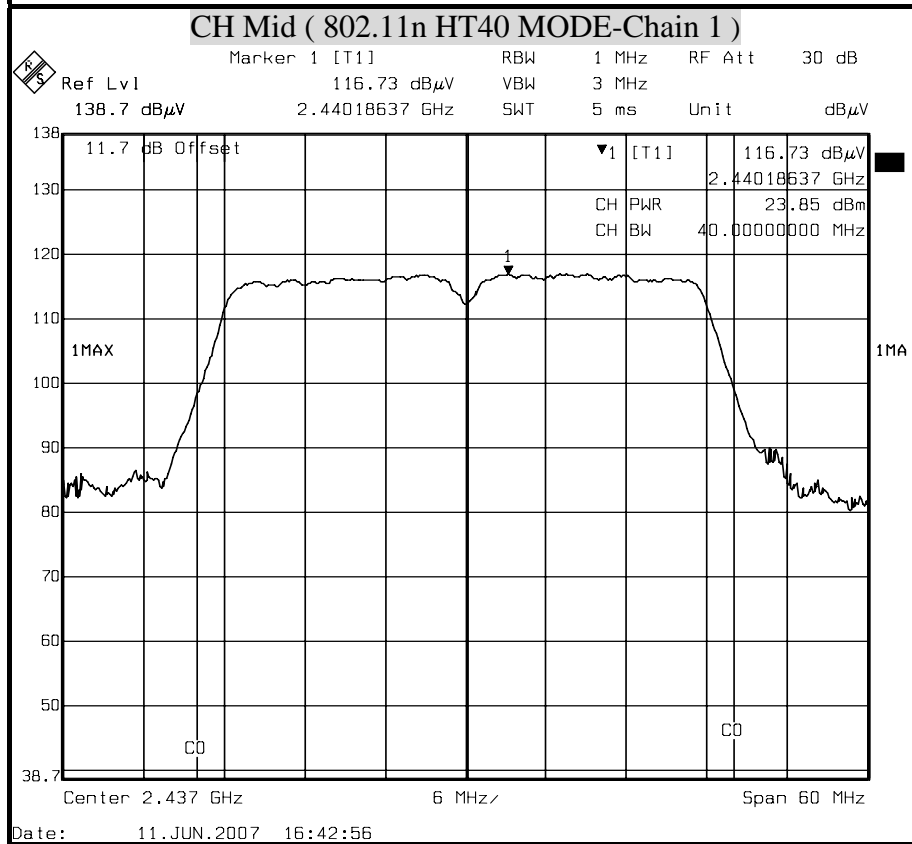
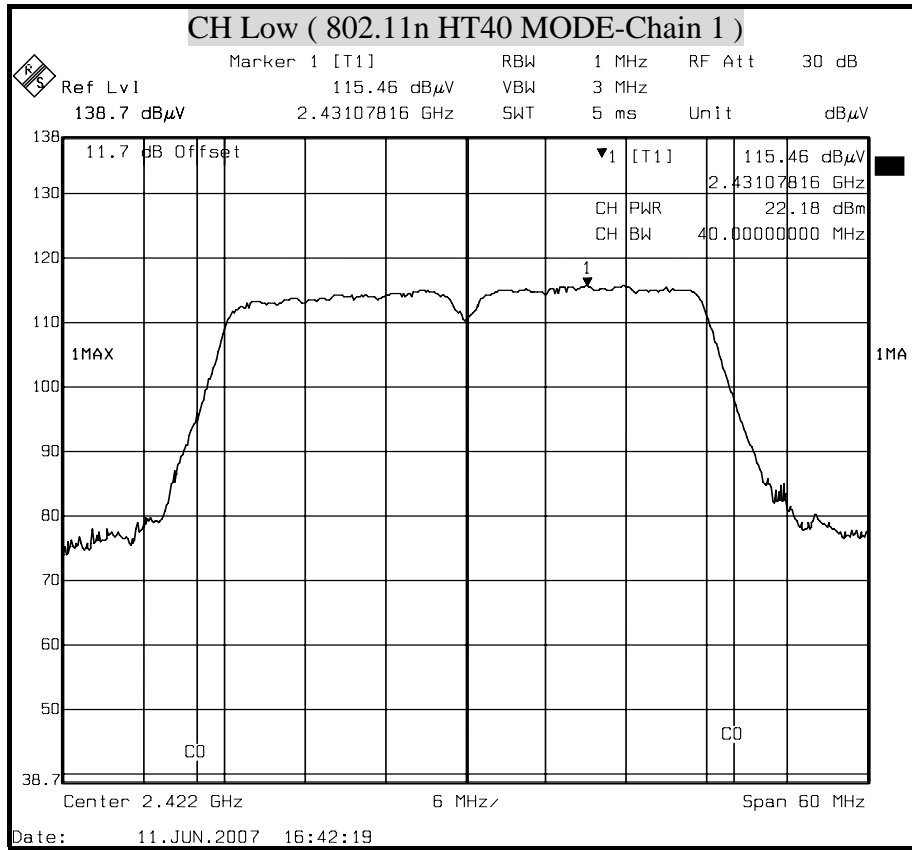

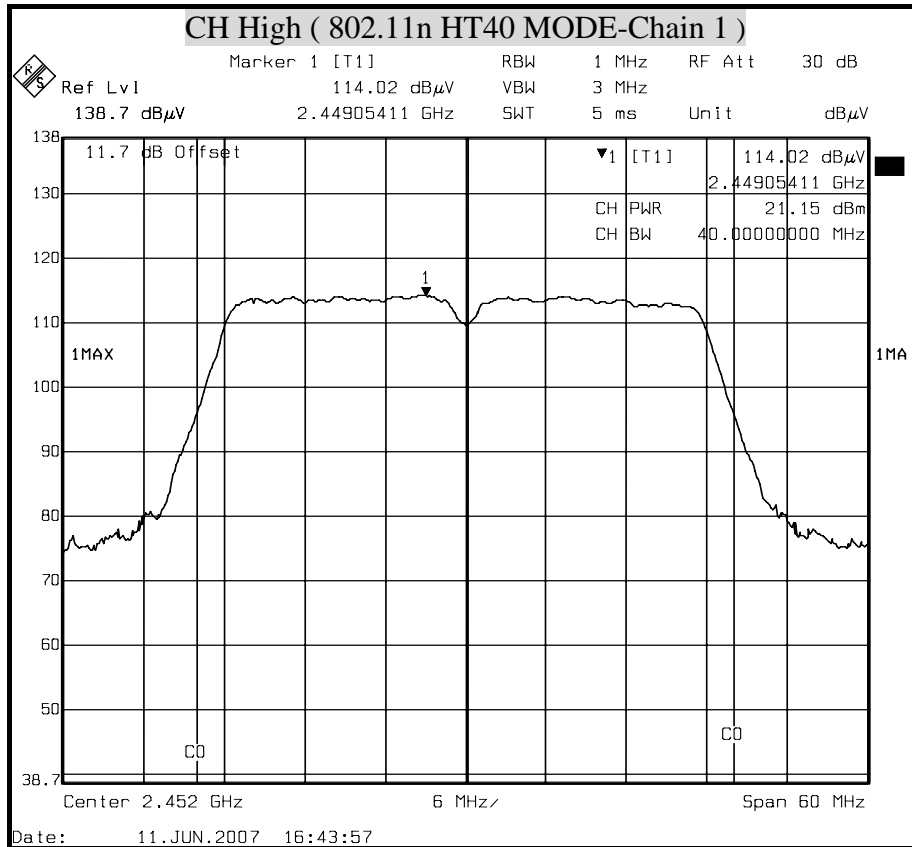



8.4 MAXIMUM PERMISSIBLE EXPOSURE

According to FCC 1.1310 : The criteria listed in the following table shall be used to evaluate the environment impact of human exposure to radio frequency (RF) radiation as specified in 1.1307(b) LIMITS FOR MAXIMUM PERMISSIBLE EXPOSURE (MPE)

Frequency Range (MHz)	Electric Field Strength (V/m)	Magnetic Field Strength (A/m)	Power Density (mW/cm ²)	Average Time
(A) Limits for Occupational / Control Exposures				
300-1,500	--	--	F/300	6
1,500-100,000	--	--	5	6
(B) Limits for General Population / Uncontrol Exposures				
300-1,500	--	--	F/1500	6
1,500-100,000	--	--	1	30

CALCULATIONS

Given $E = \frac{\sqrt{30 \times P \times G}}{d}$ & $S = \frac{E^2}{3770}$

Where E = Field strength in Volts / meter

P = Power in Watts

G = Numeric antenna gain

d = Distance in meters

S = Power density in milliwatts / square centimeter

Combining equations and re-arranging the terms to express the distance as a function of the remaining variables yields:

$$S = \frac{30 \times P \times G}{3770d^2}$$

Changing to units of mW and cm, using:

$$P (mW) = P (W) / 1000 \text{ and}$$

$$d (cm) = d(m) / 100$$

Yields

$$S = \frac{30 \times (P/1000) \times G}{3770 \times (d/100)^2} = 0.0796 \times \frac{P \times G}{d^2}$$

Where d = Distance in cm

P = Power in mW

G = Numeric antenna gain

S = Power density in mW / cm²



LIMIT

Power Density Limit, $S=1.0\text{mW}/\text{cm}^2$

TEST RESULTS

No non-compliance noted

Mode	Minimum separation distance (cm)	Output Power (dBm)	Antenna Gain (dBi)	Power Density Limit (mW/cm^2)	Power Density at 20cm (mW/cm^2)
IEEE 802.11b	20.0	25.49	4.50	1.00	0.20
IEEE 802.11g	20.0	28.00	4.50	1.00	0.35
IEEE 802.11n HT20	20.0	27.08	4.50	1.00	0.29
IEEE 802.11n HT40	20.0	28.00	4.50	1.00	0.35

Remark: For mobile or fixed location transmitters, the maximum power density is $1.0\text{ mW}/\text{cm}^2$ even if the calculation indicates that the power density would be larger.



8.5 AVERAGE POWER

LIMIT

None; for reporting purposes only.

TEST EQUIPMENTS

Name of Equipment	Manufacturer	Model	Serial Number	Calibration Due
Power Meter	Anritsu	ML2487A	6K00003888	MAR. 13, 2007

TEST SETUP



TEST PROCEDURE

The transmitter output is connected to a power meter.

TEST RESULTS

Total peak power calculation formula:

$$10 \log (10^{\text{Chain 0 Power} / 10} + 10^{\text{Chain1 Power} / 10})$$

No non-compliance noted



IEEE 802.11b mode

Channel	Channel Frequency (MHz)	Average Power (dBm)	
		Chain 0	Chain 1
Low	2412	17.93	17.55
Middle	2437	17.65	17.82
High	2462	17.67	17.32

Note : 1. At final test to get the worst-case emission at 1Mbps.
 2. The cable assembly insertion loss of 11.7dB (including 10 dB pad and 1.7 dB cable) was Entered as an offset in the spectrum analyzer to allow for direct reading of power.

IEEE 802.11g mode

Channel	Channel Frequency (MHz)	Average Power (dBm)	
		Chain 0	Chain 1
Low	2412	16.91	16.63
Middle	2437	15.53	15.43
High	2462	16.65	16.45

Note : 1. At final test to get the worst-case emission at 6Mbps.
 2. The cable assembly insertion loss of 11.7dB (including 10 dB pad and 1.7 dB cable) was Entered as an offset in the spectrum analyzer to allow for direct reading of power.

IEEE 802.11n HT20 mode

Channel	Channel Frequency (MHz)	Average Power (dBm)	
		Chain 0	Chain 1
Low	2412	14.74	14.58
Middle	2437	15.48	15.36
High	2462	16.11	15.92

Note : 1. At final test to get the worst-case emission at 6.5Mbps.
 2. The cable assembly insertion loss of 11.7dB (including 10 dB pad and 1.7 dB cable) was Entered as an offset in the spectrum analyzer to allow for direct reading of power.

IEEE 802.11n HT40 mode

Channel	Channel Frequency (MHz)	Average Power (dBm)	
		Chain 0	Chain 1
Low	2422	14.02	13.46
Middle	2437	15.52	15.15
High	2452	11.94	11.90

Note : 1. At final test to get the worst-case emission at 6.5Mbps.
 2. The cable assembly insertion loss of 11.7dB (including 10 dB pad and 1.7 dB cable) was Entered as an offset in the spectrum analyzer to allow for direct reading of power.



8.6 POWER SPECTRAL DENSITY

LIMIT

§ 15.247(e) For digitally modulated systems, the power spectral density conducted from the intentional radiator to the antenna shall not greater than 8 dBm in any 3 kHz band during any time interval of continuous transmission.

TEST EQUIPMENTS

Name of Equipment	Manufacturer	Model	Serial Number	Calibration Due
Spectrum Analyzer	R&S	FSEM	829054/017	MAR. 13, 2008

TEST SETUP

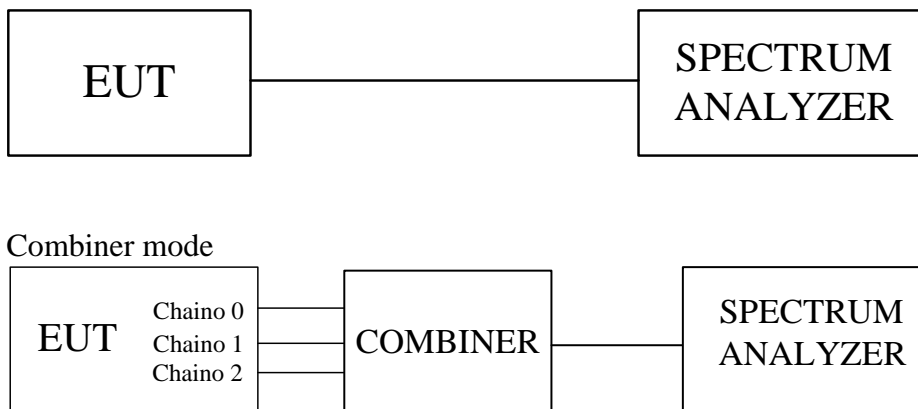

TEST PROCEDURE

The transmitter output was connected to the spectrum analyzer, the bandwidth of the fundamental frequency was measured with the spectrum analyzer using RBW=3KHz and VBW ≥ RBW, set sweep time=span / 3KHz.

The power spectral density was measured and recorded.

The sweep time is allowed to be longer than span / 3KHz for a full response of the mixer in the spectrum analyzer.

TEST RESULTS

Total peak power calculation formula:

$$10 \log (10^{\text{Chain 0 PPSD} / 10} + 10^{\text{Chain1 PPSD} / 10})$$

No non-compliance noted

**IEEE 802.11b mode**

Channel	Channel Frequency (MHz)	Final RF Power Level in 3KHz BW (dBm)		PPSD Total (dBm)	Maximum Limit (dBm)	Pass / Fail
		Chain 0	Chain 1			
Low	2412	-12.46	-12.70	-9.57	8	PASS
Middle	2437	-11.11	-11.37	-8.23	8	PASS
High	2462	-13.31	-13.25	-10.27	8	PASS

- Note :
1. At final test to get the worst-case emission at 1Mbps.
 2. The cable assembly insertion loss of 11.7dB (including 10 dB pad and 1.7 dB cable) was Entered as an offset in the spectrum analyzer to allow for direct reading of power.

IEEE 802.11b Combined mode

Channel	Channel Frequency (MHz)	Final RF Power Level in 3KHz BW (dBm)	Maximum Limit (dBm)	Pass / Fail
Low	2412	-7.51	8	PASS
Middle	2437	-6.60	8	PASS
High	2462	-9.05	8	PASS

- Note :
1. At final test to get the worst-case emission at 1Mbps.
 2. The cable assembly insertion loss of 15.2dB (including 10 dB pad and 5.2 dB cable) was Entered as an offset in the spectrum analyzer to allow for direct reading of power.

IEEE 802.11g mode

Channel	Channel Frequency (MHz)	Final RF Power Level in 3KHz BW (dBm)		PPSD Total (dBm)	Maximum Limit (dBm)	Pass / Fail
		Chain 0	Chain 1			
Low	2412	-11.95	-11.74	-8.83	8	PASS
Middle	2437	-13.26	-13.69	-10.46	8	PASS
High	2462	-12.50	-12.73	-9.60	8	PASS

- Note :
1. At final test to get the worst-case emission at 6Mbps.
 2. The cable assembly insertion loss of 11.7dB (including 10 dB pad and 1.7 dB cable) was Entered as an offset in the spectrum analyzer to allow for direct reading of power.

IEEE 802.11g Combined mode

Channel	Channel Frequency (MHz)	Final RF Power Level in 3KHz BW (dBm)	Maximum Limit (dBm)	Pass / Fail
Low	2412	-6.82	8	PASS
Middle	2437	-7.10	8	PASS
High	2462	-5.84	8	PASS

- Note :
1. At final test to get the worst-case emission at 6Mbps.
 2. The cable assembly insertion loss of 15.2dB (including 10 dB pad and 5.2 dB cable) was Entered as an offset in the spectrum analyzer to allow for direct reading of power.

**IEEE 802.11n HT20 mode**

Channel	Channel Frequency (MHz)	Final RF Power Level in 3KHz BW (dBm)		PPSD Total (dBm)	Maximum Limit (dBm)	Pass / Fail
		Chain 0	Chain 1			
Low	2412	-13.37	-12.40	-9.85	8	PASS
Middle	2437	-12.91	-12.70	-9.79	8	PASS
High	2462	-12.69	-12.32	-9.49	8	PASS

- Note :
1. At final test to get the worst-case emission at 6.5Mbps.
 2. The cable assembly insertion loss of 11.7dB (including 10 dB pad and 1.7 dB cable) was Entered as an offset in the spectrum analyzer to allow for direct reading of power.

IEEE 802.11n HT20 Combined mode

Channel	Channel Frequency (MHz)	Final RF Power Level in 3KHz BW (dBm)	Maximum Limit (dBm)	Pass / Fail
Low	2412	-8.61	8	PASS
Middle	2437	-6.22	8	PASS
High	2462	-6.69	8	PASS

- Note :
1. At final test to get the worst-case emission at 6.5Mbps.
 2. The cable assembly insertion loss of 15.2dB (including 10 dB pad and 5.2 dB cable) was Entered as an offset in the spectrum analyzer to allow for direct reading of power.

IEEE 802.11n HT40 mode

Channel	Channel Frequency (MHz)	Final RF Power Level in 3KHz BW (dBm)		PPSD Total (dBm)	Maximum Limit (dBm)	Pass / Fail
		Chain 0	Chain 1			
Low	2422	-15.08	-14.43	-11.73	8	PASS
Middle	2437	-15.59	-14.70	-12.11	8	PASS
High	2452	-16.15	-17.97	-13.96	8	PASS

- Note :
1. At final test to get the worst-case emission at 6.5Mbps.
 2. The cable assembly insertion loss of 11.7dB (including 10 dB pad and 1.7 dB cable) was Entered as an offset in the spectrum analyzer to allow for direct reading of power.

IEEE 802.11n HT40 Combined mode

Channel	Channel Frequency (MHz)	Final RF Power Level in 3KHz BW (dBm)	Maximum Limit (dBm)	Pass / Fail
Low	2422	-10.60	8	PASS
Middle	2437	-8.33	8	PASS
High	2452	-13.11	8	PASS

- Note :
1. At final test to get the worst-case emission at 6.5Mbps.
 2. The cable assembly insertion loss of 15.2dB (including 10 dB pad and 5.2 dB cable) was Entered as an offset in the spectrum analyzer to allow for direct reading of power.



POWER SPECTRAL DENSITY (IEEE 802.11b MODE)

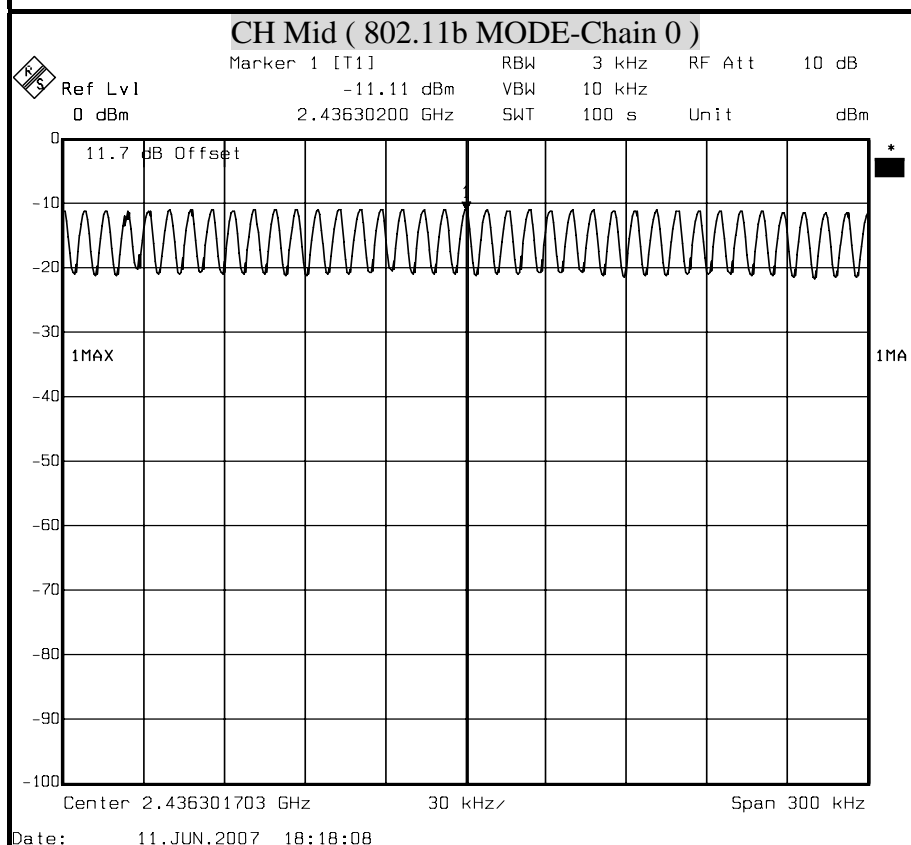
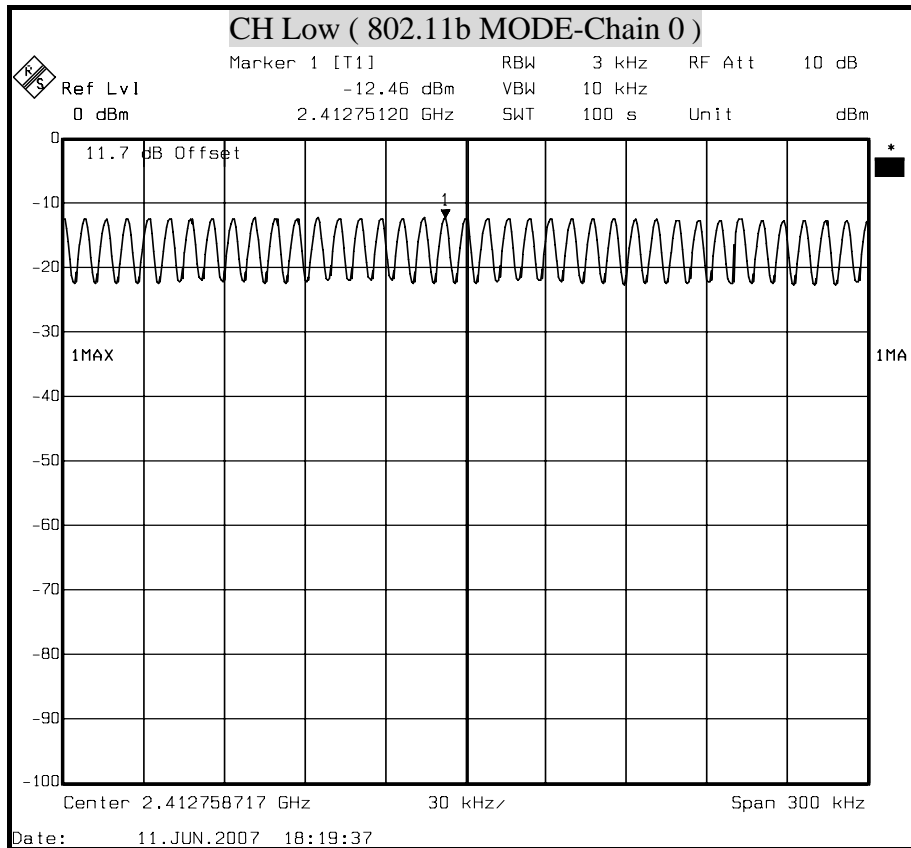

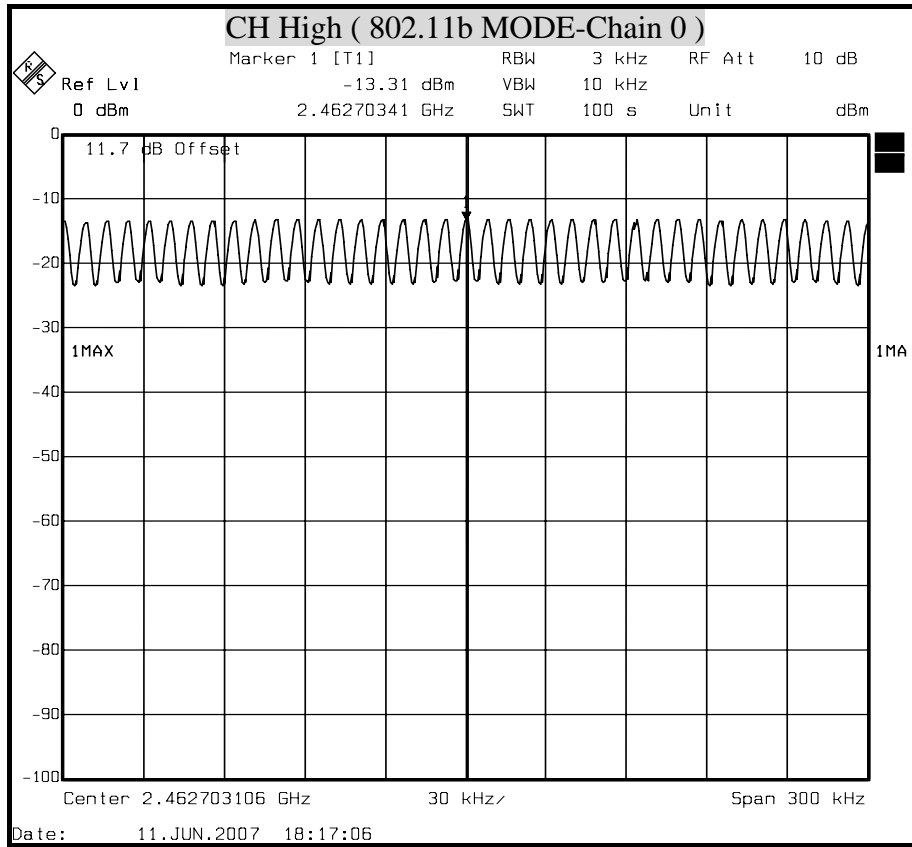

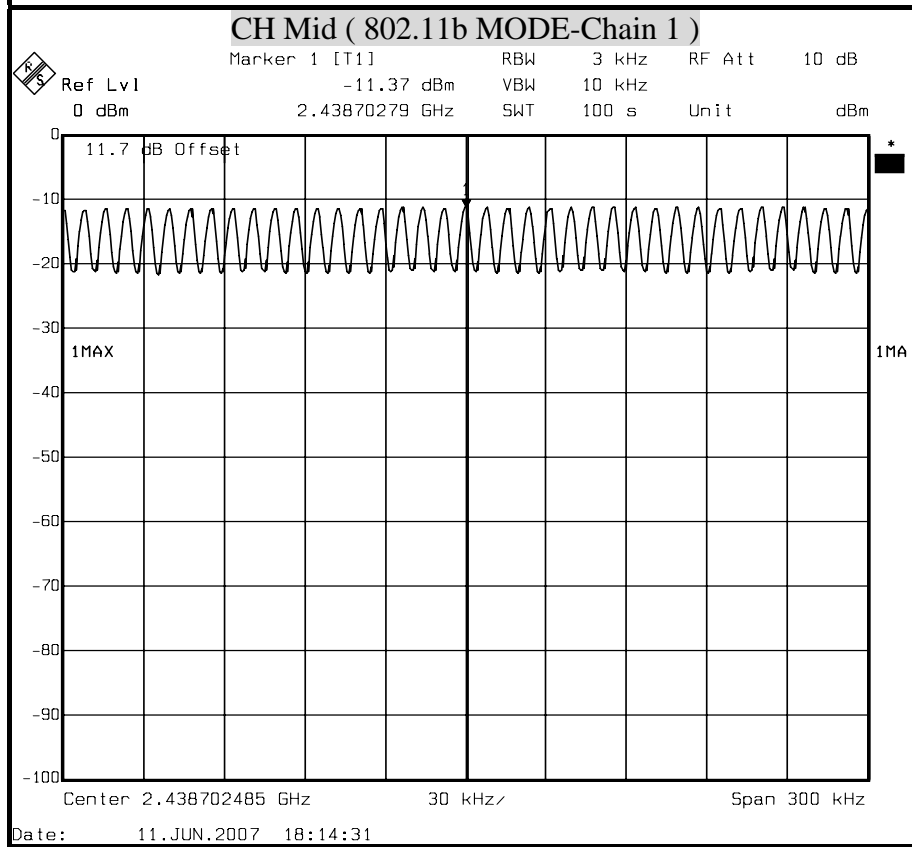
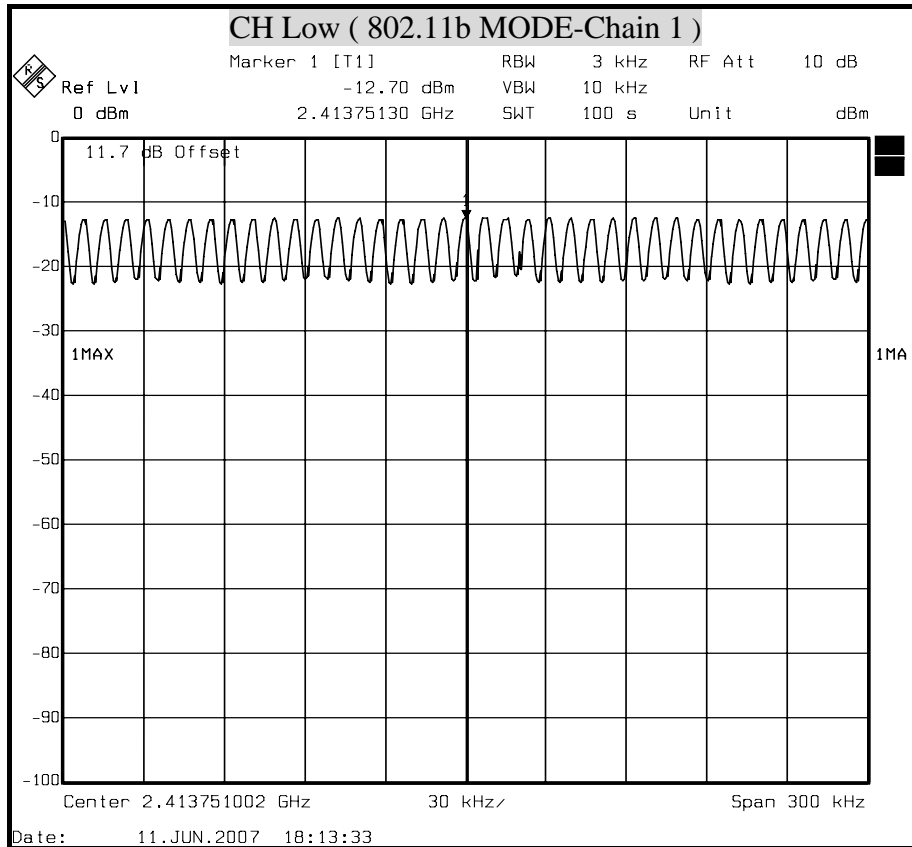

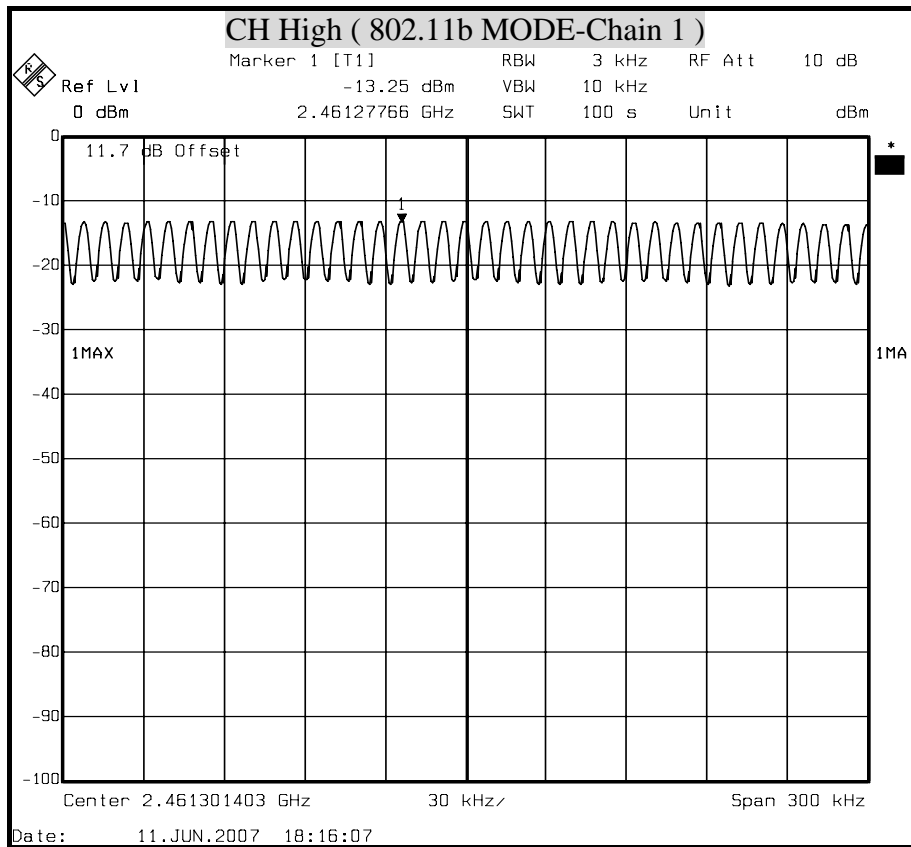

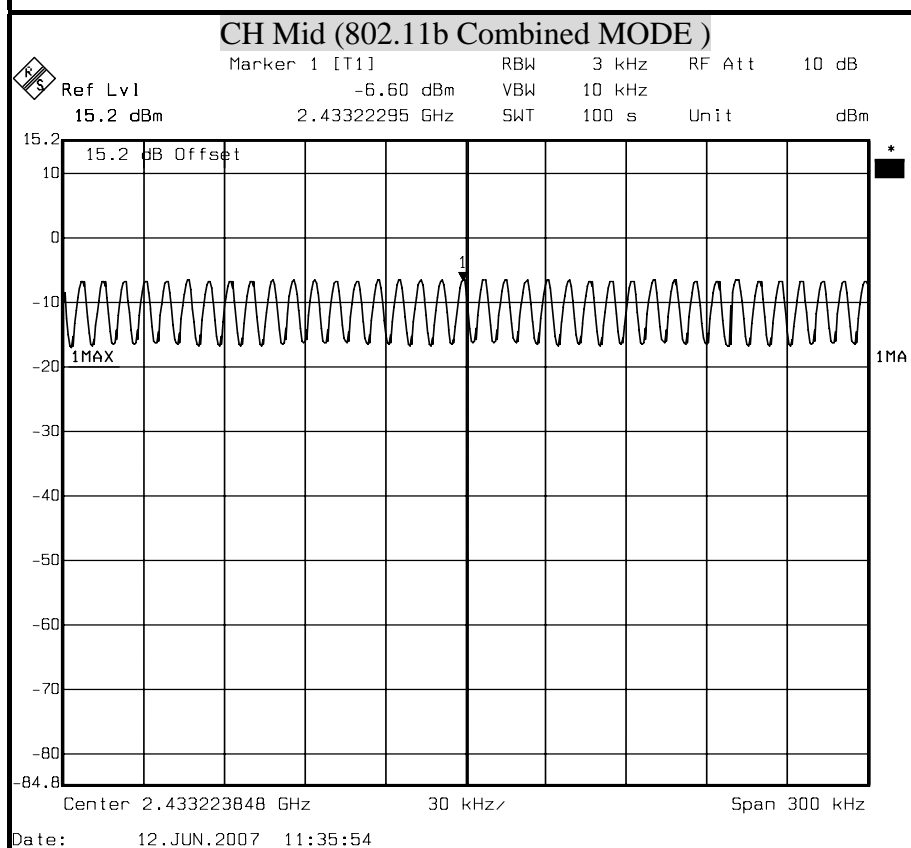
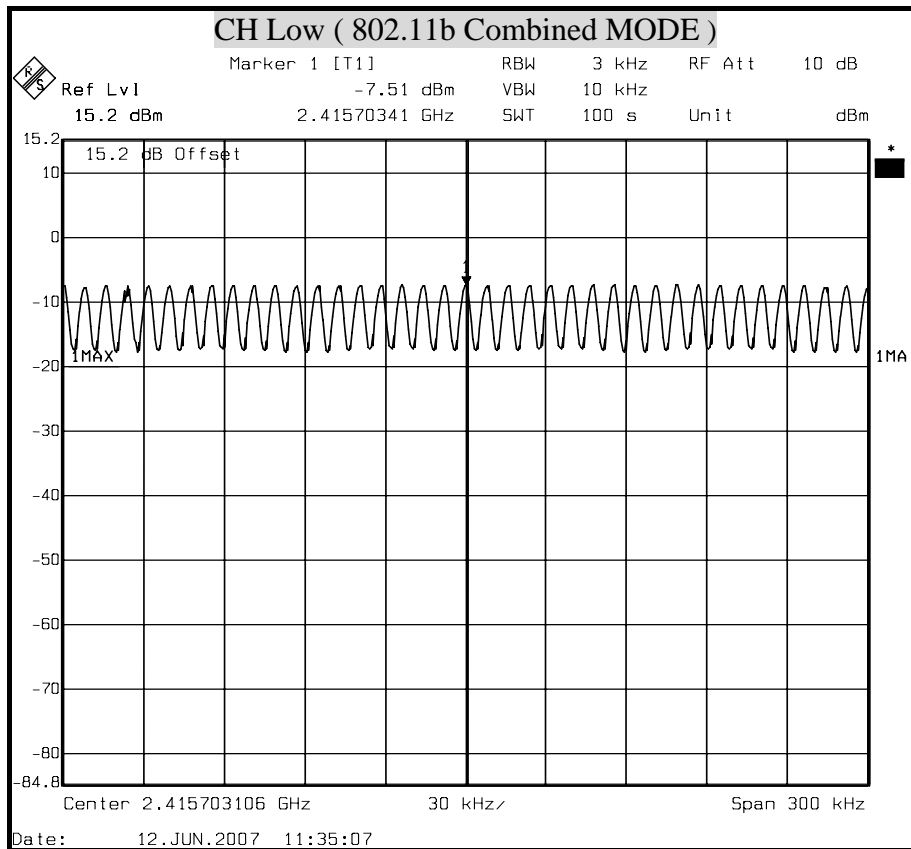

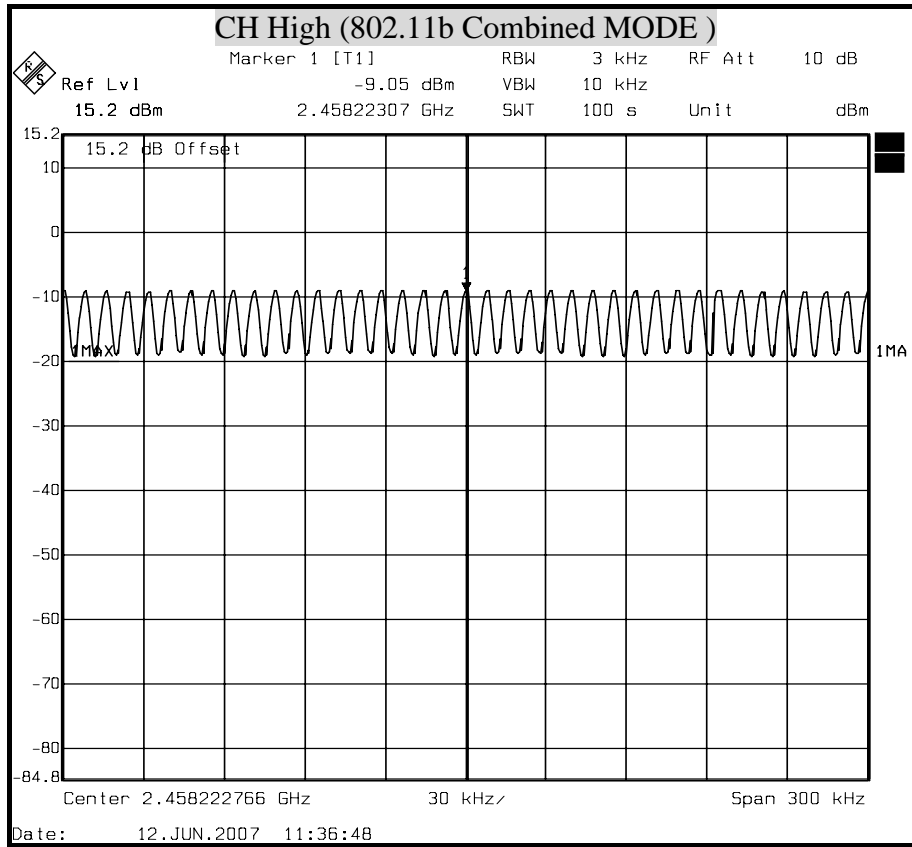



POWER SPECTRAL DENSITY (IEEE 802.11g MODE)

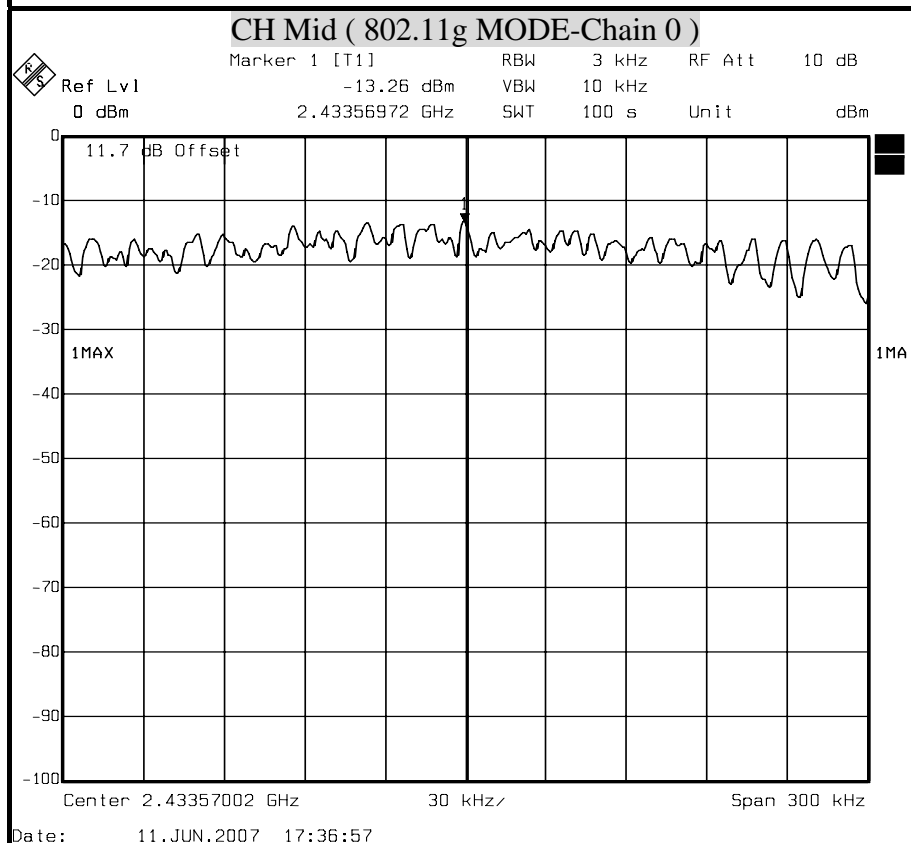
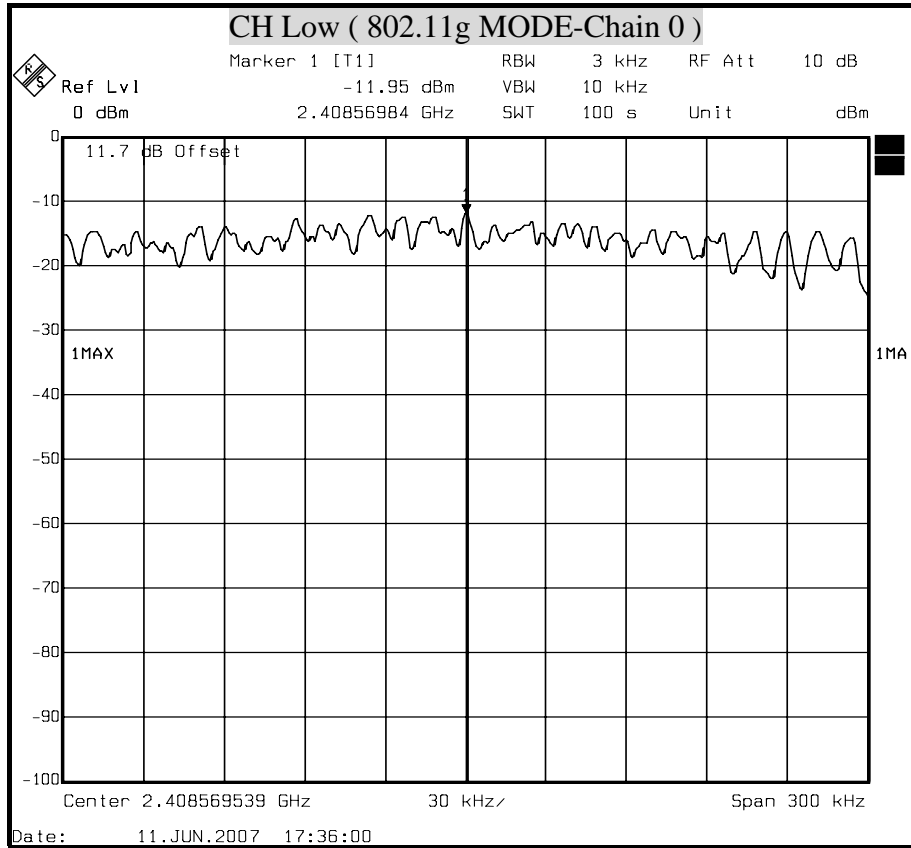

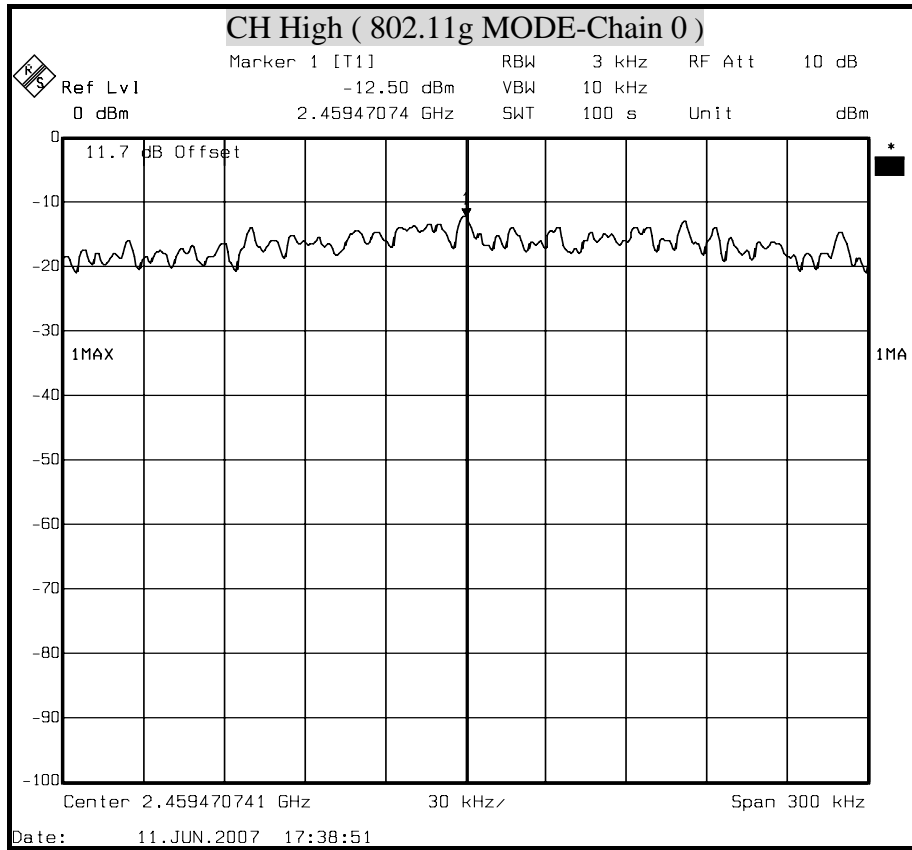

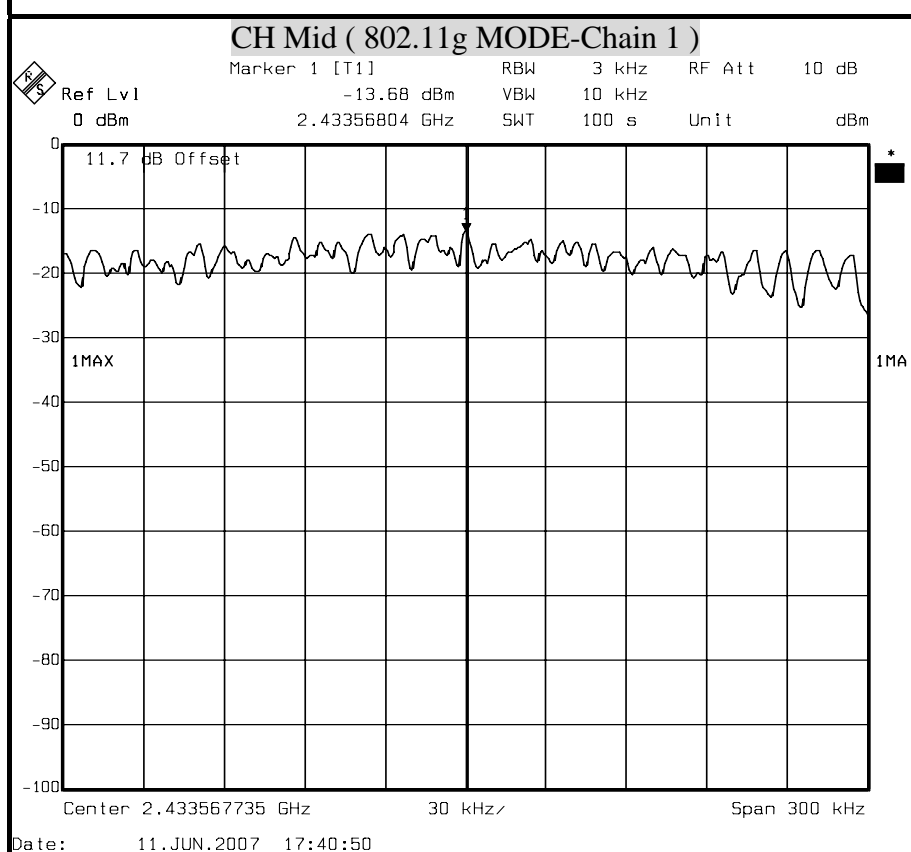
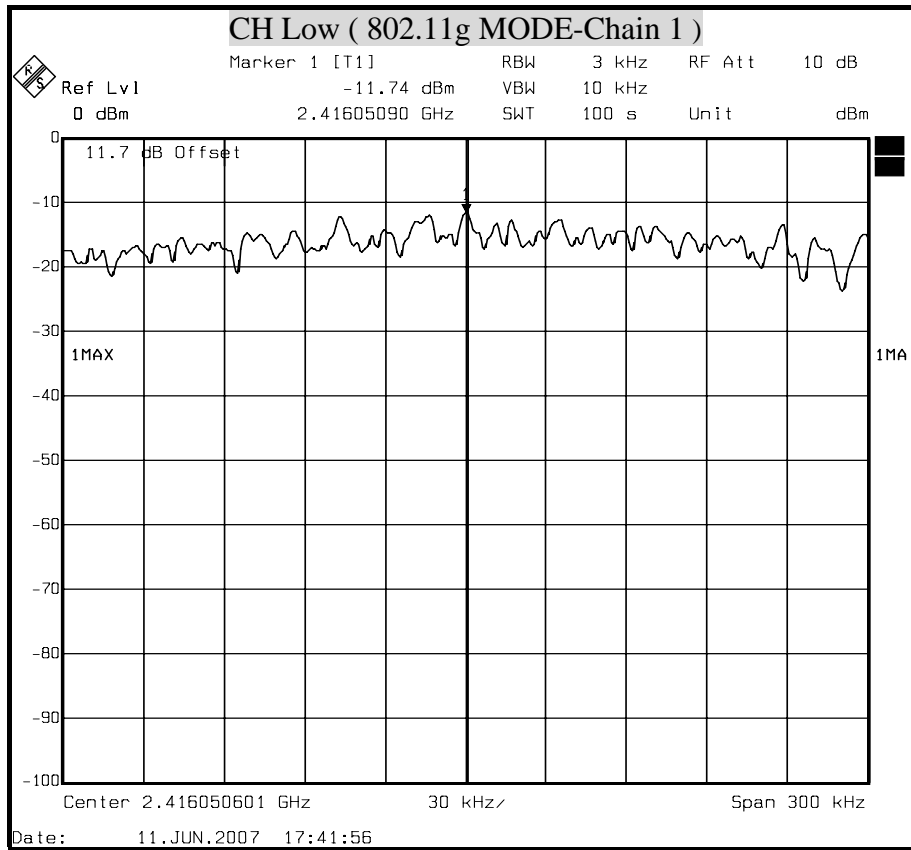

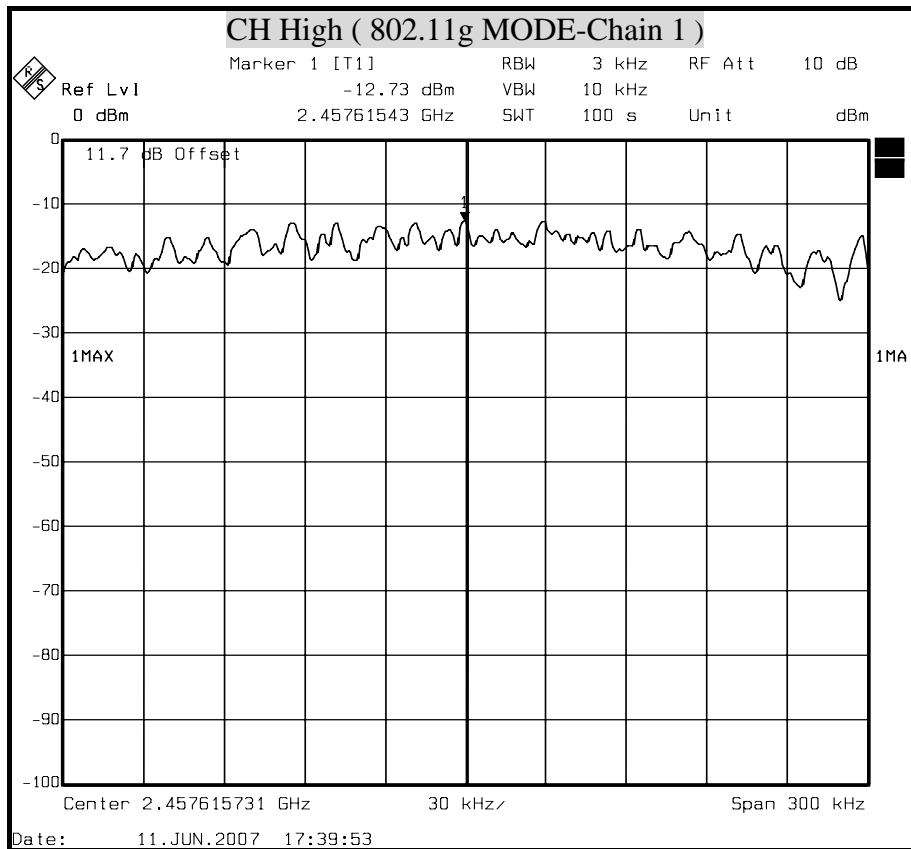

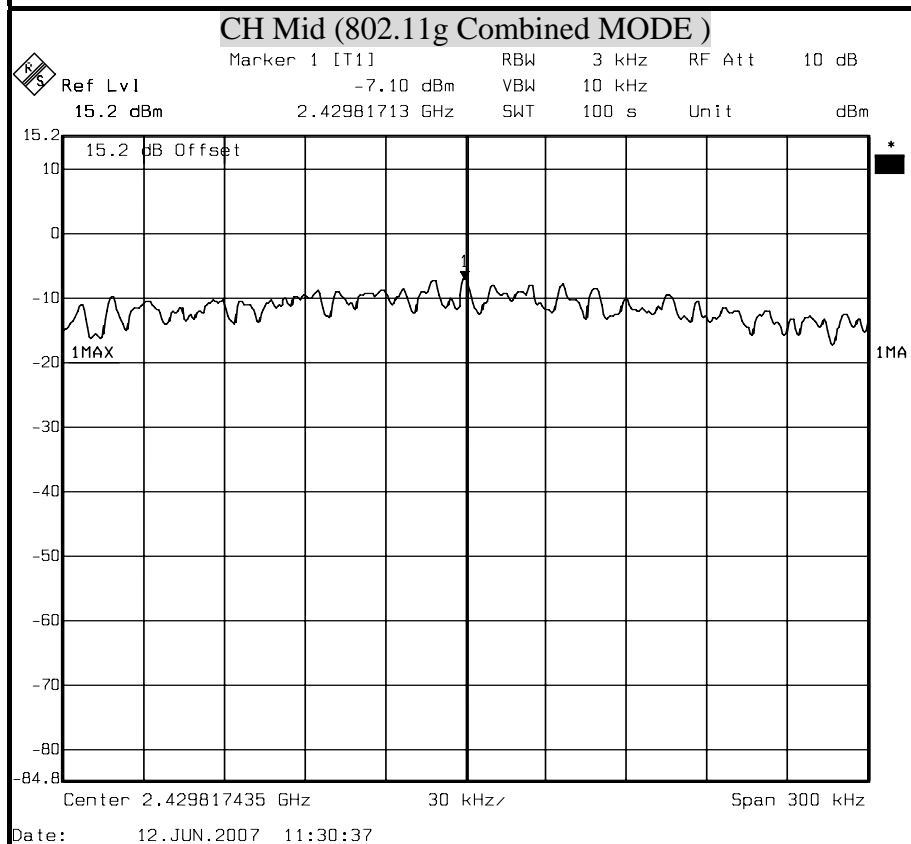
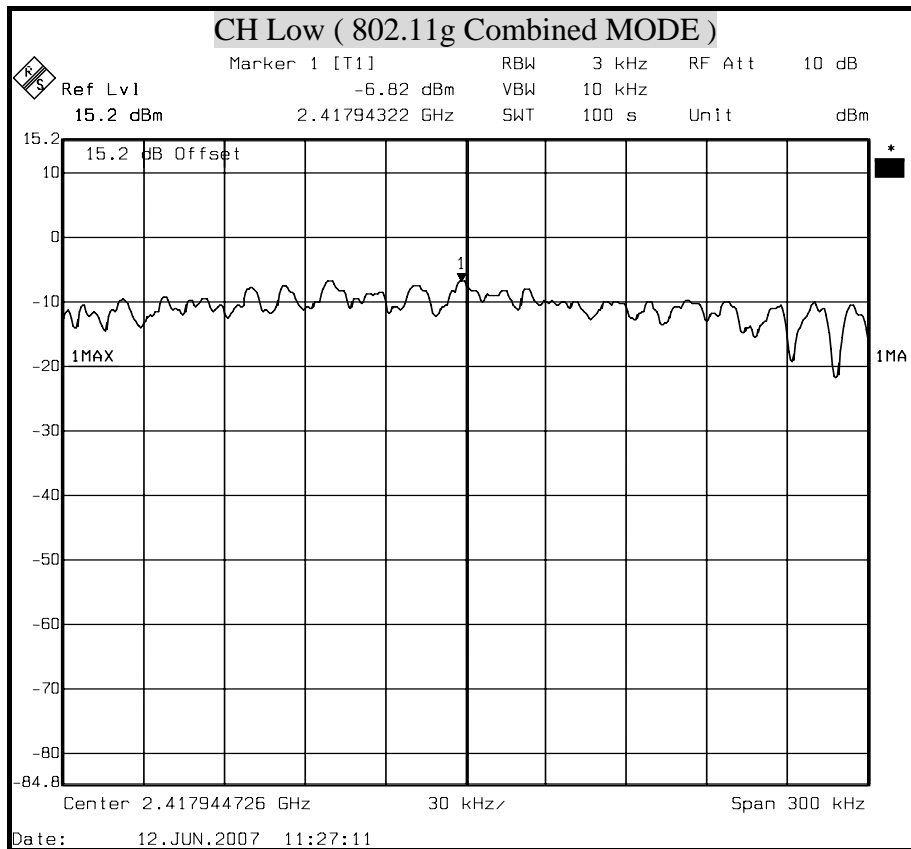

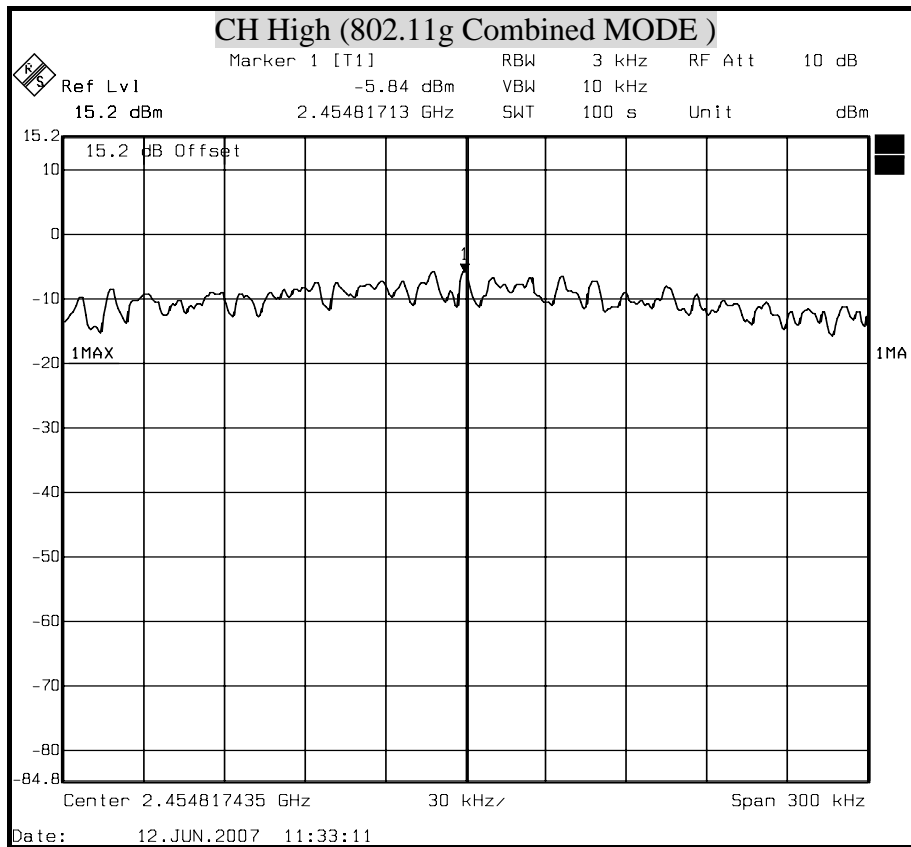



POWER SPECTRAL DENSITY (IEEE 802.11n HT20 MODE)

