



FCC TEST REPORT

REPORT NO.: RF940601L14

MODEL NO.: GN-AP01G

RECEIVED: Jun. 02, 2005

TESTED: Jun. 02 ~ 24, 2005

ISSUED: Jun. 27, 2005

APPLICANT: Giga-Byte Technology Co., Ltd.

ADDRESS: No. 6, Bau Chiang Road, Hsin-Tien, Taipei Hsien,
Taiwan R.O.C.

ISSUED BY: Advance Data Technology Corporation

LAB ADDRESS: No. 47, 14th Ling, Chia Pau Tsuen, Lin Kou Hsiang
244, Taipei Hsien, Taiwan, R.O.C.

TEST LOCATION: No. 19, Hwa Ya 2nd Rd., Wen Hwa Tsuen, Kwei
Shan Hsiang, Taoyuan Hsien 333, Taiwan, R.O.C.

This test report consists of 63 pages in total. It may be duplicated completely for legal use with the approval of the applicant. It should not be reproduced except in full, without the written approval of our laboratory. The client should not use it to claim product endorsement by CNLA, A2LA or any government agencies. The test results in the report only apply to the tested sample.



0528
ILAC MRA



No. 2177-01



TABLE OF CONTENTS

1.	CERTIFICATION	4
2.	SUMMARY OF TEST RESULTS	5
2.1	MEASUREMENT UNCERTAINTY	5
3.	GENERAL INFORMATION	6
3.1	GENERAL DESCRIPTION OF EUT	6
3.2	DESCRIPTION OF TEST MODES	7
3.2.1	CONFIGURATION OF SYSTEM UNDER TEST	7
3.2.2	TEST MODE APPLICABILITY AND TESTED CHANNEL DETAIL	8
3.2.3	GENERAL DESCRIPTION OF APPLIED STANDARDS	10
3.2.4	DESCRIPTION OF SUPPORT UNITS	10
4.	TEST TYPES AND RESULTS	11
4.1	CONDUCTED EMISSION MEASUREMENT	11
4.1.1	LIMITS OF CONDUCTED EMISSION MEASUREMENT	11
4.1.2	TEST INSTRUMENTS	11
4.1.3	TEST PROCEDURES	12
4.1.4	DEVIATION FROM TEST STANDARD	12
4.1.5	TEST SETUP	13
4.1.6	EUT OPERATING CONDITIONS	13
4.1.7	TEST RESULTS	14
4.2	RADIATED EMISSION MEASUREMENT	20
4.2.1	LIMITS OF RADIATED EMISSION MEASUREMENT	20
4.2.2	TEST INSTRUMENTS	21
4.2.3	TEST PROCEDURES	22
4.2.4	DEVIATION FROM TEST STANDARD	23
4.2.5	TEST SETUP	23
4.2.6	EUT OPERATING CONDITIONS	23
4.2.7	TEST RESULTS	24
4.3	6dB BANDWIDTH MEASUREMENT	32
4.3.1	LIMITS OF 6dB BANDWIDTH MEASUREMENT	32
4.3.2	TEST INSTRUMENTS	32
4.3.3	TEST PROCEDURE	33
4.3.4	DEVIATION FROM TEST STANDARD	33
4.3.5	TEST SETUP	33
4.3.6	EUT OPERATING CONDITIONS	33
4.3.7	TEST RESULTS	34
4.4	MAXIMUM PEAK OUTPUT POWER	40
4.4.1	LIMITS OF MAXIMUM PEAK OUTPUT POWER MEASUREMENT	40



4.4.2 INSTRUMENTS 40

4.4.3 TEST PROCEDURES 41

4.4.4 DEVIATION FROM TEST STANDARD 41

4.4.5 TEST SETUP 41

4.4.6 EUT OPERATING CONDITIONS 41

4.4.7 TEST RESULTS 42

4.5 POWER SPECTRAL DENSITY MEASUREMENT 43

4.5.1 LIMITS OF POWER SPECTRAL DENSITY MEASUREMENT 43

4.5.2 TEST INSTRUMENTS 43

4.5.3 TEST PROCEDURE 44

4.5.4 DEVIATION FROM TEST STANDARD 44

4.5.5 TEST SETUP 44

4.5.6 EUT OPERATING CONDITION 44

4.5.7 TEST RESULTS 45

4.6 BAND EDGES MEASUREMENT 51

4.6.1 LIMITS OF BAND EDGES MEASUREMENT 51

4.6.2 TEST INSTRUMENTS 51

4.6.3 TEST PROCEDURE 51

4.6.4 DEVIATION FROM TEST STANDARD 51

4.6.5 EUT OPERATING CONDITION 51

4.6.6 TEST RESULTS 52

4.7 ANTENNA REQUIREMENT 60

4.7.1 STANDARD APPLICABLE 60

4.7.2 ANTENNA CONNECTED CONSTRUCTION 60

5. PHOTOGRAPHS OF THE TEST CONFIGURATION 61

6. INFORMATION ON THE TESTING LABORATORIES 63



1. CERTIFICATION

PRODUCT: 802.11g Wireless AP
MODEL NO.: GN-AP01G
BRAND NAME: GIGABYTE
APPLICANT: Giga-Byte Technology Co., Ltd.
TESTED: Jun. 02 ~ 24, 2005
TEST SAMPLE: ENGINEERING SAMPLE
STANDARDS: FCC Part 15, Subpart C (Section 15.247),
ANSI C63.4-2003

The above equipment have been tested by **Advance Data Technology Corporation**, and found compliance with the requirement of the above standards. The test record, data evaluation & Equipment Under Test (EUT) configurations represented herein are true and accurate accounts of the measurements of the sample's EMC characteristics under the conditions specified in this report.

PREPARED BY : Rennie Wang , **DATE:** Jun. 27, 2005
Rennie Wang

TECHNICAL
ACCEPTANCE : Gary Chang , **DATE:** Jun. 27, 2005
Responsible for RF Gary Chang

APPROVED BY : Cody Chang , **DATE:** Jun. 27, 2005
Cody Chang / Deputy Manager

2. SUMMARY OF TEST RESULTS

The EUT has been tested according to the following specifications:

APPLIED STANDARD: FCC Part 15, Subpart C			
STANDARD SECTION	TEST TYPE AND LIMIT	RESULT	REMARK
15.207	AC Power Conducted Emission	PASS	Meet the requirement of limit. Minimum passing margin is -13.80dB at 0.365MHz
15.247(a)(2)	Spectrum Bandwidth of a Direct Sequence Spread Spectrum System Limit: min. 500kHz	PASS	Meet the requirement of limit.
15.247(b)	Maximum Peak Output Power Limit: max. 30dBm	PASS	Meet the requirement of limit.
15.247(d)	Radiated Emissions Limit: Table 15.209	PASS	Meet the requirement of limit. Minimum passing margin is -3.70dB at 249.66MHz
15.247(e)	Power Spectral Density Limit: max. 8dBm	PASS	Meet the requirement of limit.
15.247(d)	Band Edge Measurement Limit: 20dB less than the peak value of fundamental frequency	PASS	Meet the requirement of limit.

2.1 MEASUREMENT UNCERTAINTY

Where relevant, the following measurement uncertainty levels have been estimated for tests performed on the EUT as specified in CISPR 16-4:

MEASUREMENT	FREQUENCY	UNCERTAINTY
Conducted emissions	9kHz ~ 30MHz	2.44 dB
Radiated emissions	30MHz ~ 200MHz	3.73 dB
	200MHz ~ 1000MHz	3.74 dB
	1GHz ~ 18GHz	2.20 dB
	18GHz ~ 40GHz	1.88 dB

3. GENERAL INFORMATION

3.1 GENERAL DESCRIPTION OF EUT

EUT	802.11g Wireless AP
MODEL NO.	GN-AP01G
POWER SUPPLY	7.5Vdc from AC adapter
MODULATION TYPE	CCK, DQPSK, DBPSK for DSSS 64QAM, 16QAM, QPSK, BPSK for OFDM
RADIO TECHNOLOGY	DSSS, OFDM
TRANSFER RATE	802.11b: 11/5.5/2/1Mbps 802.11g: 54/48/36/24/18/12/9/6Mbps
FREQUENCY RANGE	2412MHz ~ 2462MHz
NUMBER OF CHANNEL	11
OUTPUT POWER	63.826mW
ANTENNA TYPE	Dipole antenna with 2dBi gain
DATA CABLE	NA
I/O PORTS	RJ45
ASSOCIATED DEVICES	NA

NOTE:

1. The EUT was tested with the following adapter:

BRAND:	OEM
MODEL:	AD-0780
INPUT:	120Vac, 60Hz, 13W
OUTPUT:	7.5Vdc, 800mA
POWER LINE:	DC 1.6m non-shielded cable without core

2. The EUT, operates in the 2.4GHz frequency range, lets you connect IEEE 802.11g or IEEE 802.11b devices to the network. With its high-speed data transmissions of up to 54Mbps.

3. The above EUT information was declared by manufacturer and for more detailed features description, please refer to the manufacturer's specifications or User's Manual.

3.2 DESCRIPTION OF TEST MODES

Eleven channels are provided to this EUT.

CHANNEL	FREQUENCY	CHANNEL	FREQUENCY
1	2412 MHz	7	2442 MHz
2	2417 MHz	8	2447 MHz
3	2422 MHz	9	2452 MHz
4	2427 MHz	10	2457 MHz
5	2432 MHz	11	2462 MHz
6	2437 MHz		

3.2.1 CONFIGURATION OF SYSTEM UNDER TEST

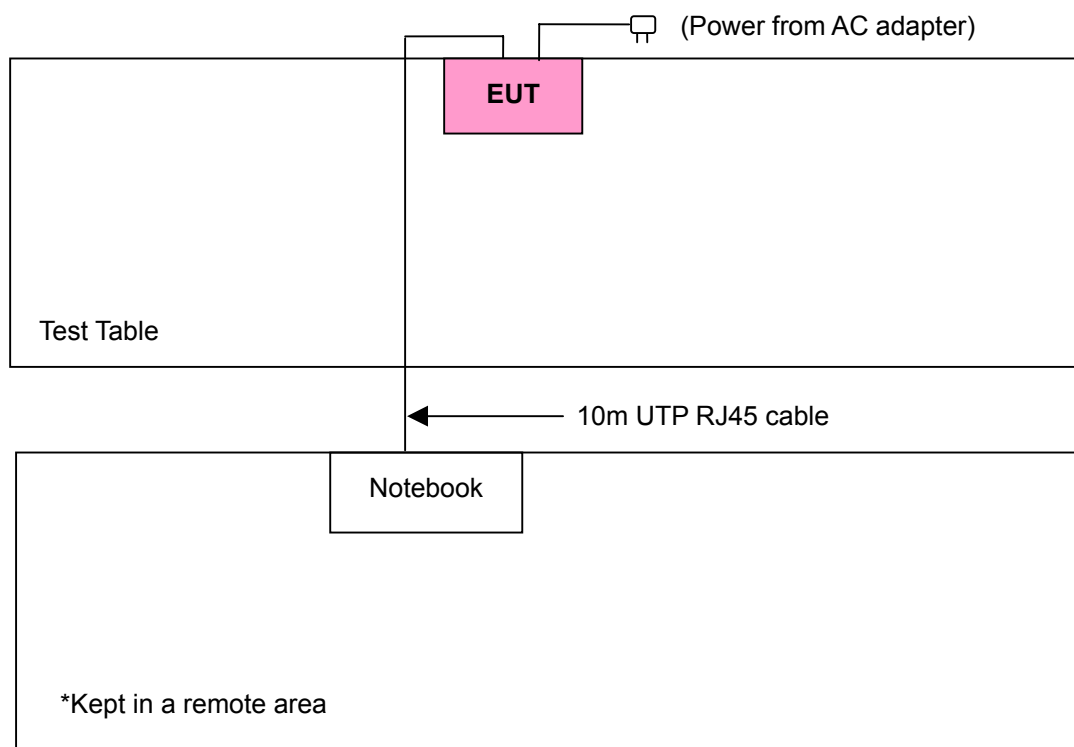



3.2.2 TEST MODE APPLICABILITY AND TESTED CHANNEL DETAIL

EUT CONFIGURE MODE	APPLICABLE TO				DESCRIPTION
	PLC	RE<1G	RE≥1G	APCM	
-	√	√	√	√	NA

Where **PLC:** Power Line Conducted Emission **RE<1G:** Radiated Emission below 1GHz
RE≥1G: Radiated Emission above 1GHz **APCM:** Antenna Port Conducted Measurement

POWER LINE CONDUCTED EMISSION TEST:

- Pre-Scan has been conducted to determine the worst-case mode from all possible combinations between available modulations, data rates and antenna ports (if EUT with antenna diversity architecture).
- Following channel(s) was (were) selected for the final test as listed below.

MODE	AVAILABLE CHANNEL	TESTED CHANNEL	MODULATION TECHNOLOGY	MODULATION TYPE	DATA RATE (Mbps)
802.11g	1 to 11	1, 6, 11	OFDM	BPSK	6

RADIATED EMISSION TEST (BELOW 1 GHz):

- Pre-Scan has been conducted to determine the worst-case mode from all possible combinations between available modulations, data rates and antenna ports (if EUT with antenna diversity architecture).
- Following channel(s) was (were) selected for the final test as listed below.

MODE	AVAILABLE CHANNEL	TESTED CHANNEL	MODULATION TECHNOLOGY	MODULATION TYPE	DATA RATE (Mbps)
802.11g	1 to 11	11	OFDM	BPSK	6

RADIATED EMISSION TEST (ABOVE 1 GHz):

- Pre-Scan has been conducted to determine the worst-case mode from all possible combinations between available modulations, data rates and antenna ports (if EUT with antenna diversity architecture).
- Following channel(s) was (were) selected for the final test as listed below.

MODE	AVAILABLE CHANNEL	TESTED CHANNEL	MODULATION TECHNOLOGY	MODULATION TYPE	DATA RATE (Mbps)
802.11b	1 to 11	1, 6, 11	DSSS	CCK	11
802.11g	1 to 11	1, 6, 11	OFDM	BPSK	6



BANDEDGE MEASUREMENT:

- Pre-Scan has been conducted to determine the worst-case mode from all possible combinations between available modulations, data rates and antenna ports (if EUT with antenna diversity architecture).
- Following channel(s) was (were) selected for the final test as listed below.

MODE	AVAILABLE CHANNEL	TESTED CHANNEL	MODULATION TECHNOLOGY	MODULATION TYPE	DATA RATE (Mbps)
802.11b	1 to 11	1, 11	DSSS	CCK	11
802.11g	1 to 11	1, 11	OFDM	BPSK	6

ANTENNA PORT CONDUCTED MEASUREMENT:

- Pre-Scan has been conducted to determine the worst-case mode from all possible combinations between available modulations, data rates and antenna ports (if EUT with antenna diversity architecture).
- Following channel(s) was (were) selected for the final test as listed below.

MODE	AVAILABLE CHANNEL	TESTED CHANNEL	MODULATION TECHNOLOGY	MODULATION TYPE	DATA RATE (Mbps)
802.11b	1 to 11	1, 6, 11	DSSS	CCK	11
802.11g	1 to 11	1, 6, 11	OFDM	BPSK	6



3.2.3 GENERAL DESCRIPTION OF APPLIED STANDARDS

The EUT is an 802.11g Wireless AP. According to the specifications of the manufacturer, it must comply with the requirements of the following standards:

FCC Part 15, Subpart C. (15.247)

ANSI C63.4- 2003

All test items have been performed and recorded as per the above standards.

NOTE: The EUT is also considered as a kind of computer peripheral, because the connection to computer is necessary for typical use. It has been verified to comply with the requirements of FCC Part 15, Subpart B, Class B (DoC). The test report has been issued separately.

3.2.4 DESCRIPTION OF SUPPORT UNITS

The EUT has been tested as an independent unit together with other necessary accessories or support units. The following support units or accessories were used to form a representative test configuration during the tests.

NO.	PRODUCT	BRAND	MODEL NO.	SERIAL NO.	FCC ID
1	NOTEBOOK COMPUTER	DELL	PP05L	12130898320	E2K24CLNS

NO.	SIGNAL CABLE DESCRIPTION OF THE ABOVE SUPPORT UNITS
1	NA

NOTE: 1. All power cords of the above support units are non shielded (1.8m).



4. TEST TYPES AND RESULTS

4.1 CONDUCTED EMISSION MEASUREMENT

4.1.1 LIMITS OF CONDUCTED EMISSION MEASUREMENT

FREQUENCY OF EMISSION (MHz)	CONDUCTED LIMIT (dB μ V)	
	Quasi-peak	Average
0.15-0.5	66 to 56	56 to 46
0.5-5	56	46
5-30	60	50

- NOTE:**
1. The lower limit shall apply at the transition frequencies.
 2. The limit decreases in line with the logarithm of the frequency in the range of 0.15 to 0.50 MHz.
 3. All emanations from a class A/B digital device or system, including any network of conductors and apparatus connected thereto, shall not exceed the level of field strengths specified above.

4.1.2 TEST INSTRUMENTS

DESCRIPTION & MANUFACTURER	MODEL NO.	SERIAL NO.	CALIBRATED UNTIL
Test Receiver ROHDE & SCHWARZ	ESCS30	100288	Nov. 06, 2005
RF signal cable Woken	5D-FB	Cable-HyC02-01	Jan. 09, 2006
LISN ROHDE & SCHWARZ	ESH2-Z5	100100	Jan. 20, 2006
LISN ROHDE & SCHWARZ	ESH3-Z5	100311	Jan. 20, 2006
Software ADT	ADT_Cond_V3	NA	NA

- NOTE:**
1. The calibration interval of the above test instruments is 12 months and the calibrations are traceable to NML/ROC and NIST/USA.
 2. The test was performed in HwaYa Shielded Room 3.
 3. The VCCI Site Registration No. is C-2047.



4.1.3 TEST PROCEDURES

- a. The EUT was placed 0.4 meters from the conducting wall of the shielded room with EUT being connected to the power mains through a line impedance stabilization network (LISN). Other support units were connected to the power mains through another LISN. The two LISNs provide 50 ohm/ 50uH of coupling impedance for the measuring instrument.
- b. Both lines of the power mains connected to the EUT were checked for maximum conducted interference.
- c. The frequency range from 150kHz to 30MHz was searched. Emission levels under (Limit - 20dB) was not recorded.

4.1.4 DEVIATION FROM TEST STANDARD

No deviation

4.1.5 TEST SETUP

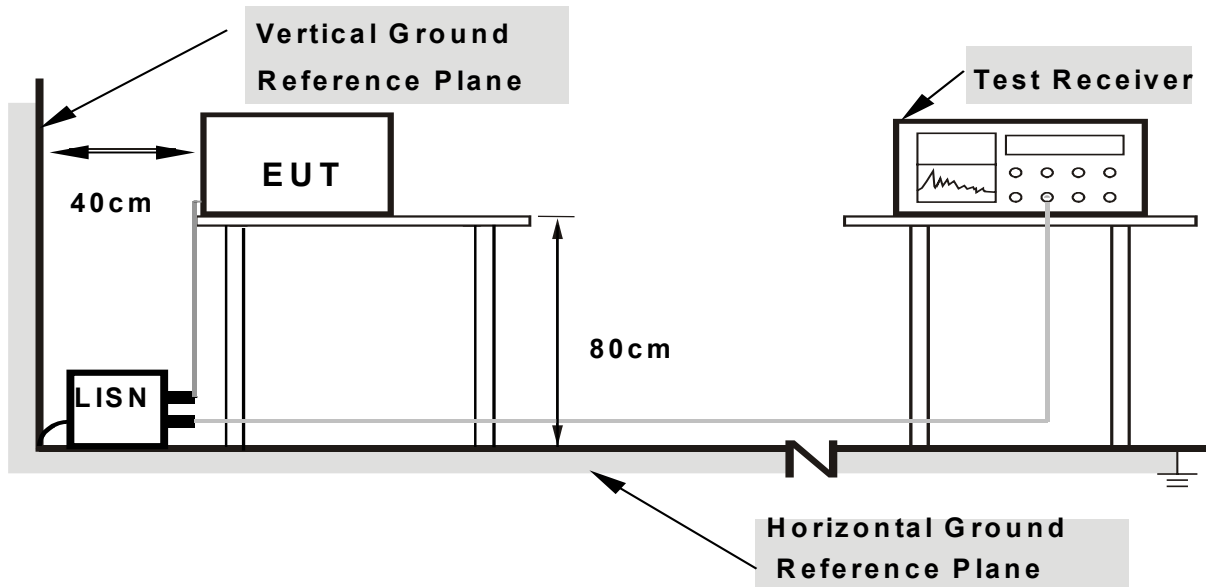

- Note:**
1. Support units were connected to second LISN.
 2. Both of LISNs (AMN) are 80 cm from EUT and at least 80 cm from other units and other metal planes

For the actual test configuration, please refer to the related item – Photographs of the Test Configuration.

4.1.6 EUT OPERATING CONDITIONS

- a. Connected the EUT to a notebook system via RJ45 cable and placed on a testing table.
- b. The notebook system ran a test program (provided by manufacturer) to enable EUT under transmission/receiving condition continuously at specific channel frequency.



4.1.7 TEST RESULTS

CONDUCTED WORST-CASE DATA

EUT	802.11g Wireless AP	MEASUREMENT DETAIL	
MODEL	GN-AP01G	PHASE	Line 1
CHANNEL	Channel 1	6dB BANDWIDTH	9 kHz
MODULATION TYPE	BPSK	ENVIRONMENTAL CONDITIONS	23deg. C, 65%RH, 991hPa
TRANSFER RATE	6Mbps	INPUT POWER (SYSTEM)	120Vac, 60 Hz
TESTED BY	Gary Chang		

No	Freq. [MHz]	Corr. Factor (dB)	Reading Value		Emission Level		Limit		Margin	
			[dB (uV)]		[dB (uV)]		[dB (uV)]		(dB)	
			Q.P.	AV.	Q.P.	AV.	Q.P.	AV.	Q.P.	AV.
1	0.154	0.10	48.24	-	48.34	-	65.79	55.79	-17.45	-
2	0.185	0.10	47.63	-	47.73	-	64.25	54.25	-16.52	-
3	0.213	0.10	46.81	-	46.91	-	63.11	53.11	-16.20	-
4	0.271	0.10	43.90	-	44.00	-	61.08	51.08	-17.08	-
5	0.357	0.10	41.49	-	41.59	-	58.80	48.80	-17.21	-
6	1.082	0.20	38.35	-	38.55	-	56.00	46.00	-17.45	-

- REMARKS:**
1. Q.P. and AV. are abbreviations of quasi-peak and average individually.
 2. "-": The Quasi-peak reading value also meets average limit and measurement with the average detector is unnecessary.
 3. The emission levels of other frequencies were very low against the limit.
 4. Margin value = Emission level - Limit value
 5. Correction factor = Insertion loss + Cable loss
 6. Emission Level = Correction Factor + Reading Value.

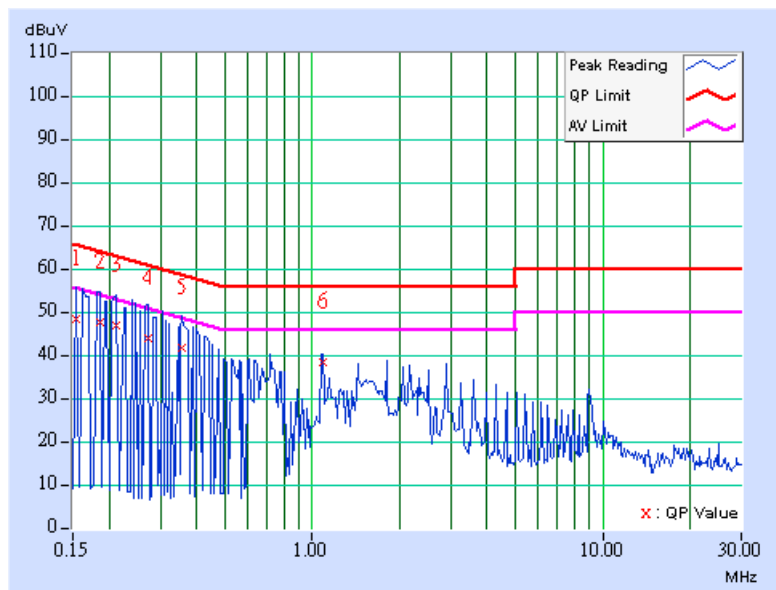



EUT	802.11g Wireless AP	MEASUREMENT DETAIL	
MODEL	GN-AP01G	PHASE	Line 2
CHANNEL	Channel 1	6dB BANDWIDTH	9 kHz
MODULATION TYPE	BPSK	ENVIRONMENTAL CONDITIONS	23deg. C, 65%RH, 991hPa
TRANSFER RATE	6Mbps	INPUT POWER (SYSTEM)	120Vac, 60 Hz
TESTED BY	Gary Chang		

No	Freq. [MHz]	Corr. Factor (dB)	Reading Value [dB (uV)]		Emission Level [dB (uV)]		Limit [dB (uV)]		Margin (dB)	
			Q.P.	AV.	Q.P.	AV.	Q.P.	AV.	Q.P.	AV.
	1	0.185	0.10	49.12	-	49.22	-	64.25	54.25	-15.03
2	0.213	0.10	47.69	-	47.79	-	63.11	53.11	-15.32	-
3	0.240	0.10	46.66	-	46.76	-	62.10	52.10	-15.34	-
4	0.365	0.10	44.72	-	44.82	-	58.62	48.62	-13.80	-
5	0.392	0.10	43.80	-	43.90	-	58.02	48.02	-14.12	-
6	1.082	0.20	38.53	-	38.73	-	56.00	46.00	-17.27	-

- REMARKS:**
1. Q.P. and AV. are abbreviations of quasi-peak and average individually.
 2. "-": The Quasi-peak reading value also meets average limit and measurement with the average detector is unnecessary.
 3. The emission levels of other frequencies were very low against the limit.
 4. Margin value = Emission level - Limit value
 5. Correction factor = Insertion loss + Cable loss
 6. Emission Level = Correction Factor + Reading Value.

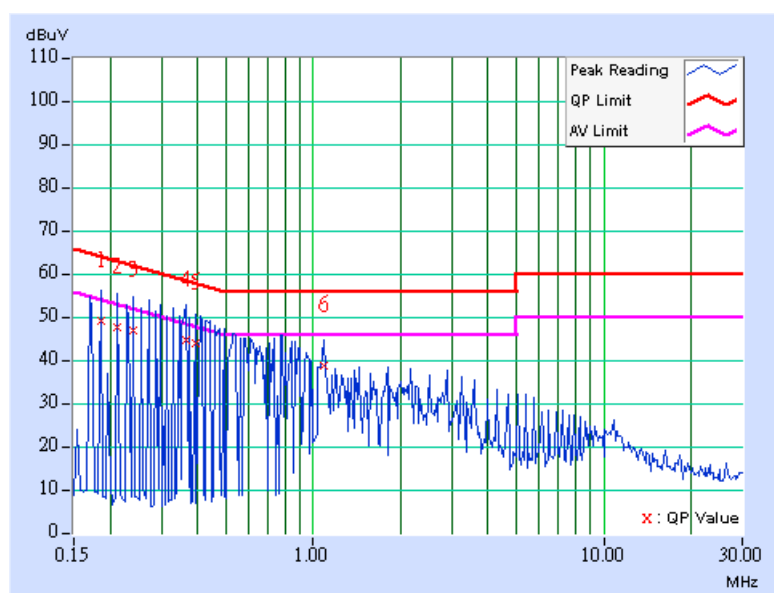



EUT	802.11g Wireless AP	MEASUREMENT DETAIL	
MODEL	GN-AP01G	PHASE	Line 1
CHANNEL	Channel 6	6dB BANDWIDTH	9 kHz
MODULATION TYPE	BPSK	ENVIRONMENTAL CONDITIONS	23deg. C, 65%RH, 991hPa
TRANSFER RATE	6Mbps	INPUT POWER (SYSTEM)	120Vac, 60 Hz
TESTED BY	Gary Chang		

No	Freq. [MHz]	Corr. Factor (dB)	Reading Value [dB (uV)]		Emission Level [dB (uV)]		Limit [dB (uV)]		Margin (dB)	
			Q.P.	AV.	Q.P.	AV.	Q.P.	AV.	Q.P.	AV.
			1	0.162	0.10	46.29	-	46.39	-	65.38
2	0.220	0.10	43.92	-	44.02	-	62.81	52.81	-18.79	-
3	0.279	0.10	40.72	-	40.82	-	60.85	50.85	-20.03	-
4	0.369	0.10	39.13	-	39.23	-	58.53	48.53	-19.30	-
5	0.623	0.14	34.93	-	35.07	-	56.00	46.00	-20.93	-
6	2.160	0.20	33.85	-	34.05	-	56.00	46.00	-21.95	-

- REMARKS:**
1. Q.P. and AV. are abbreviations of quasi-peak and average individually.
 2. "-": The Quasi-peak reading value also meets average limit and measurement with the average detector is unnecessary.
 3. The emission levels of other frequencies were very low against the limit.
 4. Margin value = Emission level - Limit value
 5. Correction factor = Insertion loss + Cable loss
 6. Emission Level = Correction Factor + Reading Value.

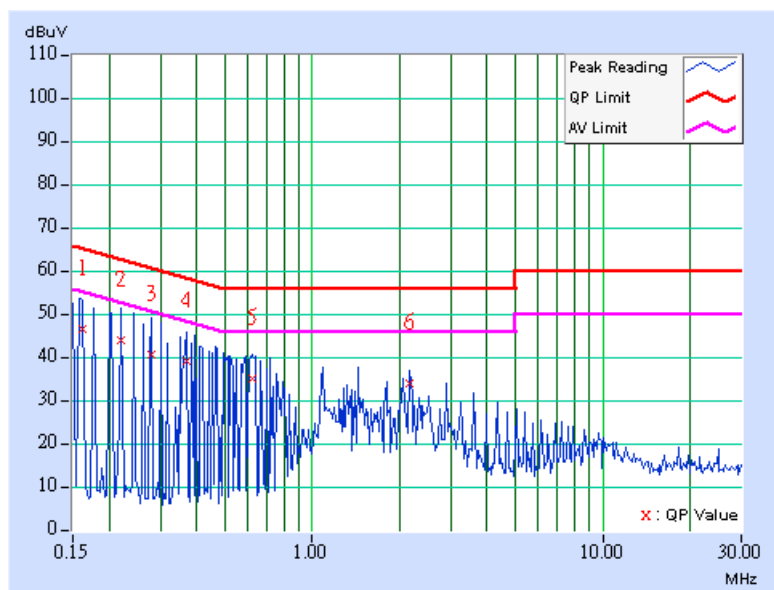



EUT	802.11g Wireless AP	MEASUREMENT DETAIL	
MODEL	GN-AP01G	PHASE	Line 2
CHANNEL	Channel 6	6dB BANDWIDTH	9 kHz
MODULATION TYPE	BPSK	ENVIRONMENTAL CONDITIONS	23deg. C, 65%RH, 991hPa
TRANSFER RATE	6Mbps	INPUT POWER (SYSTEM)	120Vac, 60 Hz
TESTED BY	Gary Chang		

No	Freq. [MHz]	Corr. Factor [dB]	Reading Value [dB (uV)]		Emission Level [dB (uV)]		Limit [dB (uV)]		Margin (dB)	
			Q.P.	AV.	Q.P.	AV.	Q.P.	AV.	Q.P.	AV.
			1	0.150	0.10	47.04	-	47.14	-	66.00
2	0.158	0.10	46.99	-	47.09	-	65.58	55.58	-18.49	-
3	0.360	0.10	43.62	-	43.72	-	58.73	48.73	-15.01	-
4	0.396	0.10	42.16	-	42.26	-	57.93	47.93	-15.67	-
5	0.447	0.11	42.03	-	42.14	-	56.93	46.93	-14.80	-
6	0.716	0.15	39.29	-	39.44	-	56.00	46.00	-16.56	-

- REMARKS:**
1. Q.P. and AV. are abbreviations of quasi-peak and average individually.
 2. "-": The Quasi-peak reading value also meets average limit and measurement with the average detector is unnecessary.
 3. The emission levels of other frequencies were very low against the limit.
 4. Margin value = Emission level - Limit value
 5. Correction factor = Insertion loss + Cable loss
 6. Emission Level = Correction Factor + Reading Value.

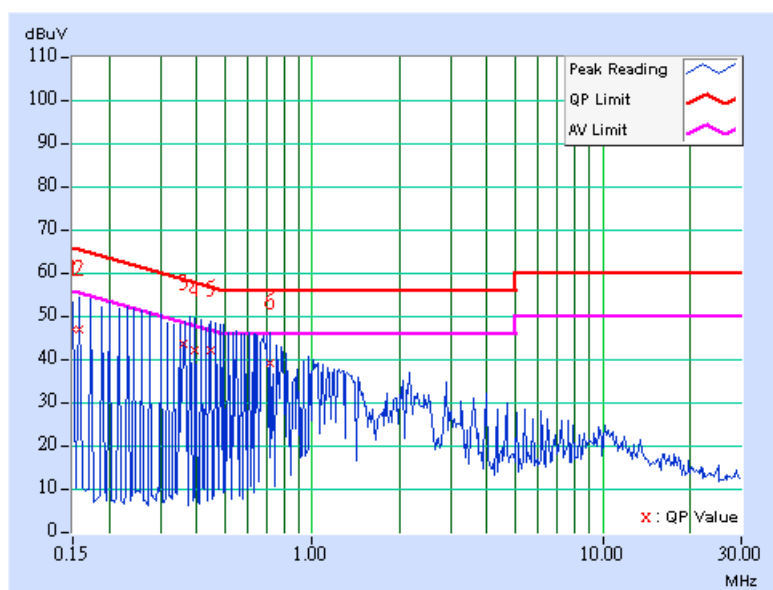



EUT	802.11g Wireless AP	MEASUREMENT DETAIL	
MODEL	GN-AP01G	PHASE	Line 1
CHANNEL	Channel 11	6dB BANDWIDTH	9 kHz
MODULATION TYPE	BPSK	ENVIRONMENTAL CONDITIONS	23deg. C, 65%RH, 991hPa
TRANSFER RATE	6Mbps	INPUT POWER (SYSTEM)	120Vac, 60 Hz
TESTED BY	Gary Chang		

No	Freq. [MHz]	Corr. Factor (dB)	Reading Value [dB (uV)]		Emission Level [dB (uV)]		Limit [dB (uV)]		Margin (dB)	
			Q.P.	AV.	Q.P.	AV.	Q.P.	AV.	Q.P.	AV.
			1	0.150	0.10	47.65	-	47.75	-	66.00
2	0.236	0.10	44.73	-	44.83	-	62.24	52.24	-17.41	-
3	0.295	0.10	42.05	-	42.15	-	60.40	50.40	-18.25	-
4	0.380	0.10	39.25	-	39.35	-	58.27	48.27	-18.92	-
5	1.082	0.20	38.70	-	38.90	-	56.00	46.00	-17.10	-
6	1.801	0.20	38.19	-	38.39	-	56.00	46.00	-17.61	-

- REMARKS:**
1. Q.P. and AV. are abbreviations of quasi-peak and average individually.
 2. "-": The Quasi-peak reading value also meets average limit and measurement with the average detector is unnecessary.
 3. The emission levels of other frequencies were very low against the limit.
 4. Margin value = Emission level - Limit value
 5. Correction factor = Insertion loss + Cable loss
 6. Emission Level = Correction Factor + Reading Value.

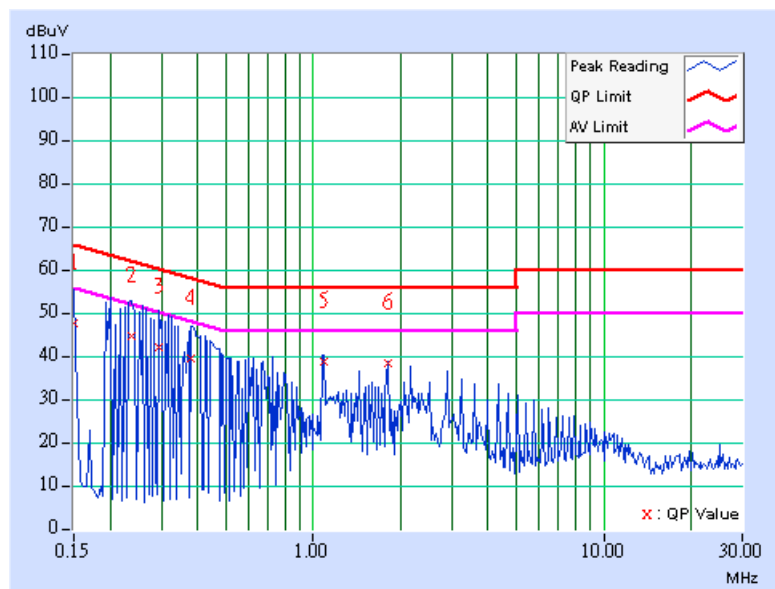



EUT	802.11g Wireless AP	MEASUREMENT DETAIL	
MODEL	GN-AP01G	PHASE	Line 2
CHANNEL	Channel 11	6dB BANDWIDTH	9 kHz
MODULATION TYPE	BPSK	ENVIRONMENTAL CONDITIONS	23deg. C, 65%RH, 991hPa
TRANSFER RATE	6Mbps	INPUT POWER (SYSTEM)	120Vac, 60 Hz
TESTED BY	Gary Chang		

No	Freq. [MHz]	Corr. Factor (dB)	Reading Value [dB (uV)]		Emission Level [dB (uV)]		Limit [dB (uV)]		Margin (dB)	
			Q.P.	AV.	Q.P.	AV.	Q.P.	AV.	Q.P.	AV.
	1	0.158	0.10	48.63	-	48.73	-	65.58	55.58	-16.85
2	0.173	0.10	48.44	-	48.54	-	64.79	54.79	-16.25	-
3	0.205	0.10	47.58	-	47.68	-	63.42	53.42	-15.74	-
4	0.259	0.10	45.67	-	45.77	-	61.45	51.45	-15.68	-
5	0.322	0.10	44.00	-	44.10	-	59.66	49.66	-15.56	-
6	0.838	0.17	35.11	-	35.28	-	56.00	46.00	-20.72	-

- REMARKS:**
1. Q.P. and AV. are abbreviations of quasi-peak and average individually.
 2. "-": The Quasi-peak reading value also meets average limit and measurement with the average detector is unnecessary.
 3. The emission levels of other frequencies were very low against the limit.
 4. Margin value = Emission level - Limit value
 5. Correction factor = Insertion loss + Cable loss
 6. Emission Level = Correction Factor + Reading Value.

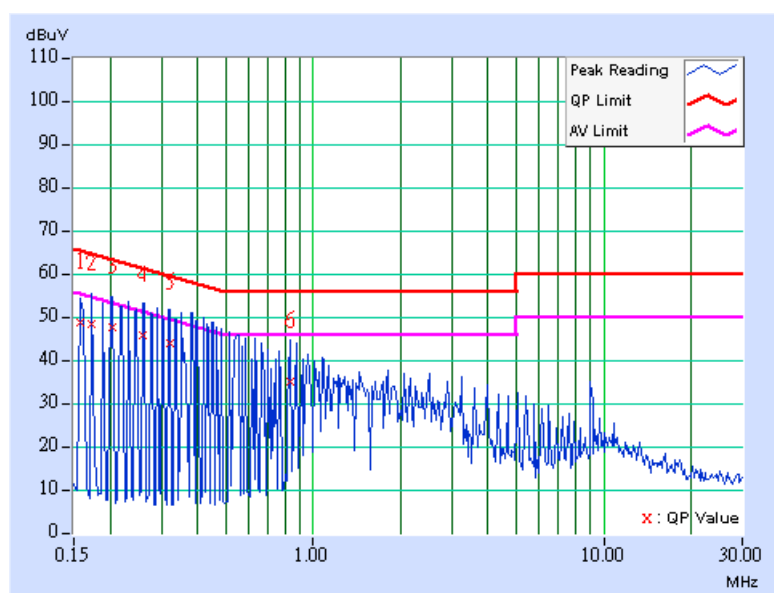



4.2 RADIATED EMISSION MEASUREMENT

4.2.1 LIMITS OF RADIATED EMISSION MEASUREMENT

Emissions radiated outside of the specified bands, shall be according to the general radiated limits in 15.209 as following:

FREQUENCIES (MHz)	FIELD STRENGTH (microvolts/meter)	MEASUREMENT DISTANCE (meters)
0.009 ~ 0.490	2400/F(kHz)	300
0.490 ~ 1.705	24000/F(kHz)	30
1.705 ~ 30.0	30	30
30 ~ 88	100	3
88 ~ 216	150	3
216 ~ 960	200	3
Above 960	500	3

NOTE:

1. The lower limit shall apply at the transition frequencies.
2. Emission level (dBuV/m) = 20 log Emission level (uV/m).
3. As shown in 15.35(b), for frequencies above 1000MHz, the field strength limits are based on average detector, however, the peak field strength of any emission shall not exceed the maximum permitted average limits, specified above by more than 20dB under any condition of modulation.



4.2.2 TEST INSTRUMENTS

DESCRIPTION & MANUFACTURER	MODEL NO.	SERIAL NO.	CALIBRATED UNTIL
Test Receiver ROHDE & SCHWARZ	ESI7	100033	May. 19, 2006
Spectrum Analyzer ROHDE & SCHWARZ	FSP40	100039	Nov. 21, 2006
BILOG Antenna SCHWARZBECK	VULB9168	9168-160	Jun. 01, 2006
HORN Antenna SCHWARZBECK	9120D	9120D-408	Jan. 17, 2006
HORN Antenna SCHWARZBECK	BBHA 9170	BBHA9170243	Jan. 23, 2006
Preamplifier Agilent	8447D	2944A10633	Nov. 09, 2005
Preamplifier Agilent	8449B	3008A01964	Nov. 06, 2005
RF signal cable HUBER+SUHNNER	SUCOFLEX 104	218183/4	Jan. 26, 2006
RF signal cable HUBER+SUHNNER	SUCOFLEX 104	218195/4	Jan. 26, 2006
Software ADT.	ADT_Radiated_V5.14	NA	NA
Antenna Tower inn-co GmbH	MA 4000	013303	NA
Antenna Tower Controller inn-co GmbH	CO2000	017303	NA
Turn Table ADT.	TT100.	TT93021703	NA
Turn Table Controller ADT.	SC100.	SC93021703	NA

- NOTE:**
1. The calibration interval of the above test instruments is 12 months and the calibrations are traceable to NML/ROC and NIST/USA.
 2. The test was performed in HwaYa Chamber 2.
 3. The horn antenna and HP preamplifier (model: 8449B) are used only for the measurement of emission frequency above 1GHz if tested.
 4. The VCCI Site Registration No. is R-237.
 5. The IC Site Registration No. is IC4924-3.



4.2.3 TEST PROCEDURES

- a. The EUT was placed on the top of a rotating table 0.8 meters above the ground at a 3 meter semi-anechoic chamber. The table was rotated 360 degrees to determine the position of the highest radiation.
- b. The EUT was set 3 meters away from the interference-receiving antenna, which was mounted on the top of a variable-height antenna tower.
- c. The antenna is a broadband antenna, and its height is varied from one meter to four meters above the ground to determine the maximum value of the field strength. Both horizontal and vertical polarizations of the antenna are set to make the measurement.
- d. For each suspected emission, the EUT was arranged to its worst case and then the antenna was tuned to heights from 1 meter to 4 meters and the rotatable table was turned from 0 degrees to 360 degrees to find the maximum reading.
- e. The test-receiver system was set to Peak Detect Function and Specified Bandwidth with Maximum Hold Mode.
- f. If the emission level of the EUT in peak mode was lower than the limit specified, then testing could be stopped and the peak values of the EUT would be reported. Otherwise the emissions would be re-tested one by one using peak, quasi-peak method or average method as specified and then reported in data sheet.

NOTE:

1. The resolution bandwidth and video bandwidth of test receiver/spectrum analyzer is 120kHz for Quasi-peak detection at frequency below 1GHz.
2. The resolution bandwidth and video bandwidth of test receiver/spectrum analyzer is 1 MHz for Peak detection (PK) at frequency above 1GHz.
3. The resolution bandwidth of test receiver/spectrum analyzer is 1 MHz and the video bandwidth is 10 Hz for Average detection (AV) at frequency above 1GHz.

4.2.4 DEVIATION FROM TEST STANDARD

No deviation

4.2.5 TEST SETUP

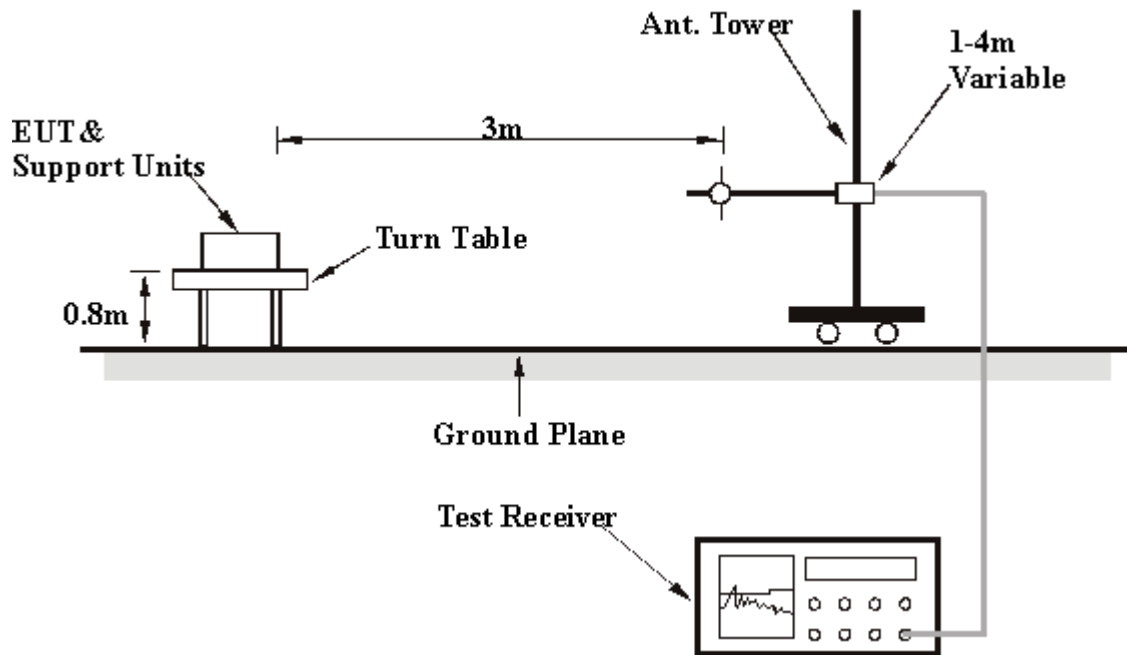

For the actual test configuration, please refer to the related item – Photographs of the Test Configuration.

4.2.6 EUT OPERATING CONDITIONS

Same as 4.1.6



4.2.7 TEST RESULTS

RADIATED WORST-CASE DATA: BELOW 1GHZ

EUT	802.11g Wireless AP	MEASUREMENT DETAIL	
MODEL	GN-AP01G	FREQUENCY RANGE	Below 1000MHz
CHANNEL	Channel 11	DETECTOR FUNCTION	Quasi-Peak
MODULATION TYPE	BPSK	ENVIRONMENTAL CONDITIONS	23deg. C, 68%RH, 991hPa
TRANSFER RATE	6Mbps	INPUT POWER (SYSTEM)	120Vac, 60 Hz
TESTED BY	Morgan Chen		

ANTENNA POLARITY & TEST DISTANCE: HORIZONTAL AT 3 M								
No.	Freq. (MHz)	Emission Level (dBuV/m)	Limit (dBuV/m)	Margin (dB)	Antenna Height (m)	Table Angle (Degree)	Raw Value (dBuV)	Correction Factor (dB/m)
1	113.59	32.07 QP	43.50	-11.43	3.00 H	244	19.37	12.70
2	199.12	36.20 QP	43.50	-7.30	1.25 H	49	24.27	11.93
3	249.66	42.30 QP	46.00	-3.70	1.25 H	223	28.66	13.64
4	300.20	34.12 QP	46.00	-11.88	1.00 H	16	19.08	15.04
5	500.42	37.40 QP	46.00	-8.60	1.75 H	349	18.12	19.28
6	751.18	34.29 QP	46.00	-11.71	1.00 H	10	10.00	24.29
7	850.32	34.40 QP	46.00	-11.60	1.50 H	40	9.39	25.01
8	900.86	34.59 QP	46.00	-11.41	1.25 H	22	8.68	25.91

- REMARKS:**
1. Emission level (dBuV/m) = Raw Value (dBuV) + Correction Factor (dB/m).
 2. Correction Factor (dB/m) = Antenna Factor (dB/m) + Cable Factor (dB).
 3. The other emission levels were very low against the limit.
 4. Margin value = Emission level – Limit value.



EUT	802.11g Wireless AP	MEASUREMENT DETAIL	
MODEL	GN-AP01G	FREQUENCY RANGE	Below 1000MHz
CHANNEL	Channel 11	DETECTOR FUNCTION	Quasi-Peak
MODULATION TYPE	BPSK	ENVIRONMENTAL CONDITIONS	23deg. C, 68%RH, 991hPa
TRANSFER RATE	6Mbps	INPUT POWER (SYSTEM)	120Vac, 60 Hz
TESTED BY	Morgan Chen		

ANTENNA POLARITY & TEST DISTANCE: VERTICAL AT 3 M								
No.	Freq. (MHz)	Emission Level (dBuV/m)	Limit (dBuV/m)	Margin (dB)	Antenna Height (m)	Table Angle (Degree)	Raw Value (dBuV)	Correction Factor (dB/m)
1	57.21	35.40 QP	40.00	-4.60	1.00 V	214	21.10	14.30
2	99.98	31.00 QP	43.50	-12.50	1.00 V	319	19.71	11.29
3	142.75	32.71 QP	43.50	-10.79	1.00 V	100	17.90	14.81
4	199.12	30.31 QP	43.50	-13.19	1.00 V	175	18.38	11.93
5	249.66	35.99 QP	46.00	-10.01	1.00 V	133	22.34	13.64
6	300.20	34.02 QP	46.00	-11.98	1.50 V	274	18.99	15.04
7	397.39	32.26 QP	46.00	-13.74	1.25 V	133	15.08	17.18
8	500.42	39.78 QP	46.00	-6.22	1.00 V	109	20.50	19.28
9	599.56	32.98 QP	46.00	-13.02	1.75 V	73	11.30	21.68
10	850.32	33.84 QP	46.00	-12.16	1.25 V	40	8.83	25.01
11	900.86	35.95 QP	46.00	-10.05	1.00 V	55	10.04	25.91

- REMARKS:**
1. Emission level (dBuV/m) = Raw Value (dBuV) + Correction Factor (dB/m).
 2. Correction Factor (dB/m) = Antenna Factor (dB/m) + Cable Factor (dB).
 3. The other emission levels were very low against the limit.
 4. Margin value = Emission level – Limit value.



802.11b DSSS MODULATION

EUT	802.11g Wireless AP	MEASUREMENT DETAIL	
MODEL	GN-AP01G	FREQUENCY RANGE	1 ~ 25GHz
CHANNEL	Channel 1	DETECTOR FUNCTION	Peak (PK) Average (AV)
MODULATION TYPE	CCK	ENVIRONMENTAL CONDITIONS	23deg. C, 65%RH, 991hPa
TRANSFER RATE	11Mbps	INPUT POWER (SYSTEM)	120Vac, 60 Hz
TESTED BY	Morgan Chen		

ANTENNA POLARITY & TEST DISTANCE: HORIZONTAL AT 3 M

No.	Freq. (MHz)	Emission Level (dBuV/m)	Limit (dBuV/m)	Margin (dB)	Antenna Height (m)	Table Angle (Degree)	Raw Value (dBuV)	Correction Factor (dB/m)
1	2038.00	47.73 PK	74.00	-26.27	1.00 H	332	17.84	29.89
1	2038.00	44.65 AV	54.00	-9.35	1.00 H	332	14.76	29.89
2	2390.00	37.73 PK	74.00	-36.27	1.10 H	25	6.41	31.32
2	2390.00	29.00 AV	54.00	-25.00	1.10 H	25	-2.32	31.32
3	*2412.00	98.98 PK			1.10 H	25	67.57	31.41
3	*2412.00	90.25 AV			1.10 H	25	58.84	31.41
4	4076.00	48.35 PK	74.00	-25.65	1.05 H	32	13.48	34.87
5	4824.00	49.56 PK	74.00	-24.44	1.00 H	47	12.75	36.81
5	4824.00	35.68 AV	54.00	-18.32	1.00 H	47	-1.13	36.81

ANTENNA POLARITY & TEST DISTANCE: VERTICAL AT 3 M

No.	Freq. (MHz)	Emission Level (dBuV/m)	Limit (dBuV/m)	Margin (dB)	Antenna Height (m)	Table Angle (Degree)	Raw Value (dBuV)	Correction Factor (dB/m)
1	2038.00	44.73 PK	74.00	-29.27	1.00 V	241	14.84	29.89
1	2038.00	39.85 AV	54.00	-14.15	1.00 V	241	9.96	29.89
2	2390.00	47.72 PK	74.00	-26.28	1.27 V	2	16.40	31.32
2	2390.00	40.23 AV	54.00	-13.77	1.27 V	2	8.91	31.32
3	*2412.00	108.97 PK			1.27 V	2	77.56	31.41
3	*2412.00	101.48 AV			1.27 V	2	70.07	31.41
4	4076.00	50.54 PK	74.00	-23.46	1.00 V	100	15.67	34.87
4	4076.00	46.83 AV	54.00	-7.17	1.00 V	100	11.96	34.87
5	4824.00	50.01 PK	74.00	-23.99	1.00 V	353	13.20	36.81
5	4824.00	35.97 AV	54.00	-18.03	1.00 V	353	-0.84	36.81

- REMARKS:**
1. Emission level (dBuV/m) = Raw Value (dBuV) + Correction Factor (dB/m).
 2. Correction Factor (dB/m) = Antenna Factor (dB/m) + Cable Factor (dB).
 3. The other emission levels were very low against the limit.
 4. Margin value = Emission level – Limit value.
 5. “ * “: Fundamental frequency.



EUT	802.11g Wireless AP	MEASUREMENT DETAIL	
MODEL	GN-AP01G	FREQUENCY RANGE	1 ~ 25GHz
CHANNEL	Channel 6	DETECTOR FUNCTION	Peak (PK) Average (AV)
MODULATION TYPE	CCK	ENVIRONMENTAL CONDITIONS	23deg. C, 65%RH, 991hPa
TRANSFER RATE	11Mbps	INPUT POWER (SYSTEM)	120Vac, 60 Hz
TESTED BY	Morgan Chen		

ANTENNA POLARITY & TEST DISTANCE: HORIZONTAL AT 3 M

No.	Freq. (MHz)	Emission Level (dBuV/m)	Limit (dBuV/m)	Margin (dB)	Antenna Height (m)	Table Angle (Degree)	Raw Value (dBuV)	Correction Factor (dB/m)
1	2063.00	42.25 PK	74.00	-31.75	1.18 H	34	12.25	30.00
2	*2437.00	102.05 PK			1.18 H	36	70.42	31.63
2	*2437.00	94.08 AV			1.18 H	36	62.45	31.63
3	4126.00	49.12 PK	74.00	-24.88	1.21 H	37	14.12	35.00
4	4874.00	52.56 PK	74.00	-21.44	1.13 H	329	15.61	36.95
4	4874.00	39.05 AV	54.00	-14.95	1.13 H	329	2.10	36.95

ANTENNA POLARITY & TEST DISTANCE: VERTICAL AT 3 M

No.	Freq. (MHz)	Emission Level (dBuV/m)	Limit (dBuV/m)	Margin (dB)	Antenna Height (m)	Table Angle (Degree)	Raw Value (dBuV)	Correction Factor (dB/m)
1	2063.00	45.63 PK	74.00	-28.37	1.10 V	324	15.63	30.00
2	*2437.00	110.10 PK			1.00 V	19	78.47	31.63
2	*2437.00	102.56 AV			1.00 V	19	70.93	31.63
3	4126.00	51.36 PK	74.00	-22.64	1.08 V	19	16.36	35.00
3	4126.00	47.29 AV	54.00	-6.71	1.08 V	19	12.29	35.00
4	4874.00	52.78 PK	74.00	-21.22	1.09 V	37	15.83	36.95
4	4874.00	39.28 AV	54.00	-14.72	1.09 V	37	2.33	36.95

- REMARKS:**
1. Emission level (dBuV/m) = Raw Value (dBuV) + Correction Factor (dB/m).
 2. Correction Factor (dB/m) = Antenna Factor (dB/m) + Cable Factor (dB).
 3. The other emission levels were very low against the limit.
 4. Margin value = Emission level – Limit value.
 5. “ * “: Fundamental frequency.



EUT	802.11g Wireless AP	MEASUREMENT DETAIL	
MODEL	GN-AP01G	FREQUENCY RANGE	1 ~ 25GHz
CHANNEL	Channel 11	DETECTOR FUNCTION	Peak (PK) Average (AV)
MODULATION TYPE	CCK	ENVIRONMENTAL CONDITIONS	23deg. C, 65%RH, 991hPa
TRANSFER RATE	11Mbps	INPUT POWER (SYSTEM)	120Vac, 60 Hz
TESTED BY	Morgan Chen		

ANTENNA POLARITY & TEST DISTANCE: HORIZONTAL AT 3 M

No.	Freq. (MHz)	Emission Level (dBuV/m)	Limit (dBuV/m)	Margin (dB)	Antenna Height (m)	Table Angle (Degree)	Raw Value (dBuV)	Correction Factor (dB/m)
1	2088.00	47.25 PK	74.00	-26.75	1.10 H	18	17.14	30.11
2	*2462.00	99.81 PK			1.03 H	16	68.18	31.63
2	*2462.00	91.54 AV			1.03 H	16	59.91	31.63
3	2483.50	42.33 PK	74.00	-31.67	1.03 H	16	10.61	31.72
3	2483.50	34.06 AV	54.00	-19.94	1.03 H	16	2.34	31.72
4	4176.00	50.32 PK	74.00	-23.68	1.20 H	32	15.25	35.07
5	4924.00	52.02 PK	74.00	-21.98	1.10 H	11	14.92	37.10
5	4924.00	38.79 AV	54.00	-15.21	1.10 H	11	1.69	37.10

ANTENNA POLARITY & TEST DISTANCE: VERTICAL AT 3 M

No.	Freq. (MHz)	Emission Level (dBuV/m)	Limit (dBuV/m)	Margin (dB)	Antenna Height (m)	Table Angle (Degree)	Raw Value (dBuV)	Correction Factor (dB/m)
1	2088.00	45.36 PK	74.00	-28.64	1.02 V	311	15.25	30.11
2	*2462.00	109.70 PK			1.00 V	9	78.07	31.63
2	*2462.00	102.06 AV			1.00 V	9	70.43	31.63
3	2483.50	52.22 PK	74.00	-21.78	1.00 V	9	20.50	31.72
3	2483.50	44.58 AV	54.00	-9.42	1.00 V	9	12.86	31.72
4	4176.00	51.22 PK	74.00	-22.78	1.00 V	124	16.15	35.07
4	4176.00	47.18 AV	54.00	-6.82	1.00 V	124	12.11	35.07
5	4924.00	52.66 PK	74.00	-21.34	1.00 V	339	15.55	37.10
5	4924.00	39.15 AV	54.00	-14.85	1.00 V	339	2.04	37.10

- REMARKS:**
1. Emission level (dBuV/m) = Raw Value (dBuV) + Correction Factor (dB/m).
 2. Correction Factor (dB/m) = Antenna Factor (dB/m) + Cable Factor (dB).
 3. The other emission levels were very low against the limit.
 4. Margin value = Emission level – Limit value.
 5. “ * “: Fundamental frequency.

802.11g OFDM MODULATION

EUT	802.11g Wireless AP	MEASUREMENT DETAIL	
MODEL	GN-AP01G	FREQUENCY RANGE	1 ~ 25GHz
CHANNEL	Channel 1	DETECTOR FUNCTION	Peak (PK) Average (AV)
MODULATION TYPE	BPSK	ENVIRONMENTAL CONDITIONS	23deg. C, 65%RH, 991hPa
TRANSFER RATE	6Mbps	INPUT POWER (SYSTEM)	120Vac, 60 Hz
TESTED BY	Gary Chang		

ANTENNA POLARITY & TEST DISTANCE: HORIZONTAL AT 3 M

No.	Freq. (MHz)	Emission Level (dBuV/m)	Limit (dBuV/m)	Margin (dB)	Antenna Height (m)	Table Angle (Degree)	Raw Value (dBuV)	Correction Factor (dB/m)
1	2038.00	46.39 PK	74.00	-27.61	1.27 H	284	16.50	29.89
2	2390.00	38.50 PK	74.00	-35.50	1.23 H	15	7.18	31.32
3	*2412.00	95.90 PK			1.23 H	15	64.49	31.41
3	*2412.00	86.98 AV			1.23 H	15	55.57	31.41
4	4076.00	46.21 PK	74.00	-27.79	1.36 H	51	11.34	34.87
5	4824.00	45.19 PK	74.00	-28.81	1.09 H	224	8.38	36.81

ANTENNA POLARITY & TEST DISTANCE: VERTICAL AT 3 M

No.	Freq. (MHz)	Emission Level (dBuV/m)	Limit (dBuV/m)	Margin (dB)	Antenna Height (m)	Table Angle (Degree)	Raw Value (dBuV)	Correction Factor (dB/m)
1	2038.00	44.40 PK	74.00	-29.60	1.09 V	19	14.51	29.89
2	2390.00	48.50 PK	74.00	-25.50	1.02 V	360	17.18	31.32
3	*2412.00	104.91 PK			1.02 V	360	73.50	31.41
3	*2412.00	95.68 AV			1.02 V	360	64.27	31.41
4	4076.00	48.38 PK	74.00	-25.62	1.23 V	15	13.51	34.87
5	4824.00	45.15 PK	74.00	-28.85	1.38 V	224	8.34	36.81

- REMARKS:**
1. Emission level (dBuV/m) = Raw Value (dBuV) + Correction Factor (dB/m).
 2. Correction Factor (dB/m) = Antenna Factor (dB/m) + Cable Factor (dB).
 3. The other emission levels were very low against the limit.
 4. Margin value = Emission level – Limit value.
 5. “ * “: Fundamental frequency.



EUT	802.11g Wireless AP	MEASUREMENT DETAIL	
MODEL	GN-AP01G	FREQUENCY RANGE	1 ~ 25GHz
CHANNEL	Channel 6	DETECTOR FUNCTION	Peak (PK) Average (AV)
MODULATION TYPE	BPSK	ENVIRONMENTAL CONDITIONS	23deg. C, 65%RH, 991hPa
TRANSFER RATE	6Mbps	INPUT POWER (SYSTEM)	120Vac, 60 Hz
TESTED BY	Gary Chang		

ANTENNA POLARITY & TEST DISTANCE: HORIZONTAL AT 3 M

No.	Freq. (MHz)	Emission Level (dBuV/m)	Limit (dBuV/m)	Margin (dB)	Antenna Height (m)	Table Angle (Degree)	Raw Value (dBuV)	Correction Factor (dB/m)
1	2063.00	45.78 PK	74.00	-28.22	1.28 H	352	15.78	30.00
2	*2437.00	96.75 PK			1.23 H	12	65.23	31.52
2	*2437.00	86.17 AV			1.23 H	12	54.65	31.52
3	4126.00	46.09 PK	74.00	-27.91	1.32 H	115	11.09	35.00
4	4874.00	46.48 PK	74.00	-27.52	1.39 H	358	9.53	36.95

ANTENNA POLARITY & TEST DISTANCE: VERTICAL AT 3 M

No.	Freq. (MHz)	Emission Level (dBuV/m)	Limit (dBuV/m)	Margin (dB)	Antenna Height (m)	Table Angle (Degree)	Raw Value (dBuV)	Correction Factor (dB/m)
1	2063.00	45.42 PK	74.00	-28.58	1.26 V	350	15.42	30.00
2	*2437.00	105.20 PK			1.05 V	350	73.68	31.52
2	*2437.00	95.80 AV			1.05 V	350	64.28	31.52
3	4126.00	47.74 PK	74.00	-26.26	1.17 V	21	12.74	35.00
4	4874.00	46.49 PK	74.00	-27.51	1.26 V	271	9.54	36.95

- REMARKS:**
1. Emission level (dBuV/m) = Raw Value (dBuV) + Correction Factor (dB/m).
 2. Correction Factor (dB/m) = Antenna Factor (dB/m) + Cable Factor (dB).
 3. The other emission levels were very low against the limit.
 4. Margin value = Emission level – Limit value.
 5. “ * “: Fundamental frequency.



EUT	802.11g Wireless AP	MEASUREMENT DETAIL	
MODEL	GN-AP01G	FREQUENCY RANGE	1 ~ 25GHz
CHANNEL	Channel 11	DETECTOR FUNCTION	Peak (PK) Average (AV)
MODULATION TYPE	BPSK	ENVIRONMENTAL CONDITIONS	23deg. C, 65%RH, 991hPa
TRANSFER RATE	6Mbps	INPUT POWER (SYSTEM)	120Vac, 60 Hz
TESTED BY	Gary Chang		

ANTENNA POLARITY & TEST DISTANCE: HORIZONTAL AT 3 M								
No.	Freq. (MHz)	Emission Level (dBuV/m)	Limit (dBuV/m)	Margin (dB)	Antenna Height (m)	Table Angle (Degree)	Raw Value (dBuV)	Correction Factor (dB/m)
1	2088.00	47.85 PK	74.00	-26.15	1.21 H	64	17.74	30.11
2	*2462.00	95.39 PK			1.27 H	10	63.76	31.63
2	*2462.00	86.08 AV			1.27 H	10	54.45	31.63
3	2483.50	37.50 PK	74.00	-36.50	1.27 H	10	5.78	31.72
4	4176.00	48.08 PK	74.00	-25.92	1.29 H	64	13.02	35.07
5	4924.00	46.51 PK	74.00	-27.49	1.28 H	224	9.41	37.10

ANTENNA POLARITY & TEST DISTANCE: VERTICAL AT 3 M								
No.	Freq. (MHz)	Emission Level (dBuV/m)	Limit (dBuV/m)	Margin (dB)	Antenna Height (m)	Table Angle (Degree)	Raw Value (dBuV)	Correction Factor (dB/m)
1	2088.00	47.90 PK	74.00	-26.10	1.35 V	291	17.79	30.11
2	*2462.00	103.55 PK			1.03 V	15	71.92	31.63
2	*2462.00	94.64 AV			1.03 V	15	63.01	31.63
3	2483.50	44.20 PK	74.00	-29.80	1.03 V	15	12.48	31.72
4	4176.00	49.42 PK	74.00	-24.58	1.10 V	125	14.36	35.07
5	4924.00	46.02 PK	74.00	-27.98	1.20 V	241	8.92	37.10

- REMARKS:**
1. Emission level (dBuV/m) = Raw Value (dBuV) + Correction Factor (dB/m).
 2. Correction Factor (dB/m) = Antenna Factor (dB/m) + Cable Factor (dB).
 3. The other emission levels were very low against the limit.
 4. Margin value = Emission level – Limit value.
 5. “ * “: Fundamental frequency.



4.3 6dB BANDWIDTH MEASUREMENT

4.3.1 LIMITS OF 6dB BANDWIDTH MEASUREMENT

The minimum of 6dB Bandwidth Measurement is 0.5 MHz.

4.3.2 TEST INSTRUMENTS

DESCRIPTION & MANUFACTURER	MODEL NO.	SERIAL NO.	CALIBRATED UNTIL
SPECTRUM ANALYZER	FSEK 30	100049	Aug. 12, 2005

NOTE: The calibration interval of the above test instruments is 12 months and the calibrations are traceable to NML/ROC and NIST/USA.

4.3.3 TEST PROCEDURE

The transmitter output was connected to the spectrum analyzer through an attenuator. The bandwidth of the fundamental frequency was measured by spectrum analyzer with 100kHz RBW and 100kHz VBW. The 6dB bandwidth is defined as the total spectrum the power of which is higher than peak power minus 6dB.

4.3.4 DEVIATION FROM TEST STANDARD

No deviation

4.3.5 TEST SETUP

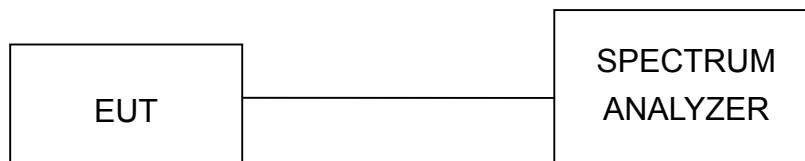

4.3.6 EUT OPERATING CONDITIONS

The software provided by client to enable the EUT under transmission condition continuously at lowest, middle and highest channel frequencies individually.



4.3.7 TEST RESULTS

802.11b DSSS MODULATION

EUT	802.11g Wireless AP	MODEL	GN-AP01G
MODULATION TYPE	CCK	TRANSFER RATE	11Mbps
INPUT POWER (SYSTEM)	120Vac, 60 Hz	ENVIRONMENTAL CONDITIONS	25deg. C, 63%RH, 991hPa
TESTED BY	Gary Chang		

CHANNEL	CHANNEL FREQUENCY (MHz)	6dB BANDWIDTH (MHz)	MINIMUM LIMIT (MHz)	PASS/FAIL
1	2412	11.84	0.5	PASS
6	2437	11.68	0.5	PASS
11	2462	11.60	0.5	PASS



CH1

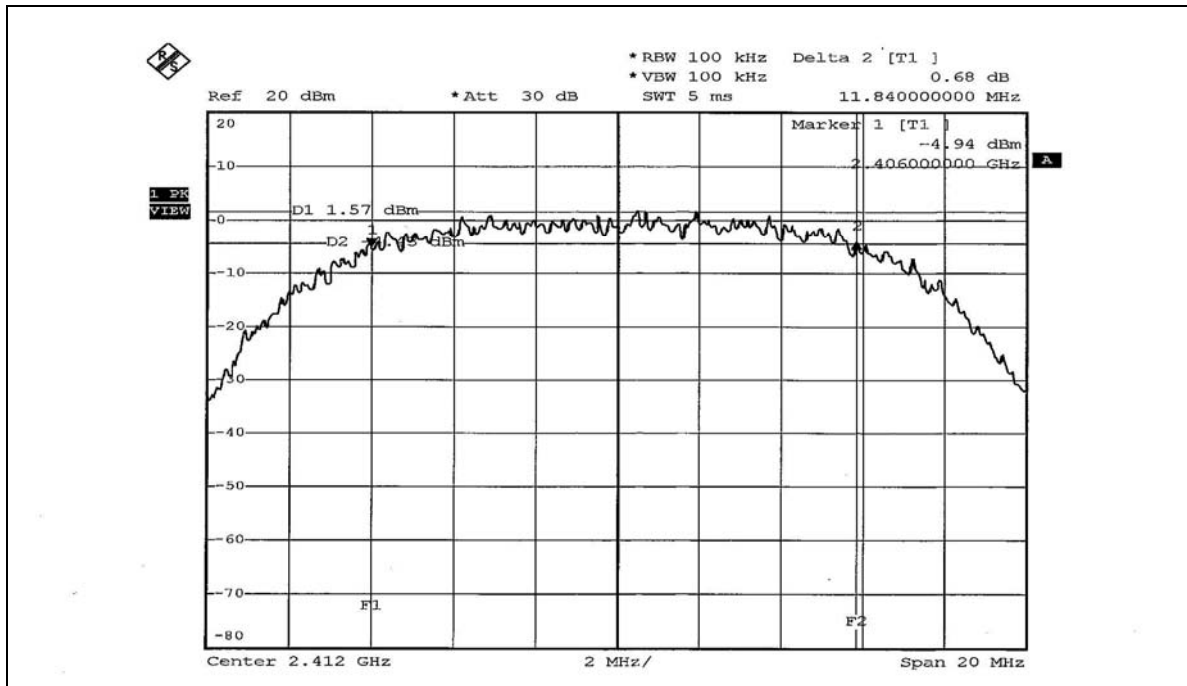

CH6

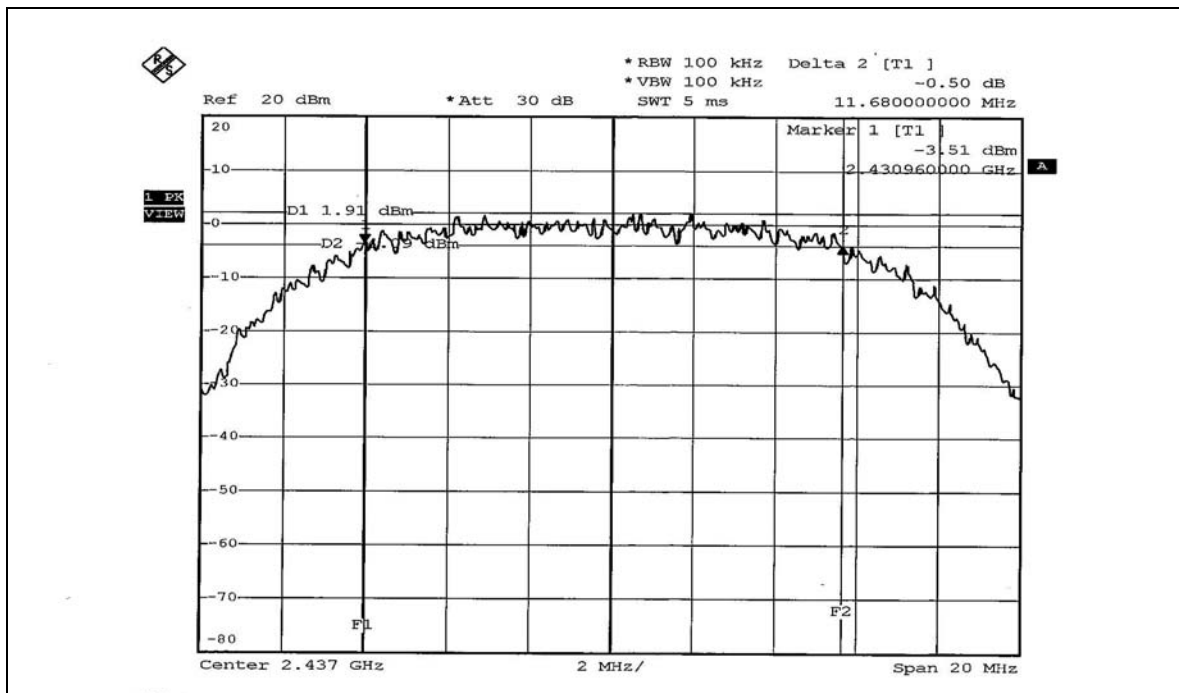



CH11

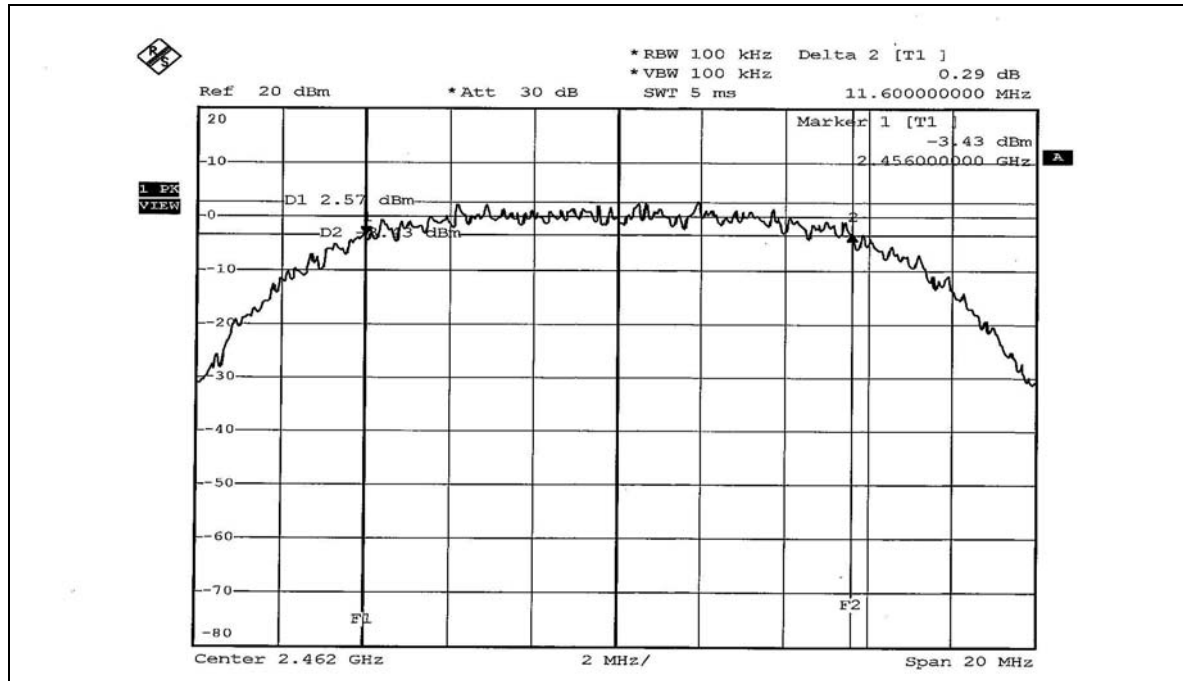



802.11g OFDM MODULATION

EUT	802.11g Wireless AP	MODEL	GN-AP01G
MODULATION TYPE	BPSK	TRANSFER RATE	6Mbps
INPUT POWER (SYSTEM)	120Vac, 60 Hz	ENVIRONMENTAL CONDITIONS	23deg. C, 65%RH, 991hPa
TESTED BY	Gary Chang		

CHANNEL	CHANNEL FREQUENCY (MHz)	6dB BANDWIDTH (MHz)	MINIMUM LIMIT (MHz)	PASS/FAIL
1	2412	16.60	0.5	PASS
6	2437	16.52	0.5	PASS
11	2462	16.56	0.5	PASS



CH1

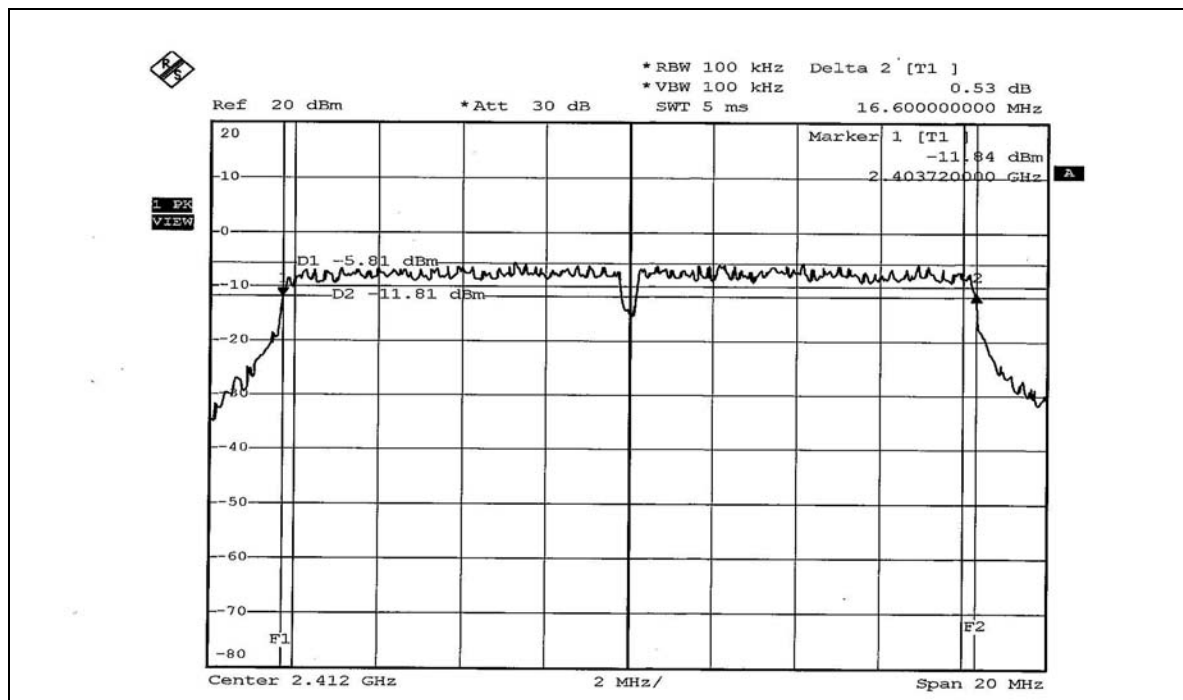

CH6

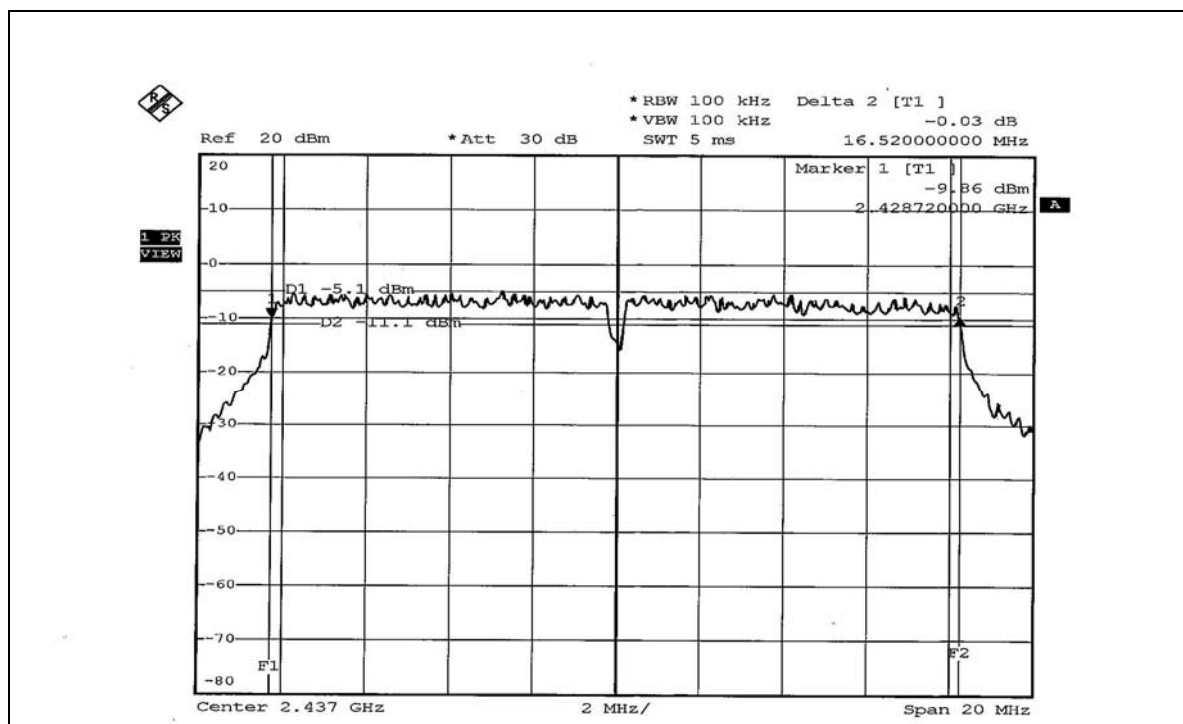



CH11

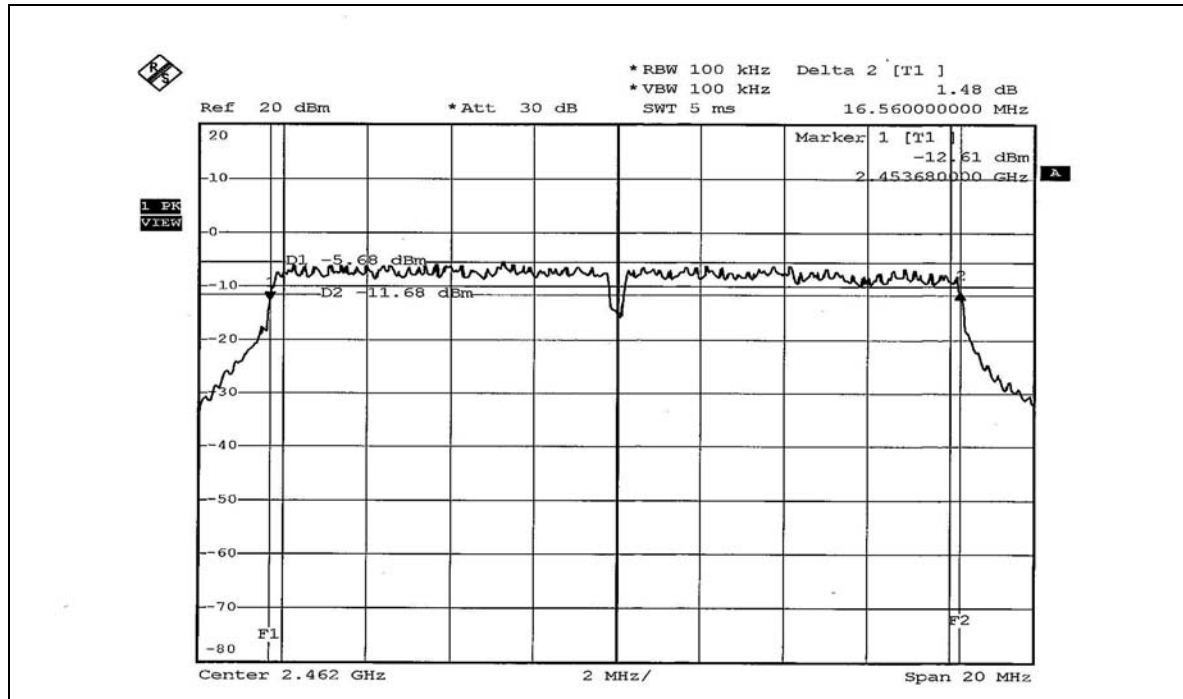



4.4 MAXIMUM PEAK OUTPUT POWER

4.4.1 LIMITS OF MAXIMUM PEAK OUTPUT POWER MEASUREMENT

The Maximum Peak Output Power Measurement is 30dBm.

4.4.2 INSTRUMENTS

DESCRIPTION & MANUFACTURER	MODEL NO.	SERIAL NO.	CALIBRATED UNTIL
R&S SPECTRUM ANALYZER	FSEK30	100049	Aug. 12, 2005
AGILENT SIGNAL GENERATOR	E8257C	MY43320668	Dec. 06, 2005
DIGITAL RT OSCILLOSCOPE	TDS1012	C037299	Dec. 07, 2005
NARDA DETECTOR	4503A	FSCM99899	NA

NOTE: The calibration interval of the above test instruments is 12 months and the calibrations are traceable to NML/ROC and NIST/USA.



4.4.3 TEST PROCEDURES

1. A detector was used on the output port of the EUT. An oscilloscope was used to read the response of the detector.
2. Replaced the EUT by the signal generator. The center frequency of the S.G was adjusted to the center frequency of the measured channel.
3. Adjusted the power to have the same reading on oscilloscope. Record the power level.

4.4.4 DEVIATION FROM TEST STANDARD

No deviation

4.4.5 TEST SETUP



4.4.6 EUT OPERATING CONDITIONS

Same as Item 4.3.6



4.4.7 TEST RESULTS

802.11b DSSS MODULATION

EUT	802.11g Wireless AP	MODEL	GN-AP01G
MODULATION TYPE	CCK	TRANSFER RATE	11Mbps
INPUT POWER (SYSTEM)	120Vac, 60 Hz	ENVIRONMENTAL CONDITIONS	25deg. C, 63%RH, 991hPa
TESTED BY	Gary Chang		

CHANNEL	CHANNEL FREQUENCY (MHz)	PEAK POWER OUTPUT (mW)	PEAK POWER OUTPUT (dBm)	PEAK POWER LIMIT (dBm)	PASS/FAIL
1	2412	62.373	17.95	30	PASS
6	2437	63.826	18.05	30	PASS
11	2462	63.533	18.03	30	PASS

802.11g OFDM MODULATION

EUT	802.11g Wireless AP	MODEL	GN-AP01G
MODULATION TYPE	BPSK	TRANSFER RATE	6Mbps
INPUT POWER (SYSTEM)	120Vac, 60 Hz	ENVIRONMENTAL CONDITIONS	25deg. C, 63%RH, 991hPa
TESTED BY	Gary Chang		

CHANNEL	CHANNEL FREQUENCY (MHz)	PEAK POWER OUTPUT (mW)	PEAK POWER OUTPUT (dBm)	PEAK POWER LIMIT (dBm)	PASS/FAIL
1	2412	30.549	14.85	30	PASS
6	2437	31.769	15.02	30	PASS
11	2462	31.117	14.93	30	PASS



4.5 POWER SPECTRAL DENSITY MEASUREMENT

4.5.1 LIMITS OF POWER SPECTRAL DENSITY MEASUREMENT

The Maximum of Power Spectral Density Measurement is 8dBm.

4.5.2 TEST INSTRUMENTS

DESCRIPTION & MANUFACTURER	MODEL NO.	SERIAL NO.	CALIBRATED UNTIL
R&S SPECTRUM ANALYZER	FSEK30	100049	Aug. 12, 2005

NOTE: The calibration interval of the above test instruments is 12 months and the calibrations are traceable to NML/ROC and NIST/USA.

4.5.3 TEST PROCEDURE

The transmitter output was connected to the spectrum analyzer through an attenuator, the bandwidth of the fundamental frequency was measured with the spectrum analyzer using 3kHz RBW and 30kHz VBW, set sweep time = span/3kHz. The power spectral density was measured and recorded.

The sweep time is allowed to be longer than span/3kHz for a full response of the mixer in the spectrum analyzer.

4.5.4 DEVIATION FROM TEST STANDARD

No deviation

4.5.5 TEST SETUP

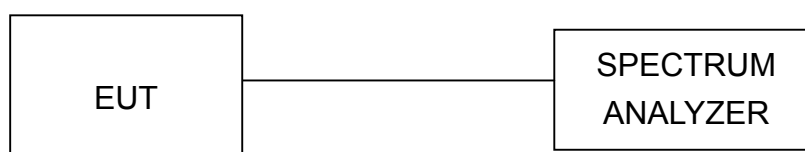

4.5.6 EUT OPERATING CONDITION

Same as Item 4.3.6



4.5.7 TEST RESULTS

802.11b DSSS MODULATION

EUT	802.11g Wireless AP	MODEL	GN-AP01G
MODULATION TYPE	CCK	TRANSFER RATE	11Mbps
INPUT POWER (SYSTEM)	120Vac, 60 Hz	ENVIRONMENTAL CONDITIONS	25deg. C, 63%RH, 991hPa
TESTED BY	Gary Chang		

CHANNEL	CHANNEL FREQUENCY (MHz)	RF POWER LEVEL IN 3kHz BW (dBm)	MAXIMUM LIMIT (dBm)	PASS/FAIL
1	2412	-12.30	8	PASS
6	2437	-11.84	8	PASS
11	2462	-11.56	8	PASS



CH1

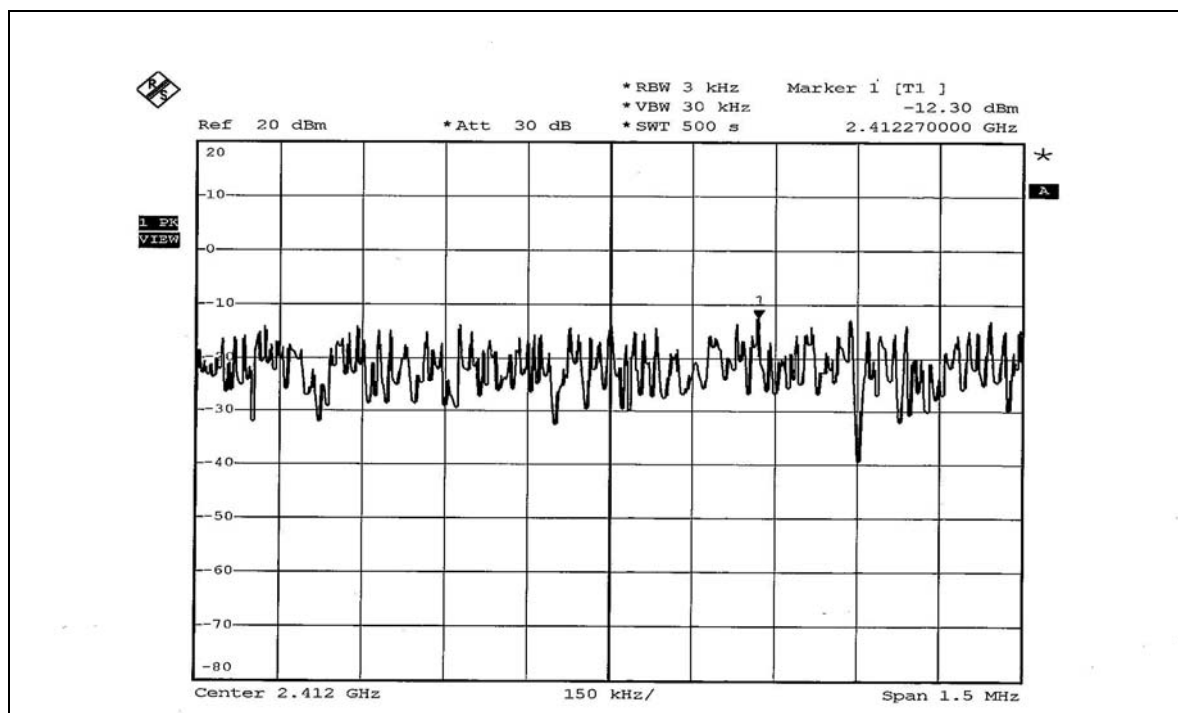

CH6

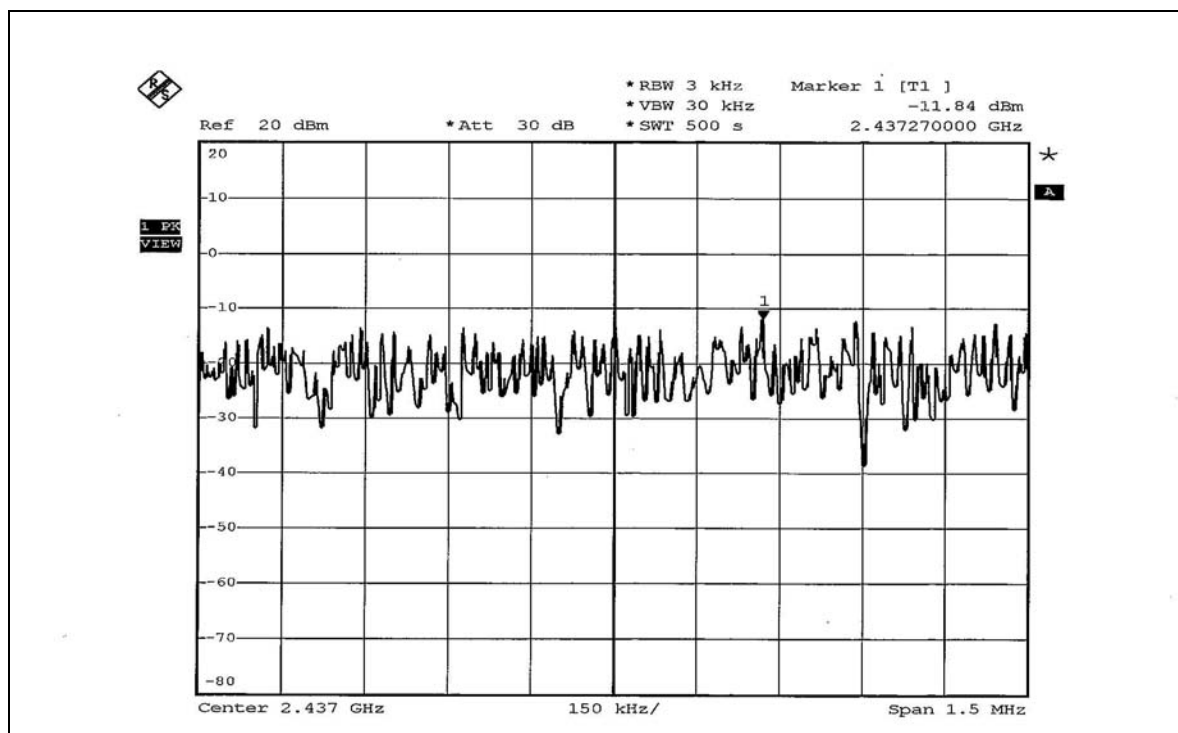



CH11

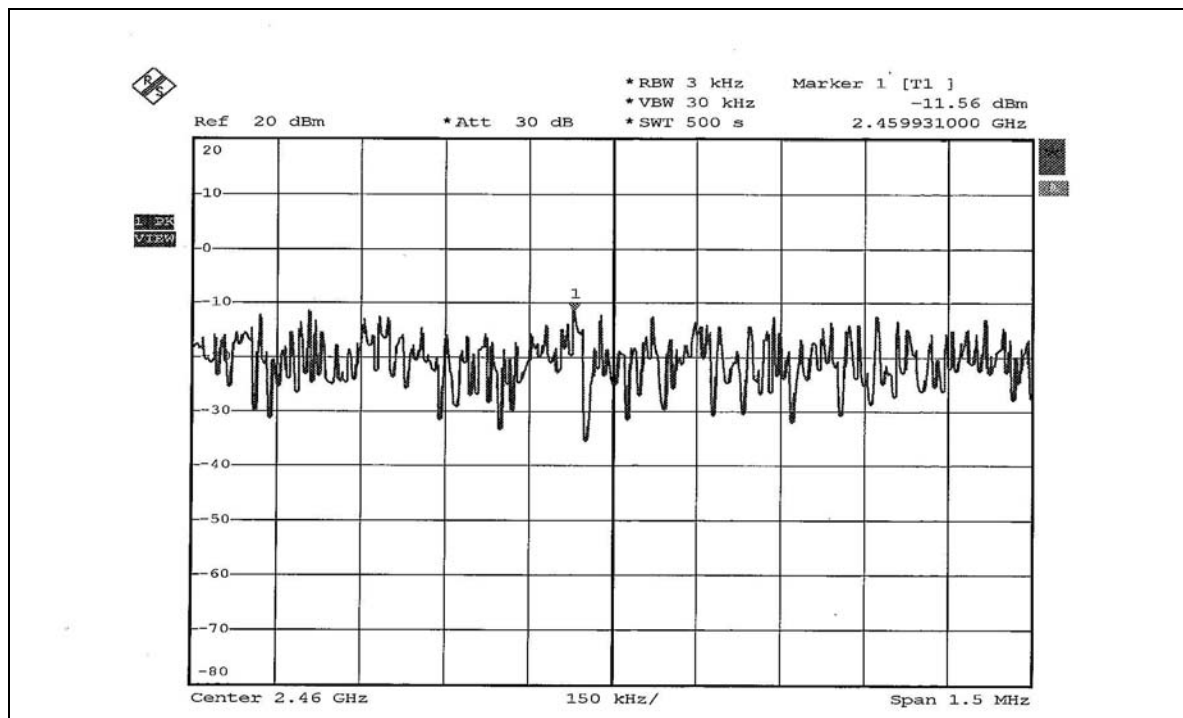



802.11g OFDM MODULATION

EUT	802.11g Wireless AP	MODEL	GN-AP01G
MODULATION TYPE	BPSK	TRANSFER RATE	6Mbps
INPUT POWER (SYSTEM)	120Vac, 60 Hz	ENVIRONMENTAL CONDITIONS	25deg. C, 63%RH, 991hPa
TESTED BY	Gary Chang		

CHANNEL	CHANNEL FREQUENCY (MHz)	RF POWER LEVEL IN 3kHz BW (dBm)	MAXIMUM LIMIT (dBm)	PASS/FAIL
1	2412	-20.32	8	PASS
6	2437	-19.74	8	PASS
11	2462	-20.33	8	PASS



CH1

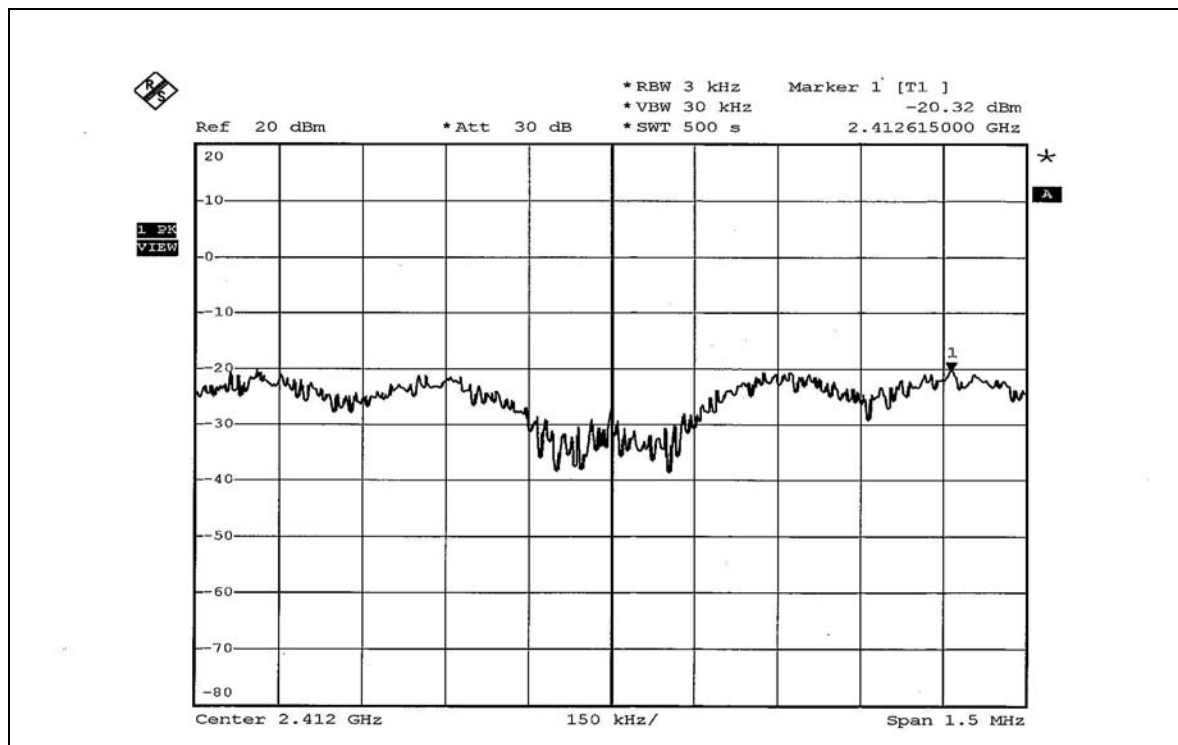

CH6

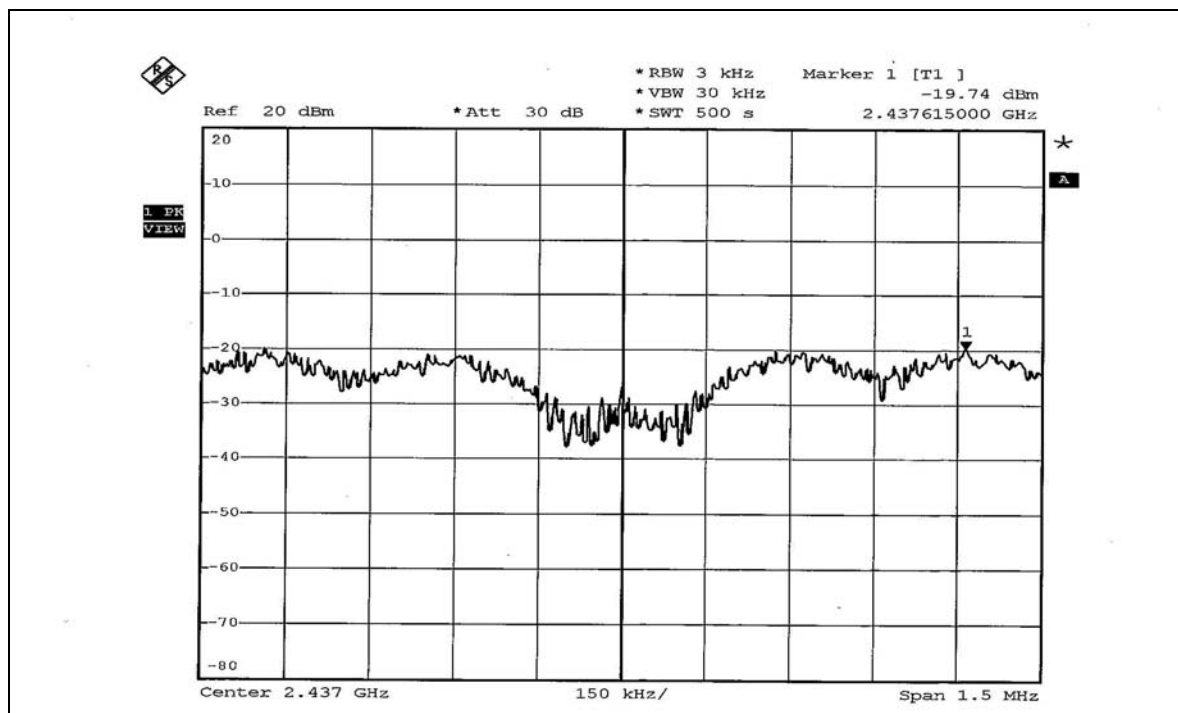



CH11

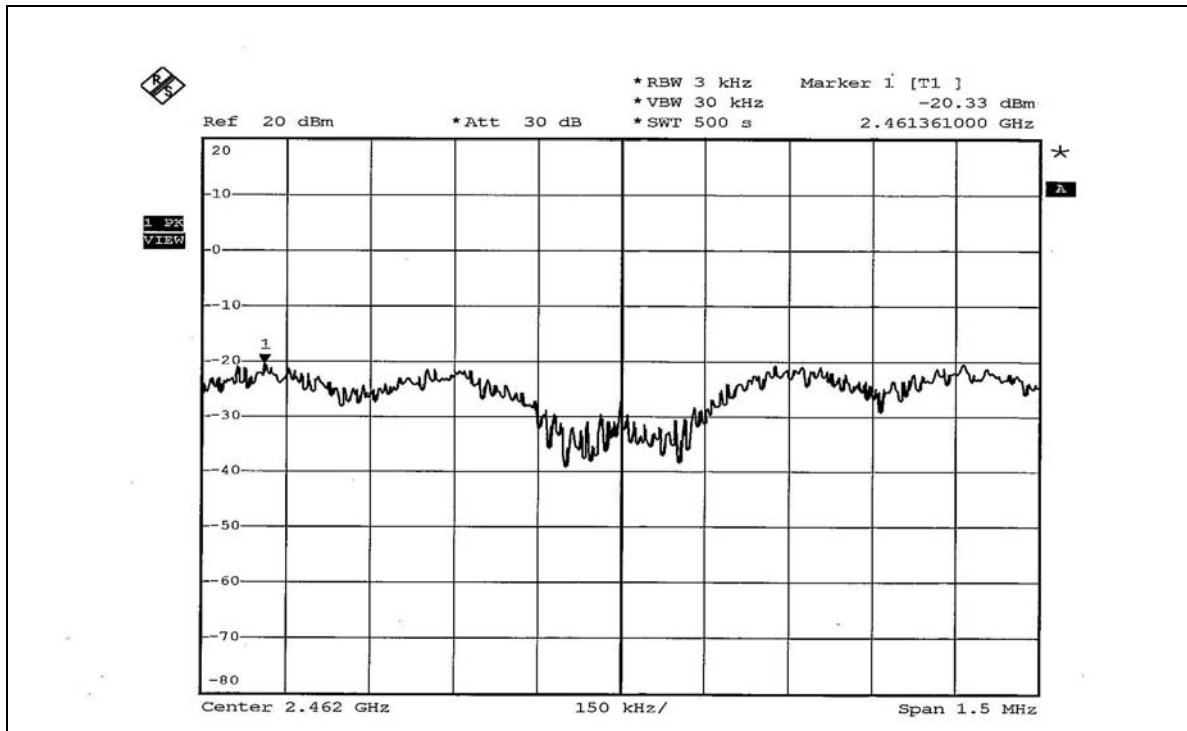



4.6 BAND EDGES MEASUREMENT

4.6.1 LIMITS OF BAND EDGES MEASUREMENT

Below -20dB of the highest emission level of operating band (in 100kHz Resolution Bandwidth).

4.6.2 TEST INSTRUMENTS

DESCRIPTION & MANUFACTURER	MODEL NO.	SERIAL NO.	CALIBRATED UNTIL
R&S SPECTRUM ANALYZER	FSEK30	100049	Aug. 12, 2005

NOTE: The calibration interval of the above test instruments is 12 months and the calibrations are traceable to NML/ROC and NIST/USA.

4.6.3 TEST PROCEDURE

The transmitter output was connected to the spectrum analyzer via a low lose cable. Set both RBW and VBW of spectrum analyzer to 100 kHz and 100 kHz with suitable frequency span including 100 MHz bandwidth from band edge. The band edges was measured and recorded.

The spectrum plots (Peak RBW=VBW=100kHz; Average RBW=1MHz, VBW=10Hz) are attached on the following pages.

4.6.4 DEVIATION FROM TEST STANDARD

No deviation

4.6.5 EUT OPERATING CONDITION

Same as Item 4.3.6



4.6.6 TEST RESULTS

The spectrum plots are attached on the following 12 images. D2 line indicates the highest level, and D1 line indicates the 20dB offset below D2. It shows compliance with the requirement in part 15.247(d).

802.11b DSSS MODULATION

NOTE 1:

The band edge emission plot on page 53 show 48.35dBc delta between carrier maximum power and local maximum emission in restrict band (2.3264GHz). The emission of carrier strength list in the test result of channel 1 at the item 4.2.7 is 108.97dBuV/m (Peak), so the maximum field strength in restrict band is $108.97 - 48.35 = 60.62$ dBuV/m, which is under 74dBuV/m limit.

The band edge emission plot on page 53 show 61.80dBc delta between carrier maximum power and local maximum emission in restrict band (2.3900GHz). The emission of carrier strength list in the test result of channel 1 at the item 4.2.7 is 101.48dBuV/m (Average), so the maximum field strength in restrict band is $101.48 - 61.80 = 39.68$ dBuV/m, which is under 54dBuV/m limit.

NOTE 2:

The band edge emission plot on the page 54 show 51.57dBc delta between carrier maximum power and local maximum emission in restrict band (2.4865GHz). The emission of carrier strength list in the test result of channel 11 at the item 4.2.7 is 109.70dBuV/m (Peak), so the maximum field strength in restrict band is $109.70 - 51.57 = 58.13$ dBuV/m, which is under 74dBuV/m limit.

The band edge emission plot on the page 55 show 57.79dBc delta between carrier maximum power and local maximum emission in restrict band (2.4879GHz). The emission of carrier strength list in the test result of channel 11 at the item 4.2.7 is 102.06dBuV/m (Average), so the maximum field strength in restrict band is $102.06 - 57.79 = 44.27$ dBuV/m, which is under 54dBuV/m limit.

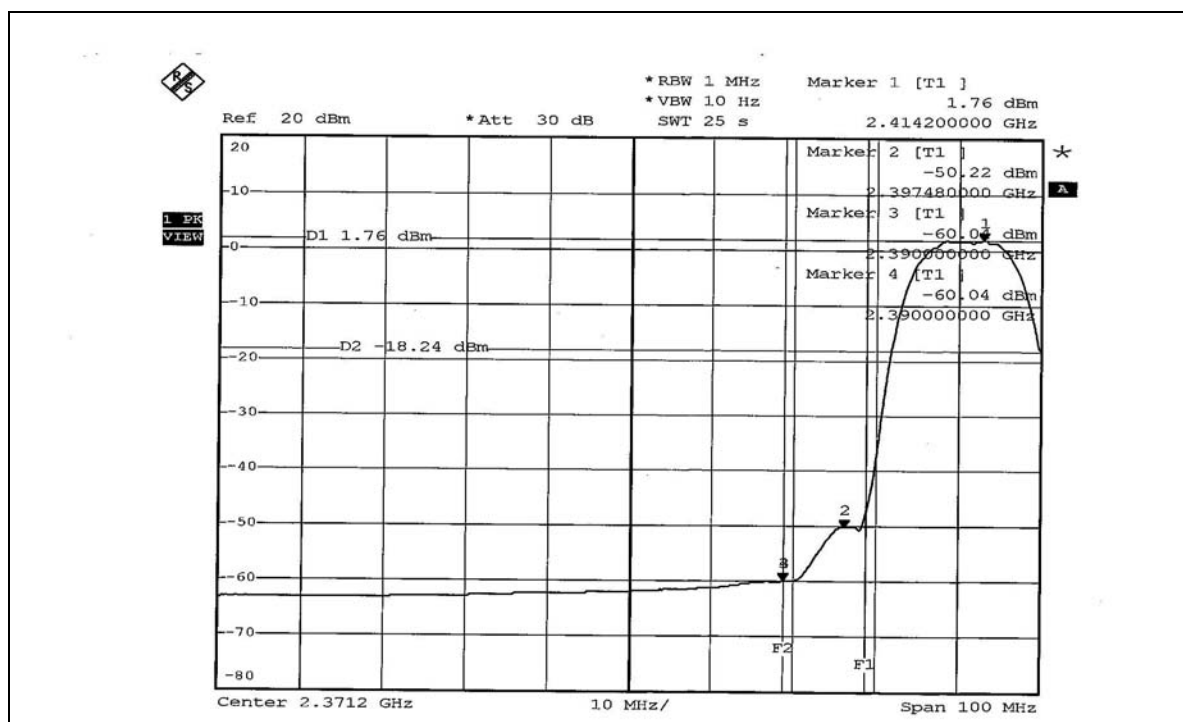
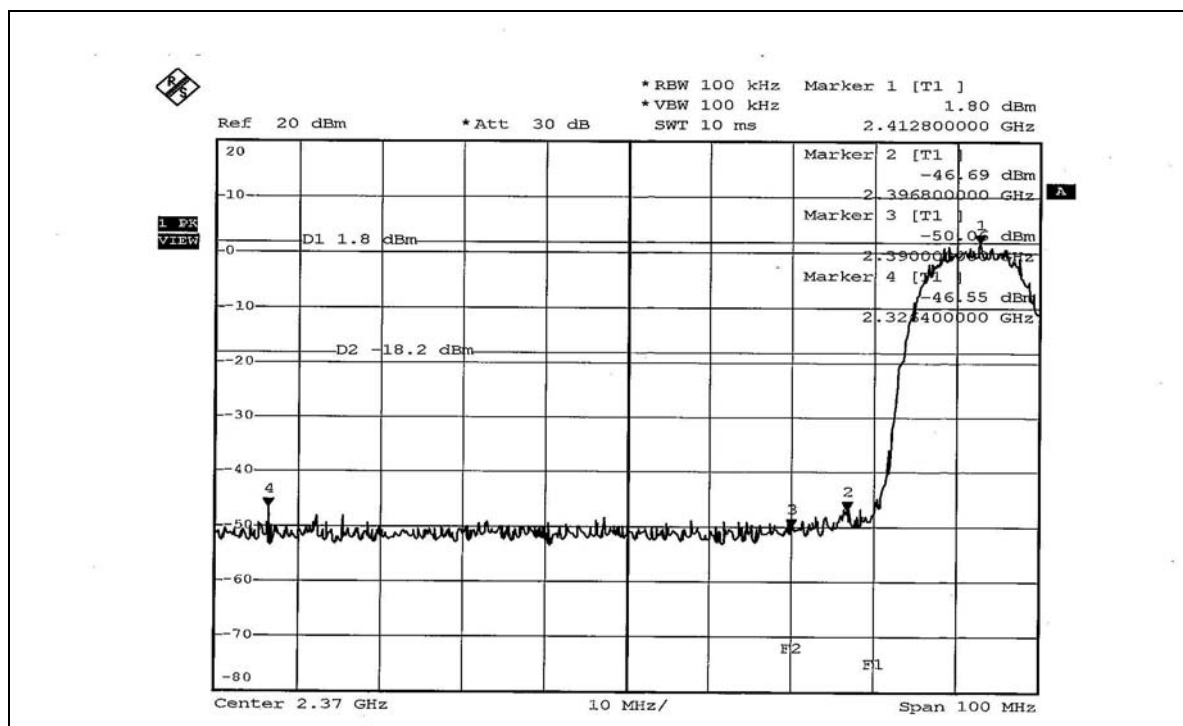

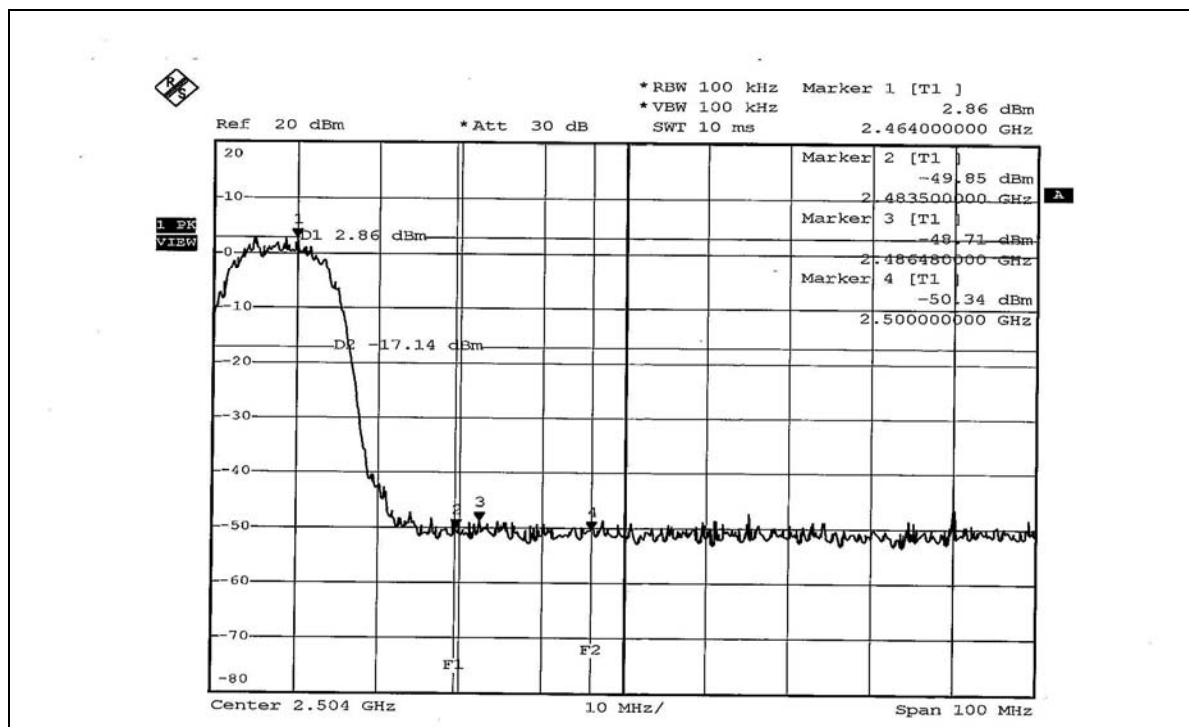
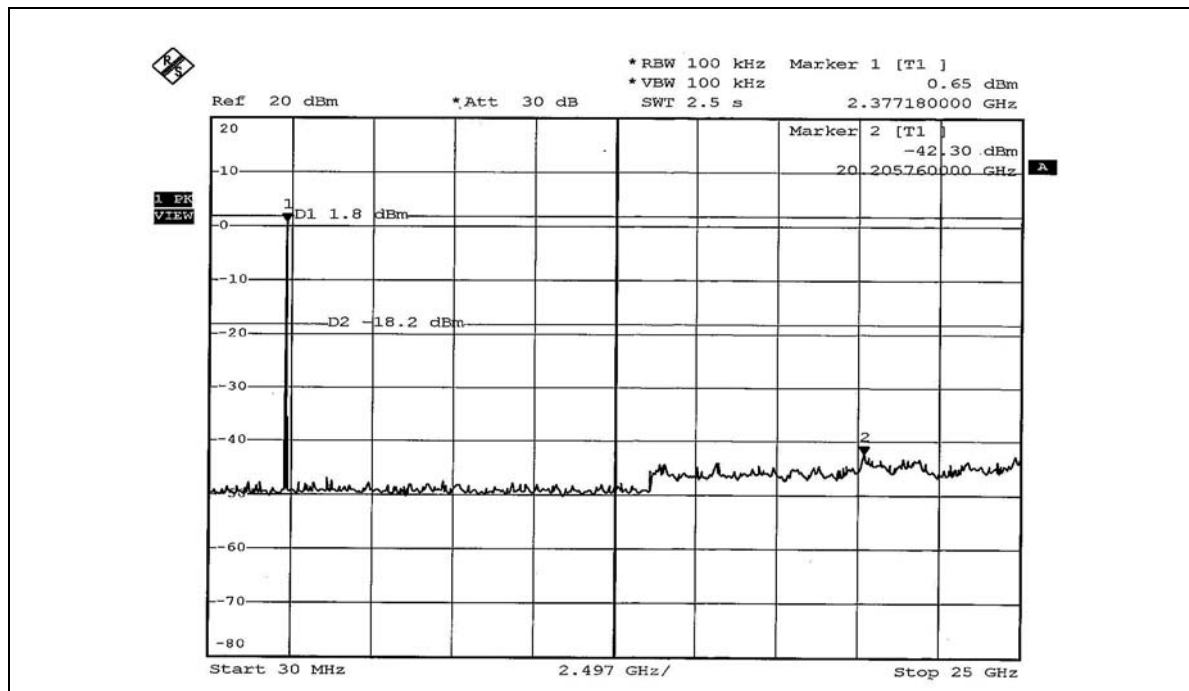

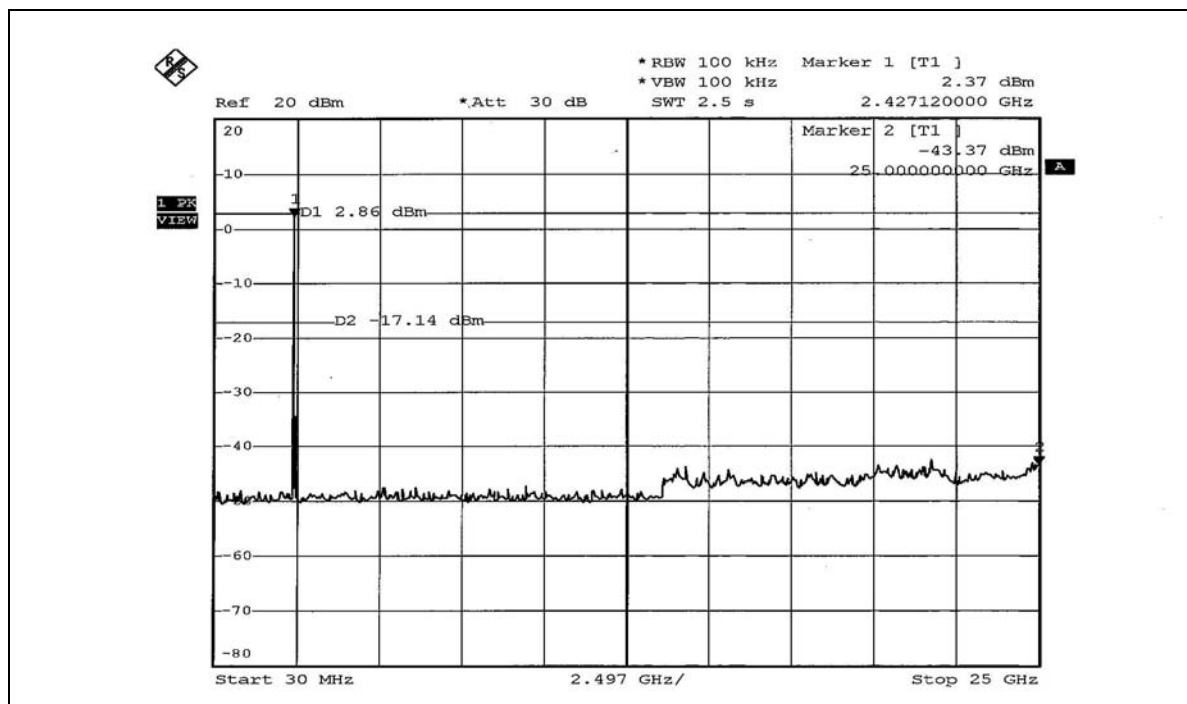
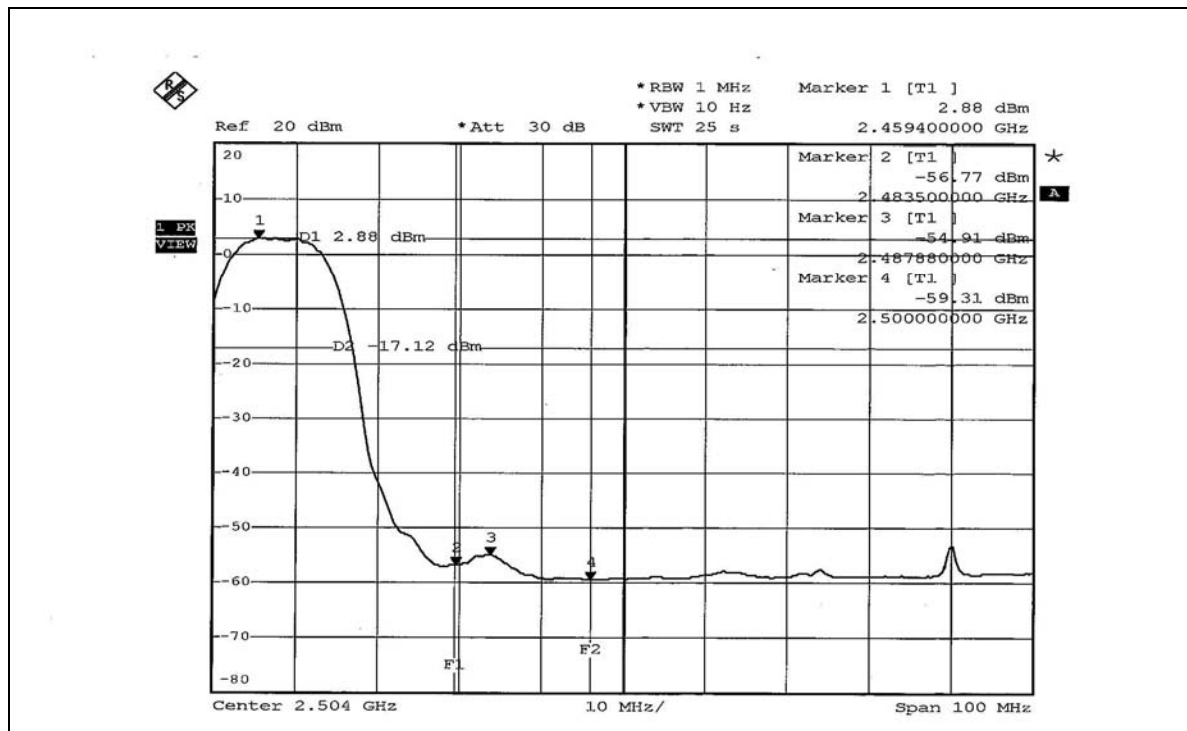



802.11g OFDM MODULATION

NOTE 1:

The band edge emission plot on page 57 show 42.14dBc delta between carrier maximum power and local maximum emission in restrict band (2.3486GHz). The emission of carrier strength list in the test result of channel 1 at the item 4.2.7 is 104.91dBuV/m (Peak), so the maximum field strength in restrict band is $104.91 - 42.14 = 62.77$ dBuV/m, which is under 74dBuV/m limit.

The band edge emission plot on page 57 show 55.81dBc delta between carrier maximum power and local maximum emission in restrict band (2.3900GHz). The emission of carrier strength list in the test result of channel 1 at the item 4.2.7 is 95.68dBuV/m (Average), so the maximum field strength in restrict band is $95.68 - 55.81 = 39.87$ dBuV/m, which is under 54dBuV/m limit.

NOTE 2:

The band edge emission plot on the page 58 show 42.13dBc delta between carrier maximum power and local maximum emission in restrict band (2.4883GHz). The emission of carrier strength list in the test result of channel 11 at the item 4.2.7 is 103.55dBuV/m (Peak), so the maximum field strength in restrict band is $103.55 - 42.13 = 61.42$ dBuV/m, which is under 74dBuV/m limit.

The band edge emission plot on the page 59 show 53.98dBc delta between carrier maximum power and local maximum emission in restrict band (2.4835GHz). The emission of carrier strength list in the test result of channel 11 at the item 4.2.7 is 94.64dBuV/m (Average), so the maximum field strength in restrict band is $94.64 - 53.98 = 40.66$ dBuV/m, which is under 54dBuV/m limit.

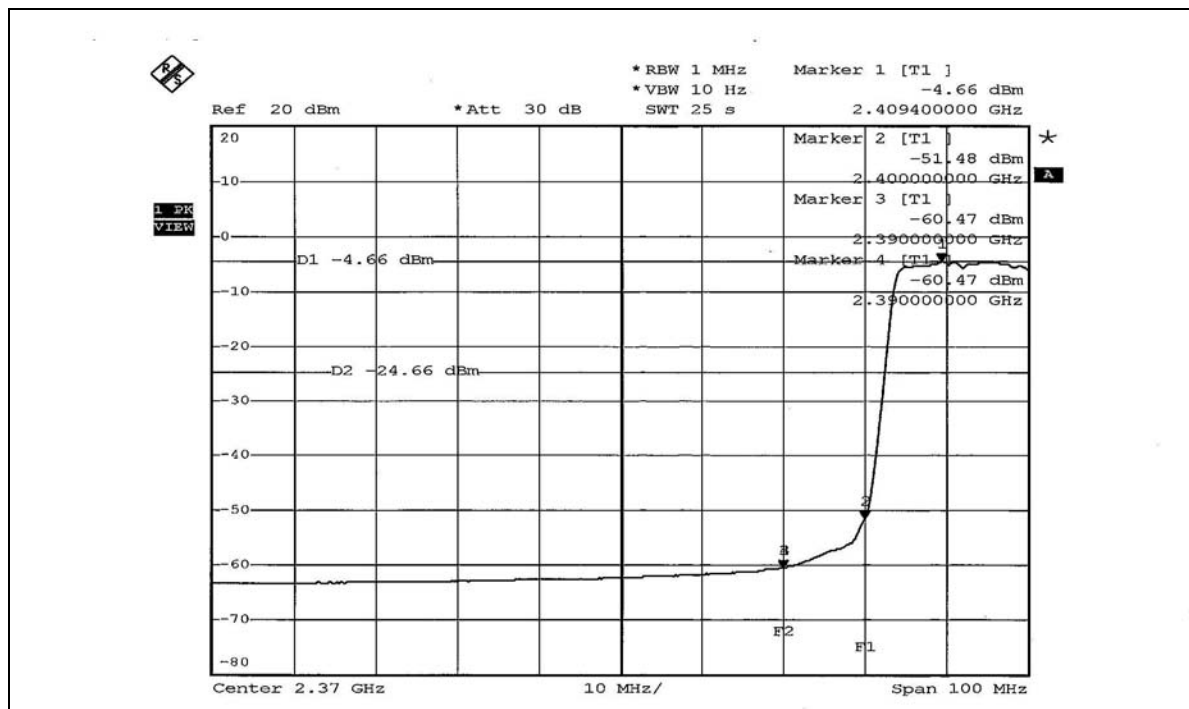
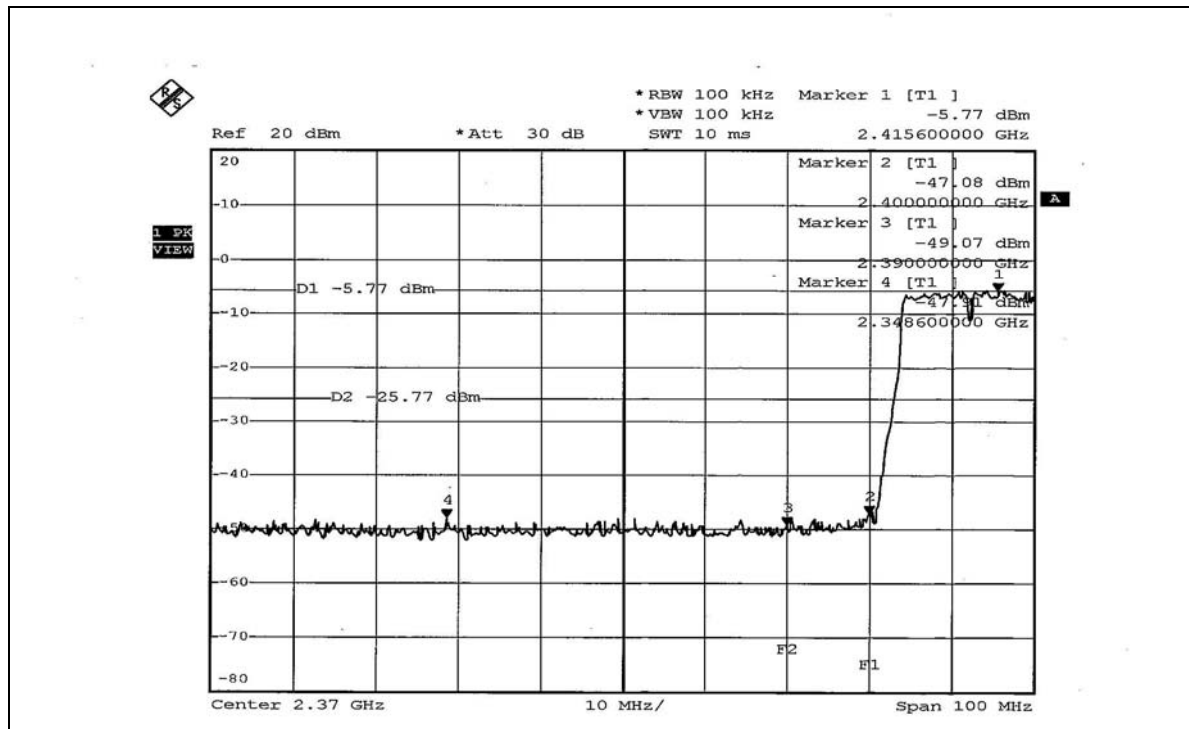

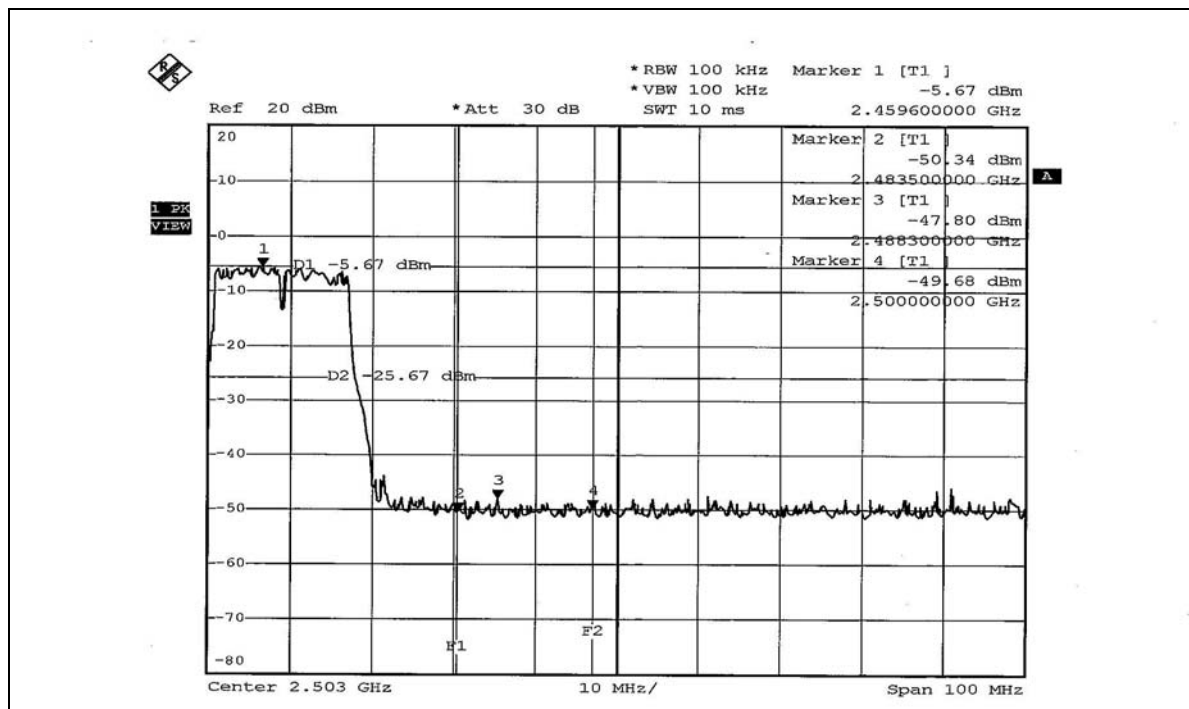
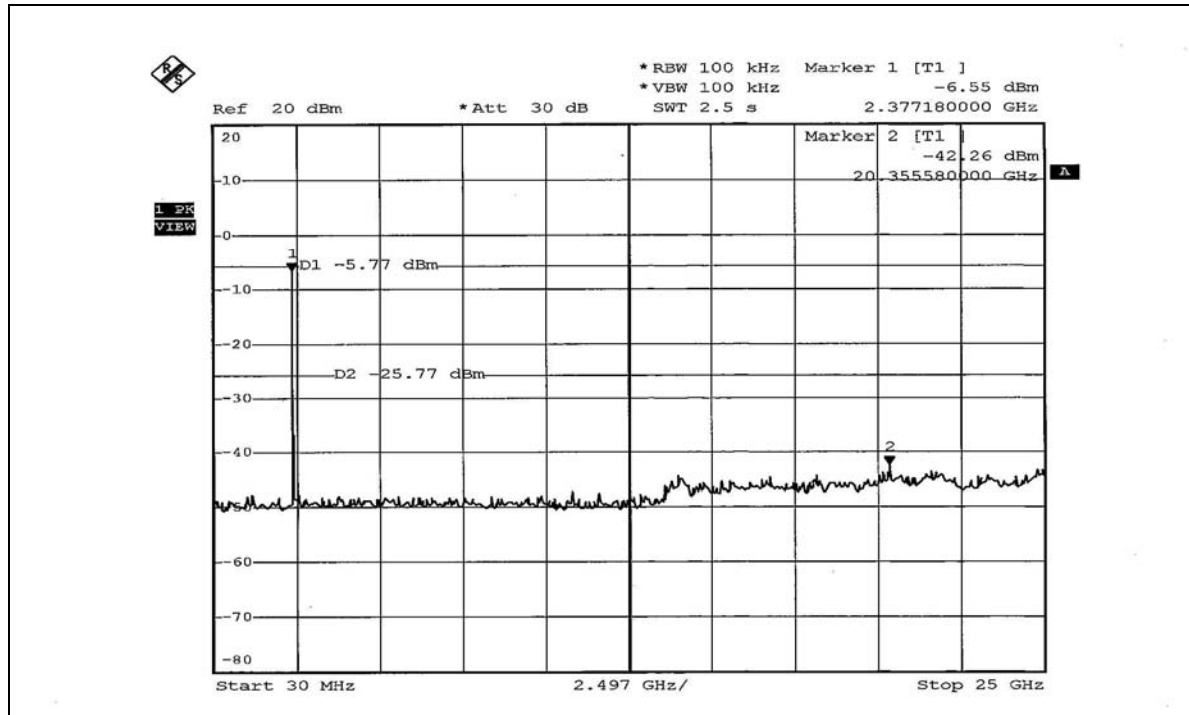

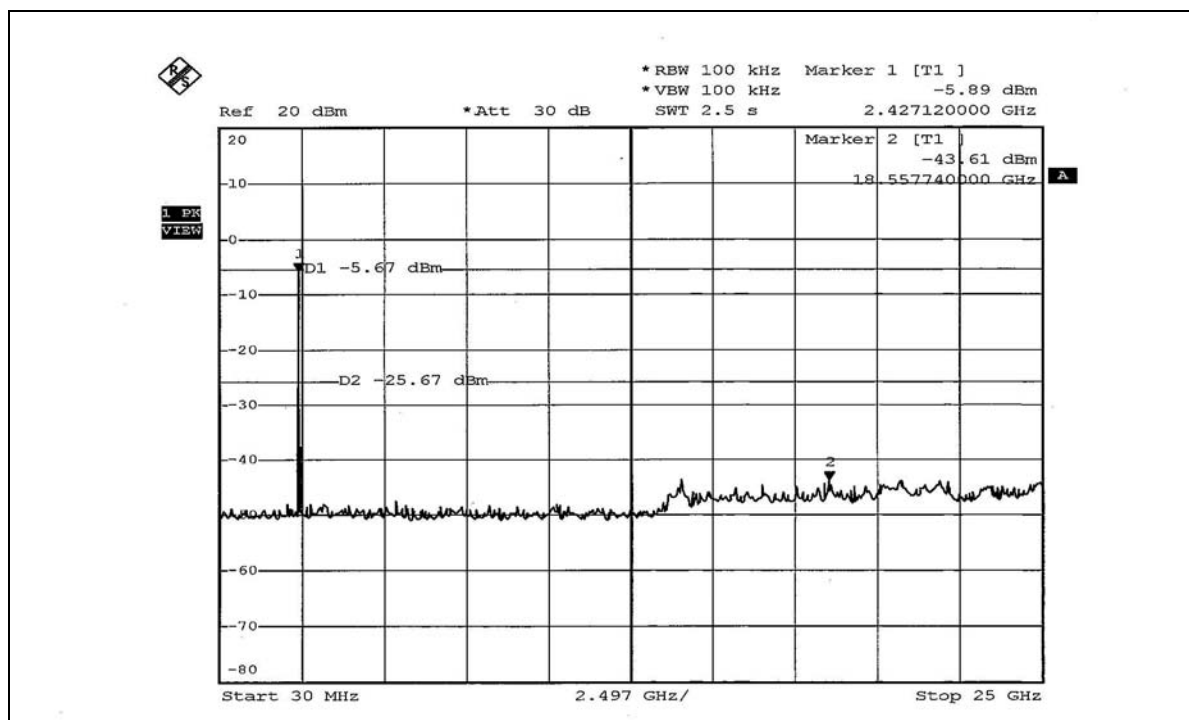
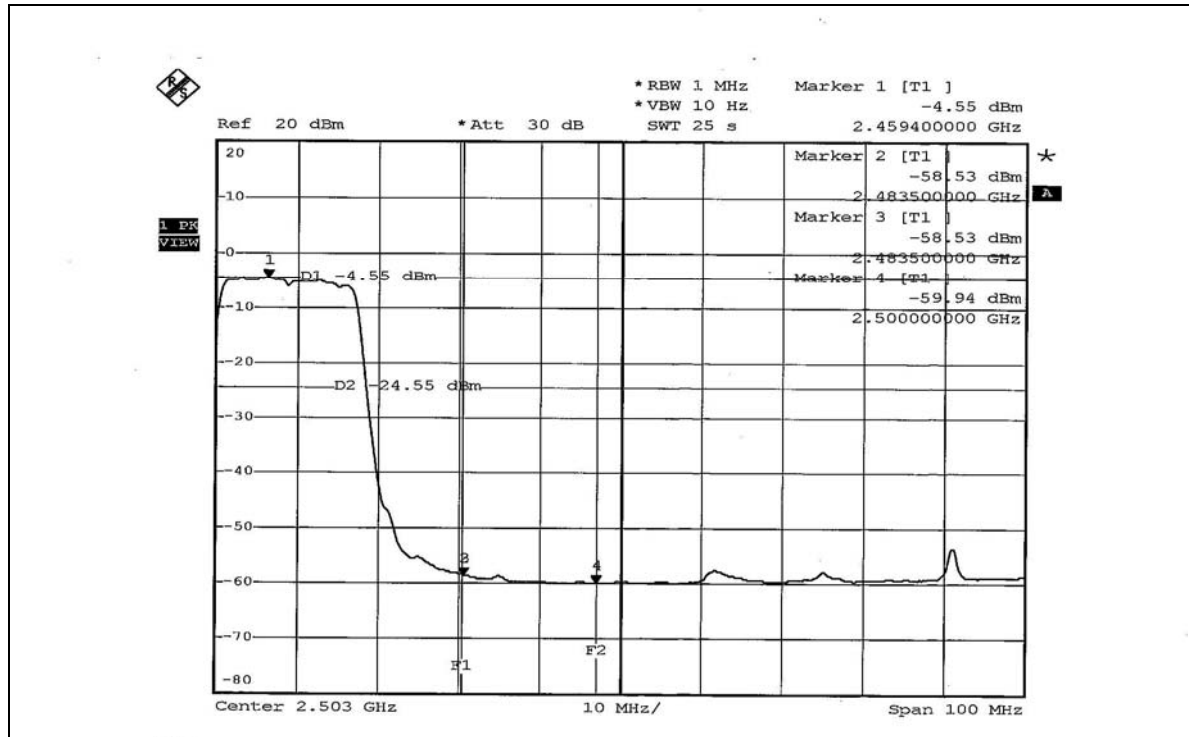



4.7 ANTENNA REQUIREMENT

4.7.1 STANDARD APPLICABLE

For intentional device, according to FCC 47 CFR Section 15.203, an intentional radiator shall be designed to ensure that no antenna other than that furnished by the responsible party shall be used with the device. And according to FCC 47 CFR Section 15.247 (b), if transmitting antennas of directional gain greater than 6dBi are used, the power shall be reduced by the amount in dB that the directional gain of the antenna exceeds 6dBi.

4.7.2 ANTENNA CONNECTED CONSTRUCTION

The antenna used in this product is Dipole antenna with RSMA antenna connector. The maximum Gain of the antenna is 2dBi.

5. PHOTOGRAPHS OF THE TEST CONFIGURATION

CONDUCTED EMISSION TEST



RADIATED EMISSION TEST

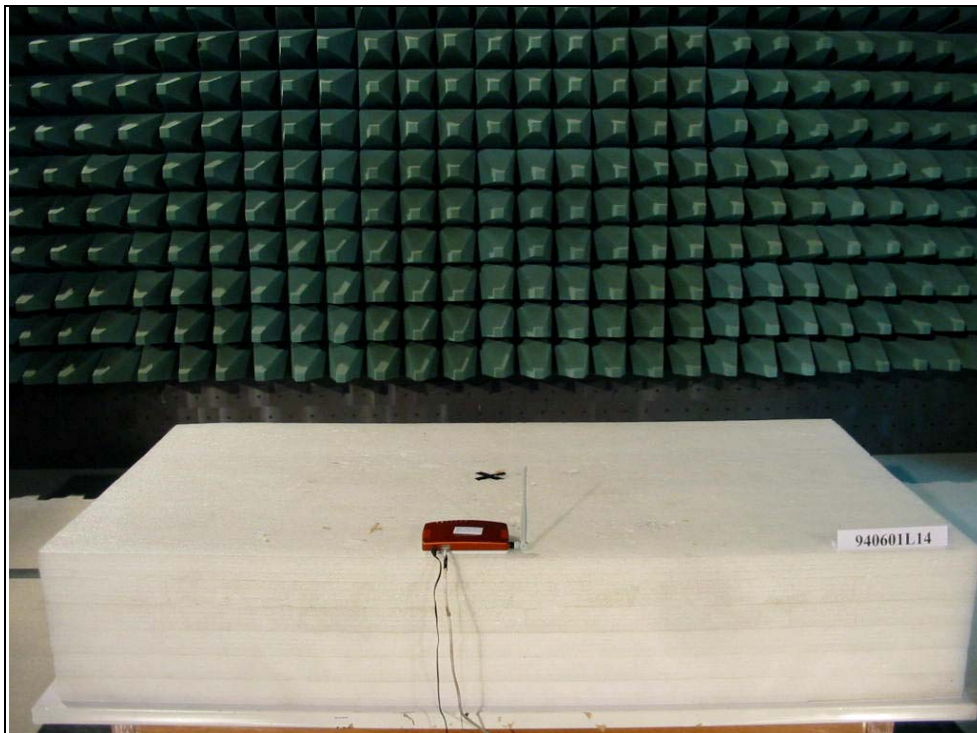
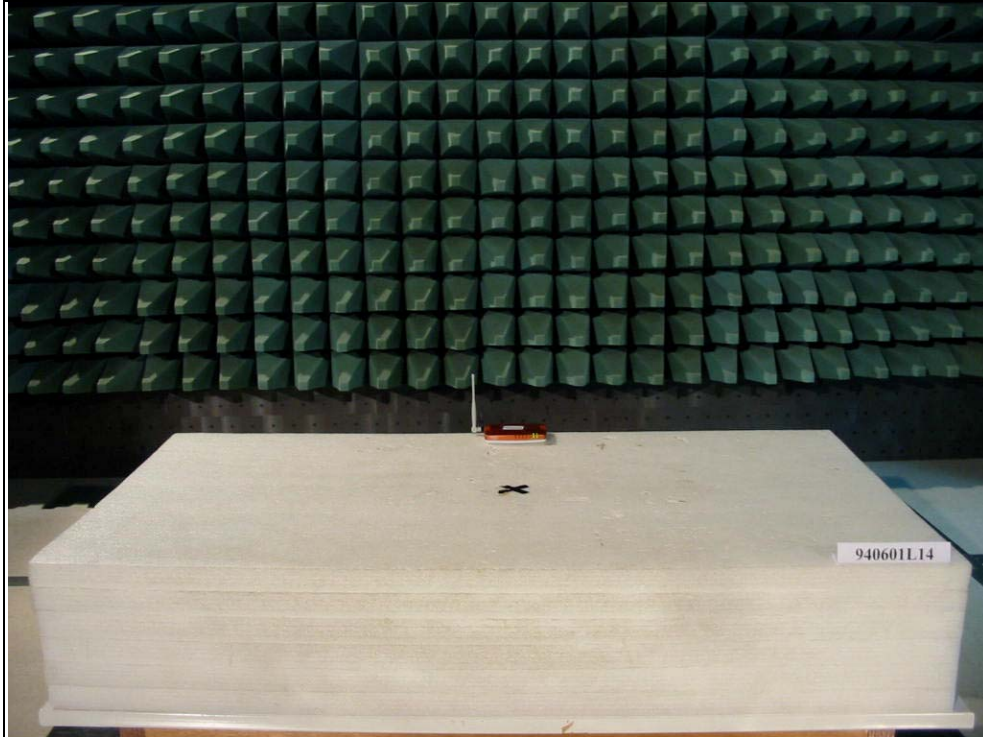



6. INFORMATION ON THE TESTING LABORATORIES

We, ADT Corp., were founded in 1988 to provide our best service in EMC, Radio, Telecom and Safety consultation. Our laboratories are accredited and approved by the following approval agencies according to ISO/IEC 17025.

USA	FCC, NVLAP, UL, A2LA
Germany	TUV Rheinland
Japan	VCCI
Norway	NEMKO
Canada	INDUSTRY CANADA , CSA
R.O.C.	CNLA, BSMI, DGT
Netherlands	Telefication
Singapore	PSB , GOST-ASIA(MOU)
Russia	CERTIS(MOU)

Copies of accreditation certificates of our laboratories obtained from approval agencies can be downloaded from our web site:

www.adt.com.tw/index.5/phtml. If you have any comments, please feel free to contact us at the following:

Linko EMC/RF Lab:
Tel: 886-2-26052180
Fax: 886-2-26052943

Hsin Chu EMC/RF Lab:
Tel: 886-3-5935343
Fax: 886-3-5935342

Hwa Ya EMC/RF/Safety Telecom Lab:
Tel: 886-3-3183232
Fax: 886-3-3185050

Linko RF Lab.
Tel: 886-3-3270910
Fax: 886-3-3270892

Web Site: www.adt.com.tw

The address and road map of all our labs can be found in our web site also