

Cover Letter

Federal Communications Commission
Authorization and Evaluation Division

Re: Application for Cellular Transceiver Type Acceptance

QUALCOMM herein submits the Application for Equipment Authorization (FCC Form 731) and Exhibits for Type Acceptance of a Cellular Transceiver, FCC ID J9CQCP-2760.

Applicant: QUALCOMM, INC.
5775 Morehouse Dr.
San Diego, CA 92121-1714

Manufacture: QUALCOMM, INC.
10300 Campus Point Drive
San Diego, California 92121

The equipment, QUALCOMM model # QCP 2760, is for mobile station cellular system use. The QCP 2760 is in full compliance with all parts of EIA/TIA/IS-98-A Mobile Station-Land Station Compatibility Specification, issue July 1996, and also in full compliance with all parts of ANSI J-STD-008, Personal Station-Base Station Compatibility Requirements for 1.8 to 2.0 GHz Code Division Multiple Access (CDMA) Personal Communications Systems, issue August 1995.

Information concerning how the ESN protection requirements are met is provided in Exhibit 3.

Request of Confidentiality

Federal Communications Commission
Authorization and Evaluation Division

Re: Request of Confidentiality

Pursuant to Sections 0.457 and 0.459 of the Commission's Rules, the Applicant hereby requests confidential treatment of information accompanying this Application as outlined below:

Description

All schematics/block diagrams
All parts lists

The above materials contain trade secrets and proprietary information not customarily released to the public. The public disclosure of these matters might be harmful to the Applicant and provide unjustified benefits to its competitors.

The Applicant understands that pursuant to Rule 0.457, disclosure of this Application and all accompanying documentation will not be made before the date of the Grant for this Application.

QUALCOMM, INC.

John Forrester
EMC Engineer

List of Exhibits

<u>Exhibit</u>	<u>Description</u>	<u>FCC Reference</u>
1	Certification of Test Data	2.911
2	General Information	2.1033(c), 2.1061,
3	ESN Protection	22.919
4	List of Semiconductor Devices	2.983(d)(6)
5	RF Output Power Measured Data - FM	2.1046
6	RF Output Power Measured Data -CDMA	2.1046, 24.232
7	Modulation Audio Response Measured Data	2.1047(a), 22.907(a)
8	Modulation Limiting Measured Data	2.1047(b)
9	Occupied Bandwidth Measured Data - FM	2.1049, 22.917
10	Occupied Bandwidth Measured Data	2.1049, 24.238
11	Conducted Spurious Emissions Measured Data	2.1051, 22.917
12	Conducted Spurious Emissions Measured Data	2.1051, 24.238
13	Radiated Spurious Emissions Measured Data	2.1053
14	Frequency Stability vs. Temperature and Voltage Measured Data	2.1055
15	Frequency Stability vs. Temperature and Voltage Measured Data	2.1055. 24.235
16	Measurement Procedures and Techniques	
17	FCC Letter of Site Recognition	
18	Circuit Diagram	2.983(d)(7)
19	Identification (Labels) Information	2.983(f)
20	Photographs	2.983(g)
21	User's Manual	2.983(d)(8)
22	SAR data	

Exhibit 1

Certification of Test Data

The data, data evaluation and equipment configuration represented herein are a true and accurate representation of the measurements of the sample's radio frequency interference emissions characteristics as of the dates and at the times of the test under the conditions herein specified. This applies to all tests that were performed that did not require an Open Area Test Site (OATS). Tests that required an OATS site were performed by TUV Product Services.

Equipment Tested: QCP-2760

Dates of Test: June 14 – June 24 1999

Test Performed by:

Engineer: John A. Forrester,

Exhibit 2**General Information**

1. Production Plans - Section 2.1033 (c)

Quantity Production Planned

2. Technical Description - Section 2.983 (d)

(1) Types of emission

40K0F8W

40K0F1D

1M25F9W

F3E voice

F3D supervisory audio tones, signaling tones

F1D wideband data signal

(2) Frequency range

The frequency range of the equipment in Domestic Public Cellular Radio Telecommunications Service bands, 824 - 849 MHz and 869 - 894 MHz for FM. The channel spacing is 30 kHz for FM.

The frequency range of the equipment in the Personal Communications Services (PCS) bands, 1851.25 – 1908.75 MHz and 1931.25 – 1988.75 MHz. The channel spacing is 1.25 MHz for CDMA.

(3) Operating power levels

The transmitter output power is independent of whether the equipment operates in the cellular system FM or CDMA mode. The equipment supports Class 3 Mobile Station Power Class, and its power output capability is reported to the Land Station via Station Class Mark. The equipment will respond to commands from the Land Station to change power levels as defined in the EIA/TIA/IS-98 Specification.

The equipment will respond to commands from the Land Station to change power levels as defined in the J-STD 008 Specification.

(4) Maximum output power

The equipment supports the maximum output power for Class 3 Mobile Station which is -2 dBW ERP, and meets the 7 W ERP (+8 dBW) maximum power limitation of Section 22.904.

The equipment is within the limited 2 watts E.I.R.P. peak power of CFR 47 Part 24.232 (b) and is able to limit the output power to the minimum necessary for successful communications.

(5) DC supply voltage and current range

The equipment is powered by lithium ion rechargeable batteries which have a voltage range of 4.1 to 3.4 Vdc.

(6) List of semiconductor active devices

See exhibit 4.

(7) Circuit diagram

See exhibit 18.

(8) User's manual

See exhibit 21.

(9) Transmitter adjustment procedure

All frequency adjustments are set at the factory and there are no frequency field adjustments for this product. Under digital mode, frequency is locked to the base station and controlled by VCTCXO adjustments to offset any possible errors.

(10) Frequency stability device

A voltage controlled, temperature compensated, crystal oscillator (VCTCXO) is employed as a frequency reference for all of the transceiver local oscillators. This crystal oscillator is specified to remain within +/- 2.5 ppm over temperature and voltage variations. The lock status indicator of all synthesizers is monitored by the microprocessor and an out of lock condition will inhibit transmission. In FM and PCS modes, the mobile receiver monitors the received signal and adjusts the frequency of the VCTCXO, this corrects any errors between the mobile frequency and the base station transmitter. The mobile is locked to the base station.

(11) Spurious radiation suppression devices

Reference Designator	Part Name	Function
FL10	Duplexer	Provides protection against transmitter spurious emissions and receiver local oscillator leakages.
U44	TX SAW filter	Provides protection against CDMA transmitter spurious emissions.
FL6	TX SAW filter	Provides protection against CDMA transmitter spurious emissions.
FL5	Ceramic filter	Provides protection against CDMA receiver local oscillator leakages.
FL7	Duplexer	Provides protection against FM transmitter spurious emissions and receiver local oscillator leakages.
FL1	TX SAW filter	Provides protection against FM transmitter spurious emissions.
FL2	Ceramic filter	Provides suppression of spurious energy and transmitter harmonics.
FL9	RX SAW filter	Provides protection against FM transmitter spurious emissions.

(12) Modulation techniques

AMPS Mode

The F3E audio modulation is accomplished through the use of Digital Signal Processor (DSP). The audio signal is converted to digital samples at 8 kHz sample rate. The samples are filtered, integrated, interpolated, and phase modulated at a 40 kHz rate. The resulting signal is then decomposed into I and Q signals, oversampled again at 160 kHz rate, and then sent to the digital-to-analog converter after proper filtering. The transmit audio modulation limiting function is performed digitally in the DSP. The pre-emphasis is performed through an IIR filter and the filtering of audio frequencies is performed through an FIR filter in DSP. The combined performance of these filters is shown in Exhibit 6 along with the actual audio frequency response of the modulated carrier signal. The DSP clocks are locked to the reference VCTCXO output signal, and maintained within ± 2.5 ppm tolerance.

CDMA Mode

The CDMA mode is described in the following pages from the TIA/EIA /IS-95 Standard. The justification for the CDMA bandwidth of 1.25 MHz is that the chip rate is 1.228 MHz (see page 6-10 of IS-95). When we look 3 dB down from the signal we find 1.25 MHz. Channel spacing is normally set at this 1.25 MHz. Also, one can reference baseband filtering requirements (page 6-27 TIA/EIA/IS-95) for filtering frequency response limits.

6.1.3 Modulation Characteristics

6.1.3.1 Reverse CDMA Channel Signals

The Reverse CDMA Channel is composed of Access Channels and Reverse Traffic Channels. These channels shall share the same CDMA frequency assignment using direct-sequence CDMA techniques. Figure 6.1.3.1-1 shows an example of all of the signals received by a base station on the Reverse CDMA Channel. Each Traffic Channel is identified by a distinct user long code sequence; each Access Channel is identified by a distinct Access Channel long code sequence. Multiple Reverse CDMA Channels may be used by a base station in a frequency division multiplexed manner.

The Reverse CDMA Channel has the overall structure shown in Figure 6.1.3.1-2. Data transmitted on the Reverse CDMA Channel is grouped into 20 ms frames. All data transmitted on the Reverse CDMA Channel is convolutionally encoded, block interleaved, modulated by the 64-ary orthogonal modulation, and direct-sequence spread prior to transmission.

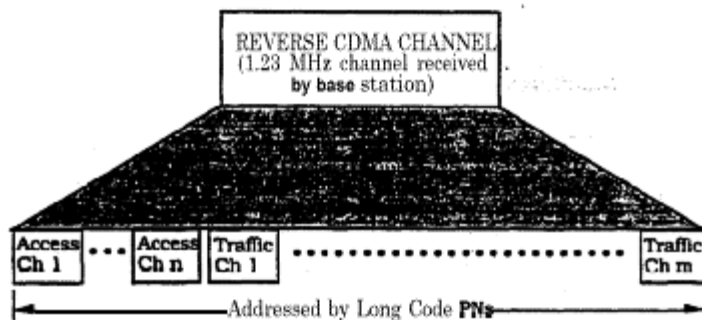

Figure 6.1.3.1-1. Example of Logical Reverse CDMA Channels Received at a Base Station

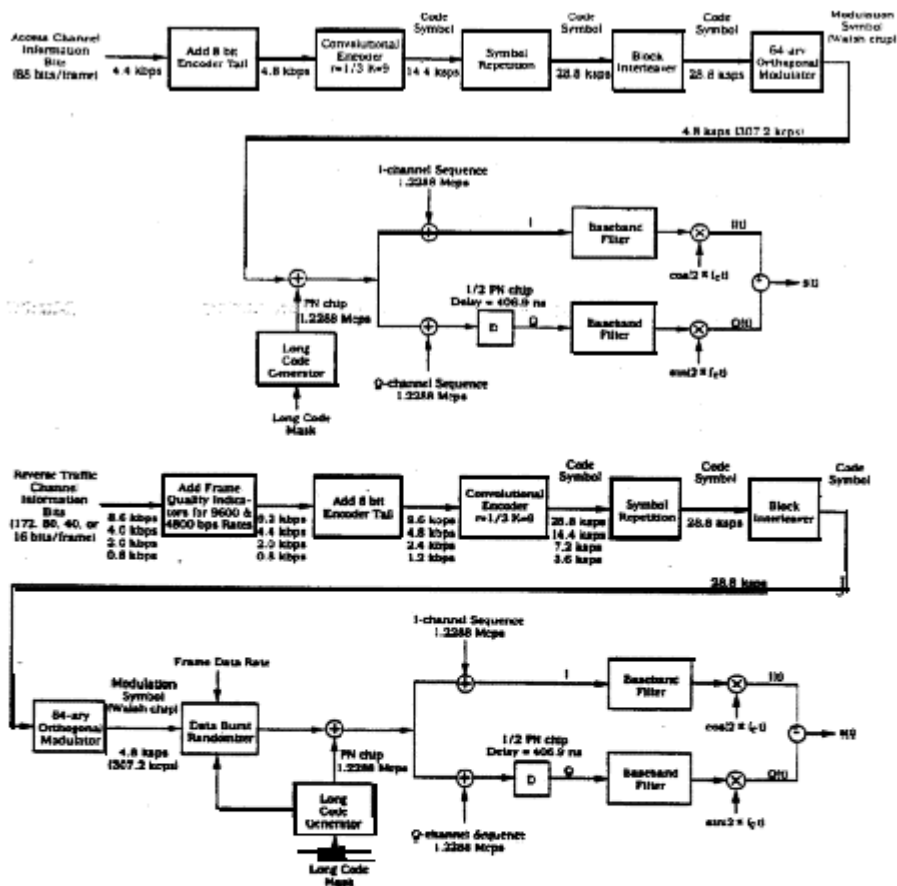

Figure 6.1.3.1-2. Reverse CDMA Channel Structure

After adding frame quality indicators for both the 9600 bps and 4800 bps rates (see 6.1.3.3.2.1) and adding eight Encoder Tail Bits (see 6.1.3.3.2.2), data frames may be transmitted on the Reverse **Traffic** Channel at data rates of 9600, **4800**, **2400**, and 1200 bps. The Reverse **Traffic** Channel may use any of these **data** rates for transmission. The transmission duty cycle on the Reverse Traffic Channel varies with the transmission data rate. Specifically, the transmission duty cycle for 9600 bps frames is 100 percent, the transmission duty cycle for 4800 bps frames is 50 percent, the transmission duty cycle for 2400 bps frames is 25 percent, and the **transmission** duty cycle for 1200 bps frames is 12.5 percent as shown in Table 6.1.3.1.1-1. As the duty cycle for transmission varies **proportionately** with the data rate, the actual burst transmission rate is fixed at 28,800

code symbols per second. Since **six** code symbols are modulated as one of 64 modulation symbols for transmission, the modulation **symbol** transmission rate is fixed at 4800 modulation symbols per second. This results in a **fixed** Walsh chip rate of 307.2 kcps. The rate of the spreading PN sequence is fixed at 1.2288 **Mcps**, so that each Walsh chip is spread by four PN chips. Table 6.1.3.1.1- 1 defines the signal rates and their relationship for the various transmission rates on the Reverse Traffic Channel.

The numerology is identical for the Access Channel except that the transmission rate is **fixed** at 4800 bps after adding eight Encoder Tail Bits (see 6.1.3.2.2). Each code symbol is repeated once, and the transmission duty cycle is 100 percent. Table 6.1.3.1.1-2 defines the signal rates and their relationship on the Access Channel.

6.1.3.1.1 Modulation Parameters

The modulation parameters for the Reverse Traffic Channel and the Access Channel are shown in Table 6.1.3.1.1- 1 and Table 6.1.3.1.1-2, respectively.

Table 6.1.3.1.1-1. Reverse Traffic Channel Modulation Parameters

Parameter	Data Rate (bps)				Units
	9600	4800	2400	1200	
PN Chip Rate	1.2288	1.2288	1.2288	1.2288	Mcps
Code Rate	1/3	1/3	1/3	1/3	bits/code sym
Transmit Duty Cycle	100.0	50.0	25.0	12.5	%
Code Symbol Rate	28,800	28,800	28,800	28,800	sps
Modulation	6	6	6	6	code sym/mod symbol
Modulation Symbol Rate	4800	4800	4800	4800	sps
Walsh Chip Rate	307.20	307.20	307.20	307.20	kcps
Mod Symbol Duration	208.33	208.33	208.33	208.33	µs
PN Chips/Code Symbol	42.67	42.67	42.67	42.67	PN chip/code symbol
PN Chips/Mod symbol	256	256	256	256	PN chip/mod symbol
PN Chips/Walsh Chip	4	4	4	4	PN chips/Walsh chip

Exhibit 3

ELECTRONIC SERIAL NUMBERS (ESN) Protection

The Cellular Portable Phone, FCC ID: J9ARJS2 use ESN. The ESN is a unique identification number to each phone which is contained in the Numeric Assignment Module and is automatically transmitted to the base station whenever a cellular call is placed. The ESN is stored in an EPROM and is isolated from fraudulent contact and tampering. Any attempt to change the ESN will render the portable phone inoperative.

The phone complies with all requirements for ESN under Part 22.919.

Exhibit 4

List of Semiconductor Devices

See the parts lists for the semiconductor devices.

Exhibit 5Transmitter RF Power Output - FCC part 2, Paragraph 2.1046**Transmitter RF Power Output - FCC part 2, Paragraph 2.1046**

6/22/99

The RF output power was measured using a HP 8594 Spectrum Analyzer that has the CDMA personality option. Terminated to a resistive coaxial load of 50 ohms.

carrier frequency (MHz)	channel	RF output power (W)
		FM
		measured
824.04	991	0.302
836.49	383	0.309
848.97	799	0.302

Transmitter RF Power Output - FCC part 2, Paragraph 2.1046

Transmitter RF Power Output - FCC part 2, Paragraph 2.1046

6/22/99

The RF output power was measured using the isotropic equation, $P=(E \times D)^2/49.8$, where E is the field strength in V/m, D is the distance at 3 meters and P is the output power in watts.

carrier frequency (MHz)	channel	RF output power (W)
		FM measured
824.04	991	0.470
836.49	383	0.481
848.97	799	0.470

Exhibit 6Transmitter RF Power Output - FCC part 24, Paragraph 2.1046, 24.232 (b)**Transmitter RF Power Output - FCC part 24, Paragraph 2.1046, 24.232 (b)**

6/22/99

The RF output power was measured using a HP 8594 Spectrum Analyzer that has the CDMA personality option. Terminated to a resistive coaxial load of 50 ohms.

carrier frequency (MHz)	channel	RF output power (W)
		CDMA
		measured
1851.25	25	0.162
1880	600	0.158
1908.75	1175	0.158

Transmitter RF Power Output - FCC part 24, Paragraph 2.1046, 24.232 (b)**Transmitter RF Power Output - FCC part 24, Paragraph 2.1046, 24.232 (b)**

6/22/99

The RF output power was measured using the isotropic equation, $P=(E \times D)^2/30$, where E is the field strength in V/m, D is the distance at 3 meters and P is the output power in watts.

		RF output power (W)
carrier frequency (MHz)	channel	CDMA
		measured
1851.25	25	0.444
1880	600	0.454
1908.75	1175	0.454

Exhibit 7

Modulation Audio Response Measured Data FCC Part 2, Paragraph 2.1047 (b)

Baseband Audio Response

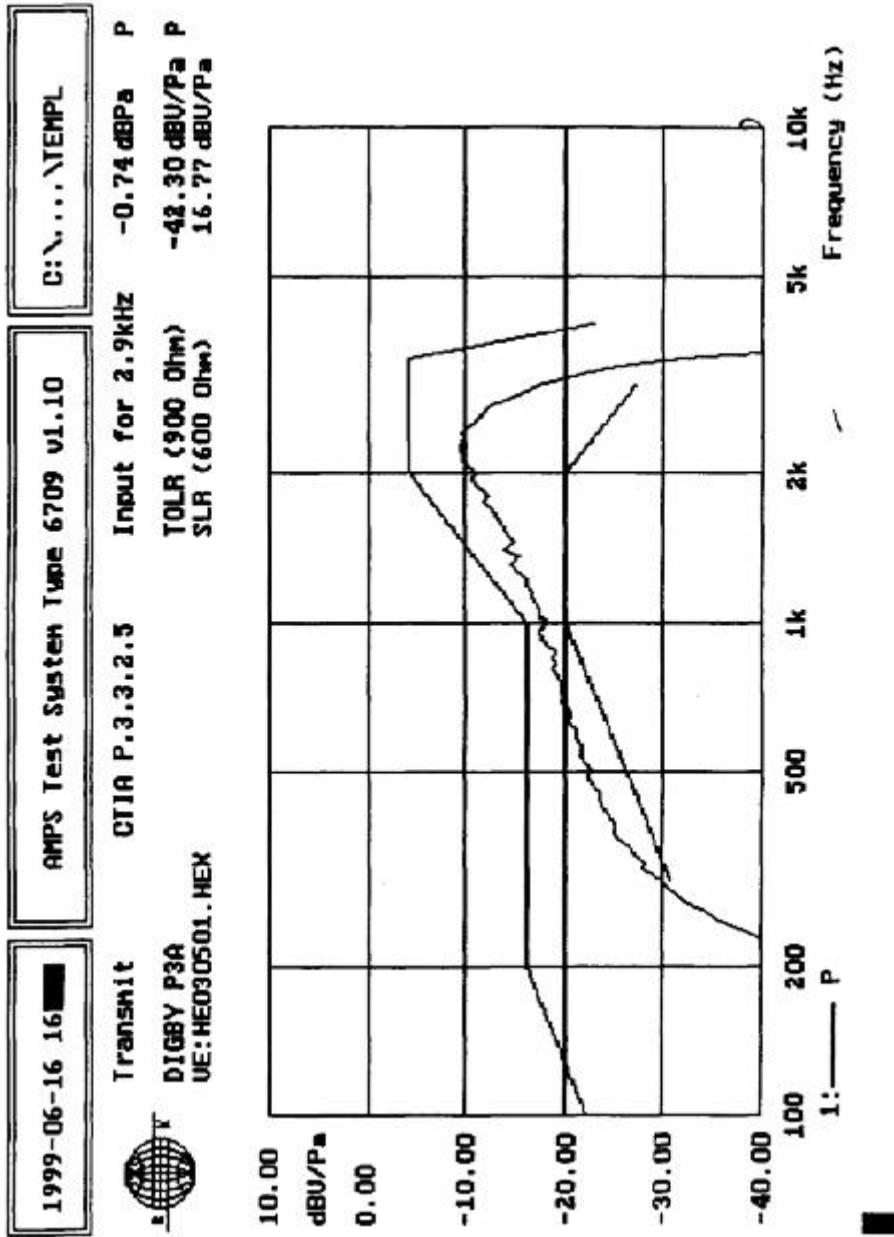

Transmitter Modulation Requirement - FCC part 2, Paragraph 2.1047 (a)

Measured with HP8920 RF communication analyzer & HP 3588A spectrum analyzer
Measurements above 3,700 Hz were not possible due to excessively high audio tone.

Audio Frequency Response (<3 kHz)

	audio freq (Hz)	audio level (mV)	dB relative to 1 kHz	lower limit	upper limit
1	100	2119	-28.99	-23.00	-19.00
2	126	1634	-26.73	-20.99	-16.99
3	158	1256	-24.44	-19.03	-15.03
4	200	795	-20.47	-16.98	-12.98
5	251	420	-14.93	-15.01	-11.01
6	300	321	-12.59	-13.46	-9.46
7	316	288	-11.65	-13.01	-9.01
8	398	207	-8.78	-11.00	-7.00
9	501	154	-6.21	-9.00	-5.00
10	631	119	-3.98	-7.00	-3.00
11	794	93.3	-1.86	-5.00	-1.00
12	1000	75.3	0.00	-3.00	1.00
13	1259	57.9	2.28	-1.00	3.00
14	1585	45.3	4.41	1.00	5.00
15	1995	35.1	6.63	3.00	7.00
16	2512	28.9	8.32	5.00	9.00
17	2700	28.1	8.56	5.63	9.63
18	2800	28.8	8.35	5.94	9.94
19	3000	32.5	7.30	6.54	10.54
20	3100	36.1	6.39	6.83	10.83
21	3200	42	5.07	7.10	11.10
22	3300	52.6	3.12	7.37	11.37
23	3500	143	-5.57	7.88	11.88
24	3700	1692	-27.03	8.36	12.36

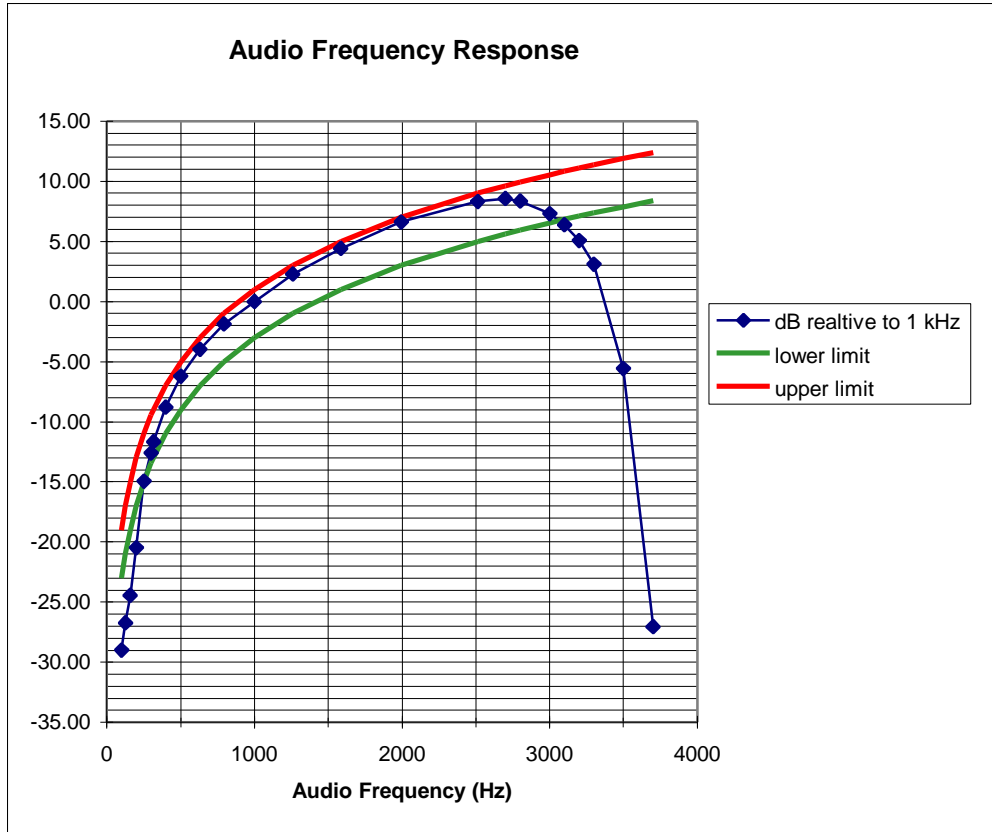

Audio Frequency Response (> 3 kHz)

freq	dev (dB)	dB from 3 kHz	upper limit
3000	-1.81	0	0.00
3500	-11.4	-9.59	-2.68
4000	-61.5	-59.69	-5.00
4500	-52.3	-50.49	-7.04
5000	-43.07	-41.26	-8.87
5900	-66.12	-64.31	-11.75
6000	-66.12	-64.31	-35.00
6100	-57.62	-55.81	-35.00
6100	-65.3	-63.49	-35.00
7000	-65.3	-63.49	-35.00
8500	-66.28	-64.47	-14.72
10000	-62.88	-61.07	-18.09
12000	-62.37	-60.56	-20.92
15000	-64.5	-62.69	-24.08
20000	-61.3	-59.49	-27.96
25000	-66.09	-64.28	-28.00
30000	-66.93	-65.12	-28.00
30000	-64.65	-62.84	-28.00

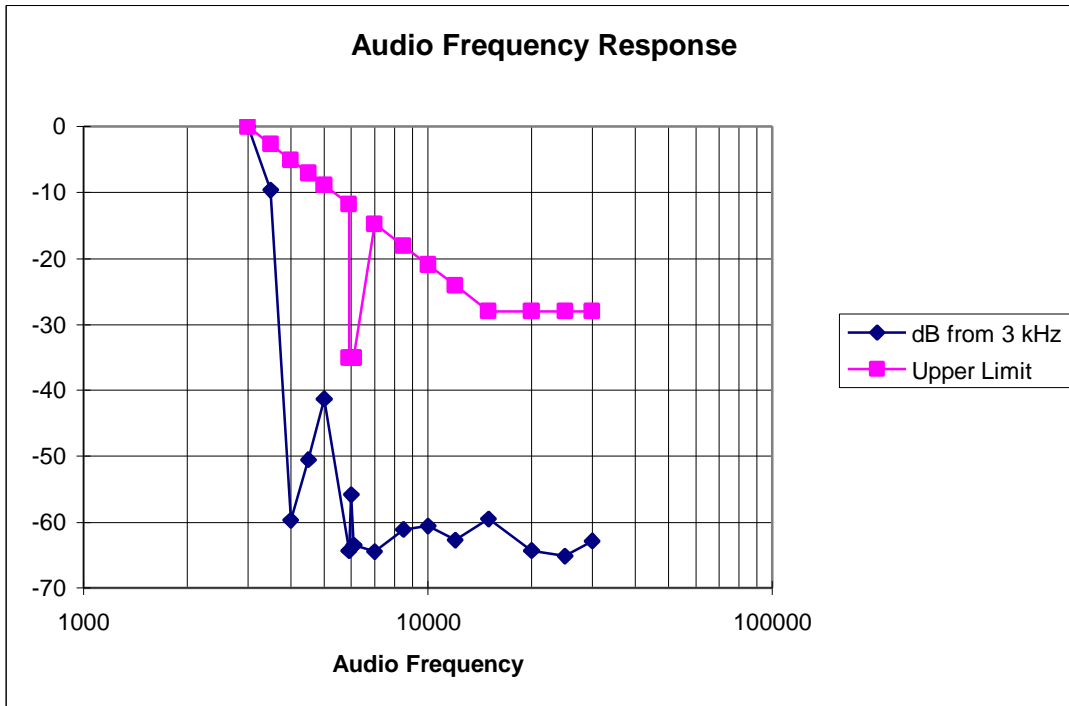

Exhibit 8

Transmitter Modulation Requirement - FCC Part 2, Paragraph 2.1047 (b)

Transmitter Modulation Requirement - FCC part 2, Paragraph 2.1047 (b)

Measured with HP8920 RF communication analyzer

Audio Input Level (dB)	FM deviation (kHz peak)		
	Modulation frequency		
(0dB=8kHz dev)	400 Hz	1 kHz	2.7 kHz
-20	1.55	3.7	7.07
-15	1.79	4.77	8.08
-10	2.16	6.12	8.58
-5	2.64	7.9	8.75
0	3.23	8	8.86
5	4.87	9.2	8.87
10	7.89	10.1	8.85
15	9.01	10.96	8.84
20	9.25	10.5	8.84

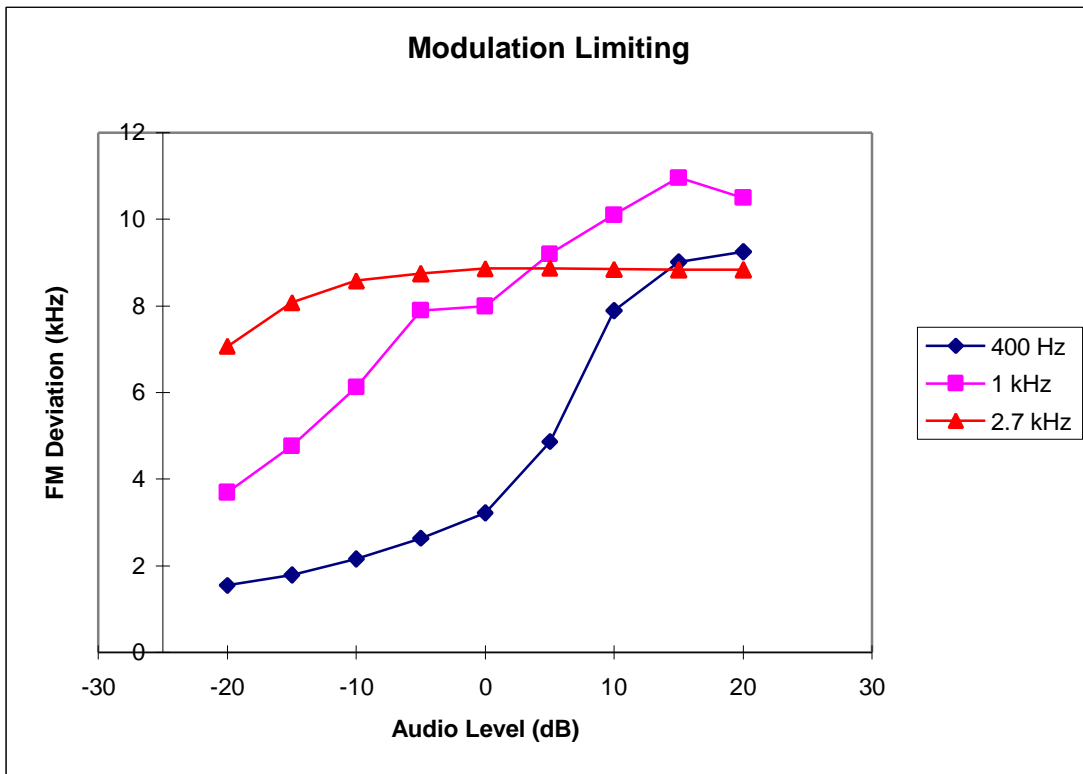
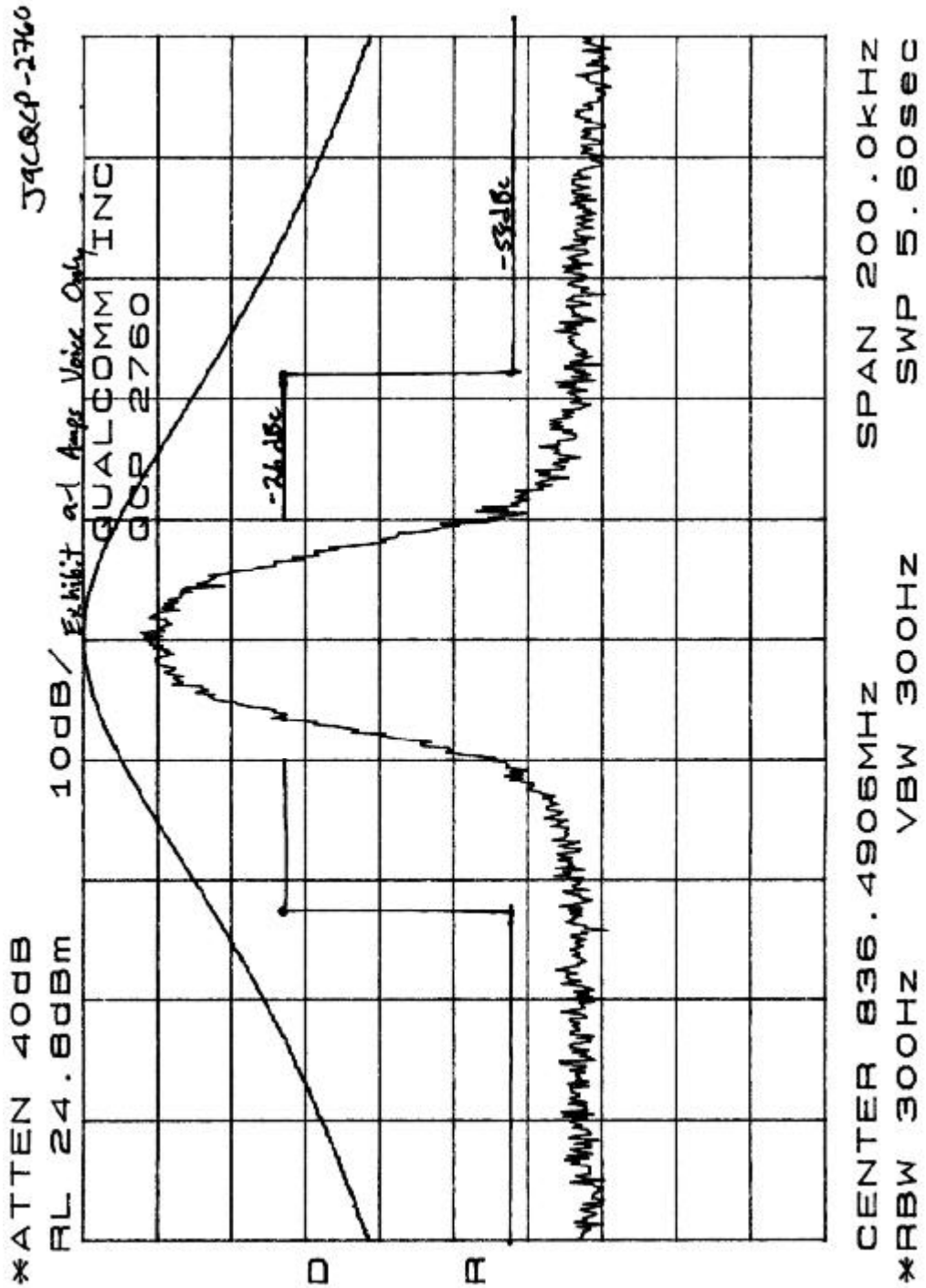

Exhibit 9**Occupied Bandwidth Measured Data****List of Exhibits**

<u>Exhibit</u>	<u>Description</u>	<u>FCC Reference</u>
a-1	AMPS voice, ± 100 kHz from carrier frequency	2.1049, 22.917
a-2	AMPS voice, + 90 kHz from carrier frequency up to 2nd harmonic	2.1049, 22.917
a-3	AMPS voice, 0 Hz to -90 kHz from carrier frequency	2.1049, 22.917
a-4	AMPS voice, 869 - 894 MHz	2.1049, 22.917
b-1	AMPS voice + SAT, ± 100 kHz from carrier frequency	2.1049, 22.917
b-2	AMPS voice + SAT, + 90 kHz from carrier frequency up to 2nd harmonic	2.1049, 22.917
b-3	AMPS voice + SAT, 0 Hz to -90 kHz from carrier frequency	2.1049, 22.917
b-4	AMPS voice + SAT, 869 - 894 MHz	2.1049, 22.917
c-1	AMPS SAT, ± 100 kHz from carrier frequency	2.1049, 22.917
c-2	AMPS SAT, + 90 kHz from carrier frequency up to 2nd harmonic	2.1049, 22.917
c-3	AMPS SAT, 0 Hz to -90 kHz from carrier frequency	2.1049, 22.917
c-4	AMPS SAT, 869 - 894 MHz	2.1049, 22.917
d-1	AMPS ST, ± 100 kHz from carrier frequency	2.1049, 22.917
d-2	AMPS ST, + 90 kHz from carrier frequency up to 2nd harmonic	2.1049, 22.917
d-3	AMPS ST, 0 Hz to -90 kHz from carrier frequency	2.1049, 22.917
d-4	AMPS ST, 869 - 894 MHz	2.1049, 22.917
e-1	AMPS ST + SAT, ± 100 kHz from carrier frequency	2.1049, 22.917
e-2	AMPS ST + SAT, + 90 kHz from carrier frequency up to 2nd harmonic	2.1049, 22.917
e-3	AMPS ST + SAT, 0 Hz to -90 kHz from carrier frequency	2.1049, 22.917
e-4	AMPS ST + SAT, 869 - 894 MHz	2.1049, 22.917
f-1	SAT & DTMF, ± 100 kHz from carrier frequency	2.1049, 22.917
f-2	SAT & DTMF, + 90 kHz from carrier frequency up to 2nd harmonic	2.1049, 22.917
f-3	SAT & DTMF, 0 Hz to -90 kHz from carrier frequency	2.1049, 22.917
f-4	SAR & DTMF, 869 - 894 MHz	2.1049, 22.917
g-1	AMPS WIDEBAND, ± 100 kHz from carrier frequency	2.1049, 22.917
g-2	AMPS WIDEBAND, + 90 kHz from carrier frequency up to 2nd harmonic	2.1049, 22.917
g-3	AMPS WIDEBAND, 0 Hz to -90 kHz from carrier frequency	2.1049, 22.917
g-4	AMPS WIDEBAND, 869 - 894 MHz	2.1049, 22.917

Exhibit 10

Occupied Bandwidth Measured Data – FCC Part 2.1049, 24.238



*ATTEN 40dB

RL 24.8dBm

10dB/Exhibit

a-2 Amps Voice Only

JAL GCP-2760

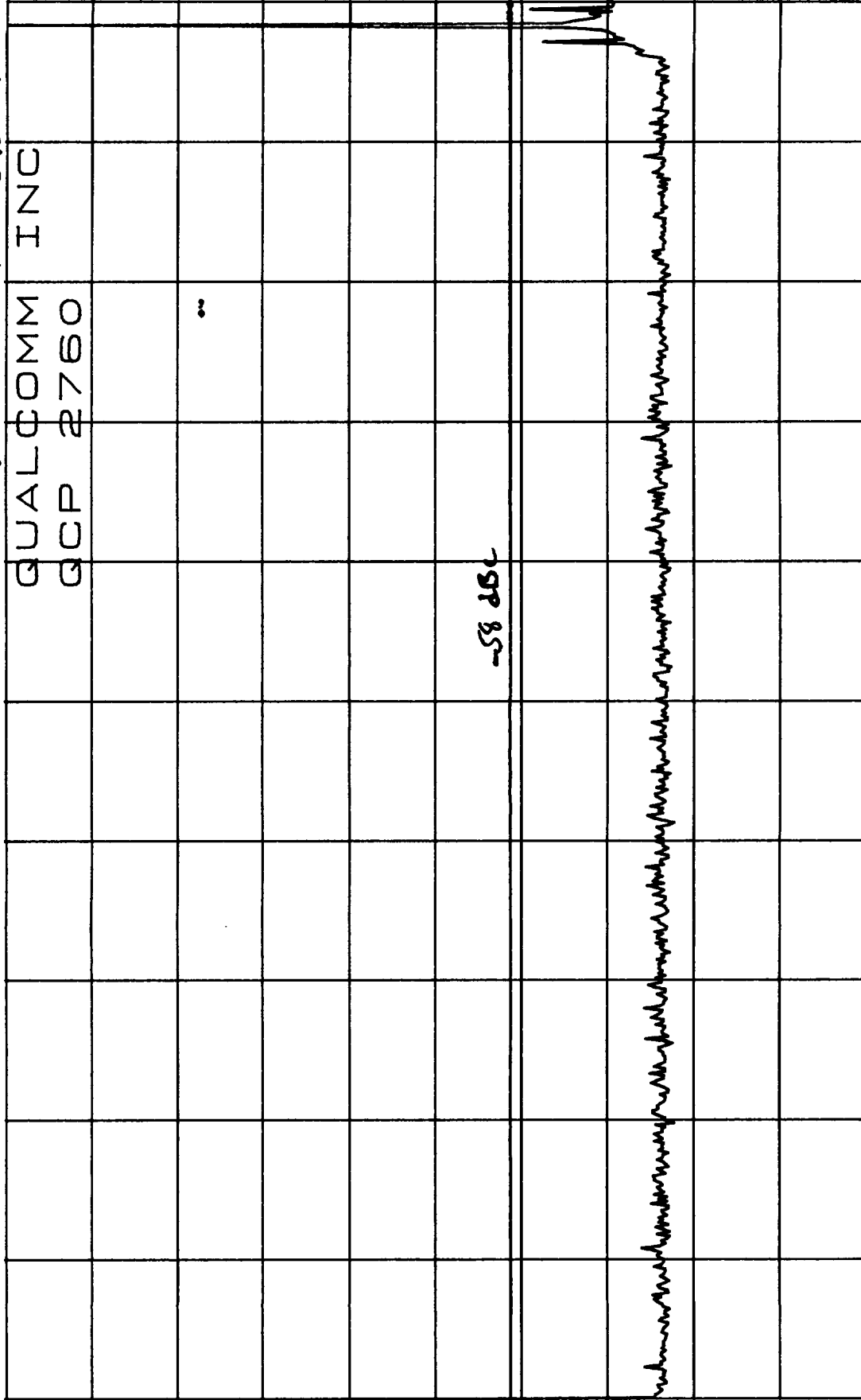

D

R

START 0HZ

*RBW 30KHZ

STOP 850.0MHZ

VBW 30KHZ

SWP 2.40sec

*ATTEN 40dB

RL 24.8dBm

10dB/

Exhibit a-3 Amps Voice Only J900P.2760

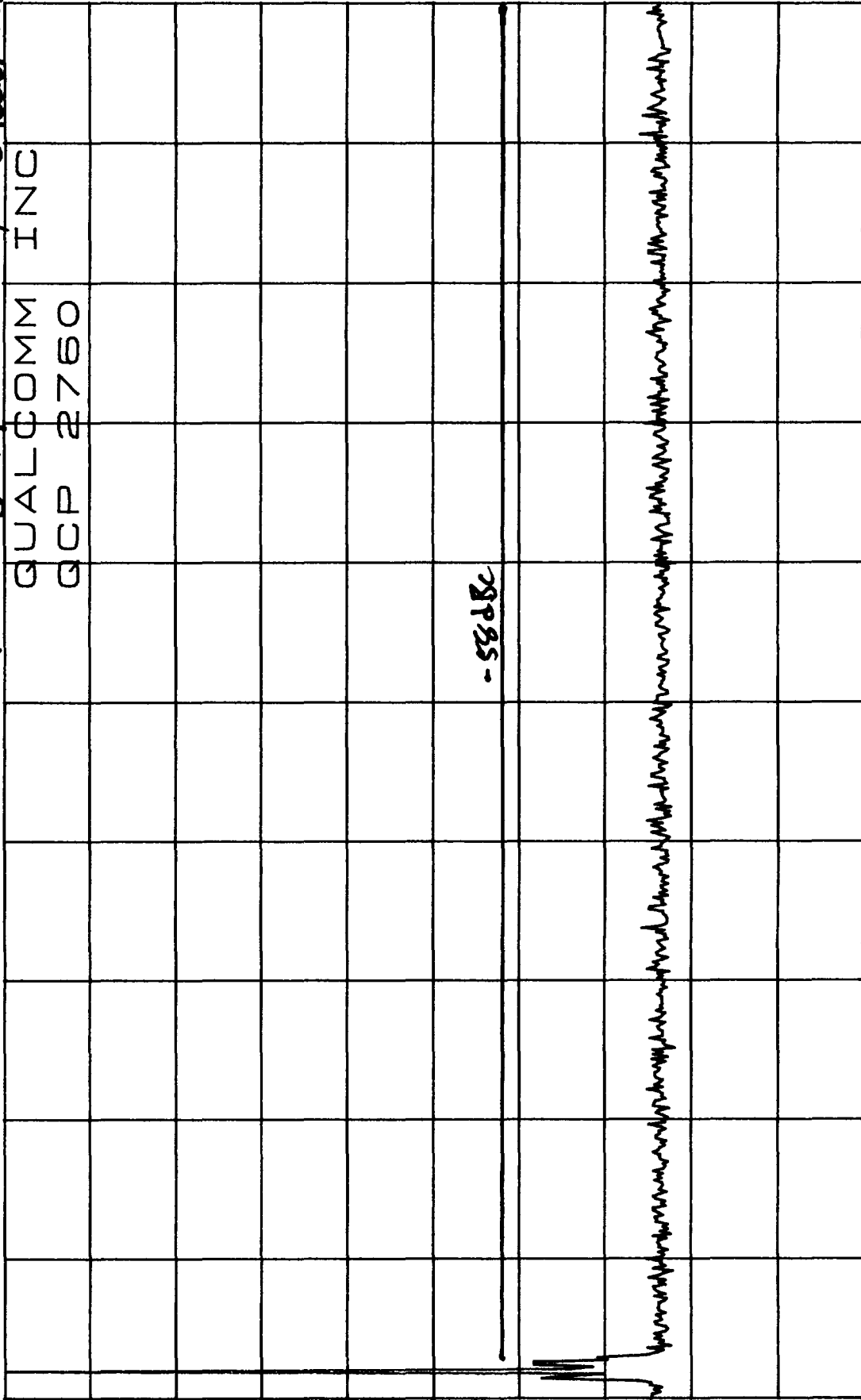

D

R

START 800MHZ

STOP 2.700GHZ

*RBW 30KHZ

VBW 30KHZ

SWP 5.30sec

*ATTEN 0dB

RL -40.0dBm

10dB/

Exhibit

a-4 AMPS VOICE ONLY

JALGCP-2760

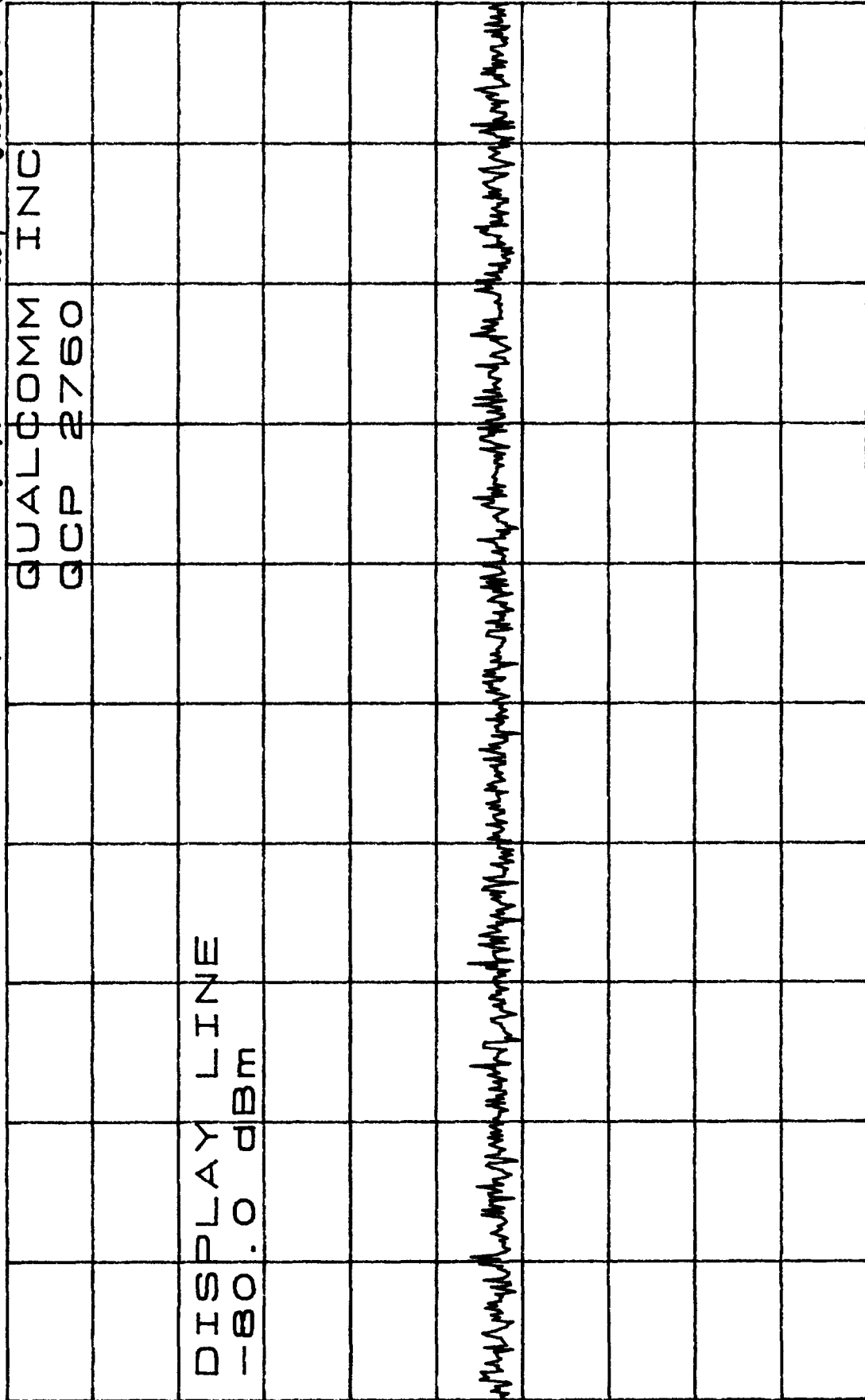

DISPLAY LINE
-80.0 dBm

CENTER 881.50MHZ

SPAN 25.00MHZ

*RBW 30KHZ

VBW 30KHZ

SWP 70.0ms

D

R

*ATTEN 40dB

RL 24.8dBm

10dB/

Exhibit 01 AAB Voice + SAT

J9C QCP-2760

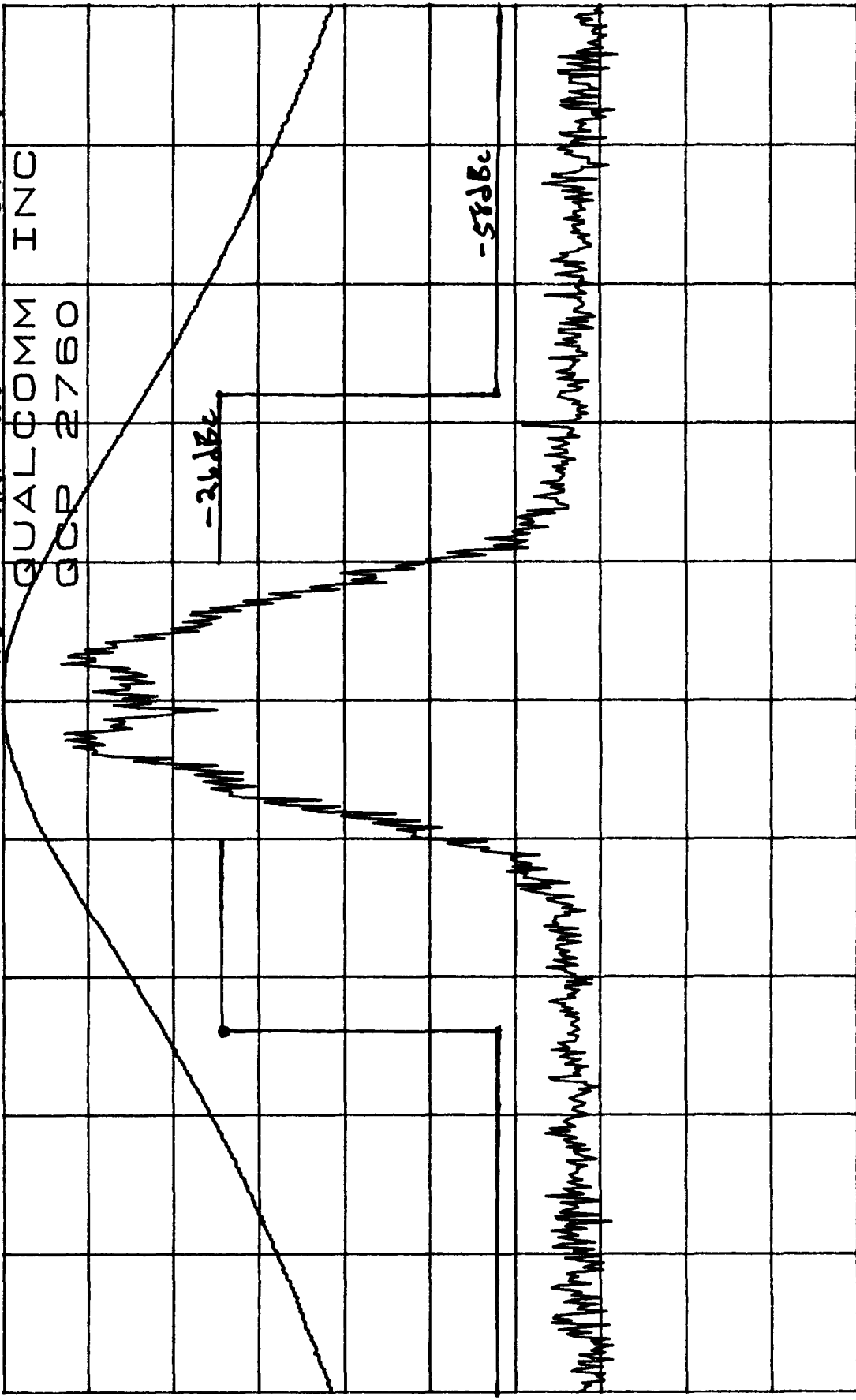

CENTER 836.4906MHZ

SPAN 200.0KHZ

*RBW 300HZ

VBW 300HZ

SWP 5.60SEC

*ATTEN 40dB

RL 24.8dBm

10dB /

Exhibit 6-2 Amps Voice + SAT

J9C QCP-2760

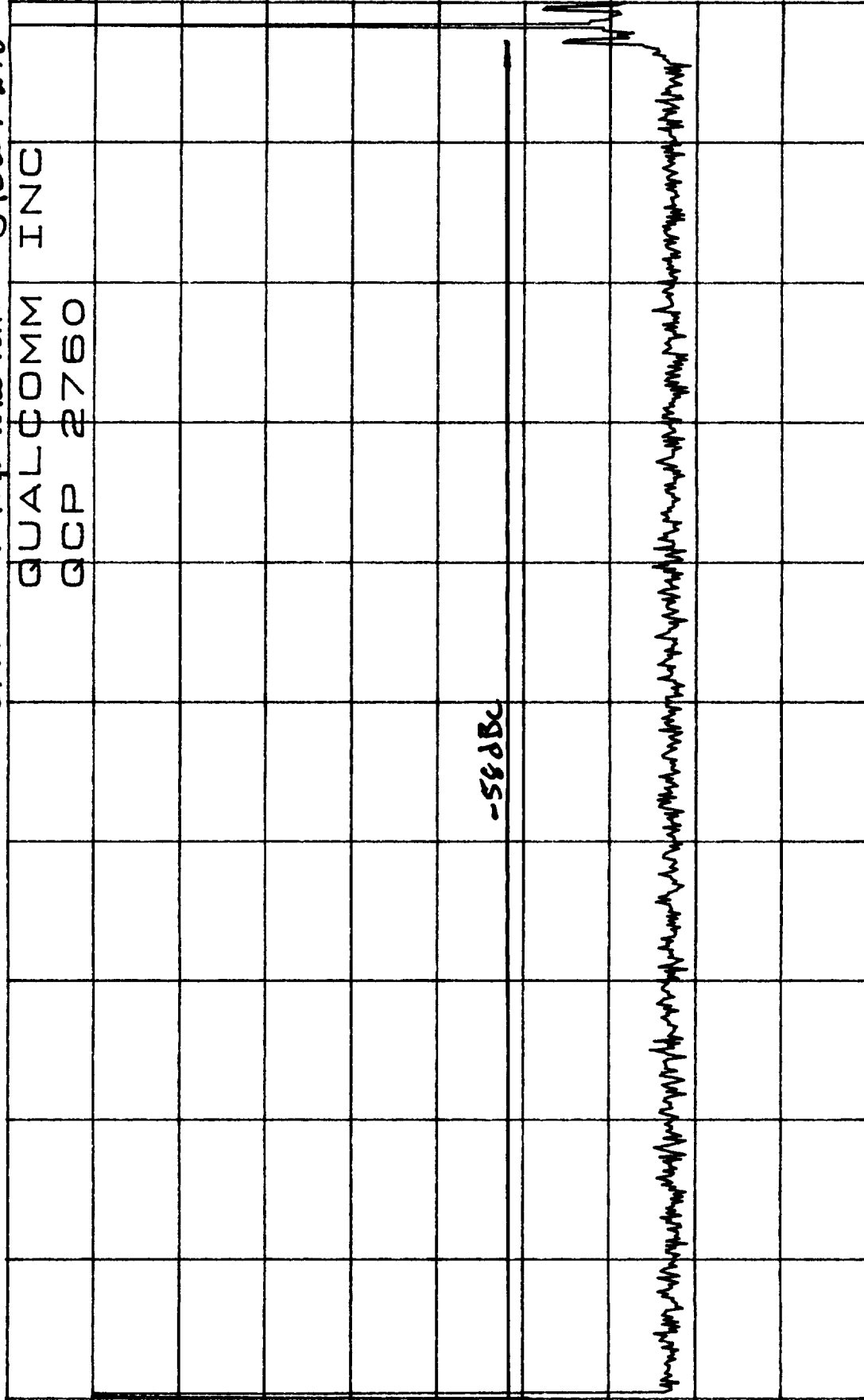

START 0HZ
*RBW 30KHZ

VBW 30KHZ

STOP 850.0MHZ

SWP 2.40sec

*ATTEN 40dB

RL 24.8dBm

10dB/

Exhibit 6-3 Amps Voice + SFT

J9CACP-2760

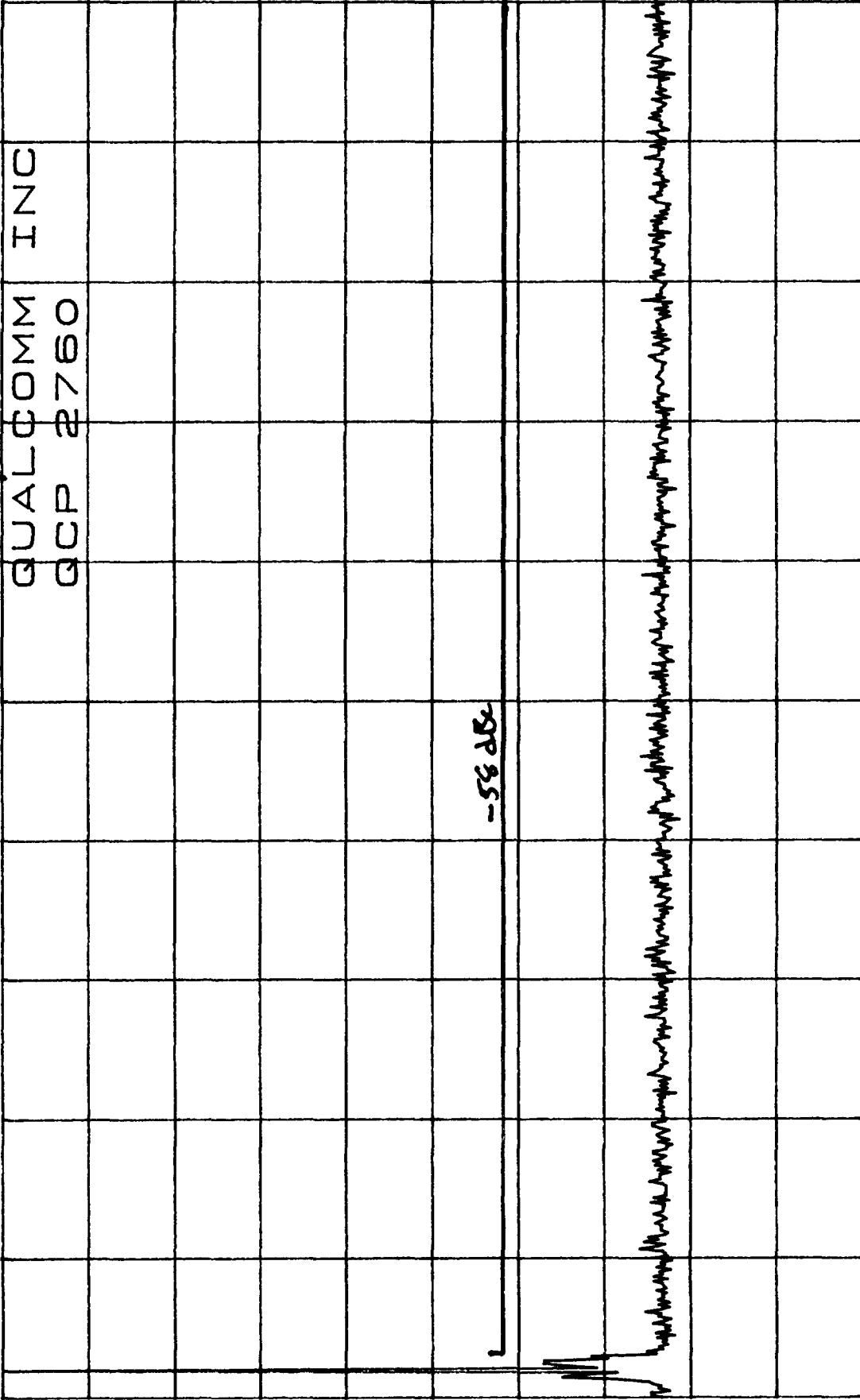

START 800MHZ

STOP 2.700GHZ

*RBW 30KHZ

VBW 30KHZ

SWP 5.30sec

*ATTEN 0dB

RL -40.0dBm

10dB / Exhibit

b-y AMPS VOICE+SAT

J9C8CP-2760

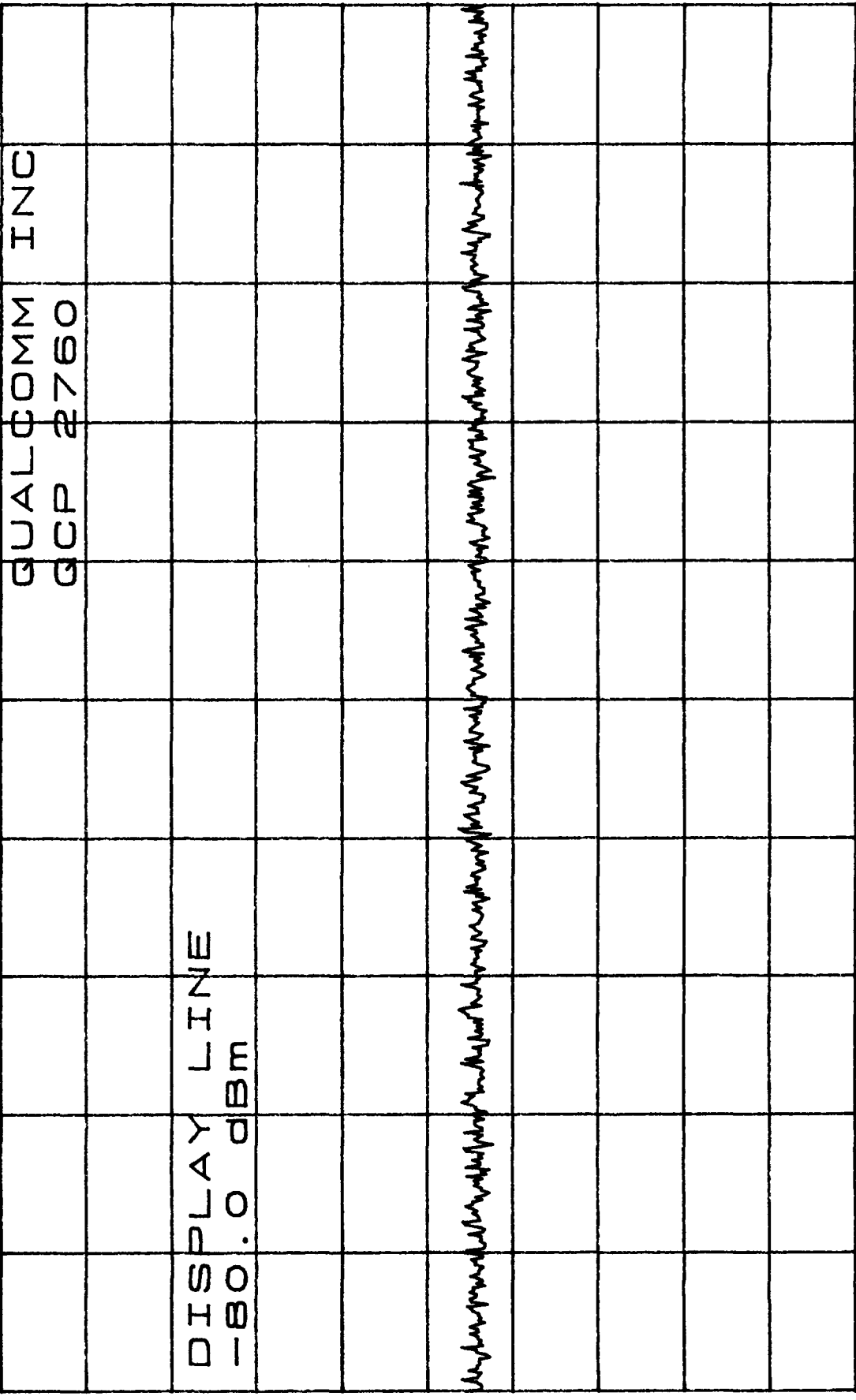

D

R

CENTER 881.50MHZ

SPAN 25.00MHZ

*RBW 30KHZ

VBW 30KHZ

SWP 70.0ms

*ATTEN 40dB

RL 24.8dBm

10dB/

Exhibit c-1 AAPS SAT

J900CP-2760

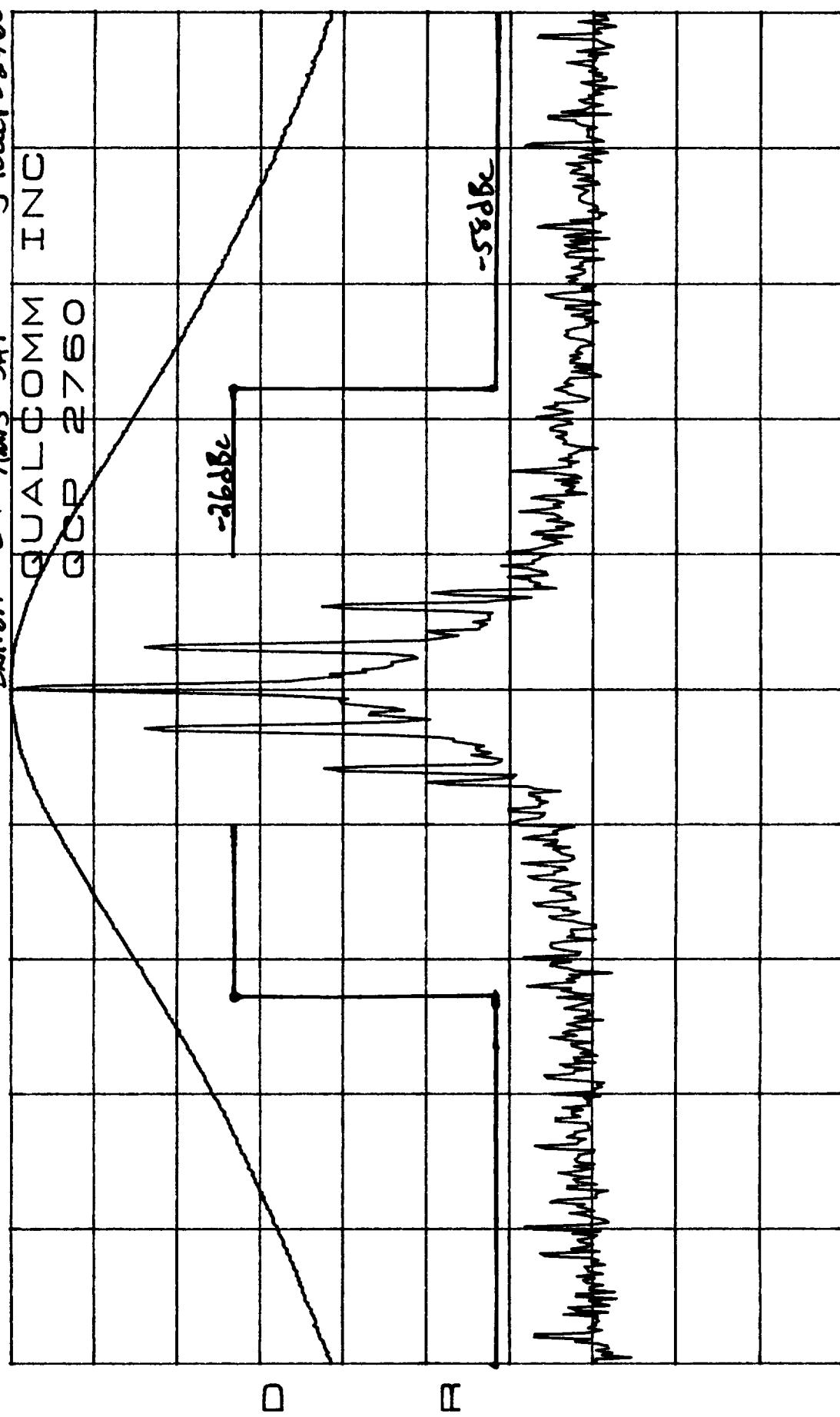

CENTER 836.4906MHZ

SPAN 200.0KHZ

*RBW 300HZ

VBW 300HZ

SWP 5.60SEC

*ATTEN 40dB

RL 24.8dBm

10dB / Exhibit 02 AMPS SAT

JAGGCP-2760

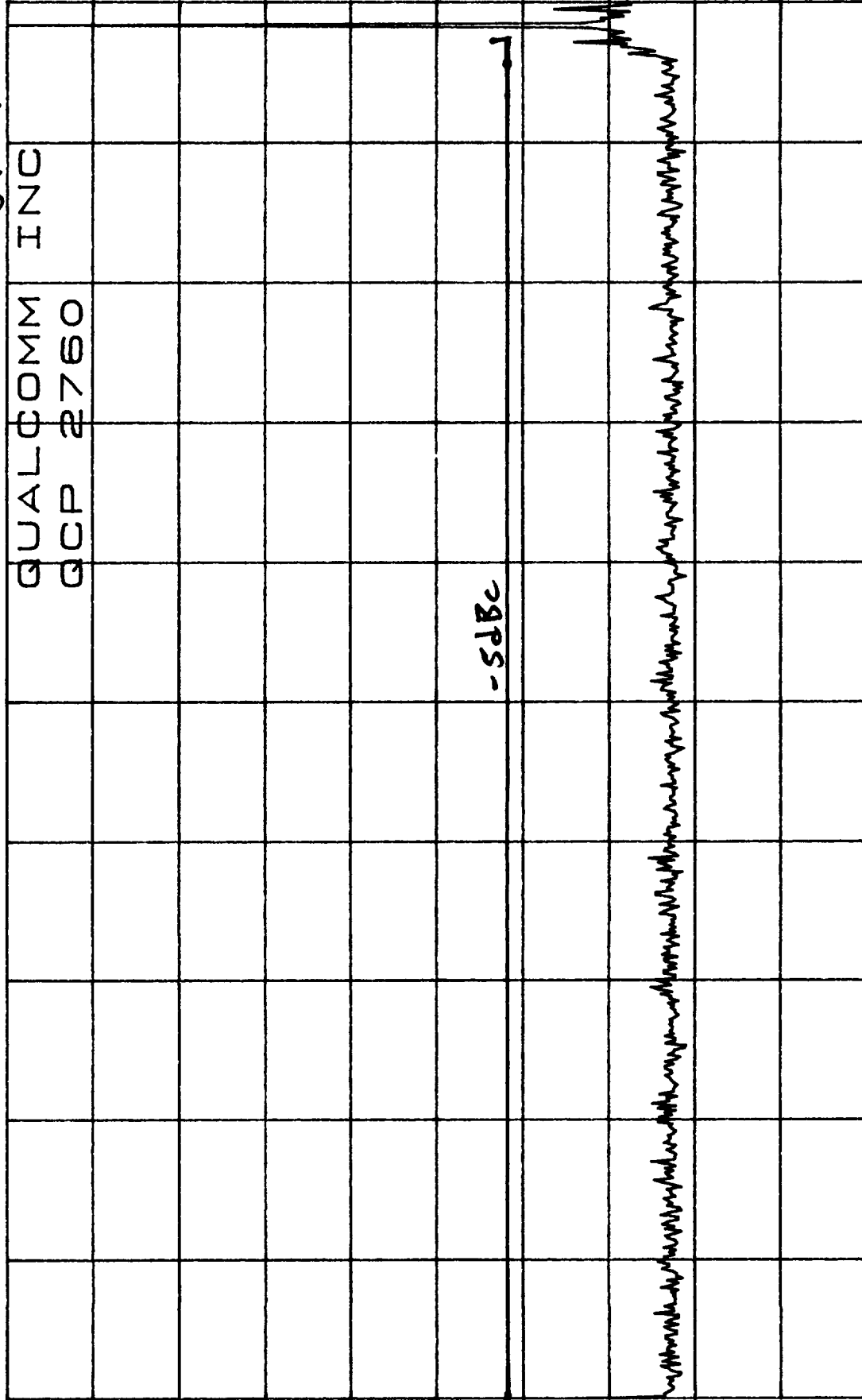

D

R

START 0HZ

*RBW 30KHZ

STOP 850.0MHZ

VBW 30KHZ

SWP 2.40sec

*ATTEN 40dB

RL 24.8dBm

10dB/

Exhibit c-3 AMPS SAT 5902LP-2760

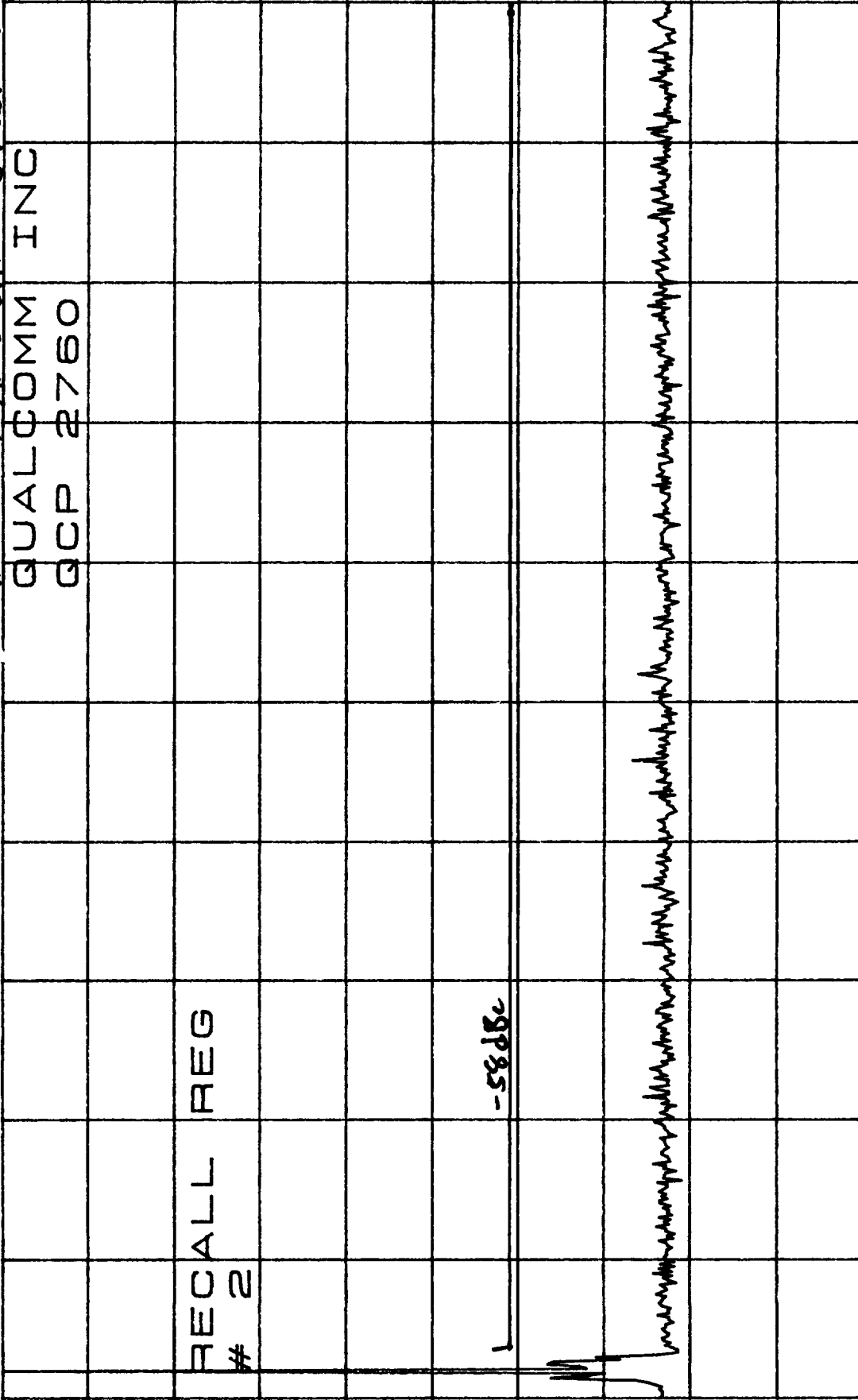

D

R

START 800MHZ

STOP 2.700GHZ

*RBW 30KHZ

VBW 30KHZ

SWP 5.30sec

*ATTEN 40dB

RL 24.8dBm

10dB/Exhibit

Qualcomm

2760

590288-2760

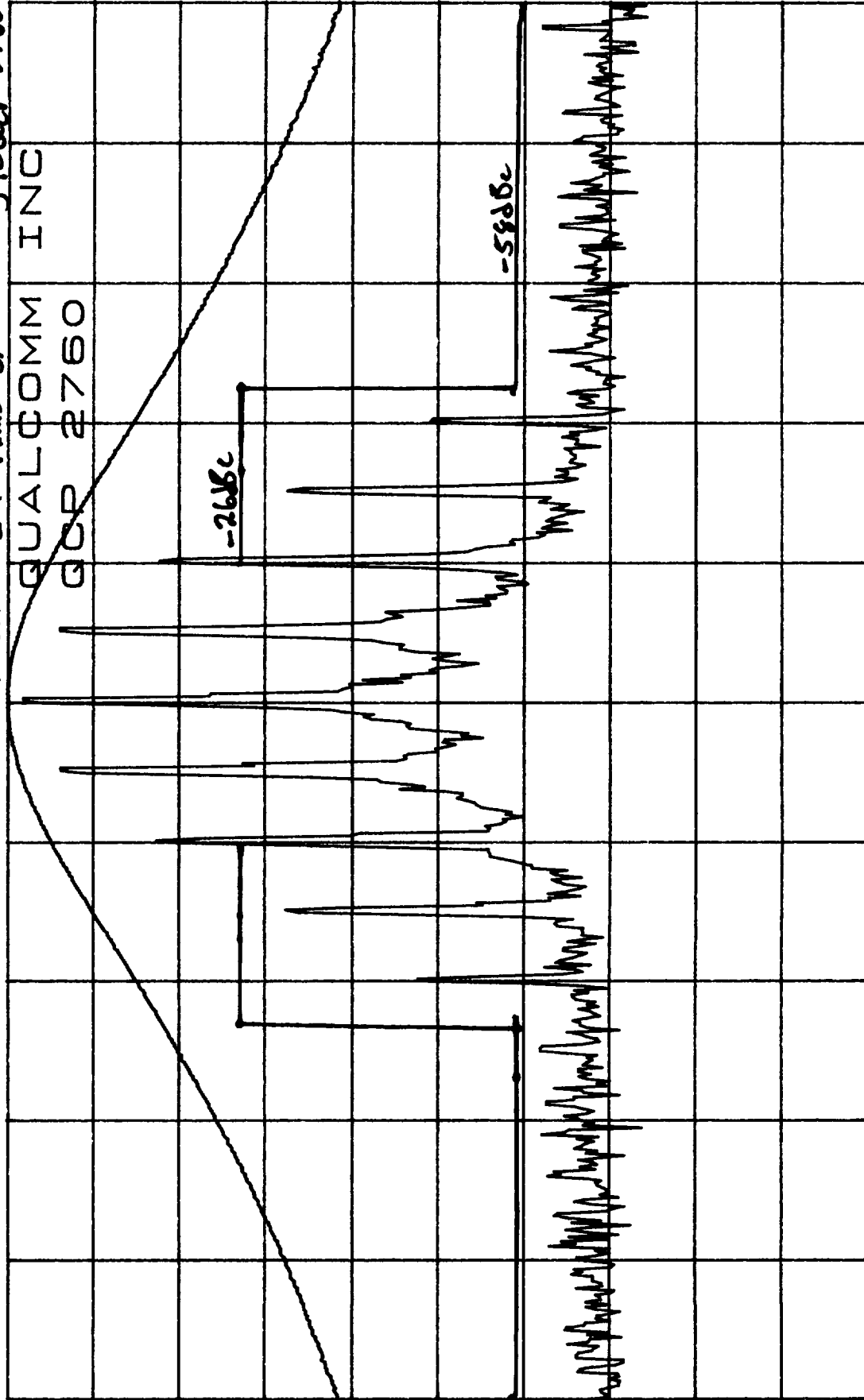

CENTER 836.4906MHZ

SPAN 200.0KHZ

*RBW 300HZ

VBW 300HZ

SWP 5.60sec

*ATTEN 40dB

RL 24.8dBm

10dB/

Exhibit

J-2 AMP ST

JNCOCP-2760

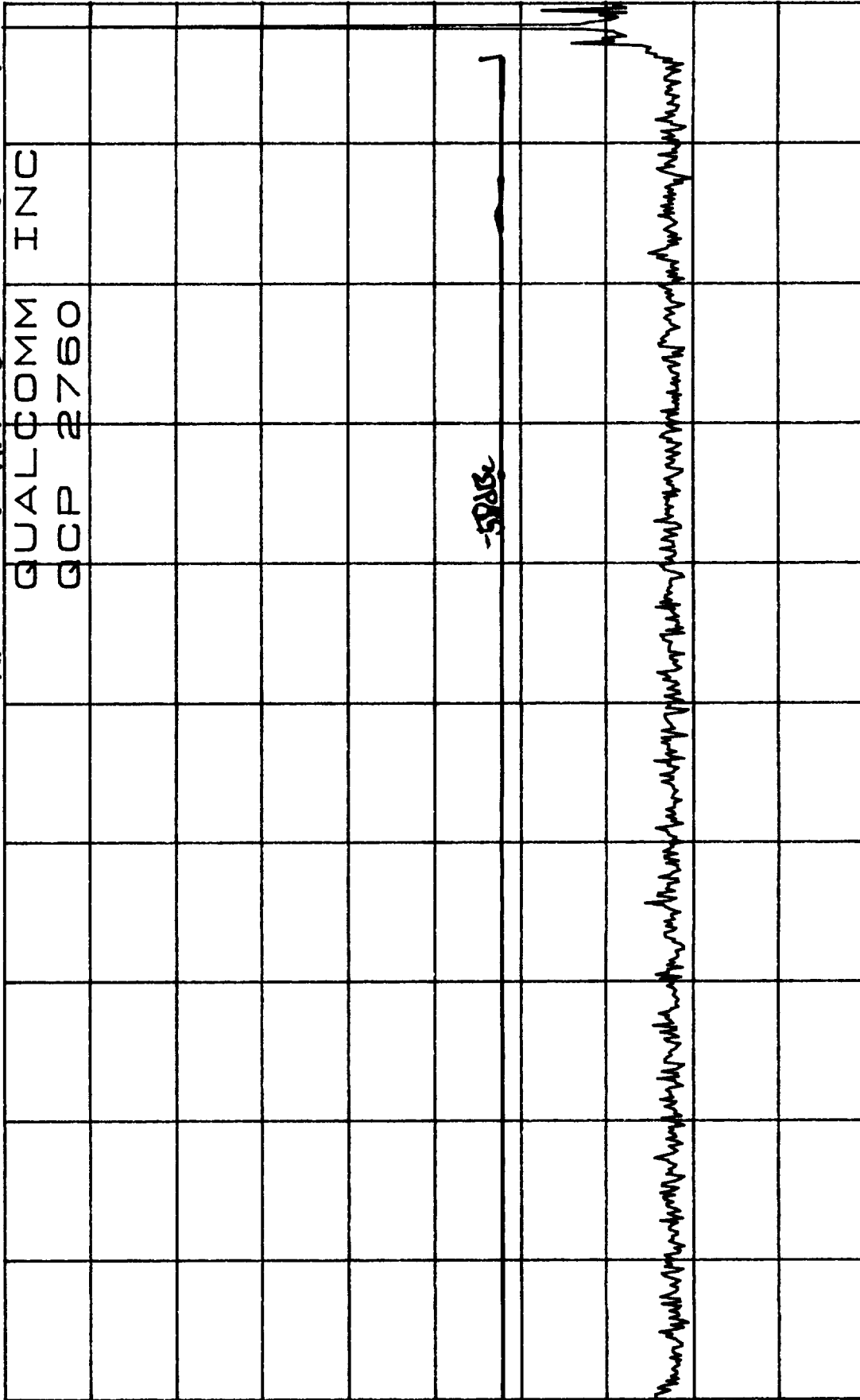

QUALCOMM

GCP 2760

INC

D

R

START 0HZ

*RBW 30KHZ

STOP 850.0MHZ

VBW 30KHZ

SWP 2.40sec

*ATTEN 40dB

RL 24.8dBm

10dB/

Exhibit J-3 TAPS ST

J9CACR-2760

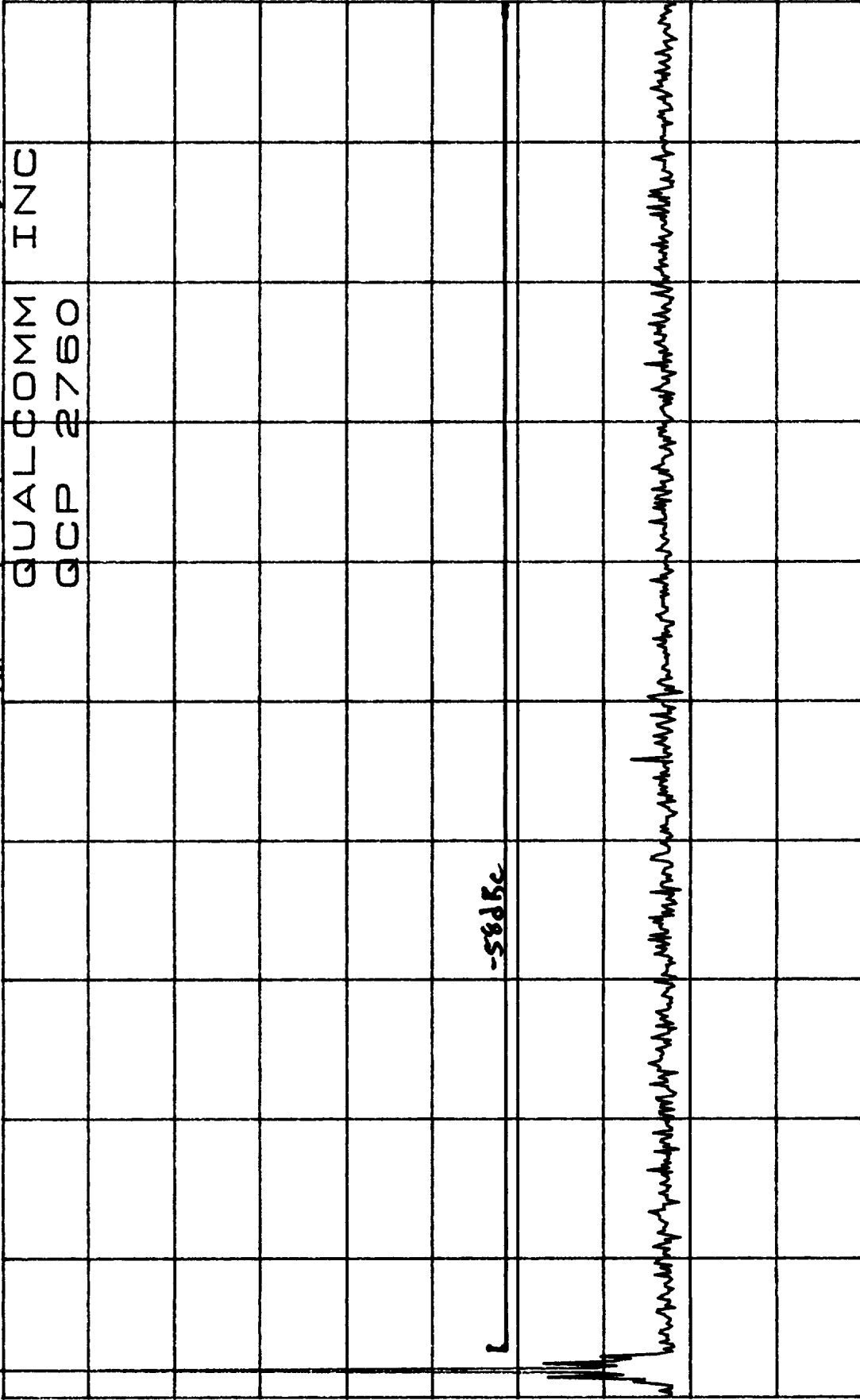

D

R

START 800MHz

STOP 2.700GHz

*RBW 30kHz

VBW 30kHz

SWP 5.30sec

*ATTEN 40dB

RL 24.8dBm

10dB/Exhibit

e-1 ANS SAT + ST J9CACP-2760

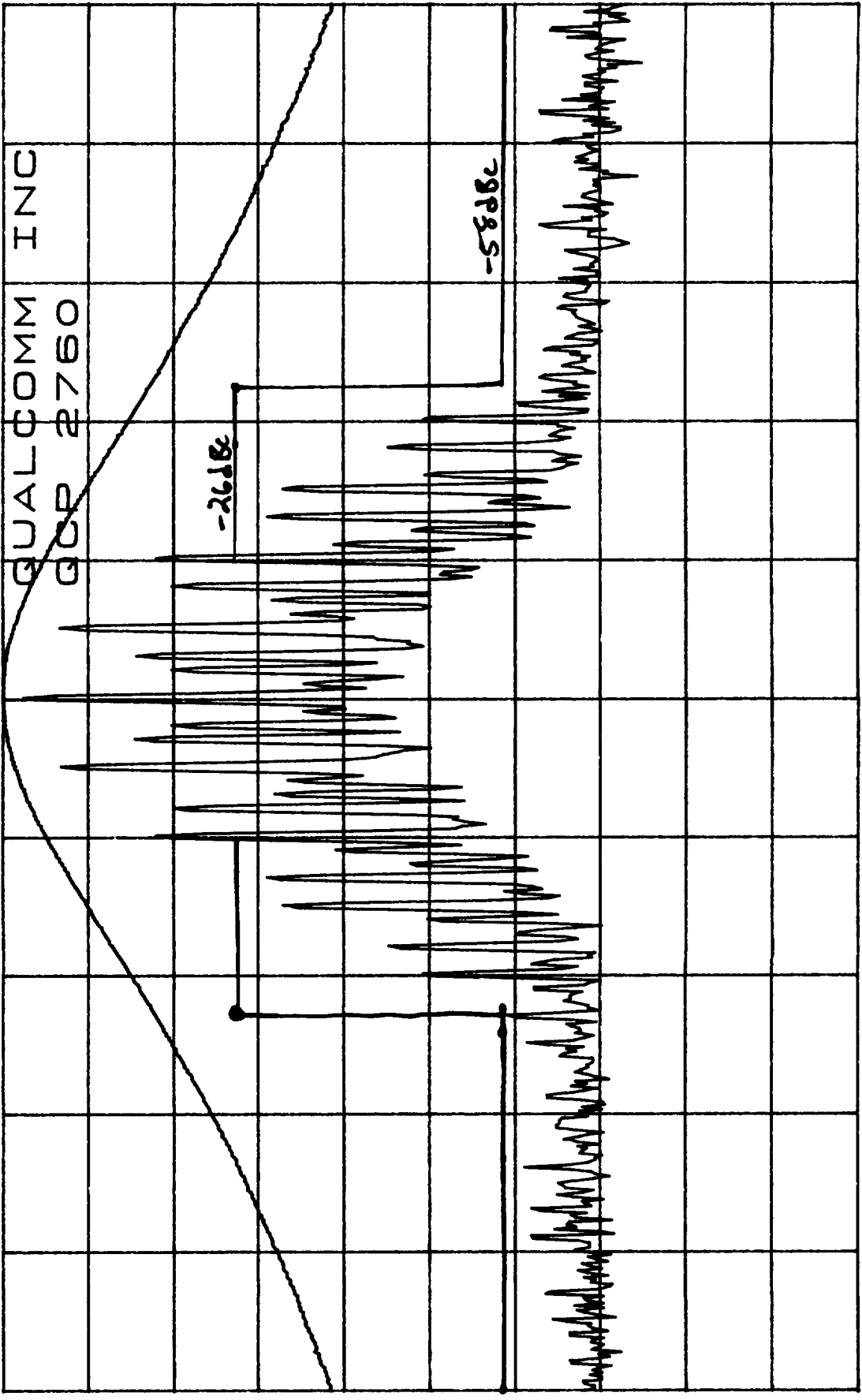

CENTER 836.4906MHZ

SPAN 200.0KHZ

*RBW 300HZ

VBW 300HZ

SWP 5.60SEC

*ATTEN 40dB

RL 24.8dBm

10dB/Exhibit

e-2 AMPS SAT + ST

19001-2760

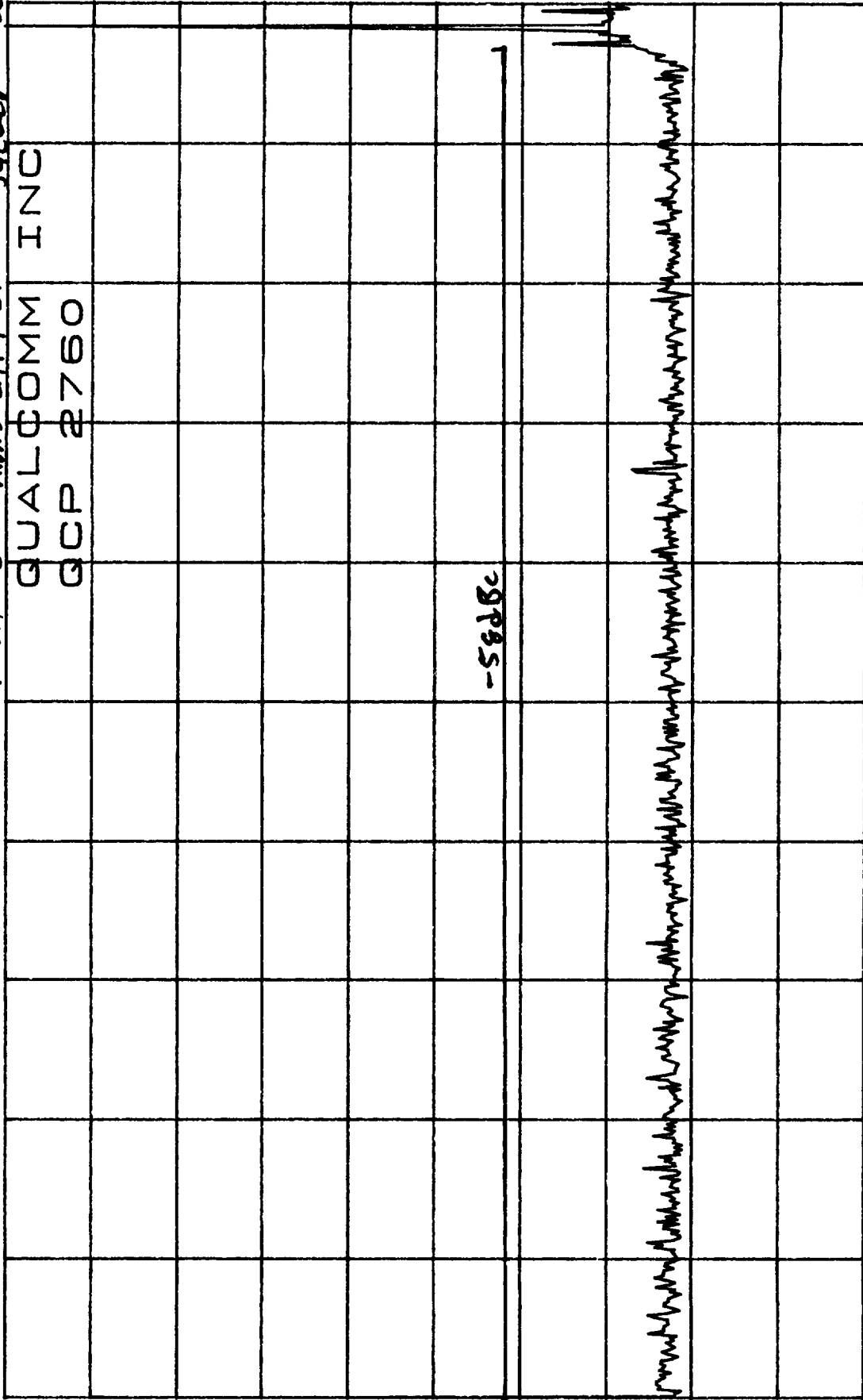

D

R

START 0HZ

*RBW 30KHZ

STOP 850.0MHZ

VBW 30KHZ

SWP 2.40sec

*ATTEN 40dB

RL 24.8dBm

10dB/Exhibit

e-3 Amplitude ST J9COP-2760

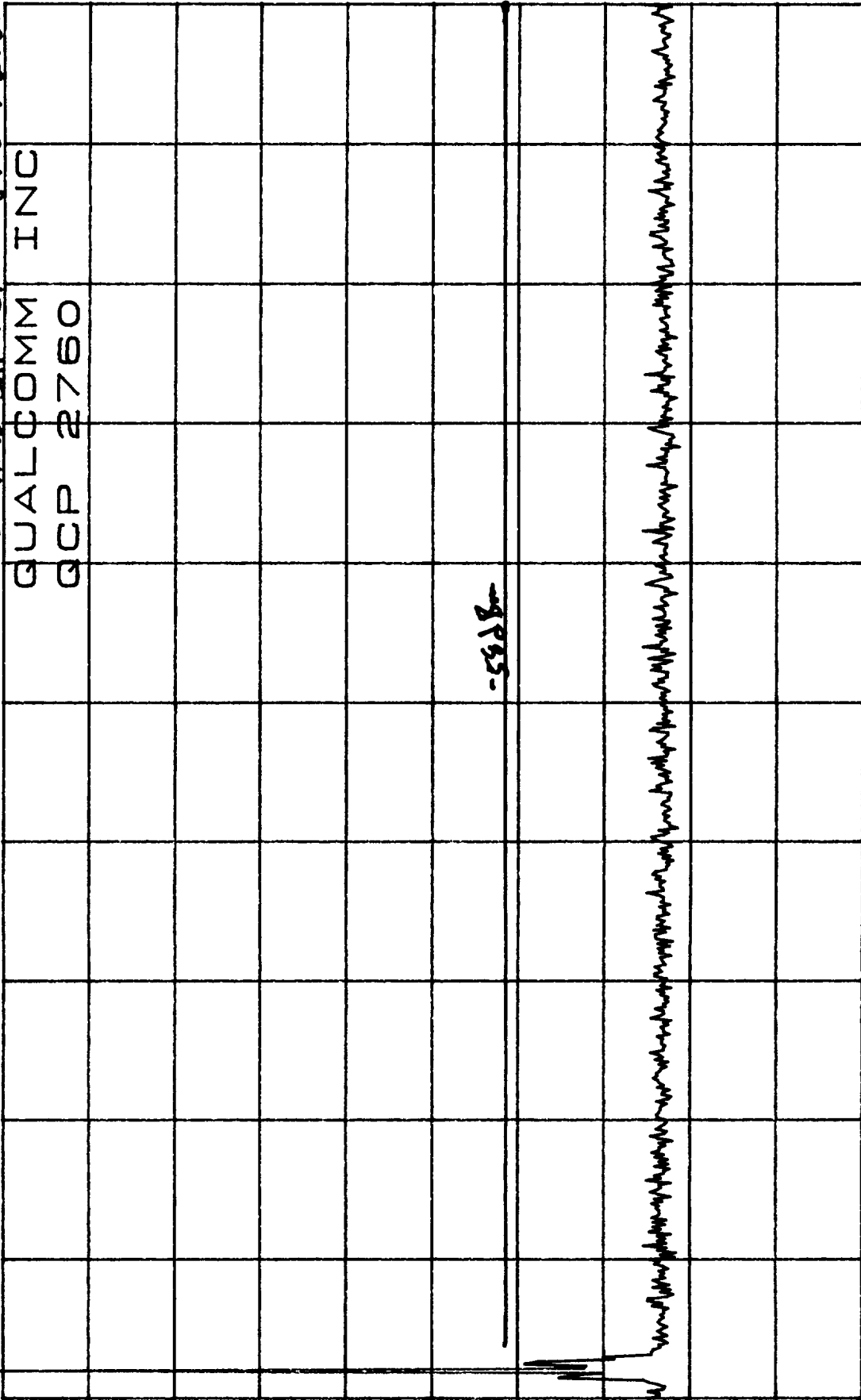

START 800MHZ

STOP 2.700GHZ

*RBW 30KHZ

VBW 30KHZ

SWP 5.30sec

*ATTEN 40dB

RL 24.8dBm

10dB/

Exhibit

Qualcomm Inc

39001-2360

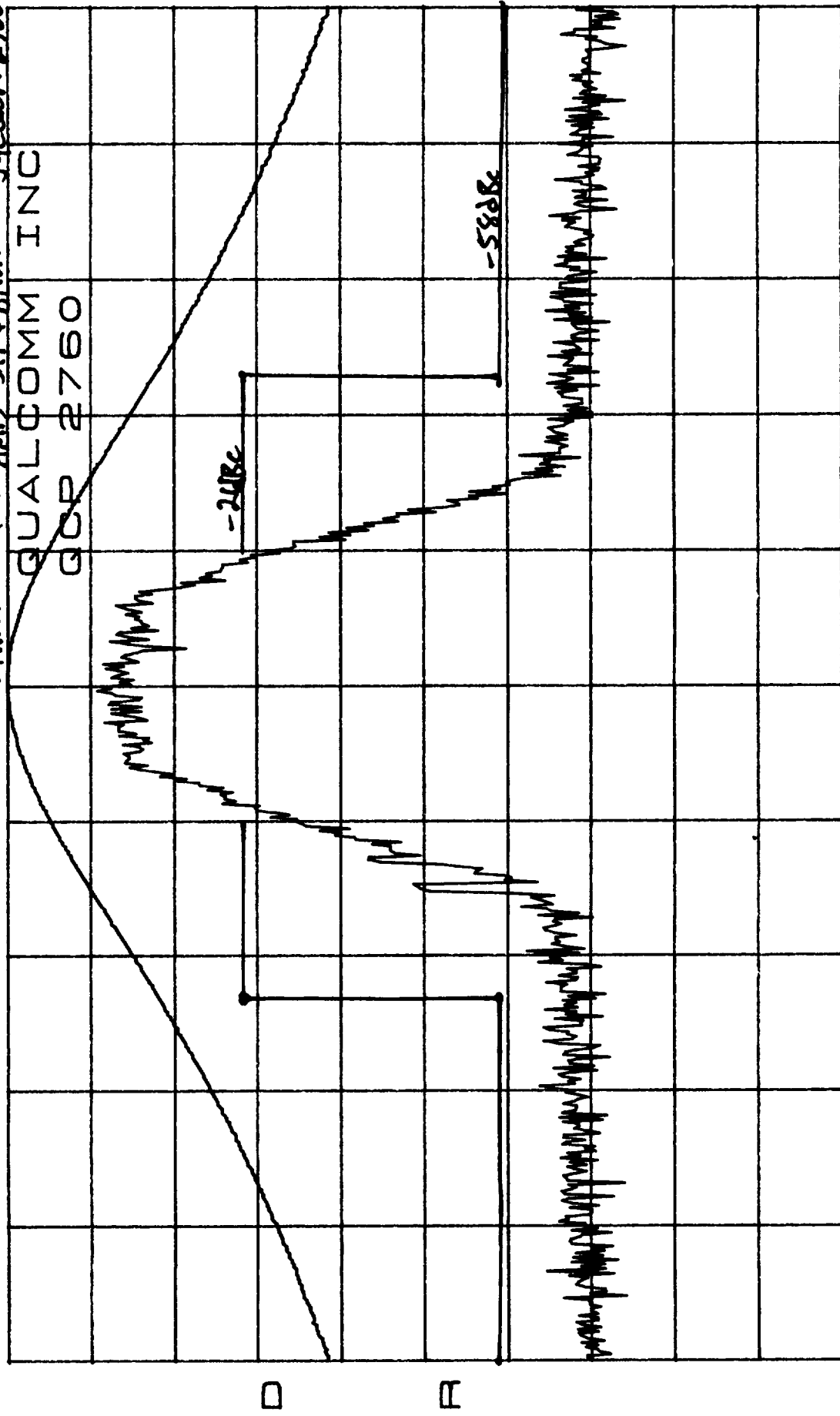

CENTER 836.4906MHZ

SPAN 200.0KHZ

*RBW 300HZ

VBW 300HZ

SWP 5.60SEC

*ATTEN 40dB

RL 24.8dBm

10dB/

Exhibit 4-7 AMPS SFT + DMF

59CQCP-2760

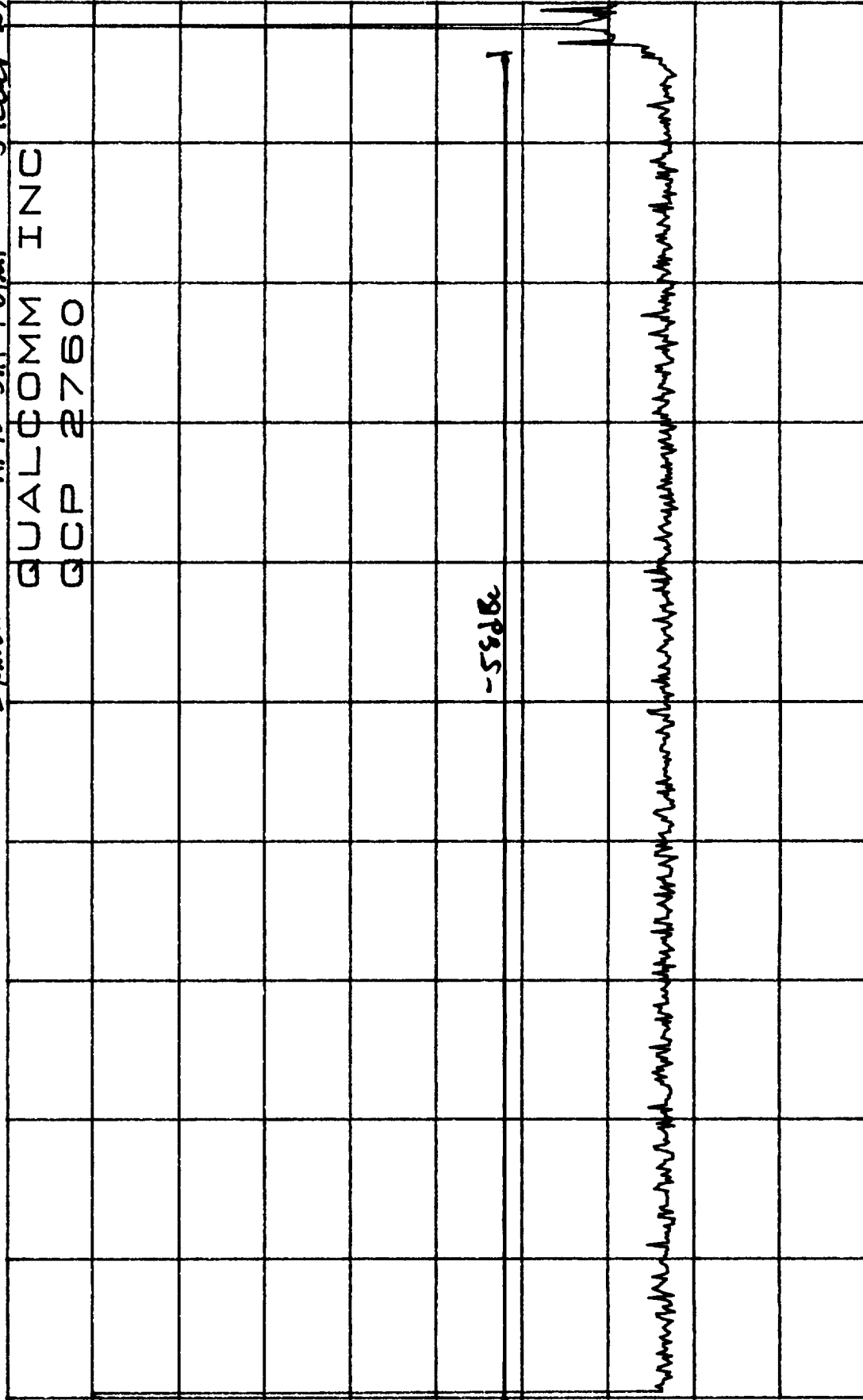

D

R

START 0HZ
*RBW 30KHZ

STOP 850.0MHZ
VBW 30KHZ
SWP 2.40sec

*ATTEN 40dB

RL 24.8dBm

10dB / Exhibit 6-3 AMPS SA+DMF SAQCP-2760

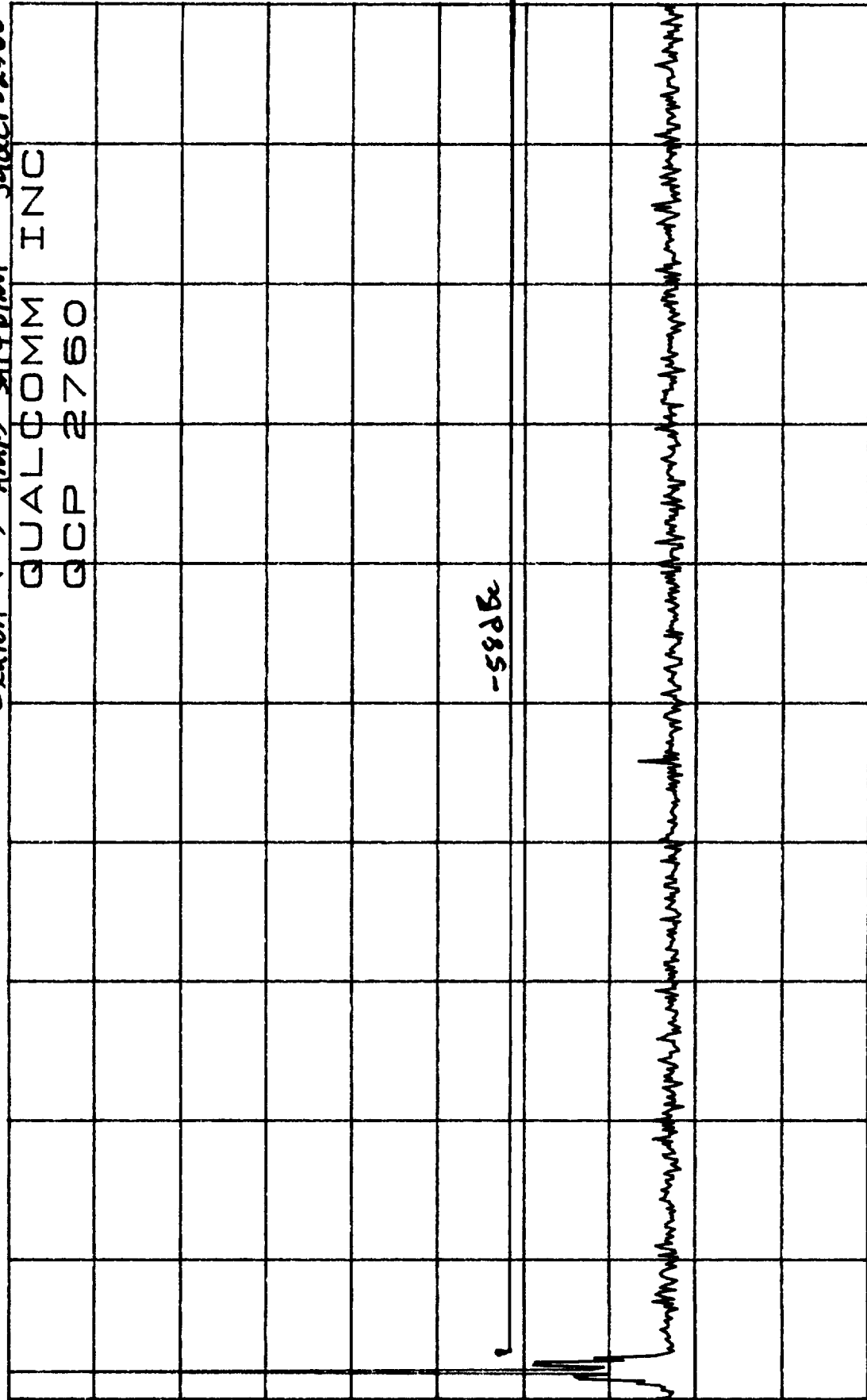

D

R

START 800MHZ

STOP 2.700GHZ

*RBW 30KHZ

VBW 30KHZ

SWP 5.30sec

*ATTEN 40dB

RL 24.8dBm

10dB/Exhibit

g-1 AMPS Wideband

JACALP-2760

QUALCOMM INC

QCP 2760

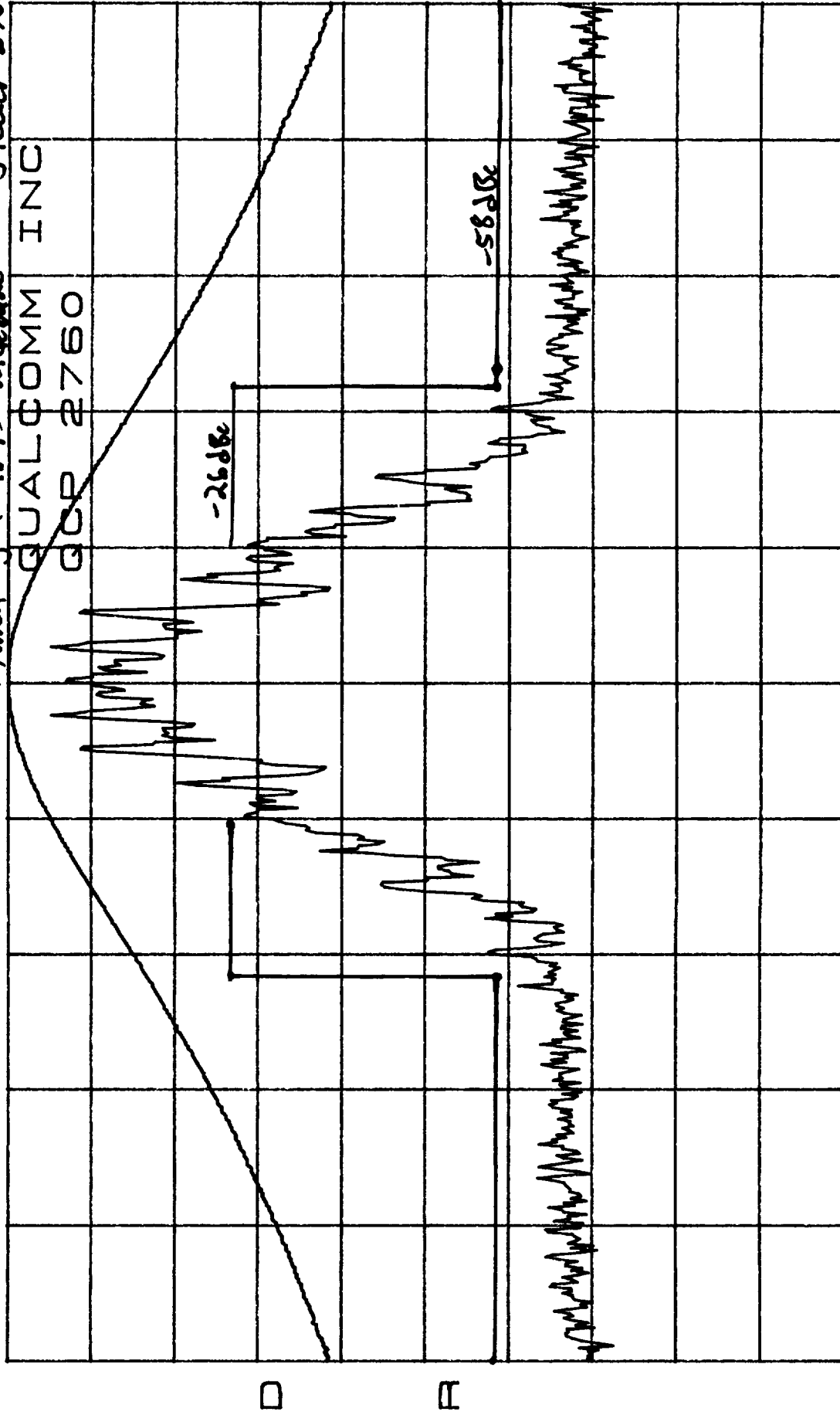

CENTER 836.4906MHZ

SPAN 200.0KHZ

*RBW 300HZ

VBW 300HZ

SWP 5.60SEC

*ATTEN 40dB

RL 24.8dBm

10dB / Exhibit

9.2 AMPs wideband

J9C QRP-2760

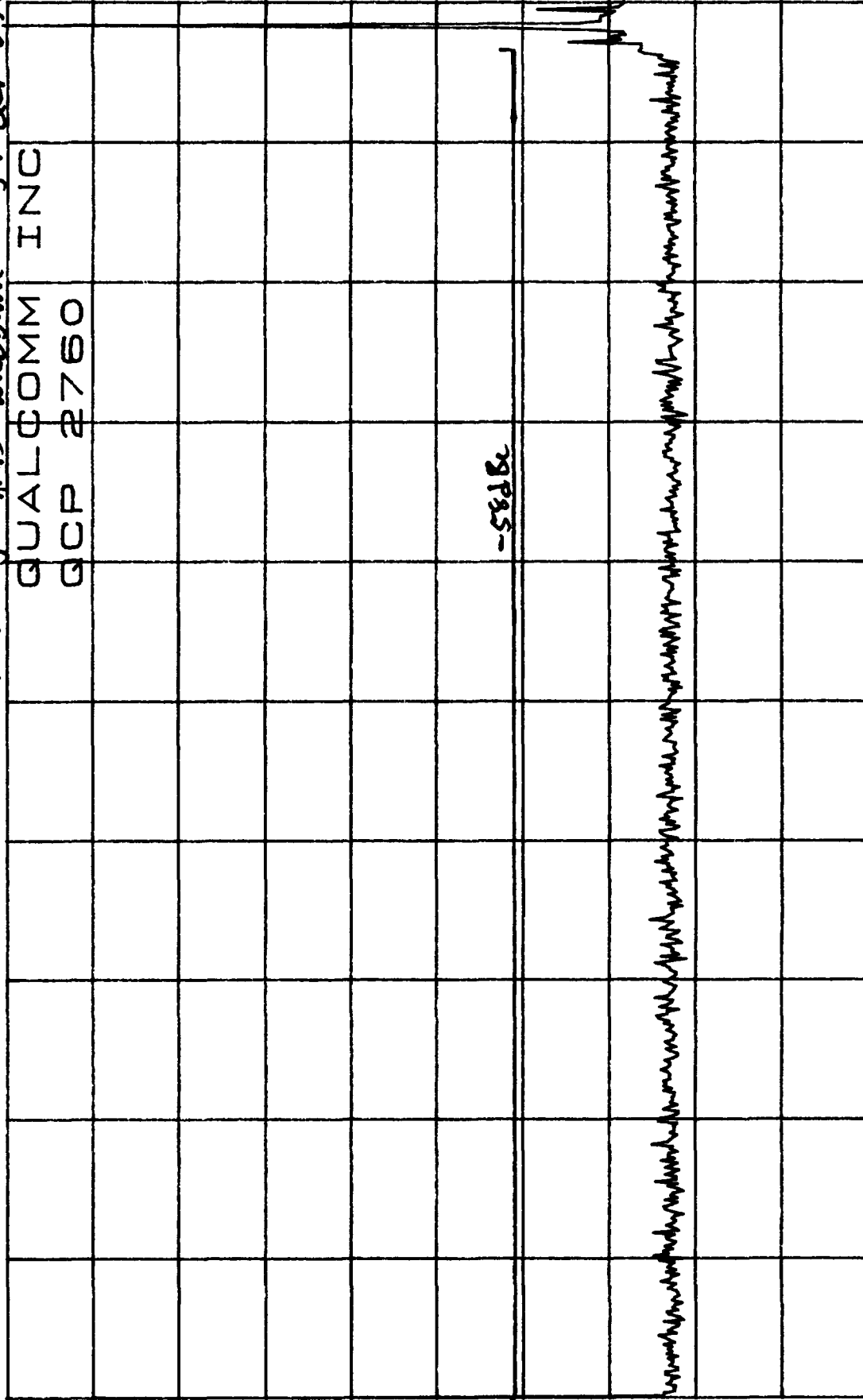

D

R

START 0HZ

*RBW 30KHZ

STOP 850.0MHZ

VBW 30KHZ

SWP 2.40sec

*ATTEN 40dB

RL 24.8dBm

10dB /

Exhibit g-3 AMPS wideband

JRC@CP-2760

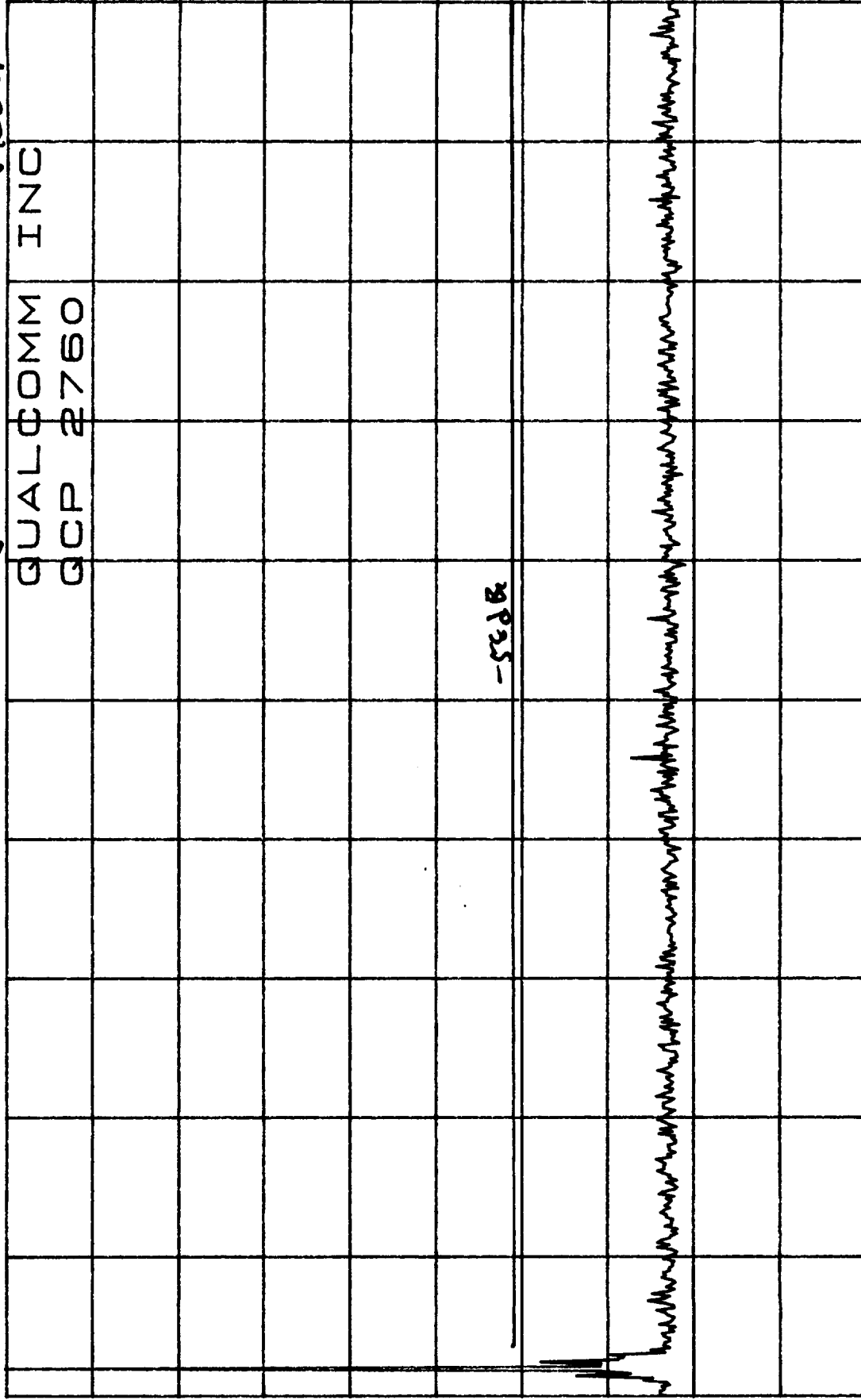

START 800MHZ

STOP 2.700GHZ

*RBW 30KHZ

VBW 30KHZ

SWP 5.30sec

*ATTEN 0dB

RL -40.0dBm

10dB/Exhibit

g-4 AMBS wideband

J9CACP-2760

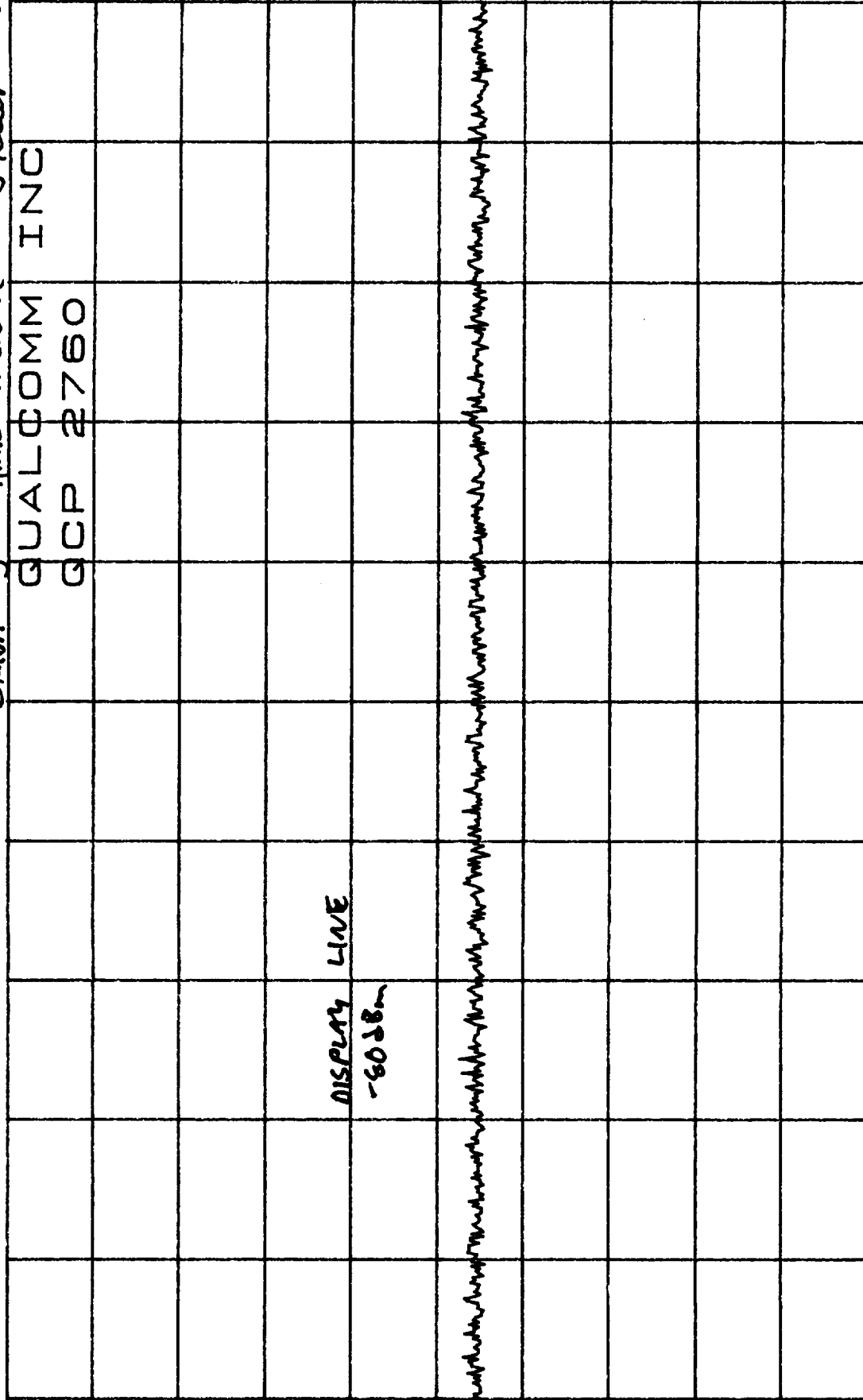

D

A

CENTER 881.50MHZ

SPAN 25.00MHZ

*RBW 30KHZ

VBW 30KHZ

SWP 70.0ms

Exhibit 11Conducted Emissions Test Results - FCC Part 22, Paragraph 2.1051, 22.917

6/22/99

Total measured cable/attenuator loss in front of spectrum analyzer : 0.8 dB

FM High Power

low band - channel 991					
	Frequency (MHz)	Measured Level (dBm)	actual level(dBm)	specification limit (dBm)	Analyzer front end attenuation
1	824.04	24.67	25.47	-	40
2	1648.08	-84.5	-83.7	-13	40
3	2472.12	-70.17	-69.37	-13	10
4	3296.16	-70.6	-69.8	-13	10
5	4120.2	-70.8	-70	-13	10
6	4944.24	-61.17	-60.37	-13	10
7	5768.28	-95.5	-94.7	-13	0
8	6592.32	-55.17	-54.37	-13	10
9	7416.36	-70.17	-69.37	-13	10
10	8240.4	-74.83	-74.03	-13	10

mid band - channel 383					
	Frequency (MHz)	Measured Level (dBm)	actual level(dBm)	specification limit (dBm)	Analyzer front end attenuation
1	836.49	24.81	25.51	-	40
2	1672.98	-75.5	-74.7	-13	10
	1933.87	-74.33	-73.53	-13	10
3	2509.47	-67.8	-67	-13	10
4	3345.96	-70.83	-70.03	-13	10
5	4182.45	-62.33	-61.53	-13	10
6	5018.94	-67.83	-67.03	-13	10
7	5855.43	-84.8	-84	-13	10
8	6691.92	-65.2	-64.4	-13	10
9	7528.41	-84.5	-83.7	-13	10
10	8364.9	-89.8	-89	-13	0

high band - channel 799					
	Frequency (MHz)	Measured Level (dBm)	actual level(dBm)	specification limit (dBm)	Analyzer front end attenuation
1	848.97	24.67	25.47	-	40
2	1697.94	-81	-80.2	-13	10
	1958.78	-73	-72.2	-13	10
3	2546.91	-67.3	-66.5	-13	10
4	3395.88	-70.2	-69.4	-13	10
5	4244.85	-49.2	-48.4	-13	10
6	5093.82	-73.5	-72.7	-13	10
7	5942.79	-69.1	-68.3	-13	10
8	6791.76	-73.5	-72.7	-13	10
9	7640.73	-85.9	-85.1	-13	10
10	8489.7	-76.17	-75.37	-13	10

Exhibit 12**Conducted Emission Test Results - FCC Part 2.1051, 24.238**

6/22/99

Total measured cable/attenuator loss in front of spectrum analyzer: 0.8 dB

PCS CDMA High Power

low band - channel 25					
	Frequency (MHz)	Measured Level (dBm)	actual level(dBm)	specification limit (dBm)	Analyzer front end attenuation
1	1851.25	21.6	22.7	-	40
2	3702.5	-62.5	-61.4	-13	10
3	5553.75	-62.7	-61.6	-13	0
4	7405	-70.6	-69.5	-13	0
5	9256.25	-70	-68.9	-13	0
6	11107.5	-72.8	-71.7	-13	0
7	12958.75	-72.2	-71.1	-13	0
8	14810	<81.1		-13	0
9	16661.25	<85		-13	0
10	18512.5	<84.8		-13	0

mid band - channel 600					
	Frequency (MHz)	Measured Level (dBm)	actual level(dBm)	specification limit (dBm)	Analyzer front end attenuation
1	1880	21.47	22.57	-	40
2	3760	-64.5	-63.4	-13	10
	5248.7	-76.17	-75.07	-13	0
3	5640	-54.17	-53.07	-13	0
4	7520	-57.5	-56.4	-13	0
5	9400	-61.2	-60.1	-13	0
6	11280	-68.5	-67.4	-13	0
7	13160	-75	-73.9	-13	0
8	15040	-77	-75.9	-13	0
9	16920	<83.5		-13	0
10	18800	<84.6		-13	0

high band - channel 1175					
	Frequency (MHz)	Measured Level (dBm)	actual level(dBm)	specification limit (dBm)	Analyzer front end attenuation
1	1908.75	21.42	22.52	-	40
	2816.25	-66	-64.9	-13	10
2	3817.5	-59.3	-58.2	-13	0
3	5726.25	-50.56	-49.46	-13	0
4	7635	-52.3	-51.2	-13	0
5	9543.75	-73.67	-72.57	-13	0
6	11452.5	-68.35	-67.25	-13	0
7	13361.25	-76.31	-75.21	-13	0
8	15270	-78.2	-77.1	-13	0
9	17178.75	<82.3		-13	0
10	19087.5	<-82		-13	0

Exhibit 13

Radiated Spurious Emissions Measured Data - FCC Part 2, Paragraph 2.993.

Separate attachment.

RADIATED EMISSIONS

DATA

FOR

**QUALCOMM, INC.
10300 Campus Point Drive
San Diego, CA 92121**

Prepared by

**TÜV PRODUCT SERVICE
10040 Mesa Rim Road
San Diego, CA 92121-2912**

Measurement Requirements (CFR 47 Part 2, Paragraph 2.1053 & Part 22, Paragraph 22.917)

The measurements which follow were performed by TÜV Product Service. To the best of my knowledge these tests were conducted in accordance with the procedures outlined in Part 2 of the Commission's Rules and Regulations. The data presented below demonstrates compliance with the appropriate technical standards.

F R Fleury

Floyd R. Fleury
EMC Manager

Emissions Test Conditions: SPURIOUS RADIATED EMISSIONS

 The *Spurious Radiated Emissions* measurements were performed using the following equipment:

Test Equipment Used :

Model No.	Prop. No.	Description	Manufacturer	Serial No.	Cal Date
8566B	720/721	Spectrum Analyzer & Display	Hewlett Packard	2115A00842 2112A02185	03/00
AA-190-06.00.0	657	Cable	United Microwave Prod.	--	N/A
AA-190-30.00.0	733	Cable	United Microwave Prod.	--	N/A
AMF-3D-010180-35-10P	752	Amplifier 20 dB	Miteq	614344	05/00
3115	453	Double Ridge Antenna	EMCO	9412-4364	10/99
F4777	--	High Pass Filter	Qualcomm	--	N/A

 Remarks: _____

Testing Facilities
Certificates of Approval

United States Department of Commerce
National Institute of Standards and Technology

NVLAP[®]



ISO/IEC GUIDE 25:1990
ISO 9002:1987

Certificate of Accreditation

TUV PRODUCT SERVICE, INC.
SAN DIEGO, CA

is recognized under the National Voluntary Laboratory Accreditation Program for satisfactory compliance with criteria established in Title 15, Part 285 Code of Federal Regulations. These criteria encompass the requirements of ISO/IEC Guide 25 and the relevant requirements of ISO 9002 (ANSI/ASQC Q92-1987) as suppliers of calibration or test results. Accreditation is awarded for specific services, listed on the Scope of Accreditation for:

ELECTROMAGNETIC COMPATIBILITY AND TELECOMMUNICATIONS
FCC

December 31, 1999

Effective through

For the National Institute of Standards and Technology

NVLAP Lab Code: 100268-0

NVLAP-01C (11-95)

National Institute
of Standards and Technology



National Voluntary
Laboratory Accreditation Program

ISO/IEC GUIDE 25:1990
ISO 9002:1987

Scope of Accreditation



Page: 1 of 1

**ELECTROMAGNETIC COMPATIBILITY
AND TELECOMMUNICATIONS**

NVLAP LAB CODE 100268-0

TUV PRODUCT SERVICE, INC.
10040 Mesa Rim Road
San Diego, CA 92121-1034
Mr. Floyd R. Fleury
Phone: 619-546-3999 Fax: 619-546-0364

NVLAP Code Designation / Description

International Special Committee on Radio Interference (CISPR) Methods

12/CIS22 IEC/CISPR 22:1993: Limits and methods of measurement of radio disturbance characteristics of information technology equipment

Federal Communications Commission (FCC) Methods

- 12/F01 FCC Method - 47 CFR Part 15 - Digital Devices
- 12/F01a Conducted Emissions, Power Lines, 450 KHz to 30 MHz
- 12/F01b Radiated Emissions

Australian Standards referred to by clauses in AUSTEL Technical Standards

12/T51 AS/NZS 3548: Electromagnetic Interference - Limits and Methods of Measurement of Information Technology Equipment

December 31, 1999

Effective through

For the National Institute of Standards and Technology

NVLAP-01S (11-96)



UNITED STATES DEPARTMENT OF COMMERCE
National Institute of Standards and Technology
Gaithersburg, Maryland 20899-

December 1, 1998

Mr. Floyd R. Fleury
TUV Product Service, Inc.
10040 Mesa Rim Road
San Diego, CA 92121-1034

NVLAP Lab Code: 100268-0

Dear Mr. Fleury:

I am pleased to inform you that continuing accreditation for specific test methods in Electromagnetic Compatibility & Telecommunications, FCC is granted to your organization under the National Voluntary Laboratory Accreditation Program (NVLAP). This accreditation is effective until December 31, 1999, provided that your organization continues to comply with accreditation requirements contained in the NVLAP Procedures.

Your Certificate of Accreditation is enclosed along with a statement of your Scope of Accreditation. You may reproduce these documents in their entirety and announce your organization's accreditation status using the NVLAP logo in business publications, the trade press, and other business-oriented literature. Accreditation does not relieve your organization from observing and complying with any applicable existing laws and/or regulations.

We are pleased to have you participate in NVLAP and look forward to your continued association with this program. If you have any questions concerning your NVLAP accreditation, please direct them to Jon Crickenberger, Sr. Program Manager, Laboratory Accreditation Program, National Institute of Standards and Technology, 100 Bureau Dr. Stop 2140, Gaithersburg, MD 20899-2140; (301) 975-4016.

Sincerely,

James L. Cigler, Chief
Laboratory Accreditation Program

Enclosure(s)

NIST

Photograph of Test Setup

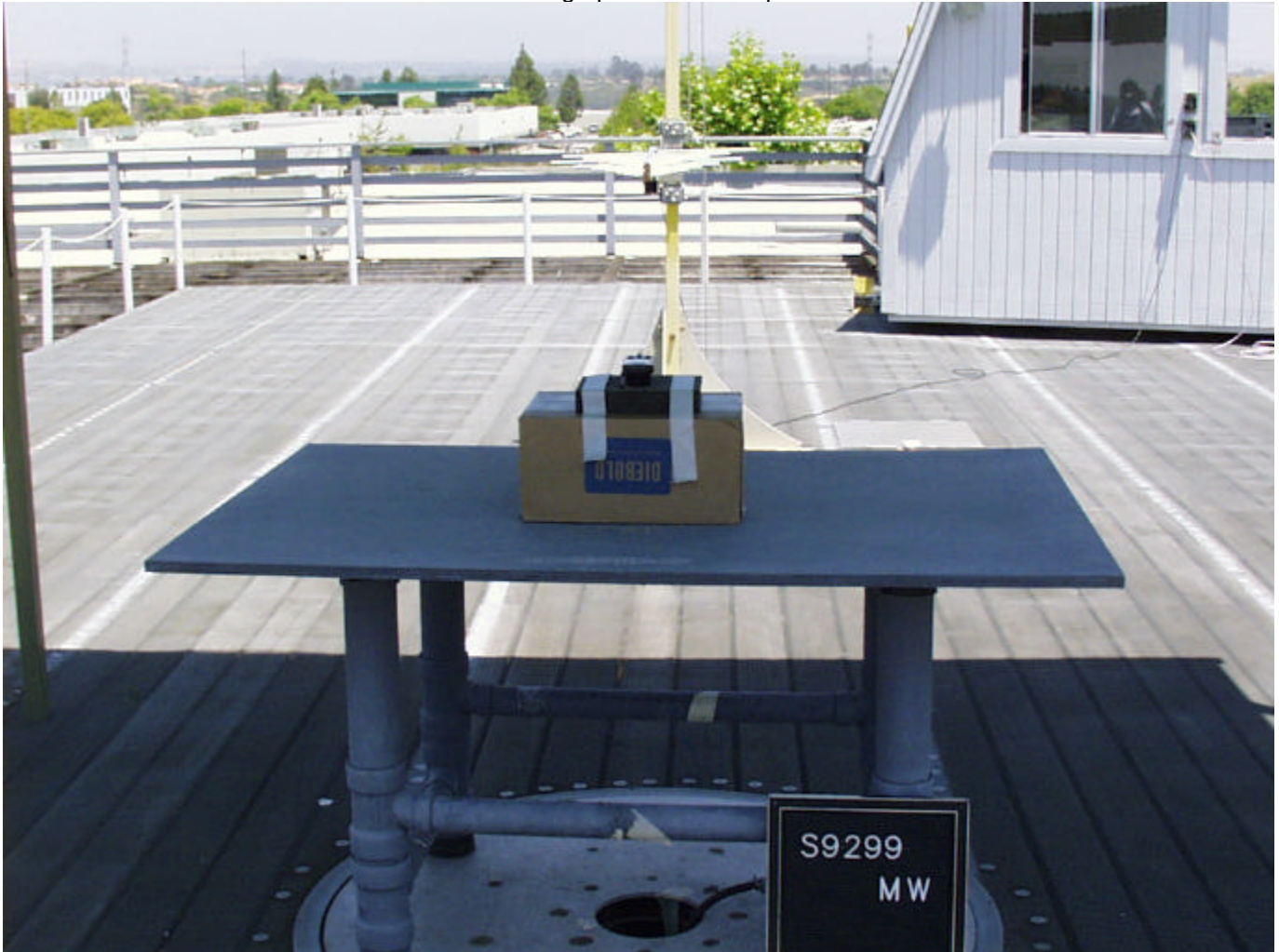

Photograph of Test Setup



REPORT No: S9299 TESTED BY: dm SPEC: Part 2 and 22
 CUSTOMER: Qualcomm Inc. TEST DIST: 1
 E U T: QCP-2760 Dual Mode Cell Phone TEST SITE: 3
 EUT MODE: Transmit Full Power - CDMA BICONICAL: N/A
 DATE: 21-Jun-99 LOG: N/A
 NOTES: Duty Cycle= 100% OTHER: 453
 Noise floor readings, except fundamental.

FREQ (MHz)	VERTICAL (dBuV)		HORIZONTAL (dBuV)		CORRECTION FACTOR (dBm)	MAX LEVEL (dBuV/m)		SPEC LIMIT (dBuV/m)		MARGIN (dB)		EUT Rotation	Antenna Height	Notes
	pk	av	pk	av		pk	av	pk	av	pk	av			
1851.25	92.2		86.4		29.5	121.7		84.4		122				Low channel
3702.5	10.7		10.7		40.3	51.0		84.4		-33.4				
5553.75	7.4		7.4		43.2	50.6		84.4		-33.8				
7405	10.4		10.4		45.9	56.3		84.4		-28.1				
9258.25	11.5		11.5		48.6	60.1		84.4		-24.3				
1880	89.5		85.1		32.3	121.8				122				Mid channel
3760	12.7		12.7		40.5	53.2		84.4		-31.2				
5640	12.2		12.2		43.5	55.7		84.4		-28.7				
7520	13.9		13.9		46.0	59.9		84.4		-24.5				
9400	13		13		48.3	61.3		84.4		-23.1				
1908.75	89.3		82.1		32.5	121.8	32.5			122	32	231	1	High channel
3817.5	9.6		9.6		40.8	60.4	40.8	84.4		-34	41			
5728.25	10.4		10.4		43.7	64.1	43.7	84.4		-30.3	44			
7635	14.6		14.6		46.2	60.8	46.2	84.4		-23.8	46			
9543.75	14.1		14.1		48.2	62.3	48.2	84.4		-22.1	48			

REPORT No: S9298 TESTED BY: mw
 SPEC: FCC Part 22, Para. 22.917, Part 2

CUSTOMER: Qualcomm, Inc. *mw*
 TEST DIST: 3 Meters

EUT: QCP-2760 Dual Mode Cell Phone *Worlinda*

EUT MODE: Transmit, Full Power, FM Mode BICONICAL: N/A

DATE: 18-Jun-99 LOG: 244

NOTES: Duty Cycle= 100% OTHER: 453

No emissions detectable at 3 meters except as noted below.

RBW and VBW = 100 kHz below 1 GHz.

RBW and VBW = 1 MHz above 1 GHz.

FREQ (MHz)	VERTICAL (dBuv)		HORIZONTAL (dBuv)		CORRECTION FACTOR (dBm)	MAX LEVEL (dBm/Wm)		SPEC LIMIT (dBuV/m)		MARGIN (dB)		EUT Rotation	Antenna Height	Notes
	pk	av	pk	av		pk	av	pk	av	pk	av			
836.49	97.9	88.7			26.3	124.2		84.4		124		247	2	Mid channel, 383
1672.98	16.3	11.1			31.2	47.5		84.4		-38.9				
2509.47	28.2	30.1			34.8	64.9		84.4		-19.5		87	1	
3345.96	13.3	11.5			38.9	52.2		84.4		-32.2				
4182.45	11	14.8			40.9	55.5		84.4		-28.9				
5018.94	6.6	10.7			42.2	62.9		84.4		-31.5				
5855.43	10.2	18			44.0	62.0		84.4		-22.4		9	1	
824.04	97.8	86.4			26.3	124.1		84.4		124		63	1.8	Low channel, 991
1648.08	17.8	10.7			31.0	48.8		84.4		-35.8				
2472.12	29.2	28.5			34.6	63.8		84.4		-20.6		187	1.9	
3296.16	12.8	10.4			38.8	51.8		84.4		-32.8				
4120.2	11.5	13.3			41.1	54.4		84.4		-30				
4944.24	6.3	8.4			41.9	50.3		84.4		-34.1				
5768.28	2	5.9			43.8	49.7		84.4		-34.7				
6592.3	7.9	13.3			44.7	53.0		84.4		-26.4				
848.97	97.6	88.4			28.5	124.1		84.4		124		60	1.6	High channel, 799
1697.94	21	17.9			31.3	62.3		84.4		-32.1				
2546.91	24.8	23.8			35.0	59.8		84.4		-24.6		224	1	
3396.88	16.8	15.3			39.1	55.7		84.4		-28.7				
4244.85	16.3	16.8			40.7	57.5		84.4		-26.9				

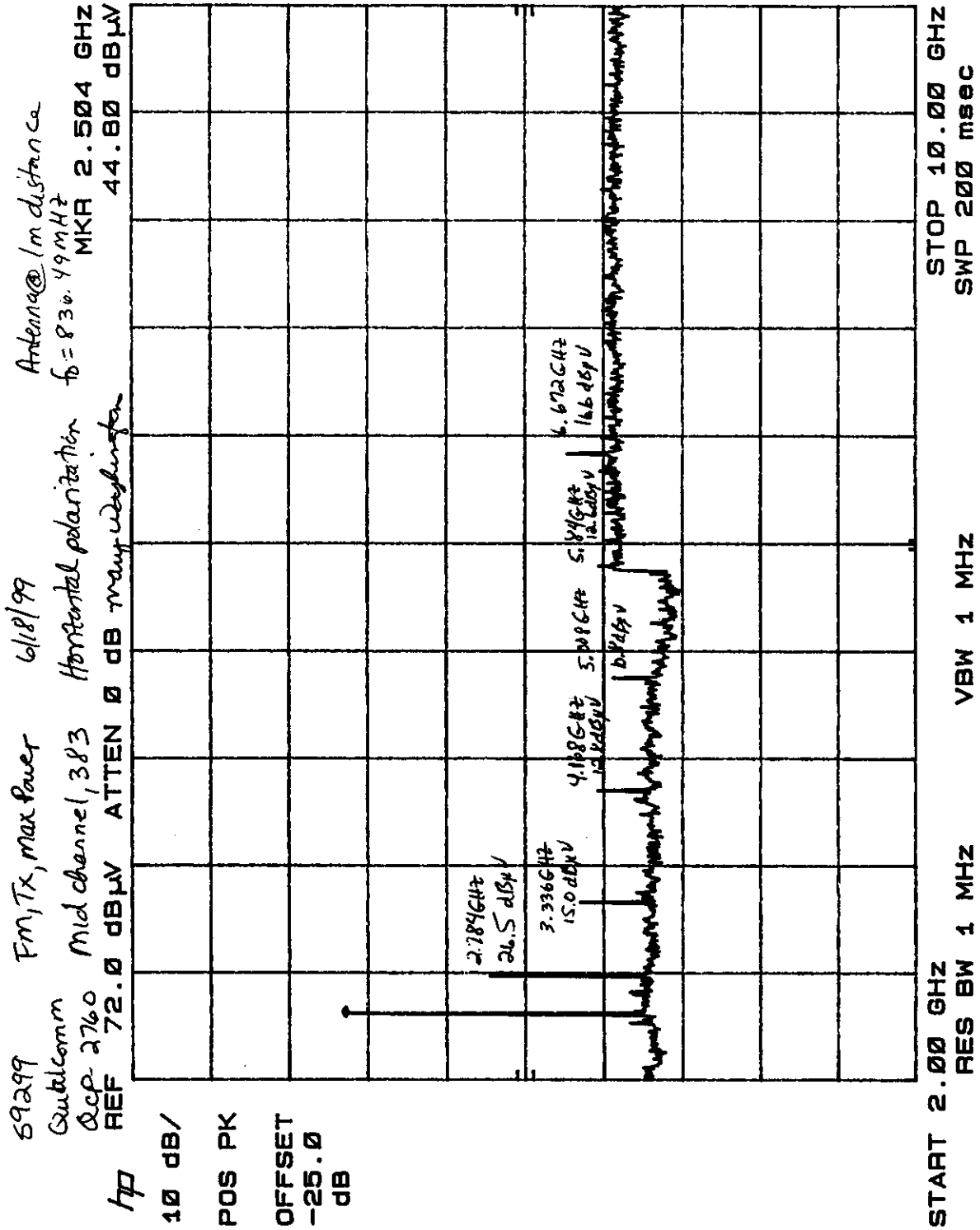

S 9299
Qualcomm
DCP-2760
Fm, Tx, Max Power
mid channel, 3P3
6/18/99
Horizontal polarization
Antenna @ 1 m distance
 $f_0 = 1.674 \text{ GHz}$
MKR 1.674 GHz
29.00 dB μ V

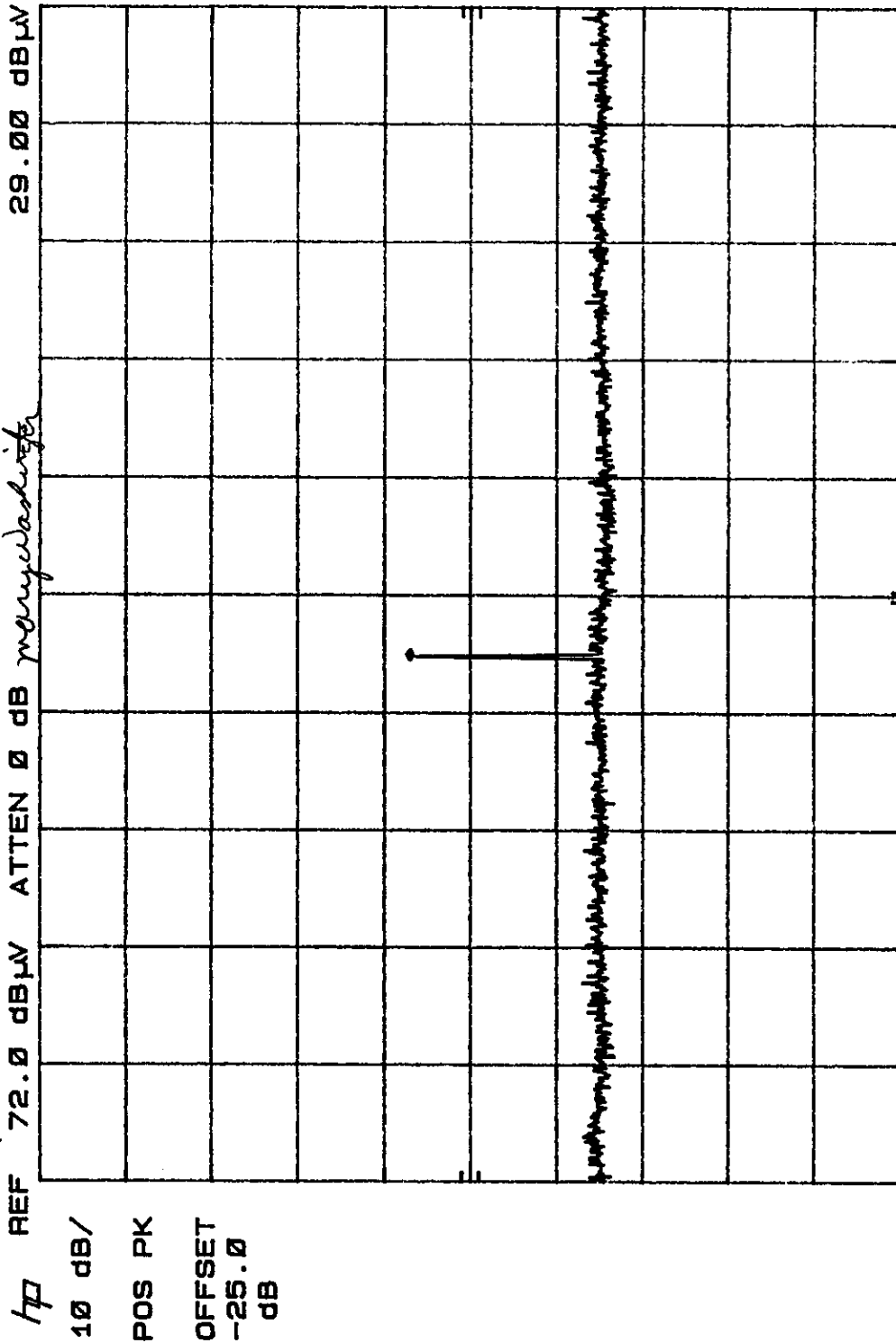

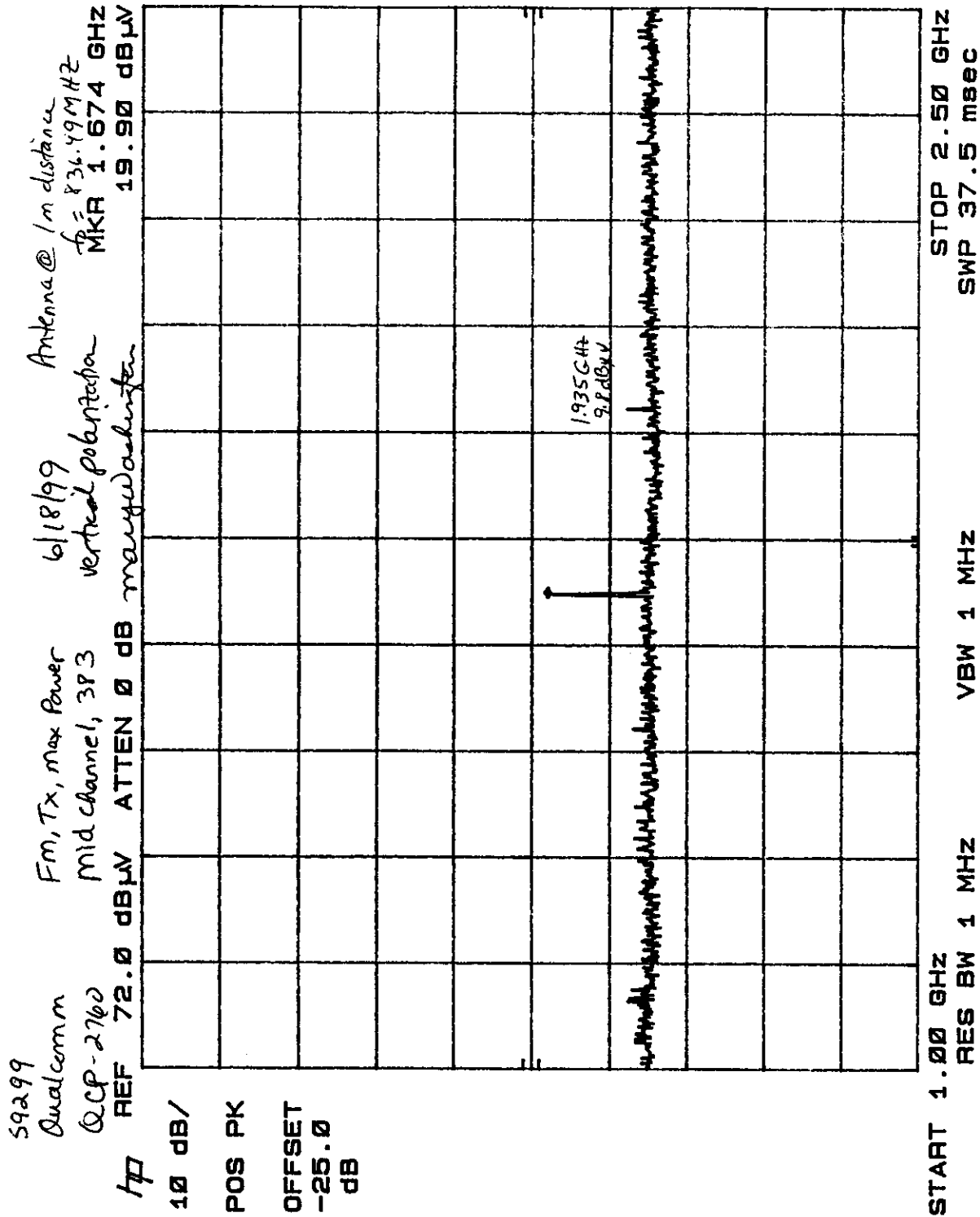

59299
Qualcomm
QCP-2760
REF 72.0 dBµV
FM, TX, Max Power
Mid channel, 38.3
6/18/99
Antenna @ 7 m distance
 $f_0 = 836.4909 \text{ MHz}$

Vertical polarization
MKR 2.504 GHz
26.10 dBµV

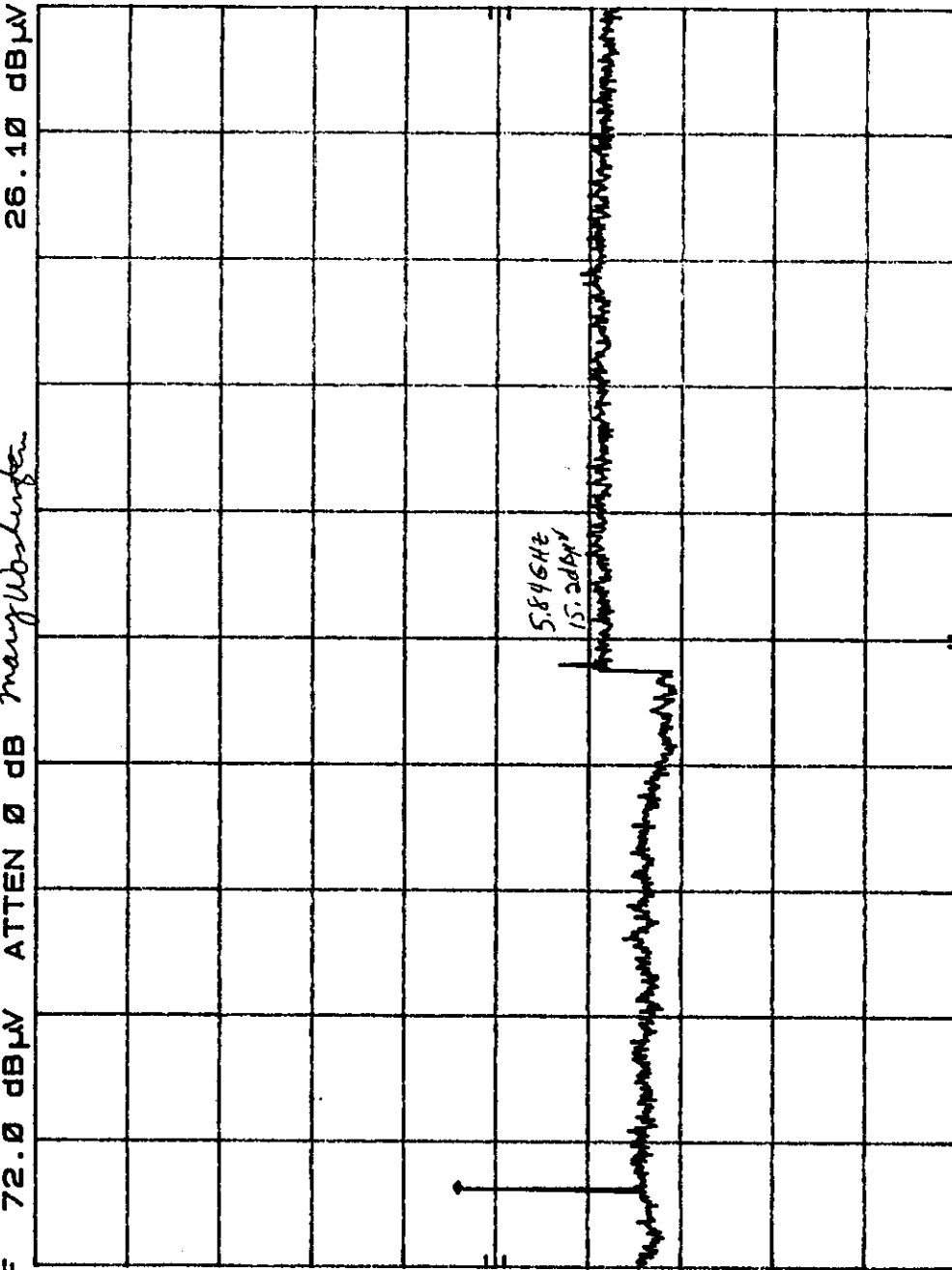

hp
10 dB/
POS PK
OFFSET
-25.0
dB

START 2.00 GHz
RES BW 1 MHz
VBW 1 MHz
STOP 10.00 GHz
SWP 200 msec

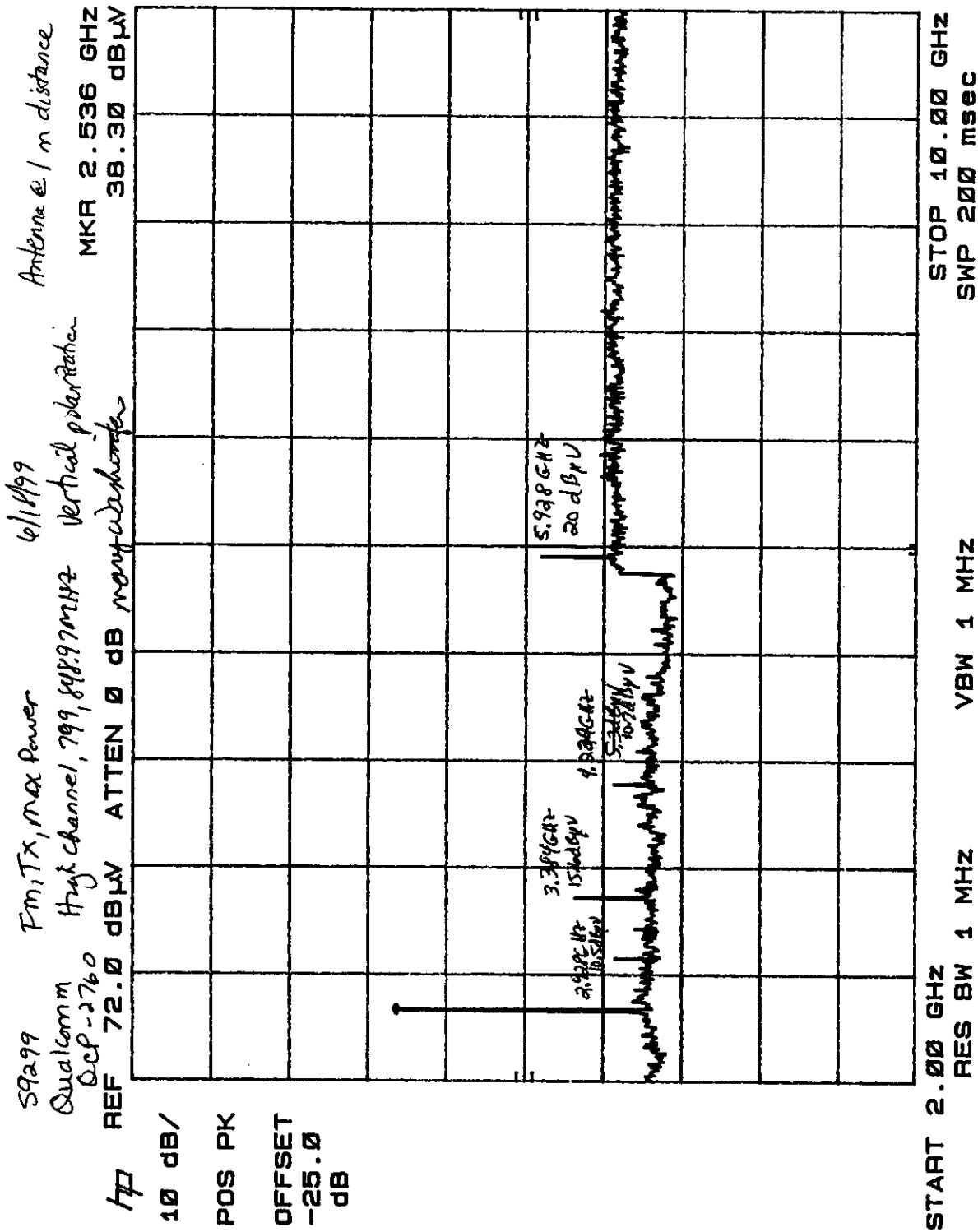

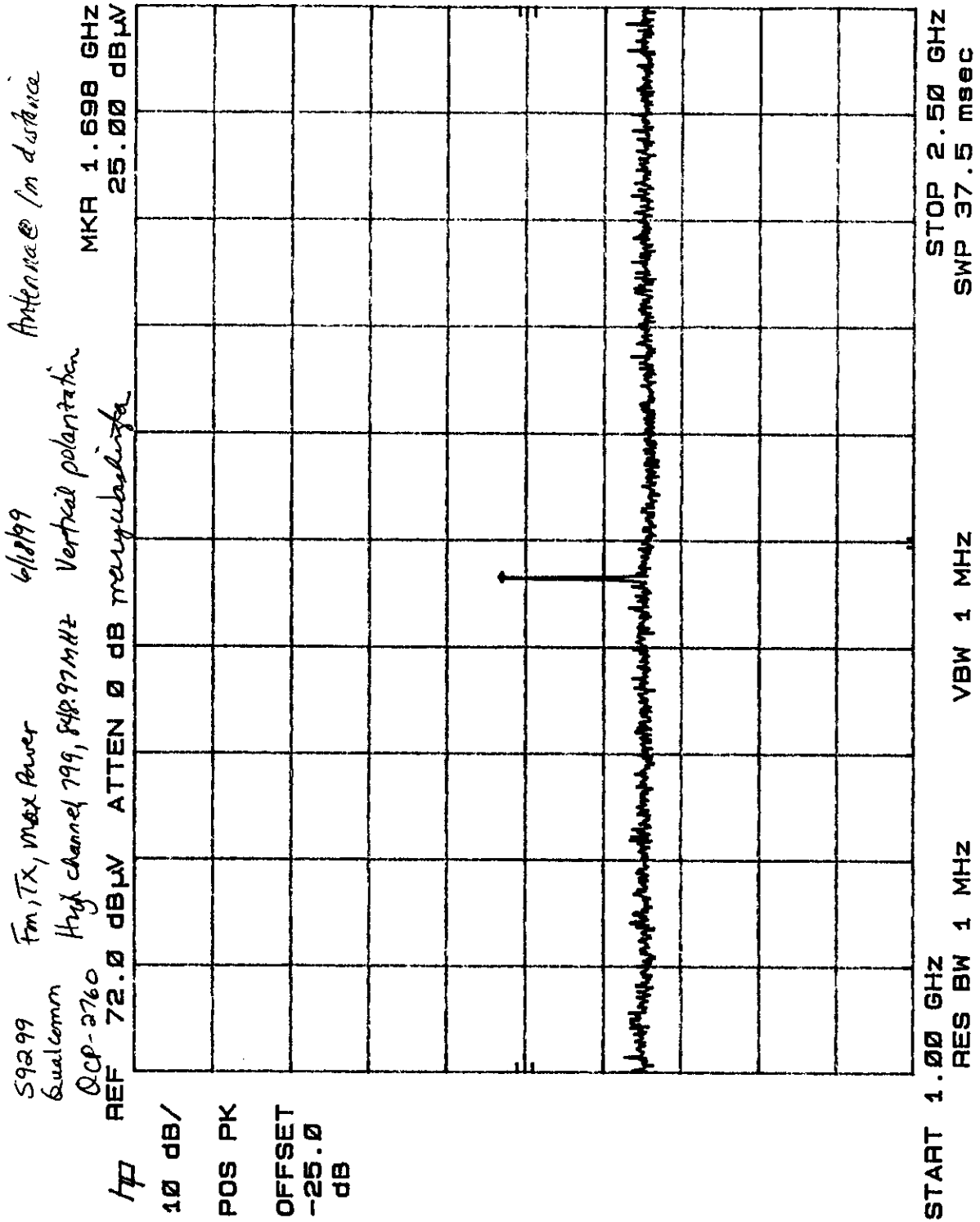

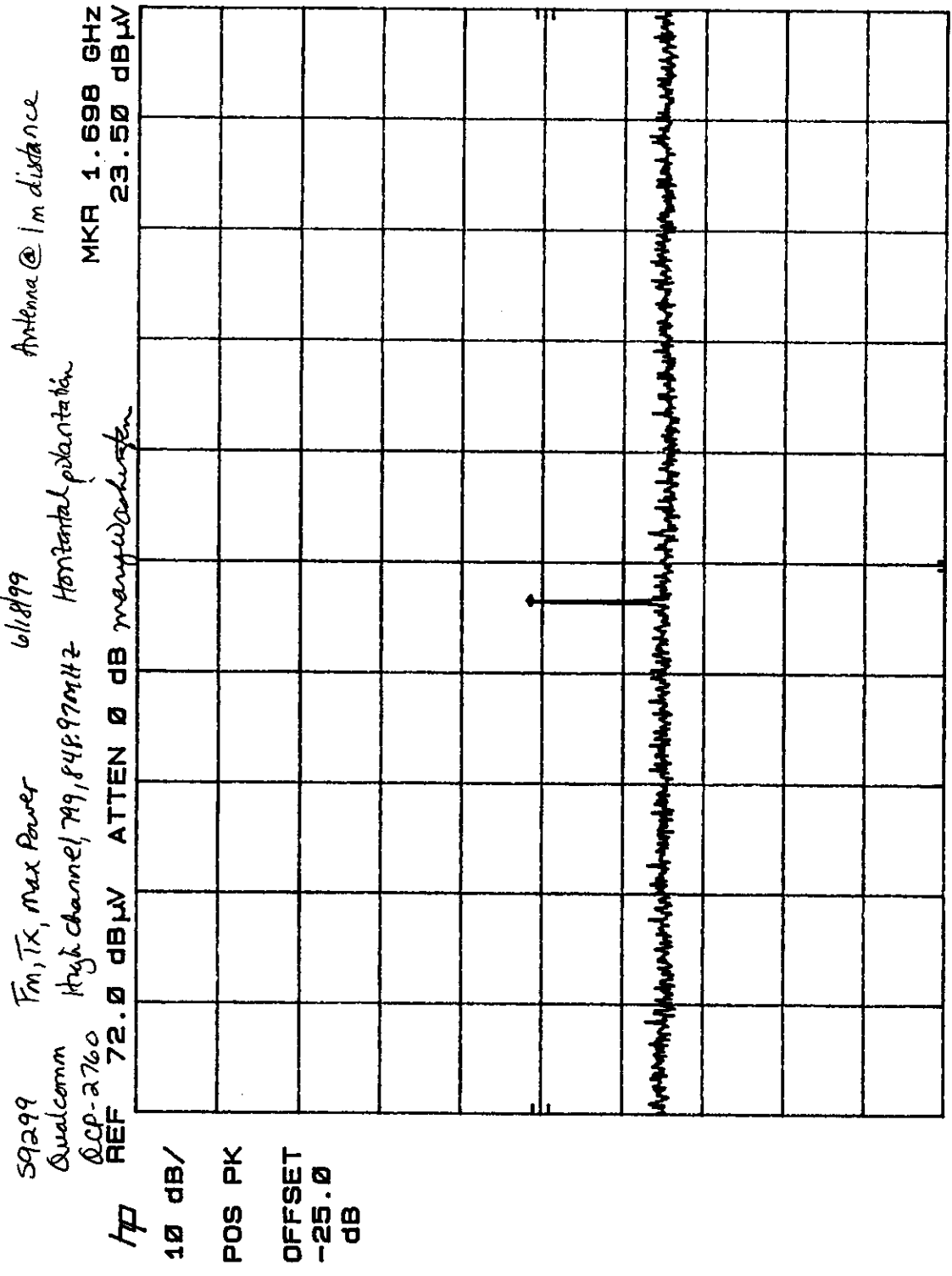

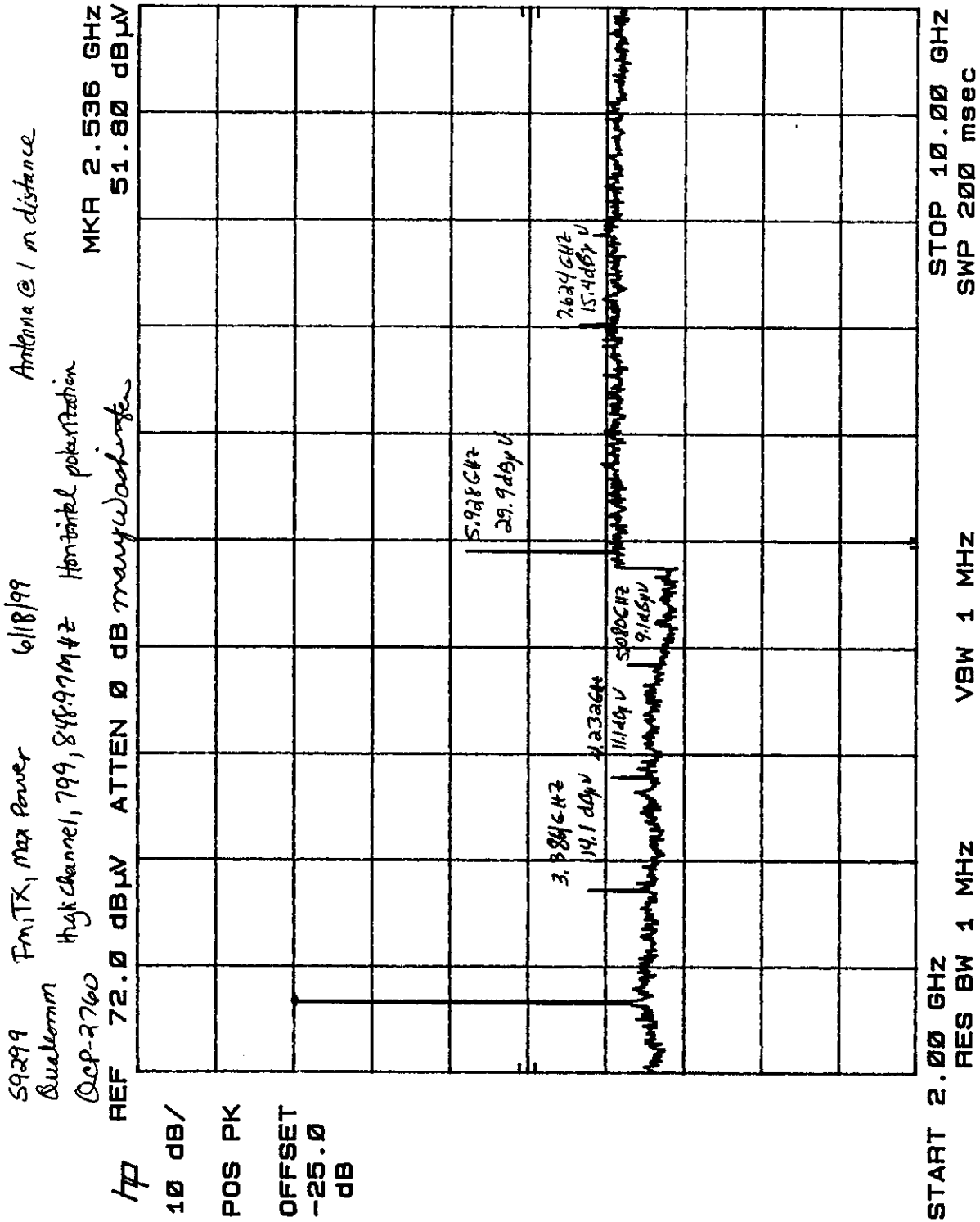

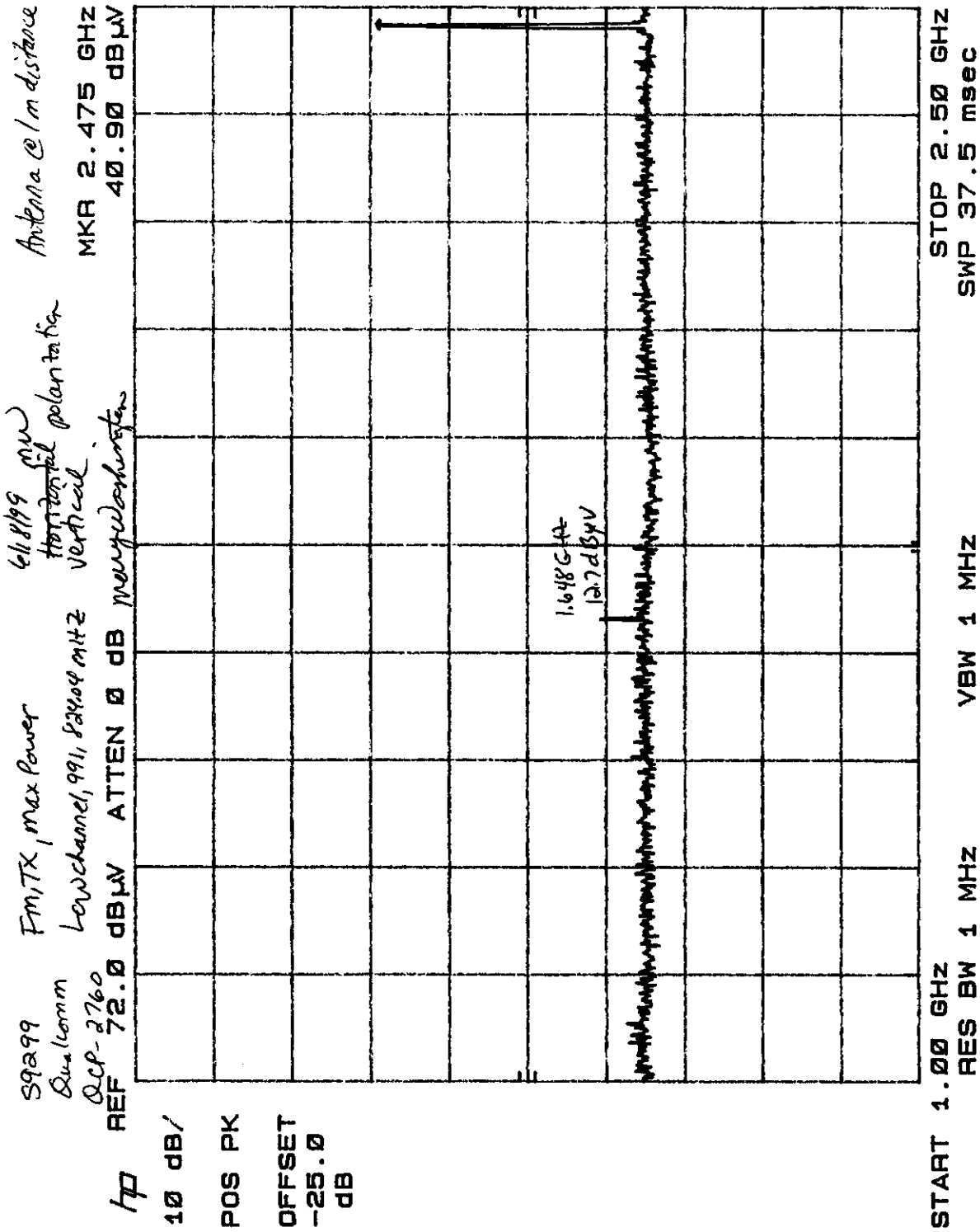

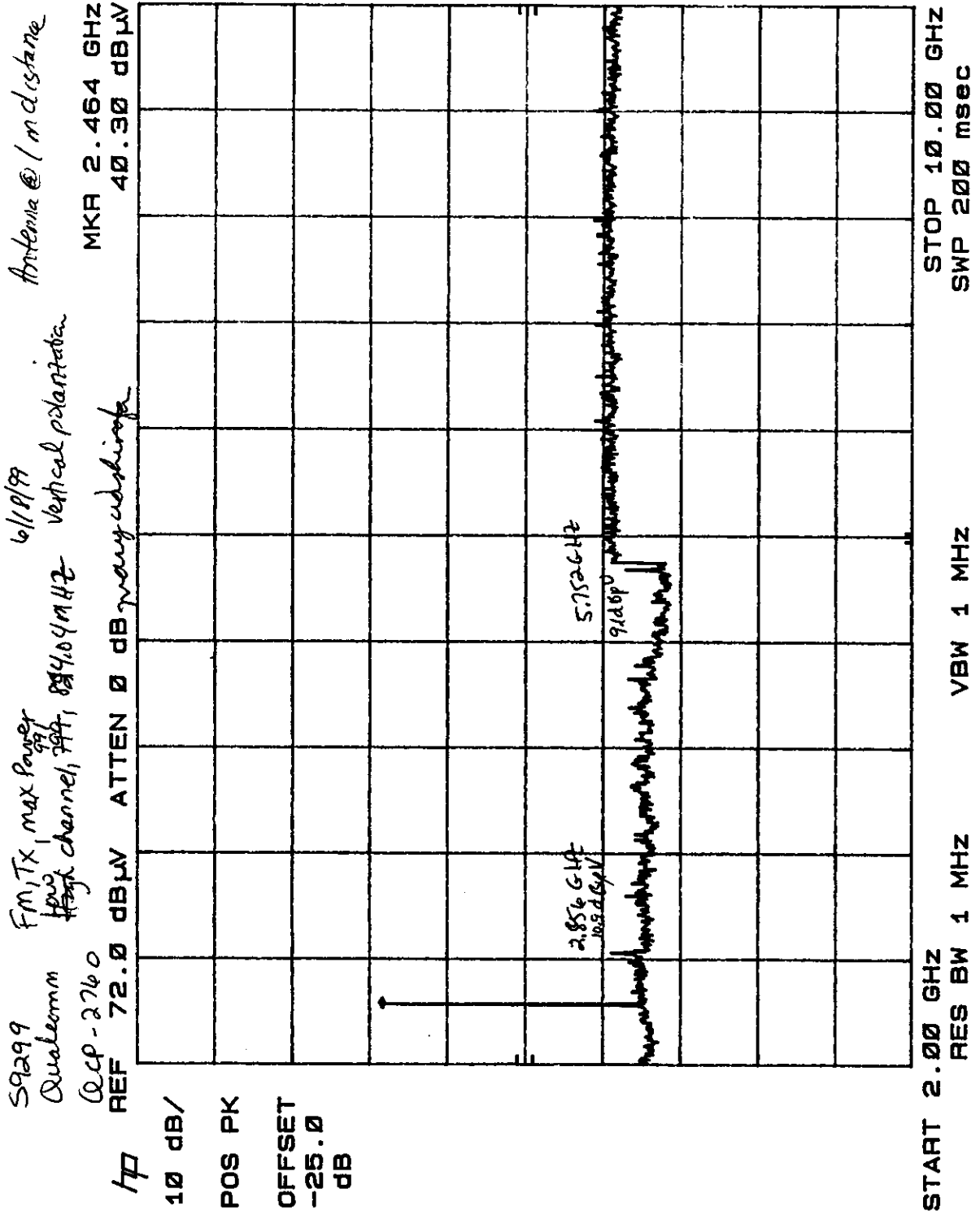

Antenna @ / meter distance
 MKR 2.475 GHz
 41.60 dBμV

6/16/99
 Horizontal polarization

FM, TX, Max Power
 Low channel, 991, 84404 MHz
 ATTN 0 dB

S9299
 Qualcomm
 QCP-2760
 REF 72.0 dBμV

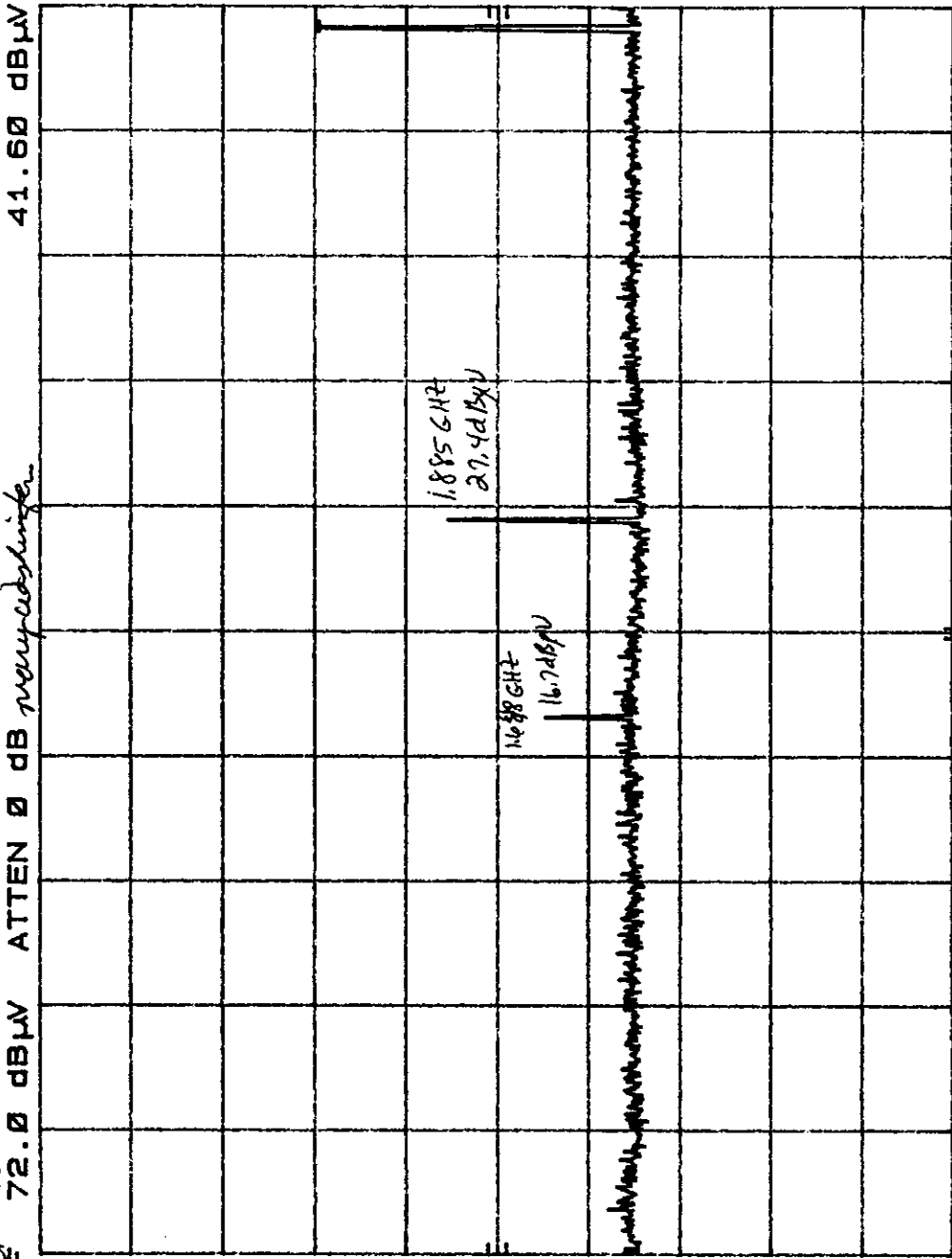

HP
 10 dB /
 POS PK
 OFFSET
 -25.0
 dB

START 1.00 GHz
 RES BW 1 MHz
 VBW 1 MHz
 STOP 2.50 GHz
 SWP 37.5 msec

S9299
 Qualcomm
 DCP-2760
 FM, TX, max power
 Low channel, 991, 829.04 MHz
 6/18/99
 Antenna @ 1 meter distance
 Horizontal polarization
 MKR 2.464 GHz
 35.70 dBµV

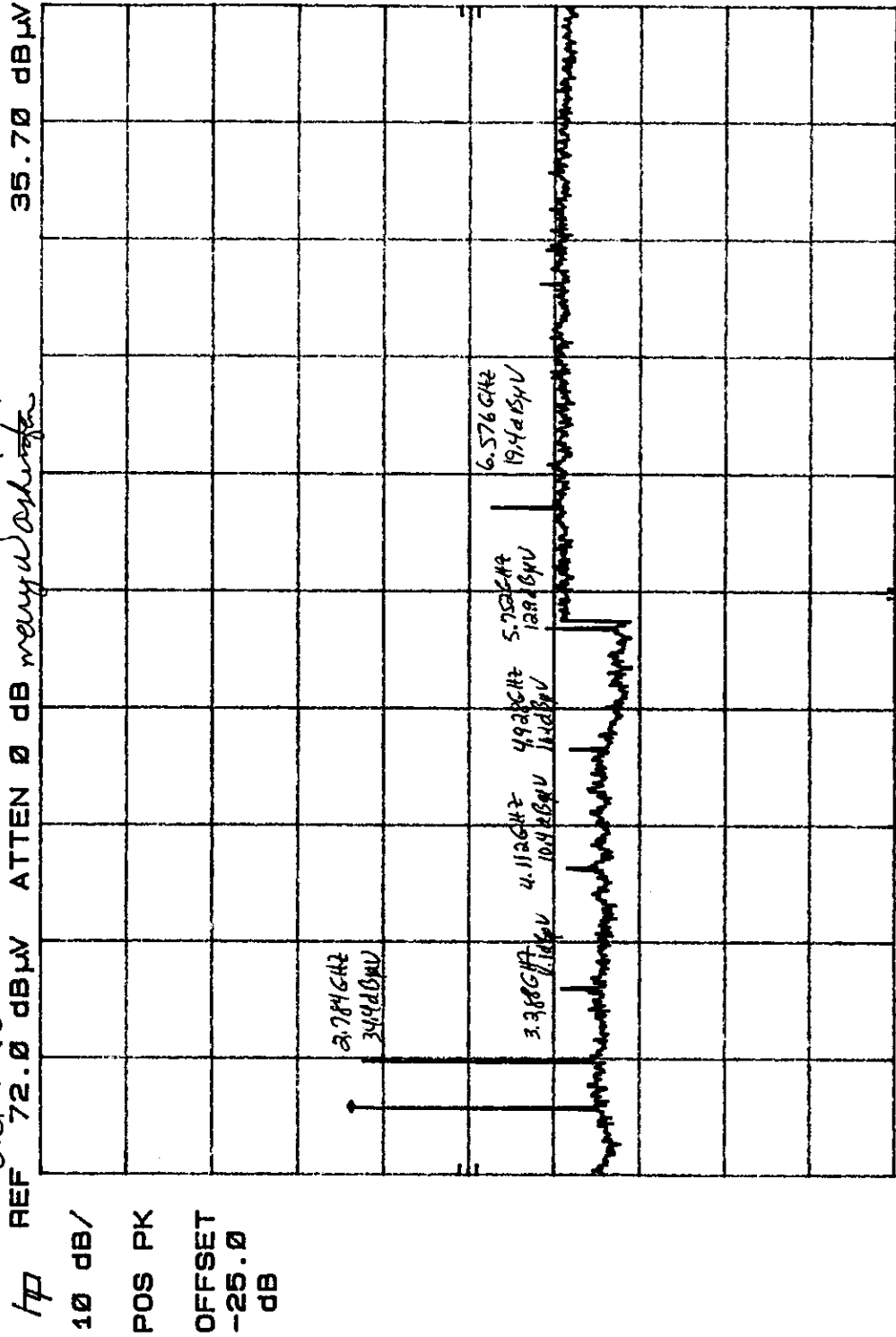

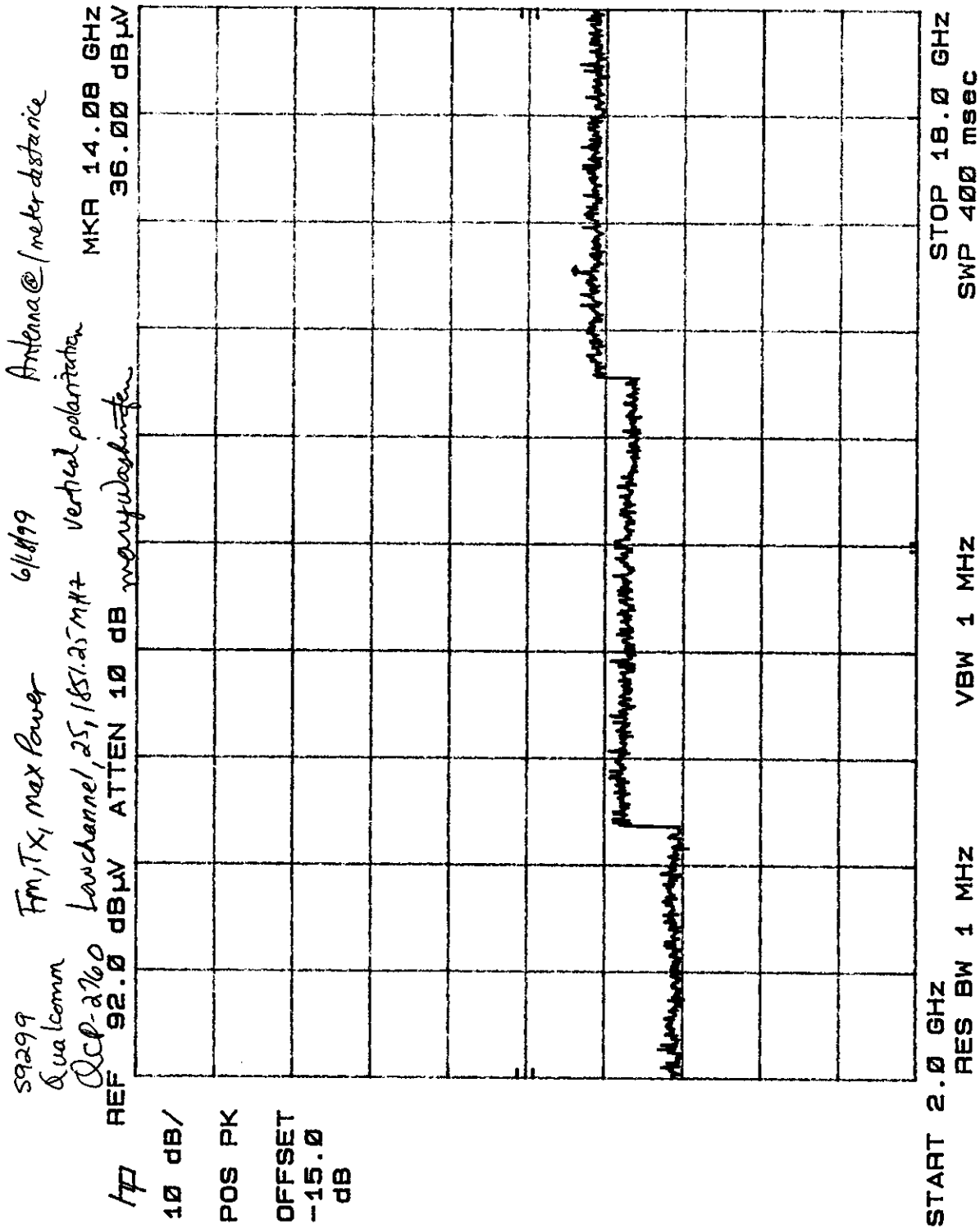

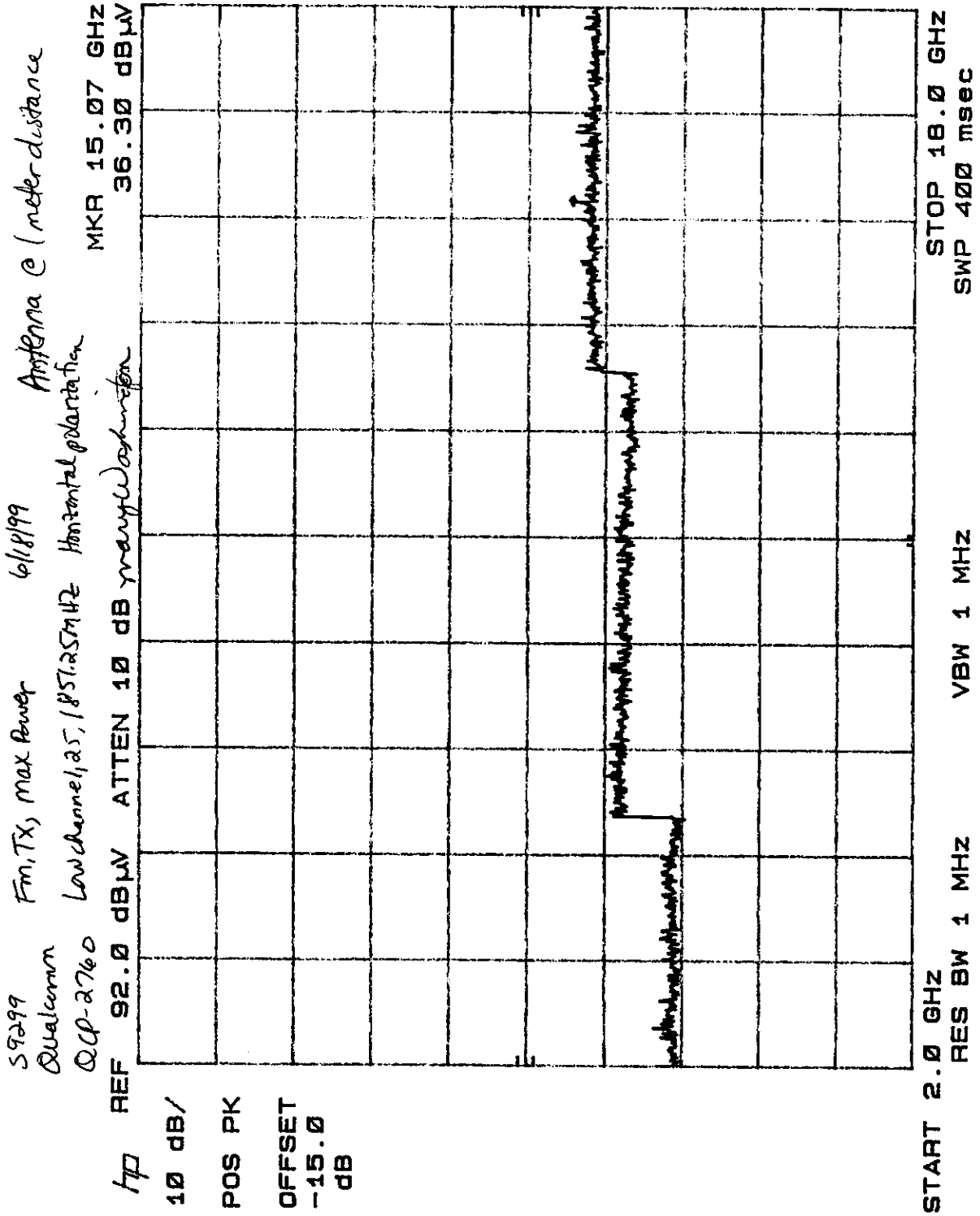

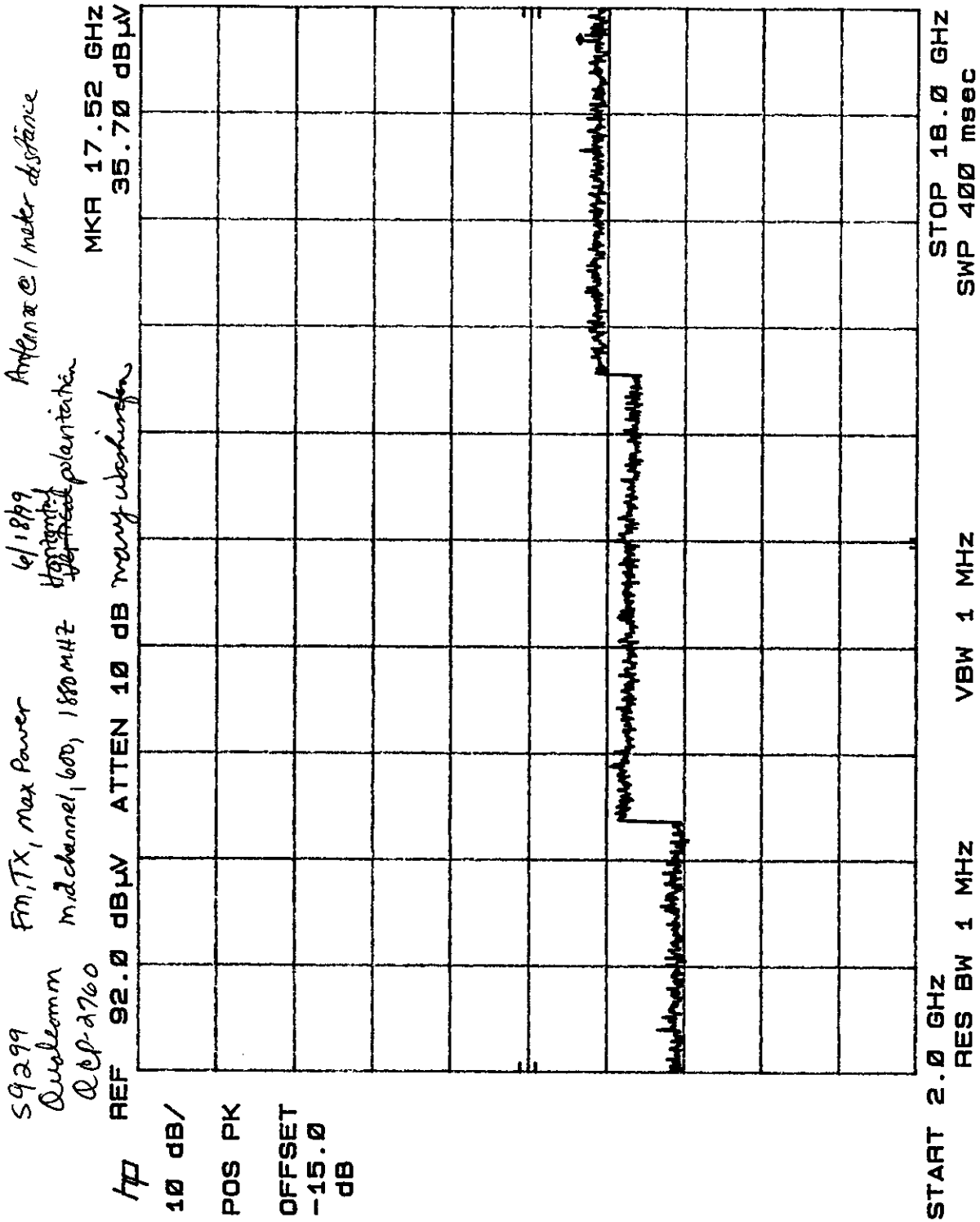

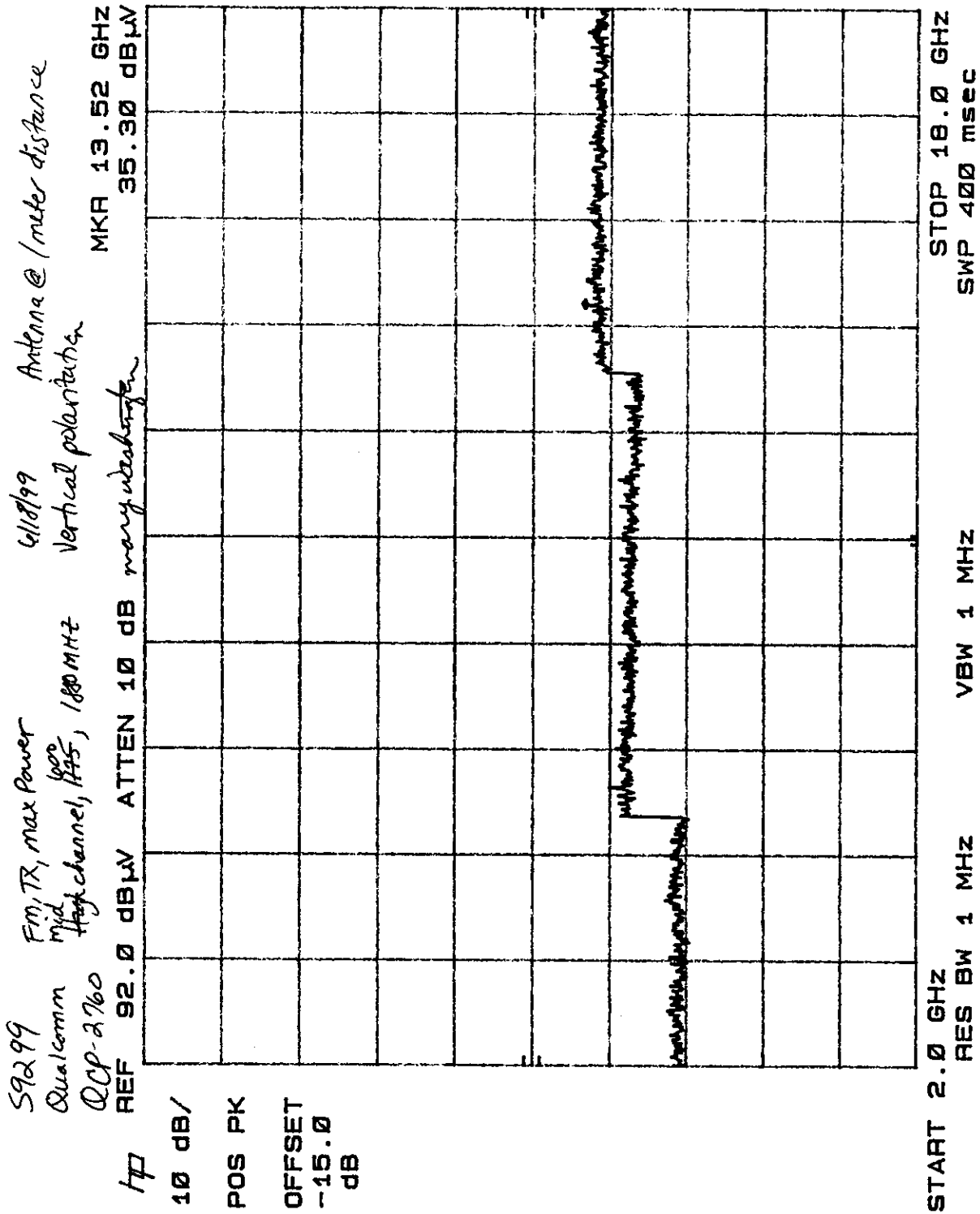

SQ299 FM, TX, max power 6/18/99 Antenna @ / meter distance
 Qualcomm High channel, 1175, 1908.75 MHz Vertical polarization
 QCP-2760 MKR 13.49 GHz
 REF 92.0 dBµV ATTN 10 dB menyawadunges 35.80 dBµV

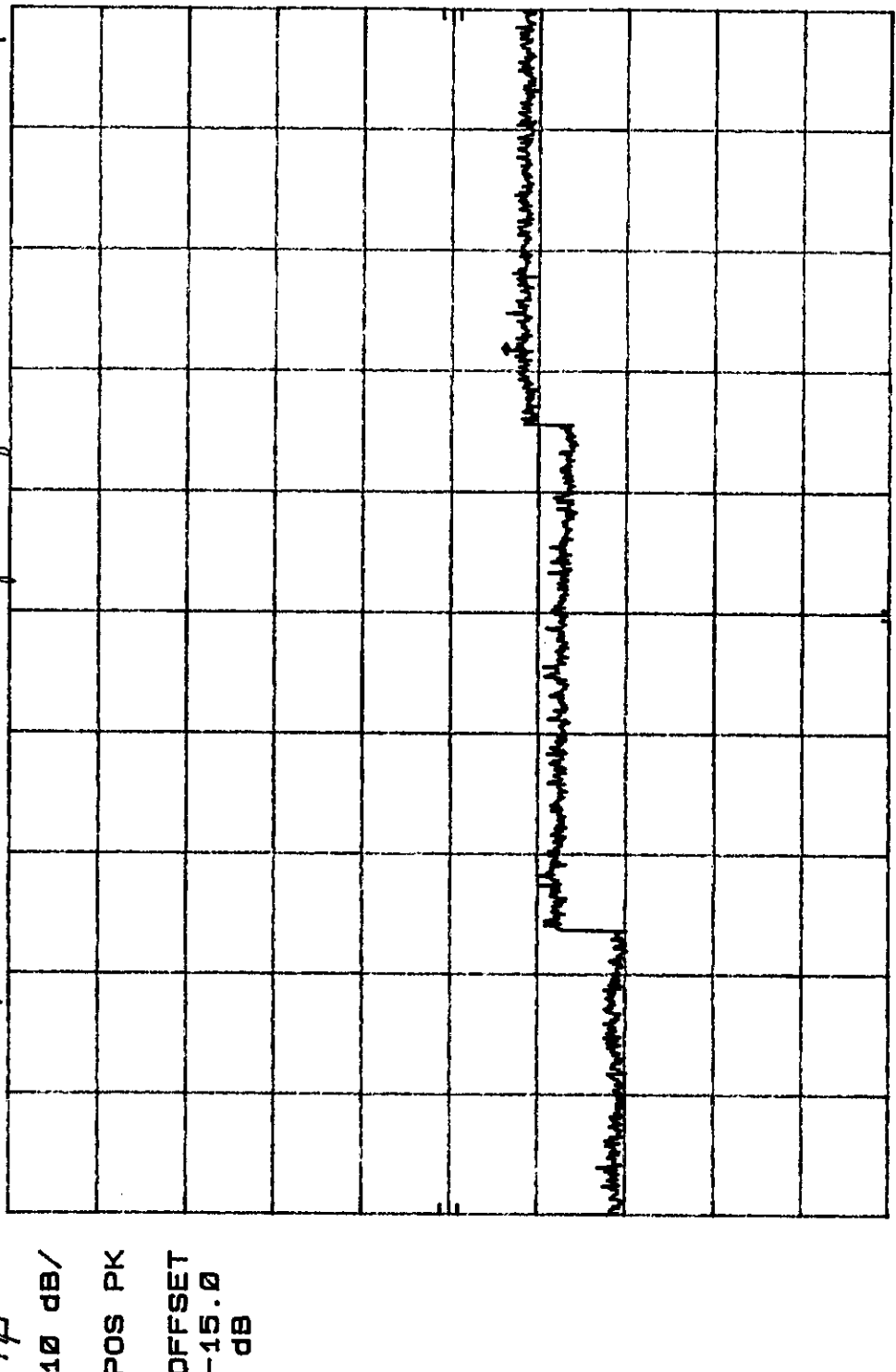

START 2.0 GHz RES BW 1 MHz VBW 1 MHz SWP 400 msec STOP 18.0 GHz

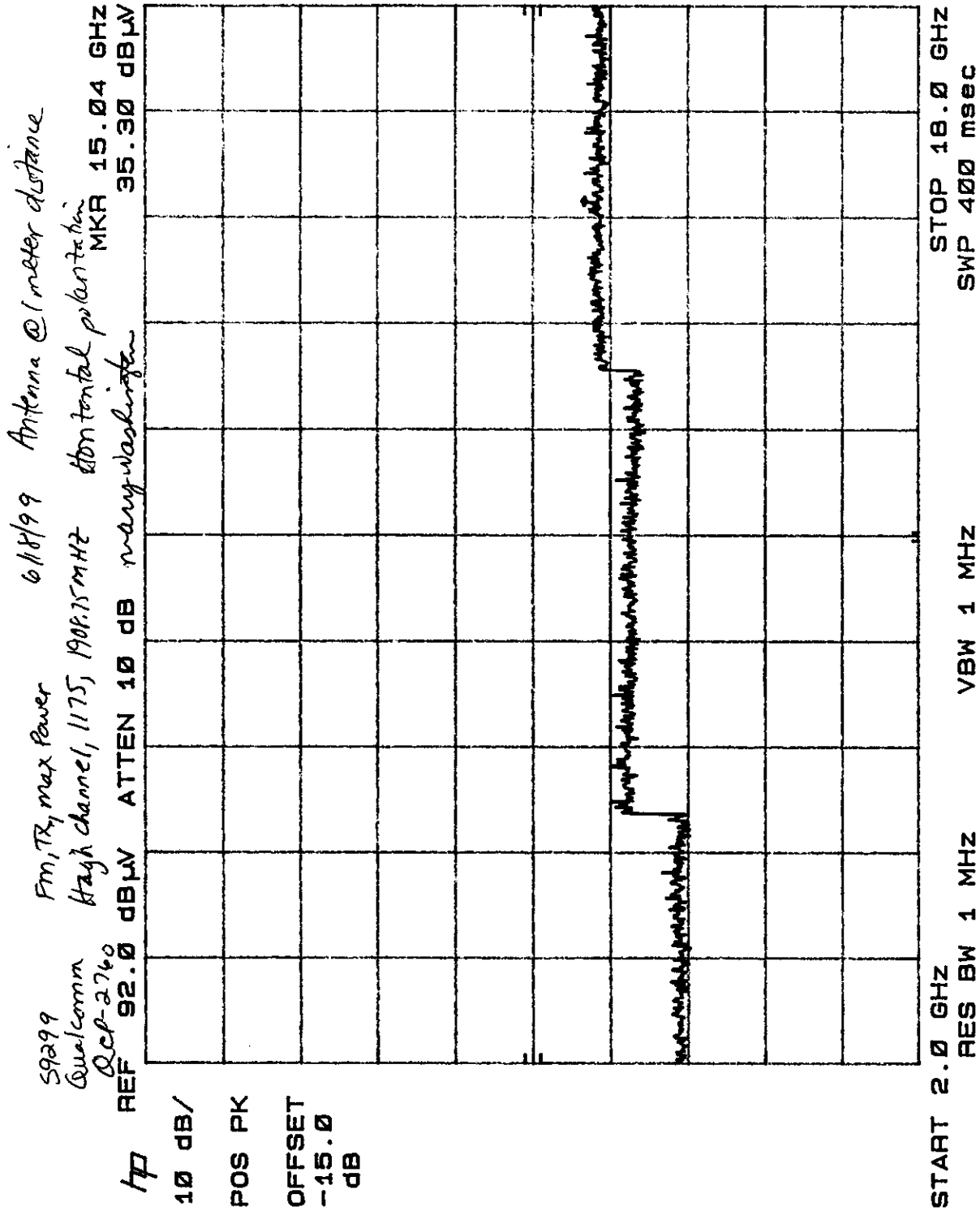

Exhibit 14

Transmitter RF Carrier Frequency Stability - FCC part 2.1055

Transmitter RF Carrier Frequency Stability - FCC part 2.1055
Phone transmitting in FM mode, but with no modulation on the carrier

Measured with HP8920 RF communication analyzer and HP 8560A Spectrum Analyzer

Carrier Frequency : 836.49 MHz FM

Temperature (C)	Transmitter Carrier Frequency Deviation (Hz)							Specification	
	3.2 V	3.4 V	3.5 V	3.6 V	3.8 V	4.0 V	4.2 V	lower limit	upper limit
-30	0	-5	0	5	0	10	0	-2091	2091
-20	0	0	0	10	8	15	0	-2091	2091
-10	0	2	5	5	-5	-5	0	-2091	2091
0	0	2	0	0	0	-5	0	-2091	2091
10	-5	-5	-2	-5	-4	-5	-3	-2091	2091
20	-4	-4	-4	-4	-4	-2	-4	-2091	2091
30	0	2	0	0	0	0	0	-2091	2091
40	-20	-18	-15	-10	-16	-5	0	-2091	2091
50	-20	-10	-15	-10	-10	-5	0	-2091	2091
60	-20	-10	-15	-15	-10	-10	-10	-2091	2091

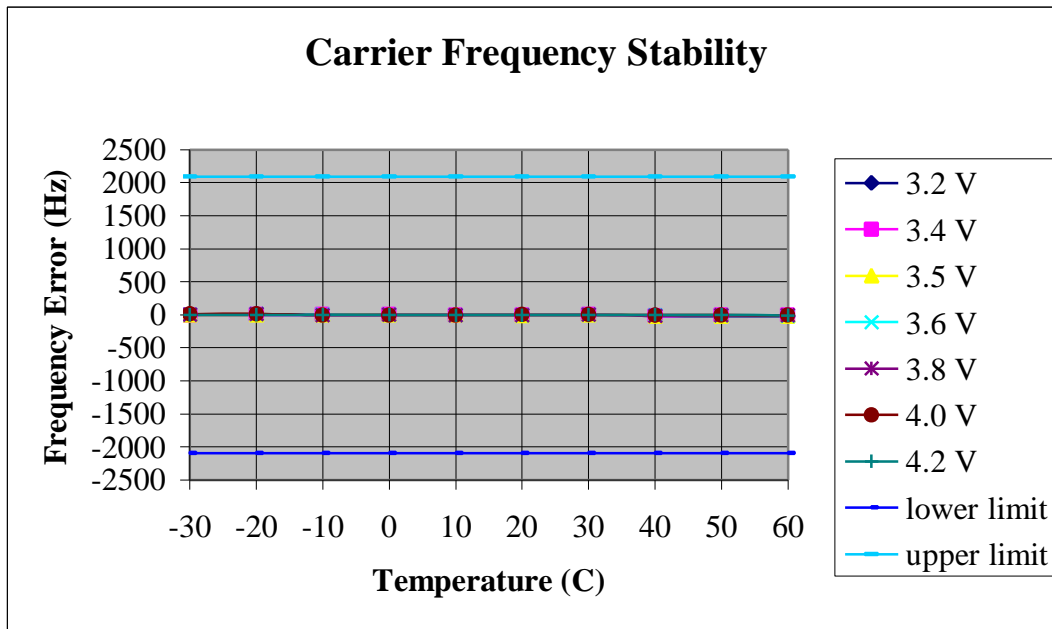

Exhibit 15

Transmitter RF Carrier Frequency Stability - FCC part 2.1055, 24.235

Transmitter RF Carrier Frequency Stability - FCC part 2.1055, 24.235
Phone transmitting in FM mode, but with no modulation on the carrier

Measured with HP8920 RF communication analyzer and HP 8560A Spectrum Analyzer

Carrier Frequency : 1880.00 MHz CDMA

Temperature (C)	Transmitter Carrier Frequency Deviation (Hz)							Specification	
	3.2 V	3.4 V	3.5 V	3.6 V	3.8 V	4.0 V	4.2 V	lower limit	upper limit
-30	1462	1462	1474	1450	1437	1375	1325	-4700	4700
-20	292	270	252	292	242	267	270	-4700	4700
-10	-222	-222	-212	-225	-207	-230	-242	-4700	4700
0	-300	-300	-299	-297	-297	-289	-272	-4700	4700
10	-35	-35	-35	-36	-35	-35	-38	-4700	4700
20	-17	-35	-25	-15	-35	-10	-7	-4700	4700
30	0	0	0	0	0	0	0	-4700	4700
40	-547	-545	-545	-527	-530	-535	-535	-4700	4700
50	-760	-787	-777	-767	-767	-748	-763	-4700	4700
60	-280	-302	-302	-287	-280	-270	-260	-4700	4700

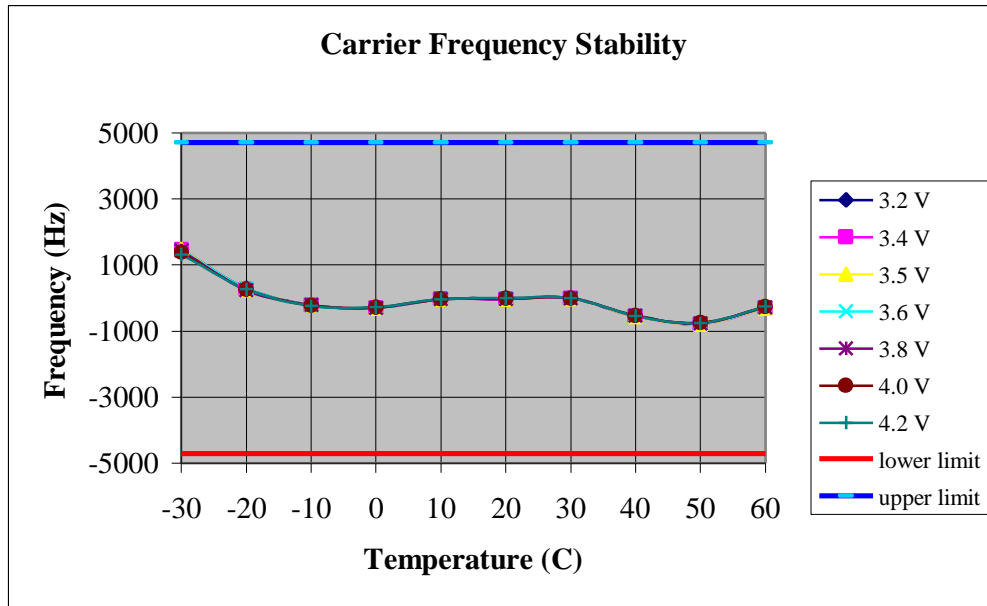

Exhibit 16

Measurement Procedures and Techniques

List of Equipment

Computer with Phone_T software

Spectrum Analyzers

HP8560E, S/N 3643A0680, CAL DUE 8/98

HP8594E, S/N 3710A04900, CAL DUE 12/17/99

HP8593E, S/N 3501A01547, CAL DUE 2/23/98

Audio Spectrum Analyzer

HP3588A, S/N 3005A00111, CAL DUE 2/28/99

Communication Test Set

HP8920B, S/N US35320824, CAL DUE 7/99

DC Power Supply

Measurement Procedures

RF Output Power

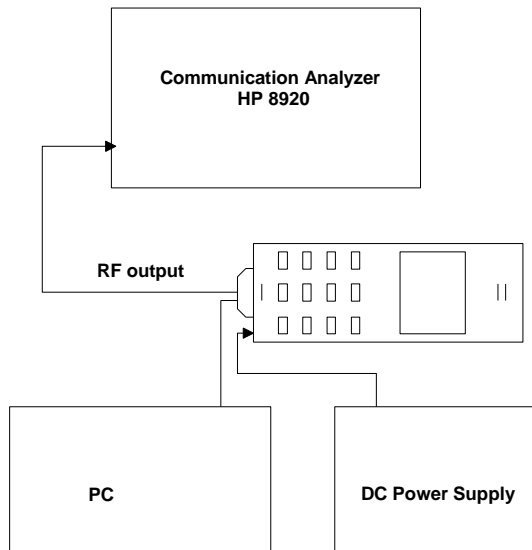

Definition - The output power rating of the transmitter is the power available at the output terminal of the transmitter when the terminal is connected to the normal load.

Method of Measurement - Measure the transmitter output carrier power without modulation using a communication test set for FM which has an RF wattmeter. An HP 8594E spectrum analyzer with the CDMA personality was used to measure CDMA mode.

Minimum Standard - The transmitter output power shall be maintained within +2 / -4 dB.

Modulation Audio Response

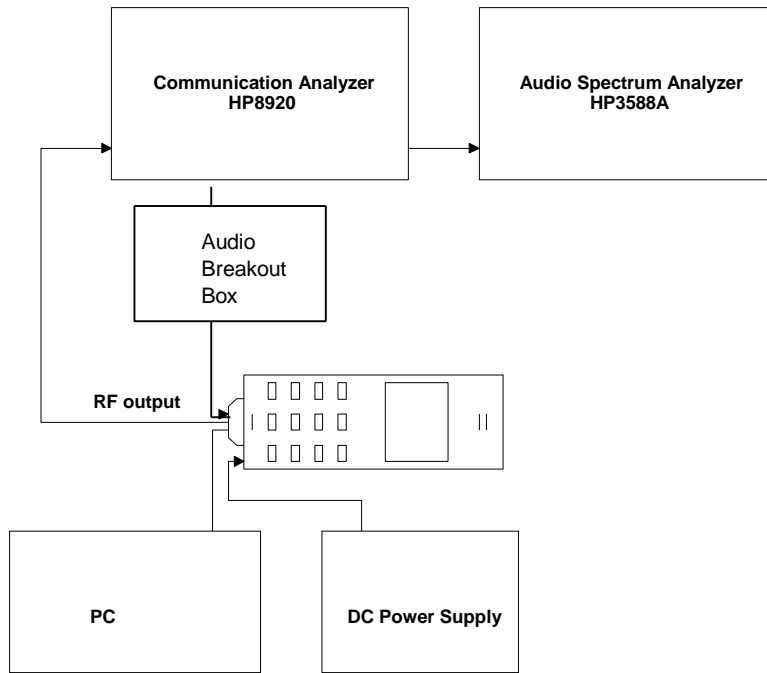

Definition - The transmitter audio frequency response is defined in terms of the degree of closeness with which the frequency deviation of the transmitter follows the prescribed 6 dB/octave pre-emphasis characteristic over a specified continuous audio frequency range while conforming to the required band-limiting conditions outside of that range.

Method of Measurement - Operate the transmitter with the compressor disabled, and monitor the output with HP8920 test receiver without de-emphasis. Apply a sine wave audio input to the transmitter external audio input port, vary the modulating frequency from 100 to 5000 Hz, and observe the input levels necessary to maintain a constant ± 2.9 kHz system deviation. Record the results. Adjust the audio input level to 20 dB greater than that required to produce ± 8 kHz deviation with 1 kHz tone. Vary the modulation frequency from 3 kHz to 30 kHz and observe the deviation while maintaining a constant audio input level. Use the audio spectrum analyzer to measure the output deviation at the same frequency as the input signal.

Minimum Standard - From 300 to 3000 Hz, the audio frequency response shall not vary more than +1 to -3 dB from a true 6 dB/octave pre-emphasis characteristic as referred to the 1000 Hz level (with the exception of a permissible 6 dB/octave roll-off from 2500 to 3000 Hz). Between 3 kHz to 30 kHz, the response shall not exceed that defined by the following table:

Frequency Range (f in kHz)	Attenuation Relative to 3 kHz (dB)
$3 \text{ kHz} \leq f \leq 5.9 \text{ kHz}$	$40 \log (f/3)$
$5.9 \text{ kHz} \leq f \leq 6.1 \text{ kHz}$	35
$6.1 \text{ kHz} \leq f \leq 15 \text{ kHz}$	$40 \log (f/3)$
$15 \text{ kHz} \leq f \leq 30 \text{ kHz}$	28

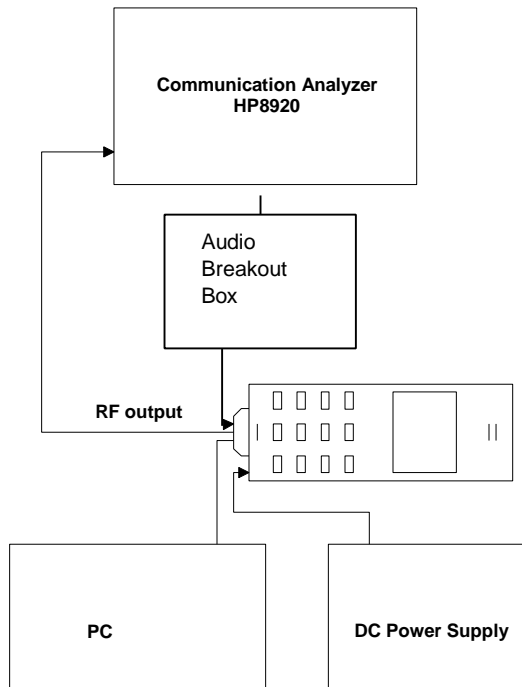
Modulation Limiting

Definition - Modulation limiting refers to the ability of the transmitter circuits to prevent the transmitter from producing deviation in excess of rated system deviation.

Method of Measurement - With the compressor enabled and the SAT disabled, adjust the audio input for ± 8 kHz peak deviation at 1000 Hz. Increase the audio input level by 20 dB. With the input level held constant at the 20 dB, and observe the deviation for 400 Hz, 1000 Hz, and 2.7 kHz.

Minimum Standard - The peak deviation shall not exceed the rated system peak frequency deviation of ± 12 kHz at any time.

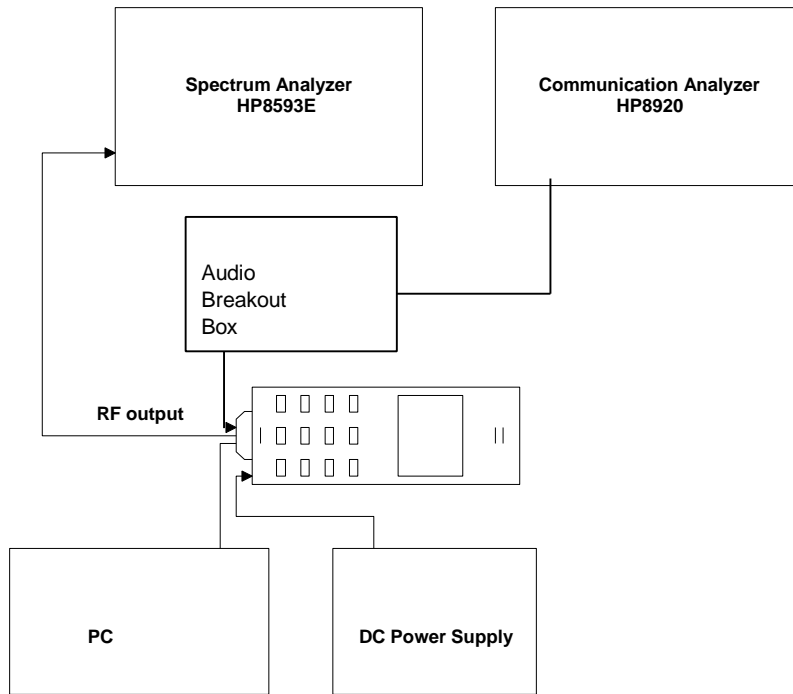
Occupied Bandwidth

Definition - The occupied bandwidth is defined as the spectrum noise produced at discrete frequency separations from the carrier due to all sources of unwanted noise within the transmitter in a modulated condition.

Method of Measurement - Use the spectrum analyzer and measure the following 8 modulating conditions: (1) For combined voice and SAT, disable the compressor, modulate with a 2500 Hz sine wave 13.5 dB greater than that required to produce ± 8 kHz peak deviation at 1000 Hz and a 6000 Hz SAT with ± 2.0 kHz peak deviation. (2) For combined Signaling Tone and SAT, modulate with a 10 kHz ST with ± 8 kHz peak deviation and a 6000 Hz SAT with ± 2.0 kHz peak deviation. (3) For wideband data, modulate with a quasi-random 10 kbps data pattern with ± 8 kHz peak deviation. (4) For CDMA, modulate with full rate. (5) For voice only, disable the compressor, modulate with a 2500 Hz sine wave 13.5 dB greater than that required to produce ± 8 kHz peak deviation at 1000 Hz. (6) For SAT only, modulate with a 6000 Hz SAT with ± 2.0 kHz peak deviation. (7) For ST only, modulate with a 10 kHz ST with ± 8 kHz peak deviation. (8) For combined SAT and DTMF, modulate with a 6000 Hz SAT with ± 2.0 kHz peak deviation and one of the DTMF tones.

Minimum Standard - The mean power of emissions from the transmitter with modulated carrier shall be attenuated below the mean power of the unmodulated carrier in accordance with the following.

- (1) For all modulation: In a 300 Hz bandwidth centered on any frequency removed from the carrier by greater than 20 kHz up to and including 45 kHz, at least 26 dB.

- (2) For modulation by combined voice and SAT: In a 300 Hz bandwidth centered on any frequency removed from the carrier frequency by greater than 45 kHz, at least $63 + 10 \log$ (mean output power in Watts) dB. Since the equipment is rated 0.6 W, the limit is 61 dB.
- (3) For modulation by wideband data and combined ST and SAT: In a 300 Hz bandwidth centered on any frequency:
 - (a) More than 45 kHz up to and including 60 kHz, at least 45 dB.
 - (b) More than 60 kHz up to and including 90 kHz, at least 65 dB.
 - (c) More than 90 kHz up to the first multiple of the carrier frequency, at least $63 + 10 \log$ (mean power in Watts) dB.

In addition, in a 30 kHz bandwidth centered anywhere between 869 and 894 MHz, the mean power of emissions from the transmitter with modulated carrier shall not exceed -80 dBm.

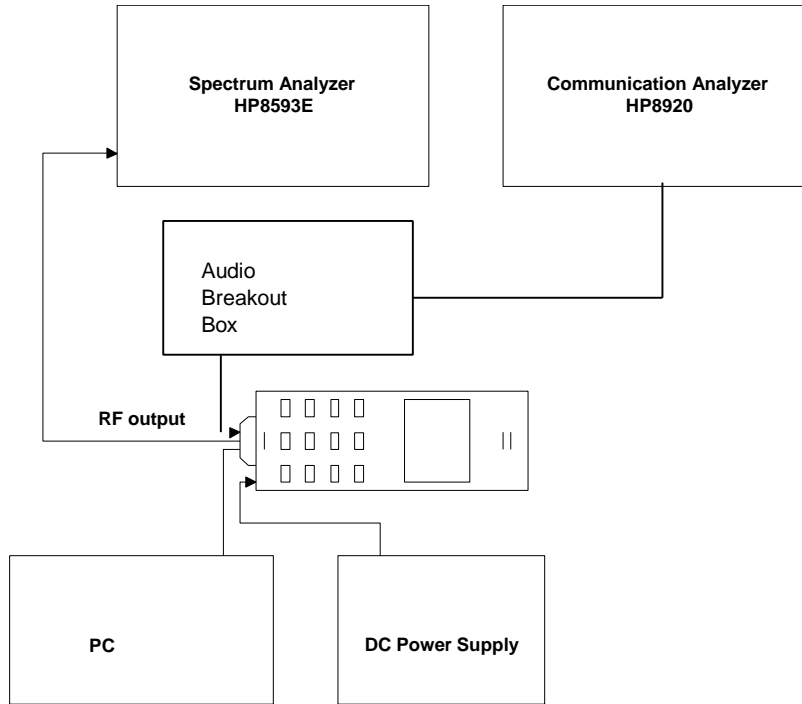
Conducted Spurious and Harmonic Emissions at Antenna Terminal

Definition - The conducted harmonic and spurious emissions are emissions at the antenna terminals on a frequency or frequencies that are outside the authorized bandwidth of the transmitter.

Method of Measurement - The transmitter shall be alternately modulated with combined voice and SAT and with wideband data. For combined voice and SAT measurements, disable the compressor, modulate with a 2500 Hz sine wave 13.5 dB greater than that required to produce ± 8 kHz peak deviation at 1000 Hz and a 6000 SAT with ± 2.0 kHz peak deviation. For wideband data measurements, the transmitter shall be modulated with a quasi-random 10 kbps data pattern with ± 8 kHz peak deviation. The measurement shall be made with a spectrum analyzer from the lowest radio frequency generated in the equipment to the 10th harmonic of the carrier except for that region within 75 kHz of the carrier frequency.

Minimum Standard - Conducted harmonic and spurious emissions shall be attenuated below the level of emissions of the carrier frequency by at least $43 + 10 \log$ (mean output power in Watts) dB.

Radiated Spurious and Harmonic Radiation

Definition - The radiated spurious emissions are emissions from the subscriber unit with the attached antenna fully extended. The radiated spurious emissions include those emissions radiated from the attached antenna as well as the equipment cabinet and attached cables.

Method of Measurement - The measurement shall be conducted at standard radiation test site with a search antenna which is movable vertically and is rotatable 90 degrees for vertically and horizontally polarized signals.

Minimum Standard - Radiated spurious emissions shall be attenuated below the maximum level of emission of the carrier frequency by at least $43 + 10 \log$ (mean output power in Watts) dB.

Frequency Stability

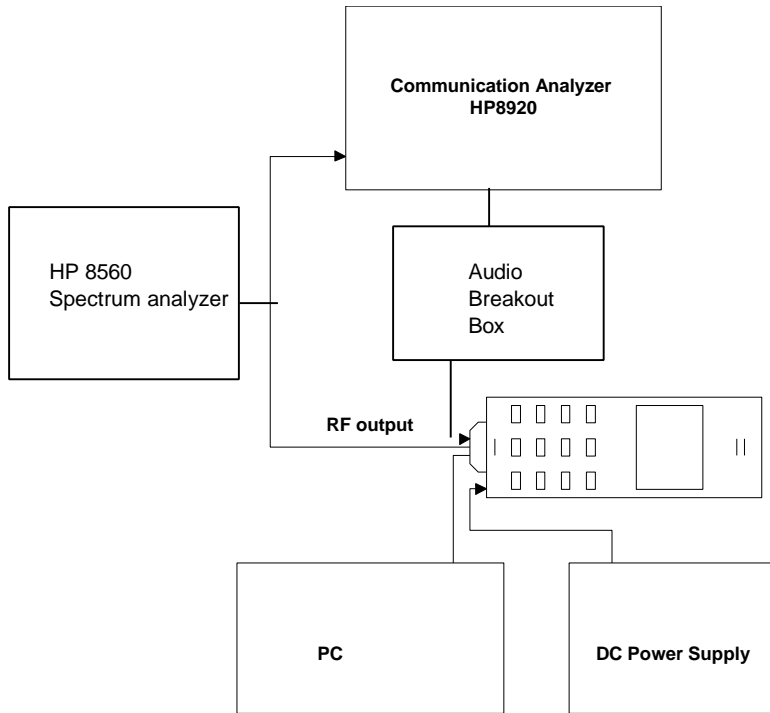

Definition - The frequency stability is the ability of the transmitter to maintain an assigned carrier frequency.

Method of Measurement - Use the communication tester to sample the transmitter RF output signal and measure its frequency. Vary the ambient temperature from -30 to +60 °C, and also vary the DC supply voltage to the equipment from 3.5 to 4.1 V at each temperature.

Minimum Standard - The transmitter carrier frequency shall be maintained within ± 2.5 ppm.

Exhibit 17

FCC Letter of Site Recognition

Included in the radiated spurious emissions data.

Exhibit 18

Product Overview and Circuit Diagrams

Technical Description

The Dual Band Phone consists of an Analog FM mode and Code Division Multiple Access (CDMA) mode. The analog transmitter is only for use in the Cellular Radiotelephone Service Part 22 of the CFR. The Portable Phone is designed to meet the requirements of TIA/EIA/IS-98-A standards for Dual-Mode Wideband Spread Spectrum Cellular Mobile Stations.

Frequency Range of operation: 824.04 - 848.97 MHz Transmitter and 869.04 - 893.07 Receiver. Max RF power output is 0.6W Max FM and 0.2W Max Digital.

Power Supply requirements: 4.1V DC Li-Ion battery.

Limiting modulation

The audio input is sampled, digitally limited, and then filtered to amplitude and frequency limit the signal applied to the modulator. The device supports the AMPS standard. The device has an operating temperature range of -30 to +60 C. The functions include Compandor, PLL lock detect for received data, audio signal filtering for signals.

Limiting Power

Transmitted power is monitored by an RF detector diode which is coupled from the Power Amplifier (PA) output. The detected DC voltage is fed into a processor which uses a calibration table along with an offset correction and temperature correction table to control power limits. When the RF power exceeds a predetermined limit the gain of the stage preceding the PA is reduced.

Block and Circuit Diagrams

Block and circuit diagrams are included in separate attachments.

Exhibit 19

FCC Identification Label Information

QCP 2760 Label Drawings

Actual size of the label that is placed on the rear side near the bottom of the phone

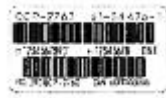

Enlarged version of the label that is placed on the rear side near the bottom of the phone.



Actual size of the label that is placed inside the battery well, under the internal battery.



Enlarged version of the label that is placed inside the battery well, under the internal battery.



Exhibit 20

Photographs

The photographs are in a separate attachment.

Exhibit 21

Users Manuel

The user's guide is in a separate attachment.

Exhibit 22

SAR DATA

The SAR data is in a separate attachment.