

80-C6303-1.book Page 1 Friday, June 30, 2006 3:12 PM

Globalstar™

**QUALCOMM Globalstar
GIK-1700 Globalstar
Installation Kit
User Manual**



Released - Internal Use Only

Released - Internal Use Only

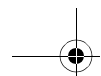

This manual is based on the production version of the QUALCOMM Globalstar GIK-1700 Globalstar Installation Kit. Software changes may have occurred after this printing.

QUALCOMM reserves the right to make changes in technical and product specifications without prior notice.

QUALCOMM Incorporated
5775 Morehouse Drive, San Diego, CA 92121-1714
Document Number 80-C6303-1 Rev B

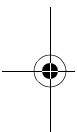

Copyright © 2006 QUALCOMM[®] Incorporated
All rights reserved

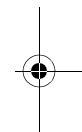

This technology was exported from the United States Government. Diversion contrary to U.S. law prohibited.

QUALCOMM[®] is a registered trademark of QUALCOMM Incorporated.
Digital by QUALCOMM[®] is a registered trademark of QUALCOMM Incorporated.
SMART KEY[™] is a trademark of QUALCOMM Incorporated.
Globalstar[™] is a trademark of Globalstar, Inc.

All other trademarks and registered trademarks are the property of their respective owners.

Printed in China

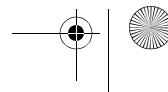
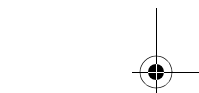
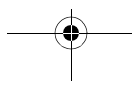

Released - Internal Use Only

Released - Internal Use Only



Table of Contents

- Introduction 1**
- Features 1
- Safety precautions when using the kit 1
- Safety precautions when using the GSP-1700
- Satellite Phone 2
- Exposure to radio frequency signals 2
- Antenna care 4
- Phone operation 4
- Driving 4
- Electronic devices 5
- Vehicles and vessels 6
- Posted facilities 6
- For vehicles equipped with an air bag 7
- Battery care 7
- Other safety issues 8
- Components 9**
- Globalstar Installation Kit standard components 10
- Component parts 11
- Globalstar Installation Kit 11
- Speaker 11
- Hands-free microphone 11
- Power interface cable 11
- Car Power Adapter 13
- Exterior antenna 13
- Antenna cables 13
- Globalstar Installation Kit optional accessories 14
- Optional accessories (not included in kit) 15

Released - Internal Use Only

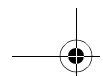

Privacy headset 15

Privacy handset 15

Globalstar Data cable 15

Operation 17

 Using the phone in a vehicle 17

 Attaching the phone to the Globalstar Installation Kit 17

 Turning on the phone and kit 18

 Charging the phone battery 19

 Car stereo mute 20

 Hands-free mode 20

 When you use hands-free mode 21

 Adjusting speaker volume 21

 Connecting to a personal computer 22

 Privacy Headset 22

 Privacy headset operation 22

Troubleshooting 25

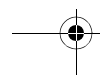
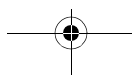
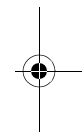
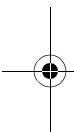



Introduction

Before using your Globalstar Installation Kit in a vehicle, please read this manual thoroughly and retain it for future reference. Professional installation is recommended.

Features

The Globalstar Installation Kit (GIK) allows your Globalstar GSP-1700 satellite phone to be used as a mobile phone in your vehicle.

With this kit installed in a vehicle, you can:

- Turn the phone on and off by turning the vehicle's ignition on and off.
- Talk without picking up the phone.
- Obtain unlimited talk time using DC current supplied by your vehicle.
- Charge the phone's battery.

Safety precautions when using the kit

When using your phone in a vehicle, please observe the following rules.

Introduction



Caution

Failure to follow these instructions and the GIK-1700 Installation Sheet may lead to serious personal injury and possible property damage.

- Secure the phone in your vehicle to prevent personal injury and damage to the phone in the event of an accident.

When attaching or detaching the exterior antenna to the kit with the antenna cables, disconnect all power to the phone and the kit. Note that DC voltage is present in the central conductor of the antenna cable (45-C6162-1). See Globalstar Installation Kit standard components, page 10.

- Detach the phone from the kit and disconnect the power interface cable (45-C6184-1) to the kit when jump-starting the vehicle or recharging the car battery. Jump-starting may cause the kit fuse to open. Refer to the installation sheet for further information regarding interconnects.

Safety precautions when using the GSP-1700 Satellite Phone

Exposure to radio frequency signals

Your wireless handheld portable telephone is a low power radio transmitter and receiver. When it is on, it receives and also sends out radio frequency (RF) signals.

In August, 1996, the Federal Communications Commissions (FCC) adopted RF exposure guidelines with safety levels for hand-held wireless phones. Those guidelines are consistent with the safety

Introduction

standards previously set by both U.S. and international standards bodies:

- ANSI/IEEE C95.1-1999 Standard¹
- NCRP Report 86 (1986)²
- ICNIRP (1998)³
- IRPA (1991) Guidelines on Protection Against Non-ionizing Radiation⁴

The phone and this kit are designed to comply with established ANSI, FCC, and international safety standards for safe levels of human exposure to RF energy. Nonetheless, RF field intensity at the surface of the transmitting antenna is fairly high. Maintaining a minimum line-of-sight separation distance of 25 cm (10 inches) between the transmitting kit antenna and all personnel will ensure that the General Population/Uncontrolled Exposure Maximum Permissible Exposure (MPE) limits are not exceeded. This satisfies the MPE limits mandated by the FCC in 47 CFR Ch. 1 (2006 Edition), Part 1, paragraph 1.1310 and defined in the ANSI/IEEE C95.1-1999 standard, and also satisfies the slightly more-stringent European and international exposure limit recommendations of IRPA (1991) and ICNIRP (1998).

-
1. American National Standards Institute
 2. National Council on Radiation Protection and Measurements
 3. International Commission on Non-Ionizing Radiation Protection
 4. Internal Radiation Protection Association

Released - Internal Use Only

Introduction

Antenna care

Use only the supplied or an approved replacement antenna. Unauthorized antennas, modifications, or attachments could damage the phone and may violate FCC regulations.

Phone operation

Hold the phone as you would any other telephone with the antenna pointed up and over your shoulder.



Tip

For your phone to operate most efficiently:

- Extend your antenna fully.
- Do not touch the antenna unnecessarily when the phone is in use. Contact with the antenna affects call quality and may cause the phone to operate at a higher power level than otherwise needed.

Driving

In the areas where you drive, always obey the local laws and regulations on the use of wireless telephones.

If using your phone while driving, please:

- Give full attention to driving – driving safely is your first responsibility.
- Use hands-free operation, if available.

Introduction

- Pull off the road and park before making or answering a call if driving conditions require you to do so.

Electronic devices

Most modern electronic equipment is shielded from RF signals. However, certain electronic equipment may not be shielded against the RF signals from your wireless phone.

Pacemakers

The Health Industry Manufacturers Association recommends that a minimum separation of six inches (15 cm) be maintained between a handheld wireless phone and a pacemaker to avoid potential interference with the pacemaker. These recommendations are consistent with the independent research by and recommendations of Wireless Technology Research.

Persons with pacemakers:

- Should ALWAYS keep the phone more than six inches from their pacemaker when the phone is turned on.
- Should not carry the phone in a breast pocket.
- Should use the ear opposite the pacemaker to minimize the potential for interference.
- If you have any reason to suspect that interference is taking place, turn your phone off immediately.

Hearing aids

Some digital wireless phones may interfere with some hearing aids. In the event of such interference, you may want to consult

Released - Internal Use Only

Introduction

your service provider (or call the customer service line to discuss alternatives). *Optional for each phone manufacturer.*

Other medical devices

If you use any other personal medical device, consult the manufacturer of your device to determine if it is adequately shielded from external RF energy. Your physician may be able to assist you in obtaining this information.

Turn your phone off in health care facilities when any regulations posted in these areas instruct you to do so. Hospitals or health care facilities may be using equipment that could be sensitive to external RF energy.

Vehicles and vessels

RF signals may affect improperly installed or inadequately shielded electronic systems in motor vehicles. Check with the manufacturer or its representative regarding your vehicle. You should also consult the manufacturer of any equipment that has been added to your vehicle.

Posted facilities

Turn your phone off in any facility where posted notices require you to do so.

Aircraft

FCC regulations prohibit using your phone while in the air. Switch off your phone before boarding an aircraft.

Introduction

Blasting areas

To avoid interfering with blasting operations, turn your phone off when in a “blasting area” or in areas posted: “Turn off two-way radio”. Obey all signs and instructions.

Potentially explosive atmospheres

Turn your phone off when in any area with a potentially explosive atmosphere and obey all signs and instructions. Sparks in such areas could cause an explosion or fire resulting in bodily injury or even death.

Areas with a potentially explosive atmosphere are often but not always clearly marked. They include fueling areas such as gasoline stations; below deck on boats; fuel or chemical transfer or storage facilities; vehicles using liquefied petroleum gas (such as propane or butane); areas where the air contains chemicals or particles, such as grain, dust, or metal powders; and any other area where you would normally be advised to turn off your vehicle engine.

For vehicles equipped with an air bag

An air bag inflates with great force. DO NOT place objects, including both installed or portable wireless equipment, in the area over the air bag or in the air bag deployment area. If in-vehicle wireless equipment is improperly installed and the air bag inflates, serious injury could result.

Battery care

The phone’s battery stores a large amount of energy when fully charged. If the battery is punctured, crushed, severely overheated,

Introduction

or charged in a non-QUALCOMM charger, this energy can be released suddenly and result in potential injury.

- Do not overheat the battery by leaving it on a heater or in the sun.
- Do not dispose of the battery in a trash compactor or incinerator.
- Use only charging accessories manufactured by QUALCOMM, and discontinue use of the battery if it becomes damaged.

Other safety issues

In order to avoid the potential for confusing the phone as a weapon, the phone features a distinctive flame orange dot on the top of the antenna.

- This orange dot is a convention used by manufacturers of various devices and is familiar to safety officers in the country of manufacture and other countries.
- Do not remove or cover the dot, and avoid using or handling the phone in a threatening manner or so as to suggest that the phone is a weapon.

Released - Internal Use Only



Components

Check the components of the Globalstar Installation Kit listed below. If there is something missing, please contact the service provider where you purchased your kit.

Component parts

CV90-C6029-1	Globalstar Cradle
CV90-C6030-1	Speaker
330-12363-0156	Hands-Free Microphone
45-C6184-1	Power Interface Cable
65-C6185-1	Hardware Kit
50-C6045-1	Speaker Mounting Bracket
CV90-C6032-1	Car Power Adapter
45-C6162-1	Antenna Cable
65-C6056-1	Literature Kit
GAT-17MP	Patch Antenna
GAT-17HX	Quadri-filar Helix Antenna

Components

Globalstar Installation Kit standard components

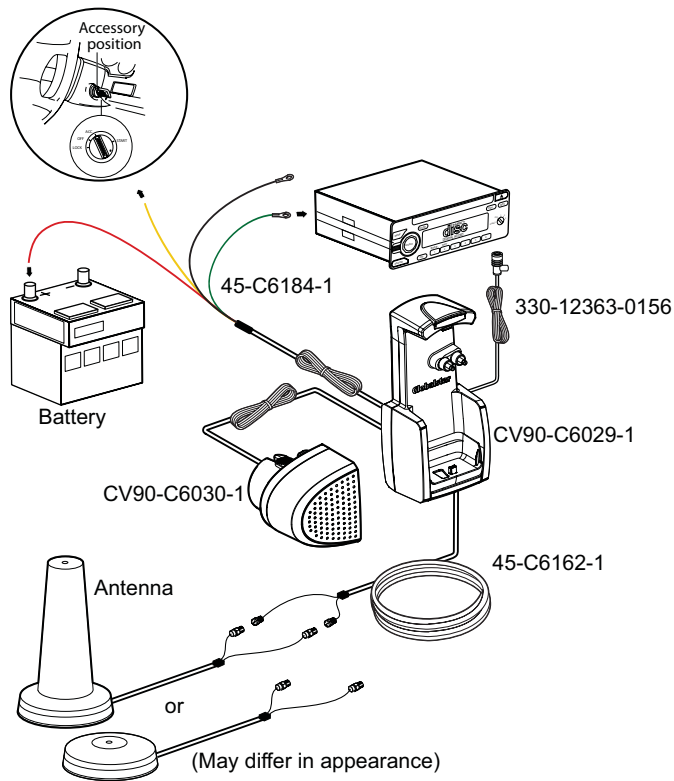

Released - Internal Use Only

*Components***Component parts****Globalstar Installation Kit**

The cradle (CV90-C6029-1) securely holds the Globalstar phone, interfaces to the vehicle's power, and houses the electronic circuit for the kit. It provides and controls the supply voltages for the accessories and the charge current for the phone.

Speaker

The speaker (CV90-C6030-1) connects to the kit speaker jack. It should be mounted at least 20 inches (50 cm) away from the Hands-Free microphone and should not be pointed towards the microphone. It can be mounted either on the kit or remotely, depending on the user's preference.

Hands-free microphone

The hands-free microphone (80-C6061-1), a unidirectional mouse-style microphone, connects to the kit microphone jack. It can be installed with velcro or tape on the A-pillar or on the driver's sun visor.

Power interface cable

There are two options to connect to the car's power supply; the car interface cable and the Car Power Adapter.

The power interface cable (45-C6184-1) connects to the kit via the 4-pin connector.

Components

- The fused red lead connects to the positive terminal of the vehicle's battery.
- The black lead ground (GND) connects to a clean, unpainted metallic part of the vehicle.
- The fused green lead (STEREO MUTE) is for car stereo mute.
- The fused yellow lead (IGNS) is for ignition sense.

Car stereo muting (STEREO MUTE)

The phone provides a feature to mute the car stereo automatically during a conversation, which is convenient and provides for safer hands-free operation. When the phone rings, the green fused lead provided for the stereo mute feature goes to ground.

**Note**

This feature requires a car stereo that supports it.

Ignition sense

The ignition sense feature prevents the car kit from draining the vehicle's battery by executing an auto power off 30 seconds after the ignition key has been turned off, if not currently in a call. The yellow wire of the power interface cable (45-C6184-1) is used for the ignition sense feature. The use of ignition sense is recommended to prevent accidental draining of the vehicle's battery. The wire is connected via a fuse to the vehicle's ignition.

*Components****Car Power Adapter***

The kit can alternatively be powered using the Car Power Adapter (CPA) (CV90-C6032-1).

- Connect the CPA cable to the 4-pin connector on the back of the unit.
- Plug the CPA into the vehicle's car power port.

**Caution**

Refer to vehicle's user manual regarding car power port operation. Some car power ports provide continuous power regardless of vehicle ignition state. This may require the user to remove the CPA from car power port to avoid vehicle battery drain when vehicle is off. When using the CPA, the stereo mute function is not available.

Exterior antenna

The exterior antenna permits communication with the satellite when the phone is installed in the kit.

Antenna cables

The antenna cable consists of a pair of paired coaxial cables (45-C6162-1) that connect the exterior antenna to the kit. Use only the antenna cables that come with your kit when connecting the exterior antenna. **Do not cut or modify the antenna cables.**

Components



Caution

DC voltage exists in the central conductor of the antenna cable. Be sure that the cable connector is installed inside the vehicle.

Globalstar Installation Kit optional accessories

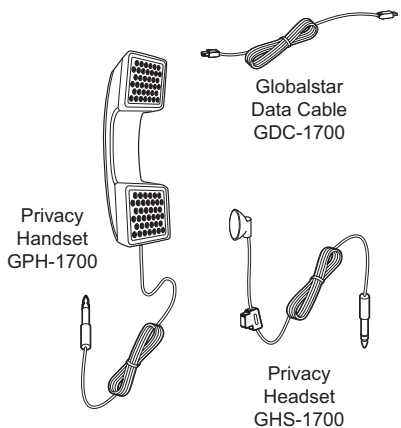

Optional accessories

- GHS-1700 Privacy Headset
- GPH-1700 Privacy Handset
- GDC-1700 Globalstar Data Cable

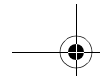

Components

Optional accessories (not included in kit)

Privacy headset

The privacy headset (GHS-1700) offers more privacy during a call and is connected directly to the phone.

Privacy handset

The privacy handset (GPH-1700) offers more privacy during a call and is connected directly to the phone.

Globalstar Data cable

A Globalstar data cable (GDC-1700) can connect a computer or other device to the kit, allowing the phone to send and receive data.

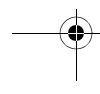
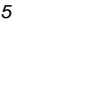
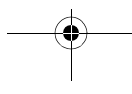
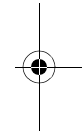
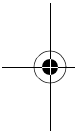

Released - Internal Use Only

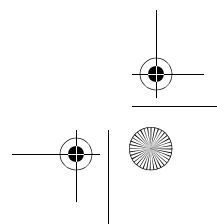
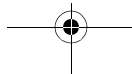
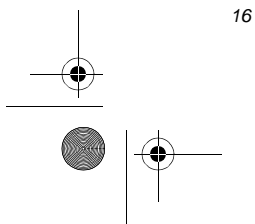
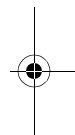
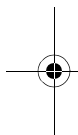
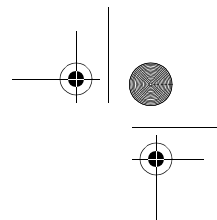
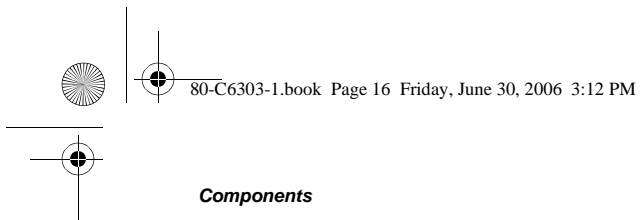

Released - Internal Use Only



Operation

Using the phone in a vehicle

Attaching the phone to the Globalstar Installation Kit

1. Remove the kit connector cover label from the back of the phone.

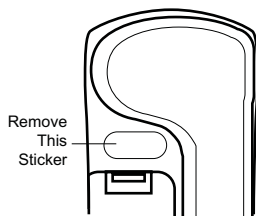

2. Remove rubber plug from connector at bottom of phone. Rotate rubber plug toward antenna.
3. Insert the connector on the bottom of the cradle into the connector on the phone.
4. Push the phone down and back until it locks into place. You should hear a click.
5. To remove the phone, press the release button at the top of the cradle, and gently remove the phone.
6. Replace the rubber plug in the connector.

Operation

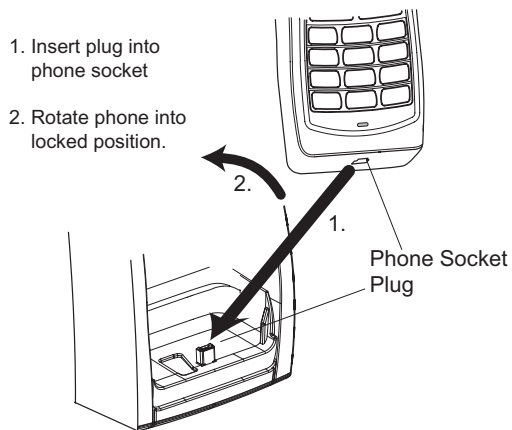

Caution

Do not pull the phone out of the cradle without first pressing the release button. If you do so, you could damage the phone and the cradle.

Turning on the phone and kit

When you turn on the vehicle's ignition, the phone and the kit are turned on. The phone is ready to make or receive a call.



Operation

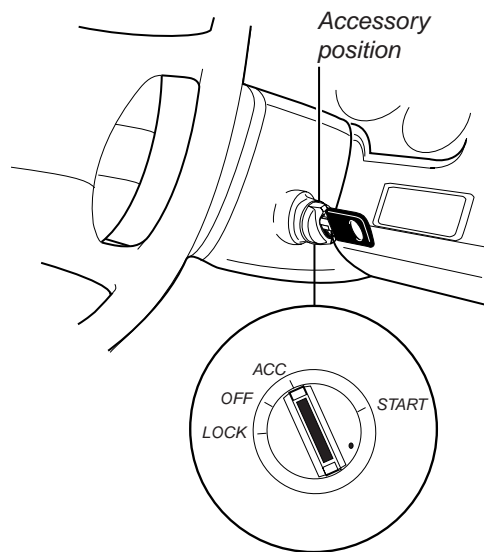

358AB_1999Q



Note

If you turn off the vehicle's ignition during a call, the kit remains on so you can continue talking. (The kit will remain on until the phone battery is fully charged. See Charging the phone battery, page 19.)

Charging the phone battery

When a powered on phone is placed in the kit, whether the ignition is on or off, the kit powers up and charges the phone's battery. When the charge is complete, the kit will power down.

Operation

If both the phone and the kit are powered down and the phone is placed in the kit, the phone will charge as long as:

- the kit is wired to the vehicle battery, OR
- the car power adapter cable has power (the light on the cable is lit).

The phone will charge to full and then both the phone and the kit will power down.

Car stereo mute



Note

This feature requires a car stereo that supports it.

The kit has the ability to mute the car stereo system automatically when you make or receive a call if the car stereo has an audio mute line (STEREO MUTE).

Hands-free mode

The kit allows you to use your phone more efficiently and safely while driving in your vehicle. When the phone is properly attached to the cradle and the vehicle's ignition is on, you can speak into the microphone and listen to the other party through the speaker while keeping both hands on the steering wheel.



Caution

You should stop the vehicle in a safe place before attempting to dial a number. If you must talk while the



Operation

vehicle is moving, use the hands-free microphone so that you can always concentrate on traffic conditions.

If you turn off the vehicle's ignition during a call, the call will not be interrupted. After you terminate the call, the phone will power off in 30 seconds. No subsequent calls can be made unless the ignition is turned on. The kit will continue to charge until the phone is fully charged.

When you use hands-free mode

- It is recommended that you use one-touch dialing or speed dialing to simplify key operations. See the *QUALCOMM Globalstar GSP-1700 Phone User Manual*.
- Exercise extreme caution with traffic conditions.

Adjusting speaker volume

You can use the volume keys on the side of the phone to adjust the speaker volume. You can:

- Adjust the phone speaker volume while on a call.
- Adjust the ringer volume when the phone is not on a call.



Note

You can also use menus to adjust the volume. Refer to the phone user manual.

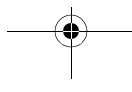
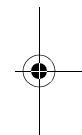
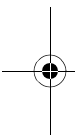

Operation**Connecting to a personal computer**

Connecting a Globalstar data cable (GDC-1700) from your computer or other device to the data port of the kit allows the phone to send and receive data. See Component parts, page 11.

**Note**

You cannot use the phone to talk while sending and receiving data.

Privacy Headset**Privacy headset operation****Setting up the headset**

Before starting to drive:

1. Remove rubber plug from the headset jack on the left side of the phone. Rotate rubber plug toward the antenna.
2. Plug the privacy headset into the headset jack on the phone.
3. Place the headset over your ear.
4. Speak in the direction of the headset microphone instead of the Hands-Free microphone. You will hear the other party through the earplug.
5. Use the volume keys or Preferences menu on your phone to adjust the volume of the earplug when you are on a call. See the phone user manual.

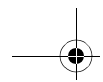

Operation

Using the headset

To make a call with the headset:

1. Dial the desired number on the keypad of your phone.
2. Press  .

When you use the headset, the speaker and microphone are muted, and you can speak in privacy.

To receive a call with the headset:

- When the phone rings, press any key except  . See the phone user manual for information on the AnyKeyAnswer option.

To end a call with the headset:

- Press  .

To switch from the headset to hands-free mode:

- Unplug the headset from the headset jack when you are not driving.

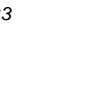
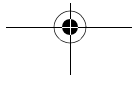
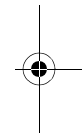
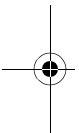

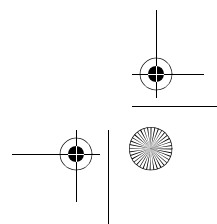
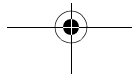
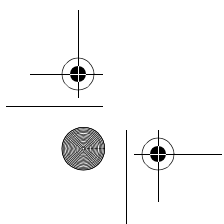
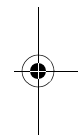
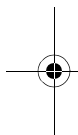
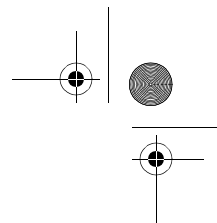
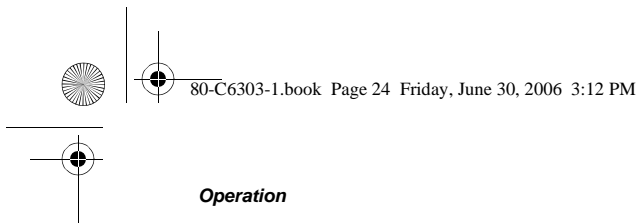

Released - Internal Use Only



Troubleshooting

If you have problems using the kit, look at these possible solutions before calling your service provider.

Table 1. Error messages

Message	Recommendation
Antenna not found	Re-check phone connection to the cradle. Re-check cable connections between the kit, antenna cable, and antenna.
MCU/Communication Error	Re-check phone connection to the cradle.
Kit connected	No troubleshooting necessary.
No message when phone is placed in kit	Re-check phone connection to cradle. Verify power is supplied to cradle, either via the power interface cable or the car power adapter.

Troubleshooting

Table 2. Other problems

Problem	Recommendation
Speaker not working	Verify speaker connection to cradle. Verify volume setting on phone is loud enough to hear speaker.
Microphone is not working	Verify microphone connection to cradle. Verify phone is not set to "mute" during a call.
After charging/ jumping vehicle battery, phone no longer works	Replace kit fuse on the red wire. Refer to the installation sheet for replacement instructions.

Released - Internal Use Only



Index

A

- adjusting headset earplug volume 22
- adjusting ringer volume 21
- adjusting speaker volume 21
- air bag safety 7
- antenna cables
 - DC voltage 14
- antenna
 - cable 9
 - exterior 13
 - patch 9
 - Quadri-filar helix 9
 - safety 4
- antenna cables
 - DC voltage 2

B

- battery
 - charging 19

C

- cables
 - antenna 13
 - power interface cable 11
- car interface cable
 - battery connection 12
 - ground 12
 - ignition sense 12

- ignition sense feature 12
- stereo mute 12

- Car Power Adapter 9
- car stereo mute 12, 20
- components 11

D

- data cable, Globalstar 15, 22
- dialing
 - one touch 21
 - speed 21
- driving safety 4

E

- electronic devices 5
- exterior antenna 13

F

- fuse 2, 26

G

- Globalstar
 - data cable 15, 22
- Globalstar Installation Kit 11
 - attaching the phone 17
 - cradle 9
 - features 1
 - optional accessories 14
 - release button 17
 - standard components 10

Index

turning off 19
turning on 18

H
hands-free mode 20
Hardware Kit 9
hearing aids 5

I
ignition sense
 auto power off 12

J
jump-starting your vehicle
 safety precautions 2

L
Literature Kit 9

M
medical devices 6
microphone 9, 11, 20
 connecting 11
 installation 11

O
operation 17
optional accessories 15

P
pacemakers 5
patch antenna 9
power interface cable 9, 11
privacy handset 15
 operation 23
privacy headset 15, 22
 adjusting earplug volume 22

Q
Quadri-filar helix antenna 9

R
radio frequency 2
recharging vehicle battery
 safety precautions 2

S
safety
 air bags 7
 aircraft 6
 antenna 4
 blasting areas 7
 driving 4
 electronic devices 5
 explosive atmospheres 7
 hearing aids 5
 hospitals 6
 medical devices 6
 pacemakers 5
 precautions 1, 2
 radio frequency 2
speaker 9, 11, 20
 connecting 11
 mounting bracket 9

T
Troubleshooting
 Error messages 25
 Other problems 26

Index-2

Released - Internal Use Only