



## About Warning



**WARNING:** A WARNING indicates a potential for property damage, personal injury, or death.

# Dell™ LOB™ Latitude™ XT2 Setup and Features Information

## Front and Right View

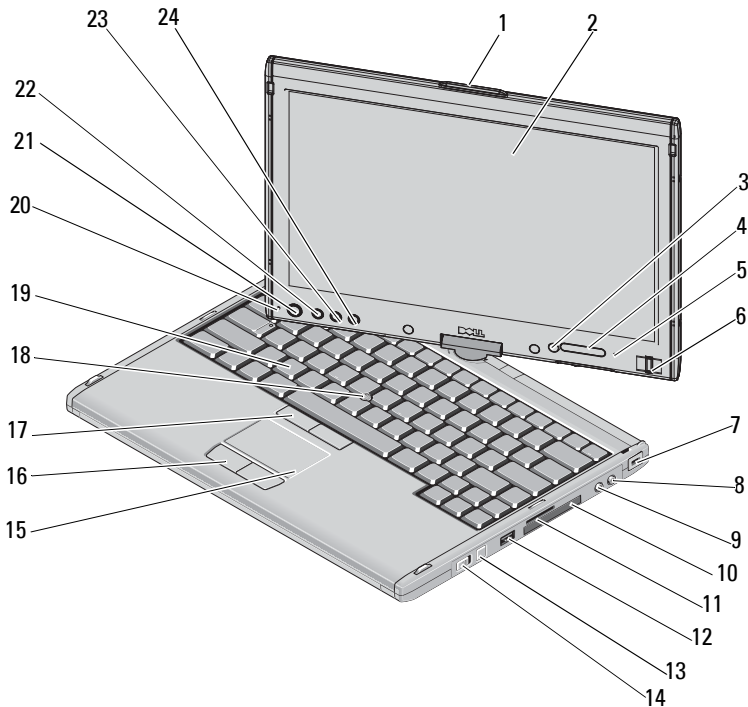

December 2008



Model PP12S



- |    |  |    |                                 |
|----|--|----|---------------------------------|
| 1  | grip   | 2  | display                         |
| 3  | ambient light sensor (with Dual-bulb CCFL LCD option only) | 4  | device status lights            |
| 5  | digital array microphone                                   | 6  | biometric reader                |
| 7  | security cable slot  | 8  | microphone connector            |
| 9  | headphones connector                                       | 10 | ExpressCard slot                |
| 11 | Secure Digital (SD) card slot                              | 12 | USB connector                   |
| 13 | Wi-Fi Catcher™ button                                      | 14 | wireless radio on/off switch    |
| 15 | touch pad  | 16 | touch pad buttons               |
| 17 | track stick buttons  | 18 | track stick                     |
| 19 | keyboard   | 20 | digital array microphone        |
| 21 | power button   | 22 | Windows® security button        |
| 23 | screen rotate button                                       | 24 | QuickSet tablet settings button |
| 25 | e-mail application shortcut button                         |    |                                 |

## Back and Left View

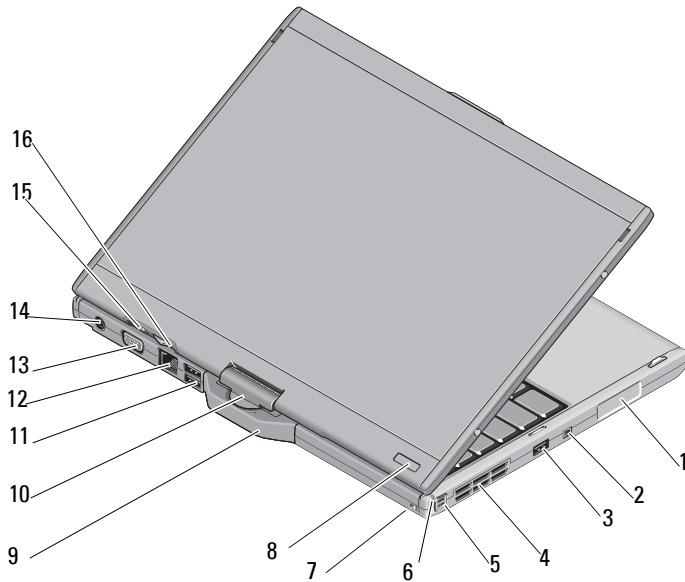



- |                          |                         |
|--------------------------|-------------------------|
| 1 speaker                | 2 IEEE 1394 connector   |
| 3 USB connector          | 4 air vent              |
| 5 pen                    | 6 pen indicator LED     |
| 7 pen tether slot        | 8 power button          |
| 9 tablet grip            | 10 rotating hinge       |
| 11 powered USB connector | 12 network connector    |
| 13 video connector       | 14 AC adapter connector |
| 15 scroll control button | 16 tablet back button   |

 **WARNING:** Do not block, push objects into, or allow dust to accumulate in the air vents. Do not store your Dell™ computer in a low-airflow environment, such as a closed briefcase, while it is running. Restricting the airflow can damage the computer or cause a fire. The computer turns on the fan when the computer gets hot. Fan noise is normal and does not indicate a problem with the fan or the computer.

## Quick Setup

 **WARNING:** Before you begin any of the procedures in this section, read the safety information that shipped with your computer. For additional best practices information see [www.dell.com/regulatory\\_compliance](http://www.dell.com/regulatory_compliance).

 **WARNING:** The AC adapter works with electrical outlets worldwide. However, power connectors and power strips vary among countries. Using an incompatible cable or improperly connecting the cable to the power strip or electrical outlet may cause fire or equipment damage.

 **CAUTION:** When you disconnect the AC adapter cable from the computer, grasp the connector, not the cable itself, and pull firmly but gently to avoid damaging the cable. When you wrap the AC adapter cable, ensure that you follow the angle of the connector on the AC adapter to avoid damaging the cable.

 **NOTE:** Some devices may not be included if you did not order them.

- 1 Connect the AC adapter to the AC adapter connector on the computer and to the electrical outlet.

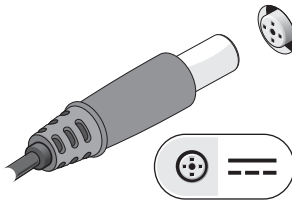

- 2 Connect the network cable.

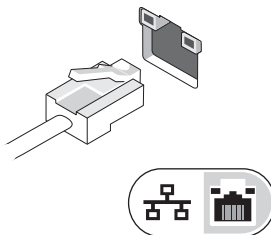

- 3 Connect USB devices, such as a mouse or keyboard.

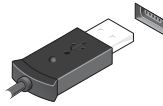

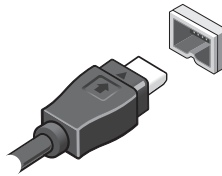

- 4** Connect IEEE 1394 devices, such as a DVD player.



- 5** Open the computer display and press the power button to turn on the computer.



-  Power button
-  Battery charge indicator.

 **NOTE:** It is recommended that you turn on and shut down your computer at least once before you install any cards or connect the computer to a docking device or other external device, such as a printer.

## Specifications

 **NOTE:** Offerings may vary by region. For more information regarding the configuration of your computer, click **Start**→**Help and Support** and select the option to view information about your computer.

---

<b>Video</b>	
Video type:	integrated on system board, hardware accelerated
Data bus	integrated video
Video controller	Intel® Integrated "Cantiga" UMA Graphics
Video memory	up to 256 MB shared video memory

---

<b>Battery</b>	
Type	4-cell "smart" lithium ion (28 WHr) 6-cell "smart" lithium ion (42 WHr)
Dimensions:	
Depth	96.84 mm (3.81 inches)
Height	13.7 mm (0.54 inch)
Weight	0.26 kg (0.57 lb) (4 cell) 0.34 kg (0.74 lb) (6 cell)
Voltage	11.1 VDC
Temperature range:	
Operating	0° to 35°C (32° to 95°F)
Storage	-40° to 65°C (-40° to 149°F)
Coin-cell battery	CR-2032

---

<b>AC Adapter</b>	
Input voltage	90–264 VAC
Input current (maximum)	1.1 A
Input frequency	47–63 Hz

---

**AC Adapter (continued)**

---

Output current	3.3 A (maximum at 4-second pulse); 2.3 A (continuous)
Output power	45 W, 65W (optional) or 90W (optional)
Rated output voltage	19.5 VDC
Dimensions:	
Height	16.0 mm (0.63 inches)
Width	63.0mm (2.48 inches)
Depth	88.0 mm (3.46 inches)
Temperature range:	
Operating	0° to 40°C (32° to 104°F)
Storage	-10° to 70°C (-50° to 158°F)

---

**Physical**

---

Height	25.4 mm (1.0 inch)
Width	297.0 mm (11.7 inches)
Depth	218.6 mm (8.6 inches)
Weight	1.62 kg (3.57 lb) (with 4-cell battery/LED standard configuration) 1.93 kg (4.25 lb) (with 6-cell battery/DLV standard configuration)

---

**Environmental**

---

Temperature range:	
Operating	0° to 35°C (32° to 95°F)
Storage	-40° to 65°C (-40° to 149°F)
Relative humidity (maximum):	
Operating	10% to 90% (noncondensing)
Storage	5% to 95% (noncondensing)
Altitude (maximum):	
Operating	-15.2 to 3048 m (-50 to 10,000 ft)
Storage	-15.2 to 10,668 m (-50 to 35,000 ft)

## Finding More Information and Resources

<b>If you need to:</b>	<b>See:</b>
find safety best practices information for your computer review Warranty information, Terms and Conditions(U.S only), Safety instructions, Regulatory information, Ergonomics information, and End User License Agreement.	the safety and regulatory documents that shipped with your computer and also see the Regulatory Compliance Homepage at <b><a href="http://www.dell.com/regulatory_compliance">www.dell.com/regulatory_compliance</a></b> .

---

**Information in this document is subject to change without notice.**

**© 2008 Dell Inc. All rights reserved. Printed in the U.S.A.**

Reproduction of these materials in any manner whatsoever without the written permission of Dell Inc. is strictly forbidden.

Trademarks used in this text: *Dell*, *Latitude*, *Dell*, *Wi-Fi Catcher*, and the *DELL* logo are trademarks of Dell Inc.; *Intel* is a registered trademark of Intel Corporation in the U.S. and other countries.

Other trademarks and trade names may be used in this document to refer to either the entities claiming the marks and names or their products. Dell Inc. disclaims any proprietary interest in trademarks and trade names other than its own.