

# TEST REPORT

## CERTIFICATE OF CONFORMITY

**Standard:** 47 CFR FCC Part 15, Subpart C (Section 15.247)

**Report No.:** RFBBEK-WTW-P21010196M

**FCC ID:** J9C-QCNFA765

**Product:** Wi-Fi 6E BT 5.2 M.2 2230 Module

**Brand:** Qualcomm

**Model No.:** QCNFA765

**Received Date:** 2023/10/26

**Test Date:** 2024/2/2 ~ 2024/2/22

**Issued Date:** 2024/3/12

**Applicant:** Qualcomm Technologies, Inc.

**Address:** 5775 Morehouse Drive, San Diego, CA 92121-1714

**Issued By:** Bureau Veritas Consumer Products Services (H.K.) Ltd., Taoyuan Branch  
Hsin Chu Laboratory

**Lab Address:** E-2, No.1, Li Hsin 1st Road, Hsinchu Science Park, Hsinchu City 300, Taiwan

**Test Location:** E-2, No.1, Li Hsin 1st Road, Hsinchu Science Park, Hsinchu City 300, Taiwan

**FCC Registration /** 723255 / TW2022

**Designation Number:**

**Approved by:**  \_\_\_\_\_, **Date:** 2024/3/12  
May Chen / Manager

This test report consists of 53 pages in total. It may be duplicated completely for legal use with the approval of the applicant. It should not be reproduced except in full, without the written approval of our laboratory. The test results in the report only apply to the tested sample. The test results in this report are traceable to the national or international standards.



Prepared by : Vito Lung / Specialist

This report is governed by, and incorporates by reference, the Conditions of Testing as posted at the date of issuance of this report at <http://www.bureauveritas.com/home/about-us/our-business/cps/about-us/terms-conditions/> and is intended for your exclusive use. Any copying or replication of this report to or for any other person or entity, or use of our name or trademark, is permitted only with our prior written permission. This report sets forth our findings solely with respect to the test samples identified herein. The results set forth in this report are not indicative or representative of the quality or characteristics of the lot from which a test sample was taken or any similar or identical product unless specifically and expressly noted. Our report includes all of the tests requested by you and the results thereof based upon the information that you provided to us. Measurement uncertainty is only provided upon request for accredited tests. Statements of conformity are based on simple acceptance criteria without taking measurement uncertainty into account, unless otherwise requested in writing. You have 60 days from date of issuance of this report to notify us of any material error or omission caused by our negligence or if you require measurement uncertainty; provided, however, that such notice shall be in writing and shall specifically address the issue you wish to raise. A failure to raise such issue within the prescribed time shall constitute your unqualified acceptance of the completeness of this report, the tests conducted and the correctness of the report contents.

## Table of Contents

<b>Release Control Record .....</b>	<b>4</b>
<b>1 Certificate.....</b>	<b>5</b>
<b>2 Summary of Test Results .....</b>	<b>6</b>
2.1 Measurement Uncertainty .....	6
2.2 Supplementary Information .....	6
<b>3 General Information .....</b>	<b>7</b>
3.1 General Description .....	7
3.2 Antenna Description of EUT .....	8
3.3 Channel List.....	9
3.4 Test Mode Applicability and Tested Channel Detail.....	10
3.5 Duty Cycle of Test Signal.....	11
3.6 Test Program Used and Operation Descriptions .....	12
3.7 Connection Diagram of EUT and Peripheral Devices .....	12
3.8 Configuration of Peripheral Devices and Cable Connections .....	13
<b>4 Test Instruments .....</b>	<b>14</b>
4.1 RF Output Power .....	14
4.2 Number of Hopping Frequency Used .....	14
4.3 Dwell Time on Each Channel .....	14
4.4 Hopping Channel Separation .....	14
4.5 20 dB Bandwidth .....	14
4.6 Conducted Out of Band Emissions .....	14
4.7 AC Power Conducted Emissions .....	15
4.8 Unwanted Emissions below 1 GHz .....	16
4.9 Unwanted Emissions above 1 GHz.....	17
<b>5 Limits of Test Items.....</b>	<b>18</b>
5.1 RF Output Power .....	18
5.2 Number of Hopping Frequency Used .....	18
5.3 Dwell Time on Each Channel .....	18
5.4 Hopping Channel Separation .....	18
5.5 20 dB Bandwidth .....	18
5.6 Conducted Out of Band Emissions .....	18
5.7 AC Power Conducted Emissions .....	18
5.8 Unwanted Emissions below 1 GHz .....	19
5.9 Unwanted Emissions above 1 GHz.....	19
<b>6 Test Arrangements.....</b>	<b>20</b>
6.1 RF Output Power .....	20
6.1.1 Test Setup .....	20
6.1.2 Test Procedure .....	20
6.2 Number of Hopping Frequency Used .....	20
6.2.1 Test Setup .....	20
6.2.2 Test Procedure .....	20
6.3 Dwell Time on Each Channel .....	21
6.3.1 Test Setup .....	21
6.3.2 Test Procedure .....	21
6.4 Hopping Channel Separation .....	21
6.4.1 Test Setup .....	21
6.4.2 Test Procedure .....	21
6.5 20 dB Bandwidth .....	22
6.5.1 Test Setup .....	22
6.5.2 Test Procedure .....	22
6.6 Conducted Out of Band Emissions .....	22
6.6.1 Test Setup .....	22
6.6.2 Test Procedure .....	22
6.7 AC Power Conducted Emissions .....	23



6.7.1	Test Setup .....	23
6.7.2	Test Procedure .....	23
6.8	Unwanted Emissions below 1 GHz .....	24
6.8.1	Test Setup .....	24
6.8.2	Test Procedure .....	25
6.9	Unwanted Emissions above 1 GHz .....	27
6.9.1	Test Setup .....	27
6.9.2	Test Procedure .....	27
<b>7</b>	<b>Test Results of Test Item .....</b>	<b>29</b>
7.1	RF Output Power .....	29
7.2	Number of Hopping Frequency Used .....	30
7.3	Dwell Time on Each Channel .....	31
7.4	Hopping Channel Separation .....	32
7.5	20 dB Bandwidth .....	33
7.6	Conducted Out of Band Emissions .....	34
7.7	AC Power Conducted Emissions .....	35
7.8	Unwanted Emissions below 1 GHz .....	37
7.9	Unwanted Emissions above 1 GHz .....	40
<b>8</b>	<b>Pictures of Test Arrangements .....</b>	<b>52</b>
<b>9</b>	<b>Information of the Testing Laboratories .....</b>	<b>53</b>



## Release Control Record

Issue No.	Description	Date Issued
RFBBEK-WTW-P21010196M	Original release.	2024/3/12

## 1 Certificate

**Product:** Wi-Fi 6E BT 5.2 M.2 2230 Module

**Brand:** Qualcomm

**Test Model:** QCNFA765

**Sample Status:** Engineering sample

**Applicant:** Qualcomm Technologies, Inc.

**Test Date:** 2024/2/2 ~ 2024/2/22

**Standard:** 47 CFR FCC Part 15, Subpart C (Section 15.247)

**Measurement** ANSI C63.10-2013

**procedure:** KDB 558074 D01 15.247 Meas Guidance v05r02

The above equipment has been tested by **Bureau Veritas Consumer Products Services (H.K.) Ltd., Taoyuan Branch**, and found compliance with the requirement of the above standards. The test record, data evaluation & Equipment Under Test (EUT) configurations represented herein are true and accurate accounts of the measurements of the sample's RF characteristics under the conditions specified in this report.

## 2 Summary of Test Results

47 CFR FCC Part 15, Subpart C (Section 15.247)			
Standard / Clause	Test Item	Result	Remark
15.247 (a)(1)	RF Output Power	Pass	Meet the requirement of limit.
15.247(a)(1) (iii)	Number of Hopping Frequency Used	Pass	Meet the requirement of limit.
15.247(a)(1) (iii)	Dwell Time on Each Channel	Pass	Meet the requirement of limit.
15.247(a)(1)	Hopping Channel Separation	Pass	Meet the requirement of limit.
15.247(a)(1)	20 dB Bandwidth	-	Refer to Note 1
15.247(d)	Conducted Out of Band Emissions	Pass	Meet the requirement of limit.
15.207	AC Power Conducted Emissions	Pass	Minimum passing margin is -9.26 dB at 0.59141 MHz
15.205 / 15.209 / 15.247(d)	Unwanted Emissions below 1 GHz	Pass	Minimum passing margin is -3.5 dB at 302.97 MHz
15.205 / 15.209 / 15.247(d)	Unwanted Emissions above 1 GHz	Pass	Minimum passing margin is -4.81 dB at 7314.54 MHz
15.203	Antenna Requirement	Pass	Antenna connector is i-pex(MHF 4L) not a standard connector.

### Notes:

1. If the Frequency Hopping System operating in 2400-2483.5 MHz band and the output power less than 125 mW. The hopping channel carrier frequencies separated by a minimum of 25 kHz or two-thirds of the 20 dB bandwidth of hopping channel whichever is greater.
2. Determining compliance based on the results of the compliance measurement, not taking into account measurement instrumentation uncertainty.

### 2.1 Measurement Uncertainty

Where relevant, the following measurement uncertainty levels have been estimated for tests performed on the EUT as specified in CISPR 16-4-2:

Parameter	Specification	Uncertainty (±)
RF Output Power	-	1.1 dB
Number of Hopping Frequency Used	-	1050.00 Hz
Dwell Time on Each Channel	-	2.2 ms
Hopping Channel Separation	-	1050.00 Hz
20 dB Bandwidth	-	1050.00 Hz
Conducted Out of Band Emissions	9 kHz ~ 40 GHz	2.6 dB
AC Power Conducted Emissions	150 kHz ~ 30 MHz	1.9 dB
Unwanted Emissions below 1 GHz	9 kHz ~ 30 MHz	3.1 dB
	30 MHz ~ 1 GHz	5.5 dB
Unwanted Emissions above 1 GHz	1 GHz ~ 18 GHz	5.1 dB
	18 GHz ~ 40 GHz	5.3 dB

The other instruments specified are routine verified to remain within the calibrated levels, no measurement uncertainty is required to be calculated.

### 2.2 Supplementary Information

There is not any deviation from the test standards for the test method, and no modifications required for compliance.

### 3 General Information

#### 3.1 General Description

Product	Wi-Fi 6E BT 5.2 M.2 2230 Module
Brand	Qualcomm
Test Model	QCNFA765
Status of EUT	Engineering sample
Power Supply Rating	3.3 Vdc from host equipment
Modulation Type	$\pi/4$ QPSK (HSL2, HSL3) $\pi/4$ DQPSK (HSL4) 8PSK (HSL5) D8PSK (HSL6)
Modulation Technology	FHSS
Transfer Rate	Up to 6 Mbps
Operating Frequency	2.404 GHz ~ 2.478 GHz
Number of Channel	Mode A: 37 Mode B: 38
Output Power	19.815 mW (12.97 dBm)

#### Note:

- This report is prepared for FCC class II permissive change. The difference compared with the original design is as the following:
  - ◆ Add QHS function (Qualcomm Bluetooth High Speed Link) by software.
- According to above conditions, all test items need to be performed. And all data are verified to meet the requirement.
- This device of WLAN (2.4GHz & 5GHz U-NII-1 Band) can support hotspot mode.
- The device of WLAN (2.4GHz) and Bluetooth technology can't transmit simultaneously, it was used timely shared coexistence technology.
- In original report, the product provides option to depopulate external LNA (Low-Noise amplifier) from 5GHz receive path. This test report covers variation of with/without external LNA and test was conducted to confirm not change in RF compliance and EMC. And worst case was found in without external LNA.
- Simultaneously transmission condition.

Condition	Technology	
1	WLAN(2.4GHz)	WLAN(6GHz)
2	WLAN(2.4GHz)	WLAN(5GHz)
3	WLAN(2.4GHz)	WLAN(5.9GHz)
4	WLAN(6GHz)	Bluetooth
5	WLAN(5GHz)	Bluetooth
6	WLAN(5.9GHz)	Bluetooth

Note: The emission of the simultaneous operation has been evaluated and no non-compliance was found.

- QCNFA725 covers two hardware variant SKUs that RF design is exactly the same between three SKUs except digital interface circuits change:

SKU (NFA765)		
SKU No.	Description	Support platform system and feature
SKU #1	M.2 2230 E-key	Support X86 system
SKU #2	M.2 2230 AE-key	
SKU (NFA765A)		
SKU #3	M.2 2230 E-key	Support WoS system

Note: From the above models, model: **NFA765** was selected as representative model for the test and its data was recorded in this report.

8. This module supports two modes, as shown in the table below. Since the power setting parameters and RF characteristics are the same, the test mainly uses mode A as the main representative mode. For additional details please refer to the document - "Theory of Operation" exhibit.

Mode	The Number of Channels
A	37
B	38

9. The above EUT information is declared by manufacturer and for more detailed features description, please refer to the manufacturer's specifications or User's Manual.

### 3.2 Antenna Description of EUT

1. The antenna information is listed as below.

Antenna Set	RF Chain No.	Brand	Model	Antenna Net Gain (dBi)	Frequency Range (GHz)	Cable Loss (dB)	Antenna Type	Connector Type	Cable Length (mm)
1	Chain0/1	HONGBO	260-25094	3.53	2.4~2.4835	0.76	PIFA	i-pex(MHF 4L)	300
				3.06	5.15~5.25	1.16			
				3.07	5.25~5.35	1.18			
				4.81	5.47~5.725	1.2			
				4.2	5.725~5.850	1.27			
2	Chain0/1	HONGBO	260-25083	5.09	5.850~5.895	1.29	PIFA	i-pex(MHF 4L)	300
				5.14	5.925~6.425	1.32			
				5.09	6.425~6.525	1.35			
				5.16	6.525~6.875	1.4			
				5.12	6.875~7.125	1.45			
3	Chain0/1	HONGBO	260-25084	3.22	2.4~2.4835	0.5	Monopole	i-pex(MHF 4L)	200
				3.35	5.150~5.250	0.76			
				3.42	5.250~5.350	0.78			
				4.77	5.470~5.725	0.81			
				4.72	5.725~5.850	0.85			
				4.71	5.850~5.895	0.86			
				4.75	5.925~6.425	0.87			
				4.29	6.425~6.525	0.91			
				4.81	6.525~6.875	0.96			
				4.74	6.875~7.125	0.98			

\* Detail antenna specification please refer to antenna datasheet and/or antenna measurement report.



### 3.3 Channel List

QHS channels:

Channel	Frequency (MHz)	Channel	Frequency (MHz)	Channel	Frequency (MHz)	Channel	Frequency (MHz)
1	2404	11	2424	21	2444	31	2464
2	2406	12*	2426	22	2446	32	2466
3	2408	13	2428	23	2448	33	2468
4	2410	14	2430	24	2450	34	2470
5	2412	15	2432	25	2452	35	2472
6	2414	16	2434	26	2454	36	2474
7	2416	17	2436	27	2456	37	2476
8	2418	18	2438	28	2458	38	2478
9	2420	19	2440	29	2460		
10	2422	20	2442	30	2462		

Note. \*Only mode B supported.

### 3.4 Test Mode Applicability and Tested Channel Detail

Pre-Scan:	1. Pre-Scan has been conducted to determine the worst-case mode from all possible combinations between available modulations, data rates and antenna ports (if EUT with antenna diversity architecture).
-----------	--

Following channel(s) was (were) selected for the final test as listed below:

Test Item	EUT Configure Mode	Mode	Tested Channel	Modulation	Data Rate Parameter
RF Output Power	A	QHS	1, 18, 38	D8PSK	6Mbps
Number of Hopping Frequency Used	A	QHS	Hopping	D8PSK	6Mbps
Dwell Time on Each Channel	A	QHS	Hopping	D8PSK	6Mbps
Hopping Channel Separation	A	QHS	1, 18, 38	D8PSK	6Mbps
20 dB Bandwidth	A	QHS	1, 18, 38	D8PSK	6Mbps
Conducted Out of Band Emissions	A	QHS	Hopping 1, 38	D8PSK	6Mbps
AC Power Conducted Emissions	C	QHS	38	D8PSK	6Mbps
Unwanted Emissions below 1 GHz	A, B	QHS	38	D8PSK	6Mbps
Unwanted Emissions above 1 GHz	A, B	QHS	1, 18, 38	D8PSK	6Mbps
EUT Configure Mode:	A	EUT only (remove 50 ohm terminator and Connect to the appropriate equipment)			
	B	EUT with 50 ohm terminator			
	C	EUT with antenna			

### 3.5 Duty Cycle of Test Signal

**QHS 6M:** Duty cycle =  $4.316 \text{ ms} / 5.627 \text{ ms} \times 100\% = 76.7\%$ , duty factor =  $10 * \log (1/\text{Duty cycle}) = 1.15 \text{ dB}$

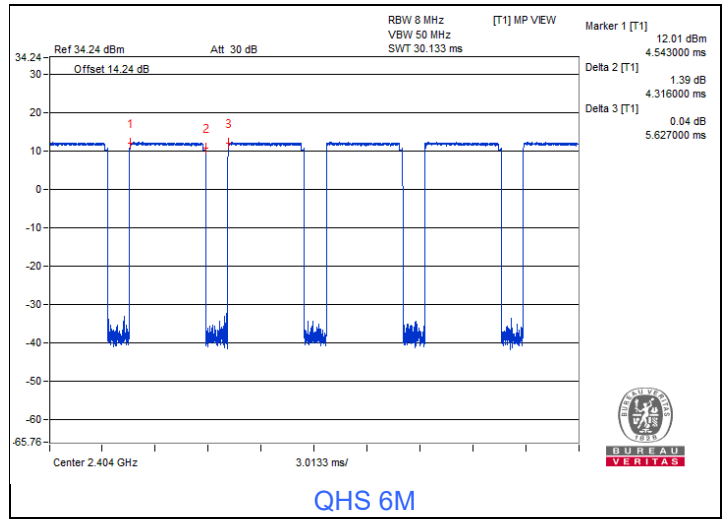

### 3.6 Test Program Used and Operation Descriptions

Controlling software (QRCT 4.0.00177.0) has been activated to set the EUT under transmission condition continuously at specific channel frequency.

### 3.7 Connection Diagram of EUT and Peripheral Devices

For AC Power Conducted Emission test

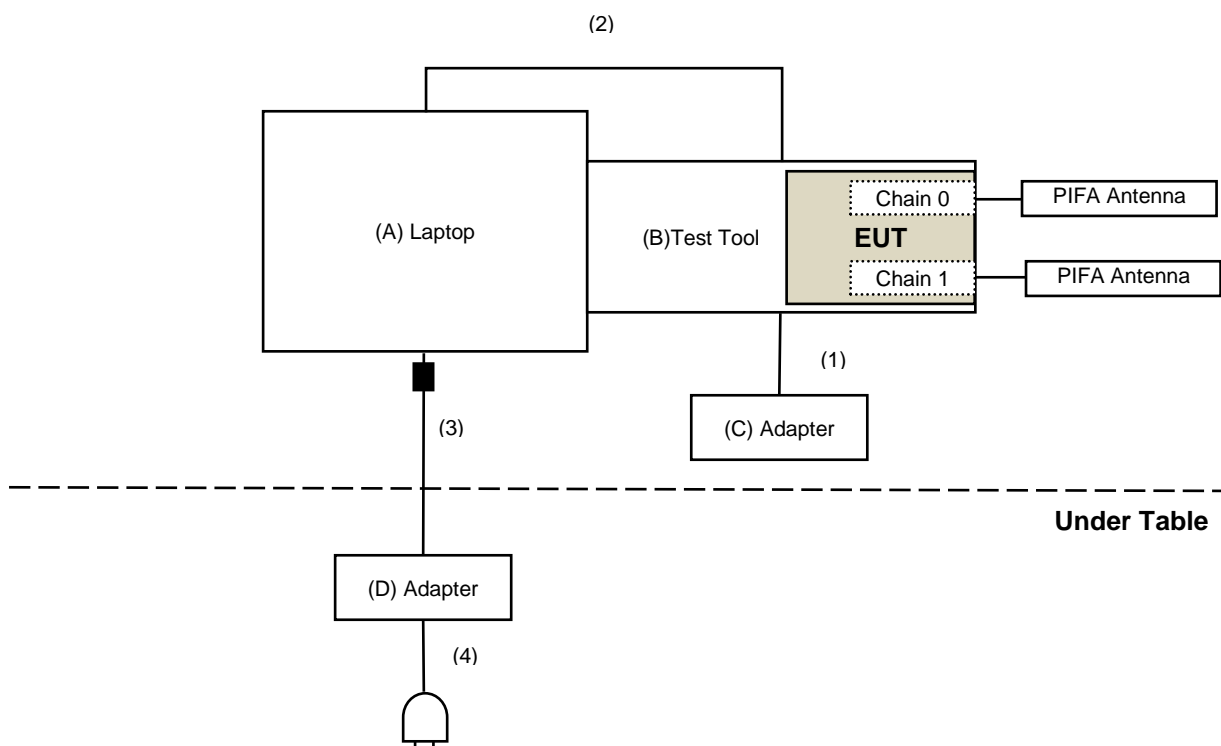

## For Unwanted Emission test

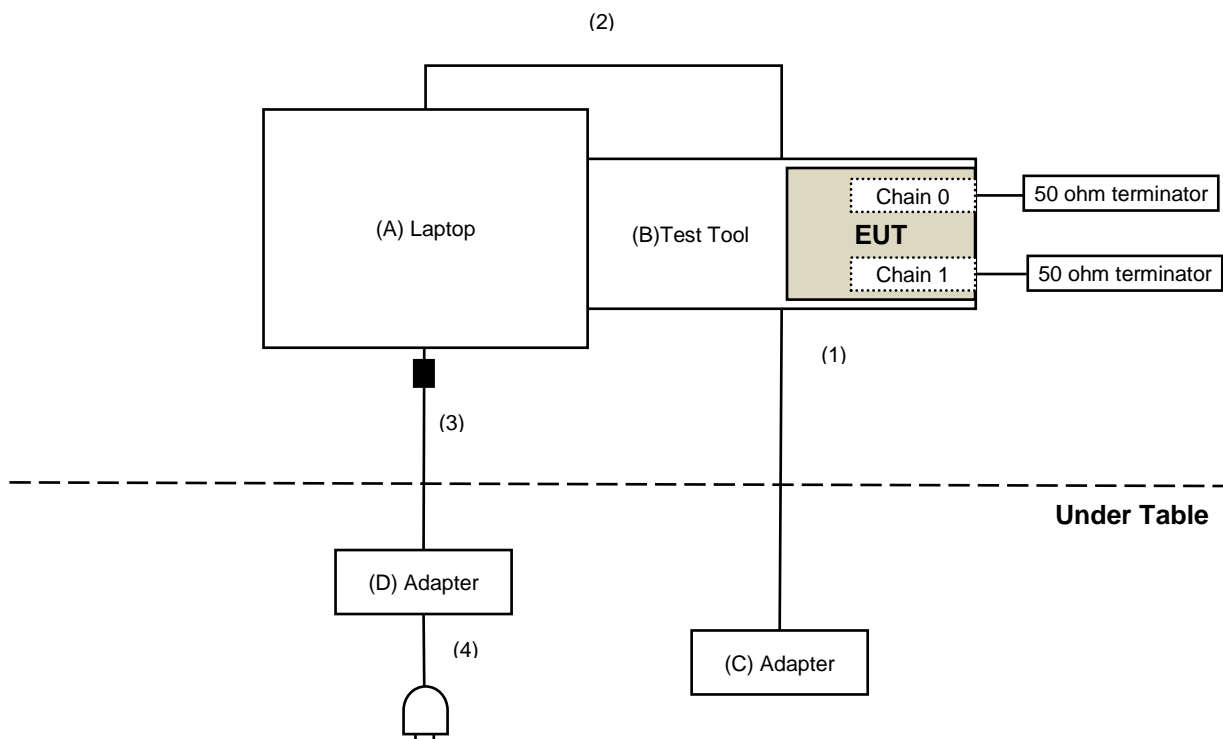

### 3.8 Configuration of Peripheral Devices and Cable Connections

ID	Product	Brand	Model No.	Serial No.	FCC ID	Remarks
A	Laptop	Dell	E5420	6FGHKV1	N/A	Provided by Lab
B	Test Tool	Qualcomm	N/A	N/A	N/A	Supplied by applicant
C	Adapter	PHIHONG	PSAA12A-120L6	N/A	N/A	Supplied by applicant
D	Adapter	Dell	LLA65NS2-01	N/A	N/A	Provided by Lab

ID	Cable Descriptions	Qty.	Length (m)	Shielding (Yes/No)	Cores (Qty.)	Remarks
1	DC Cable	1	1.2	No	0	Supplied by applicant
2	USB Cable	1	0.6	Yes	0	Provided by Lab
3	DC Cable	1	1.8	No	1	Provided by Lab
4	AC Cable	1	1.5	No	0	Provided by Lab

## 4 Test Instruments

The calibration interval of the all test instruments are 12 months and the calibrations are traceable to NML/ROC and NIST/USA.

### 4.1 RF Output Power

Description Manufacturer	Model No.	Serial No.	Calibrated Date	Calibrated Until
Power Meter Anritsu	ML2495A	1529002	2023/6/17	2024/6/16
Pulse Power Sensor Anritsu	MA2411B	1726434	2023/6/19	2024/6/18

Notes:

1. The test was performed in Oven room 2.
2. Tested Date: 2024/2/22

### 4.2 Number of Hopping Frequency Used

Description Manufacturer	Model No.	Serial No.	Calibrated Date	Calibrated Until
MXA Signal Analyzer Keysight	N9020B	MY60112409	2024/2/20	2025/2/19
Software	ADT_RF Test Software V7.6.5.4	N/A	N/A	N/A

Notes:

1. The test was performed in Oven room 2.
2. Tested Date: 2024/2/22

### 4.3 Dwell Time on Each Channel

Refer to section 4.2 to get information of the instruments.

### 4.4 Hopping Channel Separation

Refer to section 4.2 to get information of the instruments.

### 4.5 20 dB Bandwidth

Refer to section 4.2 to get information of the instruments.

### 4.6 Conducted Out of Band Emissions

Refer to section 4.2 to get information of the instruments.

#### 4.7 AC Power Conducted Emissions

Description Manufacturer	Model No.	Serial No.	Calibrated Date	Calibrated Until
50 ohm terminal resistance Telegartner	50 ohm	3	2023/10/20	2024/10/19
EMI Test Receiver R&S	ESCS 30	847124/029	2023/10/18	2024/10/17
Fixed Attenuator STI	STI02-2200-10	005	2023/7/1	2024/6/30
LISN R&S	ESH3-Z5	835239/001	2023/4/6	2024/4/5
		848773/004	2023/10/13	2024/10/12
RF Coaxial Cable JYEBAO	5D-FB	COCCAB-001	2023/7/1	2024/6/30
Software BVADT	BVADT_Cond_V7.3.7.4	N/A	N/A	N/A

Notes:

1. The test was performed in Conduction 1
2. Tested Date: 2024/2/2

#### 4.8 Unwanted Emissions below 1 GHz

##### Mode A

Description Manufacturer	Model No.	Serial No.	Calibrated Date	Calibrated Until
MXA Signal Analyzer Keysight	N9020B	MY60112409	2024/2/20	2025/2/19
Software	ADT_RF Test Software V7.6.5.4	N/A	N/A	N/A

##### Notes:

1. The test was performed in Oven room 2.
2. Tested Date: 2024/2/21

##### Mode B

Description Manufacturer	Model No.	Serial No.	Calibrated Date	Calibrated Until
Bi_Log Antenna Schwarzbeck	VULB 9168	9168-406	2023/10/13	2024/10/12
Boresight Antenna Tower & Turn Table Max-Full	MF-7802BS	MF780208530	N/A	N/A
Fixed Attenuator Mini-Circuits	UNAT-5+	PAD-ATT5-03	2023/12/12	2024/12/11
Loop Antenna EMCI	LPA600	270	2023/9/4	2024/9/3
MXA Signal Analyzer Keysight	N9020B	MY60112408	2023/3/6	2024/3/5
MXE EMI Receiver Keysight	N9038A	MY59050100	2023/6/13	2024/6/12
Preamplifier EMCI	EMC330N	980701	2023/2/18	2024/2/17
	EMC001340	980142	2023/5/8	2024/5/7
RF Coaxial Cable JYBAO	5D-FB	LOOPCAB-001	2023/12/12	2024/12/11
		LOOPCAB-002	2023/12/12	2024/12/11
RF Coaxial Cable mTJ	100100-CFD400LW-200	CFD400-200	2023/3/27	2024/3/26
	100100-CFD400LW-400	CFD400-400	2023/3/27	2024/3/26
	100100-CFD400LW-800	CFD400-800	2023/3/27	2024/3/26
Software	ADT_Radiated_V8.7.08	N/A	N/A	N/A

##### Notes:

1. The test was performed in 966 Chamber No. 4.
2. Tested Date: 2024/2/2



#### 4.9 Unwanted Emissions above 1 GHz

##### Mode A

Refer to section 4.8 Mode A to get information of the instruments.

##### Mode B

Description Manufacturer	Model No.	Serial No.	Calibrated Date	Calibrated Until
Boresight Antenna Tower & Turn Table Max-Full	MF-7802BS	MF780208530	N/A	N/A
Horn Antenna Schwarzbeck	BBHA 9120D	9120D-783	2023/11/12	2024/11/11
	BBHA 9170	9170-739	2023/11/12	2024/11/11
MXA Signal Analyzer Keysight	N9020B	MY60112408	2023/3/6	2024/3/5
Preamplifier EMCI	EMC12630SE	980688	2023/10/3	2024/10/2
	EMC184045SE	980387	2023/8/9	2024/8/8
RF Coaxial Cable EMCI	EMC102-KM-KM-1200	160924	2024/1/29	2025/1/28
	EMC102-KM-KM-4000	200214	2024/1/29	2025/1/28
	EMC104-SM-SM-1200	160922	2024/1/29	2025/1/28
	EMC104-SM-SM-2000	180502	2024/1/29	2025/1/28
	EMC104-SM-SM-6000	210704	2023/11/2	2024/11/1
Software	ADT_Radiated_V8.7.08	N/A	N/A	N/A

##### Notes:

1. The test was performed in 966 Chamber No. 4.
2. Tested Date: 2024/2/2

## 5 Limits of Test Items

### 5.1 RF Output Power

The Maximum Output Power Measurement is 125 mW (21 dBm).

### 5.2 Number of Hopping Frequency Used

At least 15 channels frequencies, and should be equally spaced.

### 5.3 Dwell Time on Each Channel

The average time of occupancy on any channel shall not be greater than 0.4 seconds within a period of 0.4 seconds multiplied by the number of hopping channels employed.

### 5.4 Hopping Channel Separation

At least 25 kHz or two-third of 20 dB hopping channel bandwidth (whichever is greater).

### 5.5 20 dB Bandwidth

Maximum bandwidth is not specified.

### 5.6 Conducted Out of Band Emissions

Below 20 dB of the highest emission level of operating band (in 100 kHz Resolution Bandwidth).

### 5.7 AC Power Conducted Emissions

Frequency (MHz)	Conducted Limit (dBuV)	
	Quasi-peak	Average
0.15 - 0.5	66 - 56	56 - 46
0.50 - 5.0	56	46
5.0 - 30.0	60	50

Notes:

1. The lower limit shall apply at the transition frequencies.
2. The limit decreases in line with the logarithm of the frequency in the range of 0.15 to 0.50 MHz.

## 5.8 Unwanted Emissions below 1 GHz

Radiated emissions up to 1 GHz which fall in the restricted bands must comply with the radiated emission limits specified as below table. Other emissions shall be at least 20 dB below the highest level of the desired power:

Frequencies (MHz)	Field Strength (microvolts/meter)	Measurement Distance (meters)
0.009 ~ 0.490	2400/F(kHz)	300
0.490 ~ 1.705	24000/F(kHz)	30
1.705 ~ 30.0	30	30
30 ~ 88	100	3
88 ~ 216	150	3
216 ~ 960	200	3
Above 960	500	3

Notes:

1. The lower limit shall apply at the transition frequencies.
2. Emission level (dBuV/m) = 20 log Emission level (uV/m).

## 5.9 Unwanted Emissions above 1 GHz

Radiated emissions above 1 GHz which fall in the restricted bands must comply with the radiated emission limits specified as below table. Other emissions shall be at least 20 dB below the highest level of the desired power:

Frequencies (MHz)	Field Strength (microvolts/meter)	Measurement Distance (meters)
Above 960	500	3

Notes:

1. The lower limit shall apply at the transition frequencies.
2. Emission level (dBuV/m) = 20 log Emission level (uV/m).
3. For frequencies above 1000 MHz, the field strength limits are based on average detector, however, the peak field strength of any emission shall not exceed the maximum permitted average limits, specified above by more than 20 dB under any condition of modulation.

## 6 Test Arrangements

### 6.1 RF Output Power

#### 6.1.1 Test Setup

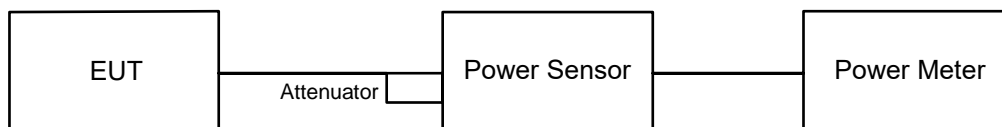

#### 6.1.2 Test Procedure

##### Peak Power:

A peak power sensor was used on the output port of the EUT. A power meter was used to read the response of the peak power sensor. Record the power level.

##### Average Power:

Average power sensor was used to perform output power measurement, trigger and gating function of wide band power meter is enabled to measure max output power of TX on burst. Duty factor is not added to measured value.

### 6.2 Number of Hopping Frequency Used

#### 6.2.1 Test Setup

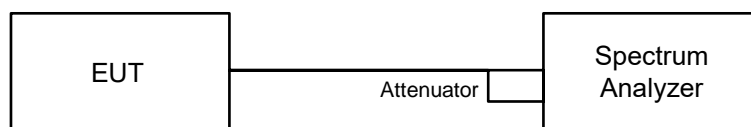

#### 6.2.2 Test Procedure

- Check the calibration of the measuring instrument (SA) using either an internal calibrator or a known signal from an external generator.
- Turn on the EUT and connect its antenna terminal to measurement via a low loss cable. Then set it to any one measured frequency within its operating range and make sure the instrument is operated in its linear range.
- Set the SA on MaxHold Mode, and then keep the EUT in hopping mode. Record all the signals from each channel until each one has been recorded.
- Set the SA on View mode and then plot the result on SA screen.
- Repeat above procedures until all frequencies measured were complete.

### 6.3 Dwell Time on Each Channel

#### 6.3.1 Test Setup

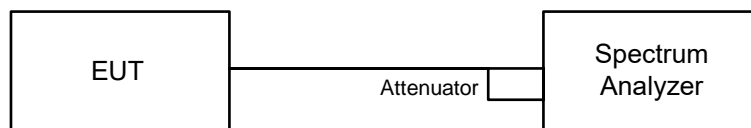

#### 6.3.2 Test Procedure

- Check the calibration of the measuring instrument (SA) using either an internal calibrator or a known signal from an external generator.
- Turn on the EUT and connect its antenna terminal to measurement via a low loss cable. Then set it to any one measured frequency within its operating range and make sure the instrument is operated in its linear range.
- Adjust the center frequency of SA on any frequency be measured and set SA to zero span mode. And then, set RBW and VBW of spectrum analyzer to proper value.
- Measure the time duration of one transmission on the measured frequency. And then plot the result with time difference of this time duration.
- Repeat above procedures until all different time-slot modes have been completed.

### 6.4 Hopping Channel Separation

#### 6.4.1 Test Setup

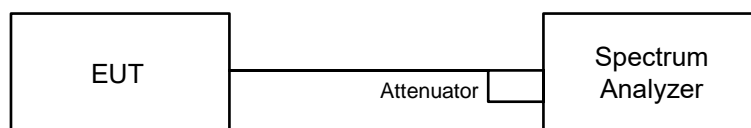

#### 6.4.2 Test Procedure

- Check the calibration of the measuring instrument using either an internal calibrator or a known signal from an external generator.
- Turn on the EUT and connect it to measurement instrument. Then set it to any one convenient frequency within its operating range.
- By using the MaxHold function record the separation of two adjacent channels.
- Measure the frequency difference of these two adjacent channels by SA MARK function. And then plot the result on SA screen.
- Repeat above procedures until all frequencies measured were complete.

## 6.5 20 dB Bandwidth

### 6.5.1 Test Setup

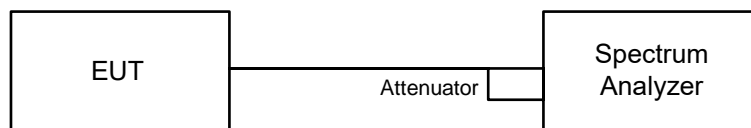

### 6.5.2 Test Procedure

- Check the calibration of the measuring instrument using either an internal calibrator or a known signal from an external generator.
- Turn on the EUT and connect it to measurement instrument. Then set it to any one convenient frequency within its operating range. Set a reference level on the measuring instrument equal to the highest peak value.
- Measure the frequency difference of two frequencies that were attenuated 20 dB from the reference level. Record the frequency difference as the emission bandwidth.
- Repeat above procedures until all frequencies measured were complete.

## 6.6 Conducted Out of Band Emissions

### 6.6.1 Test Setup

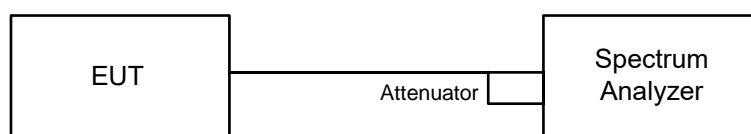

### 6.6.2 Test Procedure

#### MEASUREMENT PROCEDURE REF

- Set the RBW = 100 kHz.
- Set the VBW  $\geq$  300 kHz.
- Detector = peak.
- Sweep time = auto couple.
- Trace mode = max hold.
- Allow trace to fully stabilize.
- Use the peak marker function to determine the maximum power level in any 100 kHz band segment within the fundamental EBW.

#### MEASUREMENT PROCEDURE OOB

- Set RBW = 100 kHz.
- Set VBW  $\geq$  300 kHz.
- Detector = peak.
- Sweep = auto couple.
- Trace Mode = max hold.
- Allow trace to fully stabilize.
- Use the peak marker function to determine the maximum amplitude level.

## 6.7 AC Power Conducted Emissions

### 6.7.1 Test Setup

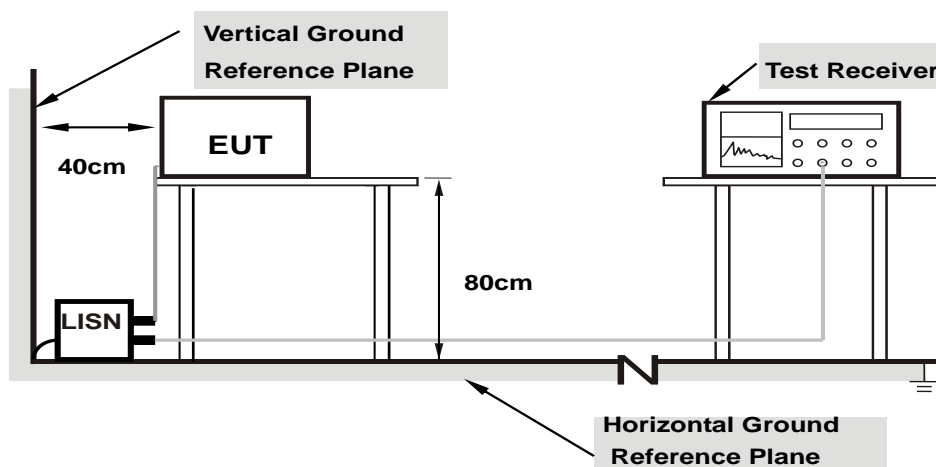

**Note: 1. Support units were connected to second LISN.**

For the actual test configuration, please refer to the attached file (Test Setup Photo).

### 6.7.2 Test Procedure

- The EUT was placed on a 0.8 meter to the top of table and placed 0.4 meters from the conducting wall of the shielded room with EUT being connected to the power mains through a line impedance stabilization network (LISN). Other support units were connected to the power mains through another LISN. The two LISNs provide 50 ohm/ 50 uH of coupling impedance for the measuring instrument.
- Both lines of the power mains connected to the EUT were checked for maximum conducted interference.
- The frequency range from 150 kHz to 30 MHz was searched. Emission levels under (Limit – 20 dB) was not recorded.

Note: The resolution bandwidth and video bandwidth of test receiver is 9 kHz for quasi-peak detection (QP) and average detection (AV) at frequency 0.15 MHz-30 MHz.

## 6.8 Unwanted Emissions below 1 GHz

### 6.8.1 Test Setup

**For Radiated Configuration:**

**For Radiated emission below 30 MHz**

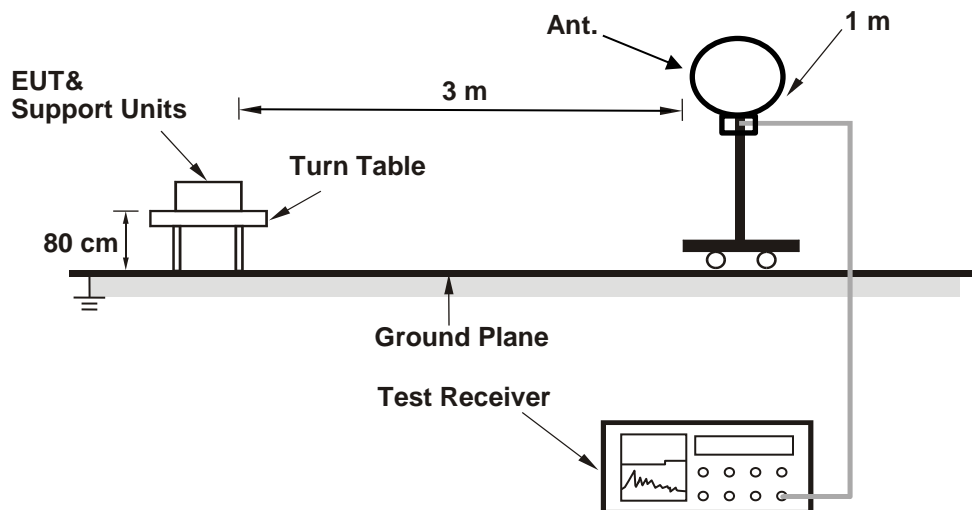

**For Radiated emission above 30 MHz**

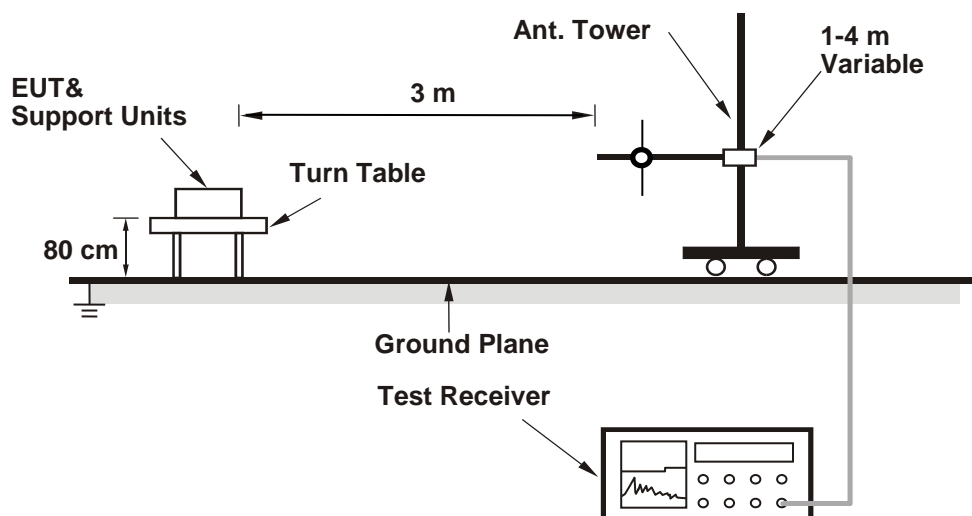

**For Conducted Configuration:**

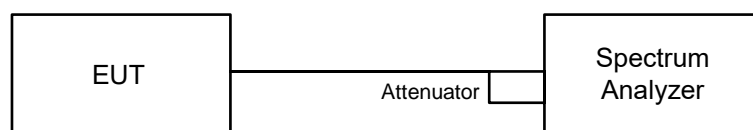

For the actual test configuration, please refer to the attached file (Test Setup Photo).



## 6.8.2 Test Procedure

### Radiated versus Conducted Measurement.

The unwanted emission limits in both the restricted and non-restricted bands are based on antenna-port conducted measurements in conjunction with cabinet emissions tests are permitted to demonstrate compliance.

The following steps was performed:

- a. Cabinet emissions measurements. Radiated measurement was performed to ensure that cabinet emissions are below the emission limits. For the cabinet-emission measurements the antenna was replaced by a termination matching the nominal impedance of the antenna.
- b. Conducted tests was performed using equipment that matches the nominal impedance of the antenna assembly used with the EUT.
- c. EIRP calculation. A value representative of an upper bound on out-of-band antenna gain (in dBi) shall be added to the measured antenna-port conducted emission power to compute EIRP within the specified measurement bandwidth. (For emissions in the restricted bands, additional calculations are required to convert EIRP to field strength at the specified distance.) The upper bound on antenna gain for a device with a single RF output shall be selected as the maximum in-band gain of the antenna across all operating bands or 2 dBi, whichever is greater.
- d. EIRP adjustments for multiple outputs. (Follow the procedures specified in FCC KDB Publication 662911)
- e. For all of Radiation emission test

#### **For Radiated emission below 30 MHz**

- e-1.1. The EUT was placed on the top of a rotating table 0.8 meters above the ground at 3 meter chamber room for test. The table was rotated 360 degrees to determine the position of the highest radiation.
- e-1.2. The EUT was set 3 meters away from the interference-receiving antenna, which was mounted on the top of a variable-height antenna tower.
- e-1.3. Parallel, perpendicular, and ground-parallel orientations of the antenna are set to make the measurement.
- e-1.4. For each suspected emission, the EUT was arranged to its worst case and the rotatable table was turned from 0 degrees to 360 degrees to find the maximum reading.
- e-1.5. The test-receiver system was set to Quasi-Peak Detect Function and Specified Bandwidth with Maximum Hold Mode, except for the frequency band (9 kHz to 90 kHz and 110 kHz to 490 kHz) set to average detect function and peak detect function.

#### Notes:

1. The resolution bandwidth and video bandwidth of test receiver/spectrum analyzer is 200 Hz at frequency below 150 kHz.
2. The resolution bandwidth and video bandwidth of test receiver/spectrum analyzer is 9 kHz or 10 kHz at frequency (150 kHz to 30 MHz).
3. All modes of operation were investigated and the worst-case emissions are reported.

### For Radiated emission above 30 MHz

- e-2.1. The EUT was placed on the top of a rotating table 0.8 meters above the ground at 3 meter chamber room for test. The table was rotated 360 degrees to determine the position of the highest radiation.
- e-2.2. The EUT was set 3 meters away from the interference-receiving antenna, which was mounted on the top of a variable-height antenna tower.
- e-2.3. The height of antenna is varied from one meter to four meters above the ground to determine the maximum value of the field strength. Both horizontal and vertical polarizations of the antenna are set to make the measurement.
- e-2.4. For each suspected emission, the EUT was arranged to its worst case and then the antenna was tuned to heights from 1 meter to 4 meters and the rotatable table was turned from 0 degrees to 360 degrees to find the maximum reading.
- e-2.5. The test-receiver system was set to quasi-peak detect function and specified bandwidth with maximum hold mode when the test frequency is below 1 GHz.

Notes:

1. The resolution bandwidth and video bandwidth of test receiver/spectrum analyzer is 120 kHz for Quasi-peak detection (QP) at frequency below 1 GHz.
2. All modes of operation were investigated and the worst-case emissions are reported.

<b>Radiated versus Conducted Measurement</b>
<p><u>For Radiated measurement:</u> The level of unwanted emissions was measured when radiated by the cabinet or structure of the equipment with the antenna connector(s) terminated by a specified load (cabinet radiation).</p> <p><u>For Conducted measurement:</u> The level of unwanted emissions was measured as their power in a specified load (conducted spurious emissions).</p>
<b>Conducted Unwanted Emission Convert Formula</b>
<p>a. Emission Level (dBuV/m) = EIRP Level (dBm) – 20log(d) + 104.8 d = measurement distance in 3 meters.</p> <p>b. EIRP Level (dBm) = Raw Value(dBm) + Correction Factor(dB)</p> <p>c. Correction Factor is directional gain, and the composite gain will be used when signal support the correlated signal For the out of band spurious the gain for the specific band may have been used rather than the highest gain across all bands. For the band edge the gain for the specific band may have been used.</p>
<p>Notes:</p> <ol style="list-style-type: none"> <li>1. In restricted bands below 1000 MHz, add upper bound on ground plane reflection: For frequencies between 30 MHz and 1000 MHz, add 4.7 dB.</li> <li>2. The conducted emission test was considered some factor to compute test result.</li> </ol>

## 6.9 Unwanted Emissions above 1 GHz

### 6.9.1 Test Setup

#### For Radiated Configuration:

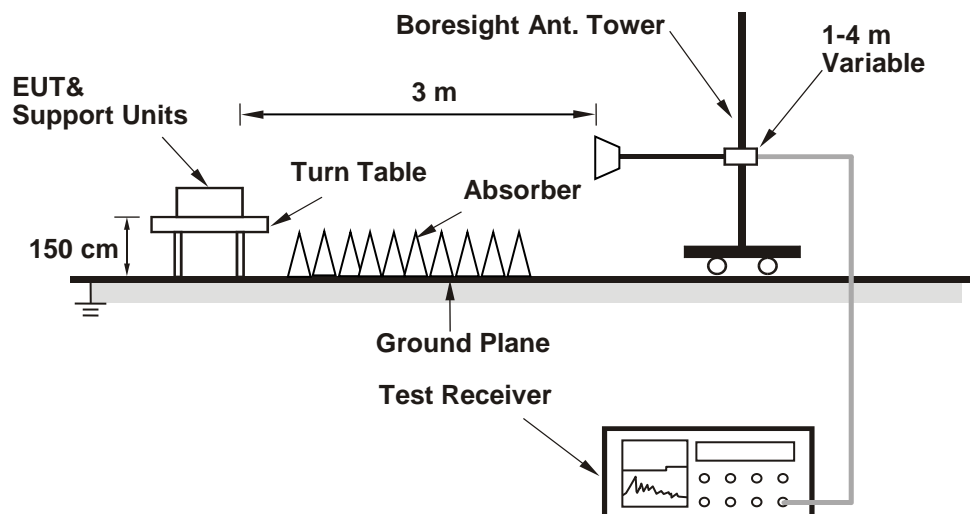

#### For Conducted Configuration:

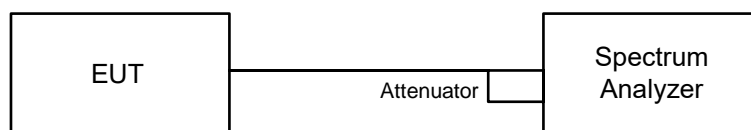

For the actual test configuration, please refer to the attached file (Test Setup Photo).

### 6.9.2 Test Procedure

#### Radiated versus Conducted Measurement.

The unwanted emission limits in both the restricted and non-restricted bands are based on antenna-port conducted measurements in conjunction with cabinet emissions tests are permitted to demonstrate compliance.

The following steps was performed:

- a. Cabinet emissions measurements. Radiated measurement was performed to ensure that cabinet emissions are below the emission limits. For the cabinet-emission measurements the antenna was replaced by a termination matching the nominal impedance of the antenna.
- b. Conducted tests was performed using equipment that matches the nominal impedance of the antenna assembly used with the EUT.
- c. EIRP calculation. A value representative of an upper bound on out-of-band antenna gain (in dBi) shall be added to the measured antenna-port conducted emission power to compute EIRP within the specified measurement bandwidth. (For emissions in the restricted bands, additional calculations are required to convert EIRP to field strength at the specified distance.) The upper bound on antenna gain for a device with a single RF output shall be selected as the maximum in-band gain of the antenna across all operating bands or 2 dBi, whichever is greater.
- d. EIRP adjustments for multiple outputs. (Follow the procedures specified in FCC KDB Publication 662911)
- e. For all of Radiation emission test
  - e-1. The EUT was placed on the top of a rotating table 1.5 meters above the ground at 3 meter chamber room for test. The table was rotated 360 degrees to determine the position of the highest radiation.
  - e-2. The EUT was set 3 meters away from the interference-receiving antenna, which was mounted on the top of a variable-height antenna tower.

- e-3. The height of antenna is varied from one meter to four meters above the ground to determine the maximum value of the field strength. Both horizontal and vertical polarizations of the antenna are set to make the measurement.
- e-4. For each suspected emission, the EUT was arranged to its worst case and then the antenna was tuned to heights from 1 meter to 4 meters and the rotatable table was turned from 0 degrees to 360 degrees to find the maximum reading.
- e-5. The test-receiver system was set to peak and average detects function and specified bandwidth with maximum hold mode when the test frequency is above 1 GHz. If the peak reading value also meets average limit, measurement with the average detector is unnecessary.

Notes:

1. The resolution bandwidth of test receiver/spectrum analyzer is 1 MHz and the video bandwidth is 3 MHz for Peak detection (PK) and Average detection (AV) at frequency above 1 GHz.
2. For fundamental and harmonic signal measurement, the resolution bandwidth of test receiver/spectrum analyzer is 1 MHz and the video bandwidth is  $\geq 1/T$  (Duty cycle < 98%) or 10 Hz (Duty cycle  $\geq 98\%$ ) for Average detection (AV) at frequency above 1 GHz.
3. All modes of operation were investigated and the worst-case emissions are reported.

<b>Radiated versus Conducted Measurement</b>
<p><u>For Radiated measurement:</u> The level of unwanted emissions was measured when radiated by the cabinet or structure of the equipment with the antenna connector(s) terminated by a specified load (cabinet radiation).</p> <p><u>For Conducted measurement:</u> The level of unwanted emissions was measured as their power in a specified load (conducted spurious emissions).</p> <p><u>For Verified radiated measurement:</u> The level of unwanted emissions was measured when radiated by the cabinet or structure of the equipment with the antenna connector(s) terminated by a specified load (cabinet radiation).</p>
<b>Conducted Unwanted Emission Convert Formula</b>
<p>a. Emission Level (dBuV/m) = EIRP Level (dBm) – 20log(d) + 104.8 d = measurement distance in 3 meters.</p> <p>b. EIRP Level (dBm) = Raw Value(dBm) + Correction Factor(dB).</p> <p>c. Correction Factor is directional gain, and the composite gain will be used when signal support the correlated signal For the out of band spurious the gain for the specific band may have been used rather than the highest gain across all bands. For the band edge the gain for the specific band may have been used.</p> <p>Note: The conducted emission test was considered some factor to compute test result.</p>

## 7 Test Results of Test Item

### 7.1 RF Output Power

Input Power:	3.3 Vdc	Environmental Conditions:	25°C, 60% RH	Tested By:	Kevin Ko
--------------	---------	---------------------------	--------------	------------	----------

#### Mode A

#### For Peak Power

Chan.	Chan. Freq. (MHz)	Peak Power (mW)	Peak Power (dBm)	Power Limit (dBm)	Test Result
1	2404	19.543	12.91	21	Pass
18	2438	18.365	12.64	21	Pass
38	2478	19.815	12.97	21	Pass

Note: The antenna gain is 3.53 dBi < 6 dBi, so the output power limit shall not be reduced.

#### For Average Power

Chan.	Chan. Freq. (MHz)	Average Power (mW)	Average Power (dBm)
1	2404	11.272	10.52
18	2438	10.046	10.02
38	2478	11.324	10.54

## 7.2 Number of Hopping Frequency Used

Input Power:	3.3 Vdc	Environmental Conditions:	25°C, 60% RH	Tested By:	Kevin Ko
--------------	---------	---------------------------	--------------	------------	----------

### Mode A

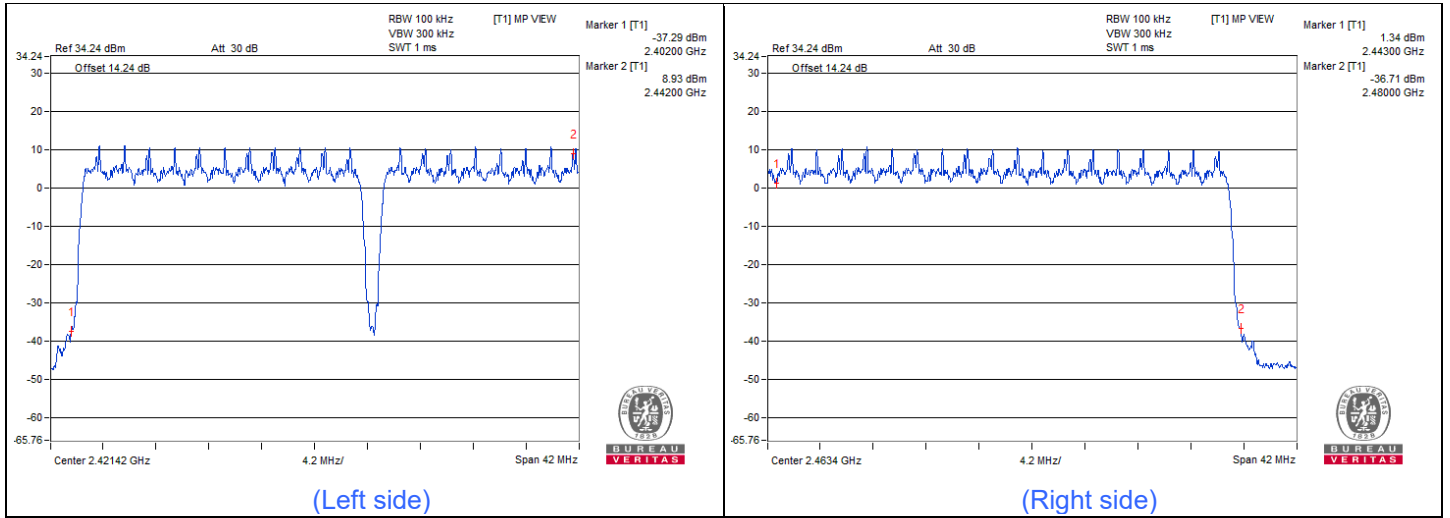

Note: There are 37 hopping frequencies in the hopping mode. On the plots, it shows that the hopping frequencies are equally spaced.

### 7.3 Dwell Time on Each Channel

Input Power:	3.3 Vdc	Environmental Conditions:	25°C, 60% RH	Tested By:	Kevin Ko
--------------	---------	---------------------------	--------------	------------	----------

#### Mode A

Mode	Number of transmission in 14.8 sec	Length of transmission time (msec)	Dwell Time (msec)	Limit (msec)	Test Result
FHSS	15 (times / 5 sec) * 2.96 = 45 times	1.504	67.68	400	Pass

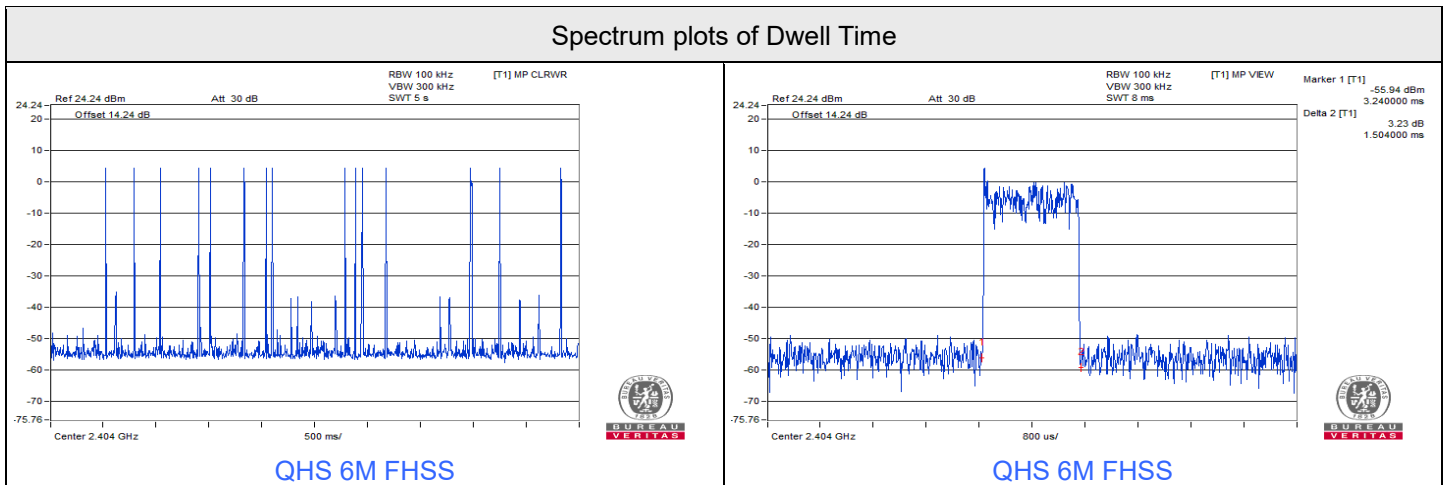

### 7.4 Hopping Channel Separation

Input Power:	3.3 Vdc	Environmental Conditions:	25°C, 60% RH	Tested By:	Kevin Ko
--------------	---------	---------------------------	--------------	------------	----------

#### Mode A

Channel	Frequency (MHz)	Hopping Channel Separation (MHz)	Minimum Limit (MHz)	Test Result
1	2404	2.00	1.58	Pass
18	2438	2.00	1.58	Pass
38	2478	2.00	1.66	Pass

Note: The minimum limit is two-third 20dB bandwidth.

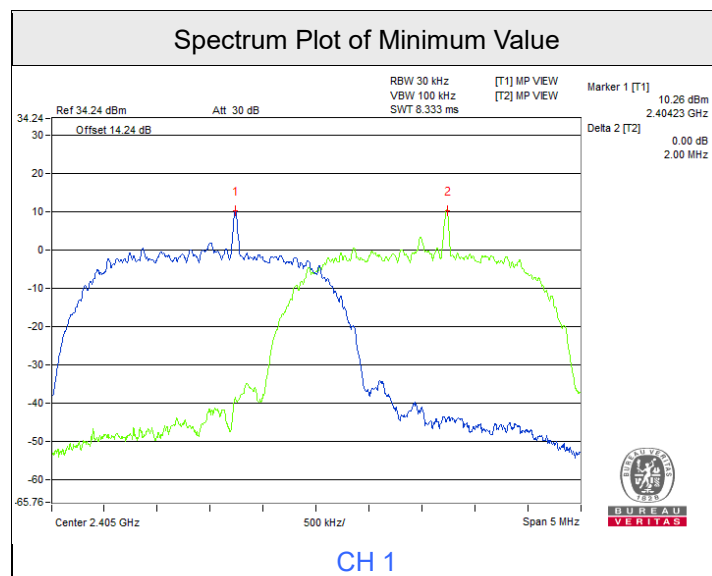



### 7.5 20 dB Bandwidth

Input Power:	3.3 Vdc	Environmental Conditions:	25°C, 60% RH	Tested By:	Kevin Ko
--------------	---------	---------------------------	--------------	------------	----------

#### Mode A

Channel	Frequency (MHz)	20dB Bandwidth (MHz)
1	2404	2.36
18	2438	2.36
38	2478	2.49

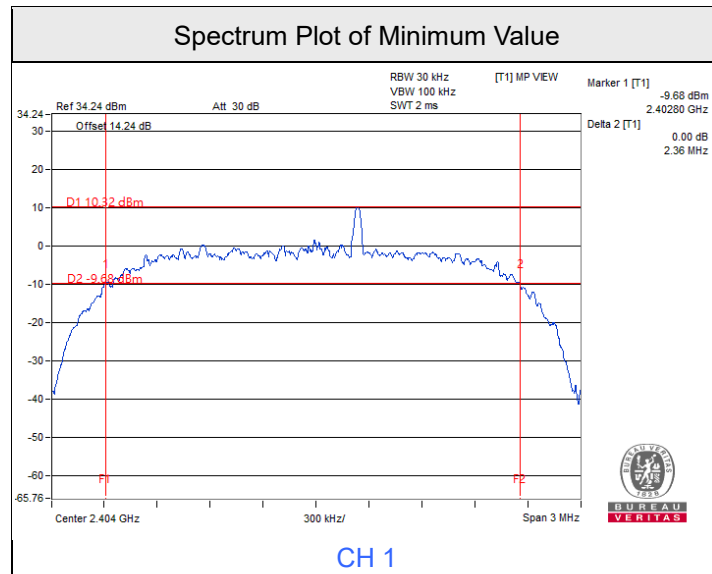



### 7.6 Conducted Out of Band Emissions

Input Power:	3.3 Vdc	Environmental Conditions:	25°C, 60% RH	Tested By:	Kevin Ko
--------------	---------	---------------------------	--------------	------------	----------

#### Mode A



## 7.7 AC Power Conducted Emissions

### Mode C

RF Mode	QHS 6M	Channel	CH 38 : 2478 MHz
Frequency Range	150 kHz ~ 30 MHz	Detector Function & Resolution Bandwidth	Quasi-Peak (QP) / Average (AV), 9 kHz
Input Power (System)	120 Vac, 60 Hz	Environmental Conditions	22°C, 63% RH
Tested By	Sampson Chen		

#### Phase Of Power : Line (L)

No	Frequency (MHz)	Correction Factor (dB)	Reading Value (dBuV)		Emission Level (dBuV)		Limit (dBuV)		Margin (dB)	
			Q.P.	AV.	Q.P.	AV.	Q.P.	AV.	Q.P.	AV.
1	0.16172	9.94	30.28	22.49	40.22	32.43	65.38	55.38	-25.16	-22.95
2	0.24375	9.94	23.44	12.27	33.38	22.21	61.97	51.97	-28.59	-29.76
<b>3</b>	<b>0.59141</b>	<b>9.96</b>	<b>34.85</b>	<b>26.78</b>	<b>44.81</b>	<b>36.74</b>	<b>56.00</b>	<b>46.00</b>	<b>-11.19</b>	<b>-9.26</b>
4	0.75938	9.97	20.62	14.84	30.59	24.81	56.00	46.00	-25.41	-21.19
5	3.53906	10.15	21.46	15.49	31.61	25.64	56.00	46.00	-24.39	-20.36
6	14.01563	10.94	33.19	25.71	44.13	36.65	60.00	50.00	-15.87	-13.35

#### Remarks:

1. Q.P. and AV. are abbreviations of quasi-peak and average individually.
2. The emission levels of other frequencies were very low against the limit.
3. Margin value = Emission level – Limit value
4. Correction factor = Insertion loss + Cable loss
5. Emission Level = Correction Factor + Reading Value

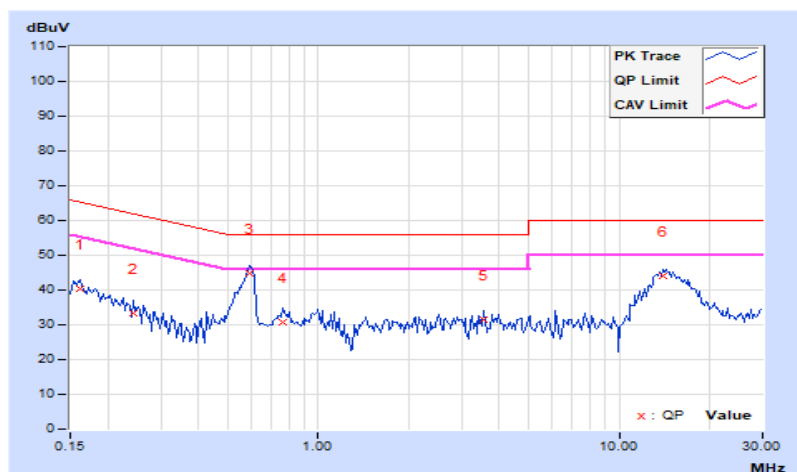

<b>RF Mode</b>	QHS 6M	<b>Channel</b>	CH 38 : 2478 MHz
<b>Frequency Range</b>	150 kHz ~ 30 MHz	<b>Detector Function &amp; Resolution Bandwidth</b>	Quasi-Peak (QP) / Average (AV), 9 kHz
<b>Input Power (System)</b>	120 Vac, 60 Hz	<b>Environmental Conditions</b>	22°C, 63% RH
<b>Tested By</b>	Sampson Chen		

Phase Of Power : Neutral (N)										
No	Frequency (MHz)	Correction Factor (dB)	Reading Value (dBuV)		Emission Level (dBuV)		Limit (dBuV)		Margin (dB)	
			Q.P.	AV.	Q.P.	AV.	Q.P.	AV.	Q.P.	AV.
1	0.16172	10.00	31.60	20.50	41.60	30.50	65.38	55.38	-23.78	-24.88
2	0.22422	10.00	26.29	11.04	36.29	21.04	62.66	52.66	-26.37	-31.62
3	0.59531	10.02	30.01	21.59	40.03	31.61	56.00	46.00	-15.97	-14.39
4	2.09766	10.10	16.76	6.81	26.86	16.91	56.00	46.00	-29.14	-29.09
5	13.71484	10.81	23.17	14.87	33.98	25.68	60.00	50.00	-26.02	-24.32
6	16.21094	10.94	25.58	19.22	36.52	30.16	60.00	50.00	-23.48	-19.84

**Remarks:**

1. Q.P. and AV. are abbreviations of quasi-peak and average individually.
2. The emission levels of other frequencies were very low against the limit.
3. Margin value = Emission level – Limit value
4. Correction factor = Insertion loss + Cable loss
5. Emission Level = Correction Factor + Reading Value

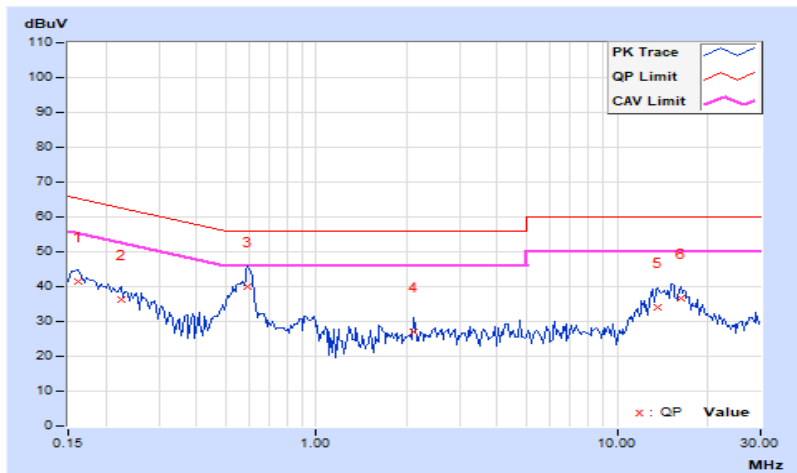

## 7.8 Unwanted Emissions below 1 GHz

### Mode A

RF Mode	QHS 6M	Channel	CH 38 : 2478 MHz
Frequency Range	30 MHz ~ 1 GHz	Environmental Conditions	22°C, 55% RH
Tested By	Kevin Ko		

Conducted Unwanted Emissions							
No.	Frequency (MHz)	Emission Level (dBuV/m)	Limit (dBuV/m)	Margin (dB)	Raw Value Chain 0 (dBm)	Correction Factor (dB)	EIRP Level (dBm)
1	74.01	23.17 PK	40	-16.83	-81.95	9.86	-72.09
2	155.25	23.71 PK	43.5	-19.79	-81.41	9.86	-71.55
3	383.93	24.17 PK	46	-21.83	-80.95	9.86	-71.09
4	495.6	24.93 PK	46	-21.07	-80.19	9.86	-70.33
5	710.46	25.42 PK	46	-20.58	-79.7	9.86	-69.84
6	808.18	25.52 PK	46	-20.48	-79.6	9.86	-69.74

#### Notes:

- Margin value = Emission Level - Limit value
- The frequency range 9 kHz ~ 30 MHz: all emissions are more than 20 dB below the limit, therefore do not be recorded in this report.

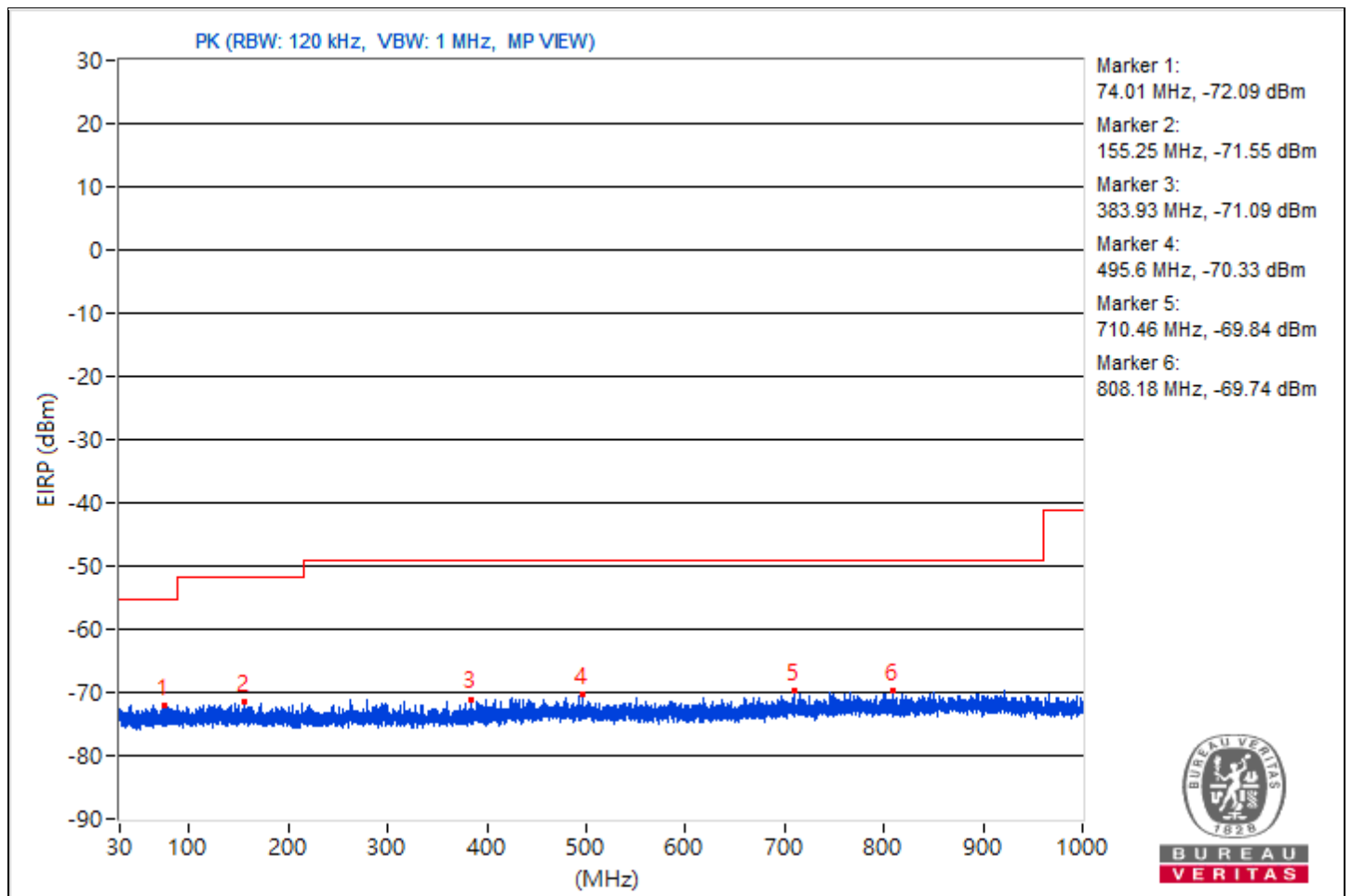

**Mode B**

<b>RF Mode</b>	QHS 6M	<b>Channel</b>	CH 38 : 2478 MHz
<b>Frequency Range</b>	30 MHz ~ 1 GHz	<b>Detector Function &amp; Bandwidth</b>	QP: RB=120kHz, DET=Quasi-Peak
<b>Input Power (System)</b>	120 Vac, 60 Hz	<b>Environmental Conditions</b>	23°C, 73% RH
<b>Tested By</b>	Sampson Chen		

Antenna Polarity & Test Distance : Horizontal at 3 m								
No	Frequency (MHz)	Emission Level (dBuV/m)	Limit (dBuV/m)	Margin (dB)	Antenna Height (m)	Table Angle (Degree)	Raw Value (dBuV)	Correction Factor (dB/m)
1	56.60	35.0 QP	40.0	-5.0	2.00 H	95	48.3	-13.3
2	120.31	37.9 QP	43.5	-5.6	2.00 H	261	52.9	-15.0
3	234.05	36.5 QP	46.0	-9.5	1.50 H	165	51.7	-15.2
<b>4</b>	<b>302.97</b>	<b>42.5 QP</b>	<b>46.0</b>	<b>-3.5</b>	<b>1.50 H</b>	<b>265</b>	<b>54.8</b>	<b>-12.3</b>
5	459.96	29.8 QP	46.0	-16.2	1.50 H	221	38.2	-8.4
6	500.03	38.5 QP	46.0	-7.5	2.00 H	275	46.2	-7.7

**Remarks:**

1. Emission Level(dBuV/m) = Raw Value(dBuV) + Correction Factor(dB/m)
2. Correction Factor(dB/m) = Antenna Factor(dB/m) + Cable Factor(dB) – Pre-Amplifier Factor(dB)
3. Margin value = Emission Level – Limit value
4. The other emission levels were very low against the limit of frequency range 30 MHz ~ 1 GHz.
5. The frequency range 9 kHz ~ 30 MHz: all emissions are more than 20 dB below the limit, therefore do not be recorded in this report.

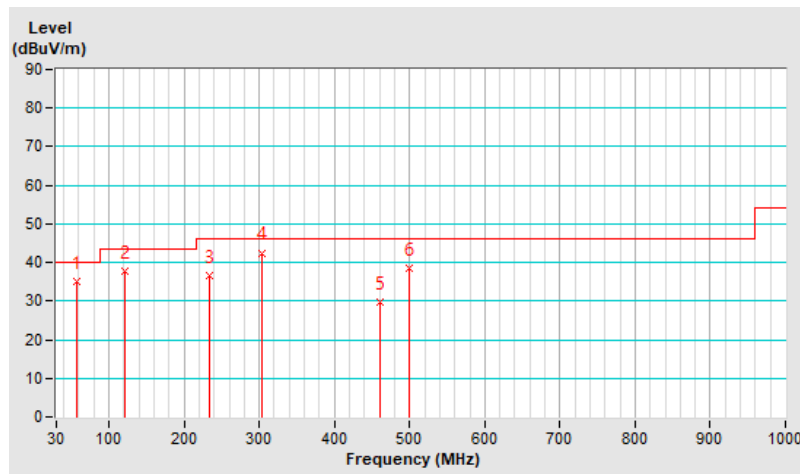

<b>RF Mode</b>	QHS 6M	<b>Channel</b>	CH 38 : 2478 MHz
<b>Frequency Range</b>	30 MHz ~ 1 GHz	<b>Detector Function &amp; Bandwidth</b>	QP: RB=120kHz, DET=Quasi-Peak
<b>Input Power (System)</b>	120 Vac, 60 Hz	<b>Environmental Conditions</b>	25°C, 68% RH
<b>Tested By</b>	Sampson Chen		

Antenna Polarity & Test Distance : Vertical at 3 m								
No	Frequency (MHz)	Emission Level (dBuV/m)	Limit (dBuV/m)	Margin (dB)	Antenna Height (m)	Table Angle (Degree)	Raw Value (dBuV)	Correction Factor (dB/m)
1	47.17	34.2 QP	40.0	-5.8	1.50 V	221	47.3	-13.1
2	103.78	36.5 QP	43.5	-7.0	2.00 V	321	53.2	-16.7
3	208.31	36.5 QP	43.5	-7.0	1.50 V	187	52.9	-16.4
4	300.94	40.9 QP	46.0	-5.1	2.00 V	154	53.3	-12.4
5	435.03	31.7 QP	46.0	-14.3	2.00 V	269	40.4	-8.7
6	519.64	39.7 QP	46.0	-6.3	1.50 V	222	46.9	-7.2

**Remarks:**

1. Emission Level(dBuV/m) = Raw Value(dBuV) + Correction Factor(dB/m)
2. Correction Factor(dB/m) = Antenna Factor(dB/m) + Cable Factor(dB) – Pre-Amplifier Factor(dB)
3. Margin value = Emission Level – Limit value
4. The other emission levels were very low against the limit of frequency range 30 MHz ~ 1 GHz.
5. The frequency range 9 kHz ~ 30 MHz: all emissions are more than 20 dB below the limit, therefore do not be recorded in this report.

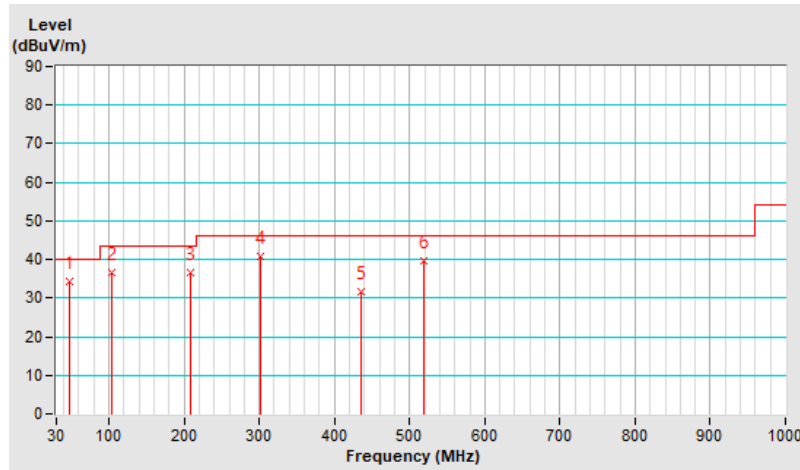

## 7.9 Unwanted Emissions above 1 GHz

### Mode A

#### Conducted Unwanted Emissions

RF Mode	QHS 6M	Channel	CH 1 : 2404 MHz
Frequency Range	1 GHz ~ 25 GHz	Environmental Conditions	22°C, 55% RH
Tested By	Kevin Ko		

Conducted Unwanted Emissions							
No.	Frequency (MHz)	Emission Level (dBuV/m)	Limit (dBuV/m)	Margin (dB)	Raw Value Chain 0 (dBm)	Correction Factor (dB)	EIRP Level (dBm)
1	2339.8	52.45 PK	74	-21.55	-47.97	5.16	-42.81
2	2211.62	42.67 AV	54	-11.33	-57.75	5.16	-52.59
3	4011.79	58.4 PK	74	-15.6	-42.02	5.16	-36.86
4	4036.99	43.14 AV	54	-10.86	-57.28	5.16	-52.12
5	15441.78	59.22 PK	74	-14.78	-41.2	5.16	-36.04
6	14494.04	43.37 AV	54	-10.63	-57.05	5.16	-51.89
7	22717.6	62.02 PK	74	-11.98	-38.4	5.16	-33.24
8	23608.3	46.84 AV	54	-7.16	-53.58	5.16	-48.42

Note: Margin value = Emission Level - Limit value

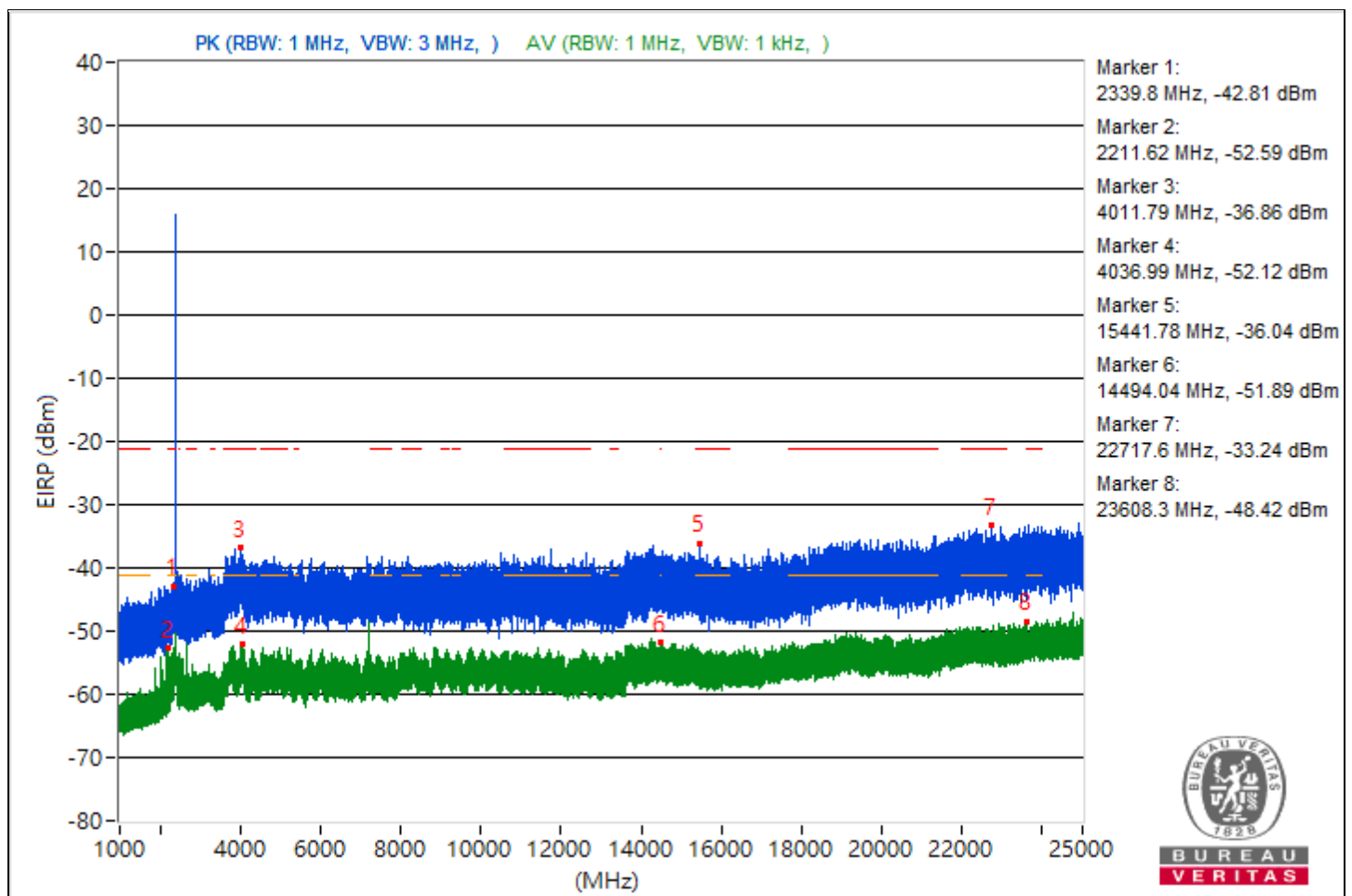





RF Mode	QHS 6M	Channel	CH 18 : 2438 MHz
Frequency Range	1 GHz ~ 25 GHz	Environmental Conditions	22°C, 55% RH
Tested By	Kevin Ko		

Conducted Unwanted Emissions							
No.	Frequency (MHz)	Emission Level (dBuV/m)	Limit (dBuV/m)	Margin (dB)	Raw Value Chain 0 (dBm)	Correction Factor (dB)	EIRP Level (dBm)
1	2266.92	52.21 PK	74	-21.79	-48.21	5.16	-43.05
2	2310.17	42.93 AV	54	-11.07	-57.49	5.16	-52.33
3	4084.2	58.46 PK	74	-15.54	-41.96	5.16	-36.8
<b>4</b>	<b>7314.54</b>	<b>49.19 AV</b>	<b>54</b>	<b>-4.81</b>	<b>-51.23</b>	<b>5.16</b>	<b>-46.07</b>
5	10958.67	57.94 PK	74	-16.06	-42.48	5.16	-37.32
6	14494.58	43.41 AV	54	-10.59	-57.01	5.16	-51.85
7	23913.4	62 PK	74	-12	-38.42	5.16	-33.26
8	23808.9	46.62 AV	54	-7.38	-53.8	5.16	-48.64

Note: Margin value = Emission Level - Limit value

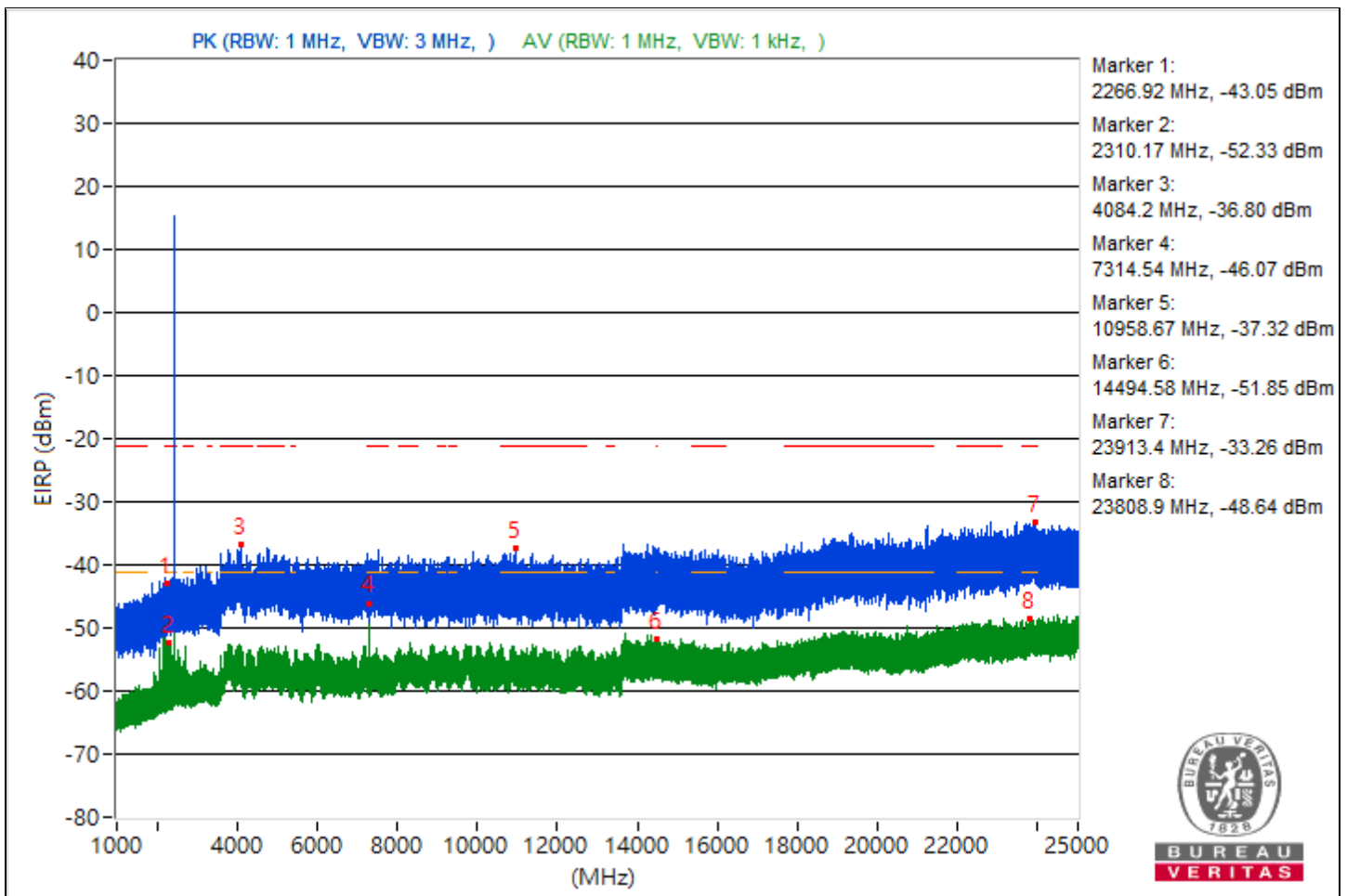



RF Mode	QHS 6M	Channel	CH 38 : 2478 MHz
Frequency Range	1 GHz ~ 25 GHz	Environmental Conditions	22°C, 55% RH
Tested By	Kevin Ko		

Conducted Unwanted Emissions							
No.	Frequency (MHz)	Emission Level (dBUV/m)	Limit (dBUV/m)	Margin (dB)	Raw Value Chain 0 (dBm)	Correction Factor (dB)	EIRP Level (dBm)
1	2221.81	55.37 PK	74	-18.63	-45.05	5.16	-39.89
2	2222.36	46.41 AV	54	-7.59	-54.01	5.16	-48.85
3	4779.38	57.93 PK	74	-16.07	-42.49	5.16	-37.33
4	7434.94	46.01 AV	54	-7.99	-54.41	5.16	-49.25
5	9114.58	58.03 PK	74	-15.97	-42.39	5.16	-37.23
6	14479.64	43.67 AV	54	-10.33	-56.75	5.16	-51.59
7	23756.6	62.32 PK	74	-11.68	-38.1	5.16	-32.94
8	23912.8	47.23 AV	54	-6.77	-53.19	5.16	-48.03

Note: Margin value = Emission Level - Limit value

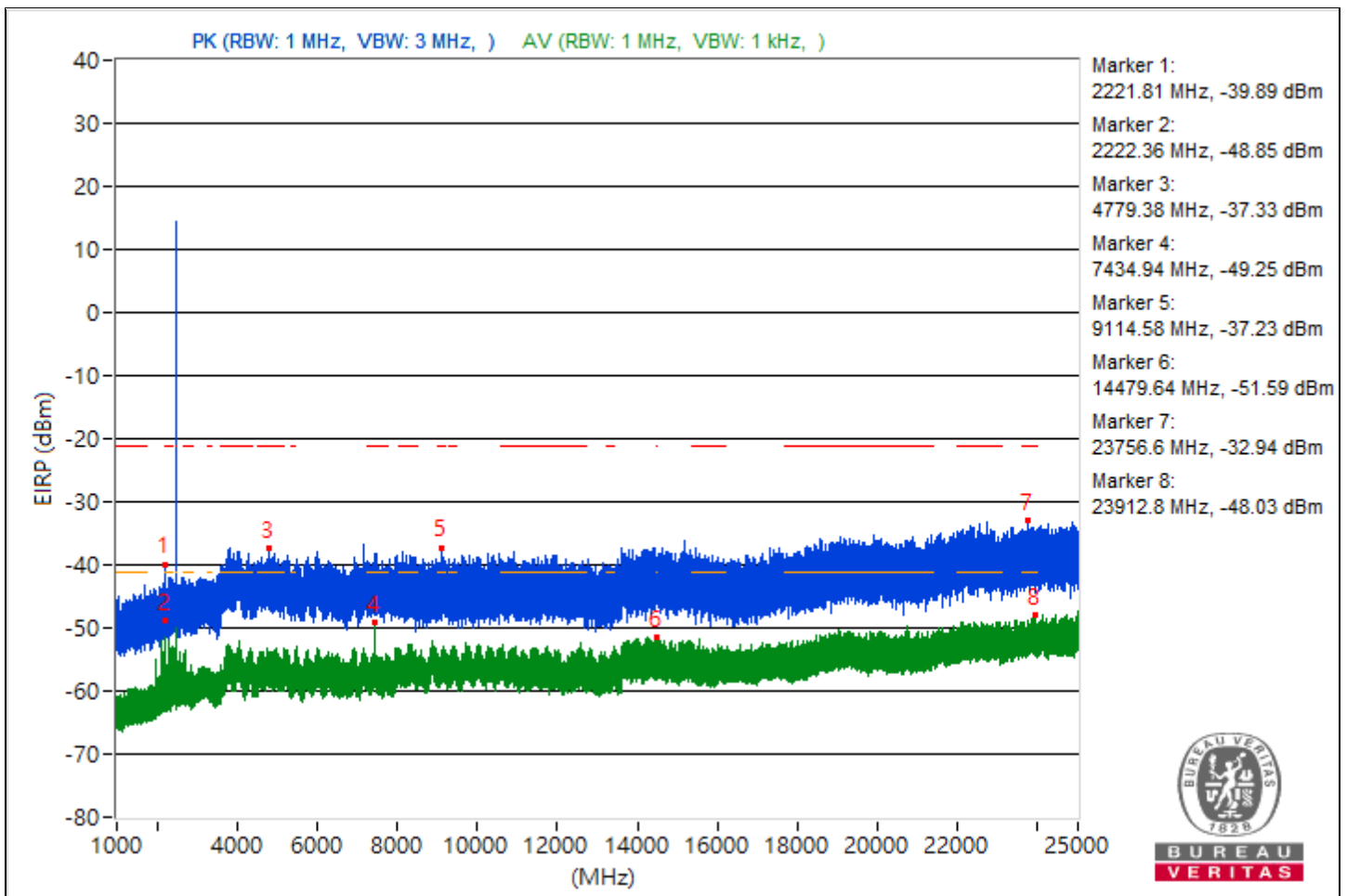

### Conducted Band Edges

RF Mode	QHS 6M	Channel	CH 1 : 2404 MHz
Frequency Range	2.31 GHz ~ 2.5 GHz	Environmental Conditions	22°C, 55% RH
Tested By	Kevin Ko		

Conducted Band Edge							
No.	Frequency (MHz)	Emission Level (dBuV/m)	Limit (dBuV/m)	Margin (dB)	Raw Value Chain 0 (dBm)	Correction Factor (dB)	EIRP Level (dBm)
1	*2404.22	109.57 PK			10.78	3.53	14.31
2	*2404.05	105.34 AV			6.55	3.53	10.08
3	2364.98	53.74 PK	74	-20.26	-45.05	3.53	-41.52
4	2327.31	41.23 AV	54	-12.77	-57.56	3.53	-54.03
5	2499.1	52.71 PK	74	-21.29	-46.08	3.53	-42.55
6	2492.61	35.86 AV	54	-18.14	-62.93	3.53	-59.4

Notes:

1. Margin value = Emission Level - Limit value
2. " \* ": Fundamental frequency, the limit was restricted at the RF Output Power.

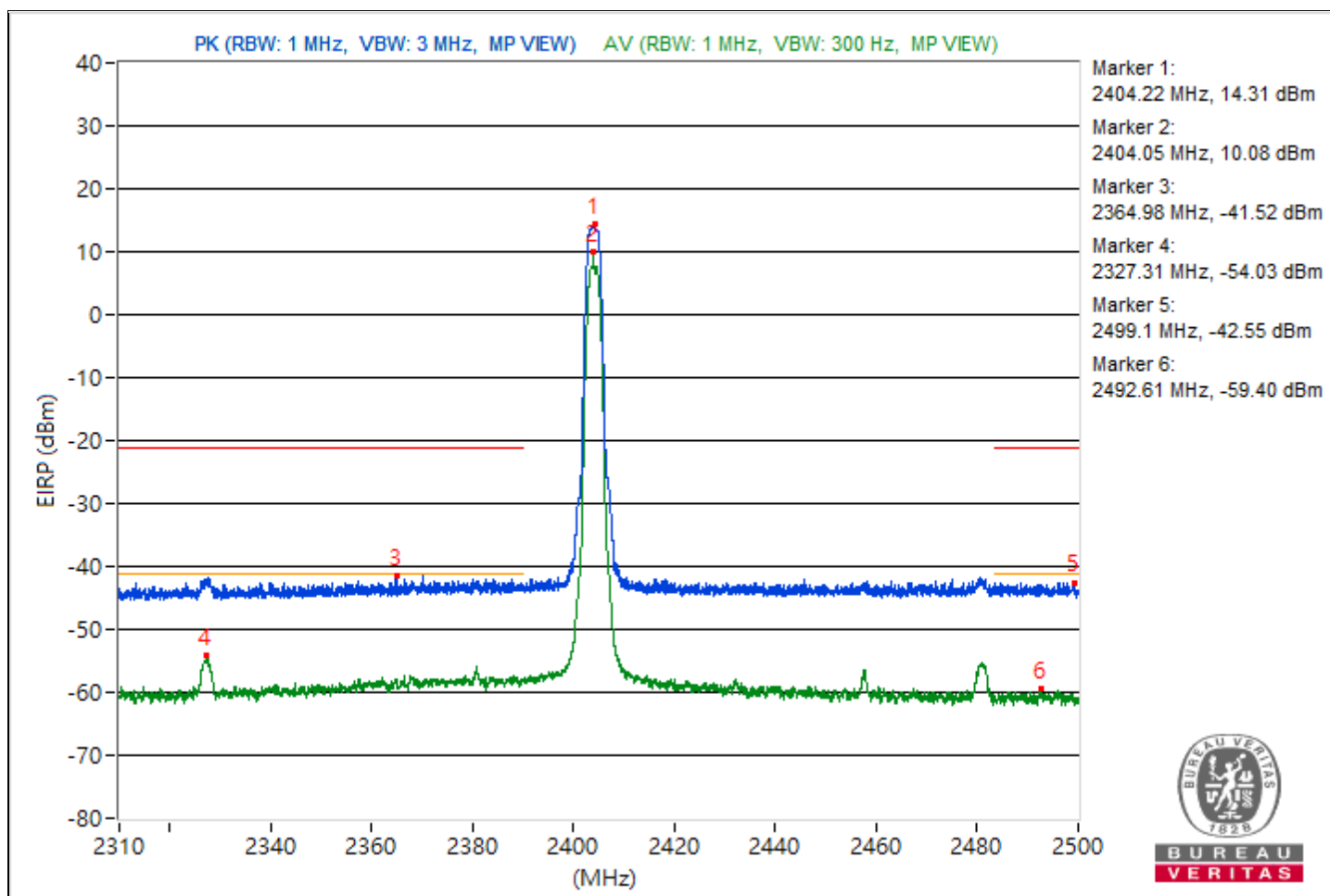

RF Mode	QHS 6M	Channel	CH 18 : 2438 MHz
Frequency Range	2.31 GHz ~ 2.5 GHz	Environmental Conditions	22°C, 55% RH
Tested By	Kevin Ko		

Conducted Band Edge							
No.	Frequency (MHz)	Emission Level (dBuV/m)	Limit (dBuV/m)	Margin (dB)	Raw Value Chain 0 (dBm)	Correction Factor (dB)	EIRP Level (dBm)
1	*2437.66	109.73 PK			10.94	3.53	14.47
2	*2438.06	105.03 AV			6.24	3.53	9.77
3	2360.61	52.02 PK	74	-21.98	-46.77	3.53	-43.24
4	2361.32	41.68 AV	54	-12.32	-57.11	3.53	-53.58
5	2496.46	51.38 PK	74	-22.62	-47.41	3.53	-43.88
6	2491.16	36.25 AV	54	-17.75	-62.54	3.53	-59.01

Notes:

1. Margin value = Emission Level - Limit value
2. " \* " : Fundamental frequency, the limit was restricted at the RF Output Power.

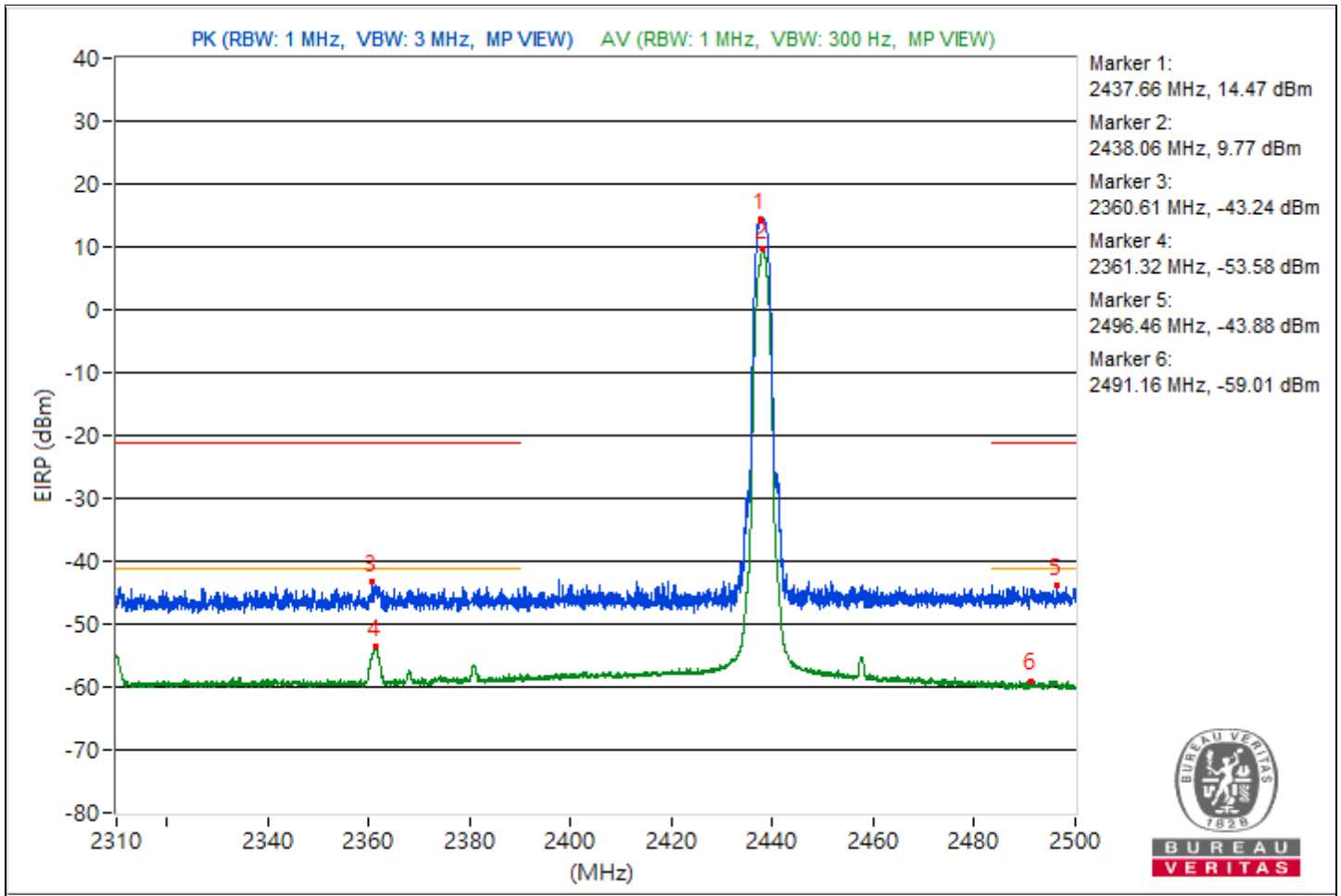

RF Mode	QHS 6M	Channel	CH 38 : 2478 MHz
Frequency Range	2.31 GHz ~ 2.5 GHz	Environmental Conditions	22°C, 55% RH
Tested By	Kevin Ko		

Conducted Band Edge							
No.	Frequency (MHz)	Emission Level (dBuV/m)	Limit (dBuV/m)	Margin (dB)	Raw Value Chain 0 (dBm)	Correction Factor (dB)	EIRP Level (dBm)
1	*2478.2	108.12 PK			9.33	3.53	12.86
2	*2477.75	102.58 AV			3.79	3.53	7.32
3	2324.75	52.35 PK	74	-21.65	-46.44	3.53	-42.91
4	2324.49	40.56 AV	54	-13.44	-58.23	3.53	-54.7
5	2488.58	52.62 PK	74	-21.38	-46.17	3.53	-42.64
6	2483.71	38.01 AV	54	-15.99	-60.78	3.53	-57.25

Notes:

1. Margin value = Emission Level - Limit value
2. " \* " : Fundamental frequency, the limit was restricted at the RF Output Power.

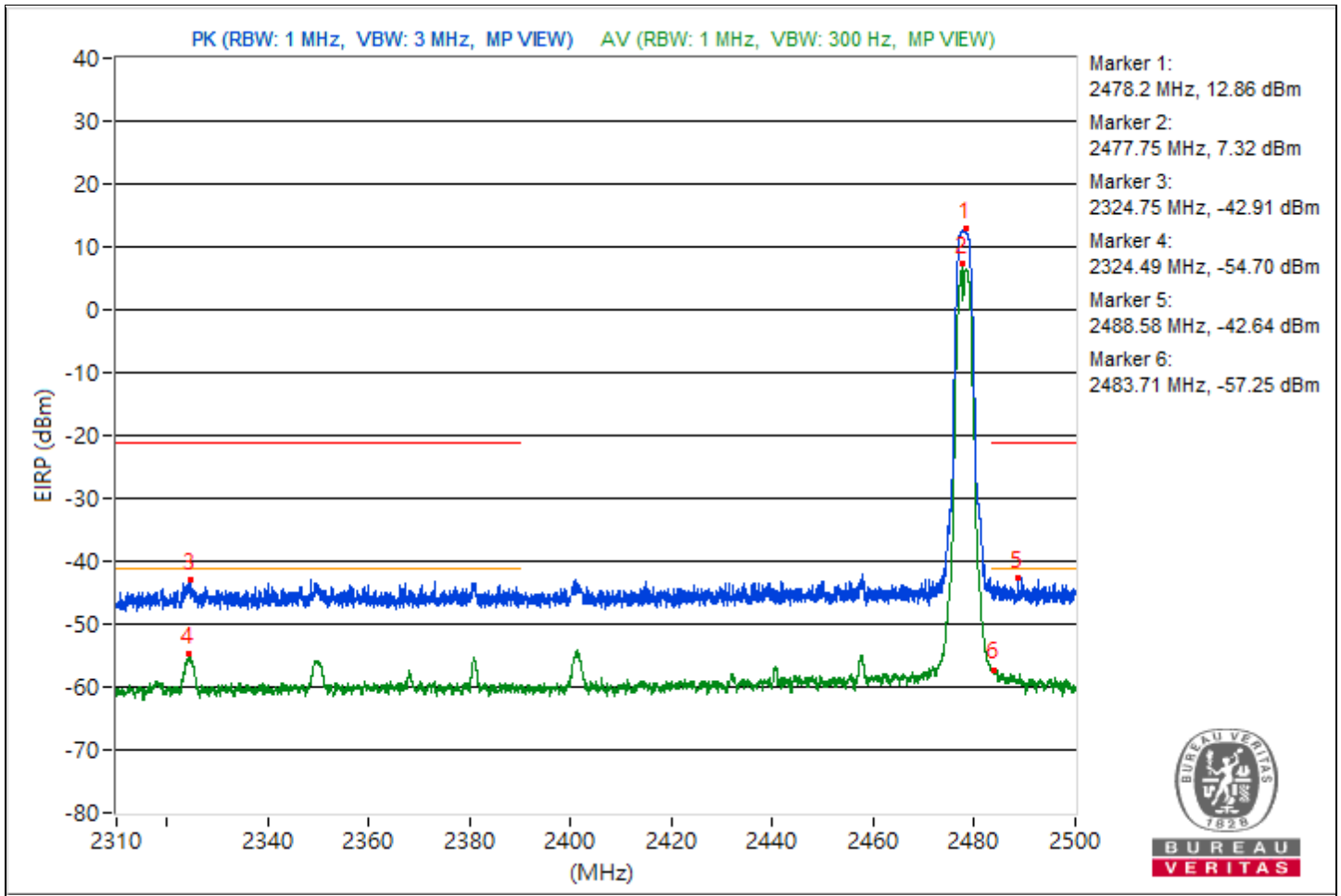

**Mode B**

<b>RF Mode</b>	QHS 6M	<b>Channel</b>	CH 1 : 2404 MHz
<b>Frequency Range</b>	1 GHz ~ 25 GHz	<b>Detector Function &amp; Bandwidth</b>	PK: RB=1 MHz, VB=3 MHz, DET=Peak AV: RB=1 MHz, VB=1 kHz, DET=Peak
<b>Input Power (System)</b>	120 Vac, 60 Hz	<b>Environmental Conditions</b>	22°C, 69% RH
<b>Tested By</b>	Sampson Chen		

Antenna Polarity & Test Distance : Horizontal at 3 m								
No	Frequency (MHz)	Emission Level (dBUV/m)	Limit (dBUV/m)	Margin (dB)	Antenna Height (m)	Table Angle (Degree)	Raw Value (dBUV)	Correction Factor (dB/m)
1	4808.00	42.1 PK	74.0	-31.9	1.33 H	321	37.6	4.5
2	4808.00	30.5 AV	54.0	-23.5	1.33 H	321	26.0	4.5

**Remarks:**

1. Emission Level(dBUV/m) = Raw Value(dBuV) + Correction Factor(dB/m)
2. Correction Factor(dB/m) = Antenna Factor(dB/m) + Cable Factor(dB) – Pre-Amplifier Factor(dB)
3. Margin value = Emission Level – Limit value
4. The other emission levels were very low against the limit.

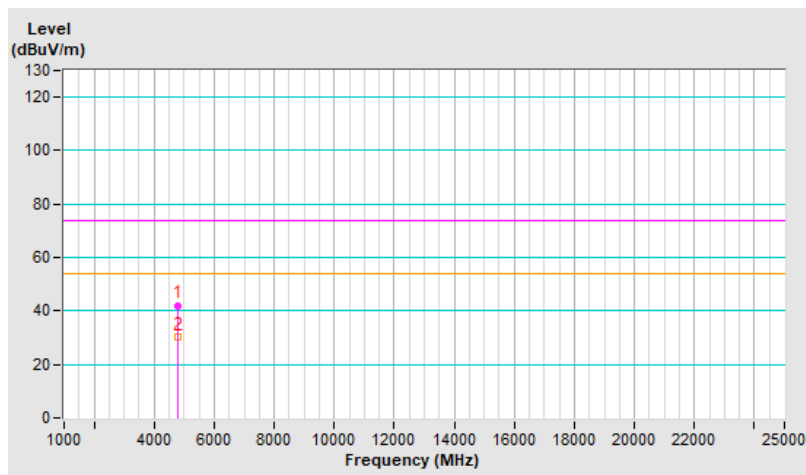

<b>RF Mode</b>	QHS 6M	<b>Channel</b>	CH 1 : 2404 MHz
<b>Frequency Range</b>	1 GHz ~ 25 GHz	<b>Detector Function &amp; Bandwidth</b>	PK: RB=1 MHz, VB=3 MHz, DET=Peak AV: RB=1 MHz, VB=1 kHz, DET=Peak
<b>Input Power (System)</b>	120 Vac, 60 Hz	<b>Environmental Conditions</b>	22°C, 69% RH
<b>Tested By</b>	Sampson Chen		

Antenna Polarity & Test Distance : Vertical at 3 m								
No	Frequency (MHz)	Emission Level (dBuV/m)	Limit (dBuV/m)	Margin (dB)	Antenna Height (m)	Table Angle (Degree)	Raw Value (dBuV)	Correction Factor (dB/m)
1	4808.00	39.3 PK	74.0	-34.7	1.68 V	147	34.8	4.5
2	4808.00	29.7 AV	54.0	-24.3	1.68 V	147	25.2	4.5

**Remarks:**

1. Emission Level(dBuV/m) = Raw Value(dBuV) + Correction Factor(dB/m)
2. Correction Factor(dB/m) = Antenna Factor(dB/m) + Cable Factor(dB) – Pre-Amplifier Factor(dB)
3. Margin value = Emission Level – Limit value
4. The other emission levels were very low against the limit.

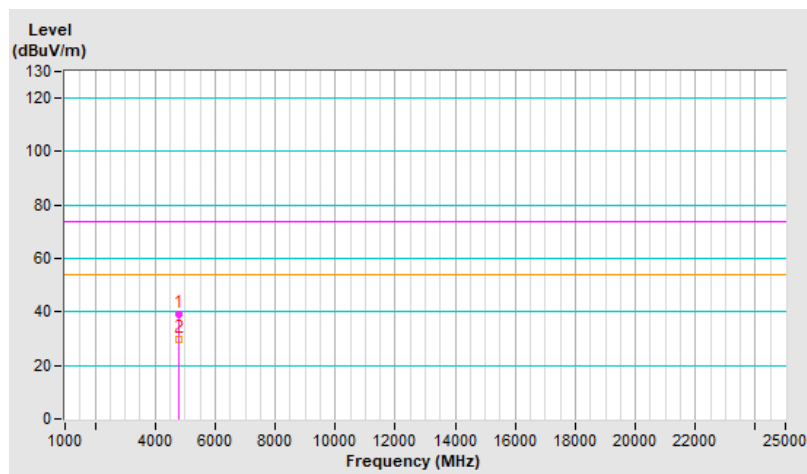

<b>RF Mode</b>	QHS 6M	<b>Channel</b>	CH 18 : 2438 MHz
<b>Frequency Range</b>	1 GHz ~ 25 GHz	<b>Detector Function &amp; Bandwidth</b>	PK: RB=1 MHz, VB=3 MHz, DET=Peak AV: RB=1 MHz, VB=1 kHz, DET=Peak
<b>Input Power (System)</b>	120 Vac, 60 Hz	<b>Environmental Conditions</b>	22°C, 69% RH
<b>Tested By</b>	Sampson Chen		

Antenna Polarity & Test Distance : Horizontal at 3 m								
No	Frequency (MHz)	Emission Level (dBuV/m)	Limit (dBuV/m)	Margin (dB)	Antenna Height (m)	Table Angle (Degree)	Raw Value (dBuV)	Correction Factor (dB/m)
1	4876.00	41.2 PK	74.0	-32.8	1.36 H	331	36.7	4.5
2	4876.00	30.5 AV	54.0	-23.5	1.36 H	331	26.0	4.5
3	7314.00	47.6 PK	74.0	-26.4	1.89 H	171	36.1	11.5
4	7314.00	34.9 AV	54.0	-19.1	1.89 H	171	23.4	11.5

**Remarks:**

1. Emission Level(dBuV/m) = Raw Value(dBuV) + Correction Factor(dB/m)
2. Correction Factor(dB/m) = Antenna Factor(dB/m) + Cable Factor(dB) – Pre-Amplifier Factor(dB)
3. Margin value = Emission Level – Limit value
4. The other emission levels were very low against the limit.

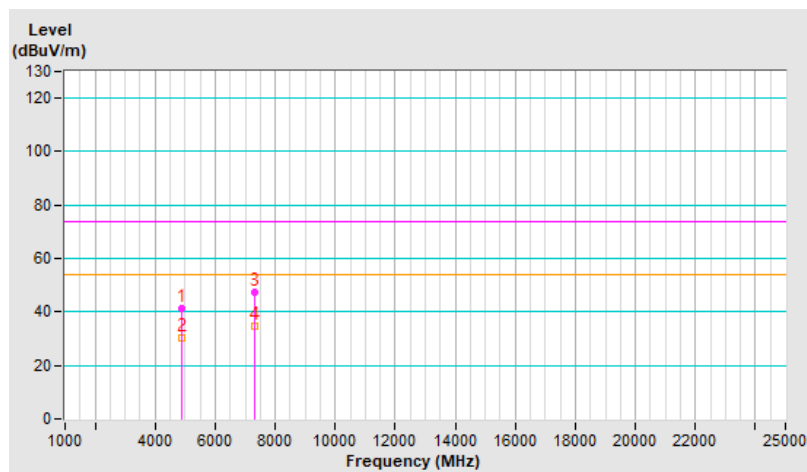



<b>RF Mode</b>	QHS 6M	<b>Channel</b>	CH 18 : 2438 MHz
<b>Frequency Range</b>	1 GHz ~ 25 GHz	<b>Detector Function &amp; Bandwidth</b>	PK: RB=1 MHz, VB=3 MHz, DET=Peak AV: RB=1 MHz, VB=1 kHz, DET=Peak
<b>Input Power (System)</b>	120 Vac, 60 Hz	<b>Environmental Conditions</b>	22°C, 69% RH
<b>Tested By</b>	Sampson Chen		

Antenna Polarity & Test Distance : Vertical at 3 m								
No	Frequency (MHz)	Emission Level (dBuV/m)	Limit (dBuV/m)	Margin (dB)	Antenna Height (m)	Table Angle (Degree)	Raw Value (dBuV)	Correction Factor (dB/m)
1	4876.00	40.9 PK	74.0	-33.1	1.49 V	160	36.4	4.5
2	4876.00	31.6 AV	54.0	-22.4	1.49 V	160	27.1	4.5
3	7314.00	46.9 PK	74.0	-27.1	1.99 V	264	35.4	11.5
4	7314.00	34.6 AV	54.0	-19.4	1.99 V	264	23.1	11.5

**Remarks:**

1. Emission Level(dBuV/m) = Raw Value(dBuV) + Correction Factor(dB/m)
2. Correction Factor(dB/m) = Antenna Factor(dB/m) + Cable Factor(dB) – Pre-Amplifier Factor(dB)
3. Margin value = Emission Level – Limit value
4. The other emission levels were very low against the limit.

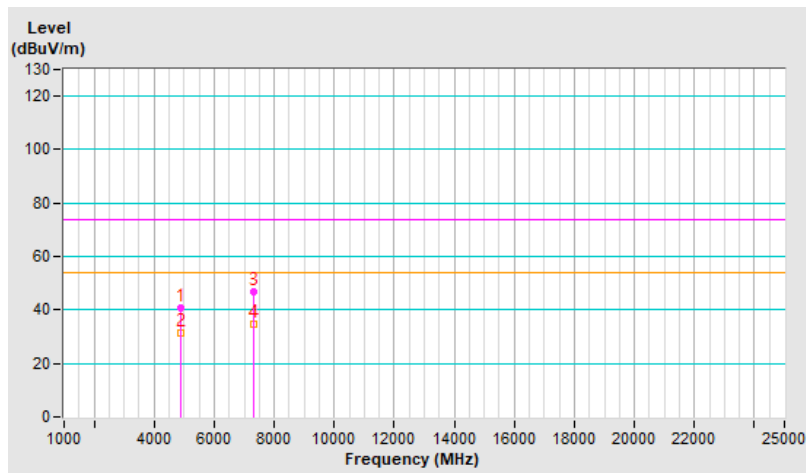

<b>RF Mode</b>	QHS 6M	<b>Channel</b>	CH 38 : 2478 MHz
<b>Frequency Range</b>	1 GHz ~ 25 GHz	<b>Detector Function &amp; Bandwidth</b>	PK: RB=1 MHz, VB=3 MHz, DET=Peak AV: RB=1 MHz, VB=1 kHz, DET=Peak
<b>Input Power (System)</b>	120 Vac, 60 Hz	<b>Environmental Conditions</b>	22°C, 69% RH
<b>Tested By</b>	Sampson Chen		

Antenna Polarity & Test Distance : Horizontal at 3 m								
No	Frequency (MHz)	Emission Level (dBuV/m)	Limit (dBuV/m)	Margin (dB)	Antenna Height (m)	Table Angle (Degree)	Raw Value (dBuV)	Correction Factor (dB/m)
1	4956.00	40.3 PK	74.0	-33.7	1.28 H	321	35.6	4.7
2	4956.00	30.2 AV	54.0	-23.8	1.28 H	321	25.5	4.7
3	7434.00	46.1 PK	74.0	-27.9	1.86 H	199	34.2	11.9
4	7434.00	33.8 AV	54.0	-20.2	1.86 H	199	21.9	11.9

**Remarks:**

1. Emission Level(dBuV/m) = Raw Value(dBuV) + Correction Factor(dB/m)
2. Correction Factor(dB/m) = Antenna Factor(dB/m) + Cable Factor(dB) – Pre-Amplifier Factor(dB)
3. Margin value = Emission Level – Limit value
4. The other emission levels were very low against the limit.

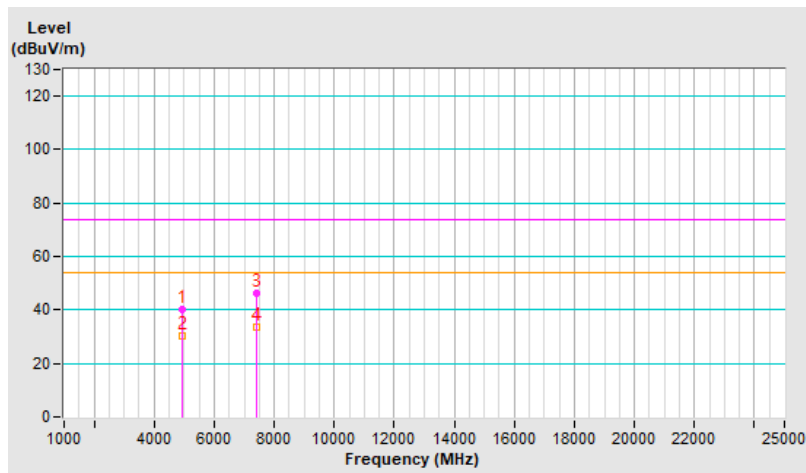

<b>RF Mode</b>	QHS 6M	<b>Channel</b>	CH 38 : 2478 MHz
<b>Frequency Range</b>	1 GHz ~ 25 GHz	<b>Detector Function &amp; Bandwidth</b>	PK: RB=1 MHz, VB=3 MHz, DET=Peak AV: RB=1 MHz, VB=1 kHz, DET=Peak
<b>Input Power (System)</b>	120 Vac, 60 Hz	<b>Environmental Conditions</b>	22°C, 69% RH
<b>Tested By</b>	Sampson Chen		

Antenna Polarity & Test Distance : Vertical at 3 m								
No	Frequency (MHz)	Emission Level (dBuV/m)	Limit (dBuV/m)	Margin (dB)	Antenna Height (m)	Table Angle (Degree)	Raw Value (dBuV)	Correction Factor (dB/m)
1	4956.00	40.7 PK	74.0	-33.3	1.46 V	151	36.0	4.7
2	4956.00	31.3 AV	54.0	-22.7	1.46 V	151	26.6	4.7
3	7434.00	47.0 PK	74.0	-27.0	2.01 V	259	35.1	11.9
4	7434.00	35.0 AV	54.0	-19.0	2.01 V	259	23.1	11.9

**Remarks:**

1. Emission Level(dBuV/m) = Raw Value(dBuV) + Correction Factor(dB/m)
2. Correction Factor(dB/m) = Antenna Factor(dB/m) + Cable Factor(dB) – Pre-Amplifier Factor(dB)
3. Margin value = Emission Level – Limit value
4. The other emission levels were very low against the limit.

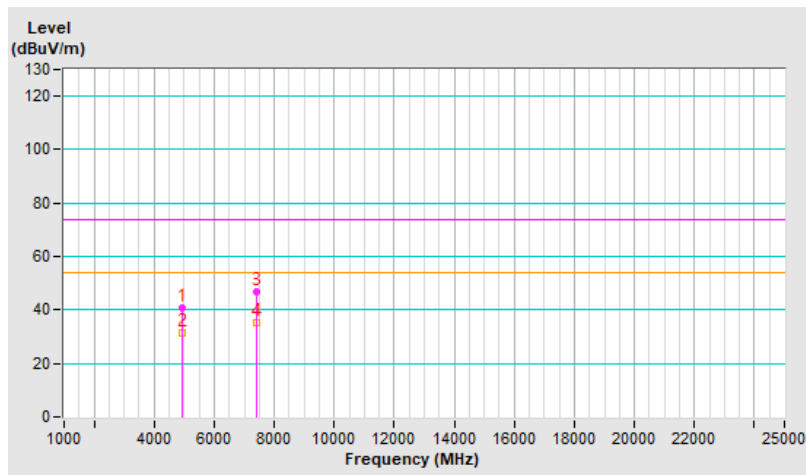

## 8 Pictures of Test Arrangements

Please refer to the attached file (Test Setup Photo)

## 9 Information of the Testing Laboratories

We, Bureau Veritas Consumer Products Services (H.K.) Ltd., Taoyuan Branch, were founded in 1988 to provide our best service in EMC, Radio, Telecom and Safety consultation. Our laboratories are FCC recognized accredited test firms and accredited according to ISO/IEC 17025.

If you have any comments, please feel free to contact us at the following:

**Lin Kou EMC/RF Lab**

Tel: 886-2-26052180

Fax: 886-2-26051924

**Hsin Chu EMC/RF/Telecom Lab**

Tel: 886-3-6668565

Fax: 886-3-6668323

**Hwa Ya EMC/RF/Safety Lab**

Tel: 886-3-3183232

Fax: 886-3-3270892

**Email:** [service.adt@bureauveritas.com](mailto:service.adt@bureauveritas.com)

**Web Site:** <http://ee.bureauveritas.com.tw>

The address and road map of all our labs can be found in our web site also.

--- END ---