

# Regulatory WLAN Antenna Information (Template)

*English Language Required for Regulatory Review / Approval*

Platform information						
Brand	Tester's name	Tester's signature	Test Date	platform (ex: Yes, No or NA)	Platform type (ex: regular NB, convertible PC, AIO...etc)	*SAR minimum separation (mm)
Hong-Bo	Eason Tseng	<i>Eason Tseng</i>	2021/1/25	NA	WiFi PIFA	
<p>*****Please fill in exact product model name and make sure the model name is visible on product cover or any parts for end users recognize for authority inspection.</p>						
Antenna information						
Vendor		Type	Antenna Part number (Main)			
Hong-Bo		PIFA	260-25094			
Peak gain w/ cable loss (dBi)*						
	2.4GHz 2400-2483.5 MHz	5.2GHz 5150-5250MHz	5.3GHz 5250-5350MHz	5.6GHz 5470-5725MHz	5.8GHz 5725-5850MHz	
Main	3.53	3.06	3.07	4.81	4.2	

# Table of contents

1. Applicable test method
2. Test & System Description
  - a. Test setup
  - b. Equipment list
3. Setup photo

## Section 1. Antenna Assembly Specifications

## Section 2. Radiation characteristics of antenna loaded in Host Platform

4. Antenna information used for conformity with limits

**1. Applicable test methods**

This test report is prepared for PIFA antenna testing under a AMS-8500 Full Anechoic Chamber.

ETS-Lindgren AMS-8500 system is 3D fully anechoic chamber, it is applied to the "Conical Cut test method"

the detail description is described as below,

The Conical Cut method requires the ability of the Measurement Antenna to be physically rotated in the theta plane (overhead) of the EUT for implementations using a single Measurement Antenna, Eleven conical cuts are required to capture data at every 15 degrees from the EUT, with the top (0 degrees) and bottom

(180 degrees) cuts not being measured. Typically, the EUT will remain affixed to a turntable during the entire measurement process. The Measurement Antenna will be positioned at a starting theta angle.

The EUT will then be rotated around the full 360 degrees of phi rotation, The

Measurement Antenna will then be positioned at the next theta angle, and the process repeated.

		$\theta$ -Axis	$\Phi$ -Axis
Passive	Step size	15°~165° step: 15°	0°~345° step: 15°
	N / M (Points)	12	24

**2. Test & System Description**

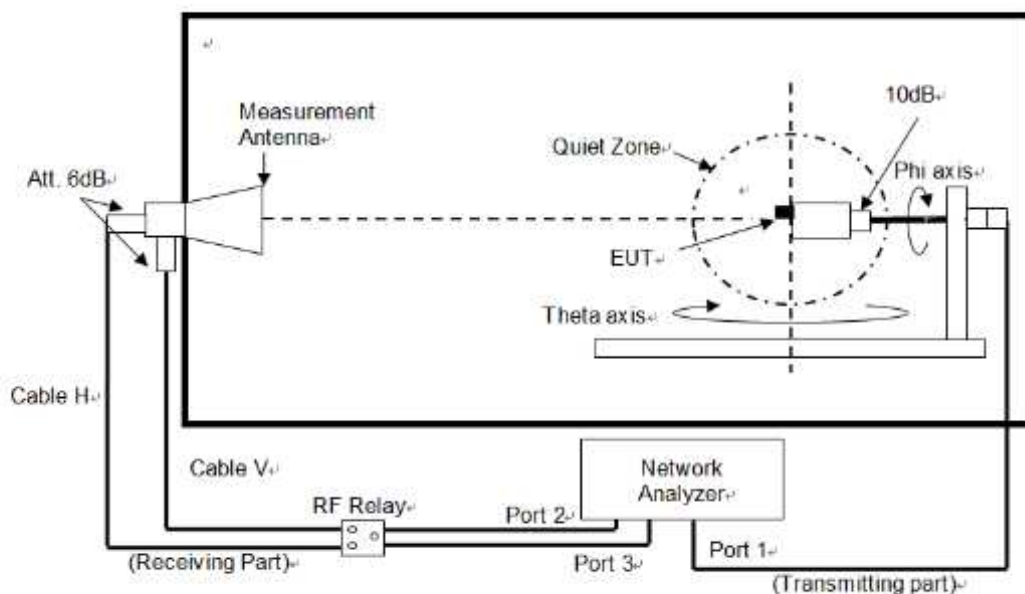

## b. Equipment list

Name	Manufacture	Type/Model	Serial Number	Cal. Date	Cal. Due Date
ENA Series Network Analyze	Keysight	E5071C	MY46108594	2021/8/3	2023/8/3
RF Switch	Keysight	3499A	MY4200955	NCR	NCR
Multi-Axis Positioner Controller	ETS-Lindgren	2090	N/A	NCR	NCR
Medium-Duty Positioner	ETS-Lindgren	2015	N/A	NCR	NCR
Measurement Horn Antenna	EMCO	Aug-64	86722	NCR	NCR
Measurement software	ETS-Lindgren	EM-Quest	1195	NCR	NCR

**3. Setup photo**

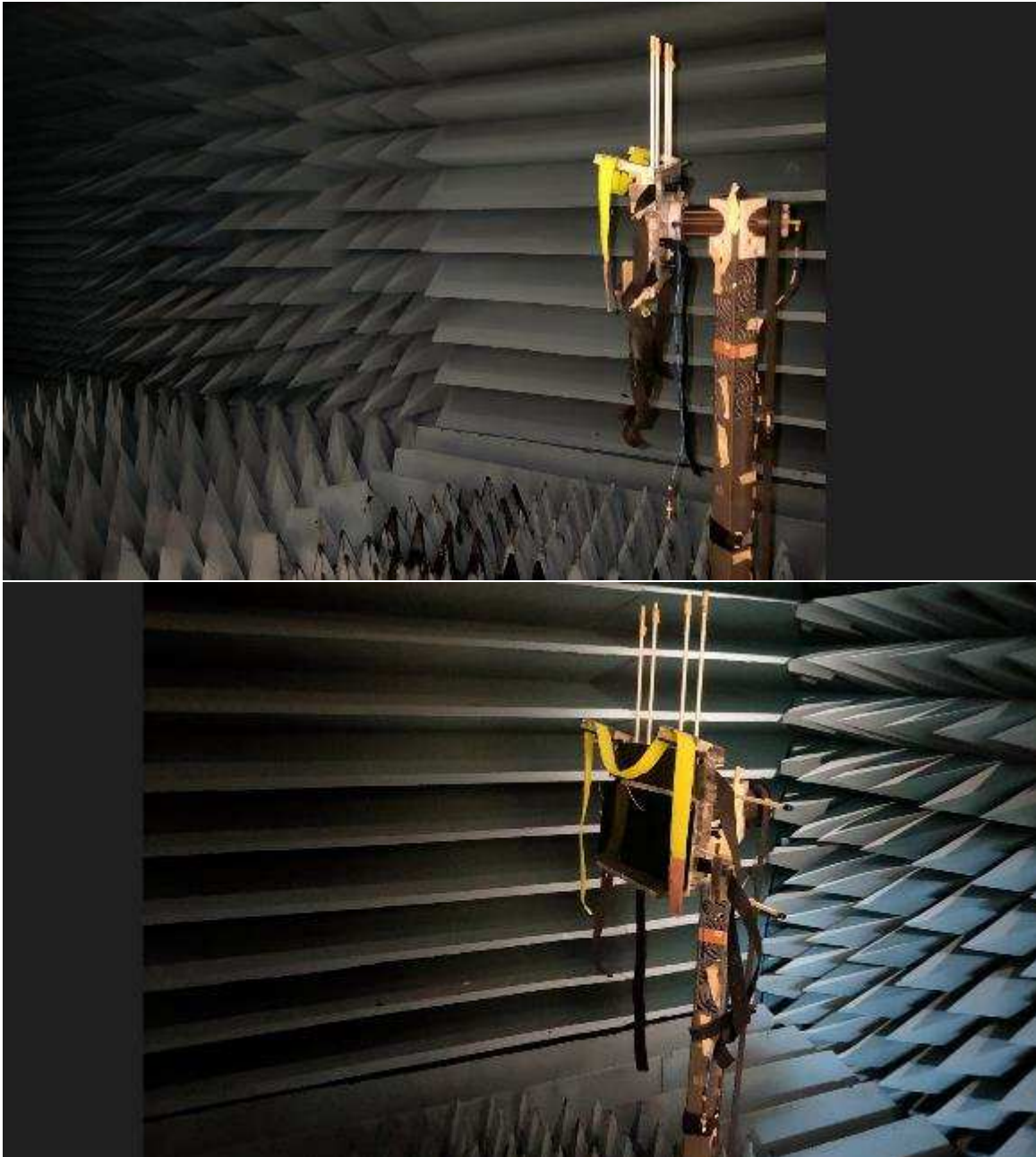

# Antenna Information

## Section 1. Antenna Assembly Specifications

1A Antenna Part Number	1B Manufacturer	1C Antenna Type	1D Cable Assembly Part Number and Information	Freq Range MHz	1E * Peak Gain W/ Cable loss (dBi)	1F Peak Gain w/o Cable Loss (dBi)	1G Max VSWR	1H Cable Loss (dB)
260-25094	Hong-Bo	PIFA	50 ohm Coaxial length: 300mm diameter: 1.13LLS  Connector type: MHF4L MHF-B13-N-01	2400-2483.5	3.53	4.27	2.5	0.74
				5150-5250	3.06	4.22	2.5	1.16
				5250-5350	3.07	4.25	2.5	1.18
				5470-5725	4.81	6.07	2.5	1.26
				5725-5850	4.2	5.48	2.5	1.28

Note: The individual antenna gain is by measurement as indicated in above table. For module transmitter supports MIMO and use same antenna at multiple antenna ports. The direction gain values shall follow section FCC KDB 662911 D01.

- 3D Antenna Peak Gain required being test in system basis.

Frequency MHz	Peak Gain (dBi)	Theta angle ( ° )	Phi angle ( ° )	Frequency MHz	Peak Gain (dBi)	Theta angle ( ° )	Phi angle ( ° )
2412	2.55	75	0	5320	3.03	120	255
2422	2.72	120	195	5350	3.07	120	255
2437	3.01	75	0	5470	4.81	120	255
2442	3.17	75	0	5500	4.53	120	255
2452	3.32	75	0	5725	4.09	135	270
2484	3.53	75	0	5785	4.2	135	270
5150	2.32	120	255	5805	4.15	135	270
5180	2.51	120	255	5850	4.07	135	270
5250	3.06	120	255				

## Section 2. Radiation characteristics of antenna loaded in Host Platform

### Main Antenna

#### Max Antenna 3D Radiation Pattern 2400 – 2484 MHz

Frequency (MHz)	Peak Gain w/ Cable Loss (dBi)	Theta angle (°)	Phi angle (°)
2400-2483.5	3.53	75	0

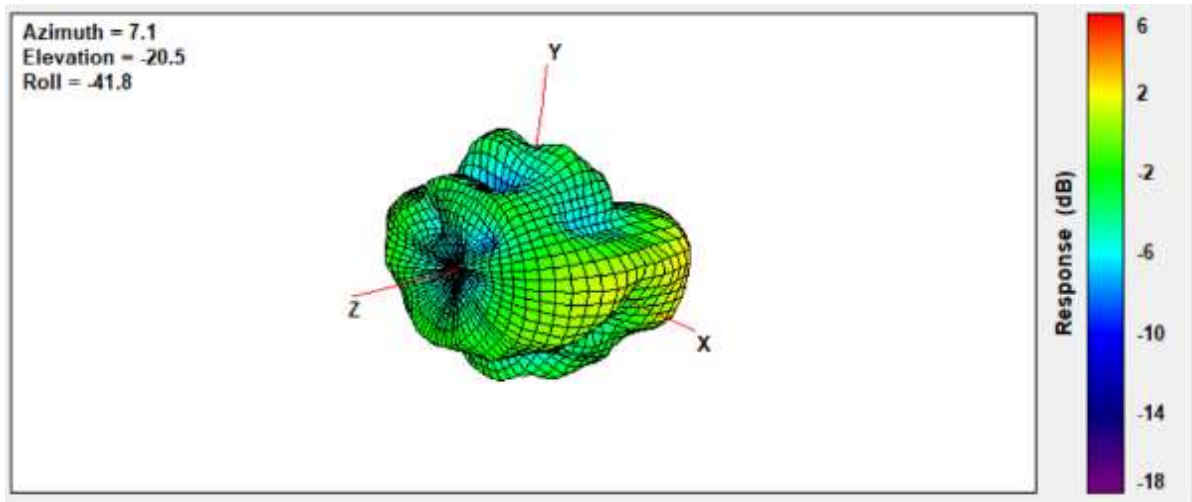

#### Max Antenna 3D Radiation Pattern 5150-5250 MHz

Frequency (MHz)	Peak Gain w/ Cable Loss (dBi)	Theta angle (°)	Phi angle (°)
5150-5250	3.06	120	255

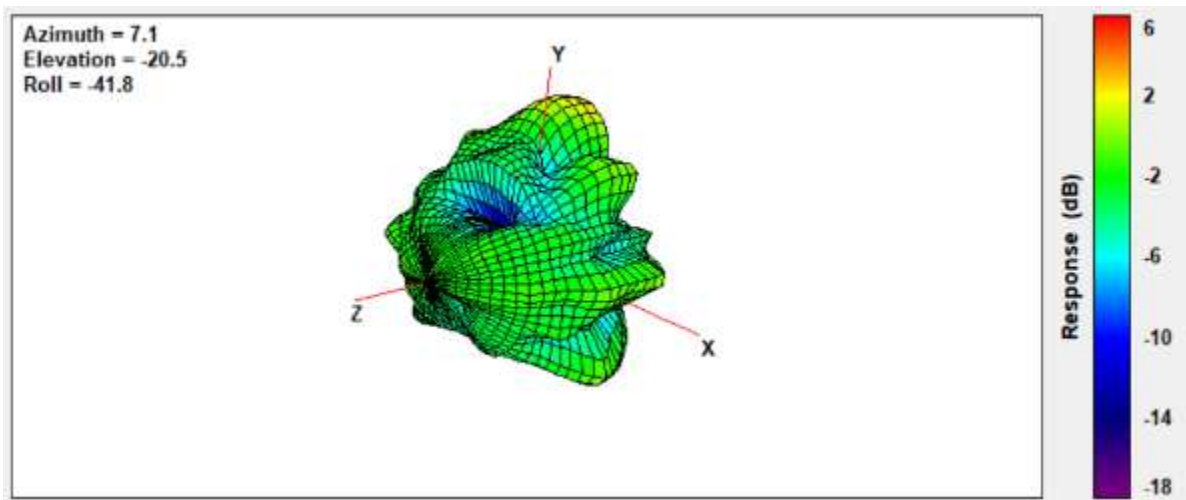

### Max Antenna 3D Radiation Pattern 5250-5350 MHz

Frequency (MHz)	Peak Gain w/ Cable Loss (dBi)	Theta angle (°)	Phi angle (°)
5250-5350	3.07	120	255

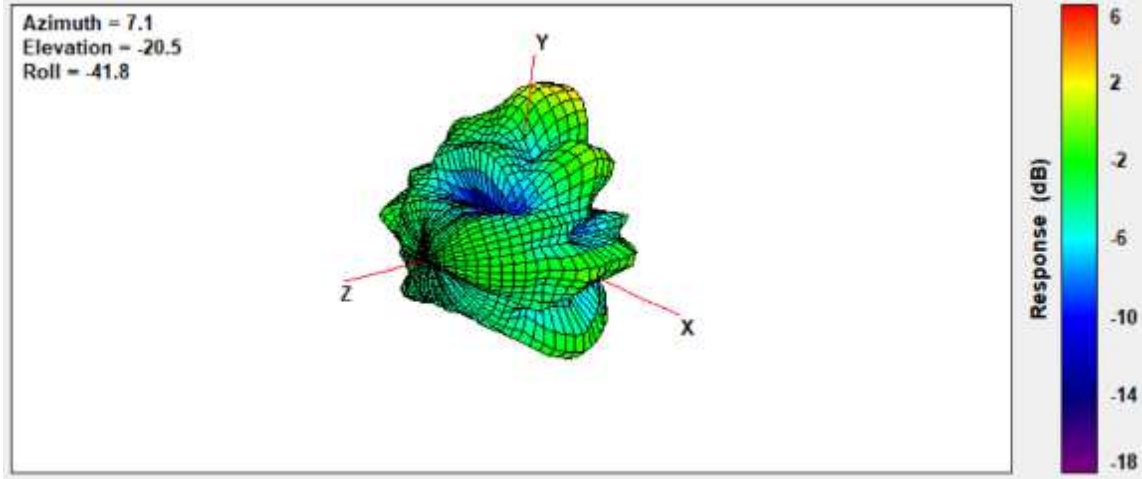

### Max Antenna 3D Radiation Pattern 5470-5725 MHz

Frequency (MHz)	Peak Gain w/ Cable Loss (dBi)	Theta angle (°)	Phi angle (°)
5470-5725	4.81	120	255

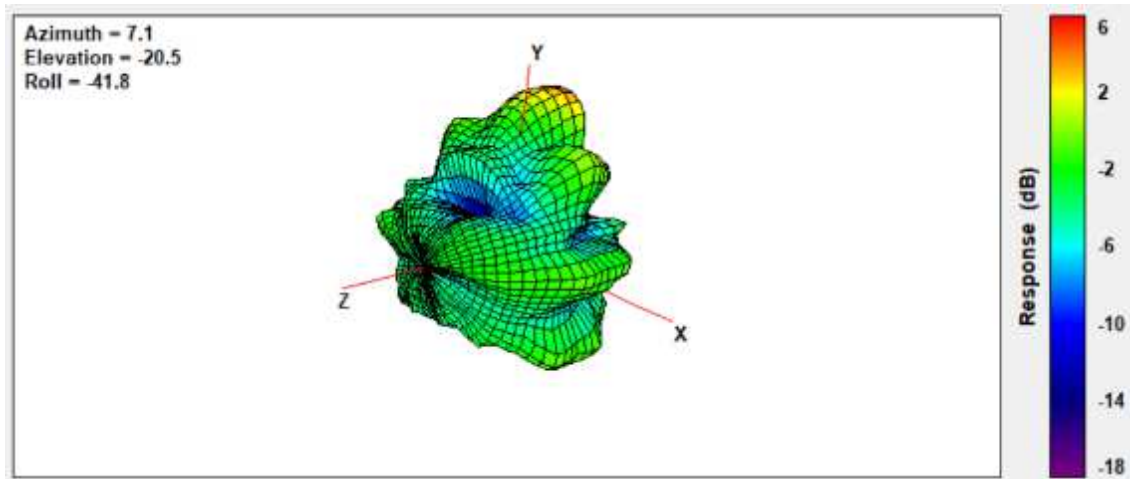



## Max Antenna 3D Radiation Pattern 5725-5850 MHz

Frequency (MHz)	Peak Gain w/ Cable Loss (dBi)	Theta angle (°)	Phi angle (°)
5725-5850	4.2	135	270

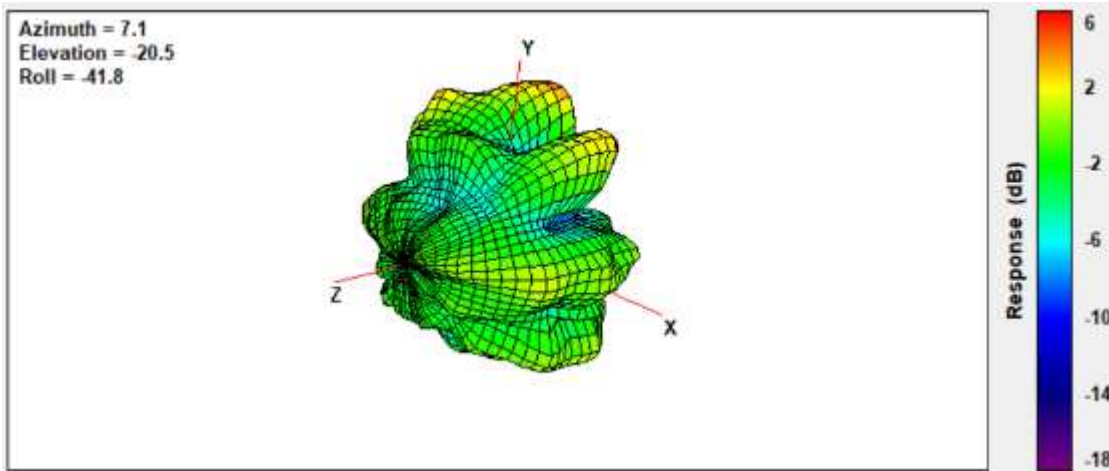

#### 4. Antenna information used for conformity with limits

This is a WIFI/BT typical antenna for modular manufacture regulatory testing purpose. The applicable limit is subjected to modular transmitter design/specification (i.e., SISO or MIMO etc.) and FCC Part 15 regulation. Detail of conformity limit to be described in module FCC test reports.