

TEST REPORT

CERTIFICATE OF CONFORMITY

Standard: 47 CFR FCC Part 15, Subpart E (Section 15.407)

Report No.: RFBWIN-WTW-P22110682-4

FCC ID: J9C-QCNCM865

Product: Qualcomm WiFi 7/BT Combo module

Brand: Qualcomm

Model No.: QCNCM865

Received Date: 2022/11/24

Test Date: 2022/12/19 ~ 2023/2/24

Issued Date: 2023/3/21

Applicant: Qualcomm Technologies, Inc.

Address: 5775 Morehouse Drive, San Diego, CA 92121-1714

Issued By: Bureau Veritas Consumer Products Services (H.K.) Ltd., Taoyuan Branch
Hsin Chu Laboratory

Lab Address: E-2, No.1, Li Hsin 1st Road, Hsinchu Science Park, Hsinchu City 300, Taiwan

Test Location: E-2, No.1, Li Hsin 1st Road, Hsinchu Science Park, Hsinchu City 300, Taiwan

FCC Registration / 723255 / TW2022

Designation Number:

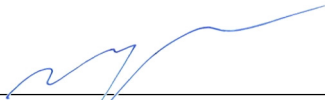
Approved by:  , **Date:** 2023/3/21

May Chen / Manager

This test report consists of 1257 pages in total. It may be duplicated completely for legal use with the approval of the applicant. It should not be reproduced except in full, without the written approval of our laboratory. The test results in the report only apply to the tested sample. The test results in this report are traceable to the national or international standards.

Prepared by : Vivian Huang / Specialist



Table of Contents

Release Control Record	4
1 Certificate	5
2 Summary of Test Results	6
2.1 Measurement Uncertainty	6
2.2 Supplementary Information	6
3 General Information	7
3.1 General Description of EUT	7
3.2 Antenna Description of EUT	9
3.3 Channel List	10
3.4 Test Mode Applicability and Tested Channel Detail	14
3.5 Duty Cycle of Test Signal	39
3.6 Test Program Used and Operation Descriptions	49
3.7 Connection Diagram of EUT and Peripheral Devices	49
3.8 Configuration of Peripheral Devices and Cable Connections	51
4 Test Instruments	52
4.1 RF Output Power	52
4.2 Power Spectral Density	52
4.3 Emission Bandwidth	52
4.4 In-Band Emission Mask	52
4.5 Occupied Bandwidth	52
4.6 Frequency Stability	53
4.7 Contention-based Protocol	53
4.8 AC Power Conducted Emissions	54
4.9 Unwanted Emissions below 1 GHz	55
4.10 Unwanted Emissions above 1 GHz	56
5 Limits of Test Items	57
5.1 RF Output Power	57
5.2 Power Spectral Density	57
5.3 Emission Bandwidth	57
5.4 In-Band Emission Mask	58
5.5 Occupied Bandwidth	58
5.6 Frequency Stability	58
5.7 Contention-based Protocol	58
5.8 AC Power Conducted Emissions	58
5.9 Unwanted Emissions below 1 GHz	59
5.10 Unwanted Emissions above 1 GHz	59
6 Test Arrangements	60
6.1 RF Output Power	60
6.1.1 Test Setup	60
6.1.2 Test Procedure	60
6.2 Power Spectral Density	60
6.2.1 Test Setup	60
6.2.2 Test Procedure	60
6.3 Emission Bandwidth	61
6.3.1 Test Setup	61
6.3.2 Test Procedure	61
6.4 In-Band Emission Mask	61
6.4.1 Test Setup	61
6.4.2 Test Procedure	61
6.5 Occupied Bandwidth	62
6.5.1 Test Setup	62
6.5.2 Test Procedure	62
6.6 Frequency Stability	62
6.6.1 Test Setup	62



6.6.2	Test Procedure.....	62
6.7	Contention-based Protocol.....	63
6.7.1	Test Setup.....	63
6.7.2	Test Procedure.....	63
6.8	AC Power Conducted Emissions.....	64
6.8.1	Test Setup.....	64
6.8.2	Test Procedure.....	64
6.9	Unwanted Emissions below 1 GHz.....	65
6.9.1	Test Setup.....	65
6.9.2	Test Procedure.....	66
6.10	Unwanted Emissions above 1 GHz.....	67
6.10.1	Test Setup.....	67
6.10.2	Test Procedure.....	68
7	Test Results of Test Item.....	69
7.1	RF Output Power.....	69
7.2	Power Spectral Density.....	104
7.3	Emission Bandwidth.....	141
7.4	In-Band Emission Mask.....	152
7.5	Occupied Bandwidth.....	204
7.6	Frequency Stability.....	215
7.7	Contention-based Protocol.....	216
7.8	AC Power Conducted Emissions.....	226
7.9	Unwanted Emissions below 1 GHz.....	228
7.10	Unwanted Emissions above 1 GHz.....	232
8	Operational Restrictions for 6 GHz U-NII Devices.....	1255
9	Pictures of Test Arrangements.....	1256
10	Information of the Testing Laboratories.....	1257



Release Control Record

Issue No.	Description	Date Issued
RFBWIN-WTW-P22110682-4	Original release.	2023/3/21

1 Certificate

Product: Qualcomm WiFi 7/BT Combo module

Brand: Qualcomm

Test Model: QCNCM865

Sample Status: Engineering sample

Applicant: Qualcomm Technologies, Inc.

Test Date: 2022/12/19 ~ 2023/2/24

Standard: 47 CFR FCC Part 15, Subpart E (Section 15.407)

Measurement ANSI C63.10-2013

procedure:

KDB 987594 D02 U-NII 6 GHz EMC Measurement v01v01

KDB 789033 D02 General UNII Test Procedure New Rules v02r01

KDB 662911 D01 Multiple Transmitter Output v02r01

The above equipment has been tested by **Bureau Veritas Consumer Products Services (H.K.) Ltd., Taoyuan Branch**, and found compliance with the requirement of the above standards. The test record, data evaluation & Equipment Under Test (EUT) configurations represented herein are true and accurate accounts of the measurements of the sample's RF characteristics under the conditions specified in this report.

2 Summary of Test Results

47 CFR FCC Part 15, Subpart E (Section 15.407)			
Clause	Test Item	Result	Remark
15.407(a)(7)(8)	RF Output Power	Pass	Meet the requirement of limit.
15.407(a)(7)(8)	Power Spectral Density	Pass	Meet the requirement of limit.
15.407(a)(10)	Occupied Bandwidth	Pass	Meet the requirement of limit.
15.407(b)(9)	AC Power Conducted Emissions	Pass	Minimum passing margin is -9.64 dB at 0.56791 MHz
15.407(b)(9)	Unwanted Emissions below 1 GHz	Pass	Minimum passing margin is -1.6 dB at 198.41 MHz
15.407(b)(6) 15.407(b)(10)	Unwanted Emissions above 1 GHz	Pass	Minimum passing margin is -12.9 dB at 11910.00 MHz
15.407(b)(7)	In-Band Emission Mask	Pass	Meet the requirement of limit.
15.407(d)(6)	Contention-based Protocol	Pass	Meet the requirement of limit.
15.407(g)	Frequency Stability	Pass	Meet the requirement of limit.
15.407(d)	Operational restrictions for 6 GHz U-NII devices	Pass	Declaration by applicant
15.203	Antenna Requirement	Pass	Antenna connector is MHF 4L not a standard connector.
---	Emission Bandwidth	-	Reference only.

Note: Determining compliance based on the results of the compliance measurement, not taking into account measurement instrumentation uncertainty.

2.1 Measurement Uncertainty

Where relevant, the following measurement uncertainty levels have been estimated for tests performed on the EUT as specified in CISPR 16-4-2:

Measurement	Specification	Expanded Uncertainty (k=2) (±)
AC Power Conducted Emissions	150 kHz ~ 30 MHz	1.9 dB
Unwanted Emissions below 1 GHz	9 kHz ~ 30 MHz	3.1 dB
	30 MHz ~ 1 GHz	5.1 dB
Unwanted Emissions above 1 GHz	1 GHz ~ 18 GHz	5.1 dB
	18 GHz ~ 40 GHz	5.3 dB

The other instruments specified are routine verified to remain within the calibrated levels, no measurement uncertainty is required to be calculated.

2.2 Supplementary Information

There is not any deviation from the test standards for the test method, and no modifications required for compliance.

3 General Information

3.1 General Description of EUT

Product	Qualcomm WiFi 7/BT Combo module
Brand	Qualcomm
Test Model	QCNCM865
Status of EUT	Engineering sample
Power Supply Rating	3.3Vdc from host equipment
Modulation Type	64QAM, 16QAM, QPSK, BPSK for OFDM 4096QAM for OFDMA in 11ax mode 4096QAM for OFDMA in 11be mode
Modulation Technology	OFDM, OFDMA
Transfer Rate	802.11a: up to 54Mbps 802.11ax: up to 2401.6Mbps 802.11be: up to 5764.8Mbps
Operating Frequency	Under control by Standard Power AP: 5.935 GHz ~ 6.415 GHz 6.535 GHz ~ 6.855 GHz Under control by Low-power Indoor AP: 5.935 GHz ~ 6.415 GHz 6.425 GHz ~ 6.525 GHz 6.535 GHz ~ 6.855 GHz 6.875 GHz ~ 7.115 GHz
Number of Channel	802.11a, 802.11ax (HE20), 802.11be (EHT20): 60 802.11ax (HE40), 802.11be (EHT40): 29 802.11ax (HE80), 802.11be (EHT80): 14 802.11ax (HE160), 802.11be (EHT160): 7 802.11be (EHT320): 6
Resource Unit (RU)	Single RU: 26-tone, 52-tone, 106-tone, 242-tone, 484-tone, 996-tone Multi-RU(Small RU): 52-tone + 26-tone, 106-tone + 26-tone Multi-RU (Large RU): 484-tone + 242-tone, 996-tone + 484-tone, 2 * 996-tone
Channel Puncturing (Large RU)	80 MHz punctured by 20 MHz, 160 MHz punctured by 20 MHz 160 MHz punctured by 40 MHz
Output Power	Under control by Standard Power AP: 5.935 GHz ~ 6.415 GHz : EIRP: 468.334 mW (26.71 dBm) 6.535 GHz ~ 6.855 GHz : EIRP: 435.201 mW (26.39 dBm) Under control by Low-power Indoor AP: 5.935 GHz ~ 6.415 GHz : EIRP: 100.008 mW (20 dBm) 6.425 GHz ~ 6.525 GHz : EIRP: 94.469 mW (19.75 dBm) 6.535 GHz ~ 6.855 GHz : EIRP: 91.663 mW (19.62 dBm) 6.875 GHz ~ 7.115 GHz : EIRP: 90.075 mW (19.55 dBm)
EUT Category	Client Device (controlled of an indoor AP) Client Device (controlled of an standard power AP)

Note:

1. There are Bluetooth and WLAN (2.4 GHz & 5 GHz & 5.9 GHz & 6 GHz) technology used for the EUT.
2. Simultaneously transmission condition.

DBS			
Condition	Technology		
1	WLAN(2.4GHz)_Ant 0+1	WLAN(5GHz)_Ant 0+1	
2	WLAN(2.4GHz)_Ant 0+1	WLAN(6GHz)_Ant 0+1	
HBS+BT			
Condition	Technology		
3	Bluetooth_Ant 0+1	WLAN(5GHz)_Ant 0+1	
4	Bluetooth_Ant 0+1	WLAN(6GHz)_Ant 0+1	
5	WLAN(5GHz_U-NII-1, U-NII-2A)_Ant 0+1	WLAN(5GHz_U-NII-2C, U-NII-3, U-NII-4)_Ant 0+1	Bluetooth
6	WLAN(5GHz_U-NII-1, U-NII-2A)_Ant 0+1	WLAN(6GHz)_Ant 0+1	Bluetooth

Note: The emission of the simultaneous operation has been evaluated and no non-compliance was found.

3. QCNCM865 has HW variant SKUs below to support different Microsoft Windows platform system and feature:

SKU	Support platform system and feature
NCM865	X86 platform, support DBS and HBS
NCM865A	Qualcomm platform, support DBS and HBS
NCM835	X86 platform, support DBS
NCM835A	Qualcomm platform, support DBS

Note: From the above SKUs, the worst was found in **SKU (NCM865)**. Therefore only the test data of the modes were recorded in this report.

4. The EUT support OFDMA and Partial RU mode, therefore partial RU combination were investigated and the worst case scenario was identified. (The worst case data were presented in section 3.4)
5. This device no support multiple 6E band simultaneously operation.
6. The above EUT information is declared by manufacturer and for more detailed features description, please refer to the manufacturer's specifications or user's manual.

3.2 Antenna Description of EUT

1. The antenna information is listed as below.

Antenna Set	RF Chain No.	Brand	Model	Antenna Net Gain (dBi)	Frequency Range	Cable Loss (dB)	Antenna Type	Connector Type	Cable Length
1	Chain0/1	Hong-Bo	260-25094	3.53	2.4~2.4835GHz	0.74	PIFA	MHF 4L	300mm
				3.06	5.15~5.25GHz	1.16			
				3.07	5.25~5.35GHz	1.18			
				4.81	5.47~5.725GHz	1.26			
				4.2	5.725~5.850GHz	1.28			
2	Chain0/1	Hong-Bo	260-25083	5.09	5.850~5.895 GHz	1.29	PIFA	MHF 4L	300mm
				5.14	5.925~6.425 GHz	1.35			
				5.09	6.425~6.525 GHz	1.38			
				5.16	6.525~6.875 GHz	1.45			
				5.12	6.875~7.125 GHz	1.50			
3	Chain0/1	Hong-Bo	260-25084	3.22	2.4~2.4835 GHz	0.49	Monopole	MHF 4L	200mm
				3.35	5.150~5.250 GHz	0.76			
				3.42	5.250~5.350 GHz	0.77			
				4.77	5.470~5.725 GHz	0.80			
				4.72	5.725~5.850 GHz	0.84			
				4.71	5.850~5.895 GHz	0.84			
				4.75	5.925~6.425 GHz	0.86			
				4.29	6.425~6.525 GHz	0.91			
				4.81	6.525~6.875 GHz	0.96			
				4.74	6.875~7.125 GHz	0.98			

* Detail antenna specification please refer to antenna datasheet and/or antenna measurement report.

2. The EUT incorporates a MIMO function:

6GHz Band		
MODULATION MODE	TX & RX CONFIGURATION	
802.11a	2TX	2RX
802.11ax (HE20)	2TX	2RX
802.11ax (HE40)	2TX	2RX
802.11ax (HE80)	2TX	2RX
802.11ax (HE160)	2TX	2RX
802.11be (EHT20)	2TX	2RX
802.11be (EHT40)	2TX	2RX
802.11be (EHT80)	2TX	2RX
802.11be (EHT160)	2TX	2RX
802.11be (EHT320)	2TX	2RX
802.11ax (RU26/52/106/242/484/996/996x2)	2TX	2RX
802.11be (RU26/52/106/242/484/996/996x2/996x4/ MRU52+26/106+26/484+242/ 996+484+242/ 996x2+484/996x3/ 996x3+484)	2TX	2RX

Note: The modulation and bandwidth are similar for 802.11ax/be mode for 20MHz (40MHz, 80MHz, 160MHz).

3.3 Channel List

U-NII-5: Under control of a Low-power Indoor AP and Standard Power AP

25 channels are provided for 802.11a, 802.11ax (HE20), 802.11be (EHT20):

Channel	Frequency	Channel	Frequency	Channel	Frequency	Channel	Frequency
2	5935 MHz	1	5955 MHz	5	5975 MHz	9	5995 MHz
13	6015 MHz	17	6035 MHz	21	6055 MHz	25	6075 MHz
29	6095 MHz	33	6115 MHz	37	6135 MHz	41	6155 MHz
45	6175 MHz	49	6195 MHz	53	6215 MHz	57	6235 MHz
61	6255 MHz	65	6275 MHz	69	6295 MHz	73	6315 MHz
77	6335 MHz	81	6355 MHz	85	6375 MHz	89	6395 MHz
93	6415 MHz						

12 channels are provided for 802.11ax (HE40), 802.11be (EHT40):

Channel	Frequency	Channel	Frequency	Channel	Frequency	Channel	Frequency
3	5965 MHz	11	6005 MHz	19	6045 MHz	27	6085 MHz
35	6125 MHz	43	6165 MHz	51	6205 MHz	59	6245 MHz
67	6285 MHz	75	6325 MHz	83	6365 MHz	91	6405 MHz

6 channels are provided for 802.11ax (HE80), 802.11be (EHT80):

Channel	Frequency	Channel	Frequency	Channel	Frequency	Channel	Frequency
7	5985 MHz	23	6065 MHz	39	6145 MHz	55	6225 MHz
71	6305 MHz	87	6385 MHz				

3 channels are provided for 802.11ax (HE160), 802.11be (EHT160):

Channel	Frequency	Channel	Frequency	Channel	Frequency
15	6025 MHz	47	6185 MHz	79	6345 MHz

2 channels are provided for 802.11be (EHT320):

Channel	Frequency	Channel	Frequency
31	6105 MHz	63	6265 MHz

U-NII-6: Under control of a Low-power Indoor AP

5 channels are provided for 802.11a, 802.11ax (HE20), 802.11be (EHT20):

Channel	Frequency	Channel	Frequency	Channel	Frequency	Channel	Frequency
97	6435 MHz	101	6455 MHz	105	6475 MHz	109	6495 MHz
113	6515 MHz						

3 channels are provided for 802.11ax (HE40), 802.11be (EHT40):

Channel	Frequency	Channel	Frequency	Channel	Frequency
99	6445 MHz	107	6485 MHz	*115	6525 MHz

1 channel is provided for 802.11ax (HE80), 802.11be (EHT80):

Channel	Frequency
103	6465 MHz

1 channel is provided for 802.11ax (HE160), 802.11be (EHT160):

Channel	Frequency
*111	6505 MHz

1 channels is provided for 802.11be (EHT320):

Channel	Frequency
95	6425 MHz

U-NII-7: Under control of a Low-power Indoor AP and Standard Power AP

17 channels are provided for 802.11a, 802.11ax (HE20), 802.11be (EHT20):

Channel	Frequency	Channel	Frequency	Channel	Frequency	Channel	Frequency
117	6535 MHz	121	6555 MHz	125	6575 MHz	129	6595 MHz
133	6615 MHz	137	6635 MHz	141	6655 MHz	145	6675 MHz
149	6695 MHz	153	6715 MHz	157	6735 MHz	161	6755 MHz
165	6775 MHz	169	6795 MHz	173	6815 MHz	177	6835 MHz
181	6855 MHz						

8 channels are provided for 802.11ax (HE40), 802.11be (EHT40):

Channel	Frequency	Channel	Frequency	Channel	Frequency	Channel	Frequency
123	6565 MHz	131	6605 MHz	139	6645 MHz	147	6685 MHz
155	6725 MHz	163	6765 MHz	171	6805 MHz	179	6845 MHz

5 channels are provided for 802.11ax (HE80), 802.11be (EHT80):

Channel	Frequency	Channel	Frequency	Channel	Frequency	Channel	Frequency
*119	6545 MHz	135	6625 MHz	151	6705 MHz	167	6785 MHz
*183	6865 MHz						

2 channels are provided for 802.11ax (HE160), 802.11be (EHT160):

Channel	Frequency	Channel	Frequency
143	6665 MHz	175	*6825 MHz

2 channels are provided for 802.11be (EHT320):

Channel	Frequency	Channel	Frequency
127	6585 MHz	159	6745 MHz

U-NII-8: Under control of a Low-power Indoor AP

13 channels are provided for 802.11a, 802.11ax (HE20), 802.11be (EHT20):

Channel	Frequency	Channel	Frequency	Channel	Frequency	Channel	Frequency
185	6875 MHz	189	6895 MHz	193	6915 MHz	197	6935 MHz
201	6955 MHz	205	6975 MHz	209	6995 MHz	213	7015 MHz
217	7035 MHz	221	7055 MHz	225	7075 MHz	229	7095 MHz
233	7115 MHz						

6 channels are provided for 802.11ax (HE40), 802.11be (EHT40):

Channel	Frequency	Channel	Frequency	Channel	Frequency	Channel	Frequency
187	6885 MHz	195	6925 MHz	203	6965 MHz	211	7005 MHz
219	7045 MHz	227	7085 MHz				

2 channels are provided for 802.11ax (HE80), 802.11be (EHT80):

Channel	Frequency	Channel	Frequency
199	6945 MHz	215	7025 MHz

1 channel is provided for 802.11ax (HE160), 802.11be (EHT160):

Channel	Frequency
207	6985 MHz

1 channels is provided for 802.11be (EHT320):

Channel	Frequency
191	6905 MHz

Note: * mean these are straddle channels and operating under control by Low-power indoor AP only.

3.4 Test Mode Applicability and Tested Channel Detail

Pre-Scan:	1. Pre-Scan has been conducted to determine the worst-case mode from all possible combinations between available modulations, data rates and antenna ports (if EUT with antenna diversity architecture).
-----------	--

Following channel(s) was (were) selected for the final test as listed below:

Test Item	EUT Configure Mode	Mode	Signal Mode	Category	Tested Channel	Modulation	Data Rate Parameter	RU/MRU Index				
Output power / Power Density	A	802.11a	CDD	Indoor client	2, 1, 45, 93	BPSK	6Mb/s	NA				
					97, 105, 113							
					117, 149, 181, 185							
					209, 233							
		802.11be (EHT20)	CDD		CDD	2, 1, 45, 93	BPSK		MCS0	NA		
						97, 105, 113						
						117, 149, 181, 185						
						209, 233						
		802.11be (EHT40)	CDD		CDD	3, 43, 91	BPSK		MCS0	NA		
						99, 107, 115						
						123, 155, 179						
						187, 211, 227						
		802.11be (EHT80)	CDD		CDD	7, 39, 87	BPSK		MCS0	NA		
						103						
						119, 151, 183						
		802.11be (EHT160)	CDD		CDD	15, 47, 79	BPSK		MCS0	NA		
						111,						
						143, 175						
		802.11be (EHT320)	CDD		CDD	207	BPSK		MCS0	NA		
						31, 63						
						95, 127						
									159, 191			

Output power / Power Density	A	802.11be (EHT20) 26-tone RU	CDD	Indoor client	2, 1, 45, 93	BPSK	MCS0	0, 0, 0, 8
					97, 105, 113			0, 0, 8
					117, 149, 181, 185			0, 0, 8, 8
					209, 233			0, 0, 8
		802.11be (EHT20) 52-tone RU	CDD		2, 1, 45, 93	BPSK	MCS0	37, 37, 37, 40
					97, 105, 113			37, 37, 40
					117, 149, 181, 185			37, 37, 40, 40
					209, 233			37, 37, 40
		802.11be (EHT20) 106-tone RU	CDD		2, 1, 45, 93	BPSK	MCS0	53, 53, 53, 54
					97, 105, 113			53, 53, 54
					117, 149, 181, 185			53, 53, 54, 54
					209, 233			53, 53, 54
		802.11be (EHT20) 242-tone RU	CDD		2, 1, 45, 93	BPSK	MCS0	NA
					97, 105, 113			
					117, 149, 181, 185			
					209, 233			
		802.11be (EHT40) 484-tone RU	CDD		3, 43, 91	BPSK	MCS0	NA
					99, 107, 115			
					123, 155, 179			
					187, 211, 227			
		802.11be (EHT80) 996-tone RU	CDD		7, 39, 87	BPSK	MCS0	NA
					103			
					119, 151, 183			
		802.11be (EHT160) 2x996-tone RU	CDD		15, 47, 79	BPSK	MCS0	NA
					111			
					143, 175			
					207			
		802.11be (EHT20) 52+26-tone MRU	CDD		45	BPSK	MCS0	UL_RU52+26_Low_70_MCS0
105	UL_RU52+26_High_72_MCS0							
185	UL_RU52+26_Low_70_MCS0							
209	UL_RU52+26_High_72_MCS0							

Output power / Power Density	A	802.11be (EHT20) 106+26-tone MRU	CDD	Indoor client	45	BPSK	MCS0	UL_RU106+26_Low_82_MCS0
					105			UL_RU106+26_High_83_MCS0
					185			UL_RU106+26_Low_82_MCS0
					209			UL_RU106+26_High_83_MCS0
		802.11be (EHT80) 484+242-tone MRU	CDD		7	BPSK	MCS0	UL_RU484+242_Punc20_91_MCS0
					103			
					119			
					199			
		802.11be (EHT160) 996+484-tone MRU	CDD		47	BPSK	MCS0	UL_RU996+484_Low_MCS0 UL_RU996+484_Punc40_MCS0
					111			
					143			
					207			
		802.11be (EHT320) 2x996+484-tone MRU	CDD		63	BPSK	MCS0	UL_RU996x2+484_Punc40_MCS0
					159			
191								
802.11be (EHT320) 3x996-tone MRU	CDD	63	BPSK	MCS0	UL_RU996x3_Low_MCS0			
		159						
		191						
802.11be (EHT320) 3x996+484-tone MRU	CDD	63	BPSK	MCS0	UL_RU996x3+484_Low_MCS0			
		159						
		191						
802.11be (EHT80) Punctured by 20 MHz	CDD	7	BPSK	MCS0	EHT80_SU_Punct20_Mid2			
		103, 119						
		199						
802.11be (EHT160) Punctured by 20 MHz	CDD	47	BPSK	MCS0	EHT160_SU_Punct20_High			
		111						
		143						
		207						
802.11be (EHT160) Punctured by 40 MHz	CDD	47	BPSK	MCS0	EHT160_SU_Punct40_Mid2			
		111						
		143						
		207						
802.11be (EHT320) Punctured by 40 MHz	CDD	63	BPSK	MCS0	EHT320_SU_Punct40_Mid2			
		159						
		191						
802.11be (EHT320) Punctured by 80 MHz	CDD	63	BPSK	MCS0	EHT320_SU_Punct80_Mid2			
		159						
		191						
802.11be (EHT320) Punctured by 80+40 MHz	CDD	63	BPSK	MCS0	EHT320_SU_Punct120_Mid			
		159						
		191						

Output power / Power Density	C	802.11a	CDD	Outdoor client	2, 1, 45, 93	BPSK	6Mb/s	NA
					117, 149, 181			
		802.11be (EHT20)	CDD		2, 1, 45, 93	BPSK	MCS0	NA
					117, 149, 181			
		802.11be (EHT40)	CDD		3, 43, 91	BPSK	MCS0	NA
					123, 155, 179			
		802.11be (EHT80)	CDD		7, 39, 87	BPSK	MCS0	NA
					135, 151, 167			
		802.11be (EHT160)	CDD		15, 47, 79	BPSK	MCS0	NA
					143			
		802.11be (EHT320)	CDD		31, 63	BPSK	MCS0	NA
		802.11be (EHT20) 26-tone RU	CDD		2, 1, 45, 93	BPSK	MCS0	0, 0, 0, 8
					117, 149, 181			0, 0, 8, 8
		802.11be (EHT20) 52-tone RU	CDD		2, 1, 45, 93	BPSK	MCS0	37, 37, 37, 40
					117, 149, 181			37, 37, 40, 40
		802.11be (EHT20) 106-tone RU	CDD		2, 1, 45, 93	BPSK	MCS0	53, 53, 53, 54
					117, 149, 181			53, 53, 54, 54
		802.11be (EHT20) 242-tone RU	CDD		1	BPSK	MCS0	NA
					117			
		802.11be (EHT40) 484-tone RU	CDD		3	BPSK	MCS0	NA
123								
802.11be (EHT80) 996-tone RU	CDD	7	BPSK	MCS0	NA			
		135						
802.11be (EHT160) 2x996-tone RU	CDD	15	BPSK	MCS0	NA			
		143						
802.11be (EHT20) 52+26-tone MRU	CDD	1	BPSK	MCS0	UL_RU52+26_Low_70_MCS0			
		117			UL_RU52+26_High_72_MCS0			

Output power / Power Density	C	802.11be (EHT20) 106+26-tone MRU	CDD	Outdoor client	1	BPSK	MCS0	UL_RU106+26_Low_82_MCS0
					117			UL_RU106+26_High_83_MCS0
		802.11be (EHT80) 484+242-tone MRU	CDD		7	BPSK	MCS0	UL_RU484+242_Punc20_91_MCS0
					135			
		802.11be (EHT160) 996+484-tone MRU	CDD		15	BPSK	MCS0	UL_RU996+484_Punc40_MCS0
					143			
		802.11be (EHT320) 2x996+484-tone MRU	CDD		31	BPSK	MCS0	UL_RU996x2+484_Low_MCS0
		802.11be (EHT320) 3x996-tone MRU	CDD		31	BPSK	MCS0	UL_RU996x3_Low_MCS0
		802.11be (EHT320) 3x996+484-tone MRU	CDD		31	BPSK	MCS0	UL_RU996x3+484_Low_MCS0
		802.11be (EHT80) Punctured by 20 MHz	CDD		7	BPSK	MCS0	EHT80_SU_Punct20_Mid2
					135			
		802.11be (EHT160) Punctured by 20 MHz	CDD		15	BPSK	MCS0	EHT160_SU_Punct20_High
					143			
802.11be (EHT160) Punctured by 40 MHz	CDD	15	BPSK	MCS0	EHT160_SU_Punct40_High			
		143						
802.11be (EHT320) Punctured by 40 MHz	CDD	31	BPSK	MCS0	EHT320_SU_Punct40_Mid2			
802.11be (EHT320) Punctured by 80 MHz	CDD	31	BPSK	MCS0	EHT320_SU_Punct80_Mid2			
802.11be (EHT320) Punctured by 80+40 MHz	CDD	31	BPSK	MCS0	EHT320_SU_Punct120_Mid			

Output power	E	802.11be (EHT20)	CDD	Indoor client	2, 1, 45, 93	BPSK	MCS0	NA
					97, 105, 113			
					117, 149, 181, 185			
					209, 233			
		802.11be (EHT40)	CDD		3, 43, 91	BPSK	MCS0	NA
					99, 107, 115			
					123, 155, 179			
					187, 211, 227			
		802.11be (EHT80)	CDD		7, 39, 87	BPSK	MCS0	NA
					103			
					119, 151, 183			
					199, 215			
		802.11be (EHT160)	CDD		15, 47, 79	BPSK	MCS0	NA
					111,			
					143, 175			
					207			
		802.11be (EHT320)	CDD		31, 63	BPSK	MCS0	NA
					95, 127			
					159, 191			
		802.11be (EHT20) 26-tone RU	CDD		2, 1, 45, 93	BPSK	MCS0	0, 0, 0, 8
					97, 105, 113			0, 0, 8
					117, 149, 181, 185			0, 0, 8, 8
					209, 233			0, 0, 8
		802.11be (EHT20) 52-tone RU	CDD		2, 1, 45, 93	BPSK	MCS0	37, 37, 37, 40
					97, 105, 113			37, 37, 40
					117, 149, 181, 185			37, 37, 40, 40
					209, 233			37, 37, 40
		802.11be (EHT20) 106-tone RU	CDD		2, 1, 45, 93	BPSK	MCS0	53, 53, 53, 54
97, 105, 113	53, 53, 54							
117, 149, 181, 185	53, 53, 54, 54							
209, 233	53, 53, 54							

Output power	E	802.11be (EHT20) 242-tone RU	CDD	Indoor client	2, 1, 45, 93	BPSK	MCS0	NA
					97, 105, 113			
					117, 149, 181, 185			
					209, 233			
		802.11be (EHT40) 484-tone RU	CDD		3, 43, 91	BPSK	MCS0	NA
					99, 107, 115			
					123, 155, 179			
		802.11be (EHT80) 996-tone RU	CDD		187, 211, 227	BPSK	MCS0	NA
					7, 39, 87			
					103			
		802.11be (EHT160) 2x996-tone RU	CDD		119, 151, 183	BPSK	MCS0	NA
					199, 215			
					15, 47, 79			
		802.11be (EHT160) 2x996-tone RU	CDD		111	BPSK	MCS0	NA
					143, 175			
					207			
		802.11be (EHT20) 52+26-tone MRU	CDD		45	BPSK	MCS0	UL_RU52+26_Low_70_MCS0
					105			UL_RU52+26_High_72_MCS0
					185			UL_RU52+26_Low_70_MCS0
					209			UL_RU52+26_High_72_MCS0
802.11be (EHT20) 106+26-tone MRU	CDD	45	BPSK	MCS0	UL_RU106+26_Low_82_MCS0			
		105			UL_RU106+26_High_83_MCS0			
		185			UL_RU106+26_Low_82_MCS0			
		209			UL_RU106+26_High_83_MCS0			
802.11be (EHT80) 484+242-tone MRU	CDD	7	BPSK	MCS0	UL_RU484+242_Punc20_91_MCS0			
		103						
		119						
		199						
802.11be (EHT160) 996+484-tone MRU	CDD	47	BPSK	MCS0	UL_RU996+484_Low_MCS0 UL_RU996+484_Punc40_MCS0			
		111						
		143						
		207						
802.11be (EHT320) 2x996+484-tone MRU	CDD	63	BPSK	MCS0	UL_RU996x2+484_Punc40_MCS0			
		159						
		191						
802.11be (EHT320) 3x996-tone MRU	CDD	63	BPSK	MCS0	UL_RU996x3_Low_MCS0			
		159						
		191						



Output power	E	802.11be (EHT320) 3x996+484-tone MRU	CDD	Indoor client	63	BPSK	MCS0	UL_RU996x3+484_Low_MCS0
					159			
					191			
		802.11be (EHT80) Punctured by 20 MHz	CDD		7	BPSK	MCS0	EHT80_SU_Punct20_Mid2
					103,			
					119			
					199			
		802.11be (EHT160) Punctured by 20 MHz	CDD		47	BPSK	MCS0	EHT160_SU_Punct20_High
					111			
					143			
					207			
		802.11be (EHT160) Punctured by 40 MHz	CDD		47	BPSK	MCS0	EHT160_SU_Punct40_Mid2
					111			
					143			
					207			
		802.11be (EHT320) Punctured by 40 MHz	CDD		63	BPSK	MCS0	EHT320_SU_Punct40_Mid2
					159			
					191			
		802.11be (EHT320) Punctured by 80 MHz	CDD		63	BPSK	MCS0	EHT320_SU_Punct80_Mid2
					159			
					191			
802.11be (EHT320) Punctured by 80+40 MHz	CDD	63	BPSK	MCS0	EHT320_SU_Punct120_Mid			
		159						
		191						

Emission Bandwidth	A	802.11a	CDD	Indoor client	2, 1, 45, 93	BPSK	6Mb/s	NA
					97, 105, 113			
					117, 149, 181, 185			
					209, 233			
		802.11be (EHT20)	CDD		2, 1, 45, 93	BPSK	MCS0	NA
					97, 105, 113			
					117, 149, 181, 185			
					209, 233			
		802.11be (EHT40)	CDD		3, 43, 91	BPSK	MCS0	NA
					99, 107, 115			
					123, 155, 179			
					187, 211, 227			
		802.11be (EHT80)	CDD		7, 39, 87	BPSK	MCS0	NA
					103,			
					119, 151, 183			
					199, 215			
		802.11be (EHT160)	CDD		15, 47, 79	BPSK	MCS0	NA
					111,			
					143, 175			
					207			

Emission Bandwidth	A	802.11be (EHT320)	CDD	Indoor client	31, 63	BPSK	MCS0	NA		
					95, 127					
		802.11be (EHT20) 26-tone RU	CDD		159, 191	BPSK	MCS0	2, 1, 45, 93	MCS0	0, 0, 0, 8
					97, 105, 113			0, 0, 8		
					117, 149, 181, 185			0, 0, 8, 8		
					209, 233			0, 0, 8		
		802.11be (EHT20) 52-tone RU	CDD		2, 1, 45, 93	BPSK	MCS0	37, 37, 37, 40		
					97, 105, 113			37, 37, 40		
					117, 149, 181, 185			37, 37, 40, 40		
					209, 233			37, 37, 40		
		802.11be (EHT20) 106-tone RU	CDD		2, 1, 45, 93	BPSK	MCS0	53, 53, 53, 54		
					97, 105, 113			53, 53, 54		
					117, 149, 181, 185			53, 53, 54, 54		
					209, 233			53, 53, 54		

Emission Bandwidth	C	802.11a	CDD	Outdoor client	2, 1, 45, 93	BPSK	6Mb/s	NA
					117, 149, 181			
		802.11be (EHT20)	CDD		2, 1, 45, 93	BPSK	MCS0	NA
					117, 149, 181			
		802.11be (EHT40)	CDD		3, 43, 91	BPSK	MCS0	NA
					123, 155, 179,			
		802.11be (EHT80)	CDD		7, 39, 87	BPSK	MCS0	NA
					135, 151, 167			
		802.11be (EHT160)	CDD		15, 47, 79	BPSK	MCS0	NA
					143			
		802.11be (EHT320)	CDD		31, 63	BPSK	MCS0	NA
		802.11be (EHT20) 26-tone RU	CDD		2, 1, 45, 93	BPSK	MCS0	0, 0, 0, 8
					117, 149, 181			0, 0, 8, 8
		802.11be (EHT20) 52-tone RU	CDD		2, 1, 45, 93	BPSK	MCS0	37, 37, 37, 40
					117, 149, 181			37, 37, 40, 40
		802.11be (EHT20) 106-tone RU	CDD		2, 1, 45, 93	BPSK	MCS0	53, 53, 53, 54
117, 149, 181	53, 53, 54, 54							



In-Band Emission Mask	A	802.11a	CDD	Indoor client	2, 1, 45, 93	BPSK	6Mb/s	NA
					97, 105, 113			
					117, 149, 181, 185			
					209, 233			
		802.11be (EHT20)	CDD		2, 1, 45, 93	BPSK	MCS0	NA
					97, 105, 113			
					117, 149, 181, 185			
					209, 233			
		802.11be (EHT40)	CDD		3, 43, 91	BPSK	MCS0	NA
					99, 107, 115			
					115, 123, 155, 179			
					187, 211, 227			
		802.11be (EHT80)	CDD		7, 39, 87	BPSK	MCS0	NA
					103			
					119, 151, 183			
					199, 215			
		802.11be (EHT160)	CDD		15, 47, 79	BPSK	MCS0	NA
					111			
					143, 175			
					207			

In-Band Emission Mask	A	802.11be (EHT320)	CDD	Indoor client	31, 63	BPSK	MCS0	NA
					95, 127			
					159, 191			
		802.11be (EHT20) 26-tone RU	CDD		2, 1, 45, 93	BPSK	MCS0	0, 0, 0, 8
					97, 105, 113			0, 0, 8
					117, 149, 181, 185			0, 0, 8, 8
					209, 233			0, 0, 8
		802.11be (EHT20) 52-tone RU	CDD		2, 1, 45, 93	BPSK	MCS0	37, 37, 37, 40
					97, 105, 113			37, 37, 40
					117, 149, 181, 185			37, 37, 40, 40
					209, 233			37, 37, 40
		802.11be (EHT20) 106-tone RU	CDD		2, 1, 45, 93	BPSK	MCS0	53, 53, 53, 54
					97, 105, 113			53, 53, 54
					117, 149, 181, 185			53, 53, 54, 54
					209, 233			53, 53, 54

In-Band Emission Mask	C	802.11a	CDD	Outdoor client	2, 1, 45, 93	BPSK	6Mb/s	NA
					117, 149, 181			
		802.11be (EHT20)	CDD		2, 1, 45, 93	BPSK	MCS0	NA
					117, 149, 181			
		802.11be (EHT40)	CDD		3, 43, 91	BPSK	MCS0	NA
					123, 155, 179			
		802.11be (EHT80)	CDD		7, 39, 87	BPSK	MCS0	NA
					135, 151, 167			
		802.11be (EHT160)	CDD		15, 47, 79	BPSK	MCS0	NA
					143			
		802.11be (EHT320)	CDD		31, 63	BPSK	MCS0	NA
		802.11be (EHT20) 26-tone RU	CDD		2, 1, 45, 93	BPSK	MCS0	0, 0, 0, 8
					117, 149, 181			0, 0, 8, 8
		802.11be (EHT20) 52-tone RU	CDD		2, 1, 45, 93	BPSK	MCS0	37, 37, 37, 40
					117, 149, 181			37, 37, 40, 40
		802.11be (EHT20) 106-tone RU	CDD		2, 1, 45, 93	BPSK	MCS0	53, 53, 53, 54
117, 149, 181	53, 53, 54, 54							



Occupied Bandwidth	A	802.11a	CDD	Indoor client	2, 1, 45, 93	BPSK	6Mb/s	NA
					97, 105, 113			
					117, 149, 181, 185			
					209, 233			
		802.11be (EHT20)	CDD		2, 1, 45, 93	BPSK	MCS0	NA
					97, 105, 113			
					117, 149, 181, 185			
					209, 233			
		802.11be (EHT40)	CDD		3, 43, 91	BPSK	MCS0	NA
					99, 107, 115			
					115, 123, 155, 179			
					187, 211, 227			
		802.11be (EHT80)	CDD		7, 39, 87	BPSK	MCS0	NA
					103			
					119, 151, 183			
					199, 215			
		802.11be (EHT160)	CDD		15, 47, 79	BPSK	MCS0	NA
					111,			
					143, 175			
					207			

Occupied Bandwidth	A	802.11be (EHT320)	CDD	Indoor client	31, 63	BPSK	MCS0	NA
					95, 127			
					159, 191			
		802.11be (EHT20) 26-tone RU	CDD		2, 1, 45, 93	BPSK	MCS0	0, 0, 0, 8
	97, 105, 113				0, 0, 8			
	117, 149, 181, 185				0, 0, 8, 8			
	209, 233				0, 0, 8			
	802.11be (EHT20) 52-tone RU	CDD	2, 1, 45, 93		BPSK	MCS0	37, 37, 37, 40	
			97, 105, 113				37, 37, 40	
			117, 149, 181, 185				37, 37, 40, 40	
			209, 233				37, 37, 40	
	802.11be (EHT20) 106-tone RU	CDD	2, 1, 45, 93		BPSK	MCS0	53, 53, 53, 54	
			97, 105, 113				53, 53, 54	
			117, 149, 181, 185				53, 53, 54, 54	
			209, 233				53, 53, 54	

Occupied Bandwidth	C	802.11a	CDD	Outdoor client	2, 1, 45, 93	BPSK	6Mb/s	NA
					117, 149, 181			
		802.11be (EHT20)	CDD		2, 1, 45, 93	BPSK	MCS0	NA
					117, 149, 181			
		802.11be (EHT40)	CDD		3, 43, 91	BPSK	MCS0	NA
					123, 155, 179			
		802.11be (EHT80)	CDD		7, 39, 87	BPSK	MCS0	NA
					135, 151, 167			
		802.11be (EHT160)	CDD		15, 47, 79	BPSK	MCS0	NA
					143			
		802.11be (EHT320)	CDD		31, 63	BPSK	MCS0	NA
		802.11be (EHT20) 26-tone RU	CDD		2, 1, 45, 93	BPSK	MCS0	0, 0, 0, 8
					117, 149, 181			0, 0, 8, 8
		802.11be (EHT20) 52-tone RU	CDD		2, 1, 45, 93	BPSK	MCS0	37, 37, 37, 40
					117, 149, 181			37, 37, 40, 40
		802.11be (EHT20) 106-tone RU	CDD		2, 1, 45, 93	BPSK	MCS0	53, 53, 53, 54
117, 149, 181	53, 53, 54, 54							
Frequency Stability	A	802.11a	-	-	1	un-modulation	-	-

Contention-based Protocol	A	802.11be (HE20)	-	Indoor client	1	BPSK	MCS0	NA
					97			
					117			
					193			
A	802.11be (EHT320)	-	Indoor client	31	BPSK	MCS0	NA	
				95				
				159				
AC Power Conducted Emissions	B	802.11be (EHT20)	CDD	Indoor client	45	BPSK	MCS0	-
Unwanted Emissions below 1 GHz	C, D	802.11be (EHT20)	CDD	Outdoor client	45	BPSK	MCS0	-



Unwanted Emissions above 1 GHz	A, B	802.11a	CDD	Indoor client	2, 1, 45, 93	BPSK	6Mb/s	NA
					97, 105, 113			
					117, 149, 181, 185			
					209, 233			
		802.11be (EHT20)	CDD		2, 1, 45, 93	BPSK	MCS0	NA
			97, 105, 113					
			117, 149, 181, 185					
			209, 233					
		802.11be (EHT40)	CDD		3, 43, 91	BPSK	MCS0	NA
			99, 107, 115					
			115, 123, 155, 179					
			187, 211, 227					
		802.11be (EHT80)	CDD		7, 39, 87	BPSK	MCS0	NA
			103					
			119, 151, 183					
			199, 215					
	802.11be (EHT160)	CDD	15, 47, 79	BPSK	MCS0	NA		
		111						
		143, 175						
		207						

Unwanted Emissions above 1 GHz	A, B	802.11be (EHT320)	CDD	Indoor client	31, 63	BPSK	MCS0	NA
					95, 127			
					159, 191			
		802.11be (EHT20) 26-tone RU	CDD		2, 1, 45, 93	BPSK	MCS0	0, 0, 0, 8
					97, 105, 113			0, 0, 8
					117, 149, 181, 185			0, 0, 8, 8
					209, 233			0, 0, 8
		802.11be (EHT20) 52-tone RU	CDD		2, 1, 45, 93	BPSK	MCS0	37, 37, 37, 40
	97, 105, 113			37, 37, 40				
	117, 149, 181, 185			37, 37, 40, 40				
	209, 233			37, 37, 40				
	802.11be (EHT20) 106-tone RU	CDD	2, 1, 45, 93	BPSK	MCS0	53, 53, 53, 54		
			97, 105, 113			53, 53, 54		
			117, 149, 181, 185			53, 53, 54, 54		
			209, 233			53, 53, 54		

Unwanted Emissions above 1 GHz	A, B	802.11be (EHT20) 242-tone RU	CDD	Indoor client	2, 1, 45, 93	BPSK	MCS0	NA
					97, 105, 113			
					117, 149, 181, 185			
					209, 233			
		802.11be (EHT40) 484-tone RU	CDD		3, 43, 91	BPSK	MCS0	NA
					99, 107, 115			
					123, 155, 179, 187, 211, 227			
		802.11be (EHT80) 996-tone RU	CDD		7, 39, 87	BPSK	MCS0	NA
					103			
					119, 151, 183, 199, 215			
		802.11be (EHT160) 2x996-tone RU	CDD		15, 47, 79	BPSK	MCS0	NA
					111			
					143, 175, 207			
		802.11be (EHT20) 52+26-tone MRU	CDD		45	BPSK	MCS0	UL_RU52+26_Low_70_MCS0
					105			UL_RU52+26_High_72_MCS0
					185			UL_RU52+26_Low_70_MCS0
					209			UL_RU52+26_High_72_MCS0
		802.11be (EHT20) 106+26-tone MRU	CDD		45	BPSK	MCS0	UL_RU106+26_Low_82_MCS0
					105			UL_RU106+26_High_83_MCS0
					185			UL_RU106+26_Low_82_MCS0
209	UL_RU106+26_High_83_MCS0							
802.11be (EHT80) 484+242-tone MRU	CDD	7	BPSK	MCS0	UL_RU484+242_Punc20_91_MCS0			
		103						
		119						
		199						
802.11be (EHT160) 996+484-tone MRU	CDD	47	BPSK	MCS0	UL_RU996+484_Punc40_MCS0			
		111						
		143						
		207						
802.11be (EHT320) 2x996+484-tone MRU	CDD	63	BPSK	MCS0	UL_RU996x2+484_Low_MCS0			
		159						
		191						
802.11be (EHT320) 3x996-tone MRU	CDD	63	BPSK	MCS0	UL_RU996x3_Low_MCS0			
		159						
		191						

Unwanted Emissions above 1 GHz	A, B	802.11be (EHT320) 3x996+484-tone MRU	CDD	Indoor client	63	BPSK	MCS0	UL_RU996x3+484_Low_MCS0		
					159					
					191					
		802.11be (EHT80) Punctured by 20 MHz	CDD		802.11be (EHT160) Punctured by 20 MHz	CDD	7	BPSK	MCS0	EHT80_SU_Punct20_Mid2
							103			
							119			
							199			
		802.11be (EHT160) Punctured by 20 MHz	CDD		802.11be (EHT160) Punctured by 40 MHz	CDD	47	BPSK	MCS0	EHT160_SU_Punct20_High
							111			
	143									
	207									
	802.11be (EHT160) Punctured by 40 MHz	CDD	802.11be (EHT320) Punctured by 40 MHz		CDD	47	BPSK	MCS0	EHT160_SU_Punct40_Mid2	
						111				
						143				
						207				
	802.11be (EHT320) Punctured by 40 MHz	CDD	802.11be (EHT320) Punctured by 80 MHz		CDD	63	BPSK	MCS0	EHT320_SU_Punct40_Mid2	
						159				
						191				
	802.11be (EHT320) Punctured by 80 MHz	CDD	802.11be (EHT320) Punctured by 80+40 MHz		CDD	63	BPSK	MCS0	EHT320_SU_Punct80_Mid2	
						159				
						191				
802.11be (EHT320) Punctured by 80+40 MHz	CDD	802.11be (EHT320) Punctured by 80+40 MHz	CDD	63	BPSK	MCS0	EHT320_SU_Punct120_Mid			
				159						
				191						



Unwanted Emissions above 1 GHz	C, D	802.11a	CDD	Outdoor client	2, 1, 45, 93	BPSK	6Mb/s	NA
					117, 149, 181			
		802.11be (EHT20)	CDD		2, 1, 45, 93	BPSK	MCS0	NA
					117, 149, 181			
		802.11be (EHT40)	CDD		3, 43, 91	BPSK	MCS0	NA
					123, 155, 179			
		802.11be (EHT80)	CDD		7, 39, 87	BPSK	MCS0	NA
					135, 151, 167			
		802.11be (EHT160)	CDD		15, 47, 79	BPSK	MCS0	NA
					143			
		802.11be (EHT320)	CDD		31, 63	BPSK	MCS0	NA
		802.11be (EHT20) 26-tone RU	CDD		2, 1, 45, 93	BPSK	MCS0	0, 0, 0, 8
					117, 149, 181			0, 0, 8, 8
		802.11be (EHT20) 52-tone RU	CDD		2, 1, 45, 93	BPSK	MCS0	37, 37, 37, 40
					117, 149, 181			37, 37, 40, 40
		802.11be (EHT20) 106-tone RU	CDD		2, 1, 45, 93	BPSK	MCS0	53, 53, 53, 54
117, 149, 181	53, 53, 54, 54							

Unwanted Emissions above 1 GHz	C, D	802.11be (EHT20) 242-tone RU	CDD	Outdoor client	1	BPSK	MCS0	NA
					117			
		802.11be (EHT40) 484-tone RU	CDD		3	BPSK	MCS0	NA
					123			
		802.11be (EHT80) 996-tone RU	CDD		7	BPSK	MCS0	NA
					135			
		802.11be (EHT160) 2x996-tone RU	CDD		15	BPSK	MCS0	NA
					143,			
		802.11be (EHT20) 52+26-tone MRU	CDD		1	BPSK	MCS0	UL_RU52+26_Low_70_MCS0
					117			UL_RU52+26_High_72_MCS0
		802.11be (EHT20) 106+26-tone MRU	CDD		1	BPSK	MCS0	UL_RU106+26_Low_82_MCS0
					117			UL_RU106+26_High_83_MCS0
		802.11be (EHT80) 484+242-tone MRU	CDD		7	BPSK	MCS0	UL_RU484+242_Punc20_91_MCS0
					135			
		802.11be (EHT160) 996+484-tone MRU	CDD		15	BPSK	MCS0	UL_RU996+484_Punc40_MCS0
					143			
		802.11be (EHT320) 2x996+484-tone MRU	CDD		31	BPSK	MCS0	UL_RU996x2+484_Low_MCS0
802.11be (EHT320) 3x996-tone MRU	CDD	31	BPSK	MCS0	UL_RU996x3_Low_MCS0			
802.11be (EHT320) 3x996+484-tone MRU	CDD	31	BPSK	MCS0	UL_RU996x3+484_Low_MCS0			
802.11be (EHT80) Punctured by 20 MHz	CDD	7	BPSK	MCS0	EHT80_SU_Punct20_Mid2			
		135						
802.11be (EHT160) Punctured by 20 MHz	CDD	15	BPSK	MCS0	EHT160_SU_Punct20_High			
		143						
802.11be (EHT160) Punctured by 40 MHz	CDD	15	BPSK	MCS0	EHT160_SU_Punct40_Mid2			
		143						
802.11be (EHT320) Punctured by 40 MHz	CDD	31	BPSK	MCS0	EHT320_SU_Punct40_Mid2			



		802.11be (EHT320) Punctured by 80 MHz	CDD		31	BPSK	MCS0	EHT320_SU_Punct80_Mid2
		802.11be (EHT320) Punctured by 80+40 MHz	CDD		31	BPSK	MCS0	EHT320_SU_Punct120_Mid
EUT Configure Mode:	A	EUT only (w/o antenna)_indoor client_Nss 1						
	B	EUT with 50 ohm terminator indoor client						
	C	EUT only (w/o antenna) outdoor client						
	D	EUT with 50 ohm terminator outdoor client						
	E	EUT only (w/o antenna) indoor client with Nss2						

3.5 Duty Cycle of Test Signal

Mode A

- 802.11a: Duty cycle = 2.09 ms / 2.116 ms x 100% = 98.8%
- 802.11be (EHT20): Duty cycle = 5.335 ms / 5.385 ms x 100% = 99.1%
- 802.11be (EHT40): Duty cycle = 5.389 ms / 5.434 ms x 100% = 99.2%
- 802.11be (EHT80): Duty cycle = 5.248 ms / 5.305 ms x 100% = 98.9%
- 802.11be (EHT160): Duty cycle = 4.404 ms / 4.453 ms x 100% = 98.9%
- 802.11be (EHT320): Duty cycle = 3.96 ms / 3.985 ms x 100% = 99.4%
- 802.11be (EHT20) 26-tone RU: Duty cycle = 5.07 ms / 5.123 ms x 100% = 99.0%
- 802.11be (EHT20) 52-tone RU: Duty cycle = 5.07 ms / 5.123 ms x 100% = 99.0%
- 802.11be (EHT20) 106-tone RU: Duty cycle = 5.07 ms / 5.123 ms x 100% = 99.0%
- 802.11be (EHT20) 242-tone RU: Duty cycle = 5.07 ms / 5.123 ms x 100% = 99.0%
- 802.11be (EHT40) 484-tone RU: Duty cycle = 3.318 ms / 3.356 ms x 100% = 98.9%
- 802.11be (EHT80) 996-tone RU: Duty cycle = 1.622 ms / 1.647 ms x 100% = 98.5%
- 802.11be (EHT160) 2x996-tone RU: Duty cycle = 2.149 ms / 2.179 ms x 100% = 98.6%
- 802.11be (EHT20) 52+26-tone MRU: Duty cycle = 5.07 ms / 5.123 ms x 100% = 99.0%
- 802.11be (EHT20) 106+26-tone MRU: Duty cycle = 5.07 ms / 5.123 ms x 100% = 99.0%
- 802.11be (EHT80) 484+242-tone MRU: Duty cycle = 1.622 ms / 1.647 ms x 100% = 98.5%
- 802.11be (EHT160) 996+484-tone MRU: Duty cycle = 2.149 ms / 2.179 ms x 100% = 98.6%
- 802.11be (EHT320) 2x996+484-tone MRU: Duty cycle = 0.574 ms / 0.598 ms x 100% = 96.0%, duty factor = 10 * log (1/Duty cycle) = 0.18 dB
- 802.11be (EHT320) 3x996-tone MRU: Duty cycle = 0.574 ms / 0.598 ms x 100% = 96.0%, duty factor = 10 * log (1/Duty cycle) = 0.18 dB
- 802.11be (EHT320) 3x996+484-tone MRU: Duty cycle = 0.574 ms / 0.598 ms x 100% = 96.0%, duty factor = 10 * log (1/Duty cycle) = 0.18 dB
- 802.11be (EHT80) Punctured by 20 MHz: Duty cycle = 1.622 ms / 1.647 ms x 100% = 98.5%
- 802.11be (EHT160) Punctured by 20 MHz: Duty cycle = 2.149 ms / 2.179 ms x 100% = 98.6%
- 802.11be (EHT160) Punctured by 40 MHz: Duty cycle = 2.149 ms / 2.179 ms x 100% = 98.6%
- 802.11be (EHT320) Punctured by 40 MHz: Duty cycle = 3.96 ms / 3.985 ms x 100% = 99.4%
- 802.11be (EHT320) Punctured by 80 MHz: Duty cycle = 3.96 ms / 3.985 ms x 100% = 99.4%
- 802.11be (EHT320) Punctured by 80+40 MHz: Duty cycle = 3.96 ms / 3.985 ms x 100% = 99.4%

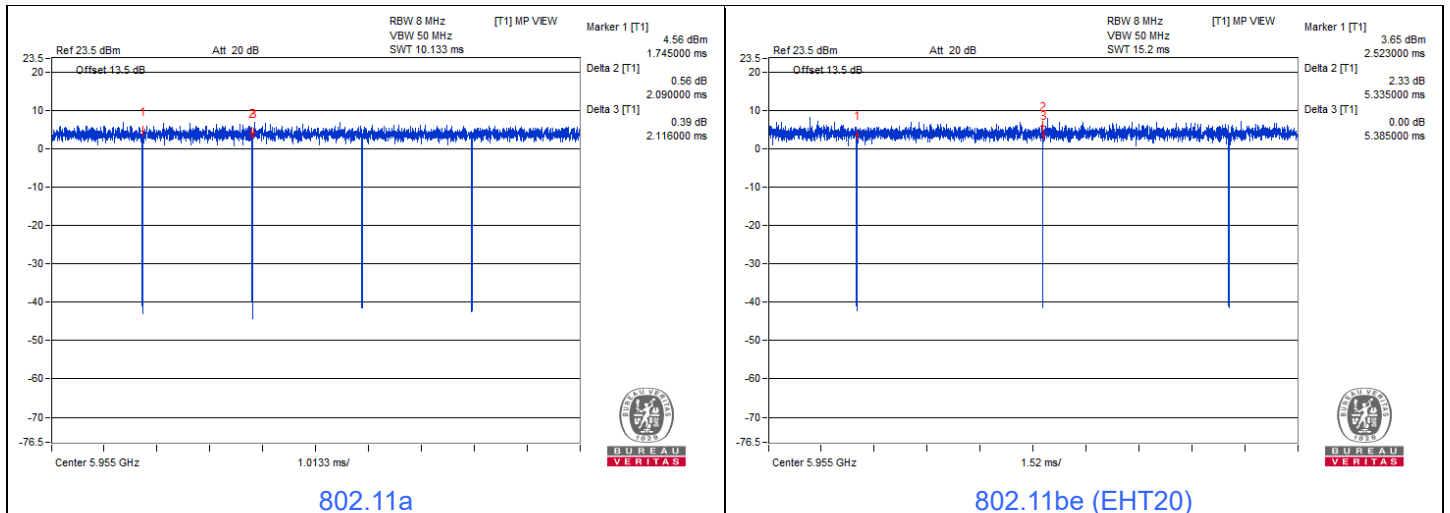

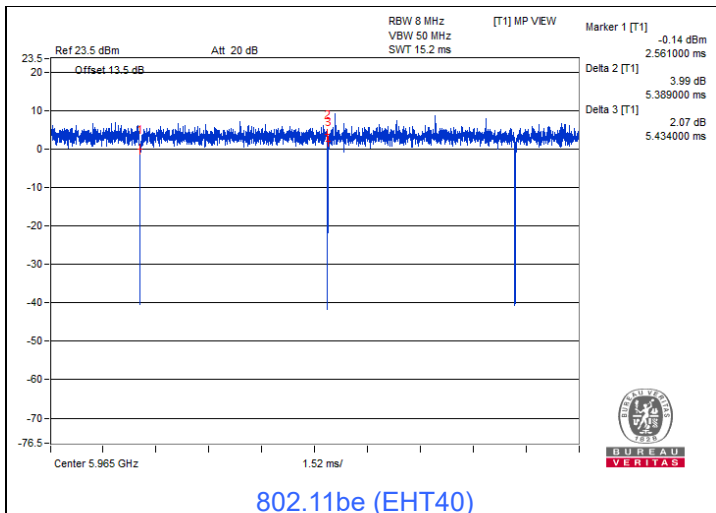

802.11be (EHT40)

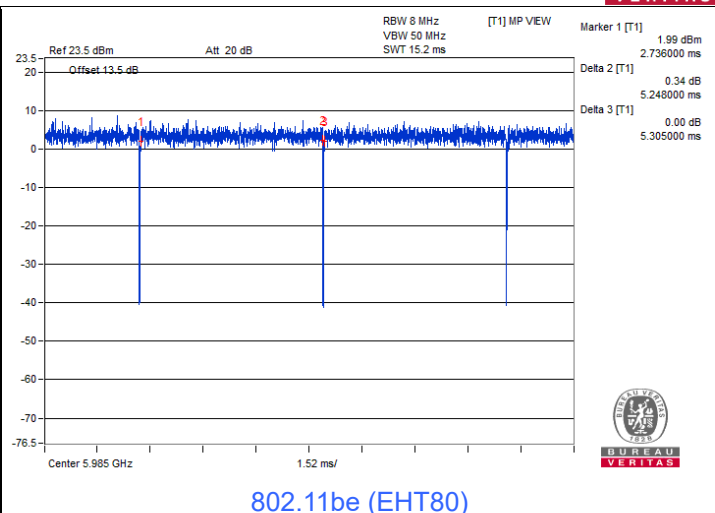

802.11be (EHT80)

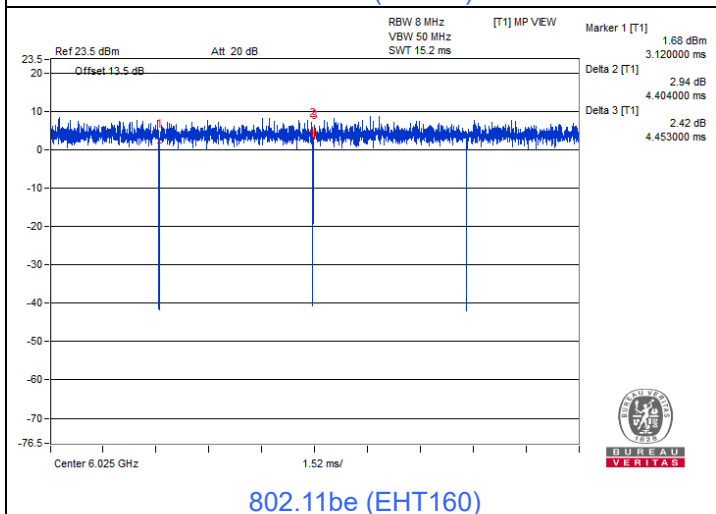

802.11be (EHT160)

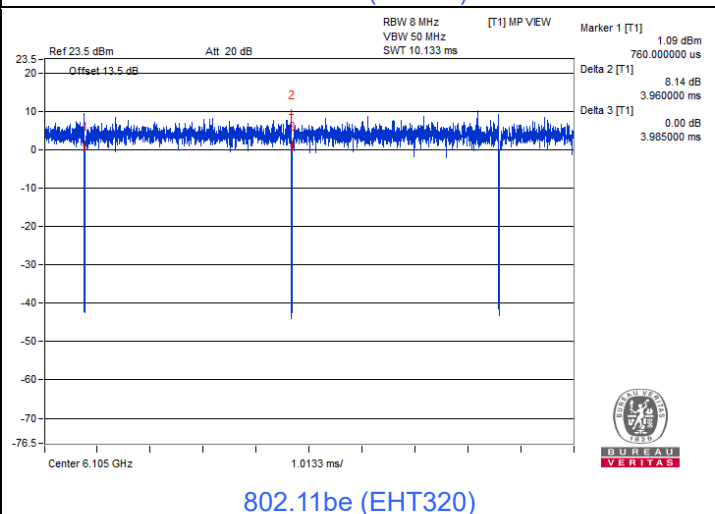

802.11be (EHT320)

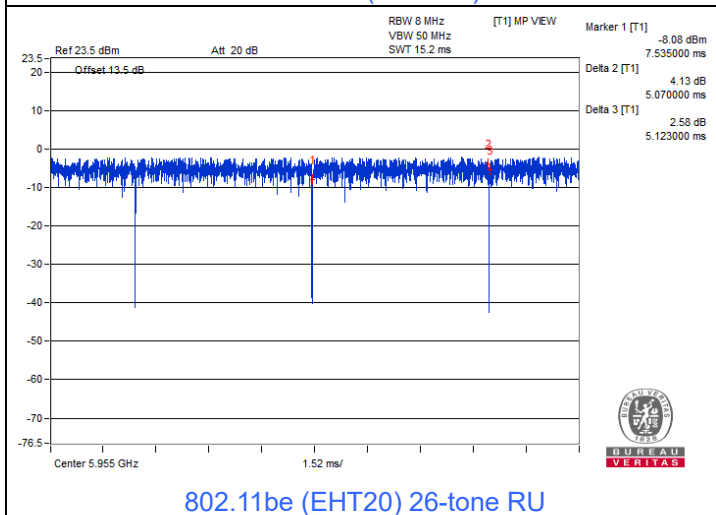

802.11be (EHT20) 26-tone RU

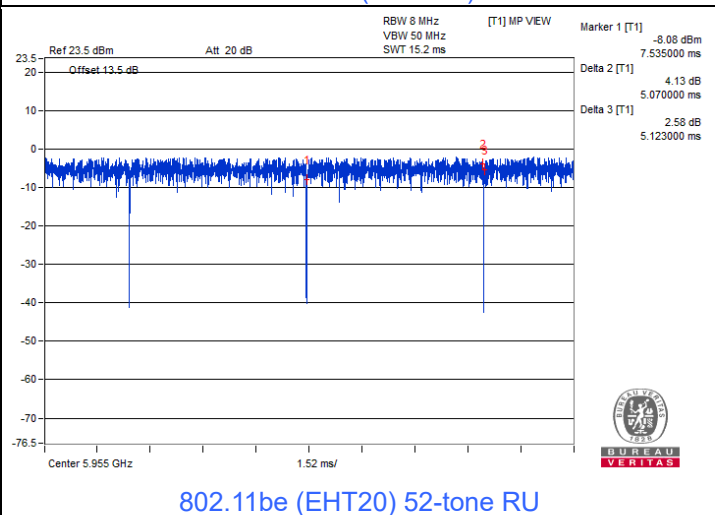

802.11be (EHT20) 52-tone RU

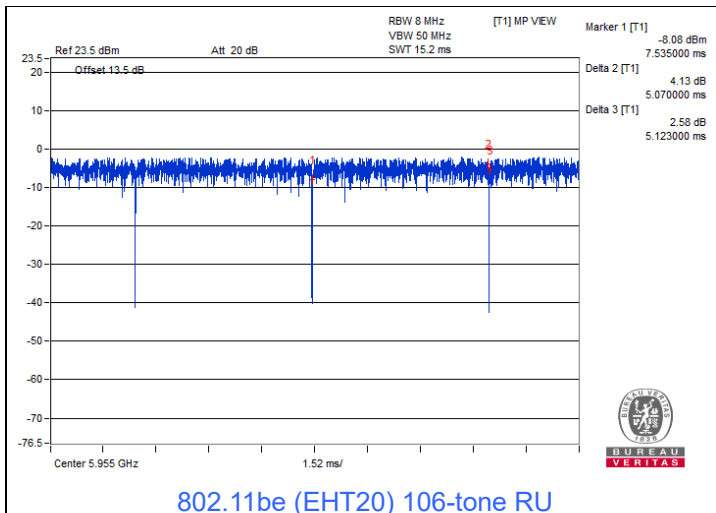

802.11be (EHT20) 106-tone RU

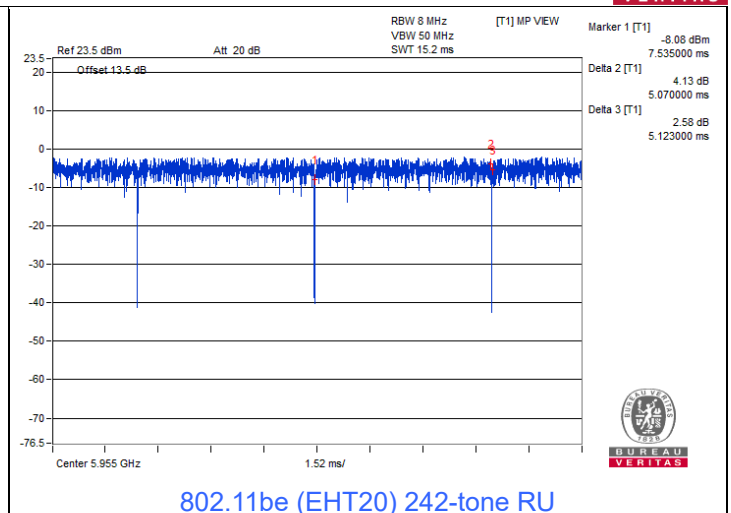

802.11be (EHT20) 242-tone RU

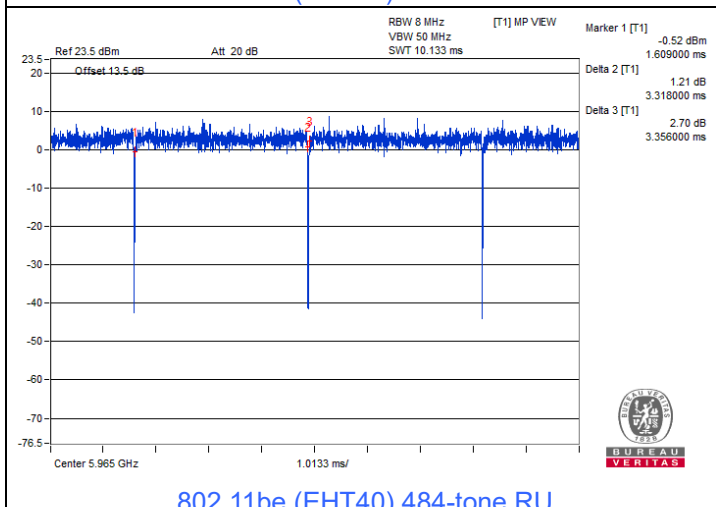

802.11be (EHT40) 484-tone RU

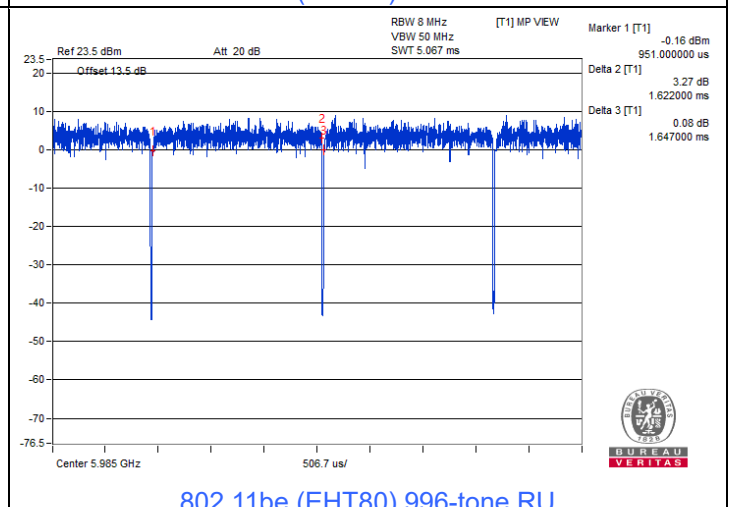

802.11be (EHT80) 996-tone RU

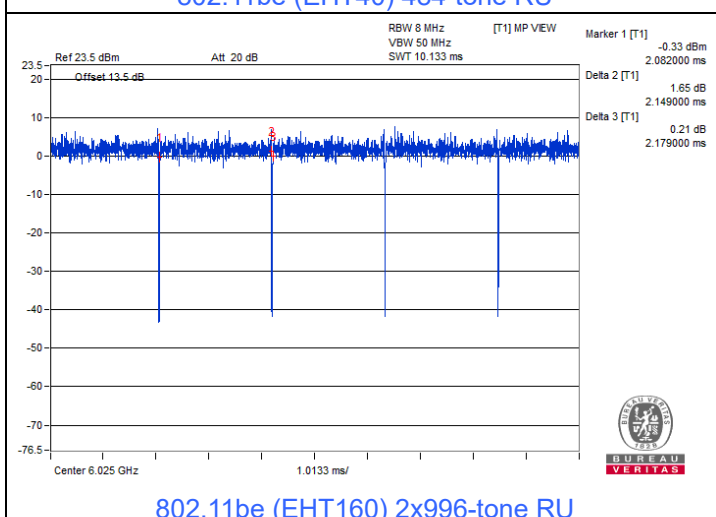

802.11be (EHT160) 2x996-tone RU

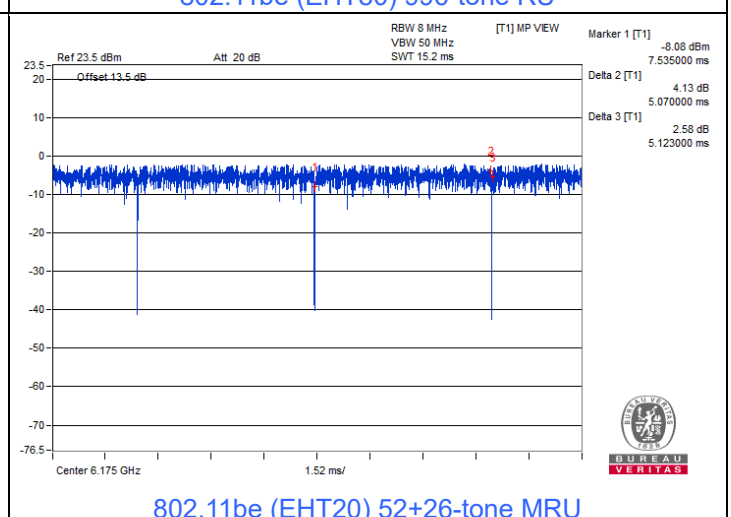

802.11be (EHT20) 52+26-tone MRU

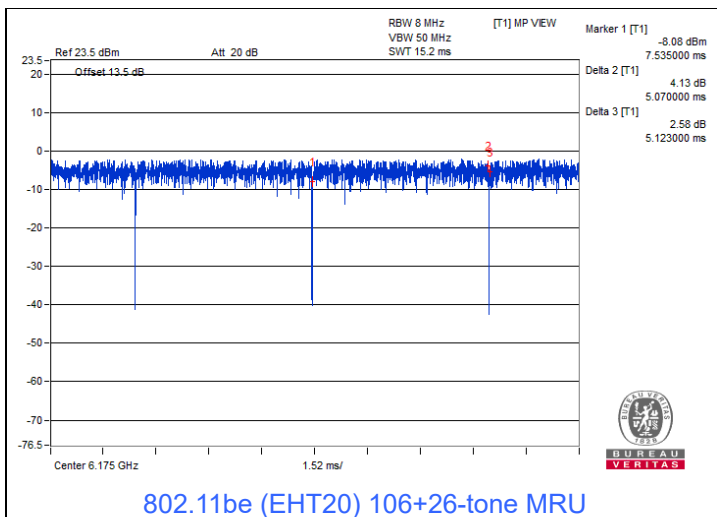

802.11be (EHT20) 106+26-tone MRU

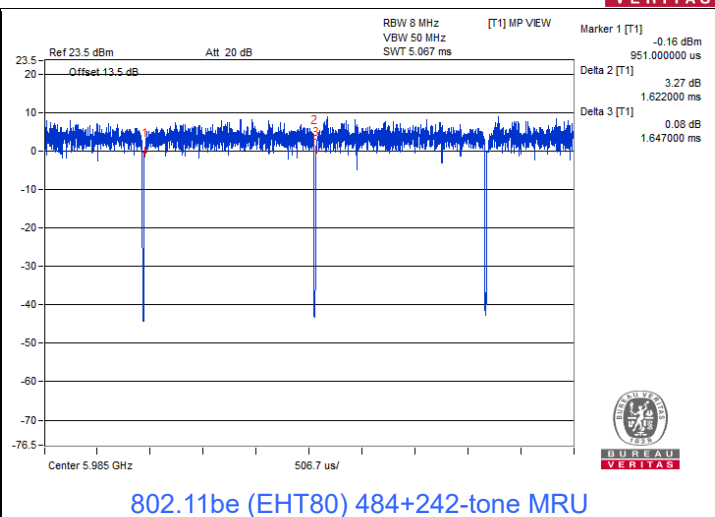

802.11be (EHT80) 484+242-tone MRU

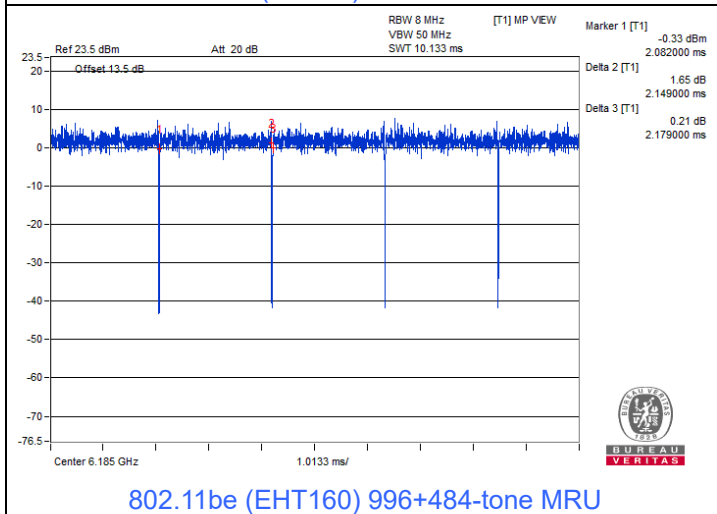

802.11be (EHT160) 996+484-tone MRU

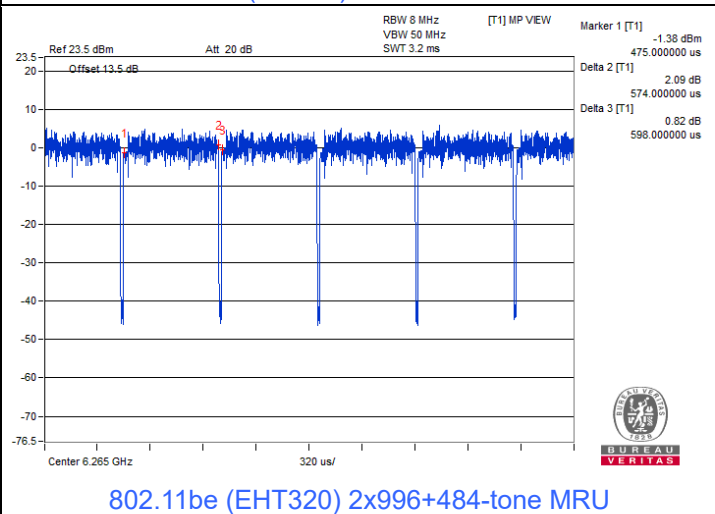

802.11be (EHT320) 2x996+484-tone MRU

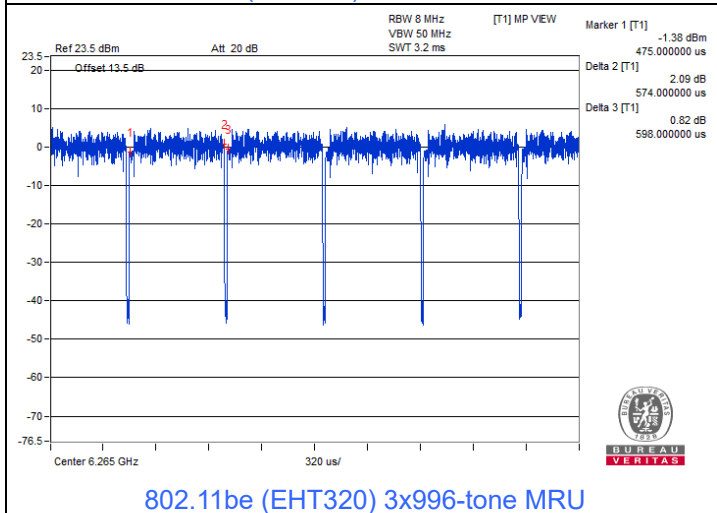

802.11be (EHT320) 3x996-tone MRU

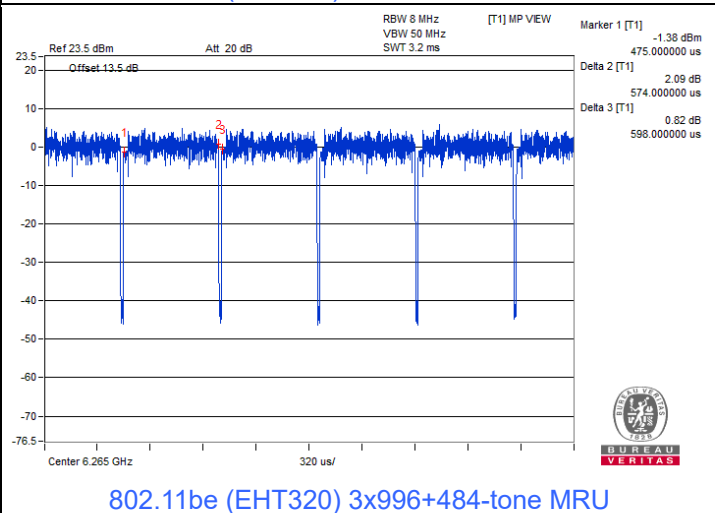

802.11be (EHT320) 3x996+484-tone MRU

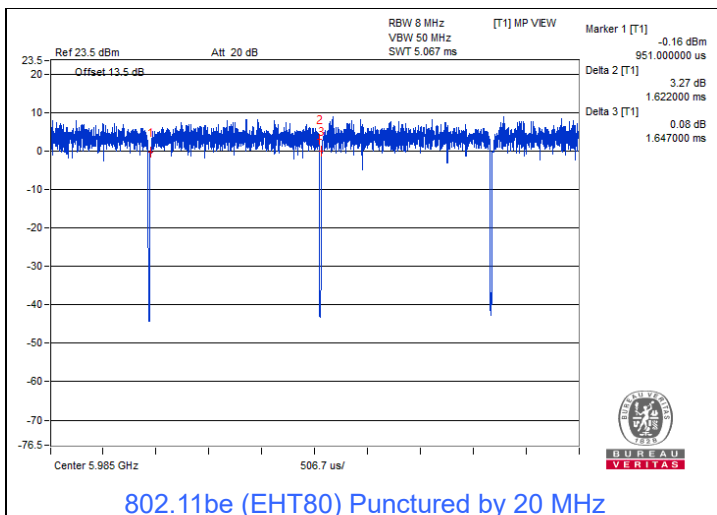

802.11be (EHT80) Punctured by 20 MHz

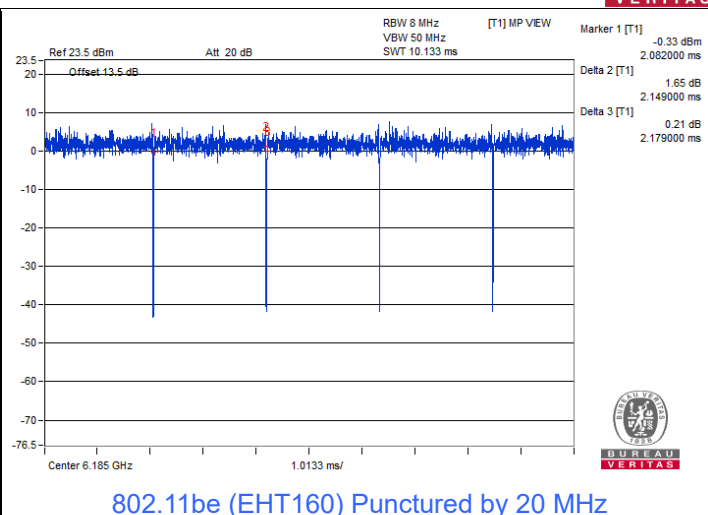

802.11be (EHT160) Punctured by 20 MHz

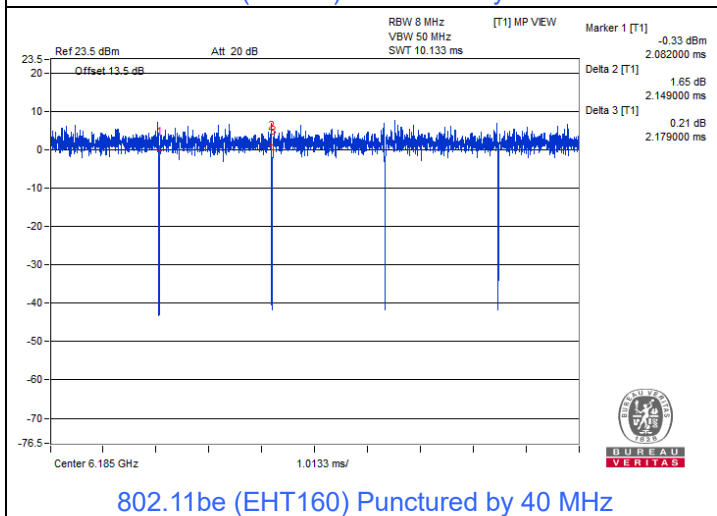

802.11be (EHT160) Punctured by 40 MHz

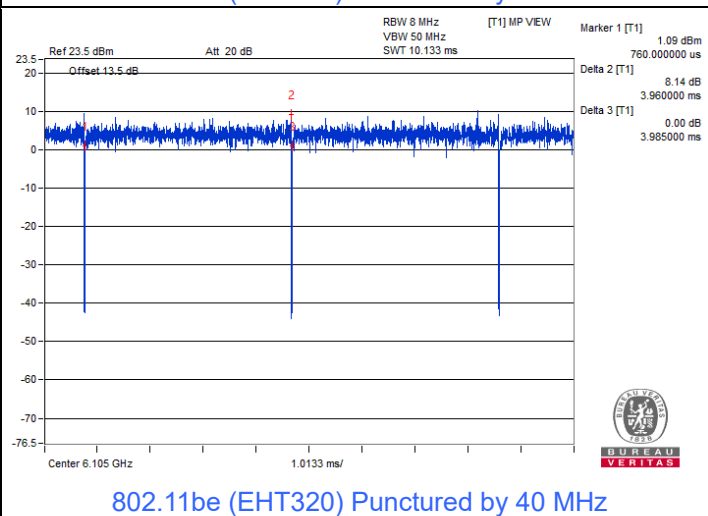

802.11be (EHT320) Punctured by 40 MHz

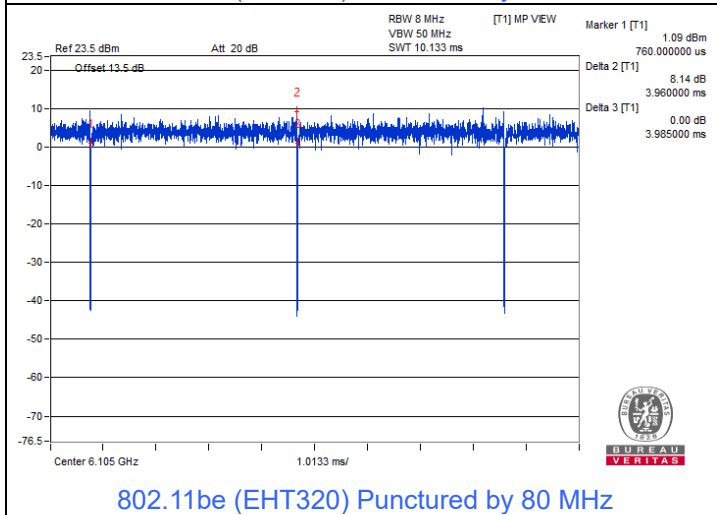

802.11be (EHT320) Punctured by 80 MHz

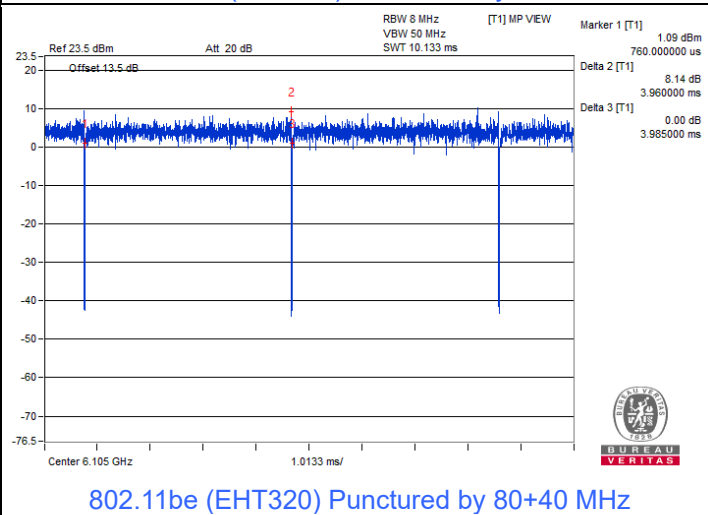

802.11be (EHT320) Punctured by 80+40 MHz

Mode C

- 802.11a: Duty cycle = 2.09 ms / 2.116 ms x 100% = 98.8%
- 802.11be (EHT20): Duty cycle = 5.335 ms / 5.385 ms x 100% = 99.1%
- 802.11be (EHT40): Duty cycle = 5.389 ms / 5.434 ms x 100% = 99.2%
- 802.11be (EHT80): Duty cycle = 5.248 ms / 5.305 ms x 100% = 98.9%
- 802.11be (EHT160): Duty cycle = 4.404 ms / 4.453 ms x 100% = 98.9%
- 802.11be (EHT320): Duty cycle = 3.96 ms / 3.985 ms x 100% = 99.4%
- 802.11be (EHT20) 26-tone RU: Duty cycle = 5.07 ms / 5.123 ms x 100% = 99.0%
- 802.11be (EHT20) 52-tone RU: Duty cycle = 5.07 ms / 5.123 ms x 100% = 99.0%
- 802.11be (EHT20) 106-tone RU: Duty cycle = 5.07 ms / 5.123 ms x 100% = 99.0%
- 802.11be (EHT20) 242-tone RU: Duty cycle = 5.07 ms / 5.123 ms x 100% = 99.0%
- 802.11be (EHT40) 484-tone RU: Duty cycle = 3.318 ms / 3.356 ms x 100% = 98.9%
- 802.11be (EHT80) 996-tone RU: Duty cycle = 1.622 ms / 1.647 ms x 100% = 98.5%
- 802.11be (EHT160) 2x996-tone RU: Duty cycle = 2.149 ms / 2.179 ms x 100% = 98.6%
- 802.11be (EHT20) 52+26-tone MRU: Duty cycle = 5.07 ms / 5.123 ms x 100% = 99.0%
- 802.11be (EHT20) 106+26-tone MRU: Duty cycle = 5.07 ms / 5.123 ms x 100% = 99.0%
- 802.11be (EHT80) 484+242-tone MRU: Duty cycle = 1.622 ms / 1.647 ms x 100% = 98.5%
- 802.11be (EHT160) 996+484-tone MRU: Duty cycle = 2.149 ms / 2.179 ms x 100% = 98.6%
- 802.11be (EHT320) 2x996+484-tone MRU: Duty cycle = 0.574 ms / 0.598 ms x 100% = 96.0%, duty factor = 10 * log (1/Duty cycle) = 0.18 dB
- 802.11be (EHT320) 3x996-tone MRU: Duty cycle = 0.574 ms / 0.598 ms x 100% = 96.0%, duty factor = 10 * log (1/Duty cycle) = 0.18 dB
- 802.11be (EHT320) 3x996+484-tone MRU: Duty cycle = 0.574 ms / 0.598 ms x 100% = 96.0%, duty factor = 10 * log (1/Duty cycle) = 0.18 dB
- 802.11be (EHT80) Punctured by 20 MHz: Duty cycle = 1.622 ms / 1.647 ms x 100% = 98.5%
- 802.11be (EHT160) Punctured by 20 MHz: Duty cycle = 2.149 ms / 2.179 ms x 100% = 98.6%
- 802.11be (EHT160) Punctured by 40 MHz: Duty cycle = 2.149 ms / 2.179 ms x 100% = 98.6%
- 802.11be (EHT320) Punctured by 40 MHz: Duty cycle = 3.96 ms / 3.985 ms x 100% = 99.4%
- 802.11be (EHT320) Punctured by 80 MHz: Duty cycle = 3.96 ms / 3.985 ms x 100% = 99.4%
- 802.11be (EHT320) Punctured by 80+40 MHz: Duty cycle = 3.96 ms / 3.985 ms x 100% = 99.4%

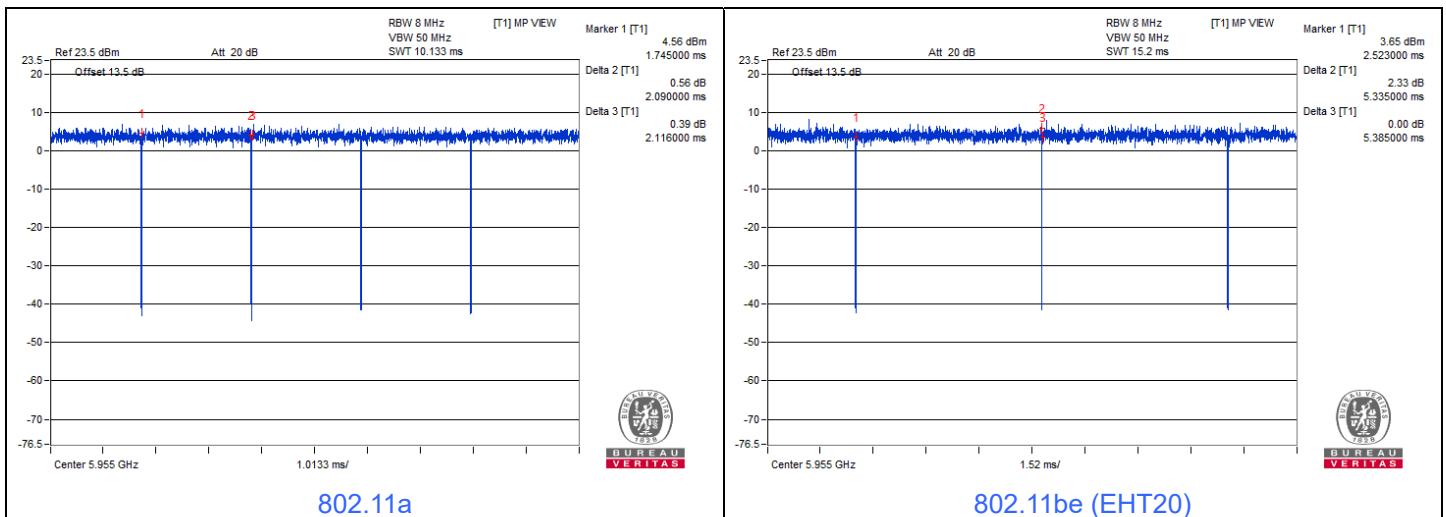

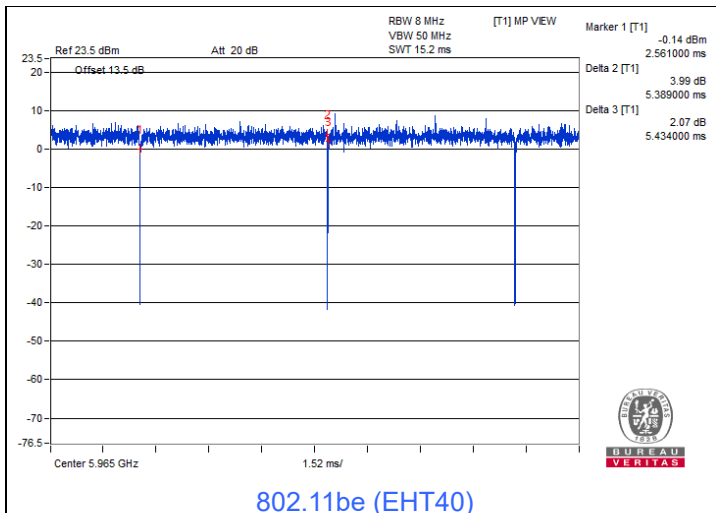

802.11be (EHT40)

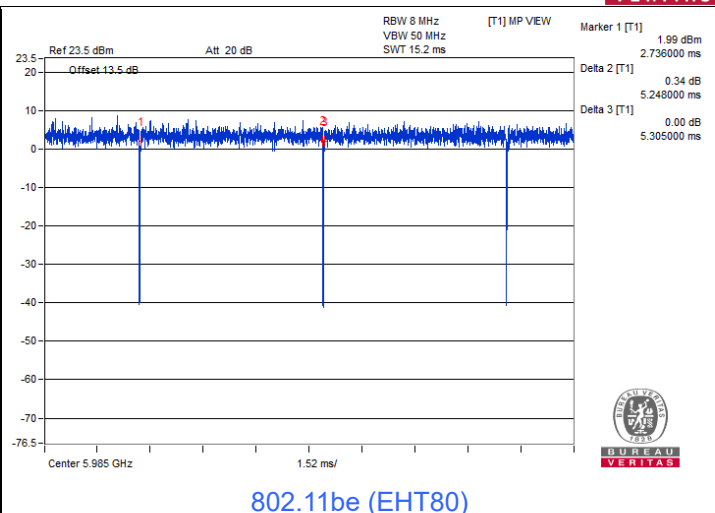

802.11be (EHT80)

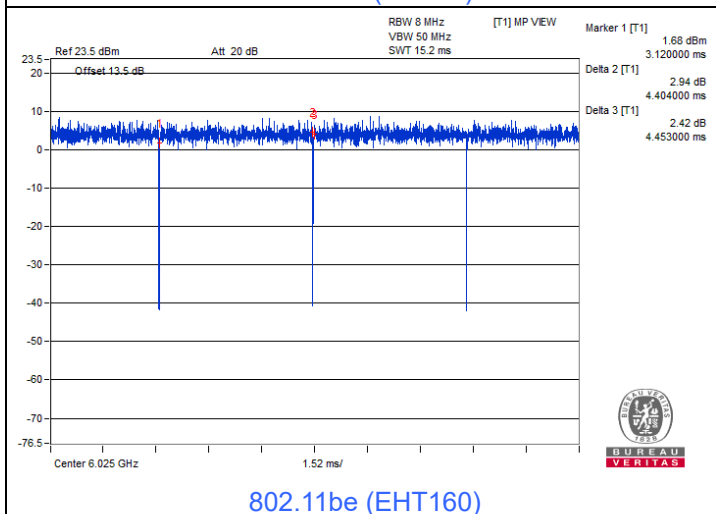

802.11be (EHT160)

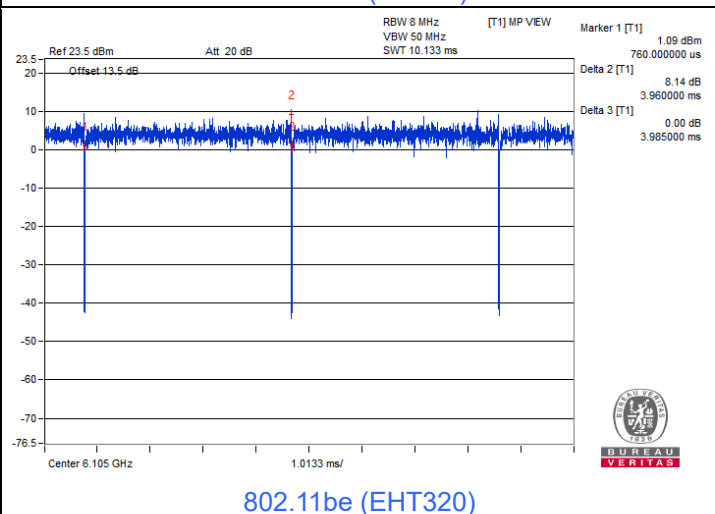

802.11be (EHT320)

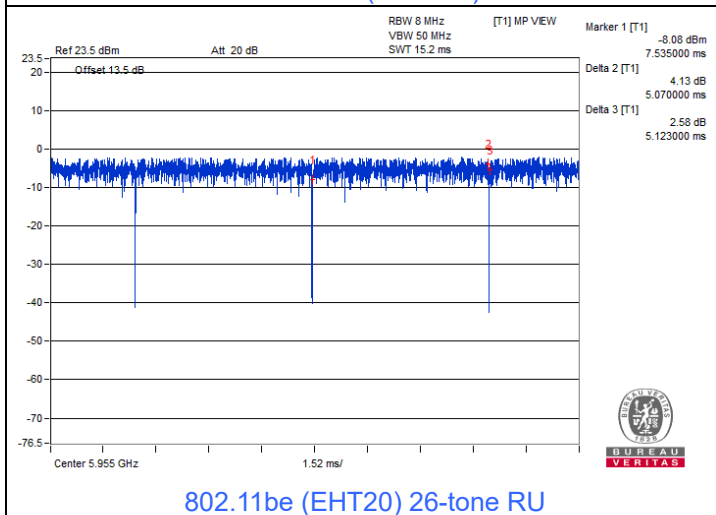

802.11be (EHT20) 26-tone RU

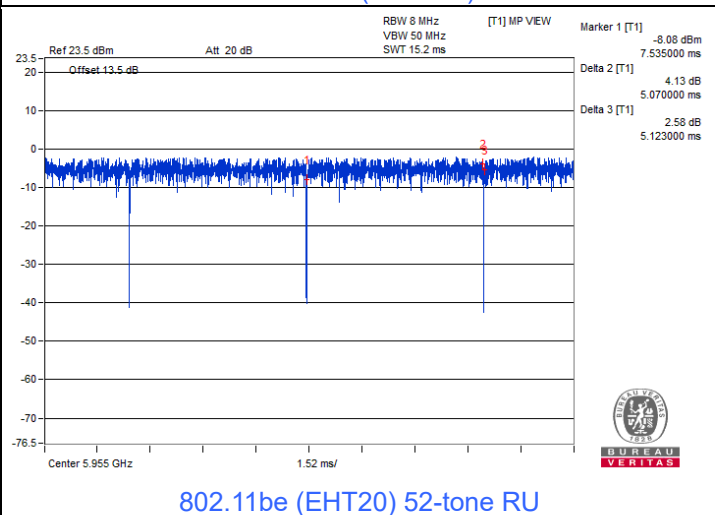

802.11be (EHT20) 52-tone RU

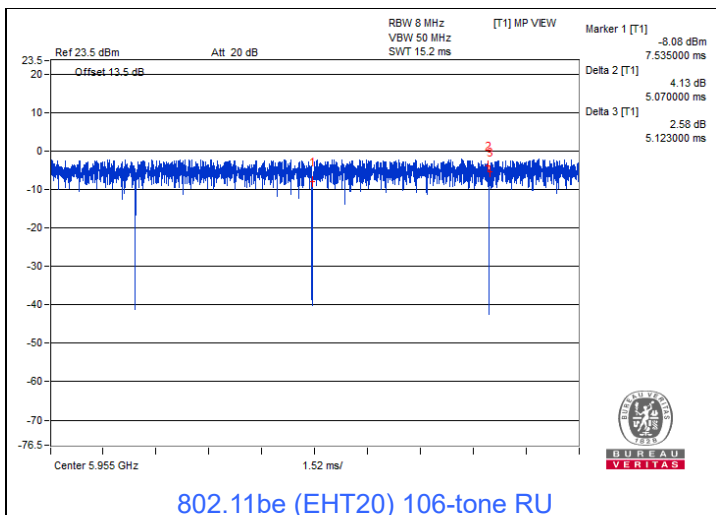

802.11be (EHT20) 106-tone RU

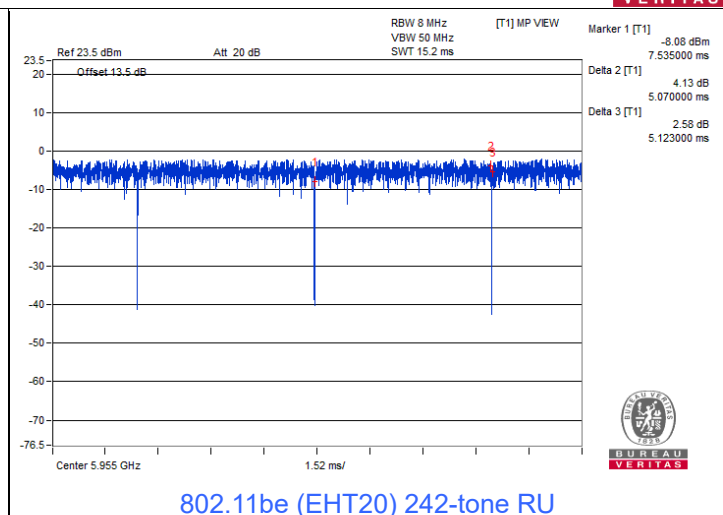

802.11be (EHT20) 242-tone RU

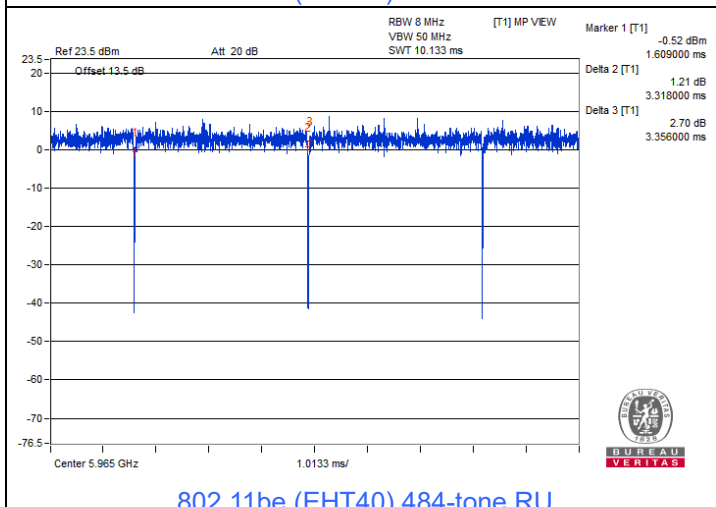

802.11be (EHT40) 484-tone RU

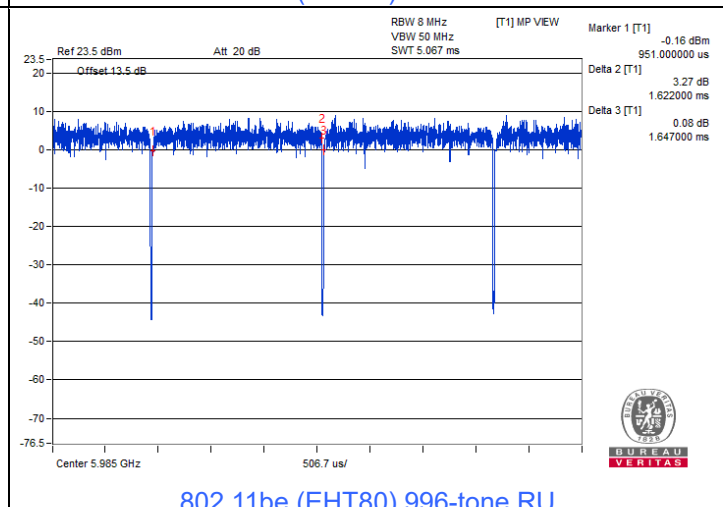

802.11be (EHT80) 996-tone RU

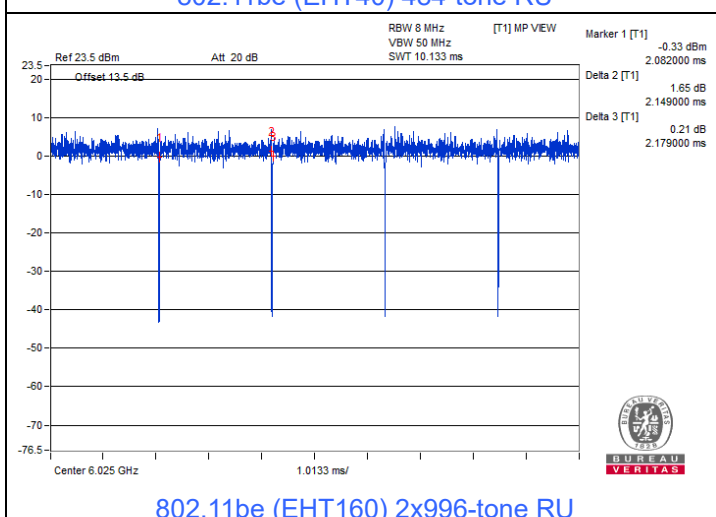

802.11be (EHT160) 2x996-tone RU

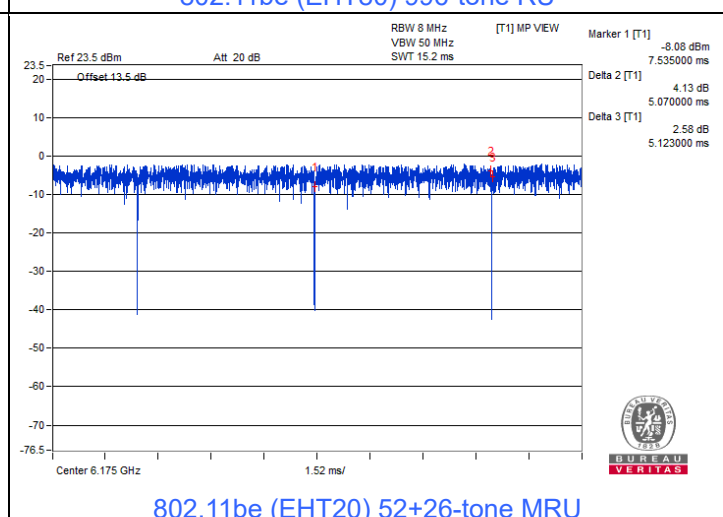

802.11be (EHT20) 52+26-tone MRU

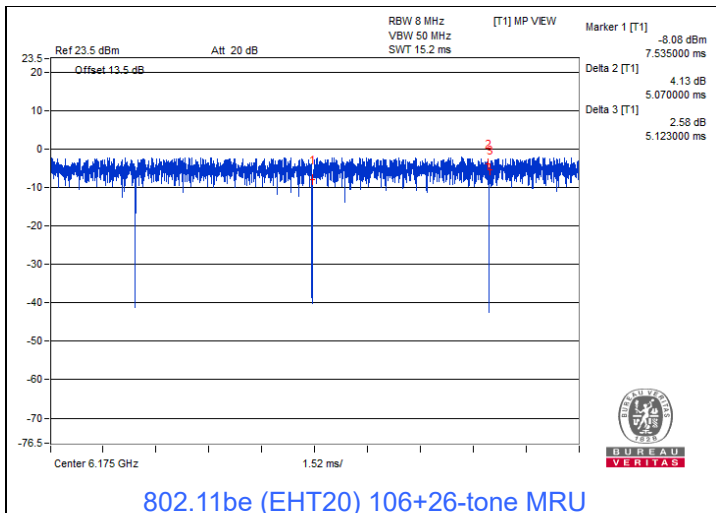

802.11be (EHT20) 106+26-tone MRU

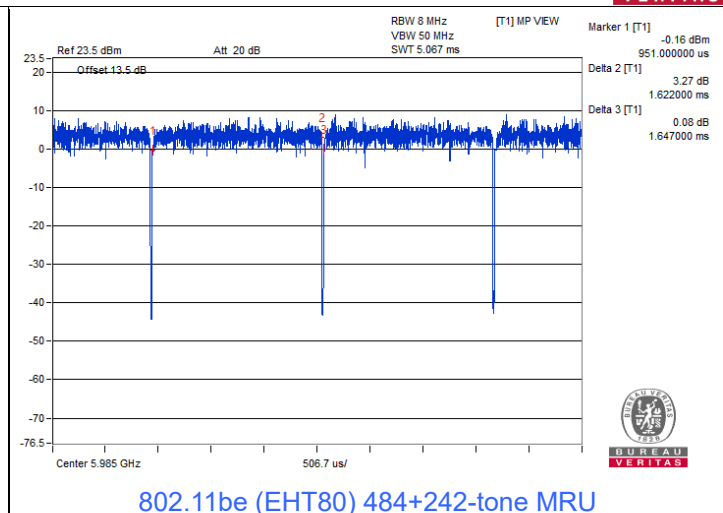

802.11be (EHT80) 484+242-tone MRU

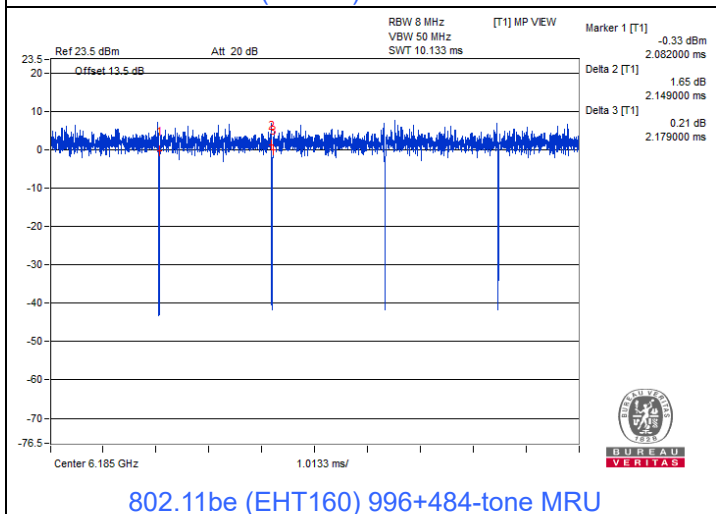

802.11be (EHT160) 996+484-tone MRU

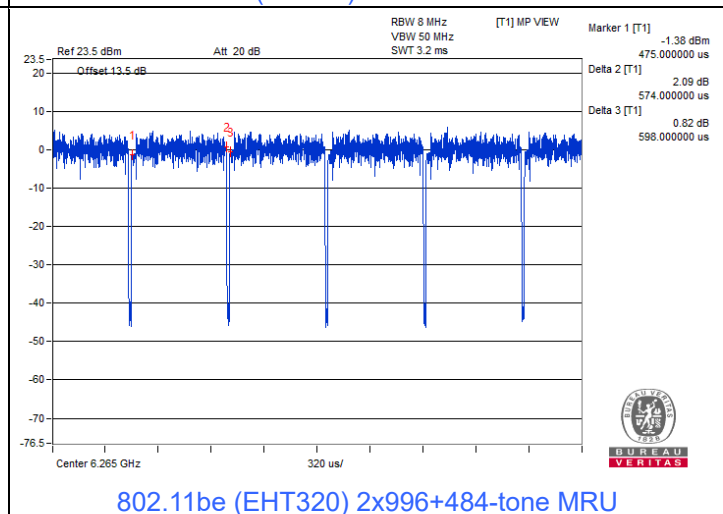

802.11be (EHT320) 2x996+484-tone MRU

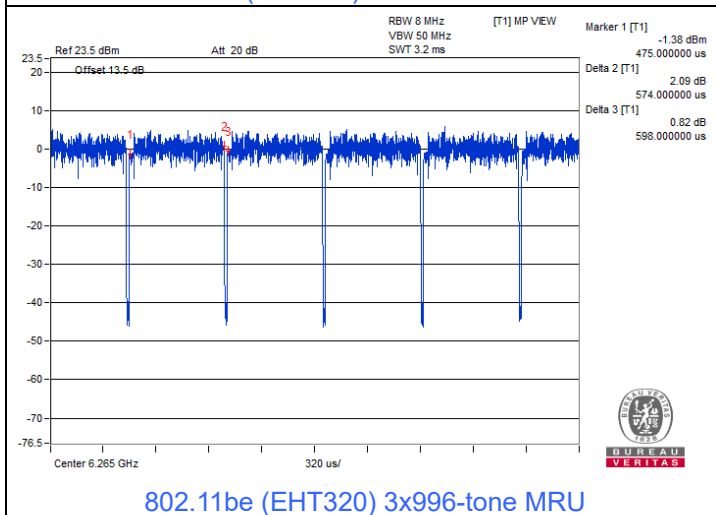

802.11be (EHT320) 3x996-tone MRU

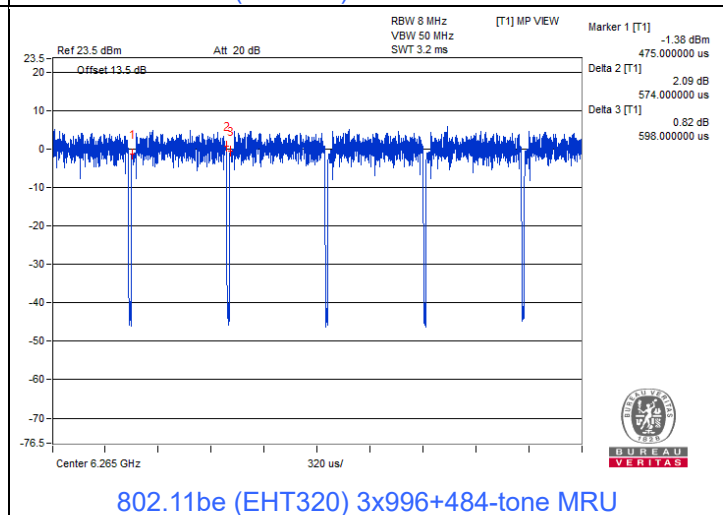

802.11be (EHT320) 3x996+484-tone MRU

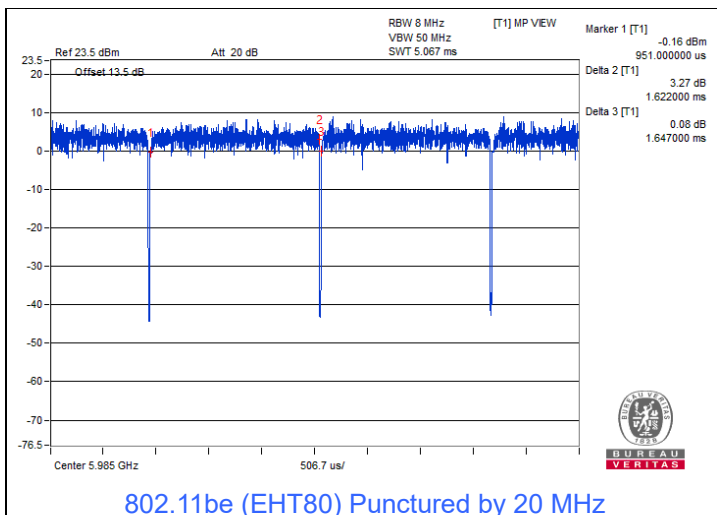

802.11be (EHT80) Punctured by 20 MHz

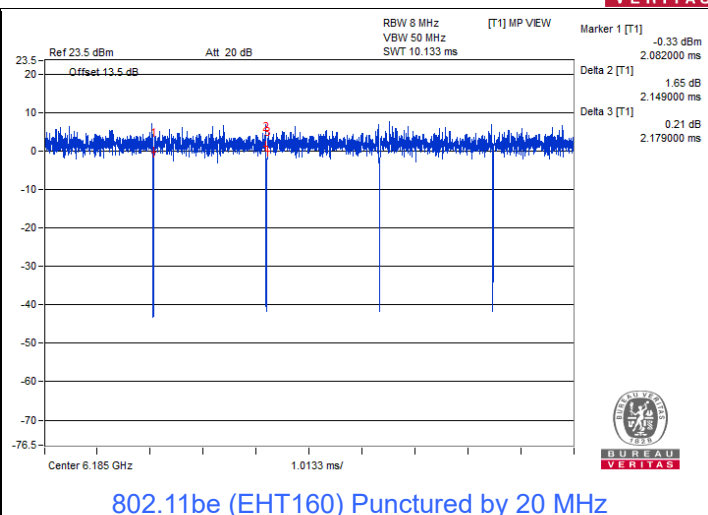

802.11be (EHT160) Punctured by 20 MHz

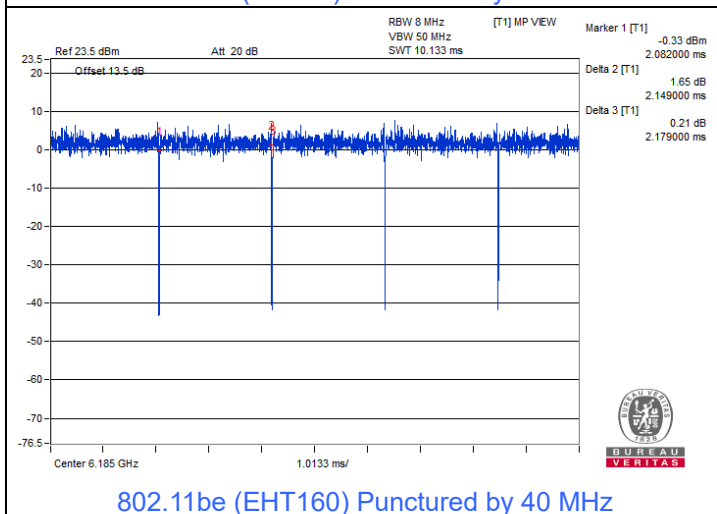

802.11be (EHT160) Punctured by 40 MHz

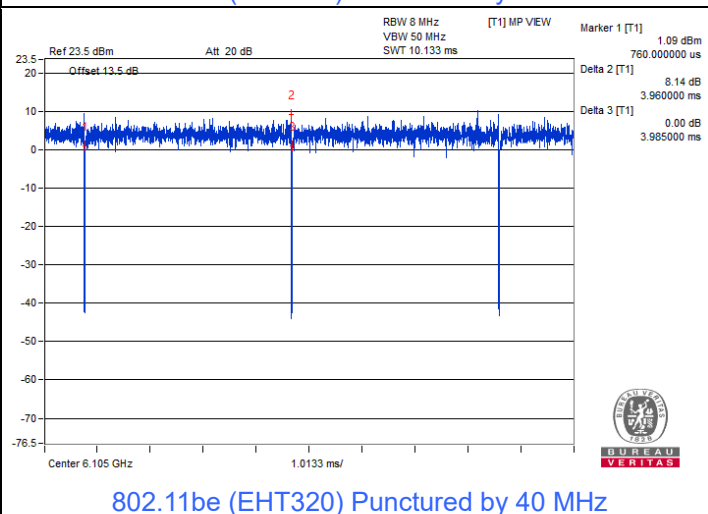

802.11be (EHT320) Punctured by 40 MHz

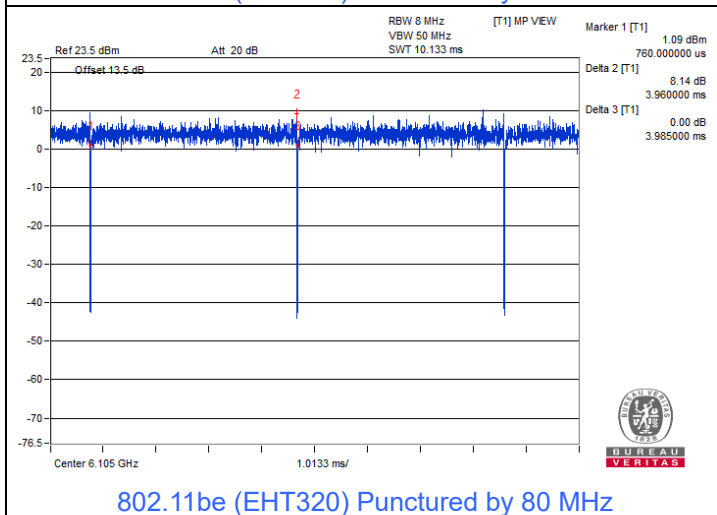

802.11be (EHT320) Punctured by 80 MHz

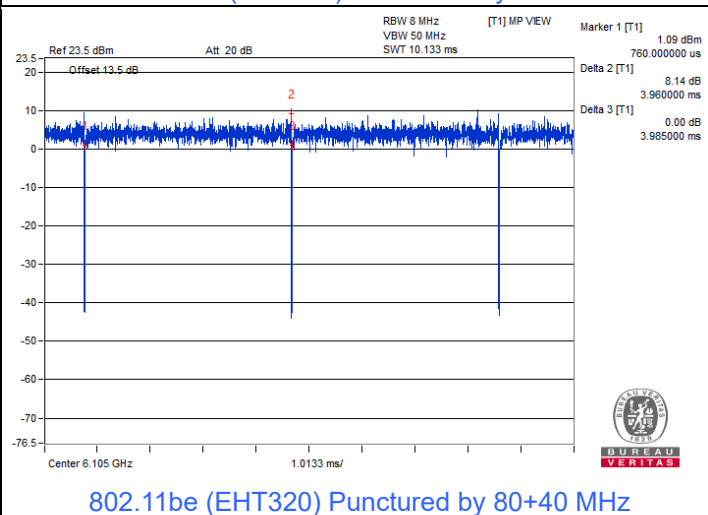

802.11be (EHT320) Punctured by 80+40 MHz

3.6 Test Program Used and Operation Descriptions

Controlling software (QRCT 4.0.00159.1) has been activated to set the EUT under transmission condition continuously at specific channel frequency.

3.7 Connection Diagram of EUT and Peripheral Devices

For AC Power Conducted Emission test

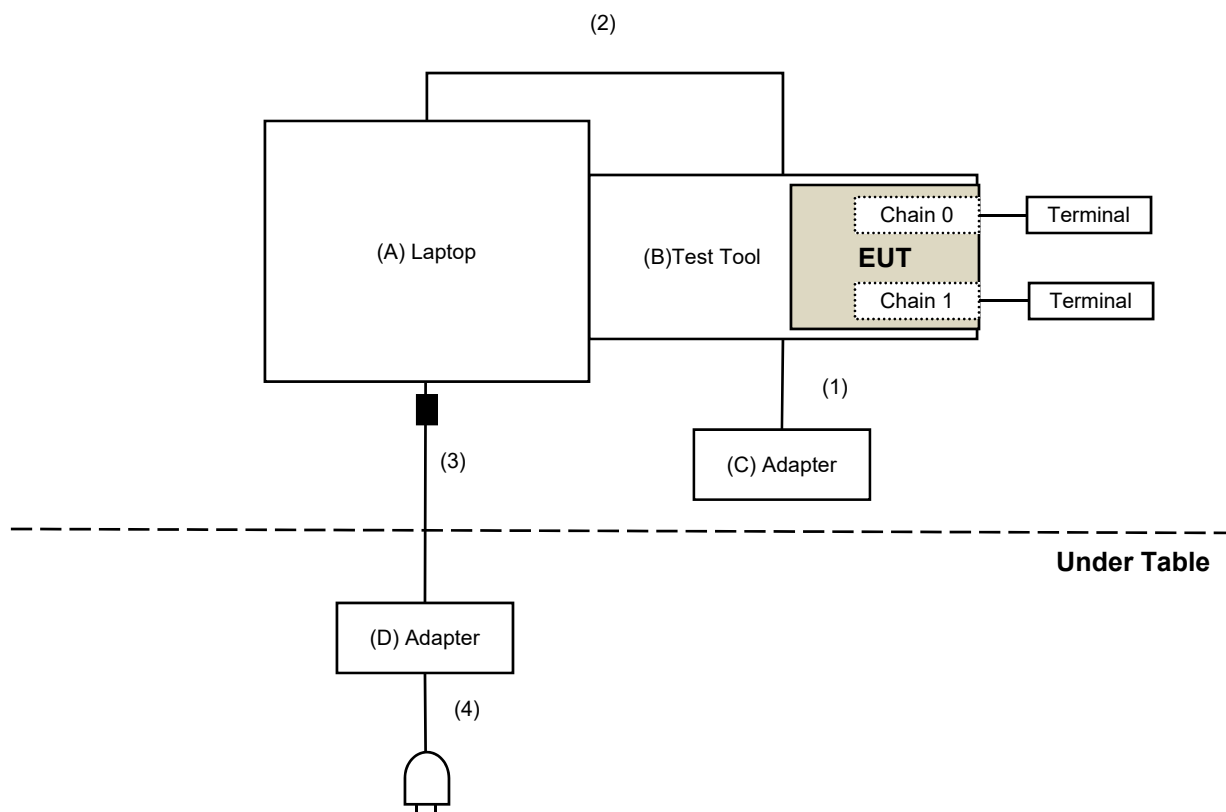

For Unwanted Emission test

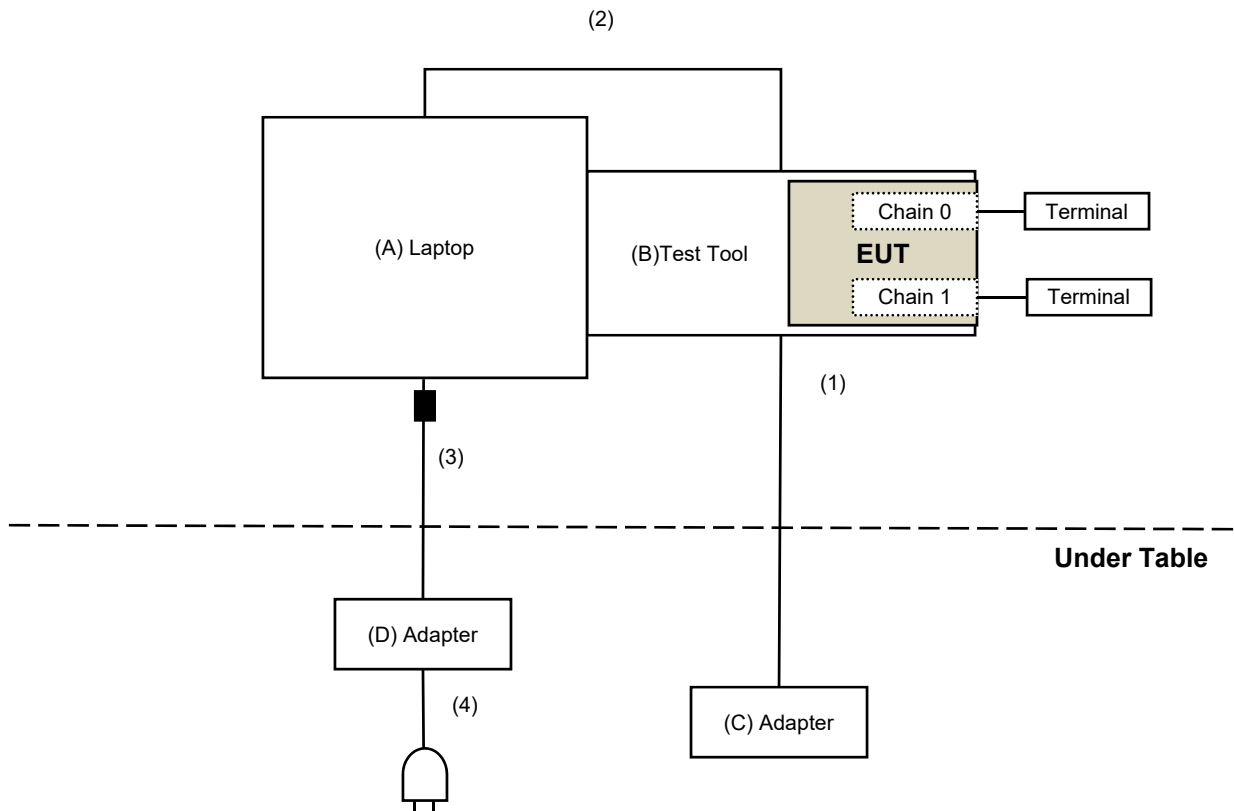

3.8 Configuration of Peripheral Devices and Cable Connections

ID	Product	Brand	Model No.	Serial No.	FCC ID	Remarks
A	Laptop	Dell	E5420	6FGHKV1	N/A	Provided by Lab
B	Test Tool	Qualcomm	N/A	N/A	N/A	Supplied by applicant
C	Adapter	PHIHONG	PSAA12A-120L6	N/A	N/A	Supplied by applicant
D	Adapter	Dell	LLA65NS2-01	N/A	N/A	Provided by Lab

ID	Cable Descriptions	Qty.	Length (m)	Shielding (Yes/No)	Cores (Qty.)	Remarks
1	DC Cable	1	1.2	NO	0	Supplied by applicant
2	USB Cable	1	0.6	Yes	0	Provided by Lab
3	DC Cable	1	1.8	NO	1	Provided by Lab
4	AC Cable	1	1.5	NO	0	Provided by Lab

4 Test Instruments

The calibration interval of the all test instruments are 12 months and the calibrations are traceable to NML/ROC and NIST/USA.

4.1 RF Output Power

Description Manufacturer	Model No.	Serial No.	Calibrated Date	Calibrated Until
Power Meter Anritsu	ML2495A	1529002	2022/6/22	2023/6/21
Pulse Power Sensor Anritsu	MA2411B	1726434	2022/6/22	2023/6/21
Attenuator WOKEN	MDCS18N-10	MDCS18N-10-01	2022/4/5	2023/4/4
Software	ADT_RF Test Software V6.6.5.4	N/A	N/A	N/A

Notes:

1. The test was performed in Oven room 2.
2. Tested Date: 2022/12/19 ~ 2022/12/27

4.2 Power Spectral Density

Description Manufacturer	Model No.	Serial No.	Calibrated Date	Calibrated Until
Attenuator WOKEN	MDCS18N-10	MDCS18N-10-01	2022/4/5	2023/4/4
Software	ADT_RF Test Software V6.6.5.4	N/A	N/A	N/A
Spectrum Analyzer Keysight	N9020B	MY60112409	2022/3/11	2023/3/10

Notes:

1. The test was performed in Oven room 2.
2. Tested Date: 2022/12/19 ~ 2022/12/27

4.3 Emission Bandwidth

Refer to section 4.2 to get information of the instruments.

4.4 In-Band Emission Mask

Refer to section 4.2 to get information of the instruments.

4.5 Occupied Bandwidth

Refer to section 4.2 to get information of the instruments.

4.6 Frequency Stability

Description Manufacturer	Model No.	Serial No.	Calibrated Date	Calibrated Until
Attenuator WOKEN	MDCS18N-10	MDCS18N-10-01	2022/4/5	2023/4/4
DC POWER SUPPLY Topward	6603D	795558	N/A	N/A
Software	ADT_RF Test Software V6.6.5.4	N/A	N/A	N/A
Spectrum Analyzer Keysight	N9020B	MY60112409	2022/3/11	2023/3/10
Temperature & Humidity Chamber Giant Force	GTH-150-40-SP-AR	MAA0812-008	2022/1/14	2023/1/13
True RMS Clamp Meter Fluke	325	31130711WS	2022/6/9	2023/6/8

Notes:

1. The test was performed in Oven room 2.
2. Tested Date: 2022/12/19 ~ 2022/12/27

4.7 Contention-based Protocol

Description Manufacturer	Model No.	Serial No.	Calibrated Date	Calibrated Until
Combiner Mini-Circuits	ZFRSC-123-S+	F698501347_01	2022/12/28	2023/12/27
Frequency Extender KEYSIGHT	N5182BX07	MY59360198	2022/10/14	2023/10/13
MXG X-Series RF Vector Signal Generator Keysight	N5182B	MY53052647	2022/11/8	2023/11/7
Spectrum Analyzer Keysight	N9030A	MY55410176	2022/6/21	2023/6/20
Spectrum Analyzer R&S	FSV40	101516	2022/3/7	2023/3/6

Notes:

1. The test was performed in Adaptivity room.
2. Tested Date: 2023/2/24

4.8 AC Power Conducted Emissions

Description Manufacturer	Model No.	Serial No.	Calibrated Date	Calibrated Until
50 ohm terminal resistance	N/A	EMC-01	2022/9/27	2023/9/26
Fixed attenuator STI	STI02-2200-10	005	2022/8/24	2023/8/23
LISN R&S	ESH3-Z5	848773/004	2022/10/18	2023/10/17
RF Coaxial Cable JYEBO	5D-FB	COCCAB-001	2022/8/24	2023/8/23
Software BVADT	BVADT_Cond_V7.3.7.4	N/A	N/A	N/A
TEST RECEIVER R&S	ESCS 30	847124/029	2022/10/14	2023/10/13

Notes:

1. The test was performed in Conduction 1
2. Tested Date: 2023/2/20

4.9 Unwanted Emissions below 1 GHz

Description Manufacturer	Model No.	Serial No.	Calibrated Date	Calibrated Until
Bilog Antenna Schwarzbeck	VULB 9168	9168-0842	2022/10/24	2023/10/23
Boresight Antenna Tower & Turn Table Max-Full	MF-7802BS	MF780208530	N/A	N/A
Fixed attenuator Mini-Circuits	UNAT-5+	PAD-ATT5-02	2022/12/28	2023/12/27
LOOP ANTENNA Electro-Metrics	EM-6879	264	2022/3/18	2023/3/17
Pre_Amplifier Agilent	8447D	2944A10636	2022/3/19	2023/3/18
Pre_Amplifier EMCI	EMC330N	980538	2022/4/25	2023/4/24
RF Coaxial Cable COMMATE/PEWC	8D	966-5-1	2022/4/25	2023/4/24
		966-5-2	2022/4/25	2023/4/24
		966-5-3	2022/4/25	2023/4/24
RF Coaxial Cable JYEBO	5D-FB	LOOPCAB-001	2022/12/19	2023/12/18
		LOOPCAB-002	2022/12/19	2023/12/18
Software	ADT_Radiated_V8.7.08	N/A	N/A	N/A
Spectrum Analyzer Keysight	N9020B	MY60112410	2022/3/13	2023/3/12
Test Receiver R&S	ESR3	102528	2023/2/10	2024/2/9

Notes:

1. The test was performed in 966 Chamber No. 5.
2. Tested Date: 2023/2/15

4.10 Unwanted Emissions above 1 GHz

Description Manufacturer	Model No.	Serial No.	Calibrated Date	Calibrated Until
Boresight Antenna Tower & Turn Table Max-Full	MF-7802BS	MF780208530	N/A	N/A
Horn Antenna Schwarzbeck	BBHA 9120D	9120D-1819	2022/11/13	2023/11/12
	BBHA 9170	9170-739	2022/11/13	2023/11/12
Pre_Amplifier EMCI	EMC12630SE	980509	2022/4/25	2023/4/24
	EMC184045SE	980387	2022/12/28	2023/12/27
RF Cable-Frequency range: 1- 40GHz EMCI	EMC102-KM-KM-1200	160924	2022/12/28	2023/12/27
RF Coaxial Cable EMCI	EMC-KM-KM-4000	200214	2022/3/8	2023/3/7
	EMC104-SM-SM-1500	180503	2022/4/25	2023/4/24
	EMC104-SM-SM-2000	180501	2022/4/25	2023/4/24
	EMC104-SM-SM-6000	180506	2022/4/25	2023/4/24
Software	ADT_Radiated_V8.7.08	N/A	N/A	N/A
Spectrum Analyzer Keysight	N9020B	MY60112410	2022/3/13	2023/3/12
Test Receiver R&S	ESR3	102528	2023/2/10	2024/2/9

Notes:

1. The test was performed in 966 Chamber No. 5.
2. Tested Date: 2023/2/21

5 Limits of Test Items

5.1 RF Output Power

Operation Band	EUT Category	Limit
		Max Average Power
U-NII-5 U-NII-6 U-NII-7 U-NII-8	Dual Client Devices (controlled of an indoor AP)	EIRP 24 dBm
U-NII-5 U-NII-7	Dual Client Devices (controlled of a standard power AP)	EIRP 30 dBm

Per KDB 662911 Method of conducted output power measurement on IEEE 802.11 devices,

Array Gain = 0 dB (i.e., no array gain) for $N_{ANT} \leq 4$;

Array Gain = 0 dB (i.e., no array gain) for channel widths ≥ 40 MHz for any N_{ANT} ;

Array Gain = $5 \log(N_{ANT}/N_{SS})$ dB or 3 dB, whichever is less for 20-MHz channel widths with $N_{ANT} \geq 5$.

For power measurements on all other devices: Array Gain = $10 \log(N_{ANT}/N_{SS})$ dB.

5.2 Power Spectral Density

Operation Band	EUT Category	Limit
		Peak Power Density
U-NII-5 U-NII-6 U-NII-7 U-NII-8	Dual Client Devices (controlled of an indoor AP)	EIRP -1 dBm/MHz
U-NII-5 U-NII-7	Dual Client Devices (controlled of a standard power AP)	EIRP 17 dBm/MHz

5.3 Emission Bandwidth

The results are for reference only.

5.4 In-Band Emission Mask

Test Item	Frequencies (MHz)	(X) dBc*1
Emission Mask	At 1 MHz outside of channel edge	20
	At one channel bandwidth from the channel center*2	28
	At one- and one-half times the channel bandwidth away from channel center*3	40
	More than one- and one-half times the channel bandwidth	40

*1 : The power spectral density must be suppressed by "x" dB

*2 : At frequencies between one megahertz outside an unlicensed device's channel edge and one channel bandwidth from the center of the channel, the limits must be linearly interpolated between 20 dB and 28 dB suppression,

*3 : At frequencies between one and one- and one-half times an unlicensed device's channel bandwidth, the limits must be linearly interpolated between 28 dB and 40 dB suppression.

5.5 Occupied Bandwidth

The maximum transmitter channel bandwidth for U-NII devices in the 5.925-7.125 GHz band is 320 MHz.

5.6 Frequency Stability

The frequency of the carrier signal shall be maintained within band of operation.

5.7 Contention-based Protocol

Unlicensed indoor low-power devices must detect co-channel radio frequency power that is at least -62 dBm (The threshold is referenced to a 0 dBi antenna gain.) or lower. Additionally, indoor low-power devices must detect co-channel energy with 90% or greater certainty.

5.8 AC Power Conducted Emissions

Frequency (MHz)	Conducted Limit (dBuV)	
	Quasi-peak	Average
0.15 - 0.5	66 - 56	56 - 46
0.50 - 5.0	56	46
5.0 - 30.0	60	50

Notes:

1. The lower limit shall apply at the transition frequencies.
2. The limit decreases in line with the logarithm of the frequency in the range of 0.15 to 0.50 MHz.

5.9 Unwanted Emissions below 1 GHz

Radiated emissions which fall in the restricted bands must comply with the radiated emission limits specified as below table.

Frequencies (MHz)	Field Strength (microvolts/meter)	Measurement Distance (meters)
0.009 ~ 0.490	2400/F(kHz)	300
0.490 ~ 1.705	24000/F(kHz)	30
1.705 ~ 30.0	30	30
30 ~ 88	100	3
88 ~ 216	150	3
216 ~ 960	200	3
Above 960	500	3

Notes:

1. The lower limit shall apply at the transition frequencies.
2. Emission level (dBuV/m) = 20 log Emission level (uV/m).

5.10 Unwanted Emissions above 1 GHz

Radiated emissions which fall in the restricted bands must comply with the radiated emission limits specified as below table.

Frequencies (MHz)	Field Strength (microvolts/meter)	Measurement Distance (meters)
Above 960	500	3

Notes:

1. The lower limit shall apply at the transition frequencies.
2. Emission level (dBuV/m) = 20 log Emission level (uV/m).
3. For frequencies above 1000 MHz, the field strength limits are based on average detector, however, the peak field strength of any emission shall not exceed the maximum permitted average limits, specified above by more than 20 dB under any condition of modulation.

Limits of unwanted emission out of the restricted bands

Frequencies (MHz)	EIRP Limit	Equivalent Field Strength at 3 m
5925 MHz > F > 7125 MHz	Peak: -7 (dBm/MHz)	88.2 (dBuV/m)
	Average: -27 (dBm/MHz)	68.2 (dBuV/m)

Note: The following formula is used to convert the equipment isotropic radiated power (eirp) to field strength:

$$E = \frac{1000000 \sqrt{30P}}{3} \mu\text{V/m, where P is the eirp (Watts).}$$

6 Test Arrangements

6.1 RF Output Power

6.1.1 Test Setup

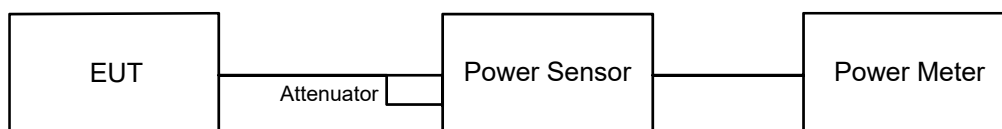

6.1.2 Test Procedure

Method PM is used to perform output power measurement, trigger and gating function of wide band power meter is enabled to measure max output power of TX on burst and set the detector to average. Duty factor is not added to measured value.

6.2 Power Spectral Density

6.2.1 Test Setup

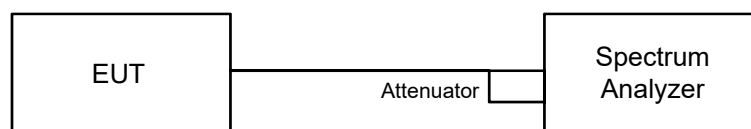

6.2.2 Test Procedure

For specified measurement bandwidth 1 MHz:

Method SA-1

- Set span to encompass the entire emission bandwidth (EBW) of the signal.
- Set RBW = 1 MHz, Set VBW \geq 3 MHz, Detector = RMS
- Sweep points \geq $[2 \times \text{span} / \text{RBW}]$. (This gives bin-to-bin spacing \leq RBW / 2, so that narrowband signals are not lost between frequency bins.)
- Sweep time = auto, trigger set to "free run".
- Trace average at least 100 traces in power averaging mode.
- Record the max value

For specified measurement bandwidth 1 MHz:

Method SA-2

- Set span to encompass the entire emission bandwidth (EBW) of the signal.
- Set RBW = 1 MHz, Set VBW \geq 3 MHz, Detector = RMS
- Sweep points \geq $[2 \times \text{span} / \text{RBW}]$. (This gives bin-to-bin spacing \leq RBW / 2, so that narrowband signals are not lost between frequency bins.)
- Sweep time = auto, trigger set to "free run".
- Trace average at least 100 traces in power averaging mode.
- Use the peak search function on the instrument to find the peak of the spectrum and record its value.
- Record the max value and add 10 log (1/duty cycle).

6.3 Emission Bandwidth

6.3.1 Test Setup

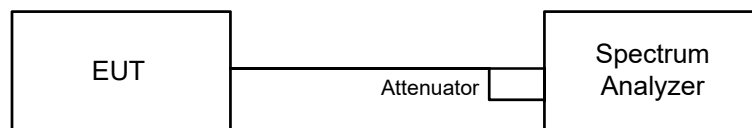

6.3.2 Test Procedure

- a. Set RBW = approximately 1% of the emission bandwidth.
- b. Set the VBW > RBW.
- c. Detector = Peak.
- d. Trace mode = max hold.
- e. Measure the maximum width of the emission that is 26 dB down from the peak of the emission. Compare this with the RBW setting of the analyzer. Readjust RBW and repeat measurement as needed until the RBW/EBW ratio is approximately 1%.

6.4 In-Band Emission Mask

6.4.1 Test Setup

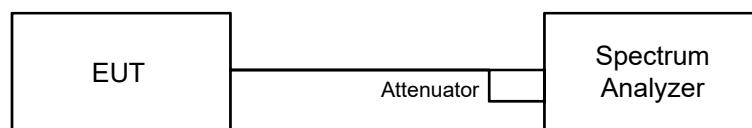

6.4.2 Test Procedure

- a. Connect output of the antenna port to a spectrum analyzer and adjust appropriate attenuation.
- b. Measure the 26 dB EBW using the test procedure 12.4.1 of ANSI C63.10-2013. (Determine the channel edge.)
- c. Measure the power spectral density (for emissions mask reference) using the following procedure:
 - a) Set the span to encompass the entire 26 dB EBW of the signal.
 - b) Set RBW = same RBW used for 26 dB EBW measurement.
 - c) Set VBW \geq [3 X RBW].
 - d) Number of points in sweep \geq [2 X span / RBW].
 - e) Sweep time = auto.
 - f) Detector = RMS (i.e., power averaging).
 - g) Trace average at least 100 traces in power averaging (rms) mode.
 - h) Use the peak search function on the instrument to find the peak of the spectrum.
- d. Using the measuring equipment limit line function, develop the emissions mask based on the following requirements. The emissions power spectral density must be reduced below the peak power spectral density (in dB) as follows:
 - a) Suppressed by 20 dB at 1 MHz outside of the channel edge. (The channel edge is defined as the 26-dB point on either side of the carrier center frequency.)
 - b) Suppressed by 28 dB at one channel bandwidth from the channel center.
 - c) Suppressed by 40 dB at one- and one-half times the channel bandwidth from the channel center.
- e. Adjust the span to encompass the entire mask as necessary and clear trace.
- f. Trace average at least 100 traces in power averaging (rms) mode.
- g. Adjust the reference level as necessary so that the crest of the channel touches the top of the emission mask

6.5 Occupied Bandwidth

6.5.1 Test Setup

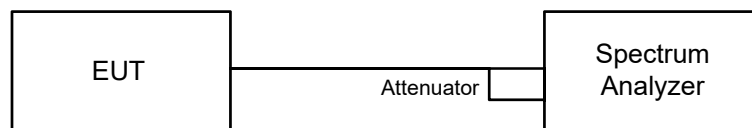

6.5.2 Test Procedure

The transmitter output was connected to the spectrum analyzer through an attenuator. The bandwidth of the fundamental frequency was measured by spectrum analyzer with resolution bandwidth in the range of 1% to 5% of the anticipated emission bandwidth, and a video bandwidth at least 3x the resolution bandwidth and set the detector to Sampling. The width of a frequency band such that, below the lower and above the upper frequency limits, the mean powers emitted are each equal to a specified percentage 0.5% of the total mean power of a given emission.

6.6 Frequency Stability

6.6.1 Test Setup

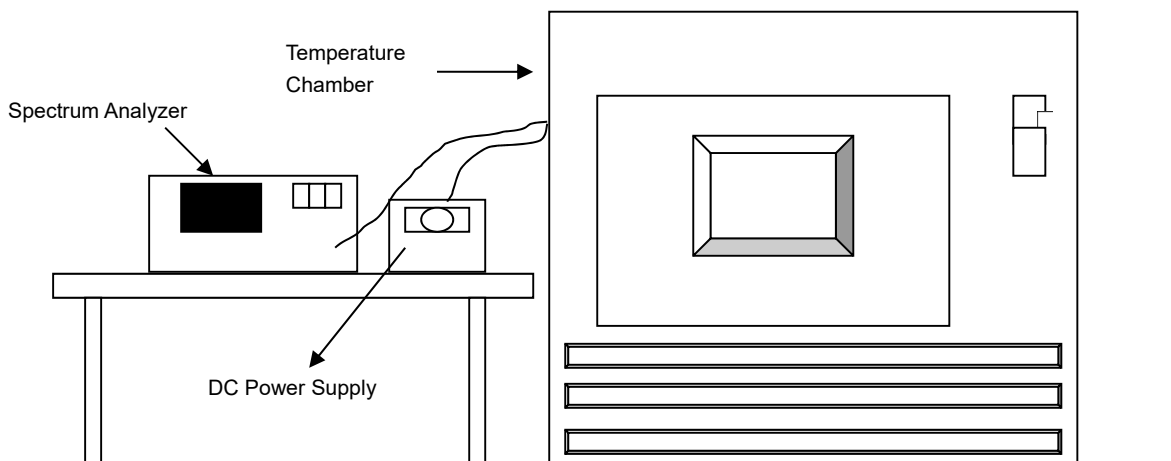

6.6.2 Test Procedure

- The EUT was placed inside the environmental test chamber and powered by nominal DC voltage.
- Turn the EUT on and couple its output to a spectrum analyzer.
- Turn the EUT off and set the chamber to the highest temperature specified.
- Allow sufficient time (approximately 30 min) for the temperature of the chamber to stabilize, turn the EUT on and measure the operating frequency after 2, 5, and 10 Minutes.
- Repeat step (d) with the temperature chamber set to the next desired temperature until measurements down to the lowest specified temperature have been completed.
- The test chamber was allowed to stabilize at +20 degree C for a minimum of 30 Minutes. The supply voltage was then adjusted on the EUT from 85% to 115% and the frequency record.

6.7 Contention-based Protocol

6.7.1 Test Setup

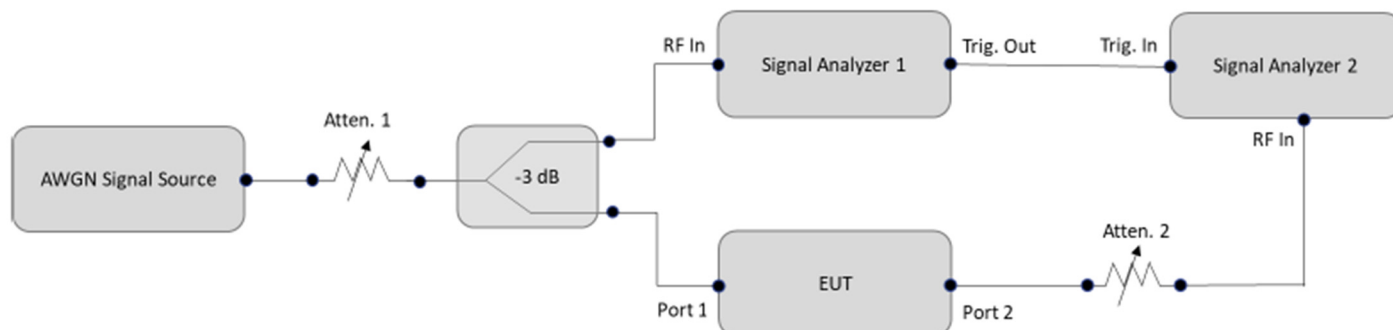

6.7.2 Test Procedure

- Set the signal analyzer center frequency to the nominal EUT channel center frequency. The span range of the signal analyzer shall be between two times and five times the OBW of the EUT. Connect the output port of the EUT to the signal analyzer 2. Ensure that the attenuator 2 provides enough attenuation to not overload the signal analyzer 2 receiver.
- Monitoring the signal analyzer 2, verify the EUT is operating and transmitting with the parameters (set as following section 4.7.5 EUT operating condition).
- Determine number of times detection threshold test as following table,

If	Number of Tests	Placement of Incumbent Transmission
$BW_{EUT} \leq BW_{Inc}$	Once	Same as EUT transmission
$BW_{Inc} < BW_{EUT} \leq 2 \times BW_{Inc}$	Once	Contained within BW_{EUT}
$2 \times BW_{Inc} < BW_{EUT} \leq 4 \times BW_{Inc}$	Twice. (Incumbent transmission is contained within BW_{EUT})	Closely to the lower edge and upper edge of the EUT Channel
$BW_{EUT} > 4 \times BW_{Inc}$	Three times	Closely to the lower edge, in the middle and upper edge of the EUT Channel

- Using an AWGN signal source, generate (but do not transmit, i.e., RF OFF) a 10 MHz-wide AWGN signal. Use step c table to determine the center frequency of the 10 MHz AWGN signal relative to the EUT's channel bandwidth and center frequency.
- Set the AWGN signal power to an extremely low level (more than 20 dB below the -62 dBm threshold). Connect the AWGN signal source, via a 3-dB splitter, to the signal analyzer 1 and the EUT.
- Transmit the AWGN signal (RF ON) and verify its characteristics on the signal analyzer 1.
- Monitor the signal analyzer 2 to verify if the AWGN signal has been detected and the EUT has ceased transmission. If the EUT continues to transmit, then incrementally increase the AWGN signal power level until the EUT stops transmitting.
- (Including all losses in the RF paths) Determine and record the AWGN signal power level (at the EUT's antenna port) at which the EUT ceased transmission. Repeat the procedure at least 10 times to verify the EUT can detect an AWGN signal with 90% (or better) level of certainty.
- Refer to step c table to determine number of times the detection threshold testing needs to be repeated. If testing is required more than once, then go back to step d, choose a different center frequency for the AWGN signal and repeat the process.

6.8 AC Power Conducted Emissions

6.8.1 Test Setup

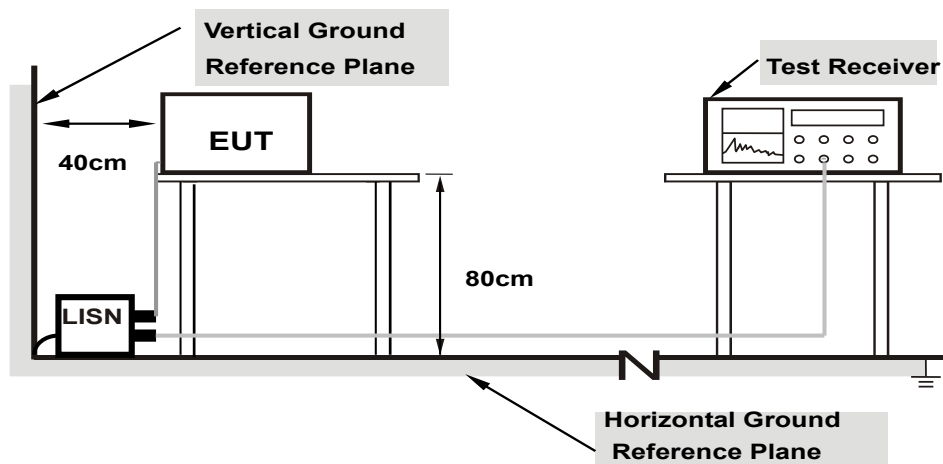

Note: 1. Support units were connected to second LISN.

For the actual test configuration, please refer to the attached file (Test Setup Photo).

6.8.2 Test Procedure

- The EUT was placed on a 0.8 meter to the top of table and placed 0.4 meters from the conducting wall of the shielded room with EUT being connected to the power mains through a line impedance stabilization network (LISN). Other support units were connected to the power mains through another LISN. The two LISNs provide 50 ohm/ 50 uH of coupling impedance for the measuring instrument.
- Both lines of the power mains connected to the EUT were checked for maximum conducted interference.
- The frequency range from 150 kHz to 30 MHz was searched. Emission levels under (Limit – 20 dB) was not recorded.

Note: The resolution bandwidth and video bandwidth of test receiver is 9 kHz for quasi-peak detection (QP) and average detection (AV) at frequency 0.15 MHz-30 MHz.

6.9 Unwanted Emissions below 1 GHz

6.9.1 Test Setup

For Conducted Configuration:

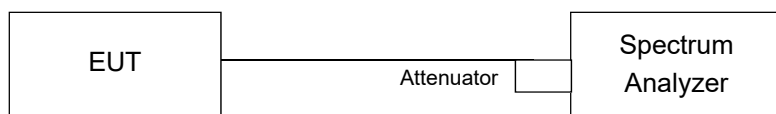

For Radiated Configuration:

For Radiated emission below 30 MHz

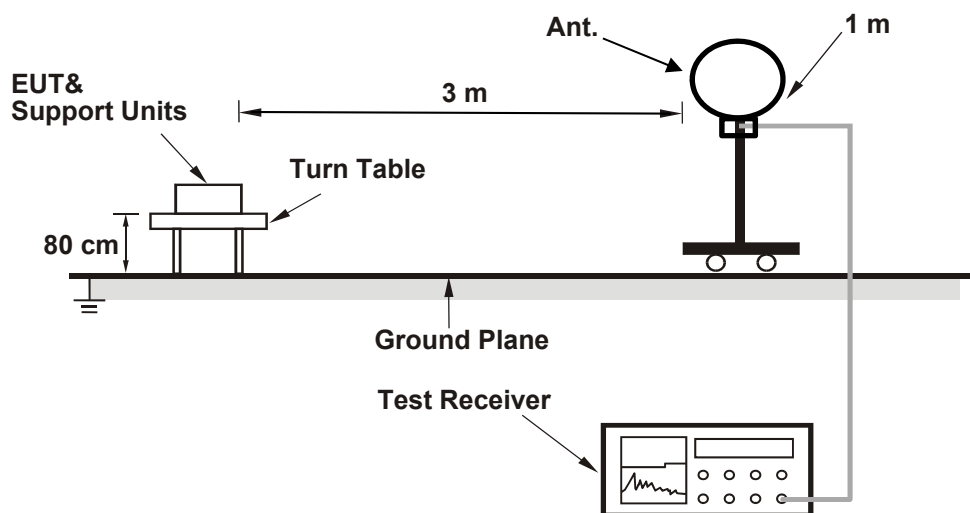

For Radiated emission above 30 MHz

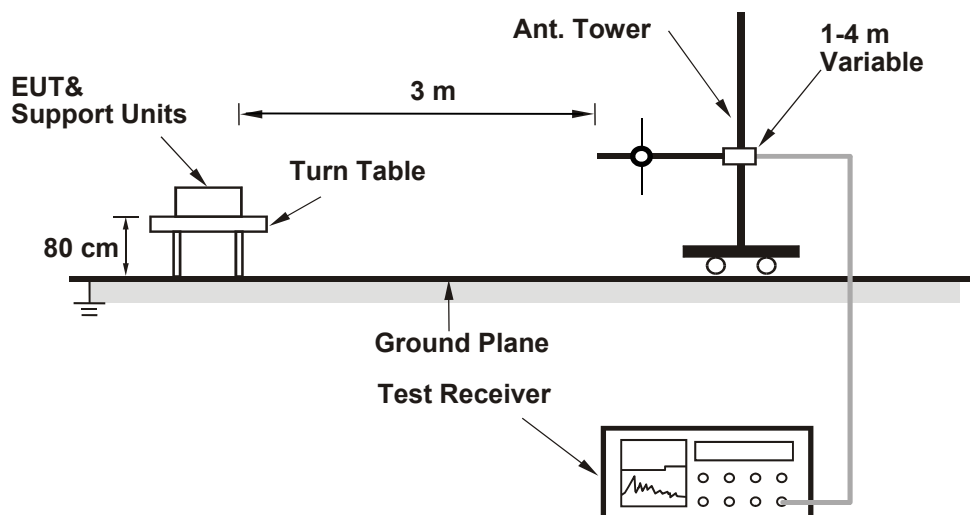

For the actual test configuration, please refer to the attached file (Test Setup Photo).

6.9.2 Test Procedure

Following FCC KDB 789033 D02 General UNII Test Procedures:

Radiated versus Conducted Measurements.

The unwanted emission limits in both the restricted and non-restricted bands are based on antenna-port conducted measurements in conjunction with cabinet emissions tests are permitted to demonstrate compliance.

The following steps was performed:

- a. Cabinet emissions measurements. Radiated measurement was performed to ensure that cabinet emissions are below the emission limits. For the cabinet-emission measurements the antenna was replaced by a termination matching the nominal impedance of the antenna.
- b. Conducted tests was performed using equipment that matches the nominal impedance of the antenna assembly used with the EUT.
- c. EIRP calculation. A value representative of an upper bound on out-of-band antenna gain (in dBi) shall be added to the measured antenna-port conducted emission power to compute EIRP within the specified measurement bandwidth. (For emissions in the restricted bands, additional calculations are required to convert EIRP to field strength at the specified distance.) The upper bound on antenna gain for a device with a single RF output shall be selected as the maximum in-band gain of the antenna across all operating bands or 2 dBi, whichever is greater.
- d. EIRP adjustments for multiple outputs. (Follow the procedures specified in FCC KDB Publication 662911)
- e. For all of Radiation emission test

For Radiated emission below 30 MHz

- a. The EUT was placed on the top of a rotating table 0.8 meters above the ground at 3 meter chamber room for test. The table was rotated 360 degrees to determine the position of the highest radiation.
- b. The EUT was set 3 meters away from the interference-receiving antenna, which was mounted on the top of a variable-height antenna tower.
- c. Parallel, perpendicular, and ground-parallel orientations of the antenna are set to make the measurement.
- d. For each suspected emission, the EUT was arranged to its worst case and the rotatable table was turned from 0 degrees to 360 degrees to find the maximum reading.
- e. The test-receiver system was set to Quasi-Peak Detect Function and Specified Bandwidth with Maximum Hold Mode, except for the frequency band (9 kHz to 90 kHz and 110 kHz to 490 kHz) set to average detect function and peak detect function.

Notes:

1. The resolution bandwidth and video bandwidth of test receiver/spectrum analyzer is 200 Hz at frequency below 150 kHz.
2. The resolution bandwidth and video bandwidth of test receiver/spectrum analyzer is 9 kHz or 10 kHz at frequency (150 kHz to 30 MHz).
3. All modes of operation were investigated and the worst-case emissions are reported.

For Radiated emission above 30 MHz

- a. The EUT was placed on the top of a rotating table 0.8 meters above the ground at 3 meter chamber room for test. The table was rotated 360 degrees to determine the position of the highest radiation.
- b. The EUT was set 3 meters away from the interference-receiving antenna, which was mounted on the top of a variable-height antenna tower.
- c. The height of antenna is varied from one meter to four meters above the ground to determine the maximum value of the field strength. Both horizontal and vertical polarizations of the antenna are set to make the measurement.
- d. For each suspected emission, the EUT was arranged to its worst case and then the antenna was tuned to heights from 1 meter to 4 meters and the rotatable table was turned from 0 degrees to 360 degrees to find the maximum reading.
- e. The test-receiver system was set to quasi-peak detect function and specified bandwidth with maximum hold mode when the test frequency is below 1 GHz.

Notes:

1. The resolution bandwidth and video bandwidth of test receiver/spectrum analyzer is 120 kHz for Quasi-peak detection (QP) at frequency below 1 GHz.
2. All modes of operation were investigated and the worst-case emissions are reported.

6.10 Unwanted Emissions above 1 GHz

6.10.1 Test Setup

For Conducted Configuration:

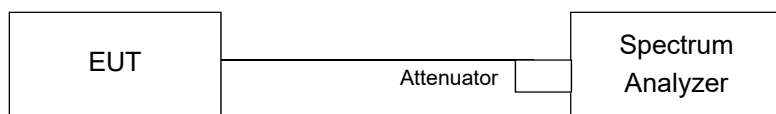

For Radiated Configuration:

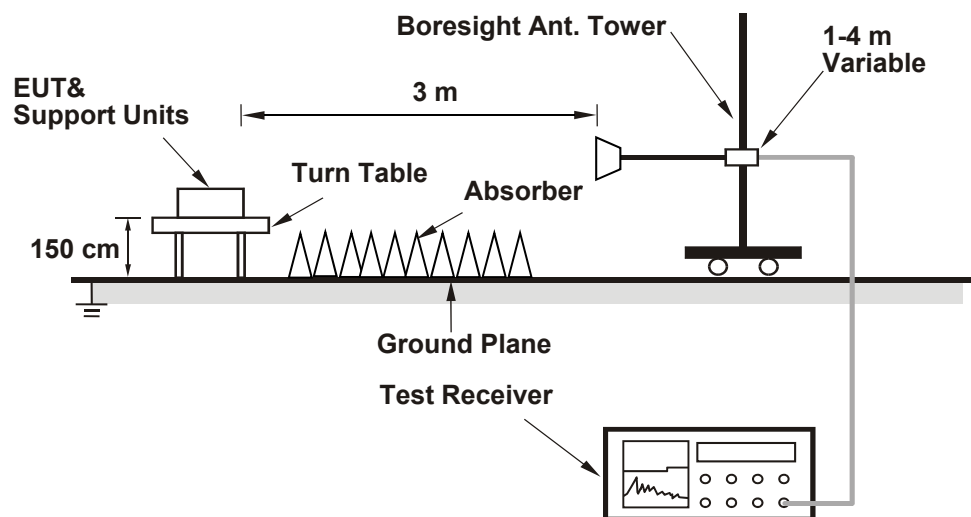

For the actual test configuration, please refer to the attached file (Test Setup Photo).

6.10.2 Test Procedure

Following FCC KDB 789033 D02 General UNII Test Procedures:

Radiated versus Conducted Measurements.

The unwanted emission limits in both the restricted and non-restricted bands are based on antenna-port conducted measurements in conjunction with cabinet emissions tests are permitted to demonstrate compliance.

The following steps was performed:

- a. Cabinet emissions measurements. Radiated measurement was performed to ensure that cabinet emissions are below the emission limits. For the cabinet-emission measurements the antenna was replaced by a termination matching the nominal impedance of the antenna.
- b. Conducted tests was performed using equipment that matches the nominal impedance of the antenna assembly used with the EUT.
- c. EIRP calculation. A value representative of an upper bound on out-of-band antenna gain (in dBi) shall be added to the measured antenna-port conducted emission power to compute EIRP within the specified measurement bandwidth. (For emissions in the restricted bands, additional calculations are required to convert EIRP to field strength at the specified distance.) The upper bound on antenna gain for a device with a single RF output shall be selected as the maximum in-band gain of the antenna across all operating bands or 2 dBi, whichever is greater.
- d. EIRP adjustments for multiple outputs. (Follow the procedures specified in FCC KDB Publication 662911)
- e. For all of Radiation emission test

For Radiated emission above 1 GHz

- a. The EUT was placed on the top of a rotating table 1.5 meters above the ground at 3 meter chamber room for test. The table was rotated 360 degrees to determine the position of the highest radiation.
- b. The EUT was set 3 meters away from the interference-receiving antenna, which was mounted on the top of a variable-height antenna tower.
- c. The height of antenna is varied from one meter to four meters above the ground to determine the maximum value of the field strength. Both horizontal and vertical polarizations of the antenna are set to make the measurement.
- d. For each suspected emission, the EUT was arranged to its worst case and then the antenna was tuned to heights from 1 meter to 4 meters and the rotatable table was turned from 0 degrees to 360 degrees to find the maximum reading.
- e. The test-receiver system was set to peak and average detects function and specified bandwidth with maximum hold mode when the test frequency is above 1 GHz. If the peak reading value also meets average limit, measurement with the average detector is unnecessary.

Notes:

1. The resolution bandwidth of test receiver/spectrum analyzer is 1 MHz and the video bandwidth is 3 MHz for Peak detection (PK) and Average detection (AV) at frequency above 1 GHz.
2. For fundamental and harmonic signal measurement, the resolution bandwidth of test receiver/spectrum analyzer is 1 MHz and the video bandwidth is $\geq 1/T$ (Duty cycle < 98%) or 10 Hz (Duty cycle $\geq 98\%$) for Average detection (AV) at frequency above 1 GHz.
3. All modes of operation were investigated and the worst-case emissions are reported.

7 Test Results of Test Item

7.1 RF Output Power

Mode A

Input Power:	3.3 Vdc	Environmental Conditions:	24°C, 65% RH	Tested By:	Eric Peng
--------------	---------	---------------------------	--------------	------------	-----------

802.11a

Chan.	Chan. Freq. (MHz)	Average Power (dBm)		Total Power (mW)	Total Power (dBm)	Maximum Gain (dBi)	EIRP (mW)	EIRP (dBm)	EIRP Limit (dBm)	Test Result
		Chain 0	Chain 1							
2	5935	-0.78	-2.16	1.4437	1.59	5.14	4.715	6.73	24	Pass
1	5955	-0.65	-1.97	1.4963	1.75	5.14	4.887	6.89	24	Pass
45	6175	-1.67	-1.90	1.3264	1.23	5.14	4.332	6.37	24	Pass
93	6415	-1.37	-2.36	1.3102	1.17	5.14	4.279	6.31	24	Pass
97	6435	-0.92	-1.83	1.4652	1.66	5.09	4.73	6.75	24	Pass
105	6475	-0.85	-1.76	1.489	1.73	5.09	4.807	6.82	24	Pass
113	6515	-0.71	-1.68	1.5284	1.84	5.09	4.934	6.93	24	Pass
117	6535	-0.83	-1.49	1.5356	1.86	5.16	5.038	7.02	24	Pass
149	6695	-1.08	-1.15	1.5472	1.90	5.16	5.076	7.06	24	Pass
181	6855	-1.47	-1.24	1.4645	1.66	5.16	4.805	6.82	24	Pass
185	6875	-1.87	-2.06	1.2724	1.05	5.16	4.175	6.21	24	Pass
209	6995	-1.82	-1.80	1.3184	1.20	5.12	4.286	6.32	24	Pass
233	7115	-2.17	-1.68	1.2859	1.09	5.12	4.18	6.21	24	Pass

Notes:

1. Directional gain is the maximum gain of antennas.
2. For U-NII-5, The maximum gain is 5.14 dBi
3. For U-NII-6, The maximum gain is 5.09 dBi
4. For U-NII-7, The maximum gain is 5.16 dBi
5. For U-NII-8, The maximum gain is 5.12 dBi

802.11be (EHT20)

Chan.	Chan. Freq. (MHz)	Average Power (dBm)		Total Power (mW)	Total Power (dBm)	Maximum Gain (dBi)	EIRP (mW)	EIRP (dBm)	EIRP Limit (dBm)	Test Result
		Chain 0	Chain 1							
2	5935	-11.72	-12.95	0.118	-9.28	5.14	0.3854	-4.14	24	Pass
1	5955	-0.33	-1.44	1.6446	2.16	5.14	5.371	7.3	24	Pass
45	6175	-1.34	-1.47	1.4474	1.61	5.14	4.727	6.75	24	Pass
93	6415	-1.02	-1.99	1.4231	1.53	5.14	4.648	6.67	24	Pass
97	6435	-0.56	-1.58	1.574	1.97	5.09	5.082	7.06	24	Pass
105	6475	-0.53	-1.49	1.5947	2.03	5.09	5.148	7.12	24	Pass
113	6515	-0.34	-1.28	1.6694	2.23	5.09	5.39	7.32	24	Pass
117	6535	-0.49	-1.12	1.666	2.22	5.16	5.466	7.38	24	Pass
149	6695	-0.76	-0.77	1.677	2.25	5.16	5.502	7.41	24	Pass
181	6855	-1.09	-0.81	1.6079	2.06	5.16	5.275	7.22	24	Pass
185	6875	-1.06	-1.20	1.542	1.88	5.16	5.059	7.04	24	Pass
209	6995	-0.77	-0.90	1.6504	2.18	5.12	5.365	7.3	24	Pass
233	7115	-12.16	-11.39	0.13342	-8.75	5.12	0.4337	-3.63	24	Pass

Notes:

1. Directional gain is the maximum gain of antennas.
2. For U-NII-5, The maximum gain is 5.14 dBi
3. For U-NII-6, The maximum gain is 5.09 dBi
4. For U-NII-7, The maximum gain is 5.16 dBi
5. For U-NII-8, The maximum gain is 5.12 dBi

802.11be (EHT40)

Chan.	Chan. Freq. (MHz)	Average Power (dBm)		Total Power (mW)	Total Power (dBm)	Maximum Gain (dBi)	EIRP (mW)	EIRP (dBm)	EIRP Limit (dBm)	Test Result
		Chain 0	Chain 1							
3	5965	3.20	3.14	4.15	6.18	5.14	13.553	11.32	24	Pass
43	6165	2.83	3.09	3.956	5.97	5.14	12.92	11.11	24	Pass
91	6405	2.56	3.23	3.907	5.92	5.14	12.76	11.06	24	Pass
99	6445	2.64	3.32	3.984	6.00	5.09	12.862	11.09	24	Pass
107	6485	2.74	3.34	4.037	6.06	5.09	13.033	11.15	24	Pass
115	6525	2.86	3.13	3.988	6.01	5.16	13.084	11.17	24	Pass
123	6565	2.79	3.48	4.13	6.16	5.16	13.55	11.32	24	Pass
155	6725	2.40	3.65	4.055	6.08	5.16	13.304	11.24	24	Pass
179	6845	2.69	3.27	3.981	6.00	5.16	13.061	11.16	24	Pass
187	6885	2.14	2.85	3.564	5.52	5.12	11.586	10.64	24	Pass
211	7005	2.31	3.51	3.946	5.96	5.12	12.828	11.08	24	Pass
227	7085	2.19	3.53	3.91	5.92	5.12	12.711	11.04	24	Pass

Notes:

1. Directional gain is the maximum gain of antennas.
2. For U-NII-5, The maximum gain is 5.14 dBi
3. For U-NII-6, The maximum gain is 5.09 dBi
4. For U-NII-7, The maximum gain is 5.16 dBi
5. For U-NII-8, The maximum gain is 5.12 dBi

802.11be (EHT80)

Chan.	Chan. Freq. (MHz)	Average Power (dBm)		Total Power (mW)	Total Power (dBm)	Maximum Gain (dBi)	EIRP (mW)	EIRP (dBm)	EIRP Limit (dBm)	Test Result
		Chain 0	Chain 1							
7	5985	4.79	4.82	6.047	7.82	5.14	19.749	12.96	24	Pass
39	6145	4.64	4.92	6.015	7.79	5.14	19.644	12.93	24	Pass
87	6385	4.28	5.47	6.203	7.93	5.14	20.258	13.07	24	Pass
103	6465	5.22	5.99	7.299	8.63	5.09	23.565	13.72	24	Pass
119	6545	5.16	5.45	6.788	8.32	5.16	22.271	13.48	24	Pass
151	6705	4.26	5.82	6.486	8.12	5.16	21.28	13.28	24	Pass
183	6865	4.58	5.38	6.322	8.01	5.16	20.742	13.17	24	Pass
199	6945	4.75	5.19	6.289	7.99	5.12	20.445	13.11	24	Pass
215	7025	4.66	5.25	6.274	7.98	5.12	20.396	13.1	24	Pass

Notes:

1. Directional gain is the maximum gain of antennas.
2. For U-NII-5, The maximum gain is 5.14 dBi
3. For U-NII-6, The maximum gain is 5.09 dBi
4. For U-NII-7, The maximum gain is 5.16 dBi
5. For U-NII-8, The maximum gain is 5.12 dBi

802.11be (EHT160)

Chan.	Chan. Freq. (MHz)	Average Power (dBm)		Total Power (mW)	Total Power (dBm)	Maximum Gain (dBi)	EIRP (mW)	EIRP (dBm)	EIRP Limit (dBm)	Test Result
		Chain 0	Chain 1							
15	6025	8.38	8.64	14.198	11.52	5.14	46.369	16.66	24	Pass
47	6185	8.58	9.03	15.209	11.82	5.14	49.671	16.96	24	Pass
79	6345	7.86	8.73	13.574	11.33	5.14	44.331	16.47	24	Pass
111	6505	8.48	8.94	14.881	11.73	5.09	48.043	16.82	24	Pass
143	6665	8.11	8.78	14.022	11.47	5.16	46.006	16.63	24	Pass
175	6825	7.99	8.74	13.777	11.39	5.16	45.202	16.55	24	Pass
207	6985	8.08	8.91	14.207	11.53	5.12	46.185	16.65	24	Pass

Notes:

1. Directional gain is the maximum gain of antennas.
2. For U-NII-5, The maximum gain is 5.14 dBi
3. For U-NII-6, The maximum gain is 5.09 dBi
4. For U-NII-7, The maximum gain is 5.16 dBi
5. For U-NII-8, The maximum gain is 5.12 dBi

802.11be (EHT320)

Chan.	Chan. Freq. (MHz)	Average Power (dBm)		Total Power (mW)	Total Power (dBm)	Maximum Gain (dBi)	EIRP (mW)	EIRP (dBm)	EIRP Limit (dBm)	Test Result
		Chain 0	Chain 1							
31	6105	11.86	11.84	30.622	14.86	5.14	100.008	20	24	Pass
63	6265	11.83	11.82	30.446	14.84	5.14	99.433	19.98	24	Pass
95	6425	11.45	11.75	28.926	14.61	5.14	94.469	19.75	24	Pass
127	6585	11.14	11.73	27.895	14.46	5.16	91.522	19.62	24	Pass
159	6745	10.85	11.98	27.938	14.46	5.16	91.663	19.62	24	Pass
191	6905	10.93	11.78	27.454	14.39	5.16	90.075	19.55	24	Pass

Notes:

1. Directional gain is the maximum gain of antennas.
2. For U-NII-5, The maximum gain is 5.14 dBi
3. For U-NII-6, The maximum gain is 5.09 dBi
4. For U-NII-7, The maximum gain is 5.16 dBi
5. For U-NII-8, The maximum gain is 5.12 dBi

802.11be (EHT20) 26-tone RU

Chan.	Chan. Freq. (MHz)	Average Power (dBm)		Total Power (mW)	Total Power (dBm)	Maximum Gain (dBi)	EIRP (mW)	EIRP (dBm)	EIRP Limit (dBm)	Test Result
		Chain 0	Chain 1							
2	5935	-19.20	-20.07	0.021863	-16.60	5.14	0.0714	-11.46	24	Pass
1	5955	-8.82	-9.81	0.2357	-6.28	5.14	0.7698	-1.14	24	Pass
45	6175	-10.06	-9.78	0.20382	-6.91	5.14	0.6657	-1.77	24	Pass
93	6415	-9.64	-10.27	0.20261	-6.93	5.14	0.6617	-1.79	24	Pass
97	6435	-9.67	-10.27	0.20187	-6.95	5.09	0.6517	-1.86	24	Pass
105	6475	-9.61	-10.12	0.20667	-6.85	5.09	0.6672	-1.76	24	Pass
113	6515	-9.47	-9.95	0.2141	-6.69	5.09	0.6912	-1.6	24	Pass
117	6535	-9.50	-9.83	0.2162	-6.65	5.16	0.7093	-1.49	24	Pass
149	6695	-9.60	-9.31	0.2269	-6.44	5.16	0.7444	-1.28	24	Pass
181	6855	-10.00	-9.49	0.2125	-6.73	5.16	0.6972	-1.57	24	Pass
185	6875	-9.95	-9.73	0.2076	-6.83	5.16	0.6811	-1.67	24	Pass
209	6995	-9.73	-9.75	0.2123	-6.73	5.12	0.6902	-1.61	24	Pass
233	7115	-19.03	-18.45	0.02679	-15.72	5.12	0.08709	-10.6	24	Pass

Notes:

1. Directional gain is the maximum gain of antennas.
2. For U-NII-5, The maximum gain is 5.14 dBi
3. For U-NII-6, The maximum gain is 5.09 dBi
4. For U-NII-7, The maximum gain is 5.16 dBi
5. For U-NII-8, The maximum gain is 5.12 dBi

802.11be (EHT20) 52-tone RU

Chan.	Chan. Freq. (MHz)	Average Power (dBm)		Total Power (mW)	Total Power (dBm)	Maximum Gain (dBi)	EIRP (mW)	EIRP (dBm)	EIRP Limit (dBm)	Test Result
		Chain 0	Chain 1							
2	5935	-16.80	-17.72	0.0378	-14.23	5.14	0.1235	-9.08	24	Pass
1	5955	-6.11	-7.04	0.4426	-3.54	5.14	1.445	1.6	24	Pass
45	6175	-7.40	-6.97	0.3829	-4.17	5.14	1.251	0.97	24	Pass
93	6415	-6.80	-7.34	0.3934	-4.05	5.14	1.285	1.09	24	Pass
97	6435	-7.12	-7.51	0.3715	-4.30	5.09	1.199	0.79	24	Pass
105	6475	-7.11	-7.33	0.3795	-4.21	5.09	1.225	0.88	24	Pass
113	6515	-6.55	-6.90	0.4255	-3.71	5.09	1.374	1.38	24	Pass
117	6535	-7.06	-7.09	0.3922	-4.06	5.16	1.287	1.1	24	Pass
149	6695	-7.14	-7.02	0.3918	-4.07	5.16	1.285	1.09	24	Pass
181	6855	-7.31	-6.77	0.3962	-4.02	5.16	1.3	1.14	24	Pass
185	6875	-7.34	-7.02	0.3831	-4.17	5.16	1.257	0.99	24	Pass
209	6995	-7.20	-7.13	0.3842	-4.15	5.12	1.249	0.97	24	Pass
233	7115	-17.30	-16.51	0.04096	-13.88	5.12	0.1332	-8.75	24	Pass

Notes:

1. Directional gain is the maximum gain of antennas.
2. For U-NII-5, The maximum gain is 5.14 dBi
3. For U-NII-6, The maximum gain is 5.09 dBi
4. For U-NII-7, The maximum gain is 5.16 dBi
5. For U-NII-8, The maximum gain is 5.12 dBi

802.11be (EHT20) 106-tone RU

Chan.	Chan. Freq. (MHz)	Average Power (dBm)		Total Power (mW)	Total Power (dBm)	Maximum Gain (dBi)	EIRP (mW)	EIRP (dBm)	EIRP Limit (dBm)	Test Result
		Chain 0	Chain 1							
2	5935	-15.00	-15.71	0.05848	-12.33	5.14	0.191	-7.19	24	Pass
1	5955	-2.86	-3.58	0.9561	-0.19	5.14	3.123	4.95	24	Pass
45	6175	-3.79	-3.94	0.8215	-0.85	5.14	2.683	4.29	24	Pass
93	6415	-3.79	-4.43	0.7784	-1.09	5.14	2.542	4.05	24	Pass
97	6435	-3.34	-3.93	0.868	-0.61	5.09	2.802	4.47	24	Pass
105	6475	-3.42	-3.64	0.8875	-0.52	5.09	2.865	4.57	24	Pass
113	6515	-3.19	-3.51	0.9254	-0.34	5.09	2.988	4.75	24	Pass
117	6535	-3.32	-3.52	0.9102	-0.41	5.16	2.986	4.75	24	Pass
149	6695	-3.37	-3.34	0.9237	-0.34	5.16	3.031	4.82	24	Pass
181	6855	-3.86	-3.15	0.8953	-0.48	5.16	2.937	4.68	24	Pass
185	6875	-3.77	-3.57	0.8593	-0.66	5.16	2.819	4.5	24	Pass
209	6995	-3.80	-3.78	0.8357	-0.78	5.12	2.717	4.34	24	Pass
233	7115	-14.77	-13.92	0.07389	-11.31	5.12	0.2402	-6.19	24	Pass

Notes:

1. Directional gain is the maximum gain of antennas.
2. For U-NII-5, The maximum gain is 5.14 dBi
3. For U-NII-6, The maximum gain is 5.09 dBi
4. For U-NII-7, The maximum gain is 5.16 dBi
5. For U-NII-8, The maximum gain is 5.12 dBi

802.11be (EHT20) 242-tone RU

Chan.	Chan. Freq. (MHz)	Average Power (dBm)		Total Power (mW)	Total Power (dBm)	Maximum Gain (dBi)	EIRP (mW)	EIRP (dBm)	EIRP Limit (dBm)	Test Result
		Chain 0	Chain 1							
2	5935	-0.09	-1.01	1.772	2.48	5.14	5.787	7.62	24	Pass
1	5955	0.00	-0.96	1.8017	2.56	5.14	5.884	7.7	24	Pass
45	6175	-0.96	-0.70	1.6528	2.18	5.14	5.398	7.32	24	Pass
93	6415	-0.69	-1.34	1.5876	2.01	5.14	5.185	7.15	24	Pass
97	6435	-0.29	-0.87	1.7539	2.44	5.09	5.662	7.53	24	Pass
105	6475	-0.27	-0.76	1.7792	2.50	5.09	5.744	7.59	24	Pass
113	6515	-0.04	-0.65	1.8518	2.68	5.09	5.979	7.77	24	Pass
117	6535	-0.30	-0.47	1.8307	2.63	5.16	6.006	7.79	24	Pass
149	6695	-0.33	-0.16	1.8907	2.77	5.16	6.203	7.93	24	Pass
181	6855	-0.73	-0.26	1.7872	2.52	5.16	5.864	7.68	24	Pass
185	6875	-0.69	-0.55	1.7341	2.39	5.16	5.69	7.55	24	Pass
209	6995	-0.55	-0.13	1.8516	2.68	5.12	6.019	7.8	24	Pass
233	7115	-0.85	-0.04	1.8131	2.58	5.12	5.894	7.7	24	Pass

Notes:

1. Directional gain is the maximum gain of antennas.
2. For U-NII-5, The maximum gain is 5.14 dBi
3. For U-NII-6, The maximum gain is 5.09 dBi
4. For U-NII-7, The maximum gain is 5.16 dBi
5. For U-NII-8, The maximum gain is 5.12 dBi

802.11be (EHT40) 484-tone RU

Chan.	Chan. Freq. (MHz)	Average Power (dBm)		Total Power (mW)	Total Power (dBm)	Maximum Gain (dBi)	EIRP (mW)	EIRP (dBm)	EIRP Limit (dBm)	Test Result
		Chain 0	Chain 1							
3	5965	3.09	3.23	4.141	6.17	5.14	13.524	11.31	24	Pass
43	6165	2.67	3.17	3.924	5.94	5.14	12.815	11.08	24	Pass
91	6405	2.23	3.13	3.727	5.71	5.14	12.172	10.85	24	Pass
99	6445	2.85	3.66	4.25	6.28	5.09	13.721	11.37	24	Pass
107	6485	2.91	3.66	4.277	6.31	5.09	13.808	11.4	24	Pass
115	6525	2.76	3.09	3.925	5.94	5.16	12.878	11.1	24	Pass
123	6565	2.50	3.31	3.921	5.93	5.16	12.865	11.09	24	Pass
155	6725	2.26	3.49	3.916	5.93	5.16	12.848	11.09	24	Pass
179	6845	2.41	3.14	3.802	5.80	5.16	12.474	10.96	24	Pass
187	6885	1.94	2.78	3.46	5.39	5.12	11.248	10.51	24	Pass
211	7005	2.13	2.97	3.615	5.58	5.12	11.752	10.7	24	Pass
227	7085	2.06	3.10	3.649	5.62	5.12	11.862	10.74	24	Pass

Notes:

1. Directional gain is the maximum gain of antennas.
2. For U-NII-5, The maximum gain is 5.14 dBi
3. For U-NII-6, The maximum gain is 5.09 dBi
4. For U-NII-7, The maximum gain is 5.16 dBi
5. For U-NII-8, The maximum gain is 5.12 dBi

802.11be (EHT80) 996-tone RU

Chan.	Chan. Freq. (MHz)	Average Power (dBm)		Total Power (mW)	Total Power (dBm)	Maximum Gain (dBi)	EIRP (mW)	EIRP (dBm)	EIRP Limit (dBm)	Test Result
		Chain 0	Chain 1							
7	5985	6.30	6.57	8.805	9.45	5.14	28.756	14.59	24	Pass
39	6145	5.06	5.55	6.795	8.32	5.14	22.192	13.46	24	Pass
87	6385	4.74	6.01	6.969	8.43	5.14	22.76	13.57	24	Pass
103	6465	4.82	6.06	7.07	8.49	5.09	22.825	13.58	24	Pass
119	6545	5.59	6.05	7.65	8.84	5.16	25.099	14	24	Pass
151	6705	4.77	6.33	7.295	8.63	5.16	23.935	13.79	24	Pass
183	6865	5.06	5.95	7.142	8.54	5.16	23.433	13.7	24	Pass
199	6945	5.57	6.00	7.587	8.80	5.12	24.664	13.92	24	Pass
215	7025	5.31	5.98	7.359	8.67	5.12	23.923	13.79	24	Pass

Notes:

1. Directional gain is the maximum gain of antennas.
2. For U-NII-5, The maximum gain is 5.14 dBi
3. For U-NII-6, The maximum gain is 5.09 dBi
4. For U-NII-7, The maximum gain is 5.16 dBi
5. For U-NII-8, The maximum gain is 5.12 dBi

802.11be (EHT160) 2x996-tone RU

Chan.	Chan. Freq. (MHz)	Average Power (dBm)		Total Power (mW)	Total Power (dBm)	Maximum Gain (dBi)	EIRP (mW)	EIRP (dBm)	EIRP Limit (dBm)	Test Result
		Chain 0	Chain 1							
15	6025	6.93	7.96	11.183	10.49	5.14	36.522	15.63	24	Pass
47	6185	7.07	7.80	11.119	10.46	5.14	36.313	15.6	24	Pass
79	6345	6.81	7.48	10.395	10.17	5.14	33.949	15.31	24	Pass
111	6505	7.00	7.68	10.873	10.36	5.09	35.103	15.45	24	Pass
143	6665	6.78	7.79	10.776	10.32	5.16	35.356	15.48	24	Pass
175	6825	6.64	7.62	10.394	10.17	5.16	34.102	15.33	24	Pass
207	6985	7.01	7.83	11.091	10.45	5.12	36.055	15.57	24	Pass

Notes:

1. Directional gain is the maximum gain of antennas.
2. For U-NII-5, The maximum gain is 5.14 dBi
3. For U-NII-6, The maximum gain is 5.09 dBi
4. For U-NII-7, The maximum gain is 5.16 dBi
5. For U-NII-8, The maximum gain is 5.12 dBi

802.11be (EHT20) 52+26-tone MRU

Chan.	Chan. Freq. (MHz)	Average Power (dBm)		Total Power (mW)	Total Power (dBm)	Maximum Gain (dBi)	EIRP (mW)	EIRP (dBm)	EIRP Limit (dBm)	Test Result
		Chain 0	Chain 1							
45	6175	-6.18	-5.64	0.5139	-2.89	5.14	1.678	2.25	24	Pass
105	6475	-6.12	-6.30	0.4788	-3.20	5.09	1.546	1.89	24	Pass
185	6875	-6.56	-6.00	0.472	-3.26	5.16	1.549	1.9	24	Pass
209	6995	-6.21	-5.97	0.4923	-3.08	5.12	1.6	2.04	24	Pass

Notes:

1. Directional gain is the maximum gain of antennas.
2. For U-NII-5, The maximum gain is 5.14 dBi
3. For U-NII-6, The maximum gain is 5.09 dBi
4. For U-NII-7, The maximum gain is 5.16 dBi
5. For U-NII-8, The maximum gain is 5.12 dBi

802.11be (EHT20) 106+26-tone MRU

Chan.	Chan. Freq. (MHz)	Average Power (dBm)		Total Power (mW)	Total Power (dBm)	Maximum Gain (dBi)	EIRP (mW)	EIRP (dBm)	EIRP Limit (dBm)	Test Result
		Chain 0	Chain 1							
45	6175	-3.65	-3.05	0.927	-0.33	5.14	3.027	4.81	24	Pass
105	6475	-2.88	-3.22	0.9917	-0.04	5.09	3.202	5.05	24	Pass
185	6875	-3.32	-2.96	0.9714	-0.13	5.16	3.187	5.03	24	Pass
209	6995	-3.09	-2.84	1.0109	0.05	5.12	3.286	5.17	24	Pass

Notes:

1. Directional gain is the maximum gain of antennas.
2. For U-NII-5, The maximum gain is 5.14 dBi
3. For U-NII-6, The maximum gain is 5.09 dBi
4. For U-NII-7, The maximum gain is 5.16 dBi
5. For U-NII-8, The maximum gain is 5.12 dBi

802.11be (EHT80) 484+242-tone MRU

Chan.	Chan. Freq. (MHz)	Average Power (dBm)		Total Power (mW)	Total Power (dBm)	Maximum Gain (dBi)	EIRP (mW)	EIRP (dBm)	EIRP Limit (dBm)	Test Result
		Chain 0	Chain 1							
7	5985	3.80	4.29	5.084	7.06	5.14	16.604	12.2	24	Pass
103	6465	2.91	3.78	4.342	6.38	5.09	14.018	11.47	24	Pass
119	6545	3.10	3.77	4.424	6.46	5.16	14.515	11.62	24	Pass
199	6945	2.68	3.47	4.077	6.10	5.12	13.254	11.22	24	Pass

Notes:

1. Directional gain is the maximum gain of antennas.
2. For U-NII-5, The maximum gain is 5.14 dBi
3. For U-NII-6, The maximum gain is 5.09 dBi
4. For U-NII-7, The maximum gain is 5.16 dBi
5. For U-NII-8, The maximum gain is 5.12 dBi

802.11be (EHT160) 996+484-tone MRU

Chan.	Chan. Freq. (MHz)	Average Power (dBm)		Total Power (mW)	Total Power (dBm)	Maximum Gain (dBi)	EIRP (mW)	EIRP (dBm)	EIRP Limit (dBm)	Test Result
		Chain 0	Chain 1							
47	6185	6.14	6.68	8.767	9.43	5.14	28.632	14.57	24	Pass
111	6505	6.58	7.12	9.702	9.87	5.09	31.323	14.96	24	Pass
143	6665	5.89	7.31	9.264	9.67	5.16	30.395	14.83	24	Pass
207	6985	6.52	7.22	9.76	9.89	5.12	31.729	15.01	24	Pass

Notes:

1. Directional gain is the maximum gain of antennas.
2. For U-NII-5, The maximum gain is 5.14 dBi
3. For U-NII-6, The maximum gain is 5.09 dBi
4. For U-NII-7, The maximum gain is 5.16 dBi
5. For U-NII-8, The maximum gain is 5.12 dBi

802.11be (EHT320) 2x996+484-tone MRU

Chan.	Chan. Freq. (MHz)	Average Power (dBm)		Total Power (mW)	Total Power (dBm)	Maximum Gain (dBi)	EIRP (mW)	EIRP (dBm)	EIRP Limit (dBm)	Test Result
		Chain 0	Chain 1							
63	6265	8.75	9.75	16.94	12.29	5.14	55.324	17.43	24	Pass
159	6745	8.73	10.11	17.721	12.48	5.16	58.142	17.64	24	Pass
191	6905	8.88	9.88	17.454	12.42	5.12	56.741	17.54	24	Pass

Notes:

1. Directional gain is the maximum gain of antennas.
2. For U-NII-5, The maximum gain is 5.14 dBi
3. For U-NII-6, The maximum gain is 5.09 dBi
4. For U-NII-7, The maximum gain is 5.16 dBi
5. For U-NII-8, The maximum gain is 5.12 dBi

802.11be (EHT320) 3x996-tone MRU

Chan.	Chan. Freq. (MHz)	Average Power (dBm)		Total Power (mW)	Total Power (dBm)	Maximum Gain (dBi)	EIRP (mW)	EIRP (dBm)	EIRP Limit (dBm)	Test Result
		Chain 0	Chain 1							
63	6265	7.86	8.89	13.854	11.42	5.14	45.245	16.56	24	Pass
159	6745	7.64	9.17	14.068	11.48	5.16	46.156	16.64	24	Pass
191	6905	7.81	8.77	13.573	11.33	5.12	44.124	16.45	24	Pass

Notes:

1. Directional gain is the maximum gain of antennas.
2. For U-NII-5, The maximum gain is 5.14 dBi
3. For U-NII-6, The maximum gain is 5.09 dBi
4. For U-NII-7, The maximum gain is 5.16 dBi
5. For U-NII-8, The maximum gain is 5.12 dBi

802.11be (EHT320) 3x996+484-tone MRU

Chan.	Chan. Freq. (MHz)	Average Power (dBm)		Total Power (mW)	Total Power (dBm)	Maximum Gain (dBi)	EIRP (mW)	EIRP (dBm)	EIRP Limit (dBm)	Test Result
		Chain 0	Chain 1							
63	6265	7.81	8.77	13.573	11.33	5.14	44.328	16.47	24	Pass
159	6745	7.27	8.20	11.94	10.77	5.16	39.175	15.93	24	Pass
191	6905	7.03	8.50	12.126	10.84	5.12	39.42	15.96	24	Pass

Notes:

1. Directional gain is the maximum gain of antennas.
2. For U-NII-5, The maximum gain is 5.14 dBi
3. For U-NII-6, The maximum gain is 5.09 dBi
4. For U-NII-7, The maximum gain is 5.16 dBi
5. For U-NII-8, The maximum gain is 5.12 dBi

802.11be (EHT80) Punctured by 20 MHz

Chan.	Chan. Freq. (MHz)	Average Power (dBm)		Total Power (mW)	Total Power (dBm)	Maximum Gain (dBi)	EIRP (mW)	EIRP (dBm)	EIRP Limit (dBm)	Test Result
		Chain 0	Chain 1							
7	5985	3.76	4.36	5.106	7.08	5.14	16.676	12.22	24	Pass
103	6465	3.72	4.64	5.266	7.21	5.09	17.001	12.3	24	Pass
119	6545	3.46	4.11	4.795	6.81	5.16	15.732	11.97	24	Pass
199	6945	3.00	3.78	4.383	6.42	5.12	14.249	11.54	24	Pass

Notes:

1. Directional gain is the maximum gain of antennas.
2. For U-NII-5, The maximum gain is 5.14 dBi
3. For U-NII-6, The maximum gain is 5.09 dBi
4. For U-NII-7, The maximum gain is 5.16 dBi
5. For U-NII-8, The maximum gain is 5.12 dBi

802.11be (EHT160) Punctured by 20 MHz

Chan.	Chan. Freq. (MHz)	Average Power (dBm)		Total Power (mW)	Total Power (dBm)	Maximum Gain (dBi)	EIRP (mW)	EIRP (dBm)	EIRP Limit (dBm)	Test Result
		Chain 0	Chain 1							
47	6185	6.92	7.63	10.715	10.30	5.14	34.994	15.44	24	Pass
111	6505	6.85	7.59	10.583	10.25	5.09	34.167	15.34	24	Pass
143	6665	6.71	7.76	10.658	10.28	5.16	34.968	15.44	24	Pass
207	6985	6.92	7.75	10.877	10.37	5.12	35.36	15.49	24	Pass

Notes:

1. Directional gain is the maximum gain of antennas.
2. For U-NII-5, The maximum gain is 5.14 dBi
3. For U-NII-6, The maximum gain is 5.09 dBi
4. For U-NII-7, The maximum gain is 5.16 dBi
5. For U-NII-8, The maximum gain is 5.12 dBi

802.11be (EHT160) Punctured by 40 MHz

Chan.	Chan. Freq. (MHz)	Average Power (dBm)		Total Power (mW)	Total Power (dBm)	Maximum Gain (dBi)	EIRP (mW)	EIRP (dBm)	EIRP Limit (dBm)	Test Result
		Chain 0	Chain 1							
47	6185	6.92	7.63	10.715	10.30	5.14	34.994	15.44	24	Pass
111	6505	6.85	7.59	10.583	10.25	5.09	34.167	15.34	24	Pass
143	6665	6.71	7.76	10.658	10.28	5.16	34.968	15.44	24	Pass
207	6985	6.92	7.75	10.877	10.37	5.12	35.36	15.49	24	Pass

Notes:

1. Directional gain is the maximum gain of antennas.
2. For U-NII-5, The maximum gain is 5.14 dBi
3. For U-NII-6, The maximum gain is 5.09 dBi
4. For U-NII-7, The maximum gain is 5.16 dBi
5. For U-NII-8, The maximum gain is 5.12 dBi

802.11be (EHT320) Punctured by 40 MHz

Chan.	Chan. Freq. (MHz)	Average Power (dBm)		Total Power (mW)	Total Power (dBm)	Maximum Gain (dBi)	EIRP (mW)	EIRP (dBm)	EIRP Limit (dBm)	Test Result
		Chain 0	Chain 1							
63	6265	9.77	10.64	21.072	13.24	5.14	68.819	18.38	24	Pass
159	6745	9.67	10.88	21.514	13.33	5.16	70.586	18.49	24	Pass
191	6905	9.82	10.67	21.262	13.28	5.12	69.12	18.4	24	Pass

Notes:

1. Directional gain is the maximum gain of antennas.
2. For U-NII-5, The maximum gain is 5.14 dBi
3. For U-NII-6, The maximum gain is 5.09 dBi
4. For U-NII-7, The maximum gain is 5.16 dBi
5. For U-NII-8, The maximum gain is 5.12 dBi

802.11be (EHT320) Punctured by 80 MHz

Chan.	Chan. Freq. (MHz)	Average Power (dBm)		Total Power (mW)	Total Power (dBm)	Maximum Gain (dBi)	EIRP (mW)	EIRP (dBm)	EIRP Limit (dBm)	Test Result
		Chain 0	Chain 1							
63	6265	8.59	9.40	15.937	12.02	5.14	52.048	17.16	24	Pass
159	6745	8.26	9.50	15.611	11.93	5.16	51.219	17.09	24	Pass
191	6905	8.45	9.15	15.221	11.82	5.12	49.482	16.94	24	Pass

Notes:

1. Directional gain is the maximum gain of antennas.
2. For U-NII-5, The maximum gain is 5.14 dBi
3. For U-NII-6, The maximum gain is 5.09 dBi
4. For U-NII-7, The maximum gain is 5.16 dBi
5. For U-NII-8, The maximum gain is 5.12 dBi

802.11be (EHT320) Punctured by 80+40 MHz

Chan.	Chan. Freq. (MHz)	Average Power (dBm)		Total Power (mW)	Total Power (dBm)	Maximum Gain (dBi)	EIRP (mW)	EIRP (dBm)	EIRP Limit (dBm)	Test Result
		Chain 0	Chain 1							
63	6265	7.05	8.04	11.438	10.58	5.14	37.355	15.72	24	Pass
159	6745	6.82	8.33	11.616	10.65	5.16	38.112	15.81	24	Pass
191	6905	6.99	7.93	11.209	10.50	5.12	36.439	15.62	24	Pass

Notes:

1. Directional gain is the maximum gain of antennas.
2. For U-NII-5, The maximum gain is 5.14 dBi
3. For U-NII-6, The maximum gain is 5.09 dBi
4. For U-NII-7, The maximum gain is 5.16 dBi
5. For U-NII-8, The maximum gain is 5.12 dBi

Mode C

Input Power:	3.3 Vdc	Environmental Conditions:	24°C, 64% RH	Tested By:	Eric Peng
--------------	---------	---------------------------	--------------	------------	-----------

802.11a

Chan.	Chan. Freq. (MHz)	Average Power (dBm)		Total Power (mW)	Total Power (dBm)	Directional Gain (dBi)	EIRP (mW)	EIRP (dBm)	EIRP Limit (dBm)	Test Result
		Chain 0	Chain 1							
2	5935	-0.76	-2.06	1.4618	1.65	8.15	9.547	9.8	30	Pass
1	5955	14.78	14.82	60.4	17.81	8.15	394.491	25.96	30	Pass
45	6175	14.73	14.86	60.336	17.81	8.15	394.073	25.96	30	Pass
93	6415	14.29	14.66	56.095	17.49	8.15	366.374	25.64	30	Pass
117	6535	14.34	14.70	56.676	17.53	8.17	371.877	25.7	30	Pass
149	6695	14.27	15.00	58.353	17.66	8.17	382.88	25.83	30	Pass
181	6855	14.18	14.59	54.956	17.40	8.17	360.591	25.57	30	Pass

Notes:

1. Directional gain = gain of antenna element + 10 log (2 of TX antenna elements)
2. For U-NII-5, The directional gain is 8.15 dBi
3. For U-NII-7, The directional gain is 8.17 dBi

802.11be (EHT20)

Chan.	Chan. Freq. (MHz)	Average Power (dBm)		Total Power (mW)	Total Power (dBm)	Directional Gain (dBi)	EIRP (mW)	EIRP (dBm)	EIRP Limit (dBm)	Test Result
		Chain 0	Chain 1							
2	5935	-11.47	-13.15	0.1197	-9.22	8.15	0.7818	-1.07	30	Pass
1	5955	15.67	15.29	70.704	18.49	8.15	461.789	26.64	30	Pass
45	6175	15.50	15.59	71.706	18.56	8.15	468.334	26.71	30	Pass
93	6415	14.85	15.36	64.905	18.12	8.15	423.914	26.27	30	Pass
117	6535	14.96	15.44	66.327	18.22	8.17	435.201	26.39	30	Pass
149	6695	14.76	15.43	64.837	18.12	8.17	425.425	26.29	30	Pass
181	6855	14.77	15.35	64.268	18.08	8.17	421.691	26.25	30	Pass

Notes:

1. Directional gain = gain of antenna element + 10 log (2 of TX antenna elements)
2. For U-NII-5, The directional gain is 8.15 dBi
3. For U-NII-7, The directional gain is 8.17 dBi

802.11be (EHT40)

Chan.	Chan. Freq. (MHz)	Average Power (dBm)		Total Power (mW)	Total Power (dBm)	Directional Gain (dBi)	EIRP (mW)	EIRP (dBm)	EIRP Limit (dBm)	Test Result
		Chain 0	Chain 1							
3	5965	15.07	14.81	62.406	17.95	8.15	407.593	26.1	30	Pass
43	6165	14.97	15.01	63.13	18.00	8.15	412.321	26.15	30	Pass
91	6405	14.51	14.88	59.01	17.71	8.15	385.412	25.86	30	Pass
123	6565	14.70	14.96	60.845	17.84	8.17	399.232	26.01	30	Pass
155	6725	14.43	15.19	60.77	17.84	8.17	398.739	26.01	30	Pass
179	6845	14.41	14.88	58.367	17.66	8.17	382.972	25.83	30	Pass

Notes:

1. Directional gain = gain of antenna element + 10 log (2 of TX antenna elements)
2. For U-NII-5, The directional gain is 8.15 dBi
3. For U-NII-7, The directional gain is 8.17 dBi

802.11be (EHT80)

Chan.	Chan. Freq. (MHz)	Average Power (dBm)		Total Power (mW)	Total Power (dBm)	Directional Gain (dBi)	EIRP (mW)	EIRP (dBm)	EIRP Limit (dBm)	Test Result
		Chain 0	Chain 1							
7	5985	14.24	14.06	52.014	17.16	8.15	339.719	25.31	30	Pass
39	6145	14.11	14.20	52.066	17.17	8.15	340.059	25.32	30	Pass
87	6385	13.59	14.25	49.463	16.94	8.15	323.058	25.09	30	Pass
135	6625	13.88	14.31	51.412	17.11	8.17	337.337	25.28	30	Pass
151	6705	13.62	14.49	51.133	17.09	8.17	335.507	25.26	30	Pass
167	6785	13.53	14.58	51.25	17.10	8.17	336.274	25.27	30	Pass

Notes:

1. Directional gain = gain of antenna element + 10 log (2 of TX antenna elements)
2. For U-NII-5, The directional gain is 8.15 dBi
3. For U-NII-7, The directional gain is 8.17 dBi

802.11be (EHT160)

Chan.	Chan. Freq. (MHz)	Average Power (dBm)		Total Power (mW)	Total Power (dBm)	Directional Gain (dBi)	EIRP (mW)	EIRP (dBm)	EIRP Limit (dBm)	Test Result
		Chain 0	Chain 1							
15	6025	14.38	14.47	55.406	17.44	8.15	361.874	25.59	30	Pass
47	6185	14.52	14.69	57.758	17.62	8.15	377.235	25.77	30	Pass
79	6345	13.92	14.70	54.172	17.34	8.15	353.814	25.49	30	Pass
143	6665	14.08	14.89	56.418	17.51	8.17	370.184	25.68	30	Pass

Notes:

1. Directional gain = gain of antenna element + 10 log (2 of TX antenna elements)
2. For U-NII-5, The directional gain is 8.15 dBi
3. For U-NII-7, The directional gain is 8.17 dBi

802.11be (EHT320)

Chan.	Chan. Freq. (MHz)	Average Power (dBm)		Total Power (mW)	Total Power (dBm)	Directional Gain (dBi)	EIRP (mW)	EIRP (dBm)	EIRP Limit (dBm)	Test Result
		Chain 0	Chain 1							
31	6105	13.99	14.07	50.588	17.04	8.15	330.406	25.19	30	Pass
63	6265	13.76	14.21	50.132	17.00	8.15	327.427	25.15	30	Pass

Notes:

1. Directional gain = gain of antenna element + 10 log (2 of TX antenna elements)
2. For U-NII-5, The directional gain is 8.15 dBi
3. For U-NII-7, The directional gain is 8.17 dBi

802.11be (EHT20) 26-tone RU

Chan.	Chan. Freq. (MHz)	Average Power (dBm)		Total Power (mW)	Total Power (dBm)	Maximum Gain (dBi)	EIRP (mW)	EIRP (dBm)	EIRP Limit (dBm)	Test Result
		Chain 0	Chain 1							
2	5935	-19.48	-20.07	0.021112	-16.75	5.14	0.06895	-11.61	30	Pass
1	5955	7.79	8.19	12.603	11.00	5.14	41.16	16.14	30	Pass
45	6175	7.41	8.46	12.523	10.98	5.14	40.899	16.12	30	Pass
93	6415	8.10	8.97	14.345	11.57	5.14	46.849	16.71	30	Pass
117	6535	7.69	8.17	12.436	10.95	5.16	40.802	16.11	30	Pass
149	6695	7.58	8.28	12.458	10.95	5.16	40.874	16.11	30	Pass
181	6855	7.71	8.52	13.014	11.14	5.16	42.698	16.3	30	Pass

Notes:

1. Directional gain is the maximum gain of antennas.
2. For U-NII-5, The maximum gain is 5.14 dBi
3. For U-NII-7, The maximum gain is 5.16 dBi

802.11be (EHT20) 52-tone RU

Chan.	Chan. Freq. (MHz)	Average Power (dBm)		Total Power (mW)	Total Power (dBm)	Maximum Gain (dBi)	EIRP (mW)	EIRP (dBm)	EIRP Limit (dBm)	Test Result
		Chain 0	Chain 1							
2	5935	-17.12	-17.85	0.03581	-14.46	5.14	0.117	-9.32	30	Pass
1	5955	11.34	11.45	27.578	14.41	5.14	90.066	19.55	30	Pass
45	6175	10.76	11.62	26.434	14.22	5.14	86.33	19.36	30	Pass
93	6415	10.27	10.83	22.747	13.57	5.14	74.289	18.71	30	Pass
117	6535	10.79	11.29	25.454	14.06	5.16	83.513	19.22	30	Pass
149	6695	10.71	11.50	25.901	14.13	5.16	84.98	19.29	30	Pass
181	6855	9.84	10.54	20.962	13.21	5.16	68.775	18.37	30	Pass

Notes:

1. Directional gain is the maximum gain of antennas.
2. For U-NII-5, The maximum gain is 5.14 dBi
3. For U-NII-7, The maximum gain is 5.16 dBi

802.11be (EHT20) 106-tone RU

Chan.	Chan. Freq. (MHz)	Average Power (dBm)		Total Power (mW)	Total Power (dBm)	Maximum Gain (dBi)	EIRP (mW)	EIRP (dBm)	EIRP Limit (dBm)	Test Result
		Chain 0	Chain 1							
2	5935	-15.24	-15.88	0.05575	-12.54	5.14	0.1821	-7.4	30	Pass
1	5955	13.97	14.28	51.738	17.14	5.14	168.97	22.28	30	Pass
45	6175	13.68	14.43	51.068	17.08	5.14	166.782	22.22	30	Pass
93	6415	13.57	14.01	47.928	16.81	5.14	156.527	21.95	30	Pass
117	6535	14.28	14.86	57.411	17.59	5.16	188.363	22.75	30	Pass
149	6695	14.22	15.05	58.413	17.67	5.16	191.65	22.83	30	Pass
181	6855	13.88	14.88	55.195	17.42	5.16	181.092	22.58	30	Pass

Notes:

1. Directional gain is the maximum gain of antennas.
2. For U-NII-5, The maximum gain is 5.14 dBi
3. For U-NII-7, The maximum gain is 5.16 dBi

802.11be (EHT20) 242-tone RU

Chan.	Chan. Freq. (MHz)	Average Power (dBm)		Total Power (mW)	Total Power (dBm)	Maximum Gain (dBi)	EIRP (mW)	EIRP (dBm)	EIRP Limit (dBm)	Test Result
		Chain 0	Chain 1							
1	5955	15.66	16.02	76.807	18.85	5.14	250.842	23.99	30	Pass
117	6535	15.05	15.71	69.228	18.40	5.16	227.134	23.56	30	Pass

Notes:

1. Directional gain is the maximum gain of antennas.
2. For U-NII-5, The maximum gain is 5.14 dBi
3. For U-NII-7, The maximum gain is 5.16 dBi

802.11be (EHT40) 484-tone RU

Chan.	Chan. Freq. (MHz)	Average Power (dBm)		Total Power (mW)	Total Power (dBm)	Maximum Gain (dBi)	EIRP (mW)	EIRP (dBm)	EIRP Limit (dBm)	Test Result
		Chain 0	Chain 1							
3	5965	14.98	15.13	64.061	18.07	5.14	209.215	23.21	30	Pass
123	6565	15.11	15.40	67.108	18.27	5.16	220.178	23.43	30	Pass

Notes:

1. Directional gain is the maximum gain of antennas.
2. For U-NII-5, The maximum gain is 5.14 dBi
3. For U-NII-7, The maximum gain is 5.16 dBi

802.11be (EHT80) 996-tone RU

Chan.	Chan. Freq. (MHz)	Average Power (dBm)		Total Power (mW)	Total Power (dBm)	Maximum Gain (dBi)	EIRP (mW)	EIRP (dBm)	EIRP Limit (dBm)	Test Result
		Chain 0	Chain 1							
7	5985	14.25	14.71	56.187	17.50	5.14	183.5	22.64	30	Pass
135	6625	14.40	15.07	59.679	17.76	5.16	195.804	22.92	30	Pass

Notes:

1. Directional gain is the maximum gain of antennas.
2. For U-NII-5, The maximum gain is 5.14 dBi
3. For U-NII-7, The maximum gain is 5.16 dBi

802.11be (EHT160) 2x996-tone RU

Chan.	Chan. Freq. (MHz)	Average Power (dBm)		Total Power (mW)	Total Power (dBm)	Maximum Gain (dBi)	EIRP (mW)	EIRP (dBm)	EIRP Limit (dBm)	Test Result
		Chain 0	Chain 1							
15	6025	13.68	14.01	48.511	16.86	5.14	158.431	22	30	Pass
143	6665	14.22	15.08	58.635	17.68	5.16	192.379	22.84	30	Pass

Notes:

1. Directional gain is the maximum gain of antennas.
2. For U-NII-5, The maximum gain is 5.14 dBi
3. For U-NII-7, The maximum gain is 5.16 dBi

802.11be (EHT20) 52+26-tone MRU

Chan.	Chan. Freq. (MHz)	Average Power (dBm)		Total Power (mW)	Total Power (dBm)	Maximum Gain (dBi)	EIRP (mW)	EIRP (dBm)	EIRP Limit (dBm)	Test Result
		Chain 0	Chain 1							
1	5955	12.40	12.83	36.565	15.63	5.14	119.417	20.77	30	Pass
117	6535	11.65	11.98	30.398	14.83	5.16	99.734	19.99	30	Pass

Notes:

1. Directional gain is the maximum gain of antennas.
2. For U-NII-5, The maximum gain is 5.14 dBi
3. For U-NII-7, The maximum gain is 5.16 dBi

802.11be (EHT20) 106+26-tone MRU

Chan.	Chan. Freq. (MHz)	Average Power (dBm)		Total Power (mW)	Total Power (dBm)	Maximum Gain (dBi)	EIRP (mW)	EIRP (dBm)	EIRP Limit (dBm)	Test Result
		Chain 0	Chain 1							
1	5955	14.71	15.14	62.239	17.94	5.14	203.265	23.08	30	Pass
117	6535	14.77	15.39	64.586	18.10	5.16	211.904	23.26	30	Pass

Notes:

1. Directional gain is the maximum gain of antennas.
2. For U-NII-5, The maximum gain is 5.14 dBi
3. For U-NII-7, The maximum gain is 5.16 dBi

802.11be (EHT80) 484+242-tone MRU

Chan.	Chan. Freq. (MHz)	Average Power (dBm)		Total Power (mW)	Total Power (dBm)	Maximum Gain (dBi)	EIRP (mW)	EIRP (dBm)	EIRP Limit (dBm)	Test Result
		Chain 0	Chain 1							
7	5985	15.69	16.08	77.619	18.90	5.14	253.494	24.04	30	Pass
135	6625	15.99	16.43	83.673	19.23	5.16	274.527	24.39	30	Pass

Notes:

1. Directional gain is the maximum gain of antennas.
2. For U-NII-5, The maximum gain is 5.14 dBi
3. For U-NII-7, The maximum gain is 5.16 dBi

802.11be (EHT160) 996+484-tone MRU

Chan.	Chan. Freq. (MHz)	Average Power (dBm)		Total Power (mW)	Total Power (dBm)	Maximum Gain (dBi)	EIRP (mW)	EIRP (dBm)	EIRP Limit (dBm)	Test Result
		Chain 0	Chain 1							
15	6025	15.64	16.10	77.382	18.89	5.14	252.72	24.03	30	Pass
143	6665	15.42	16.14	75.949	18.81	5.16	249.185	23.97	30	Pass

Notes:

1. Directional gain is the maximum gain of antennas.
2. For U-NII-5, The maximum gain is 5.14 dBi
3. For U-NII-7, The maximum gain is 5.16 dBi

802.11be (EHT320) 2x996+484-tone MRU

Chan.	Chan. Freq. (MHz)	Average Power (dBm)		Total Power (mW)	Total Power (dBm)	Maximum Gain (dBi)	EIRP (mW)	EIRP (dBm)	EIRP Limit (dBm)	Test Result
		Chain 0	Chain 1							
31	6105	15.59	15.69	73.292	18.65	5.14	239.363	23.79	30	Pass

Notes:

1. Directional gain is the maximum gain of antennas.
2. For U-NII-5, The maximum gain is 5.14 dBi
3. For U-NII-7, The maximum gain is 5.16 dBi

802.11be (EHT320) 3x996-tone MRU

Chan.	Chan. Freq. (MHz)	Average Power (dBm)		Total Power (mW)	Total Power (dBm)	Maximum Gain (dBi)	EIRP (mW)	EIRP (dBm)	EIRP Limit (dBm)	Test Result
		Chain 0	Chain 1							
31	6105	14.72	14.89	60.48	17.82	5.14	197.52	22.96	30	Pass

Notes:

1. Directional gain is the maximum gain of antennas.
2. For U-NII-5, The maximum gain is 5.14 dBi
3. For U-NII-7, The maximum gain is 5.16 dBi

802.11be (EHT320) 3x996+484-tone MRU

Chan.	Chan. Freq. (MHz)	Average Power (dBm)		Total Power (mW)	Total Power (dBm)	Maximum Gain (dBi)	EIRP (mW)	EIRP (dBm)	EIRP Limit (dBm)	Test Result
		Chain 0	Chain 1							
31	6105	14.21	14.36	53.653	17.30	5.14	175.224	22.44	30	Pass

Notes:

1. Directional gain is the maximum gain of antennas.
2. For U-NII-5, The maximum gain is 5.14 dBi
3. For U-NII-7, The maximum gain is 5.16 dBi

802.11be (EHT80) Punctured by 20 MHz

Chan.	Chan. Freq. (MHz)	Average Power (dBm)		Total Power (mW)	Total Power (dBm)	Maximum Gain (dBi)	EIRP (mW)	EIRP (dBm)	EIRP Limit (dBm)	Test Result
		Chain 0	Chain 1							
7	5985	14.71	15.15	62.314	17.95	5.14	203.51	23.09	30	Pass
135	6625	14.38	15.05	59.405	17.74	5.16	194.905	22.9	30	Pass

Notes:

1. Directional gain is the maximum gain of antennas.
2. For U-NII-5, The maximum gain is 5.14 dBi
3. For U-NII-7, The maximum gain is 5.16 dBi

802.11be (EHT160) Punctured by 20 MHz

Chan.	Chan. Freq. (MHz)	Average Power (dBm)		Total Power (mW)	Total Power (dBm)	Maximum Gain (dBi)	EIRP (mW)	EIRP (dBm)	EIRP Limit (dBm)	Test Result
		Chain 0	Chain 1							
15	6025	14.63	15.05	61.029	17.86	5.14	199.313	23	30	Pass
143	6665	14.35	15.24	60.647	17.83	5.16	198.98	22.99	30	Pass

Notes:

1. Directional gain is the maximum gain of antennas.
2. For U-NII-5, The maximum gain is 5.14 dBi
3. For U-NII-7, The maximum gain is 5.16 dBi

802.11be (EHT160) Punctured by 40 MHz

Chan.	Chan. Freq. (MHz)	Average Power (dBm)		Total Power (mW)	Total Power (dBm)	Maximum Gain (dBi)	EIRP (mW)	EIRP (dBm)	EIRP Limit (dBm)	Test Result
		Chain 0	Chain 1							
15	6025	14.72	15.03	61.49	17.89	5.14	200.819	23.03	30	Pass
143	6665	14.38	15.19	60.453	17.81	5.16	198.343	22.97	30	Pass

Notes:

1. Directional gain is the maximum gain of antennas.
2. For U-NII-5, The maximum gain is 5.14 dBi
3. For U-NII-7, The maximum gain is 5.16 dBi

802.11be (EHT320) Punctured by 40 MHz

Chan.	Chan. Freq. (MHz)	Average Power (dBm)		Total Power (mW)	Total Power (dBm)	Maximum Gain (dBi)	EIRP (mW)	EIRP (dBm)	EIRP Limit (dBm)	Test Result
		Chain 0	Chain 1							
31	6105	13.89	14.01	49.667	16.96	5.14	162.206	22.1	30	Pass

Notes:

1. Directional gain is the maximum gain of antennas.
2. For U-NII-5, The maximum gain is 5.14 dBi
3. For U-NII-7, The maximum gain is 5.16 dBi

802.11be (EHT320) Punctured by 80 MHz

Chan.	Chan. Freq. (MHz)	Average Power (dBm)		Total Power (mW)	Total Power (dBm)	Maximum Gain (dBi)	EIRP (mW)	EIRP (dBm)	EIRP Limit (dBm)	Test Result
		Chain 0	Chain 1							
31	6105	13.61	14.02	48.196	16.83	5.14	157.402	21.97	30	Pass

Notes:

1. Directional gain is the maximum gain of antennas.
2. For U-NII-5, The maximum gain is 5.14 dBi
3. For U-NII-7, The maximum gain is 5.16 dBi

802.11be (EHT320) Punctured by 80+40 MHz

Chan.	Chan. Freq. (MHz)	Average Power (dBm)		Total Power (mW)	Total Power (dBm)	Maximum Gain (dBi)	EIRP (mW)	EIRP (dBm)	EIRP Limit (dBm)	Test Result
		Chain 0	Chain 1							
31	6105	13.90	14.32	51.587	17.13	5.14	168.477	22.27	30	Pass

Notes:

1. Directional gain is the maximum gain of antennas.
2. For U-NII-5, The maximum gain is 5.14 dBi
3. For U-NII-7, The maximum gain is 5.16 dBi

Mode E

Input Power:	3.3 Vdc	Environmental Conditions:	24°C, 60% RH	Tested By:	Eric Peng
--------------	---------	---------------------------	--------------	------------	-----------

802.11be (EHT20)

Chan.	Chan. Freq. (MHz)	Average Power (dBm)		Total Power (mW)	Total Power (dBm)	Directional Gain (dBi)	EIRP (mW)	EIRP (dBm)	EIRP Limit (dBm)	Test Result
		Chain 0	Chain 1							
2	5935	-9.29	-10.55	0.20587	-6.86	5.14	0.6723	-1.72	24	Pass
1	5955	1.96	1.06	2.847	4.54	5.14	9.298	9.68	24	Pass
45	6175	1.07	0.85	2.496	3.97	5.14	8.152	9.11	24	Pass
93	6415	1.27	0.42	2.441	3.88	5.14	7.972	9.02	24	Pass
97	6435	1.83	0.85	2.74	4.38	5.09	8.846	9.47	24	Pass
105	6475	1.82	0.98	2.774	4.43	5.09	8.956	9.52	24	Pass
113	6515	2.12	1.05	2.903	4.63	5.09	9.372	9.72	24	Pass
117	6535	2.01	1.30	2.938	4.68	5.16	9.639	9.84	24	Pass
149	6695	1.74	1.58	2.932	4.67	5.16	9.62	9.83	24	Pass
181	6855	1.43	1.66	2.856	4.56	5.16	9.37	9.72	24	Pass
185	6875	1.24	1.17	2.64	4.22	5.16	8.662	9.38	24	Pass
209	6995	1.62	1.50	2.865	4.57	5.12	9.314	9.69	24	Pass
233	7115	-9.79	-8.91	0.2335	-6.32	5.12	0.7591	-1.2	24	Pass

Notes:

1. For U-NII-5, The directional gain is 5.14 dBi
2. For U-NII-6, The directional gain is 5.09 dBi
3. For U-NII-7, The directional gain is 5.16 dBi
4. For U-NII-8, The directional gain is 5.12 dBi

802.11be (EHT40)

Chan.	Chan. Freq. (MHz)	Average Power (dBm)		Total Power (mW)	Total Power (dBm)	Maximum Gain (dBi)	EIRP (mW)	EIRP (dBm)	EIRP Limit (dBm)	Test Result
		Chain 0	Chain 1							
3	5965	3.20	3.14	4.15	6.18	5.14	13.553	11.32	24	Pass
43	6165	2.83	3.09	3.956	5.97	5.14	12.92	11.11	24	Pass
91	6405	2.56	3.23	3.907	5.92	5.14	12.76	11.06	24	Pass
99	6445	2.64	3.32	3.984	6.00	5.09	12.862	11.09	24	Pass
107	6485	2.74	3.34	4.037	6.06	5.09	13.033	11.15	24	Pass
115	6525	2.86	3.13	3.988	6.01	5.16	13.084	11.17	24	Pass
123	6565	2.79	3.48	4.13	6.16	5.16	13.55	11.32	24	Pass
155	6725	2.40	3.65	4.055	6.08	5.16	13.304	11.24	24	Pass
179	6845	2.69	3.27	3.981	6.00	5.16	13.061	11.16	24	Pass
187	6885	2.14	2.85	3.564	5.52	5.16	11.693	10.68	24	Pass
211	7005	2.31	3.51	3.946	5.96	5.12	12.828	11.08	24	Pass
227	7085	2.19	3.53	3.91	5.92	5.12	12.711	11.04	24	Pass

Notes:

1. For U-NII-5, The directional gain is 5.14 dBi
2. For U-NII-6, The directional gain is 5.09 dBi
3. For U-NII-7, The directional gain is 5.16 dBi
4. For U-NII-8, The directional gain is 5.12 dBi

802.11be (EHT80)

Chan.	Chan. Freq. (MHz)	Average Power (dBm)		Total Power (mW)	Total Power (dBm)	Directional Gain (dBi)	EIRP (mW)	EIRP (dBm)	EIRP Limit (dBm)	Test Result
		Chain 0	Chain 1							
7	5985	7.08	7.17	10.317	10.14	5.14	33.694	15.28	24	Pass
39	6145	7.04	7.43	10.592	10.25	5.14	34.592	15.39	24	Pass
87	6385	6.55	7.75	10.475	10.20	5.14	34.21	15.34	24	Pass
103	6465	7.58	8.37	12.599	11.00	5.09	40.676	16.09	24	Pass
119	6545	7.46	7.86	11.681	10.67	5.16	38.325	15.83	24	Pass
151	6705	6.61	8.18	11.158	10.48	5.16	36.609	15.64	24	Pass
183	6865	7.12	7.81	11.192	10.49	5.16	36.72	15.65	24	Pass
199	6945	7.18	7.70	11.112	10.46	5.12	36.124	15.58	24	Pass
215	7025	7.02	7.70	10.923	10.38	5.12	35.509	15.5	24	Pass

Notes:

1. For U-NII-5, The directional gain is 5.14 dBi
2. For U-NII-6, The directional gain is 5.09 dBi
3. For U-NII-7, The directional gain is 5.16 dBi
4. For U-NII-8, The directional gain is 5.12 dBi

802.11be (EHT160)

Chan.	Chan. Freq. (MHz)	Average Power (dBm)		Total Power (mW)	Total Power (dBm)	Maximum Gain (dBi)	EIRP (mW)	EIRP (dBm)	EIRP Limit (dBm)	Test Result
		Chain 0	Chain 1							
15	6025	8.38	8.64	14.198	11.52	5.14	46.369	16.66	24	Pass
47	6185	8.58	9.03	15.209	11.82	5.14	49.671	16.96	24	Pass
79	6345	7.86	8.73	13.574	11.33	5.14	44.331	16.47	24	Pass
111	6505	8.48	8.94	14.881	11.73	5.16	48.824	16.89	24	Pass
143	6665	8.11	8.78	14.022	11.47	5.16	46.006	16.63	24	Pass
175	6825	7.99	8.74	13.777	11.39	5.16	45.202	16.55	24	Pass
207	6985	8.08	8.91	14.207	11.53	5.12	46.185	16.65	24	Pass

Notes:

1. For U-NII-5, The directional gain is 5.14 dBi
2. For U-NII-6, The directional gain is 5.09 dBi
3. For U-NII-7, The directional gain is 5.16 dBi
4. For U-NII-8, The directional gain is 5.12 dBi

802.11be (EHT320)

Chan.	Chan. Freq. (MHz)	Average Power (dBm)		Total Power (mW)	Total Power (dBm)	Maximum Gain (dBi)	EIRP (mW)	EIRP (dBm)	EIRP Limit (dBm)	Test Result
		Chain 0	Chain 1							
31	6105	11.86	11.84	30.622	14.86	5.14	100.008	20	24	Pass
63	6265	11.83	11.82	30.446	14.84	5.14	99.433	19.98	24	Pass
95	6425	11.45	11.75	28.926	14.61	5.14	94.469	19.75	24	Pass
127	6585	11.14	11.73	27.895	14.46	5.16	91.522	19.62	24	Pass
159	6745	10.85	11.98	27.938	14.46	5.16	91.663	19.62	24	Pass
191	6905	10.93	11.78	27.454	14.39	5.16	90.075	19.55	24	Pass

Notes:

1. For U-NII-5, The directional gain is 5.14 dBi
2. For U-NII-6, The directional gain is 5.09 dBi
3. For U-NII-7, The directional gain is 5.16 dBi
4. For U-NII-8, The directional gain is 5.12 dBi

802.11be (EHT20) 26-tone RU

Chan.	Chan. Freq. (MHz)	Average Power (dBm)		Total Power (mW)	Total Power (dBm)	Directional Gain (dBi)	EIRP (mW)	EIRP (dBm)	EIRP Limit (dBm)	Test Result
		Chain 0	Chain 1							
2	5935	-16.84	-17.74	0.03753	-14.26	5.14	0.1226	-9.12	24	Pass
1	5955	-6.49	-7.51	0.4018	-3.96	5.14	1.312	1.18	24	Pass
45	6175	-7.74	-7.32	0.3536	-4.51	5.14	1.155	0.63	24	Pass
93	6415	-7.31	-7.94	0.3465	-4.60	5.14	1.132	0.54	24	Pass
97	6435	-7.17	-7.79	0.3582	-4.46	5.09	1.156	0.63	24	Pass
105	6475	-7.19	-7.81	0.3566	-4.48	5.09	1.151	0.61	24	Pass
113	6515	-7.04	-7.51	0.3751	-4.26	5.09	1.211	0.83	24	Pass
117	6535	-7.05	-7.44	0.3775	-4.23	5.16	1.239	0.93	24	Pass
149	6695	-7.18	-7.00	0.391	-4.08	5.16	1.283	1.08	24	Pass
181	6855	-7.62	-7.23	0.3622	-4.41	5.16	1.188	0.75	24	Pass
185	6875	-7.45	-7.27	0.3674	-4.35	5.16	1.205	0.81	24	Pass
209	6995	-7.44	-7.24	0.3691	-4.33	5.12	1.2	0.79	24	Pass
233	7115	-16.58	-15.92	0.04756	-13.23	5.12	0.1546	-8.11	24	Pass

Notes:

1. For U-NII-5, The directional gain is 5.14 dBi
2. For U-NII-6, The directional gain is 5.09 dBi
3. For U-NII-7, The directional gain is 5.16 dBi
4. For U-NII-8, The directional gain is 5.12 dBi

802.11be (EHT20) 52-tone RU

Chan.	Chan. Freq. (MHz)	Average Power (dBm)		Total Power (mW)	Total Power (dBm)	Directional Gain (dBi)	EIRP (mW)	EIRP (dBm)	EIRP Limit (dBm)	Test Result
		Chain 0	Chain 1							
2	5935	-14.47	-15.22	0.06579	-11.82	5.14	0.2149	-6.68	24	Pass
1	5955	-3.59	-4.55	0.7883	-1.03	5.14	2.574	4.11	24	Pass
45	6175	-4.90	-4.54	0.6752	-1.71	5.14	2.205	3.43	24	Pass
93	6415	-4.50	-4.98	0.6725	-1.72	5.14	2.196	3.42	24	Pass
97	6435	-4.87	-5.11	0.6342	-1.98	5.09	2.048	3.11	24	Pass
105	6475	-4.80	-4.84	0.6592	-1.81	5.09	2.128	3.28	24	Pass
113	6515	-4.28	-4.47	0.7305	-1.36	5.09	2.358	3.73	24	Pass
117	6535	-4.69	-4.78	0.6723	-1.72	5.16	2.206	3.44	24	Pass
149	6695	-4.78	-4.57	0.6818	-1.66	5.16	2.237	3.5	24	Pass
181	6855	-4.87	-4.34	0.694	-1.59	5.16	2.277	3.57	24	Pass
185	6875	-4.97	-4.56	0.6684	-1.75	5.16	2.193	3.41	24	Pass
209	6995	-4.80	-4.69	0.6708	-1.73	5.12	2.181	3.39	24	Pass
233	7115	-14.76	-14.18	0.07161	-11.45	5.12	0.2328	-6.33	24	Pass

Notes:

1. For U-NII-5, The directional gain is 5.14 dBi
2. For U-NII-6, The directional gain is 5.09 dBi
3. For U-NII-7, The directional gain is 5.16 dBi
4. For U-NII-8, The directional gain is 5.12 dBi

802.11be (EHT20) 106-tone RU

Chan.	Chan. Freq. (MHz)	Average Power (dBm)		Total Power (mW)	Total Power (dBm)	Directional Gain (dBi)	EIRP (mW)	EIRP (dBm)	EIRP Limit (dBm)	Test Result
		Chain 0	Chain 1							
2	5935	-12.50	-13.18	0.10432	-9.82	5.14	0.3407	-4.68	24	Pass
1	5955	-0.37	-1.12	1.691	2.28	5.14	5.523	7.42	24	Pass
45	6175	-1.33	-1.68	1.4154	1.51	5.14	4.623	6.65	24	Pass
93	6415	-1.29	-2.02	1.3711	1.37	5.14	4.478	6.51	24	Pass
97	6435	-0.98	-1.56	1.4962	1.75	5.09	4.83	6.84	24	Pass
105	6475	-1.06	-1.29	1.5264	1.84	5.09	4.928	6.93	24	Pass
113	6515	-0.69	-1.20	1.6117	2.07	5.09	5.203	7.16	24	Pass
117	6535	-0.87	-0.99	1.6146	2.08	5.16	5.297	7.24	24	Pass
149	6695	-1.08	-0.90	1.5927	2.02	5.16	5.226	7.18	24	Pass
181	6855	-1.56	-0.72	1.5455	1.89	5.16	5.071	7.05	24	Pass
185	6875	-1.36	-1.16	1.4967	1.75	5.16	4.911	6.91	24	Pass
209	6995	-1.42	-1.34	1.4556	1.63	5.12	4.732	6.75	24	Pass
233	7115	-12.23	-11.54	0.12999	-8.86	5.12	0.4226	-3.74	24	Pass

Notes:

1. For U-NII-5, The directional gain is 5.14 dBi
2. For U-NII-6, The directional gain is 5.09 dBi
3. For U-NII-7, The directional gain is 5.16 dBi
4. For U-NII-8, The directional gain is 5.12 dBi

802.11be (EHT20) 242-tone RU

Chan.	Chan. Freq. (MHz)	Average Power (dBm)		Total Power (mW)	Total Power (dBm)	Directional Gain (dBi)	EIRP (mW)	EIRP (dBm)	EIRP Limit (dBm)	Test Result
		Chain 0	Chain 1							
2	5935	2.43	1.52	3.169	5.01	5.14	10.35	10.15	24	Pass
1	5955	2.43	1.41	3.133	4.96	5.14	10.232	10.1	24	Pass
45	6175	1.38	1.60	2.819	4.50	5.14	9.207	9.64	24	Pass
93	6415	1.59	0.97	2.692	4.30	5.14	8.792	9.44	24	Pass
97	6435	2.24	1.54	3.101	4.92	5.09	10.012	10.01	24	Pass
105	6475	2.11	1.75	3.122	4.94	5.09	10.079	10.03	24	Pass
113	6515	2.36	1.85	3.253	5.12	5.09	10.502	10.21	24	Pass
117	6535	2.04	1.87	3.138	4.97	5.16	10.296	10.13	24	Pass
149	6695	2.00	2.28	3.275	5.15	5.16	10.745	10.31	24	Pass
181	6855	1.55	2.17	3.077	4.88	5.16	10.095	10.04	24	Pass
185	6875	1.60	1.96	3.016	4.79	5.16	9.895	9.95	24	Pass
209	6995	1.94	2.18	3.215	5.07	5.12	10.452	10.19	24	Pass
233	7115	1.63	2.29	3.15	4.98	5.12	10.24	10.1	24	Pass

Notes:

1. For U-NII-5, The directional gain is 5.14 dBi
2. For U-NII-6, The directional gain is 5.09 dBi
3. For U-NII-7, The directional gain is 5.16 dBi
4. For U-NII-8, The directional gain is 5.12 dBi

802.11be (EHT40) 484-tone RU

Chan.	Chan. Freq. (MHz)	Average Power (dBm)		Total Power (mW)	Total Power (dBm)	Directional Gain (dBi)	EIRP (mW)	EIRP (dBm)	EIRP Limit (dBm)	Test Result
		Chain 0	Chain 1							
3	5965	5.53	5.56	7.17	8.56	5.14	23.416	13.7	24	Pass
43	6165	4.99	5.48	6.687	8.25	5.14	21.839	13.39	24	Pass
91	6405	4.62	5.48	6.429	8.08	5.14	20.996	13.22	24	Pass
99	6445	5.24	5.98	7.305	8.64	5.09	23.584	13.73	24	Pass
107	6485	5.33	6.02	7.411	8.70	5.09	23.926	13.79	24	Pass
115	6525	5.13	5.51	6.815	8.33	5.16	22.36	13.49	24	Pass
123	6565	4.78	5.84	6.843	8.35	5.16	22.452	13.51	24	Pass
155	6725	4.74	5.79	6.772	8.31	5.16	22.219	13.47	24	Pass
179	6845	4.70	5.47	6.475	8.11	5.16	21.244	13.27	24	Pass
187	6885	4.33	5.10	5.946	7.74	5.12	19.33	12.86	24	Pass
211	7005	4.54	5.46	6.36	8.03	5.12	20.676	13.15	24	Pass
227	7085	4.54	5.58	6.459	8.10	5.12	20.997	13.22	24	Pass

Notes:

1. For U-NII-5, The directional gain is 5.14 dBi
2. For U-NII-6, The directional gain is 5.09 dBi
3. For U-NII-7, The directional gain is 5.16 dBi
4. For U-NII-8, The directional gain is 5.12 dBi

802.11be (EHT80) 996-tone RU

Chan.	Chan. Freq. (MHz)	Average Power (dBm)		Total Power (mW)	Total Power (dBm)	Directional Gain (dBi)	EIRP (mW)	EIRP (dBm)	EIRP Limit (dBm)	Test Result
		Chain 0	Chain 1							
7	5985	8.57	8.95	15.047	11.77	5.14	49.142	16.91	24	Pass
39	6145	7.58	7.99	12.023	10.80	5.14	39.266	15.94	24	Pass
87	6385	7.27	8.36	12.188	10.86	5.14	39.805	16	24	Pass
103	6465	7.10	8.44	12.111	10.83	5.09	39.1	15.92	24	Pass
119	6545	7.95	8.53	13.366	11.26	5.16	43.853	16.42	24	Pass
151	6705	7.30	8.79	12.939	11.12	5.16	42.452	16.28	24	Pass
183	6865	7.50	8.40	12.542	10.98	5.16	41.15	16.14	24	Pass
199	6945	7.91	8.26	12.879	11.10	5.12	41.868	16.22	24	Pass
215	7025	7.67	8.45	12.846	11.09	5.12	41.761	16.21	24	Pass

Notes:

1. For U-NII-5, The directional gain is 5.14 dBi
2. For U-NII-6, The directional gain is 5.09 dBi
3. For U-NII-7, The directional gain is 5.16 dBi
4. For U-NII-8, The directional gain is 5.12 dBi

802.11be (EHT160) 2x996-tone RU

Chan.	Chan. Freq. (MHz)	Average Power (dBm)		Total Power (mW)	Total Power (dBm)	Directional Gain (dBi)	EIRP (mW)	EIRP (dBm)	EIRP Limit (dBm)	Test Result
		Chain 0	Chain 1							
15	6025	9.34	10.48	19.759	12.96	5.14	64.53	18.1	24	Pass
47	6185	9.34	10.16	18.965	12.78	5.14	61.937	17.92	24	Pass
79	6345	9.28	9.79	18	12.55	5.14	58.786	17.69	24	Pass
111	6505	9.37	10.03	18.719	12.72	5.09	60.434	17.81	24	Pass
143	6665	9.09	10.33	18.899	12.76	5.16	62.007	17.92	24	Pass
175	6825	9.03	9.97	17.93	12.54	5.16	58.827	17.7	24	Pass
207	6985	9.27	10.27	19.094	12.81	5.12	62.072	17.93	24	Pass

Notes:

1. For U-NII-5, The directional gain is 5.14 dBi
2. For U-NII-6, The directional gain is 5.09 dBi
3. For U-NII-7, The directional gain is 5.16 dBi
4. For U-NII-8, The directional gain is 5.12 dBi

802.11be (EHT20) 52+26-tone MRU

Chan.	Chan. Freq. (MHz)	Average Power (dBm)		Total Power (mW)	Total Power (dBm)	Maximum Gain (dBi)	EIRP (mW)	EIRP (dBm)	EIRP Limit (dBm)	Test Result
		Chain 0	Chain 1							
45	6175	-3.73	-3.22	0.9001	-0.46	5.14	2.94	4.68	24	Pass
105	6475	-3.78	-3.99	0.8178	-0.87	5.09	2.64	4.22	24	Pass
185	6875	-4.22	-3.51	0.8241	-0.84	5.16	2.704	4.32	24	Pass
209	6995	-3.83	-3.45	0.8659	-0.63	5.12	2.815	4.49	24	Pass

Notes:

1. Directional gain is the maximum gain of antennas.
2. For U-NII-5, The maximum gain is 5.14 dBi
3. For U-NII-6, The maximum gain is 5.09 dBi
4. For U-NII-7, The maximum gain is 5.16 dBi
5. For U-NII-8, The maximum gain is 5.12 dBi

802.11be (EHT20) 106+26-tone MRU

Chan.	Chan. Freq. (MHz)	Average Power (dBm)		Total Power (mW)	Total Power (dBm)	Maximum Gain (dBi)	EIRP (mW)	EIRP (dBm)	EIRP Limit (dBm)	Test Result
		Chain 0	Chain 1							
45	6175	-1.19	-0.60	1.6313	2.13	5.14	5.328	7.27	24	Pass
105	6475	-0.38	-0.66	1.7752	2.49	5.09	5.731	7.58	24	Pass
185	6875	-0.99	-0.58	1.6711	2.23	5.16	5.483	7.39	24	Pass
209	6995	-0.76	-0.36	1.7599	2.45	5.12	5.721	7.57	24	Pass

Notes:

1. Directional gain is the maximum gain of antennas.
2. For U-NII-5, The maximum gain is 5.14 dBi
3. For U-NII-6, The maximum gain is 5.09 dBi
4. For U-NII-7, The maximum gain is 5.16 dBi
5. For U-NII-8, The maximum gain is 5.12 dBi

802.11be (EHT80) 484+242-tone MRU

Chan.	Chan. Freq. (MHz)	Average Power (dBm)		Total Power (mW)	Total Power (dBm)	Maximum Gain (dBi)	EIRP (mW)	EIRP (dBm)	EIRP Limit (dBm)	Test Result
		Chain 0	Chain 1							
7	5985	6.39	6.62	8.947	9.52	5.14	29.22	14.66	24	Pass
103	6465	5.46	6.23	7.713	8.87	5.09	24.901	13.96	24	Pass
119	6545	5.56	6.18	7.747	8.89	5.16	25.418	14.05	24	Pass
199	6945	5.01	6.04	7.187	8.57	5.12	23.364	13.69	24	Pass

Notes:

1. Directional gain is the maximum gain of antennas.
2. For U-NII-5, The maximum gain is 5.14 dBi
3. For U-NII-6, The maximum gain is 5.09 dBi
4. For U-NII-7, The maximum gain is 5.16 dBi
5. For U-NII-8, The maximum gain is 5.12 dBi

802.11be (EHT160) 996+484-tone MRU

Chan.	Chan. Freq. (MHz)	Average Power (dBm)		Total Power (mW)	Total Power (dBm)	Maximum Gain (dBi)	EIRP (mW)	EIRP (dBm)	EIRP Limit (dBm)	Test Result
		Chain 0	Chain 1							
47	6185	8.60	9.04	15.261	11.84	5.14	49.841	16.98	24	Pass
111	6505	9.04	9.54	17.012	12.31	5.09	54.923	17.4	24	Pass
143	6665	8.29	9.71	16.099	12.07	5.16	52.82	17.23	24	Pass
207	6985	8.85	9.55	16.689	12.22	5.12	54.254	17.34	24	Pass

Notes:

1. Directional gain is the maximum gain of antennas.
2. For U-NII-5, The maximum gain is 5.14 dBi
3. For U-NII-6, The maximum gain is 5.09 dBi
4. For U-NII-7, The maximum gain is 5.16 dBi
5. For U-NII-8, The maximum gain is 5.12 dBi

802.11be (EHT320) 2x996+484-tone MRU

Chan.	Chan. Freq. (MHz)	Average Power (dBm)		Total Power (mW)	Total Power (dBm)	Maximum Gain (dBi)	EIRP (mW)	EIRP (dBm)	EIRP Limit (dBm)	Test Result
		Chain 0	Chain 1							
63	6265	11.27	12.33	30.497	14.84	5.14	99.599	19.98	24	Pass
159	6745	11.26	12.59	31.521	14.99	5.16	103.419	20.15	24	Pass
191	6905	11.34	12.24	30.364	14.82	5.12	98.71	19.94	24	Pass

Notes:

1. Directional gain is the maximum gain of antennas.
2. For U-NII-5, The maximum gain is 5.14 dBi
3. For U-NII-6, The maximum gain is 5.09 dBi
4. For U-NII-7, The maximum gain is 5.16 dBi
5. For U-NII-8, The maximum gain is 5.12 dBi

802.11be (EHT320) 3x996-tone MRU

Chan.	Chan. Freq. (MHz)	Average Power (dBm)		Total Power (mW)	Total Power (dBm)	Maximum Gain (dBi)	EIRP (mW)	EIRP (dBm)	EIRP Limit (dBm)	Test Result
		Chain 0	Chain 1							
63	6265	10.28	11.41	24.502	13.89	5.14	80.021	19.03	24	Pass
159	6745	9.96	11.65	24.53	13.90	5.16	80.482	19.06	24	Pass
191	6905	10.18	11.15	23.455	13.70	5.12	76.249	18.82	24	Pass

Notes:

1. Directional gain is the maximum gain of antennas.
2. For U-NII-5, The maximum gain is 5.14 dBi
3. For U-NII-6, The maximum gain is 5.09 dBi
4. For U-NII-7, The maximum gain is 5.16 dBi
5. For U-NII-8, The maximum gain is 5.12 dBi

802.11be (EHT320) 3x996+484-tone MRU

Chan.	Chan. Freq. (MHz)	Average Power (dBm)		Total Power (mW)	Total Power (dBm)	Maximum Gain (dBi)	EIRP (mW)	EIRP (dBm)	EIRP Limit (dBm)	Test Result
		Chain 0	Chain 1							
63	6265	9.76	10.53	20.76	13.17	5.14	67.8	18.31	24	Pass
159	6745	9.38	10.83	20.776	13.18	5.16	68.165	18.34	24	Pass
191	6905	9.76	10.54	20.786	13.18	5.12	67.573	18.3	24	Pass

Notes:

1. Directional gain is the maximum gain of antennas.
2. For U-NII-5, The maximum gain is 5.14 dBi
3. For U-NII-6, The maximum gain is 5.09 dBi
4. For U-NII-7, The maximum gain is 5.16 dBi
5. For U-NII-8, The maximum gain is 5.12 dBi

802.11be (EHT80) Punctured by 20 MHz

Chan.	Chan. Freq. (MHz)	Average Power (dBm)		Total Power (mW)	Total Power (dBm)	Maximum Gain (dBi)	EIRP (mW)	EIRP (dBm)	EIRP Limit (dBm)	Test Result
		Chain 0	Chain 1							
7	5985	6.07	6.82	8.854	9.47	5.14	28.916	14.61	24	Pass
103	6465	6.12	7.16	9.293	9.68	5.09	30.002	14.77	24	Pass
119	6545	5.83	6.66	8.463	9.28	5.16	27.767	14.44	24	Pass
199	6945	5.58	6.30	7.88	8.97	5.12	25.617	14.09	24	Pass

Notes:

1. Directional gain is the maximum gain of antennas.
2. For U-NII-5, The maximum gain is 5.14 dBi
3. For U-NII-6, The maximum gain is 5.09 dBi
4. For U-NII-7, The maximum gain is 5.16 dBi
5. For U-NII-8, The maximum gain is 5.12 dBi

802.11be (EHT160) Punctured by 20 MHz

Chan.	Chan. Freq. (MHz)	Average Power (dBm)		Total Power (mW)	Total Power (dBm)	Maximum Gain (dBi)	EIRP (mW)	EIRP (dBm)	EIRP Limit (dBm)	Test Result
		Chain 0	Chain 1							
47	6185	9.93	10.50	21.06	13.23	5.14	68.779	18.37	24	Pass
111	6505	9.82	10.58	21.023	13.23	5.09	67.873	18.32	24	Pass
143	6665	9.36	10.87	20.848	13.19	5.16	68.401	18.35	24	Pass
207	6985	9.86	10.54	21.007	13.22	5.12	68.291	18.34	24	Pass

Notes:

1. Directional gain is the maximum gain of antennas.
2. For U-NII-5, The maximum gain is 5.14 dBi
3. For U-NII-6, The maximum gain is 5.09 dBi
4. For U-NII-7, The maximum gain is 5.16 dBi
5. For U-NII-8, The maximum gain is 5.12 dBi

802.11be (EHT160) Punctured by 40 MHz

Chan.	Chan. Freq. (MHz)	Average Power (dBm)		Total Power (mW)	Total Power (dBm)	Maximum Gain (dBi)	EIRP (mW)	EIRP (dBm)	EIRP Limit (dBm)	Test Result
		Chain 0	Chain 1							
47	6185	9.44	9.96	18.699	12.72	5.14	61.069	17.86	24	Pass
111	6505	9.42	10.03	18.819	12.75	5.09	60.757	17.84	24	Pass
143	6665	9.09	10.25	18.702	12.72	5.16	61.36	17.88	24	Pass
207	6985	9.43	10.14	19.098	12.81	5.12	62.085	17.93	24	Pass

Notes:

1. Directional gain is the maximum gain of antennas.
2. For U-NII-5, The maximum gain is 5.14 dBi
3. For U-NII-6, The maximum gain is 5.09 dBi
4. For U-NII-7, The maximum gain is 5.16 dBi
5. For U-NII-8, The maximum gain is 5.12 dBi

802.11be (EHT320) Punctured by 40 MHz

Chan.	Chan. Freq. (MHz)	Average Power (dBm)		Total Power (mW)	Total Power (dBm)	Maximum Gain (dBi)	EIRP (mW)	EIRP (dBm)	EIRP Limit (dBm)	Test Result
		Chain 0	Chain 1							
63	6265	12.19	13.14	37.164	15.70	5.14	121.373	20.84	24	Pass
159	6745	12.22	13.41	38.601	15.87	5.16	126.648	21.03	24	Pass
191	6905	12.16	13.06	36.674	15.64	5.12	119.223	20.76	24	Pass

Notes:

1. Directional gain is the maximum gain of antennas.
2. For U-NII-5, The maximum gain is 5.14 dBi
3. For U-NII-6, The maximum gain is 5.09 dBi
4. For U-NII-7, The maximum gain is 5.16 dBi
5. For U-NII-8, The maximum gain is 5.12 dBi

802.11be (EHT320) Punctured by 80 MHz

Chan.	Chan. Freq. (MHz)	Average Power (dBm)		Total Power (mW)	Total Power (dBm)	Maximum Gain (dBi)	EIRP (mW)	EIRP (dBm)	EIRP Limit (dBm)	Test Result
		Chain 0	Chain 1							
63	6265	11.00	11.92	28.149	14.49	5.14	91.931	19.63	24	Pass
159	6745	10.83	12.01	27.991	14.47	5.16	91.837	19.63	24	Pass
191	6905	10.90	11.52	26.493	14.23	5.12	86.125	19.35	24	Pass

Notes:

1. Directional gain is the maximum gain of antennas.
2. For U-NII-5, The maximum gain is 5.14 dBi
3. For U-NII-6, The maximum gain is 5.09 dBi
4. For U-NII-7, The maximum gain is 5.16 dBi
5. For U-NII-8, The maximum gain is 5.12 dBi

802.11be (EHT320) Punctured by 80+40 MHz

Chan.	Chan. Freq. (MHz)	Average Power (dBm)		Total Power (mW)	Total Power (dBm)	Maximum Gain (dBi)	EIRP (mW)	EIRP (dBm)	EIRP Limit (dBm)	Test Result
		Chain 0	Chain 1							
63	6265	9.47	10.44	19.917	12.99	5.14	65.046	18.13	24	Pass
159	6745	9.25	10.66	20.055	13.02	5.16	65.8	18.18	24	Pass
191	6905	9.34	10.43	19.631	12.93	5.12	63.818	18.05	24	Pass

Notes:

1. Directional gain is the maximum gain of antennas.
2. For U-NII-5, The maximum gain is 5.14 dBi
3. For U-NII-6, The maximum gain is 5.09 dBi
4. For U-NII-7, The maximum gain is 5.16 dBi
5. For U-NII-8, The maximum gain is 5.12 dBi

7.2 Power Spectral Density

Mode A

Input Power:	3.3 Vdc	Environmental Conditions:	24°C, 65% RH	Tested By:	Eric Peng
--------------	---------	---------------------------	--------------	------------	-----------

802.11a

Chan.	Chan. Freq. (MHz)	PSD (dBm/MHz)		Total PSD (dBm/MHz)	Directional Gain (dBi)	EIRP PSD (dBm/MHz)	EIRP PSD Limit (dBm/MHz)	Test Result
		Chain 0	Chain 1					
2	5935	-11.92	-13.10	-9.46	8.15	-1.31	-1	Pass
1	5955	-11.85	-12.92	-9.34	8.15	-1.19	-1	Pass
45	6175	-12.89	-12.67	-9.77	8.15	-1.62	-1	Pass
93	6415	-12.70	-13.37	-10.01	8.15	-1.86	-1	Pass
97	6435	-12.10	-12.84	-9.44	8.10	-1.34	-1	Pass
105	6475	-12.14	-12.81	-9.45	8.10	-1.35	-1	Pass
113	6515	-11.94	-12.77	-9.32	8.10	-1.22	-1	Pass
117	6535	-12.16	-12.64	-9.38	8.17	-1.21	-1	Pass
149	6695	-12.36	-12.20	-9.27	8.17	-1.1	-1	Pass
181	6855	-12.57	-11.87	-9.20	8.17	-1.03	-1	Pass
185	6875	-12.58	-12.19	-9.37	8.17	-1.2	-1	Pass
209	6995	-13.15	-12.68	-9.90	8.13	-1.77	-1	Pass
233	7115	-12.72	-11.81	-9.23	8.13	-1.1	-1	Pass

Notes:

- Method E) 2) a) of power density measurement of KDB 662911 is using for calculating total power density. Total power density is summing entire spectra across corresponding frequency bins on the various outputs by computer.
- Directional gain = gain of antenna element + 10 log (2 of TX antenna elements)
- For U-NII-5, The directional gain is 8.15 dBi
- For U-NII-6, The directional gain is 8.1 dBi
- For U-NII-7, The directional gain is 8.17 dBi
- For U-NII-8, The directional gain is 8.13 dBi

802.11be (EHT20)

Chan.	Chan. Freq. (MHz)	PSD (dBm/MHz)		Total PSD (dBm/MHz)	Directional Gain (dBi)	EIRP PSD (dBm/MHz)	EIRP PSD Limit (dBm/MHz)	Test Result
		Chain 0	Chain 1					
2	5935	-11.88	-12.68	-9.25	8.15	-1.1	-1	Pass
1	5955	-12.20	-13.15	-9.64	8.15	-1.49	-1	Pass
45	6175	-12.44	-12.21	-9.31	8.15	-1.16	-1	Pass
93	6415	-12.14	-12.94	-9.51	8.15	-1.36	-1	Pass
97	6435	-11.79	-12.66	-9.19	8.10	-1.09	-1	Pass
105	6475	-11.75	-12.56	-9.13	8.10	-1.03	-1	Pass
113	6515	-12.17	-13.03	-9.57	8.10	-1.47	-1	Pass
117	6535	-12.43	-12.91	-9.65	8.17	-1.48	-1	Pass
149	6695	-12.64	-12.52	-9.57	8.17	-1.4	-1	Pass
181	6855	-12.53	-11.99	-9.24	8.17	-1.07	-1	Pass
185	6875	-12.35	-12.03	-9.18	8.17	-1.01	-1	Pass
209	6995	-12.76	-12.49	-9.61	8.13	-1.48	-1	Pass
233	7115	-12.69	-11.89	-9.26	8.13	-1.13	-1	Pass

Notes:

1. Method E) 2) a) of power density measurement of KDB 662911 is using for calculating total power density. Total power density is summing entire spectra across corresponding frequency bins on the various outputs by computer.
2. Directional gain = gain of antenna element + 10 log (2 of TX antenna elements)
3. For U-NII-5, The directional gain is 8.15 dBi
4. For U-NII-6, The directional gain is 8.1 dBi
5. For U-NII-7, The directional gain is 8.17 dBi
6. For U-NII-8, The directional gain is 8.13 dBi

802.11be (EHT40)

Chan.	Chan. Freq. (MHz)	PSD (dBm/MHz)		Total PSD (dBm/MHz)	Directional Gain (dBi)	EIRP PSD (dBm/MHz)	EIRP PSD Limit (dBm/MHz)	Test Result
		Chain 0	Chain 1					
3	5965	-12.24	-12.36	-9.29	8.15	-1.14	-1	Pass
43	6165	-12.64	-12.53	-9.57	8.15	-1.42	-1	Pass
91	6405	-13.23	-12.12	-9.63	8.15	-1.48	-1	Pass
99	6445	-13.37	-12.22	-9.75	8.10	-1.65	-1	Pass
107	6485	-13.37	-12.81	-10.07	8.10	-1.97	-1	Pass
115	6525	-13.11	-12.74	-9.91	8.17	-1.74	-1	Pass
123	6565	-13.33	-12.51	-9.89	8.17	-1.72	-1	Pass
155	6725	-13.79	-12.12	-9.86	8.17	-1.69	-1	Pass
179	6845	-12.88	-11.86	-9.33	8.17	-1.16	-1	Pass
187	6885	-13.11	-12.07	-9.55	8.17	-1.38	-1	Pass
211	7005	-13.06	-11.40	-9.14	8.13	-1.01	-1	Pass
227	7085	-13.20	-11.34	-9.16	8.13	-1.03	-1	Pass

Notes:

1. Method E) 2) a) of power density measurement of KDB 662911 is using for calculating total power density. Total power density is summing entire spectra across corresponding frequency bins on the various outputs by computer.
2. Directional gain = gain of antenna element + 10 log (2 of TX antenna elements)
3. For U-NII-5, The directional gain is 8.15 dBi
4. For U-NII-6, The directional gain is 8.1 dBi
5. For U-NII-7, The directional gain is 8.17 dBi
6. For U-NII-8, The directional gain is 8.13 dBi

802.11be (EHT80)

Chan.	Chan. Freq. (MHz)	PSD (dBm/MHz)		Total PSD (dBm/MHz)	Directional Gain (dBi)	EIRP PSD (dBm/MHz)	EIRP PSD Limit (dBm/MHz)	Test Result
		Chain 0	Chain 1					
7	5985	-12.54	-12.63	-9.57	8.15	-1.42	-1	Pass
39	6145	-13.92	-12.69	-10.25	8.15	-2.1	-1	Pass
87	6385	-14.27	-12.34	-10.19	8.15	-2.04	-1	Pass
103	6465	-13.48	-11.84	-9.57	8.10	-1.47	-1	Pass
119	6545	-12.74	-12.31	-9.51	8.17	-1.34	-1	Pass
151	6705	-13.90	-11.56	-9.56	8.17	-1.39	-1	Pass
183	6865	-13.91	-11.63	-9.61	8.17	-1.44	-1	Pass
199	6945	-12.96	-12.02	-9.45	8.13	-1.32	-1	Pass
215	7025	-13.12	-12.01	-9.52	8.13	-1.39	-1	Pass

Notes:

1. Method E) 2) a) of power density measurement of KDB 662911 is using for calculating total power density. Total power density is summing entire spectra across corresponding frequency bins on the various outputs by computer.
2. Directional gain = gain of antenna element + 10 log (2 of TX antenna elements)
3. For U-NII-5, The directional gain is 8.15 dBi
4. For U-NII-6, The directional gain is 8.1 dBi
5. For U-NII-7, The directional gain is 8.17 dBi
6. For U-NII-8, The directional gain is 8.13 dBi

802.11be (EHT160)

Chan.	Chan. Freq. (MHz)	PSD (dBm/MHz)		Total PSD (dBm/MHz)	Directional Gain (dBi)	EIRP PSD (dBm/MHz)	EIRP PSD Limit (dBm/MHz)	Test Result
		Chain 0	Chain 1					
15	6025	-12.79	-12.71	-9.74	8.15	-1.59	-1	Pass
47	6185	-12.62	-12.31	-9.45	8.15	-1.3	-1	Pass
79	6345	-13.01	-12.72	-9.85	8.15	-1.7	-1	Pass
111	6505	-12.63	-12.21	-9.40	8.10	-1.3	-1	Pass
143	6665	-13.05	-12.20	-9.59	8.17	-1.42	-1	Pass
175	6825	-13.45	-12.13	-9.73	8.17	-1.56	-1	Pass
207	6985	-13.22	-11.97	-9.54	8.13	-1.41	-1	Pass

Notes:

1. Method E) 2) a) of power density measurement of KDB 662911 is using for calculating total power density. Total power density is summing entire spectra across corresponding frequency bins on the various outputs by computer.
2. Directional gain = gain of antenna element + 10 log (2 of TX antenna elements)
3. For U-NII-5, The directional gain is 8.15 dBi
4. For U-NII-6, The directional gain is 8.1 dBi
5. For U-NII-7, The directional gain is 8.17 dBi
6. For U-NII-8, The directional gain is 8.13 dBi

802.11be (EHT320)

Chan.	Chan. Freq. (MHz)	PSD (dBm/MHz)		Total PSD (dBm/MHz)	Directional Gain (dBi)	EIRP PSD (dBm/MHz)	EIRP PSD Limit (dBm/MHz)	Test Result
		Chain 0	Chain 1					
31	6105	-12.74	-12.56	-9.64	8.15	-1.49	-1	Pass
63	6265	-12.72	-12.30	-9.49	8.15	-1.34	-1	Pass
95	6425	-12.86	-12.58	-9.71	8.15	-1.56	-1	Pass
127	6585	-12.81	-12.39	-9.58	8.17	-1.41	-1	Pass
159	6745	-13.05	-12.07	-9.52	8.17	-1.35	-1	Pass
191	6905	-13.37	-12.30	-9.79	8.17	-1.62	-1	Pass

Notes:

1. Method E) 2) a) of power density measurement of KDB 662911 is using for calculating total power density. Total power density is summing entire spectra across corresponding frequency bins on the various outputs by computer.
2. Directional gain = gain of antenna element + 10 log (2 of TX antenna elements)
3. For U-NII-5, The directional gain is 8.15 dBi
4. For U-NII-6, The directional gain is 8.1 dBi
5. For U-NII-7, The directional gain is 8.17 dBi
6. For U-NII-8, The directional gain is 8.13 dBi

802.11be (EHT20) 26-tone RU

Chan.	Chan. Freq. (MHz)	PSD (dBm/MHz)		Total PSD (dBm/MHz)	Directional Gain (dBi)	EIRP PSD (dBm/MHz)	EIRP PSD Limit (dBm/MHz)	Test Result
		Chain 0	Chain 1					
2	5935	-13.66	-14.85	-11.20	8.15	-3.05	-1	Pass
1	5955	-13.42	-14.78	-11.04	8.15	-2.89	-1	Pass
45	6175	-14.33	-14.27	-11.29	8.15	-3.14	-1	Pass
93	6415	-13.79	-14.53	-11.13	8.15	-2.98	-1	Pass
97	6435	-13.93	-14.56	-11.22	8.10	-3.12	-1	Pass
105	6475	-13.94	-14.53	-11.21	8.10	-3.11	-1	Pass
113	6515	-13.73	-14.28	-10.99	8.10	-2.89	-1	Pass
117	6535	-13.85	-14.24	-11.03	8.17	-2.86	-1	Pass
149	6695	-13.89	-13.74	-10.80	8.17	-2.63	-1	Pass
181	6855	-14.21	-13.73	-10.95	8.17	-2.78	-1	Pass
185	6875	-14.49	-14.25	-11.36	8.17	-3.19	-1	Pass
209	6995	-14.03	-14.20	-11.10	8.13	-2.97	-1	Pass
233	7115	-14.50	-13.79	-11.12	8.13	-2.99	-1	Pass

Notes:

- Method E) 2) a) of power density measurement of KDB 662911 is using for calculating total power density. Total power density is summing entire spectra across corresponding frequency bins on the various outputs by computer.
- Directional gain = gain of antenna element + 10 log (2 of TX antenna elements)
- For U-NII-5, The directional gain is 8.15 dBi
- For U-NII-6, The directional gain is 8.1 dBi
- For U-NII-7, The directional gain is 8.17 dBi
- For U-NII-8, The directional gain is 8.13 dBi

802.11be (EHT20) 52-tone RU

Chan.	Chan. Freq. (MHz)	PSD (dBm/MHz)		Total PSD (dBm/MHz)	Directional Gain (dBi)	EIRP PSD (dBm/MHz)	EIRP PSD Limit (dBm/MHz)	Test Result
		Chain 0	Chain 1					
2	5935	-13.56	-14.62	-11.05	8.15	-2.9	-1	Pass
1	5955	-13.48	-14.59	-10.99	8.15	-2.84	-1	Pass
45	6175	-14.58	-14.27	-11.41	8.15	-3.26	-1	Pass
93	6415	-14.02	-14.63	-11.30	8.15	-3.15	-1	Pass
97	6435	-14.24	-14.60	-11.41	8.10	-3.31	-1	Pass
105	6475	-14.27	-14.67	-11.46	8.10	-3.36	-1	Pass
113	6515	-13.83	-14.23	-11.02	8.10	-2.92	-1	Pass
117	6535	-14.23	-14.40	-11.30	8.17	-3.13	-1	Pass
149	6695	-14.25	-14.19	-11.21	8.17	-3.04	-1	Pass
181	6855	-14.38	-13.82	-11.08	8.17	-2.91	-1	Pass
185	6875	-14.34	-14.20	-11.26	8.17	-3.09	-1	Pass
209	6995	-14.33	-14.37	-11.34	8.13	-3.21	-1	Pass
233	7115	-14.75	-13.95	-11.32	8.13	-3.19	-1	Pass

Notes:

1. Method E) 2) a) of power density measurement of KDB 662911 is using for calculating total power density. Total power density is summing entire spectra across corresponding frequency bins on the various outputs by computer.
2. Directional gain = gain of antenna element + 10 log (2 of TX antenna elements)
3. For U-NII-5, The directional gain is 8.15 dBi
4. For U-NII-6, The directional gain is 8.1 dBi
5. For U-NII-7, The directional gain is 8.17 dBi
6. For U-NII-8, The directional gain is 8.13 dBi

802.11be (EHT20) 106-tone RU

Chan.	Chan. Freq. (MHz)	PSD (dBm/MHz)		Total PSD (dBm/MHz)	Directional Gain (dBi)	EIRP PSD (dBm/MHz)	EIRP PSD Limit (dBm/MHz)	Test Result
		Chain 0	Chain 1					
2	5935	-12.03	-12.86	-9.41	8.15	-1.26	-1	Pass
1	5955	-12.08	-12.89	-9.46	8.15	-1.31	-1	Pass
45	6175	-12.90	-12.60	-9.74	8.15	-1.59	-1	Pass
93	6415	-12.76	-13.42	-10.07	8.15	-1.92	-1	Pass
97	6435	-12.31	-12.78	-9.53	8.10	-1.43	-1	Pass
105	6475	-12.36	-12.69	-9.51	8.10	-1.41	-1	Pass
113	6515	-12.13	-12.77	-9.43	8.10	-1.33	-1	Pass
117	6535	-12.32	-12.59	-9.44	8.17	-1.27	-1	Pass
149	6695	-12.48	-12.36	-9.41	8.17	-1.24	-1	Pass
181	6855	-12.90	-12.19	-9.52	8.17	-1.35	-1	Pass
185	6875	-12.81	-12.44	-9.61	8.17	-1.44	-1	Pass
209	6995	-12.58	-12.33	-9.44	8.13	-1.31	-1	Pass
233	7115	-13.15	-11.97	-9.51	8.13	-1.38	-1	Pass

Notes:

1. Method E) 2) a) of power density measurement of KDB 662911 is using for calculating total power density. Total power density is summing entire spectra across corresponding frequency bins on the various outputs by computer.
2. Directional gain = gain of antenna element + 10 log (2 of TX antenna elements)
3. For U-NII-5, The directional gain is 8.15 dBi
4. For U-NII-6, The directional gain is 8.1 dBi
5. For U-NII-7, The directional gain is 8.17 dBi
6. For U-NII-8, The directional gain is 8.13 dBi

802.11be (EHT20) 242-tone RU

Chan.	Chan. Freq. (MHz)	PSD (dBm/MHz)		Total PSD (dBm/MHz)	Directional Gain (dBi)	EIRP PSD (dBm/MHz)	EIRP PSD Limit (dBm/MHz)	Test Result
		Chain 0	Chain 1					
2	5935	-12.20	-12.95	-9.55	8.15	-1.4	-1	Pass
1	5955	-12.12	-12.87	-9.47	8.15	-1.32	-1	Pass
45	6175	-12.86	-12.56	-9.70	8.15	-1.55	-1	Pass
93	6415	-12.65	-13.33	-9.97	8.15	-1.82	-1	Pass
97	6435	-12.19	-12.79	-9.47	8.10	-1.37	-1	Pass
105	6475	-12.26	-12.74	-9.48	8.10	-1.38	-1	Pass
113	6515	-12.16	-12.70	-9.41	8.10	-1.31	-1	Pass
117	6535	-12.27	-12.55	-9.40	8.17	-1.23	-1	Pass
149	6695	-12.43	-12.18	-9.29	8.17	-1.12	-1	Pass
181	6855	-12.79	-12.16	-9.45	8.17	-1.28	-1	Pass
185	6875	-12.62	-12.46	-9.53	8.17	-1.36	-1	Pass
209	6995	-12.48	-11.94	-9.19	8.13	-1.06	-1	Pass
233	7115	-12.81	-11.95	-9.35	8.13	-1.22	-1	Pass

Notes:

1. Method E) 2) a) of power density measurement of KDB 662911 is using for calculating total power density. Total power density is summing entire spectra across corresponding frequency bins on the various outputs by computer.
2. Directional gain = gain of antenna element + 10 log (2 of TX antenna elements)
3. For U-NII-5, The directional gain is 8.15 dBi
4. For U-NII-6, The directional gain is 8.1 dBi
5. For U-NII-7, The directional gain is 8.17 dBi
6. For U-NII-8, The directional gain is 8.13 dBi

802.11be (EHT40) 484-tone RU

Chan.	Chan. Freq. (MHz)	PSD (dBm/MHz)		Total PSD (dBm/MHz)	Directional Gain (dBi)	EIRP PSD (dBm/MHz)	EIRP PSD Limit (dBm/MHz)	Test Result
		Chain 0	Chain 1					
3	5965	-12.79	-12.14	-9.44	8.15	-1.29	-1	Pass
43	6165	-12.60	-12.39	-9.48	8.15	-1.33	-1	Pass
91	6405	-13.67	-13.21	-10.42	8.15	-2.27	-1	Pass
99	6445	-13.31	-12.01	-9.60	8.10	-1.5	-1	Pass
107	6485	-13.25	-12.64	-9.92	8.10	-1.82	-1	Pass
115	6525	-13.62	-12.55	-10.04	8.17	-1.87	-1	Pass
123	6565	-13.21	-12.32	-9.73	8.17	-1.56	-1	Pass
155	6725	-13.69	-11.90	-9.69	8.17	-1.52	-1	Pass
179	6845	-13.33	-12.17	-9.70	8.17	-1.53	-1	Pass
187	6885	-14.33	-12.52	-10.32	8.17	-2.19	-1	Pass
211	7005	-14.19	-12.15	-10.04	8.13	-1.91	-1	Pass
227	7085	-14.33	-12.07	-10.04	8.13	-1.91	-1	Pass

Notes:

1. Method E) 2) a) of power density measurement of KDB 662911 is using for calculating total power density. Total power density is summing entire spectra across corresponding frequency bins on the various outputs by computer.
2. Directional gain = gain of antenna element + 10 log (2 of TX antenna elements)
3. For U-NII-5, The directional gain is 8.15 dBi
4. For U-NII-6, The directional gain is 8.1 dBi
5. For U-NII-7, The directional gain is 8.17 dBi
6. For U-NII-8, The directional gain is 8.13 dBi

802.11be (EHT80) 996-tone RU

Chan.	Chan. Freq. (MHz)	PSD (dBm/MHz)		Total PSD (dBm/MHz)	Directional Gain (dBi)	EIRP PSD (dBm/MHz)	EIRP PSD Limit (dBm/MHz)	Test Result
		Chain 0	Chain 1					
7	5985	-13.58	-12.23	-9.84	8.15	-1.69	-1	Pass
39	6145	-13.88	-12.30	-10.01	8.15	-1.86	-1	Pass
87	6385	-14.09	-12.19	-10.03	8.15	-1.88	-1	Pass
103	6465	-14.13	-12.11	-9.99	8.10	-1.89	-1	Pass
119	6545	-13.47	-12.99	-10.21	8.17	-2.04	-1	Pass
151	6705	-14.60	-11.60	-9.84	8.17	-1.67	-1	Pass
183	6865	-14.24	-12.97	-10.55	8.17	-2.38	-1	Pass
199	6945	-12.56	-12.72	-9.63	8.13	-1.5	-1	Pass
215	7025	-13.99	-12.81	-10.35	8.13	-2.22	-1	Pass

Notes:

1. Method E) 2) a) of power density measurement of KDB 662911 is using for calculating total power density. Total power density is summing entire spectra across corresponding frequency bins on the various outputs by computer.
2. Directional gain = gain of antenna element + 10 log (2 of TX antenna elements)
3. For U-NII-5, The directional gain is 8.15 dBi
4. For U-NII-6, The directional gain is 8.1 dBi
5. For U-NII-7, The directional gain is 8.17 dBi
6. For U-NII-8, The directional gain is 8.13 dBi

802.11be (EHT160) 2x996-tone RU

Chan.	Chan. Freq. (MHz)	PSD (dBm/MHz)		Total PSD (dBm/MHz)	Directional Gain (dBi)	EIRP PSD (dBm/MHz)	EIRP PSD Limit (dBm/MHz)	Test Result
		Chain 0	Chain 1					
15	6025	-14.77	-13.89	-11.30	8.15	-3.15	-1	Pass
47	6185	-14.59	-13.90	-11.22	8.15	-3.07	-1	Pass
79	6345	-14.72	-14.53	-11.61	8.15	-3.46	-1	Pass
111	6505	-14.72	-14.05	-11.36	8.10	-3.26	-1	Pass
143	6665	-15.00	-13.82	-11.36	8.17	-3.19	-1	Pass
175	6825	-15.61	-13.87	-11.64	8.17	-3.47	-1	Pass
207	6985	-14.69	-13.44	-11.01	8.13	-2.88	-1	Pass

Notes:

1. Method E) 2) a) of power density measurement of KDB 662911 is using for calculating total power density. Total power density is summing entire spectra across corresponding frequency bins on the various outputs by computer.
2. Directional gain = gain of antenna element + 10 log (2 of TX antenna elements)
3. For U-NII-5, The directional gain is 8.15 dBi
4. For U-NII-6, The directional gain is 8.1 dBi
5. For U-NII-7, The directional gain is 8.17 dBi
6. For U-NII-8, The directional gain is 8.13 dBi

802.11be (EHT20) 52+26-tone MRU

Chan.	Chan. Freq. (MHz)	PSD (dBm/MHz)		Total PSD (dBm/MHz)	Directional Gain (dBi)	EIRP PSD (dBm/MHz)	EIRP PSD Limit (dBm/MHz)	Test Result
		Chain 0	Chain 1					
45	6175	-13.91	-13.39	-10.63	8.15	-2.48	-1	Pass
105	6475	-13.80	-14.11	-10.94	8.10	-2.84	-1	Pass
185	6875	-14.24	-13.69	-10.95	8.13	-2.82	-1	Pass
209	6995	-14.08	-13.63	-10.84	8.13	-2.71	-1	Pass

Notes:

- Method E) 2) a) of power density measurement of KDB 662911 is using for calculating total power density. Total power density is summing entire spectra across corresponding frequency bins on the various outputs by computer.
- Directional gain = gain of antenna element + 10 log (2 of TX antenna elements)
- For U-NII-5, The directional gain is 8.15 dBi
- For U-NII-6, The directional gain is 8.1 dBi
- For U-NII-7, The directional gain is 8.17 dBi
- For U-NII-8, The directional gain is 8.13 dBi

802.11be (EHT20) 106+26-tone MRU

Chan.	Chan. Freq. (MHz)	PSD (dBm/MHz)		Total PSD (dBm/MHz)	Directional Gain (dBi)	EIRP PSD (dBm/MHz)	EIRP PSD Limit (dBm/MHz)	Test Result
		Chain 0	Chain 1					
45	6175	-13.14	-12.63	-9.87	8.15	-1.72	-1	Pass
105	6475	-12.56	-12.88	-9.71	8.10	-1.61	-1	Pass
185	6875	-12.89	-12.55	-9.71	8.13	-1.58	-1	Pass
209	6995	-12.70	-12.86	-9.77	8.13	-1.64	-1	Pass

Notes:

- Method E) 2) a) of power density measurement of KDB 662911 is using for calculating total power density. Total power density is summing entire spectra across corresponding frequency bins on the various outputs by computer.
- Directional gain = gain of antenna element + 10 log (2 of TX antenna elements)
- For U-NII-5, The directional gain is 8.15 dBi
- For U-NII-6, The directional gain is 8.1 dBi
- For U-NII-7, The directional gain is 8.17 dBi
- For U-NII-8, The directional gain is 8.13 dBi

802.11be (EHT80) 484+242-tone MRU

Chan.	Chan. Freq. (MHz)	PSD (dBm/MHz)		Total PSD (dBm/MHz)	Directional Gain (dBi)	EIRP PSD (dBm/MHz)	EIRP PSD Limit (dBm/MHz)	Test Result
		Chain 0	Chain 1					
7	5985	-13.53	-13.24	-10.37	8.15	-2.22	-1	Pass
103	6465	-14.44	-13.67	-11.03	8.10	-2.93	-1	Pass
119	6545	-12.93	-12.31	-9.60	8.17	-1.43	-1	Pass
199	6945	-13.54	-12.18	-9.80	8.13	-1.67	-1	Pass

Notes:

1. Method E) 2) a) of power density measurement of KDB 662911 is using for calculating total power density. Total power density is summing entire spectra across corresponding frequency bins on the various outputs by computer.
2. Directional gain = gain of antenna element + 10 log (2 of TX antenna elements)
3. For U-NII-5, The directional gain is 8.15 dBi
4. For U-NII-6, The directional gain is 8.1 dBi
5. For U-NII-7, The directional gain is 8.17 dBi
6. For U-NII-8, The directional gain is 8.13 dBi

802.11be (EHT160) 996+484-tone MRU

Chan.	Chan. Freq. (MHz)	PSD (dBm/MHz)		Total PSD (dBm/MHz)	Directional Gain (dBi)	EIRP PSD (dBm/MHz)	EIRP PSD Limit (dBm/MHz)	Test Result
		Chain 0	Chain 1					
47	6185	-13.54	-12.97	-10.24	8.15	-2.09	-1	Pass
111	6505	-13.64	-13.16	-10.38	8.10	-2.28	-1	Pass
143	6665	-13.98	-12.87	-10.38	8.17	-2.21	-1	Pass
207	6985	-13.36	-12.74	-10.03	8.13	-1.9	-1	Pass

Notes:

1. Method E) 2) a) of power density measurement of KDB 662911 is using for calculating total power density. Total power density is summing entire spectra across corresponding frequency bins on the various outputs by computer.
2. Directional gain = gain of antenna element + 10 log (2 of TX antenna elements)
3. For U-NII-5, The directional gain is 8.15 dBi
4. For U-NII-6, The directional gain is 8.1 dBi
5. For U-NII-7, The directional gain is 8.17 dBi
6. For U-NII-8, The directional gain is 8.13 dBi

802.11be (EHT320) 2x996+484-tone MRU

Chan.	Chan. Freq. (MHz)	PSD w/o Duty Factor (dBm/MHz)		Duty Factor (dB)	Total PSD (dBm/MHz)	Directional Gain (dBi)	EIRP PSD (dBm/MHz)	EIRP PSD Limit (dBm/MHz)	Test Result
		Chain 0	Chain 1						
63	6265	-13.51	-12.25	0.18	-9.64	8.15	-1.49	-1	Pass
159	6745	-13.66	-12.14	0.18	-9.64	8.17	-1.47	-1	Pass
191	6905	-13.61	-12.53	0.18	-9.85	8.13	-1.72	-1	Pass

Notes:

1. Method E) 2) a) of power density measurement of KDB 662911 is using for calculating total power density. Total power density is summing entire spectra across corresponding frequency bins on the various outputs by computer.
2. Directional gain = gain of antenna element + 10 log (2 of TX antenna elements)
3. For U-NII-5, The directional gain is 8.15 dBi
4. For U-NII-6, The directional gain is 8.1 dBi
5. For U-NII-7, The directional gain is 8.17 dBi
6. For U-NII-8, The directional gain is 8.13 dBi

802.11be (EHT320) 3x996-tone MRU

Chan.	Chan. Freq. (MHz)	PSD w/o Duty Factor (dBm/MHz)		Duty Factor (dB)	Total PSD (dBm/MHz)	Directional Gain (dBi)	EIRP PSD (dBm/MHz)	EIRP PSD Limit (dBm/MHz)	Test Result
		Chain 0	Chain 1						
63	6265	-14.79	-13.72	0.18	-11.03	8.15	-2.88	-1	Pass
159	6745	-15.91	-13.80	0.18	-11.54	8.17	-3.37	-1	Pass
191	6905	-15.39	-14.25	0.18	-11.59	8.13	-3.46	-1	Pass

Notes:

1. Method E) 2) a) of power density measurement of KDB 662911 is using for calculating total power density. Total power density is summing entire spectra across corresponding frequency bins on the various outputs by computer.
2. Directional gain = gain of antenna element + 10 log (2 of TX antenna elements)
3. For U-NII-5, The directional gain is 8.15 dBi
4. For U-NII-6, The directional gain is 8.1 dBi
5. For U-NII-7, The directional gain is 8.17 dBi
6. For U-NII-8, The directional gain is 8.13 dBi

802.11be (EHT320) 3x996+484-tone MRU

Chan.	Chan. Freq. (MHz)	PSD w/o Duty Factor (dBm/MHz)		Duty Factor (dB)	Total PSD (dBm/MHz)	Directional Gain (dBi)	EIRP PSD (dBm/MHz)	EIRP PSD Limit (dBm/MHz)	Test Result
		Chain 0	Chain 1						
63	6265	-16.83	-14.72	0.18	-12.46	8.15	-4.31	-1	Pass
159	6745	-17.00	-14.72	0.18	-12.52	8.17	-4.35	-1	Pass
191	6905	-16.87	-15.48	0.18	-12.93	8.13	-4.8	-1	Pass

Notes:

1. Method E) 2) a) of power density measurement of KDB 662911 is using for calculating total power density. Total power density is summing entire spectra across corresponding frequency bins on the various outputs by computer.
2. Directional gain = gain of antenna element + 10 log (2 of TX antenna elements)
3. For U-NII-5, The directional gain is 8.15 dBi
4. For U-NII-6, The directional gain is 8.1 dBi
5. For U-NII-7, The directional gain is 8.17 dBi
6. For U-NII-8, The directional gain is 8.13 dBi

802.11be (EHT80) Punctured by 20 MHz

Chan.	Chan. Freq. (MHz)	PSD (dBm/MHz)		Total PSD (dBm/MHz)	Directional Gain (dBi)	EIRP PSD (dBm/MHz)	EIRP PSD Limit (dBm/MHz)	Test Result
		Chain 0	Chain 1					
7	5985	-13.41	-12.84	-10.11	8.15	-1.96	-1	Pass
103	6465	-14.10	-11.48	-9.59	8.10	-1.49	-1	Pass
119	6545	-12.93	-12.17	-9.52	8.17	-1.35	-1	Pass
199	6945	-12.94	-12.28	-9.59	8.13	-1.46	-1	Pass

Notes:

1. Method E) 2) a) of power density measurement of KDB 662911 is using for calculating total power density. Total power density is summing entire spectra across corresponding frequency bins on the various outputs by computer.
2. Directional gain = gain of antenna element + 10 log (2 of TX antenna elements)
3. For U-NII-5, The directional gain is 8.15 dBi
4. For U-NII-6, The directional gain is 8.1 dBi
5. For U-NII-7, The directional gain is 8.17 dBi
6. For U-NII-8, The directional gain is 8.13 dBi

802.11be (EHT160) Punctured by 20 MHz

Chan.	Chan. Freq. (MHz)	PSD (dBm/MHz)		Total PSD (dBm/MHz)	Directional Gain (dBi)	EIRP PSD (dBm/MHz)	EIRP PSD Limit (dBm/MHz)	Test Result
		Chain 0	Chain 1					
47	6185	-13.37	-12.53	-9.92	8.15	-1.77	-1	Pass
111	6505	-13.33	-12.81	-10.05	8.10	-1.95	-1	Pass
143	6665	-13.92	-12.59	-10.19	8.17	-2.02	-1	Pass
207	6985	-13.61	-12.83	-10.19	8.13	-2.06	-1	Pass

Notes:

1. Method E) 2) a) of power density measurement of KDB 662911 is using for calculating total power density. Total power density is summing entire spectra across corresponding frequency bins on the various outputs by computer.
2. Directional gain = gain of antenna element + 10 log (2 of TX antenna elements)
3. For U-NII-5, The directional gain is 8.15 dBi
4. For U-NII-6, The directional gain is 8.1 dBi
5. For U-NII-7, The directional gain is 8.17 dBi
6. For U-NII-8, The directional gain is 8.13 dBi

802.11be (EHT160) Punctured by 40 MHz

Chan.	Chan. Freq. (MHz)	PSD (dBm/MHz)		Total PSD (dBm/MHz)	Directional Gain (dBi)	EIRP PSD (dBm/MHz)	EIRP PSD Limit (dBm/MHz)	Test Result
		Chain 0	Chain 1					
47	6185	-13.19	-12.36	-9.74	8.15	-1.59	-1	Pass
111	6505	-13.46	-12.20	-9.77	8.10	-1.67	-1	Pass
143	6665	-13.43	-12.54	-9.95	8.17	-1.78	-1	Pass
207	6985	-12.88	-12.73	-9.79	8.13	-1.66	-1	Pass

Notes:

1. Method E) 2) a) of power density measurement of KDB 662911 is using for calculating total power density. Total power density is summing entire spectra across corresponding frequency bins on the various outputs by computer.
2. Directional gain = gain of antenna element + 10 log (2 of TX antenna elements)
3. For U-NII-5, The directional gain is 8.15 dBi
4. For U-NII-6, The directional gain is 8.1 dBi
5. For U-NII-7, The directional gain is 8.17 dBi
6. For U-NII-8, The directional gain is 8.13 dBi

802.11be (EHT320) Punctured by 40 MHz

Chan.	Chan. Freq. (MHz)	PSD (dBm/MHz)		Total PSD (dBm/MHz)	Directional Gain (dBi)	EIRP PSD (dBm/MHz)	EIRP PSD Limit (dBm/MHz)	Test Result
		Chain 0	Chain 1					
63	6265	-13.70	-12.27	-9.92	8.15	-1.77	-1	Pass
159	6745	-13.63	-12.00	-9.73	8.17	-1.56	-1	Pass
191	6905	-13.57	-12.43	-9.95	8.13	-1.82	-1	Pass

Notes:

1. Method E) 2) a) of power density measurement of KDB 662911 is using for calculating total power density. Total power density is summing entire spectra across corresponding frequency bins on the various outputs by computer.
2. Directional gain = gain of antenna element + 10 log (2 of TX antenna elements)
3. For U-NII-5, The directional gain is 8.15 dBi
4. For U-NII-6, The directional gain is 8.1 dBi
5. For U-NII-7, The directional gain is 8.17 dBi
6. For U-NII-8, The directional gain is 8.13 dBi

802.11be (EHT320) Punctured by 80 MHz

Chan.	Chan. Freq. (MHz)	PSD (dBm/MHz)		Total PSD (dBm/MHz)	Directional Gain (dBi)	EIRP PSD (dBm/MHz)	EIRP PSD Limit (dBm/MHz)	Test Result
		Chain 0	Chain 1					
63	6265	-13.40	-12.37	-9.84	8.15	-1.69	-1	Pass
159	6745	-13.98	-12.40	-10.11	8.17	-1.94	-1	Pass
191	6905	-14.07	-12.86	-10.41	8.13	-2.28	-1	Pass

Notes:

1. Method E) 2) a) of power density measurement of KDB 662911 is using for calculating total power density. Total power density is summing entire spectra across corresponding frequency bins on the various outputs by computer.
2. Directional gain = gain of antenna element + 10 log (2 of TX antenna elements)
3. For U-NII-5, The directional gain is 8.15 dBi
4. For U-NII-6, The directional gain is 8.1 dBi
5. For U-NII-7, The directional gain is 8.17 dBi
6. For U-NII-8, The directional gain is 8.13 dBi



802.11be (EHT320) Punctured by 80+40 MHz

Chan.	Chan. Freq. (MHz)	PSD (dBm/MHz)		Total PSD (dBm/MHz)	Directional Gain (dBi)	EIRP PSD (dBm/MHz)	EIRP PSD Limit (dBm/MHz)	Test Result
		Chain 0	Chain 1					
63	6265	-15.19	-13.58	-11.30	8.15	-3.15	-1	Pass
159	6745	-15.40	-14.21	-11.75	8.17	-3.58	-1	Pass
191	6905	-15.46	-14.51	-11.95	8.13	-3.82	-1	Pass

Notes:

- Method E) 2) a) of power density measurement of KDB 662911 is using for calculating total power density. Total power density is summing entire spectra across corresponding frequency bins on the various outputs by computer.
- Directional gain = gain of antenna element + 10 log (2 of TX antenna elements)
- For U-NII-5, The directional gain is 8.15 dBi
- For U-NII-6, The directional gain is 8.1 dBi
- For U-NII-7, The directional gain is 8.17 dBi
- For U-NII-8, The directional gain is 8.13 dBi

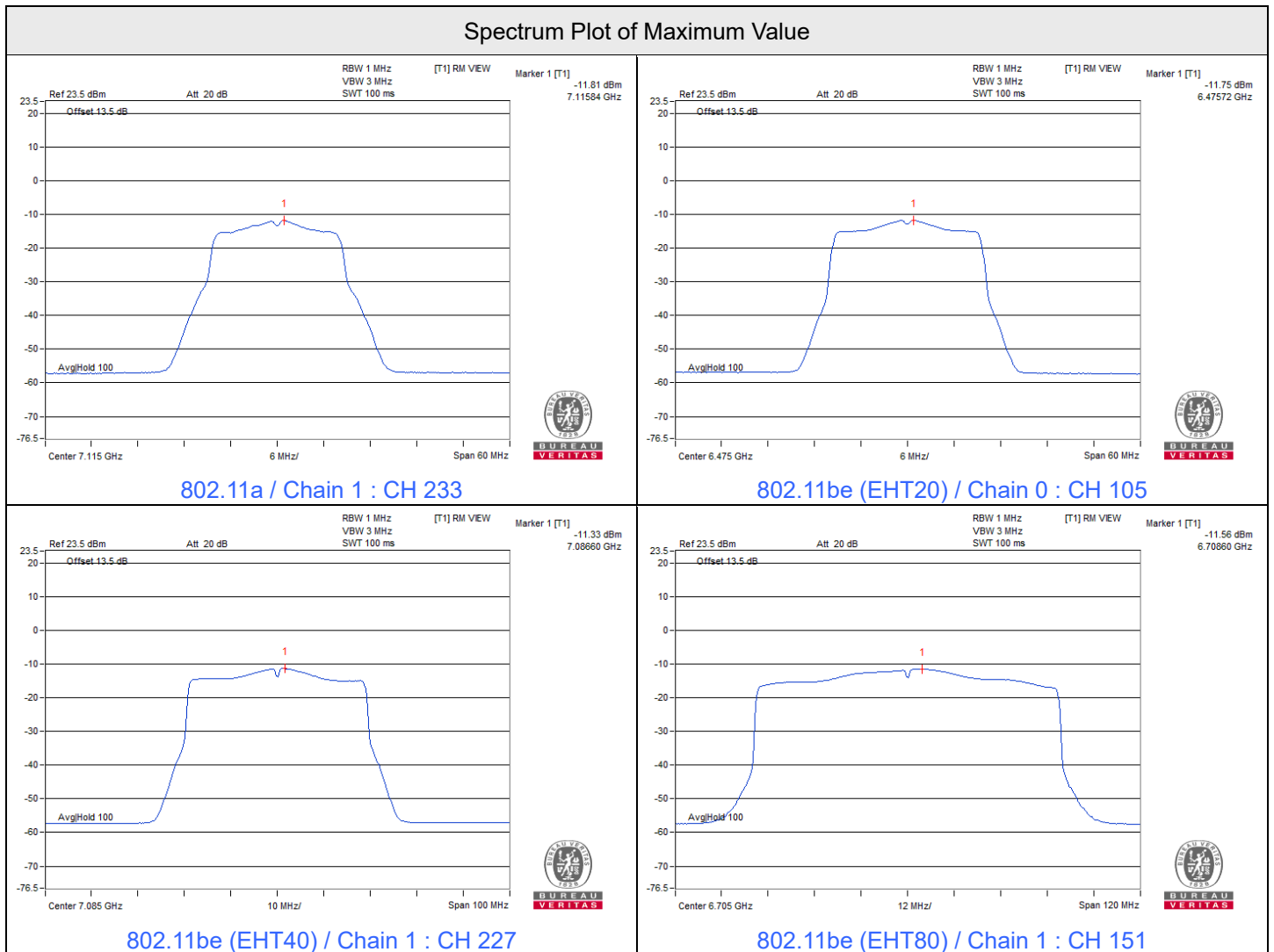

Spectrum Plot of Maximum Value

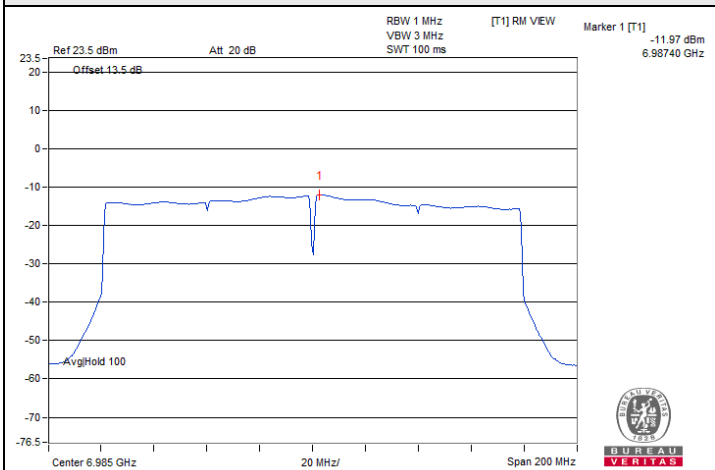

802.11be (EHT160) / Chain 1 : CH 207

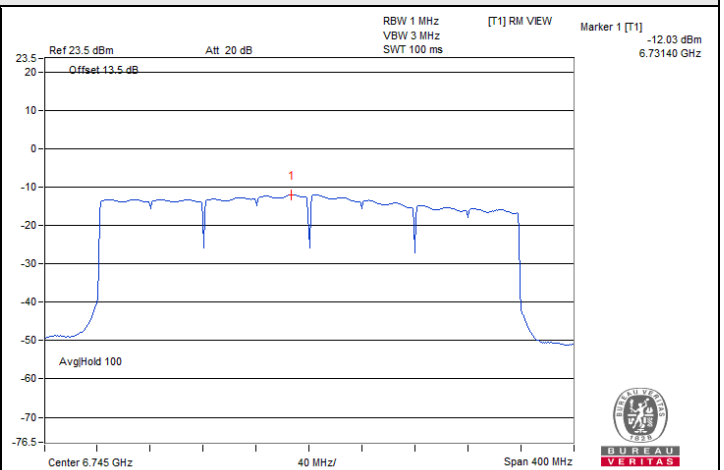

802.11be (EHT320) / Chain 1 : CH 159

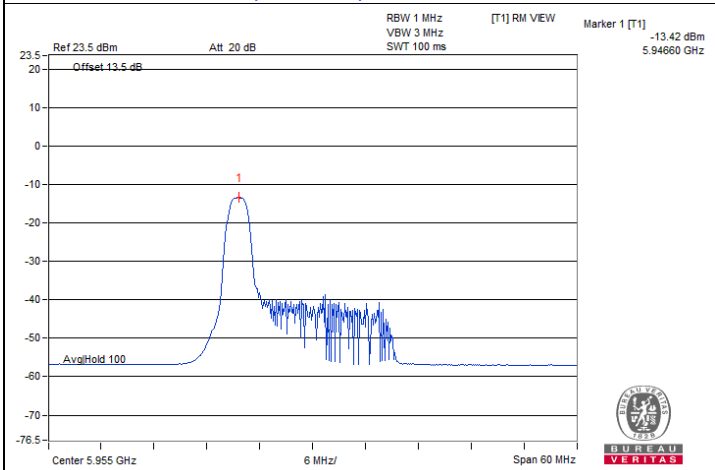

802.11be (EHT20) 26-tone RU / Chain 0 : CH 1@0

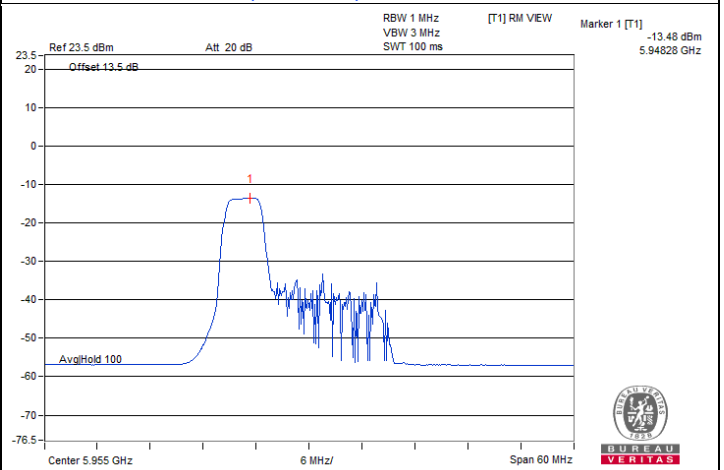

802.11be (EHT20) 52-tone RU / Chain 0 : CH 1@37

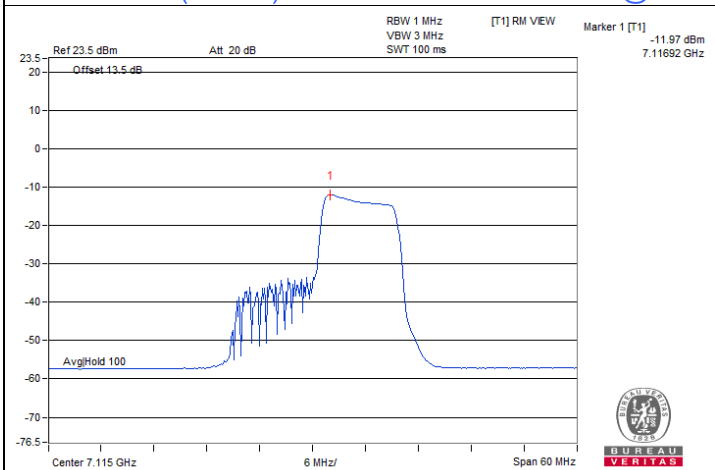

802.11be (EHT20) 106-tone RU / Chain 1 : CH 233@54

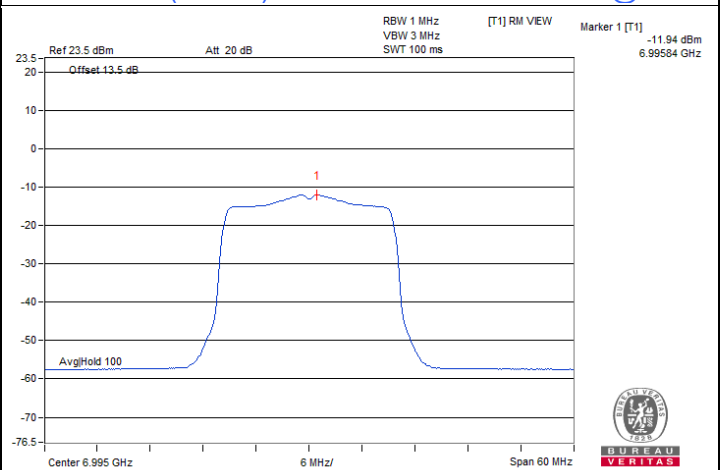

802.11be (EHT20) 242-tone RU / Chain 1 : CH 209@61

Spectrum Plot of Maximum Value

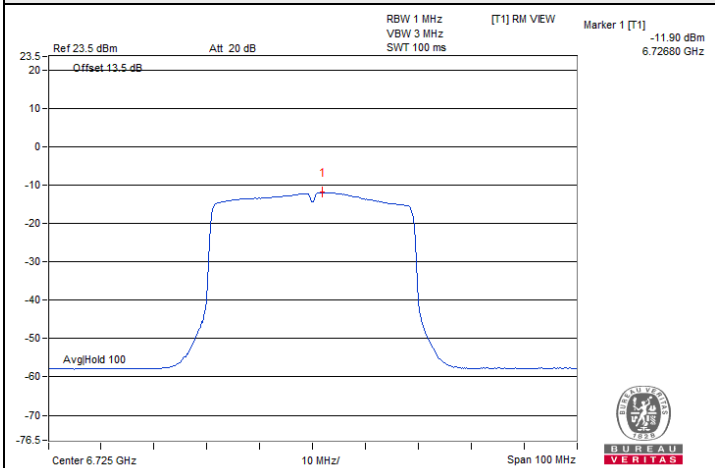

802.11be (EHT40) 484-tone RU / Chain 1 : CH 155

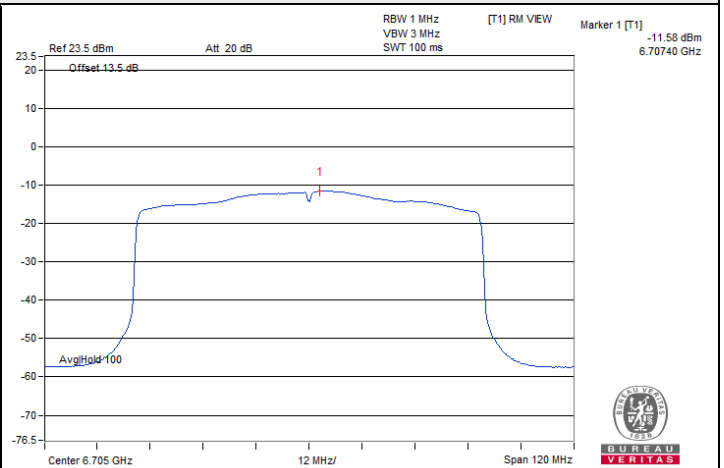

802.11be (EHT80) 996-tone RU / Chain 1 : CH 151@7

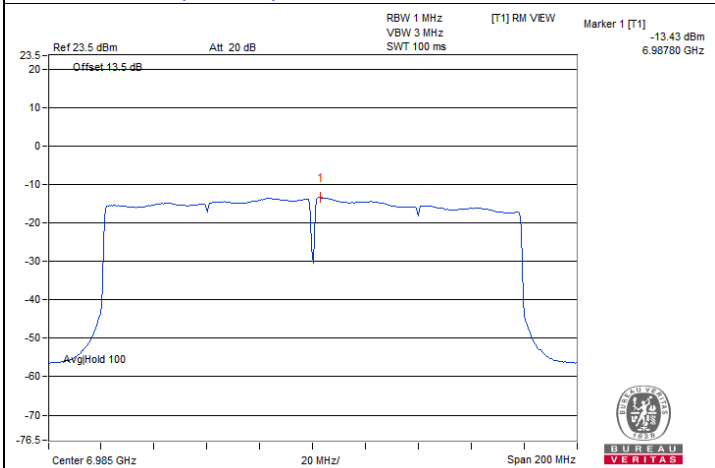

802.11be (EHT160) 2x996-tone RU / Chain 1 : CH 207@68

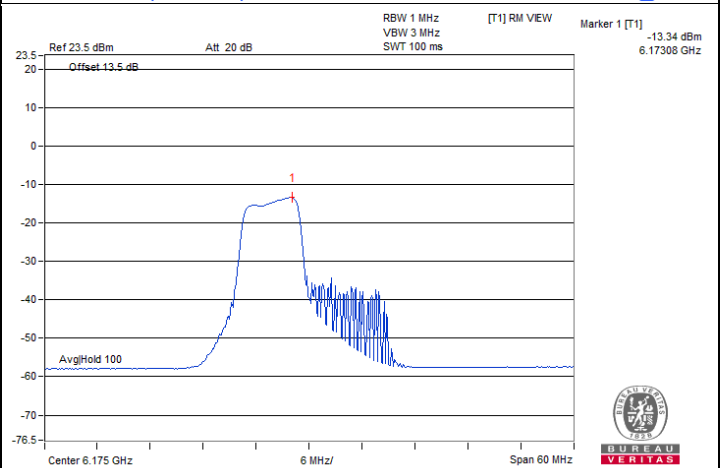

802.11be (EHT20) 52+26-tone MRU / Chain 1 : CH 45

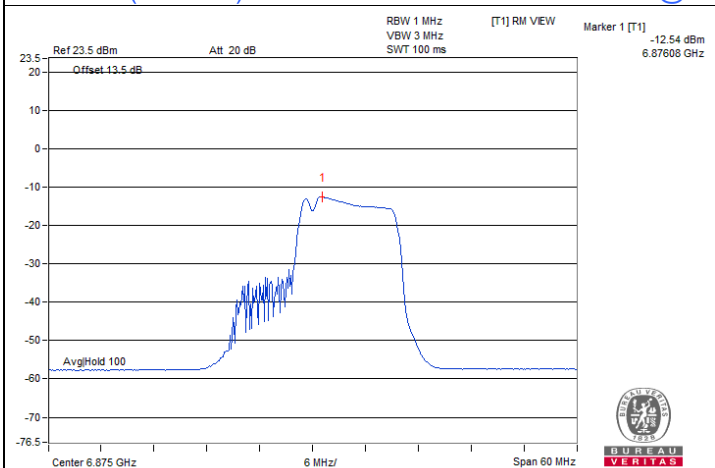

802.11be (EHT20) 106+26-tone MRU / Chain 1 : CH 185

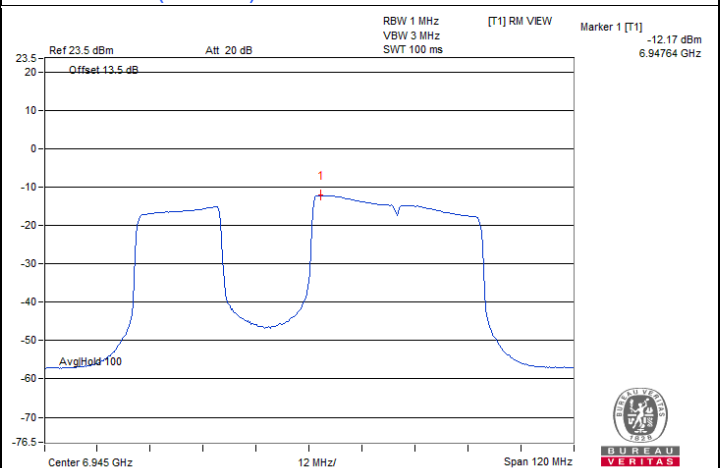

802.11be (EHT80) 484+242-tone MRU / Chain 1 : CH 199



Spectrum Plot of Maximum Value

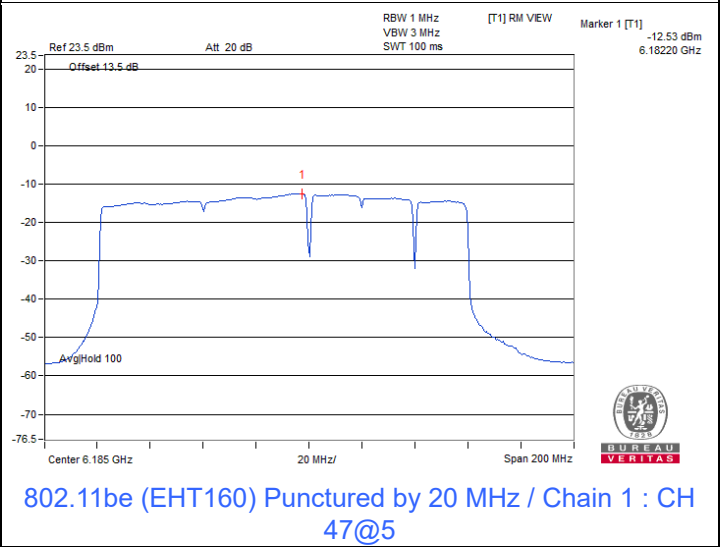
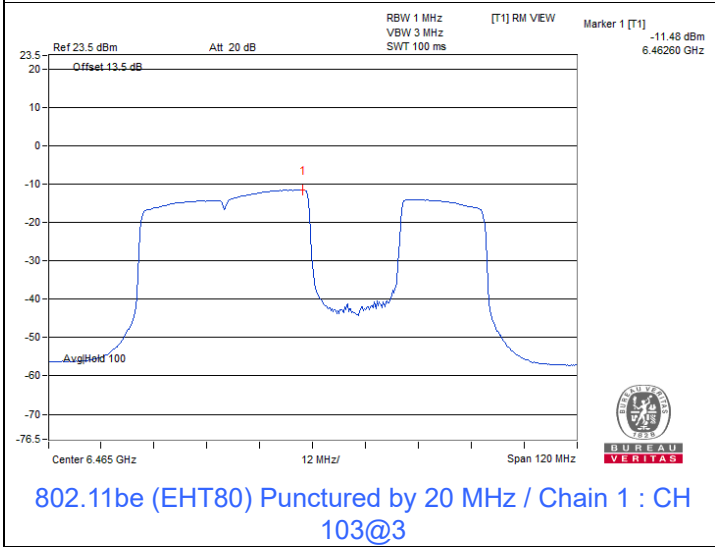
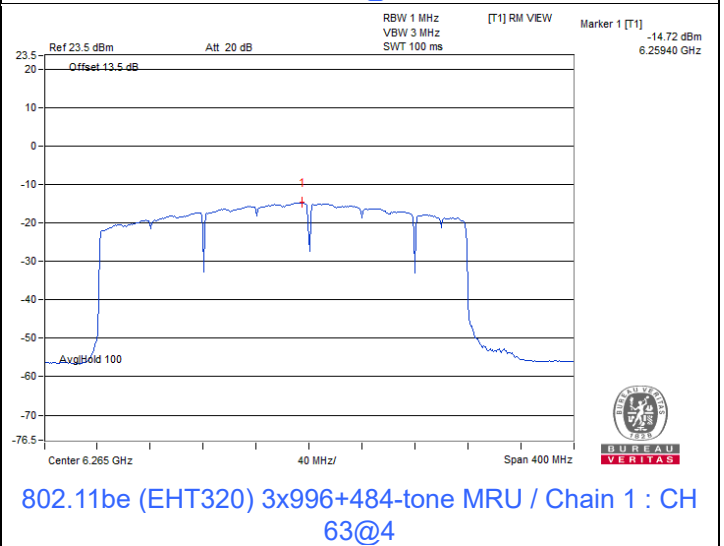
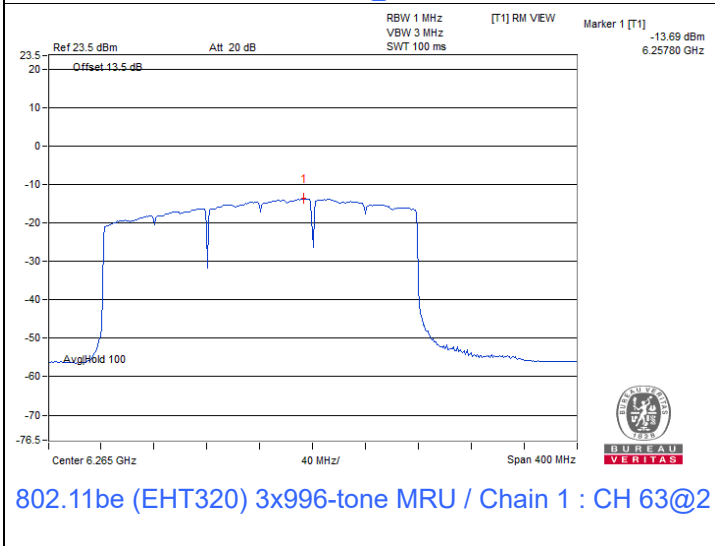
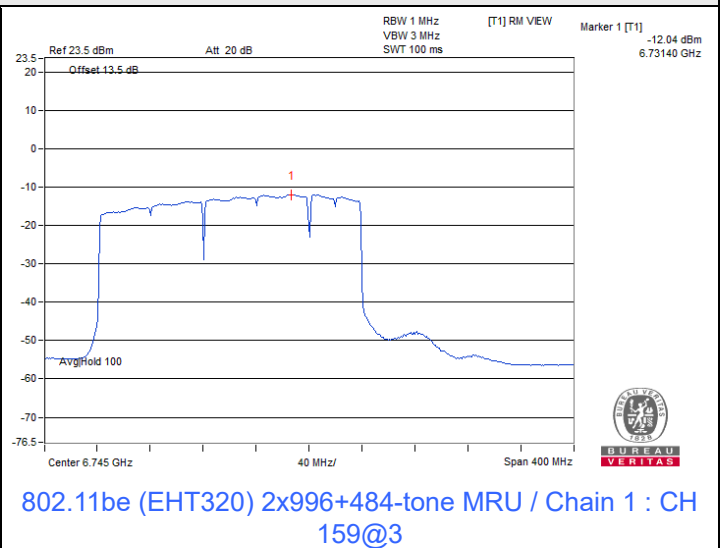
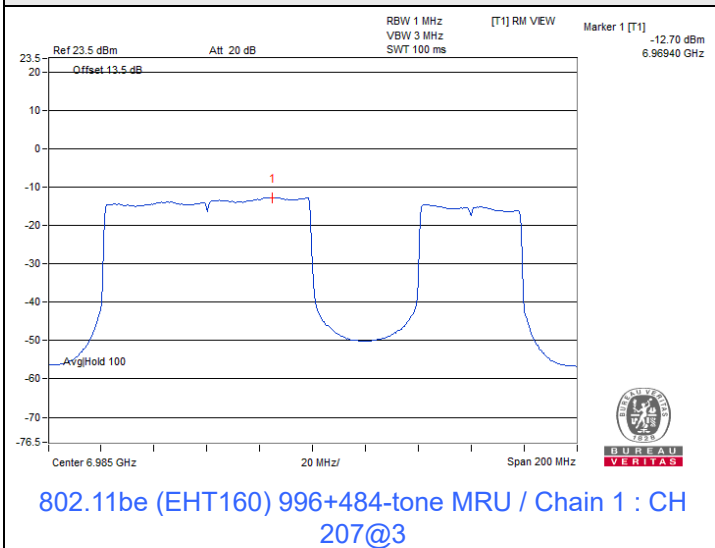

Spectrum Plot of Maximum Value

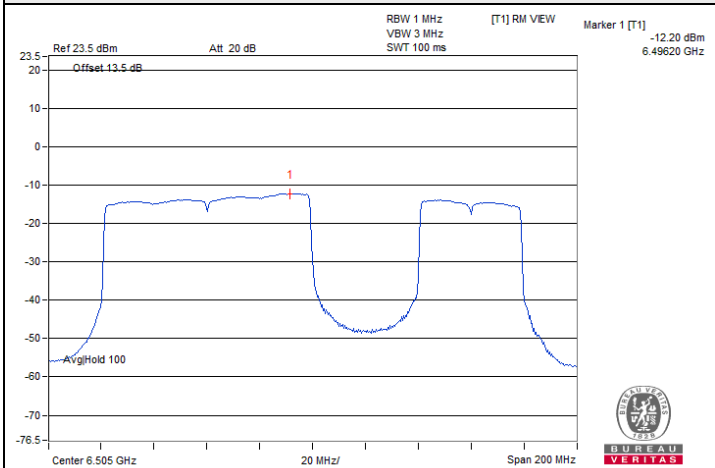

802.11be (EHT160) Punctured by 40 MHz / Chain 1 : CH 111@11

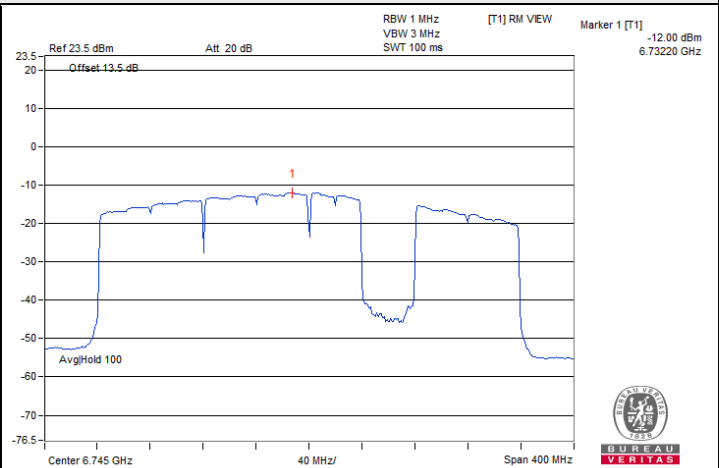

802.11be (EHT320) Punctured by 40 MHz / Chain 1 : CH 159@5

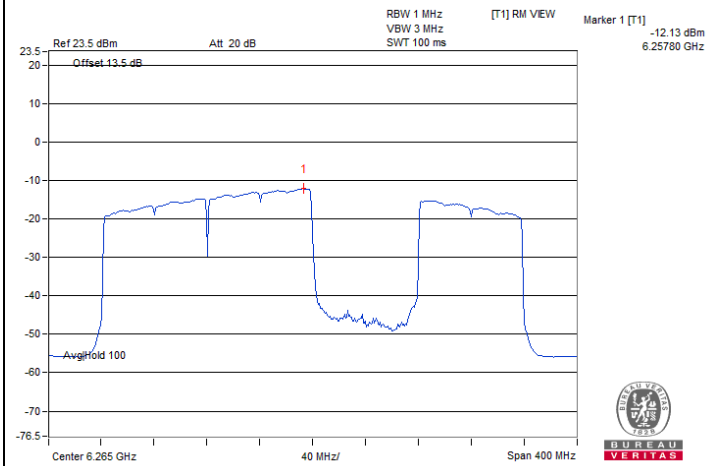

802.11be (EHT320) Punctured by 80 MHz / Chain 1 : CH 63@10

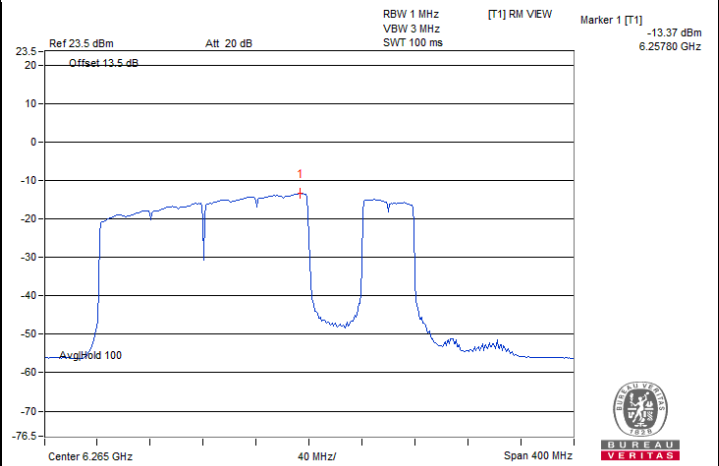

802.11be (EHT320) Punctured by 80+40 MHz / Chain 1 : CH 63@10

Mode C

Input Power:	3.3 Vdc	Environmental Conditions:	24°C, 64% RH	Tested By:	Eric Peng
--------------	---------	---------------------------	--------------	------------	-----------

802.11a

Chan.	Chan. Freq. (MHz)	PSD (dBm/MHz)		Total PSD (dBm/MHz)	Directional Gain (dBi)	EIRP PSD (dBm/MHz)	EIRP PSD Limit (dBm/MHz)	Test Result
		Chain 0	Chain 1					
2	5935	-11.92	-13.10	-9.46	8.15	-1.31	17	Pass
1	5955	3.84	3.80	6.83	8.15	14.98	17	Pass
45	6175	3.49	3.75	6.63	8.15	14.78	17	Pass
93	6415	3.15	3.06	6.12	8.15	14.27	17	Pass
117	6535	2.97	3.11	6.05	8.17	14.22	17	Pass
149	6695	2.68	3.68	6.22	8.17	14.39	17	Pass
181	6855	2.56	3.49	6.06	8.17	14.23	17	Pass

Notes:

- Method E) 2) a) of power density measurement of KDB 662911 is using for calculating total power density. Total power density is summing entire spectra across corresponding frequency bins on the various outputs by computer.
- Directional gain = gain of antenna element + 10 log (2 of TX antenna elements)
- For U-NII-5, The directional gain is 8.15 dBi
- For U-NII-7, The directional gain is 8.17 dBi

802.11be (EHT20)

Chan.	Chan. Freq. (MHz)	PSD (dBm/MHz)		Total PSD (dBm/MHz)	Directional Gain (dBi)	EIRP PSD (dBm/MHz)	EIRP PSD Limit (dBm/MHz)	Test Result
		Chain 0	Chain 1					
2	5935	-11.88	-12.68	-9.25	8.15	-1.1	17	Pass
1	5955	3.90	3.39	6.66	8.15	14.81	17	Pass
45	6175	3.79	3.58	6.70	8.15	14.85	17	Pass
93	6415	3.24	3.24	6.25	8.15	14.4	17	Pass
117	6535	2.95	3.08	6.03	8.17	14.2	17	Pass
149	6695	2.65	3.53	6.12	8.17	14.29	17	Pass
181	6855	2.76	3.44	6.12	8.17	14.29	17	Pass

Notes:

- Method E) 2) a) of power density measurement of KDB 662911 is using for calculating total power density. Total power density is summing entire spectra across corresponding frequency bins on the various outputs by computer.
- Directional gain = gain of antenna element + 10 log (2 of TX antenna elements)
- For U-NII-5, The directional gain is 8.15 dBi
- For U-NII-7, The directional gain is 8.17 dBi

802.11be (EHT40)

Chan.	Chan. Freq. (MHz)	PSD (dBm/MHz)		Total PSD (dBm/MHz)	Directional Gain (dBi)	EIRP PSD (dBm/MHz)	EIRP PSD Limit (dBm/MHz)	Test Result
		Chain 0	Chain 1					
3	5965	0.30	-0.29	3.03	8.15	11.18	17	Pass
43	6165	0.04	-0.13	2.97	8.15	11.12	17	Pass
91	6405	-0.44	-0.52	2.53	8.15	10.68	17	Pass
123	6565	-0.62	-0.47	2.47	8.17	10.64	17	Pass
155	6725	-1.09	0.00	2.50	8.17	10.67	17	Pass
179	6845	-0.86	-0.27	2.46	8.17	10.63	17	Pass

Notes:

1. Method E) 2) a) of power density measurement of KDB 662911 is using for calculating total power density. Total power density is summing entire spectra across corresponding frequency bins on the various outputs by computer.
2. Directional gain = gain of antenna element + 10 log (2 of TX antenna elements)
3. For U-NII-5, The directional gain is 8.15 dBi
4. For U-NII-7, The directional gain is 8.17 dBi

802.11be (EHT80)

Chan.	Chan. Freq. (MHz)	PSD (dBm/MHz)		Total PSD (dBm/MHz)	Directional Gain (dBi)	EIRP PSD (dBm/MHz)	EIRP PSD Limit (dBm/MHz)	Test Result
		Chain 0	Chain 1					
7	5985	-3.17	-3.59	-0.36	8.15	7.79	17	Pass
39	6145	-3.40	-3.59	-0.48	8.15	7.67	17	Pass
87	6385	-3.85	-3.78	-0.80	8.15	7.35	17	Pass
135	6625	-4.07	-3.42	-0.72	8.17	7.45	17	Pass
151	6705	-4.51	-3.18	-0.78	8.17	7.39	17	Pass
167	6785	-4.50	-3.28	-0.84	8.17	7.33	17	Pass

Notes:

1. Method E) 2) a) of power density measurement of KDB 662911 is using for calculating total power density. Total power density is summing entire spectra across corresponding frequency bins on the various outputs by computer.
2. Directional gain = gain of antenna element + 10 log (2 of TX antenna elements)
3. For U-NII-5, The directional gain is 8.15 dBi
4. For U-NII-7, The directional gain is 8.17 dBi

802.11be (EHT160)

Chan.	Chan. Freq. (MHz)	PSD (dBm/MHz)		Total PSD (dBm/MHz)	Directional Gain (dBi)	EIRP PSD (dBm/MHz)	EIRP PSD Limit (dBm/MHz)	Test Result
		Chain 0	Chain 1					
15	6025	-6.57	-6.69	-3.62	8.15	4.53	17	Pass
47	6185	-6.58	-6.57	-3.56	8.15	4.59	17	Pass
79	6345	-6.97	-7.10	-4.02	8.15	4.13	17	Pass
143	6665	-7.14	-6.24	-3.66	8.17	4.51	17	Pass

Notes:

1. Method E) 2) a) of power density measurement of KDB 662911 is using for calculating total power density. Total power density is summing entire spectra across corresponding frequency bins on the various outputs by computer.
2. Directional gain = gain of antenna element + 10 log (2 of TX antenna elements)
3. For U-NII-5, The directional gain is 8.15 dBi
4. For U-NII-7, The directional gain is 8.17 dBi

802.11be (EHT320)

Chan.	Chan. Freq. (MHz)	PSD (dBm/MHz)		Total PSD (dBm/MHz)	Directional Gain (dBi)	EIRP PSD (dBm/MHz)	EIRP PSD Limit (dBm/MHz)	Test Result
		Chain 0	Chain 1					
31	6105	-9.51	-9.53	-6.51	8.15	1.64	17	Pass
63	6265	-9.90	-9.20	-6.53	8.15	1.62	17	Pass

Notes:

1. Method E) 2) a) of power density measurement of KDB 662911 is using for calculating total power density. Total power density is summing entire spectra across corresponding frequency bins on the various outputs by computer.
2. Directional gain = gain of antenna element + 10 log (2 of TX antenna elements)
3. For U-NII-5, The directional gain is 8.15 dBi
4. For U-NII-7, The directional gain is 8.17 dBi

802.11be (EHT20) 26-tone RU

Chan.	Chan. Freq. (MHz)	PSD (dBm/MHz)		Total PSD (dBm/MHz)	Directional Gain (dBi)	EIRP PSD (dBm/MHz)	EIRP PSD Limit (dBm/MHz)	Test Result
		Chain 0	Chain 1					
2	5935	-13.66	-14.85	-11.20	8.15	-3.05	17	Pass
1	5955	3.40	3.82	6.63	8.15	14.78	17	Pass
45	6175	3.16	4.23	6.74	8.15	14.89	17	Pass
93	6415	4.05	4.75	7.42	8.15	15.57	17	Pass
117	6535	3.55	3.91	6.74	8.17	14.91	17	Pass
149	6695	3.34	4.04	6.71	8.17	14.88	17	Pass
181	6855	3.67	4.50	7.12	8.17	15.29	17	Pass

Notes:

1. Method E) 2) a) of power density measurement of KDB 662911 is using for calculating total power density. Total power density is summing entire spectra across corresponding frequency bins on the various outputs by computer.
2. Directional gain = gain of antenna element + 10 log (2 of TX antenna elements)
3. For U-NII-5, The directional gain is 8.15 dBi
4. For U-NII-7, The directional gain is 8.17 dBi

802.11be (EHT20) 52-tone RU

Chan.	Chan. Freq. (MHz)	PSD (dBm/MHz)		Total PSD (dBm/MHz)	Directional Gain (dBi)	EIRP PSD (dBm/MHz)	EIRP PSD Limit (dBm/MHz)	Test Result
		Chain 0	Chain 1					
2	5935	-13.56	-14.62	-11.05	8.15	-2.9	17	Pass
1	5955	4.37	4.39	7.39	8.15	15.54	17	Pass
45	6175	3.67	4.64	7.19	8.15	15.34	17	Pass
93	6415	3.10	3.82	6.49	8.15	14.64	17	Pass
117	6535	3.63	4.19	6.93	8.17	15.1	17	Pass
149	6695	3.50	4.35	6.96	8.17	15.13	17	Pass
181	6855	2.82	3.51	6.19	8.17	14.36	17	Pass

Notes:

1. Method E) 2) a) of power density measurement of KDB 662911 is using for calculating total power density. Total power density is summing entire spectra across corresponding frequency bins on the various outputs by computer.
2. Directional gain = gain of antenna element + 10 log (2 of TX antenna elements)
3. For U-NII-5, The directional gain is 8.15 dBi
4. For U-NII-7, The directional gain is 8.17 dBi

802.11be (EHT20) 106-tone RU

Chan.	Chan. Freq. (MHz)	PSD (dBm/MHz)		Total PSD (dBm/MHz)	Directional Gain (dBi)	EIRP PSD (dBm/MHz)	EIRP PSD Limit (dBm/MHz)	Test Result
		Chain 0	Chain 1					
2	5935	-12.03	-12.86	-9.41	8.15	-1.26	17	Pass
1	5955	5.22	5.64	8.45	8.15	16.6	17	Pass
45	6175	5.03	5.51	8.29	8.15	16.44	17	Pass
93	6415	4.71	5.06	7.90	8.15	16.05	17	Pass
117	6535	5.19	5.79	8.51	8.17	16.68	17	Pass
149	6695	5.05	6.04	8.58	8.17	16.75	17	Pass
181	6855	5.07	6.11	8.63	8.17	16.8	17	Pass

Notes:

- Method E) 2) a) of power density measurement of KDB 662911 is using for calculating total power density. Total power density is summing entire spectra across corresponding frequency bins on the various outputs by computer.
- Directional gain = gain of antenna element + 10 log (2 of TX antenna elements)
- For U-NII-5, The directional gain is 8.15 dBi
- For U-NII-7, The directional gain is 8.17 dBi

802.11be (EHT20) 242-tone RU

Chan.	Chan. Freq. (MHz)	PSD (dBm/MHz)		Total PSD (dBm/MHz)	Directional Gain (dBi)	EIRP PSD (dBm/MHz)	EIRP PSD Limit (dBm/MHz)	Test Result
		Chain 0	Chain 1					
1	5955	3.89	4.17	7.04	8.15	15.19	17	Pass
117	6535	2.93	3.43	6.20	8.17	14.37	17	Pass

Notes:

- Method E) 2) a) of power density measurement of KDB 662911 is using for calculating total power density. Total power density is summing entire spectra across corresponding frequency bins on the various outputs by computer.
- Directional gain = gain of antenna element + 10 log (2 of TX antenna elements)
- For U-NII-5, The directional gain is 8.15 dBi
- For U-NII-7, The directional gain is 8.17 dBi

802.11be (EHT40) 484-tone RU

Chan.	Chan. Freq. (MHz)	PSD (dBm/MHz)		Total PSD (dBm/MHz)	Directional Gain (dBi)	EIRP PSD (dBm/MHz)	EIRP PSD Limit (dBm/MHz)	Test Result
		Chain 0	Chain 1					
3	5965	0.29	0.45	3.38	8.15	11.53	17	Pass
123	6565	-0.70	-0.29	2.52	8.17	10.69	17	Pass

Notes:

1. Method E) 2) a) of power density measurement of KDB 662911 is using for calculating total power density. Total power density is summing entire spectra across corresponding frequency bins on the various outputs by computer.
2. Directional gain = gain of antenna element + 10 log (2 of TX antenna elements)
3. For U-NII-5, The directional gain is 8.15 dBi
4. For U-NII-7, The directional gain is 8.17 dBi

802.11be (EHT80) 996-tone RU

Chan.	Chan. Freq. (MHz)	PSD (dBm/MHz)		Total PSD (dBm/MHz)	Directional Gain (dBi)	EIRP PSD (dBm/MHz)	EIRP PSD Limit (dBm/MHz)	Test Result
		Chain 0	Chain 1					
7	5985	-3.18	-2.69	0.08	8.15	8.23	17	Pass
135	6625	-3.79	-2.85	-0.28	8.17	7.89	17	Pass

Notes:

1. Method E) 2) a) of power density measurement of KDB 662911 is using for calculating total power density. Total power density is summing entire spectra across corresponding frequency bins on the various outputs by computer.
2. Directional gain = gain of antenna element + 10 log (2 of TX antenna elements)
3. For U-NII-5, The directional gain is 8.15 dBi
4. For U-NII-7, The directional gain is 8.17 dBi

802.11be (EHT160) 2x996-tone RU

Chan.	Chan. Freq. (MHz)	PSD (dBm/MHz)		Total PSD (dBm/MHz)	Directional Gain (dBi)	EIRP PSD (dBm/MHz)	EIRP PSD Limit (dBm/MHz)	Test Result
		Chain 0	Chain 1					
15	6025	-6.82	-6.23	-3.50	8.15	4.65	17	Pass
143	6665	-7.26	-6.27	-3.73	8.17	4.44	17	Pass

Notes:

1. Method E) 2) a) of power density measurement of KDB 662911 is using for calculating total power density. Total power density is summing entire spectra across corresponding frequency bins on the various outputs by computer.
2. Directional gain = gain of antenna element + 10 log (2 of TX antenna elements)
3. For U-NII-5, The directional gain is 8.15 dBi
4. For U-NII-7, The directional gain is 8.17 dBi

802.11be (EHT20) 52+26-tone MRU

Chan.	Chan. Freq. (MHz)	PSD (dBm/MHz)		Total PSD (dBm/MHz)	Directional Gain (dBi)	EIRP PSD (dBm/MHz)	EIRP PSD Limit (dBm/MHz)	Test Result
		Chain 0	Chain 1					
1	5955	4.64	4.93	7.80	8.15	15.95	17	Pass
117	6535	3.67	4.09	6.90	8.17	15.07	17	Pass

Notes:

- Method E) 2) a) of power density measurement of KDB 662911 is using for calculating total power density. Total power density is summing entire spectra across corresponding frequency bins on the various outputs by computer.
- Directional gain = gain of antenna element + 10 log (2 of TX antenna elements)
- For U-NII-5, The directional gain is 8.15 dBi
- For U-NII-7, The directional gain is 8.17 dBi

802.11be (EHT20) 106+26-tone MRU

Chan.	Chan. Freq. (MHz)	PSD (dBm/MHz)		Total PSD (dBm/MHz)	Directional Gain (dBi)	EIRP PSD (dBm/MHz)	EIRP PSD Limit (dBm/MHz)	Test Result
		Chain 0	Chain 1					
1	5955	5.16	5.48	8.33	8.15	16.48	17	Pass
117	6535	5.09	5.60	8.36	8.17	16.53	17	Pass

Notes:

- Method E) 2) a) of power density measurement of KDB 662911 is using for calculating total power density. Total power density is summing entire spectra across corresponding frequency bins on the various outputs by computer.
- Directional gain = gain of antenna element + 10 log (2 of TX antenna elements)
- For U-NII-5, The directional gain is 8.15 dBi
- For U-NII-7, The directional gain is 8.17 dBi

802.11be (EHT80) 484+242-tone MRU

Chan.	Chan. Freq. (MHz)	PSD (dBm/MHz)		Total PSD (dBm/MHz)	Directional Gain (dBi)	EIRP PSD (dBm/MHz)	EIRP PSD Limit (dBm/MHz)	Test Result
		Chain 0	Chain 1					
7	5985	0.59	0.71	3.66	8.15	11.81	17	Pass
135	6625	-0.14	0.56	3.23	8.17	11.4	17	Pass

Notes:

- Method E) 2) a) of power density measurement of KDB 662911 is using for calculating total power density. Total power density is summing entire spectra across corresponding frequency bins on the various outputs by computer.
- Directional gain = gain of antenna element + 10 log (2 of TX antenna elements)
- For U-NII-5, The directional gain is 8.15 dBi
- For U-NII-7, The directional gain is 8.17 dBi

802.11be (EHT160) 996+484-tone MRU

Chan.	Chan. Freq. (MHz)	PSD (dBm/MHz)		Total PSD (dBm/MHz)	Directional Gain (dBi)	EIRP PSD (dBm/MHz)	EIRP PSD Limit (dBm/MHz)	Test Result
		Chain 0	Chain 1					
15	6025	-3.94	-3.47	-0.69	8.15	7.46	17	Pass
143	6665	-4.55	-3.59	-1.03	8.17	7.14	17	Pass

Notes:

- Method E) 2) a) of power density measurement of KDB 662911 is using for calculating total power density. Total power density is summing entire spectra across corresponding frequency bins on the various outputs by computer.
- Directional gain = gain of antenna element + 10 log (2 of TX antenna elements)
- For U-NII-5, The directional gain is 8.15 dBi
- For U-NII-7, The directional gain is 8.17 dBi

802.11be (EHT320) 2x996+484-tone MRU

Chan.	Chan. Freq. (MHz)	PSD w/o Duty Factor (dBm/MHz)		Duty Factor (dB)	Total PSD (dBm/MHz)	Directional Gain (dBi)	EIRP PSD (dBm/MHz)	EIRP PSD Limit (dBm/MHz)	Test Result
		Chain 0	Chain 1						
31	6105	-5.10	-4.88	0.18	-1.80	8.15	6.35	17	Pass

Notes:

- Method E) 2) a) of power density measurement of KDB 662911 is using for calculating total power density. Total power density is summing entire spectra across corresponding frequency bins on the various outputs by computer.
- Directional gain = gain of antenna element + 10 log (2 of TX antenna elements)
- For U-NII-5, The directional gain is 8.15 dBi
- For U-NII-7, The directional gain is 8.17 dBi

802.11be (EHT320) 3x996-tone MRU

Chan.	Chan. Freq. (MHz)	PSD w/o Duty Factor (dBm/MHz)		Duty Factor (dB)	Total PSD (dBm/MHz)	Directional Gain (dBi)	EIRP PSD (dBm/MHz)	EIRP PSD Limit (dBm/MHz)	Test Result
		Chain 0	Chain 1						
31	6105	-7.12	-6.61	0.18	-3.67	8.15	4.48	17	Pass

Notes:

- Method E) 2) a) of power density measurement of KDB 662911 is using for calculating total power density. Total power density is summing entire spectra across corresponding frequency bins on the various outputs by computer.
- Directional gain = gain of antenna element + 10 log (2 of TX antenna elements)
- For U-NII-5, The directional gain is 8.15 dBi
- For U-NII-7, The directional gain is 8.17 dBi

802.11be (EHT320) 3x996+484-tone MRU

Chan.	Chan. Freq. (MHz)	PSD w/o Duty Factor (dBm/MHz)		Duty Factor (dB)	Total PSD (dBm/MHz)	Directional Gain (dBi)	EIRP PSD (dBm/MHz)	EIRP PSD Limit (dBm/MHz)	Test Result
		Chain 0	Chain 1						
31	6105	-8.33	-7.61	0.18	-4.76	8.15	3.39	17	Pass

Notes:

1. Method E) 2) a) of power density measurement of KDB 662911 is using for calculating total power density. Total power density is summing entire spectra across corresponding frequency bins on the various outputs by computer.
2. Directional gain = gain of antenna element + 10 log (2 of TX antenna elements)
3. For U-NII-5, The directional gain is 8.15 dBi
4. For U-NII-7, The directional gain is 8.17 dBi

802.11be (EHT80) Punctured by 20 MHz

Chan.	Chan. Freq. (MHz)	PSD (dBm/MHz)		Total PSD (dBm/MHz)	Directional Gain (dBi)	EIRP PSD (dBm/MHz)	EIRP PSD Limit (dBm/MHz)	Test Result
		Chain 0	Chain 1					
7	5985	-1.05	-0.63	2.18	8.15	10.33	17	Pass
135	6625	-1.76	-1.08	1.60	8.17	9.77	17	Pass

Notes:

1. Method E) 2) a) of power density measurement of KDB 662911 is using for calculating total power density. Total power density is summing entire spectra across corresponding frequency bins on the various outputs by computer.
2. Directional gain = gain of antenna element + 10 log (2 of TX antenna elements)
3. For U-NII-5, The directional gain is 8.15 dBi
4. For U-NII-7, The directional gain is 8.17 dBi

802.11be (EHT160) Punctured by 20 MHz

Chan.	Chan. Freq. (MHz)	PSD (dBm/MHz)		Total PSD (dBm/MHz)	Directional Gain (dBi)	EIRP PSD (dBm/MHz)	EIRP PSD Limit (dBm/MHz)	Test Result
		Chain 0	Chain 1					
15	6025	-6.17	-5.57	-2.85	8.15	5.3	17	Pass
143	6665	-6.46	-5.77	-3.09	8.17	5.08	17	Pass

Notes:

1. Method E) 2) a) of power density measurement of KDB 662911 is using for calculating total power density. Total power density is summing entire spectra across corresponding frequency bins on the various outputs by computer.
2. Directional gain = gain of antenna element + 10 log (2 of TX antenna elements)
3. For U-NII-5, The directional gain is 8.15 dBi
4. For U-NII-7, The directional gain is 8.17 dBi

802.11be (EHT160) Punctured by 40 MHz

Chan.	Chan. Freq. (MHz)	PSD (dBm/MHz)		Total PSD (dBm/MHz)	Directional Gain (dBi)	EIRP PSD (dBm/MHz)	EIRP PSD Limit (dBm/MHz)	Test Result
		Chain 0	Chain 1					
15	6025	-5.12	-4.51	-1.79	8.15	6.36	17	Pass
143	6665	-5.40	-4.71	-2.03	8.17	6.14	17	Pass

Notes:

- Method E) 2) a) of power density measurement of KDB 662911 is using for calculating total power density. Total power density is summing entire spectra across corresponding frequency bins on the various outputs by computer.
- Directional gain = gain of antenna element + 10 log (2 of TX antenna elements)
- For U-NII-5, The directional gain is 8.15 dBi
- For U-NII-7, The directional gain is 8.17 dBi

802.11be (EHT320) Punctured by 40 MHz

Chan.	Chan. Freq. (MHz)	PSD (dBm/MHz)		Total PSD (dBm/MHz)	Directional Gain (dBi)	EIRP PSD (dBm/MHz)	EIRP PSD Limit (dBm/MHz)	Test Result
		Chain 0	Chain 1					
31	6105	-9.17	-8.72	-5.93	8.15	2.22	17	Pass

Notes:

- Method E) 2) a) of power density measurement of KDB 662911 is using for calculating total power density. Total power density is summing entire spectra across corresponding frequency bins on the various outputs by computer.
- Directional gain = gain of antenna element + 10 log (2 of TX antenna elements)
- For U-NII-5, The directional gain is 8.15 dBi
- For U-NII-7, The directional gain is 8.17 dBi

802.11be (EHT320) Punctured by 80 MHz

Chan.	Chan. Freq. (MHz)	PSD (dBm/MHz)		Total PSD (dBm/MHz)	Directional Gain (dBi)	EIRP PSD (dBm/MHz)	EIRP PSD Limit (dBm/MHz)	Test Result
		Chain 0	Chain 1					
31	6105	-8.13	-7.73	-4.92	8.15	3.23	17	Pass

Notes:

- Method E) 2) a) of power density measurement of KDB 662911 is using for calculating total power density. Total power density is summing entire spectra across corresponding frequency bins on the various outputs by computer.
- Directional gain = gain of antenna element + 10 log (2 of TX antenna elements)
- For U-NII-5, The directional gain is 8.15 dBi
- For U-NII-7, The directional gain is 8.17 dBi



802.11be (EHT320) Punctured by 80+40 MHz

Chan.	Chan. Freq. (MHz)	PSD (dBm/MHz)		Total PSD (dBm/MHz)	Directional Gain (dBi)	EIRP PSD (dBm/MHz)	EIRP PSD Limit (dBm/MHz)	Test Result
		Chain 0	Chain 1					
31	6105	-7.81	-7.15	-4.46	8.15	3.69	17	Pass

Notes:

1. Method E) 2) a) of power density measurement of KDB 662911 is using for calculating total power density. Total power density is summing entire spectra across corresponding frequency bins on the various outputs by computer.
2. Directional gain = gain of antenna element + 10 log (2 of TX antenna elements)
3. For U-NII-5, The directional gain is 8.15 dBi
4. For U-NII-7, The directional gain is 8.17 dBi

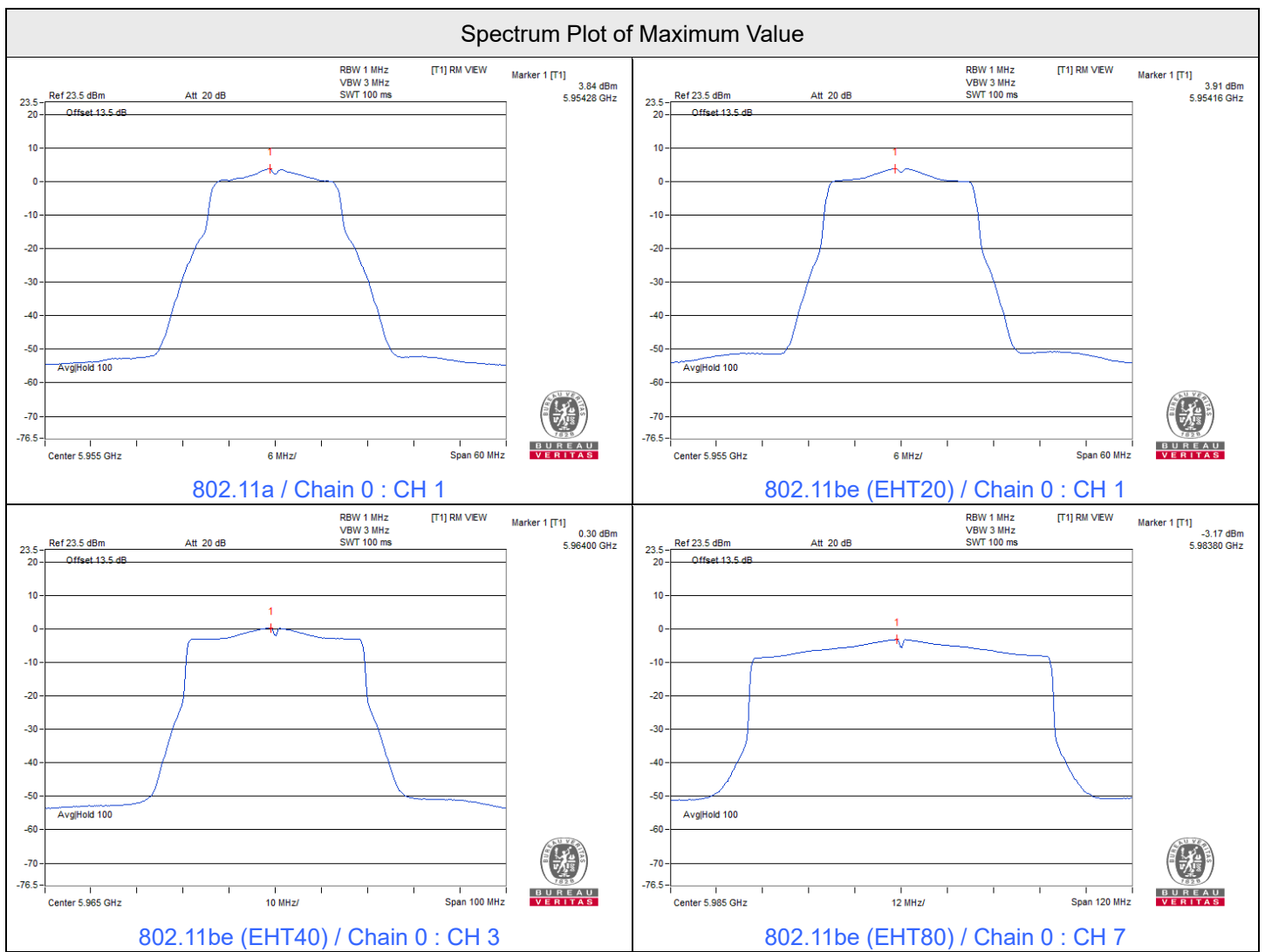



Spectrum Plot of Maximum Value

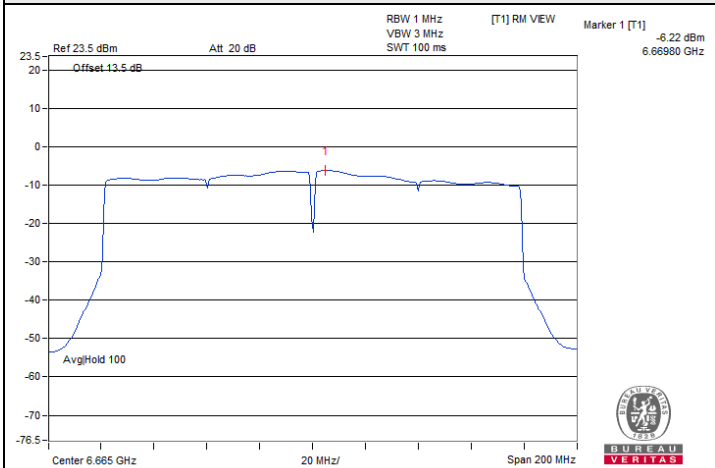

802.11be (EHT160) / Chain 1 : CH 143

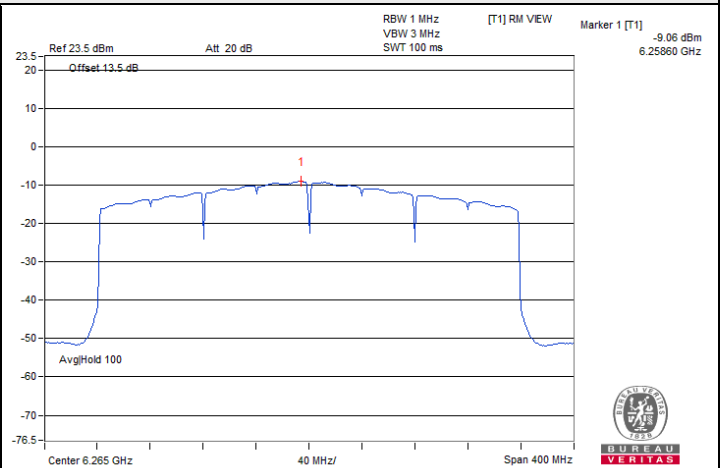

802.11be (EHT320) / Chain 1 : CH 63

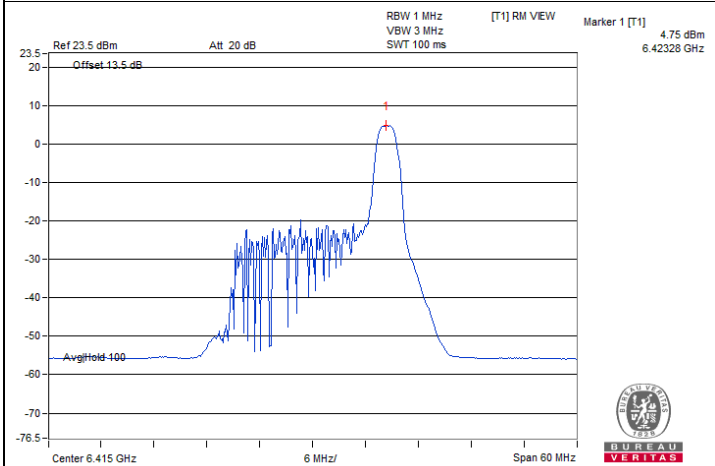

802.11be (EHT20) 26-tone RU / Chain 1 : CH 93@8

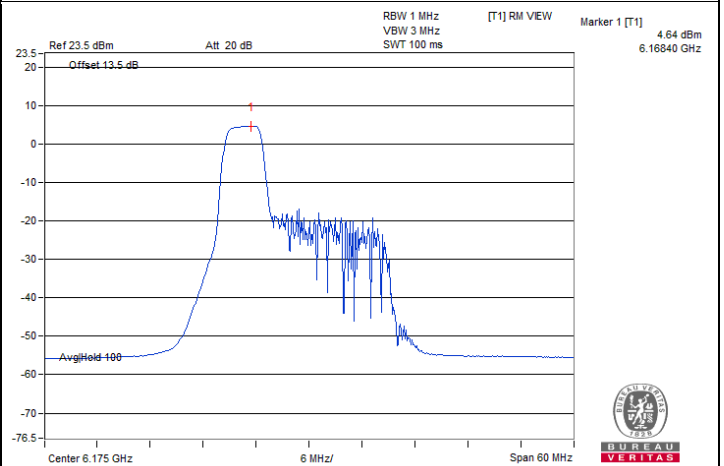

802.11be (EHT20) 52-tone RU / Chain 1 : CH 45@37

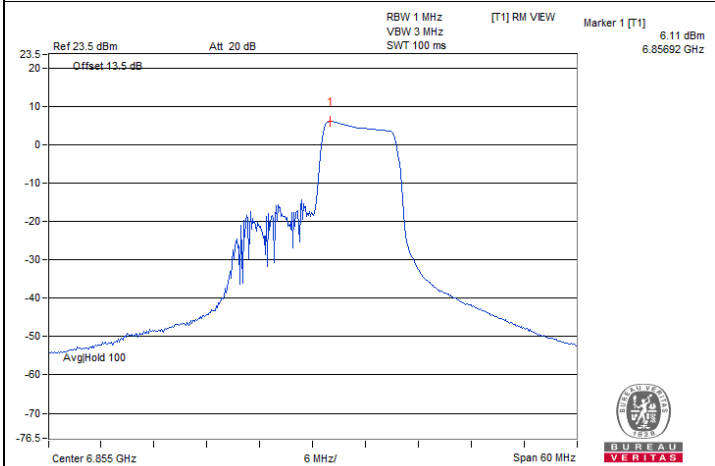

802.11be (EHT20) 106-tone RU / Chain 1 : CH 181@54

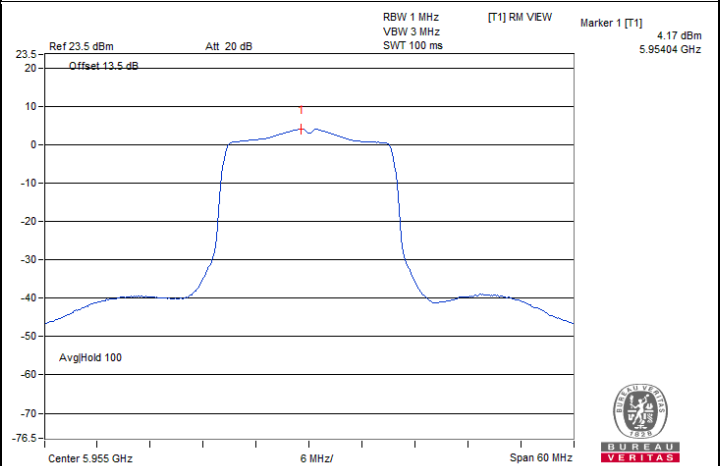

802.11be (EHT20) 242-tone RU / Chain 1 : CH 1@61



Spectrum Plot of Maximum Value

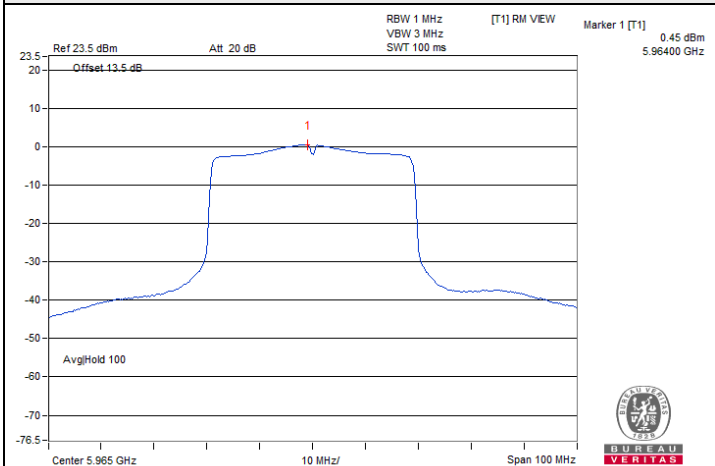

802.11be (EHT40) 484-tone RU / Chain 1 : CH 3@65

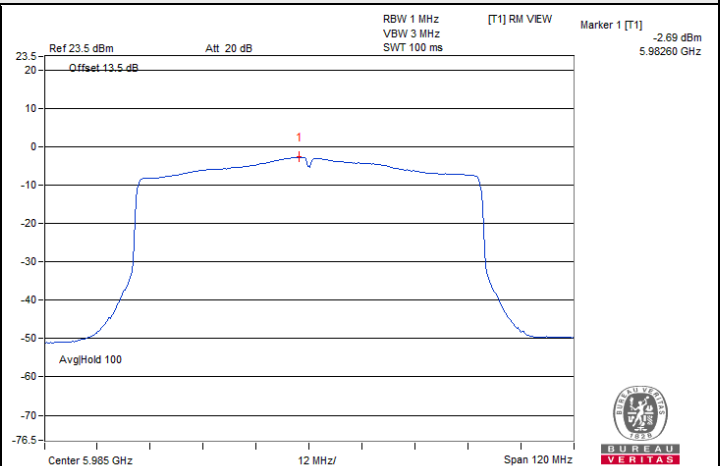

802.11be (EHT80) 996-tone RU / Chain 1 : CH 7@67

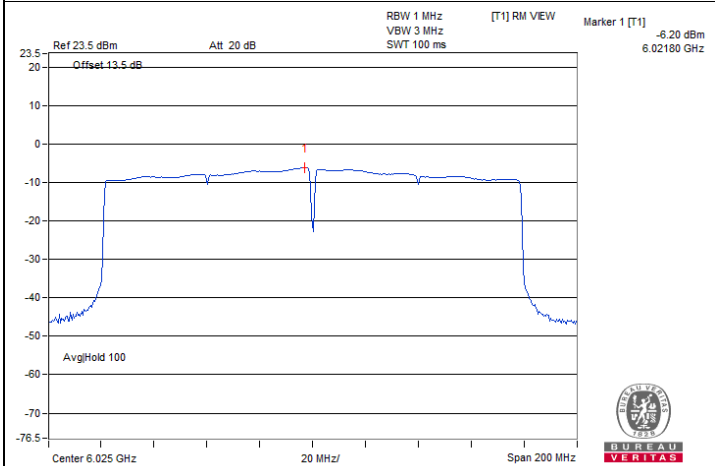

802.11be (EHT160) 2x996-tone RU / Chain 1 : CH 15

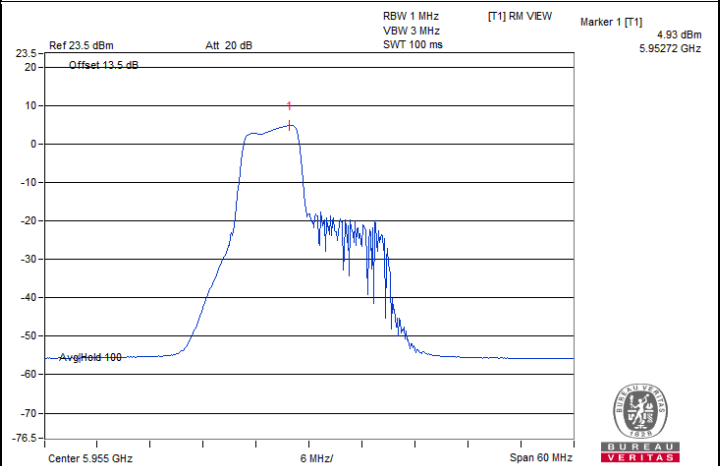

802.11be (EHT20) 52+26-tone MRU / Chain 1 : CH 1@1

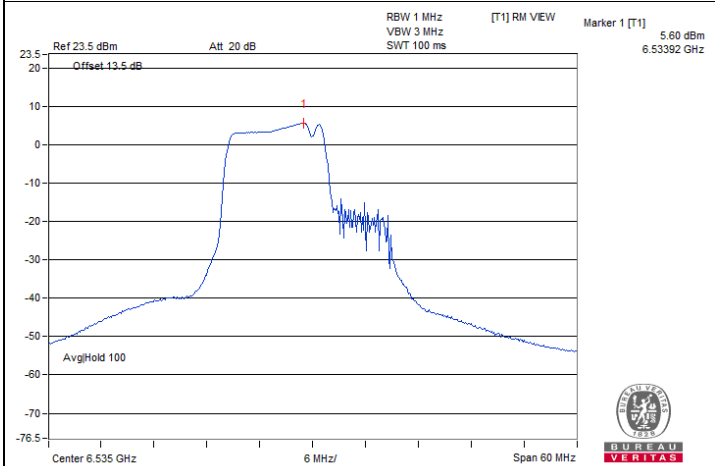

802.11be (EHT20) 106+26-tone MRU / Chain 1 : CH 117@1

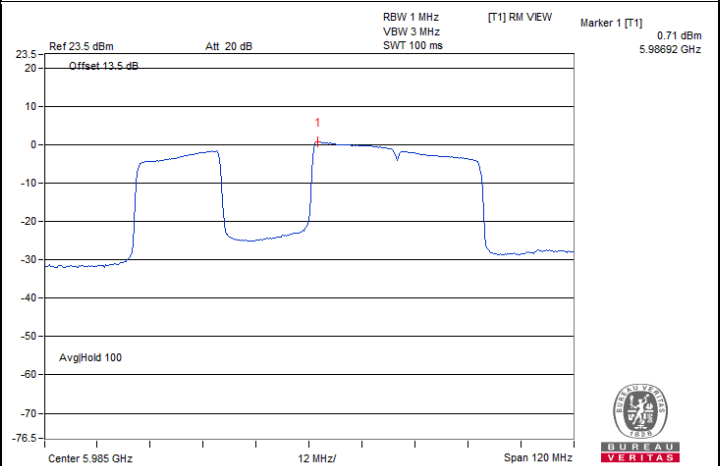

802.11be (EHT80) 484+242-tone MRU / Chain 1 : CH 7@3



Spectrum Plot of Maximum Value

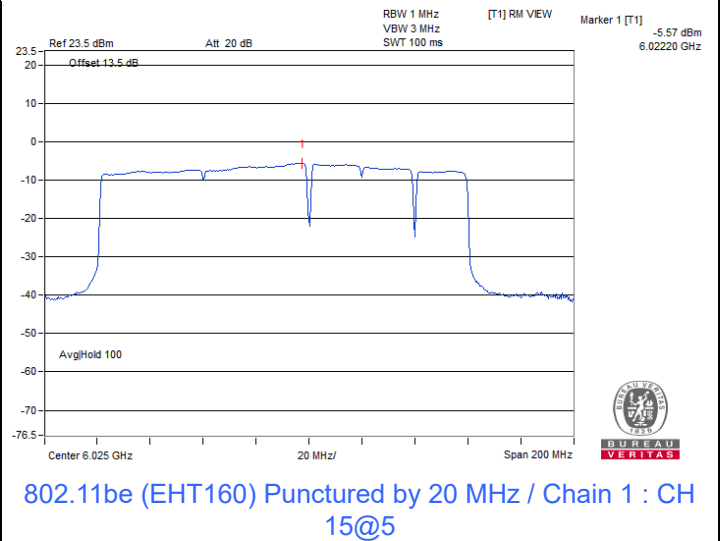
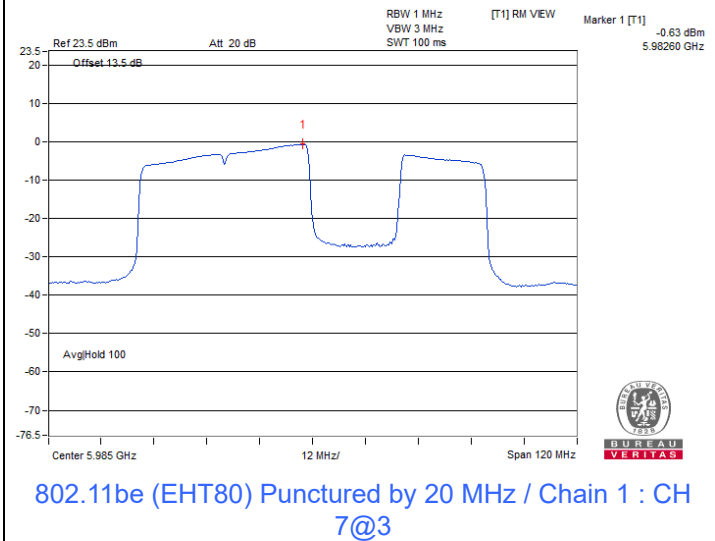
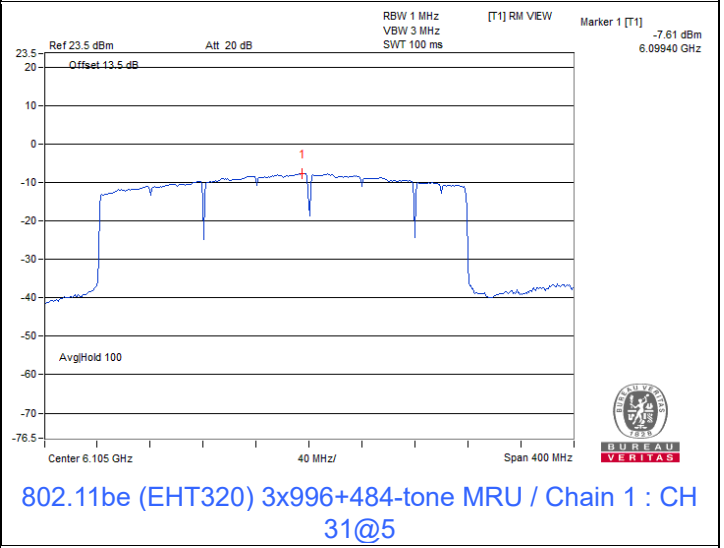
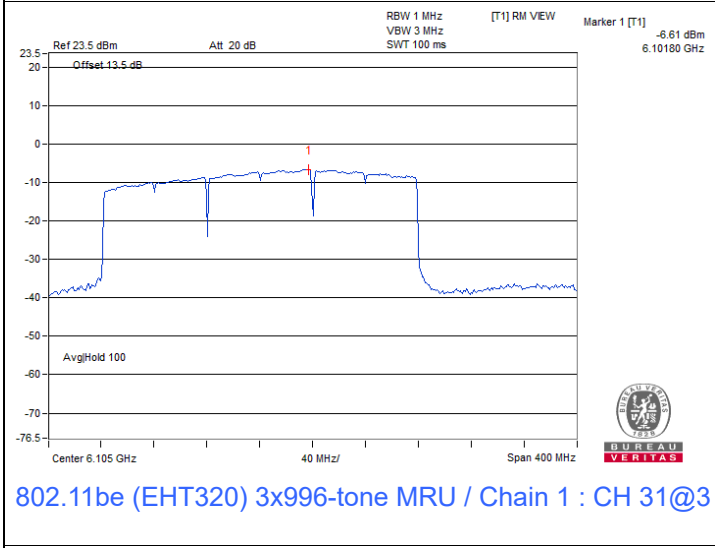
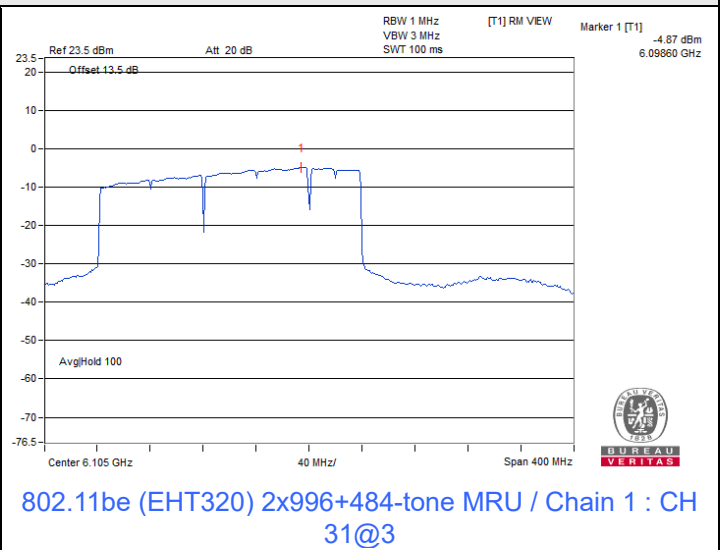
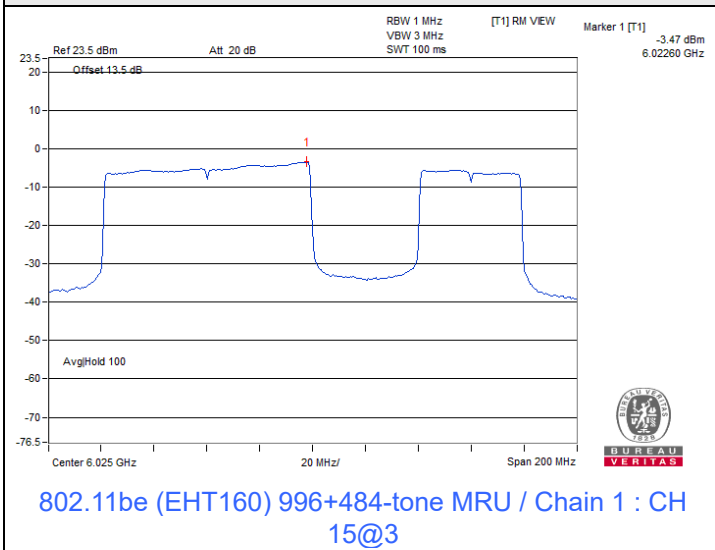



Spectrum Plot of Maximum Value

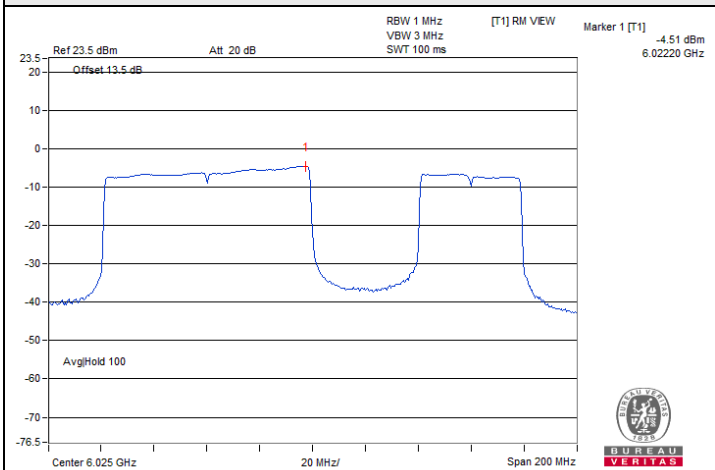

802.11be (EHT160) Punctured by 40 MHz / Chain 1 : CH 15@11

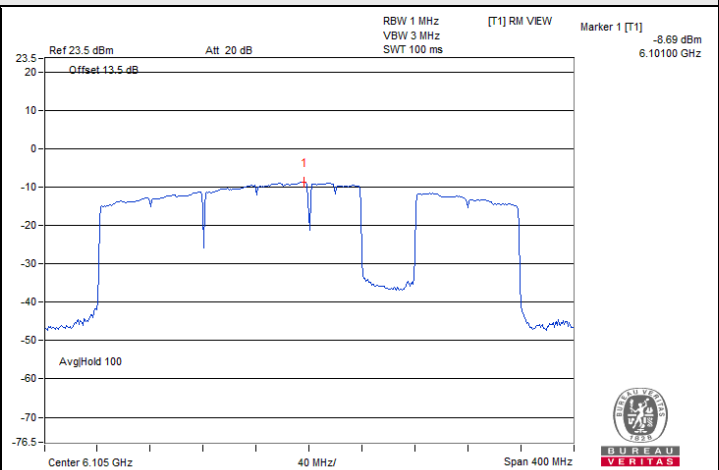

802.11be (EHT320) Punctured by 40 MHz / Chain 1 : CH 31@5

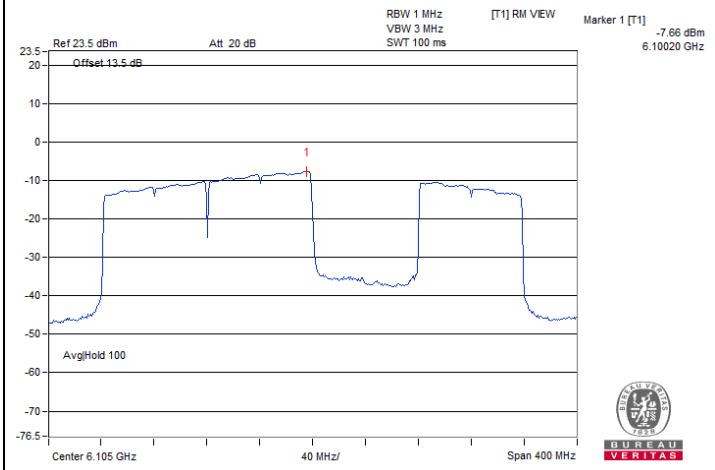

802.11be (EHT320) Punctured by 80 MHz / Chain 1 : CH 31@11

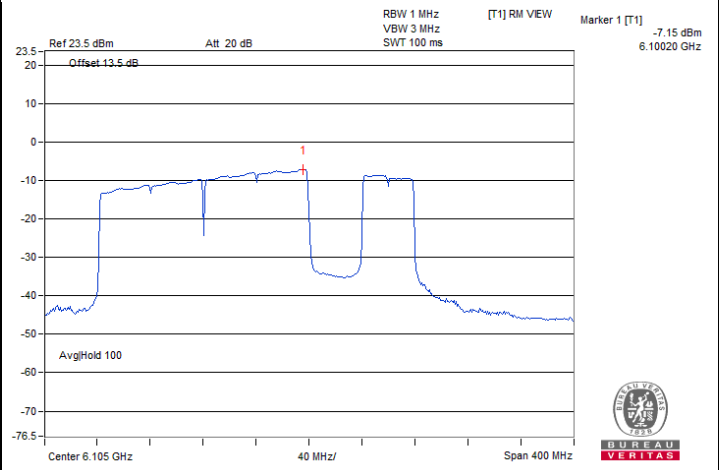

802.11be (EHT320) Punctured by 80+40 MHz / Chain 1 : CH 31@23

7.3 Emission Bandwidth

Mode A

Input Power:	3.3 Vdc	Environmental Conditions:	24°C, 65% RH	Tested By:	Eric Peng
--------------	---------	---------------------------	--------------	------------	-----------

802.11a

Channel	Frequency (MHz)	26dB Bandwidth (MHz)	
		Chain 0	Chain 1
2	5935	22.11	21.97
1	5955	22.29	22.39
45	6175	22.16	22.46
93	6415	22.32	22.47
97	6435	22.24	22.05
105	6475	22.45	22.12
113	6515	22.30	22.52
117	6535	22.37	22.42
149	6695	22.39	22.21
181	6855	22.50	22.16
185	6875	22.25	22.48
209	6995	22.91	22.11
233	7115	22.26	22.35

802.11be (EHT20)

Channel	Frequency (MHz)	26dB Bandwidth (MHz)	
		Chain 0	Chain 1
2	5935	23.51	22.83
1	5955	21.89	22.12
45	6175	22.31	22.11
93	6415	22.72	22.98
97	6435	22.81	23.32
105	6475	22.45	22.75
113	6515	22.52	22.64
117	6535	22.71	22.21
149	6695	22.40	22.60
181	6855	22.27	22.29
185	6875	22.30	22.32
209	6995	22.10	22.14
233	7115	22.34	23.19

802.11be (EHT40)

Channel	Frequency (MHz)	26dB Bandwidth (MHz)	
		Chain 0	Chain 1
3	5965	45.60	45.04
43	6165	44.94	44.02
91	6405	45.63	45.79
99	6445	46.45	45.25
107	6485	45.92	46.01
115	6525	45.59	45.94
123	6565	44.24	45.23
155	6725	44.96	43.93
179	6845	44.59	44.80
187	6885	44.27	44.36
211	7005	43.85	46.26
227	7085	45.45	46.08

802.11be (EHT80)

Channel	Frequency (MHz)	26dB Bandwidth (MHz)	
		Chain 0	Chain 1
7	5985	88.21	83.61
39	6145	86.62	84.05
87	6385	88.28	83.85
103	6465	87.86	84.21
119	6545	82.47	83.07
151	6705	88.94	84.19
183	6865	84.14	83.84
199	6945	84.30	84.10
215	7025	84.21	83.47

802.11be (EHT160)

Channel	Frequency (MHz)	26dB Bandwidth (MHz)	
		Chain 0	Chain 1
15	6025	175.57	175.32
47	6185	174.66	173.46
79	6345	176.57	172.26
111	6505	176.53	173.32
143	6665	177.28	171.60
175	6825	176.19	171.14
207	6985	171.35	172.83

802.11be (EHT320)

Channel	Frequency (MHz)	26dB Bandwidth (MHz)	
		Chain 0	Chain 1
31	6105	332.82	331.78
63	6265	329.60	330.89
95	6425	331.97	331.50
127	6585	330.94	331.78
159	6745	333.01	331.03
191	6905	331.88	330.33

802.11be (EHT20) 26-tone RU

Channel	Frequency (MHz)	26dB Bandwidth (MHz)	
		Chain 0	Chain 1
2	5935	20.37	20.33
1	5955	20.30	20.33
45	6175	20.39	20.38
93	6415	20.44	20.16
97	6435	20.32	20.34
105	6475	20.19	20.32
113	6515	20.36	20.08
117	6535	20.41	20.34
149	6695	20.37	20.35
181	6855	20.45	20.27
185	6875	20.54	20.27
209	6995	20.34	20.24
233	7115	20.32	20.15

802.11be (EHT20) 52-tone RU

Channel	Frequency (MHz)	26dB Bandwidth (MHz)	
		Chain 0	Chain 1
2	5935	20.41	21.02
1	5955	20.36	20.72
45	6175	20.23	20.52
93	6415	20.75	20.26
97	6435	20.28	20.53
105	6475	20.27	20.31
113	6515	20.53	20.15
117	6535	20.32	20.62
149	6695	20.42	20.46
181	6855	20.89	20.27
185	6875	20.86	20.22
209	6995	20.32	20.57
233	7115	20.71	20.30

802.11be (EHT20) 106-tone RU

Channel	Frequency (MHz)	26dB Bandwidth (MHz)	
		Chain 0	Chain 1
2	5935	20.36	20.88
1	5955	20.14	20.45
45	6175	20.08	20.56
93	6415	21.05	20.29
97	6435	20.13	20.66
105	6475	20.28	20.62
113	6515	20.75	20.12
117	6535	20.09	20.56
149	6695	20.14	20.57
181	6855	21.00	20.43
185	6875	21.01	20.16
209	6995	20.15	20.42
233	7115	21.24	20.45



Spectrum Plot of Maximum Value

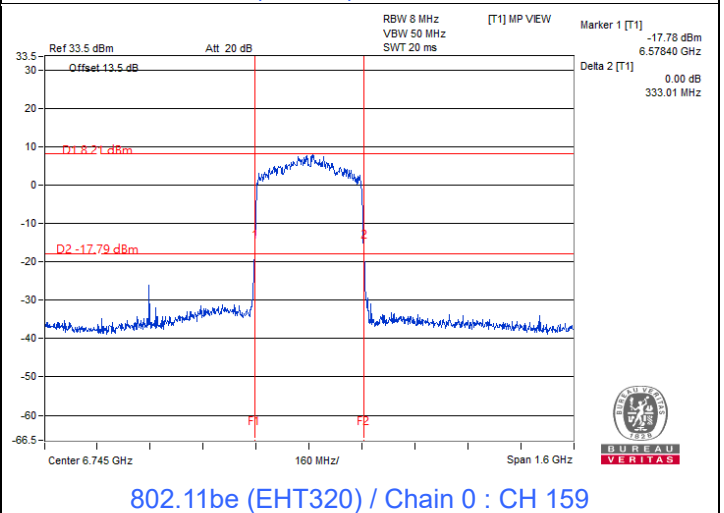
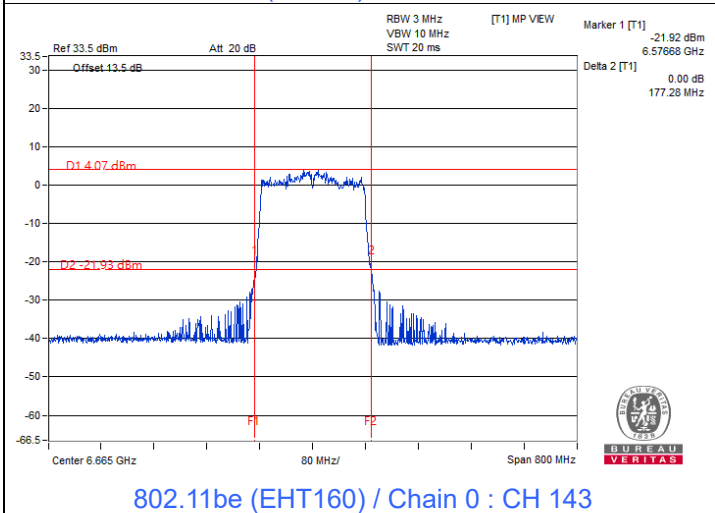
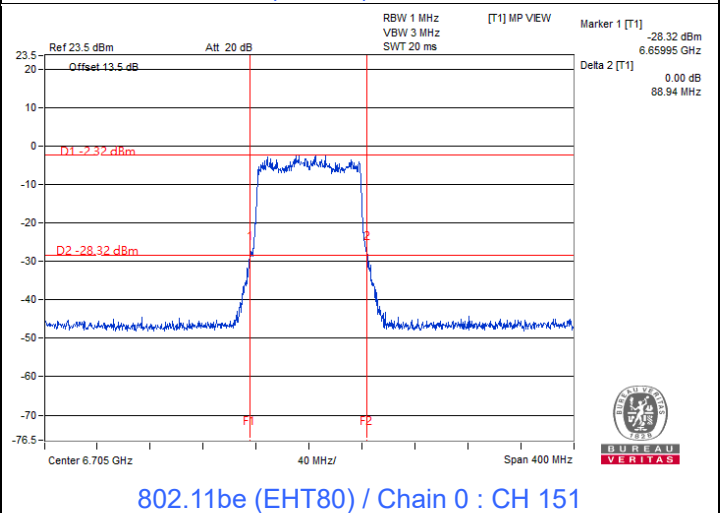
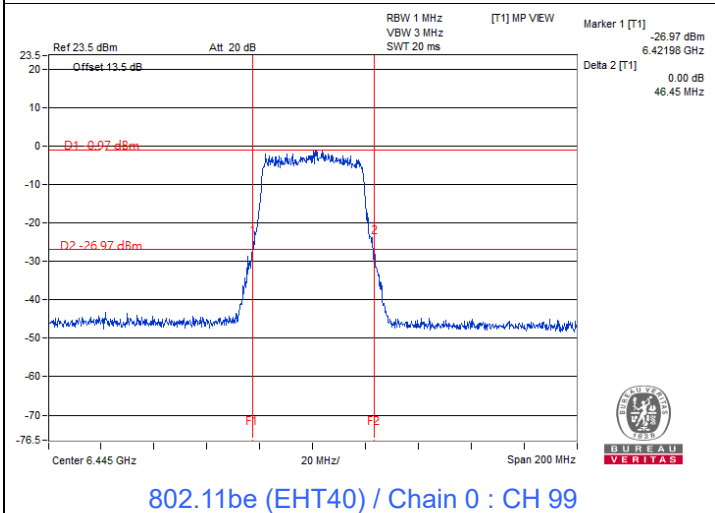
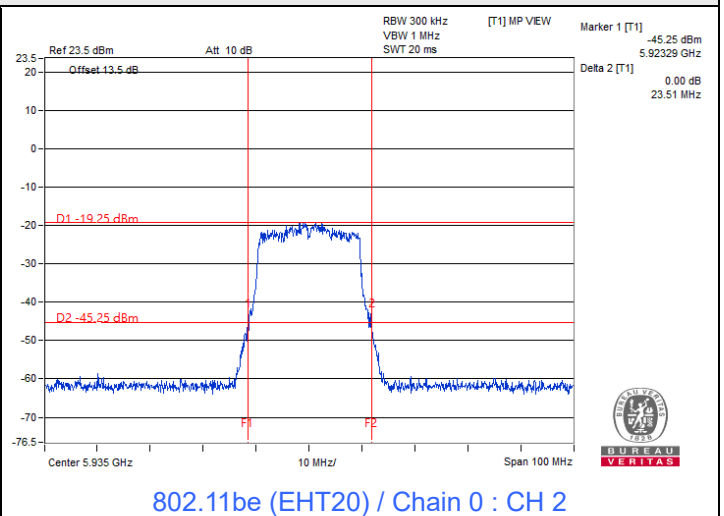
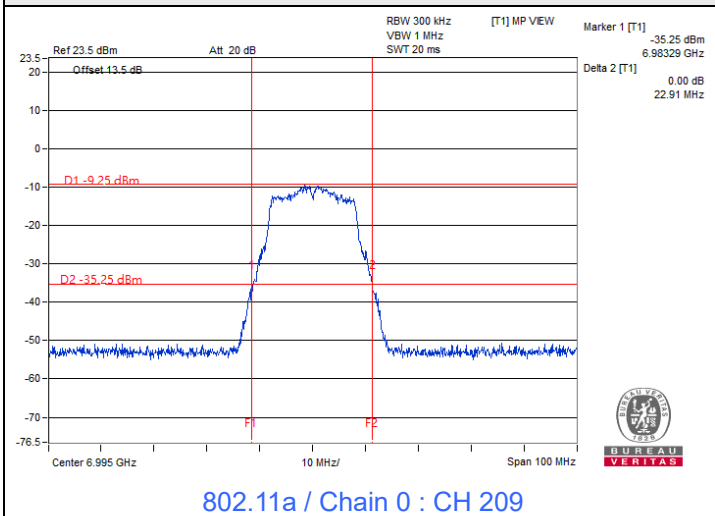

Spectrum Plot of Maximum Value

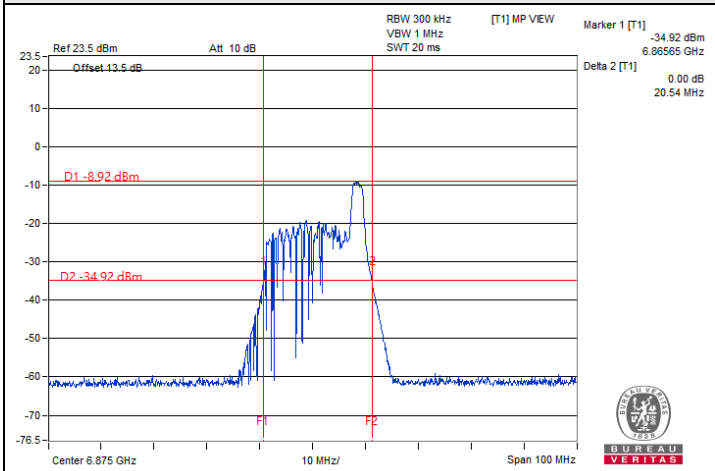

802.11be (EHT20) 26-tone RU / Chain 0 : CH 185@0

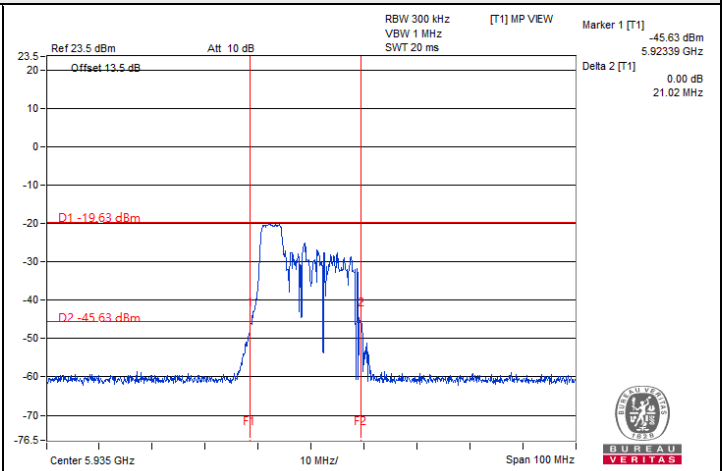

802.11be (EHT20) 52-tone RU / Chain 1 : CH 2

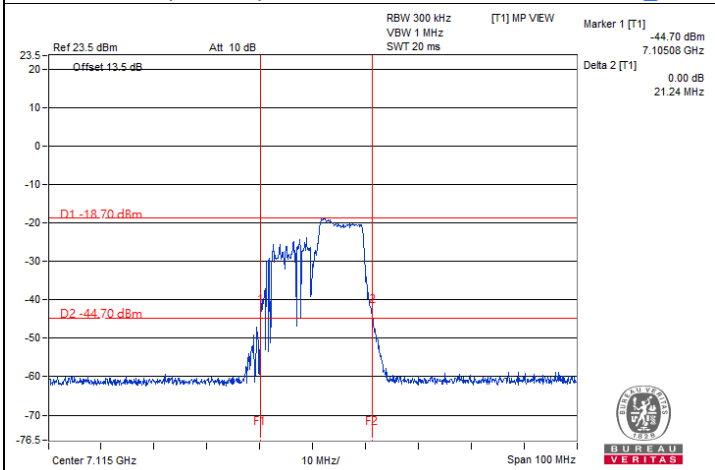

802.11be (EHT20) 106-tone RU / Chain 0 : CH 233@54

Mode C

Input Power:	3.3 Vdc	Environmental Conditions:	24°C, 64% RH	Tested By:	Eric Peng
--------------	---------	---------------------------	--------------	------------	-----------

802.11a

Channel	Frequency (MHz)	26dB Bandwidth (MHz)	
		Chain 0	Chain 1
2	5935	22.11	21.97
1	5955	22.26	22.12
45	6175	22.18	22.28
93	6415	22.28	21.96
117	6535	22.15	22.09
149	6695	22.28	22.04
181	6855	22.31	22.03

802.11be (EHT20)

Channel	Frequency (MHz)	26dB Bandwidth (MHz)	
		Chain 0	Chain 1
2	5935	23.51	22.83
1	5955	21.89	22.16
45	6175	22.36	22.57
93	6415	22.18	22.53
117	6535	22.93	23.33
149	6695	22.46	22.50
181	6855	22.45	22.54

802.11be (EHT40)

Channel	Frequency (MHz)	26dB Bandwidth (MHz)	
		Chain 0	Chain 1
3	5965	44.71	44.17
43	6165	43.88	44.57
91	6405	44.37	44.12
123	6565	44.25	44.44
155	6725	43.55	43.84
179	6845	44.38	44.83

802.11be (EHT80)

Channel	Frequency (MHz)	26dB Bandwidth (MHz)	
		Chain 0	Chain 1
7	5985	84.50	83.81
39	6145	84.79	83.75
87	6385	85.00	84.05
135	6625	84.60	83.93
151	6705	83.71	84.03
167	6785	84.77	84.20

802.11be (EHT160)

Channel	Frequency (MHz)	26dB Bandwidth (MHz)	
		Chain 0	Chain 1
15	6025	175.46	173.67
47	6185	176.75	172.93
79	6345	177.19	174.81
143	6665	175.34	173.89

802.11be (EHT320)

Channel	Frequency (MHz)	26dB Bandwidth (MHz)	
		Chain 0	Chain 1
31	6105	332.50	331.42
63	6265	330.02	335.57

802.11be (EHT20) 26-tone RU

Channel	Frequency (MHz)	26dB Bandwidth (MHz)	
		Chain 0	Chain 1
2	5935	20.37	20.33
1	5955	20.23	20.27
45	6175	20.21	20.19
93	6415	20.36	20.37
117	6535	20.27	20.31
149	6695	20.22	20.22
181	6855	20.39	20.20

802.11be (EHT20) 52-tone RU

Channel	Frequency (MHz)	26dB Bandwidth (MHz)	
		Chain 0	Chain 1
2	5935	20.41	21.02
1	5955	20.12	20.28
45	6175	20.32	20.46
93	6415	20.79	20.34
117	6535	20.43	20.36
149	6695	20.37	20.56
181	6855	20.80	20.32

802.11be (EHT20) 106-tone RU

Channel	Frequency (MHz)	26dB Bandwidth (MHz)	
		Chain 0	Chain 1
2	5935	20.36	20.88
1	5955	19.93	20.42
45	6175	20.09	20.35
93	6415	20.97	20.56
117	6535	20.18	20.62
149	6695	20.30	20.55
181	6855	20.93	20.36

Spectrum Plot of Maximum Value

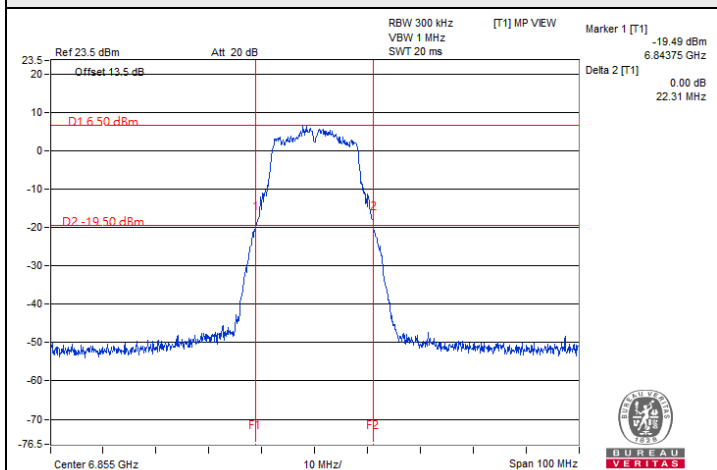

802.11a / Chain 0 : CH 181

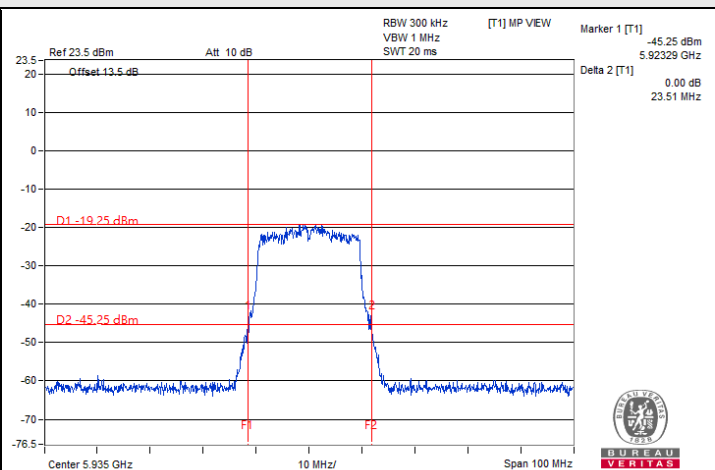

802.11be (EHT20) / Chain 0 : CH 2

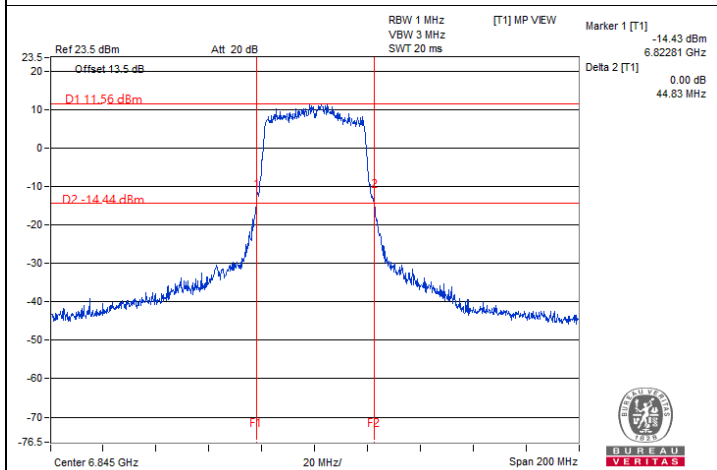

802.11be (EHT40) / Chain 1 : CH 179

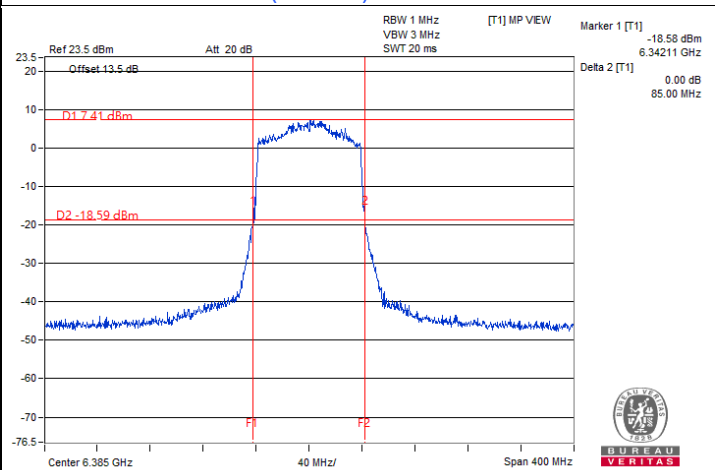

802.11be (EHT80) / Chain 0 : CH 87

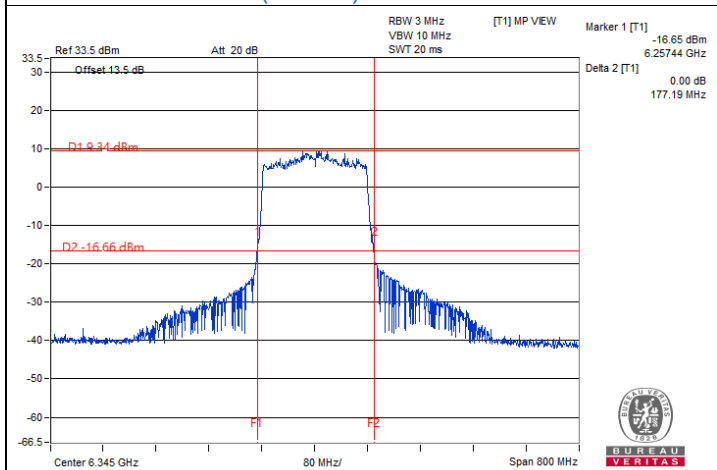

802.11be (EHT160) / Chain 0 : CH 79

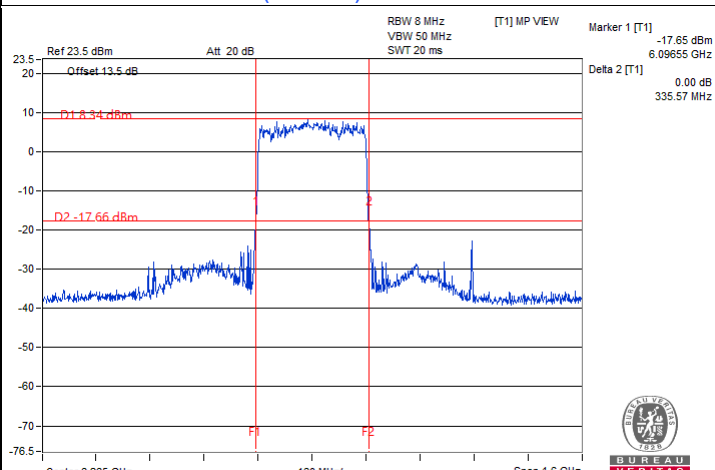

802.11be (EHT320) / Chain 1 : CH 63



Spectrum Plot of Maximum Value

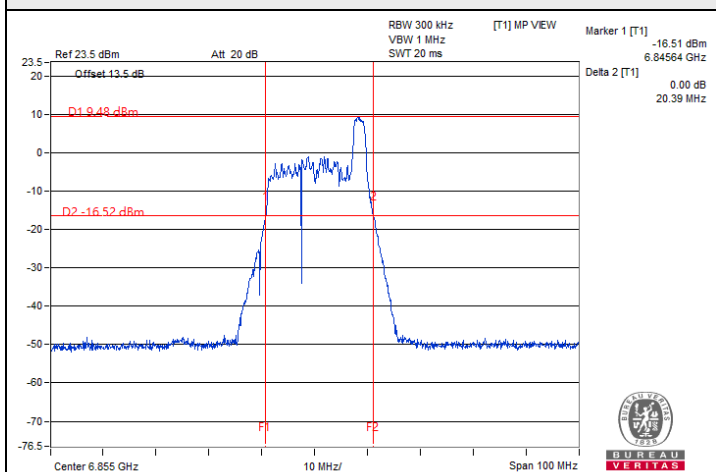

802.11be (EHT20) 26-tone RU / Chain 0 : CH 181@8

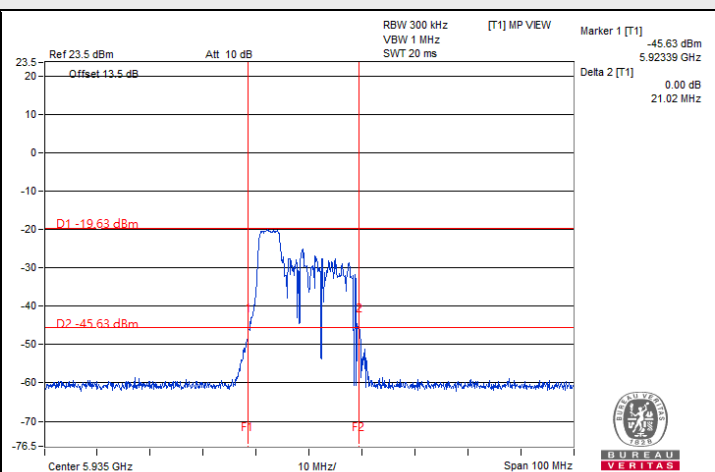

802.11be (EHT20) 52-tone RU / Chain 1 : CH 2

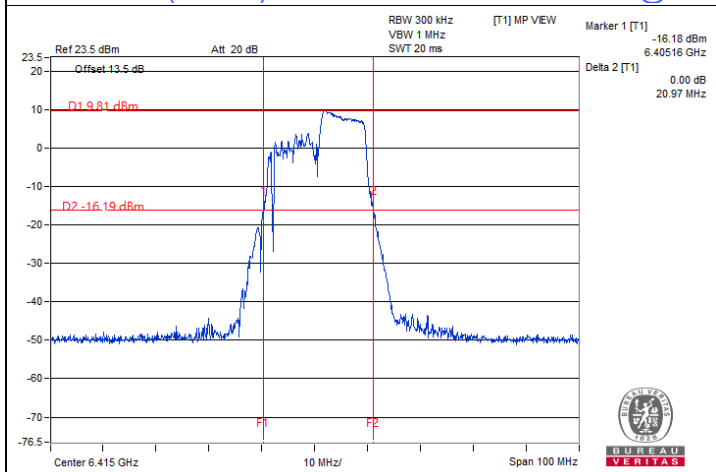

802.11be (EHT20) 106-tone RU / Chain 0 : CH 93@54

7.4 In-Band Emission Mask

Mode A

Input Power:	3.3 Vdc	Environmental Conditions:	24°C, 65% RH	Tested By:	Eric Peng
--------------	---------	---------------------------	--------------	------------	-----------

802.11a

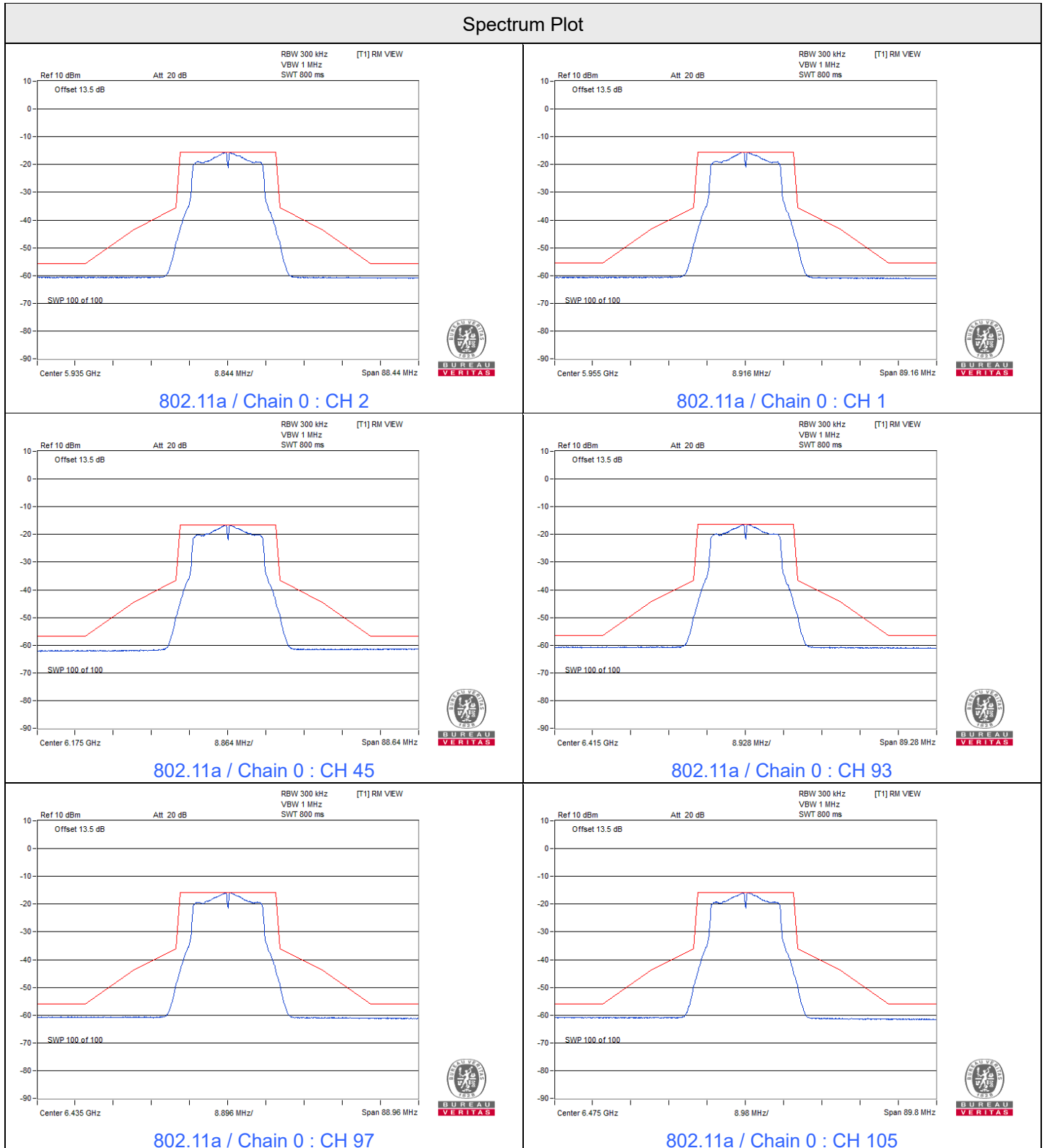

Spectrum Plot

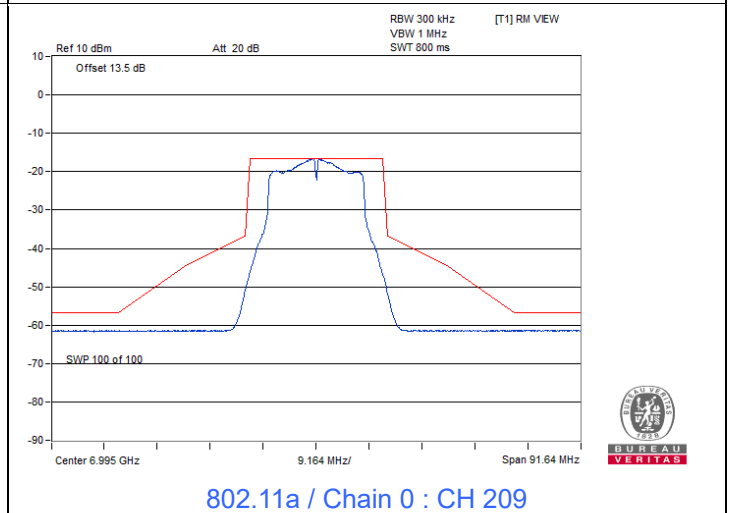
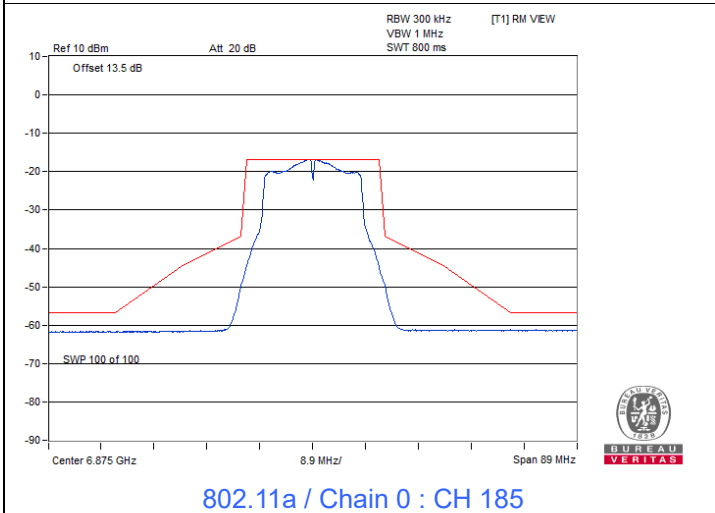
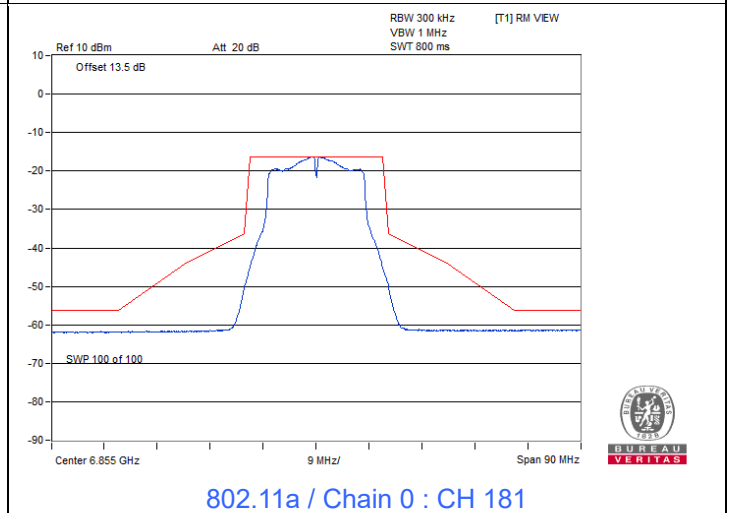
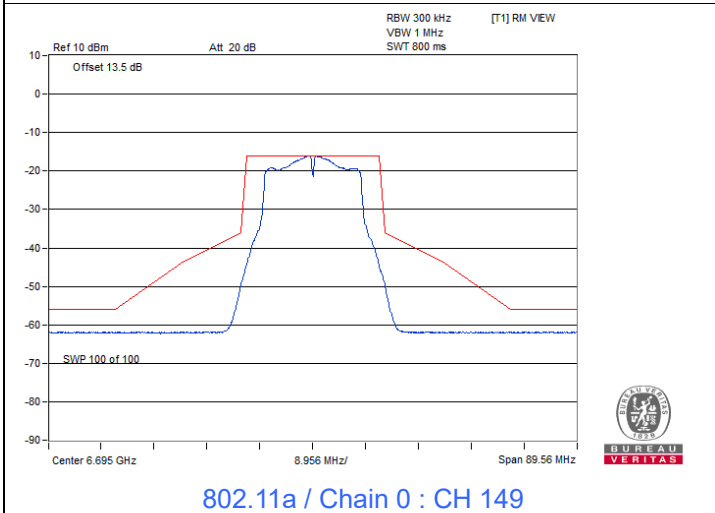
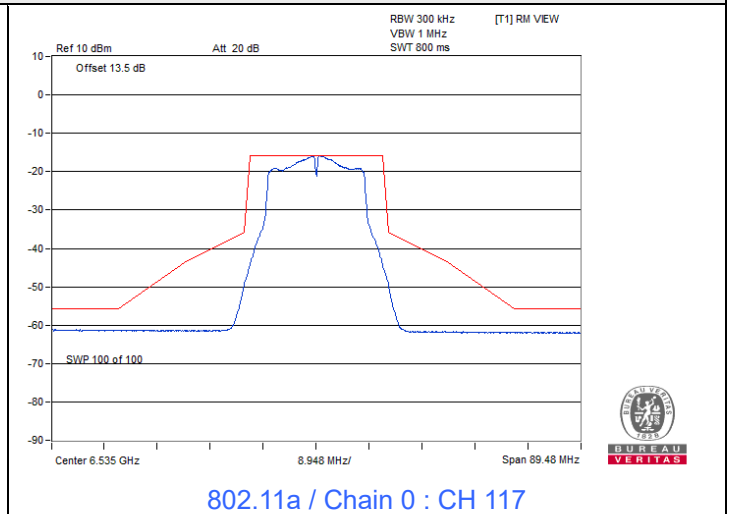
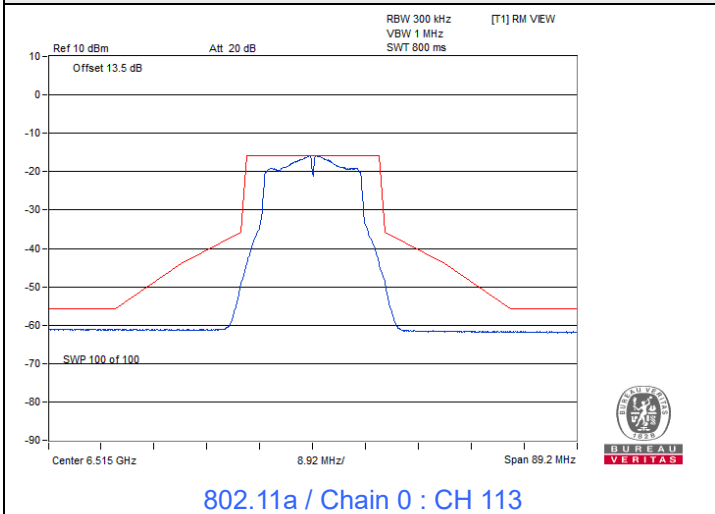

Spectrum Plot

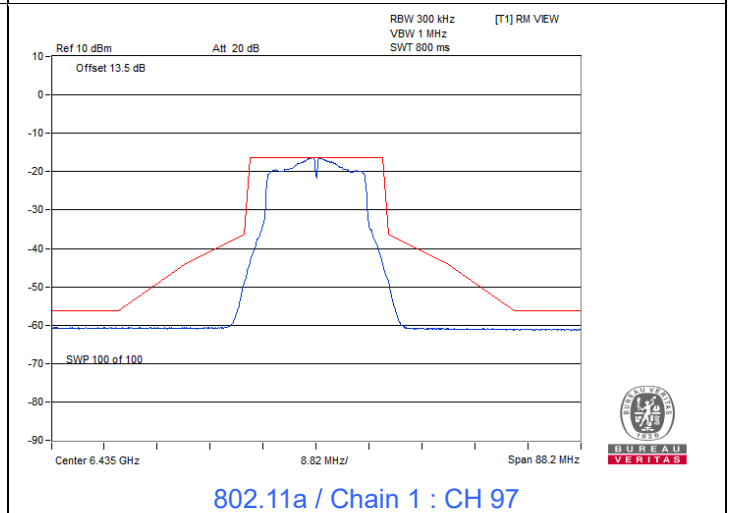
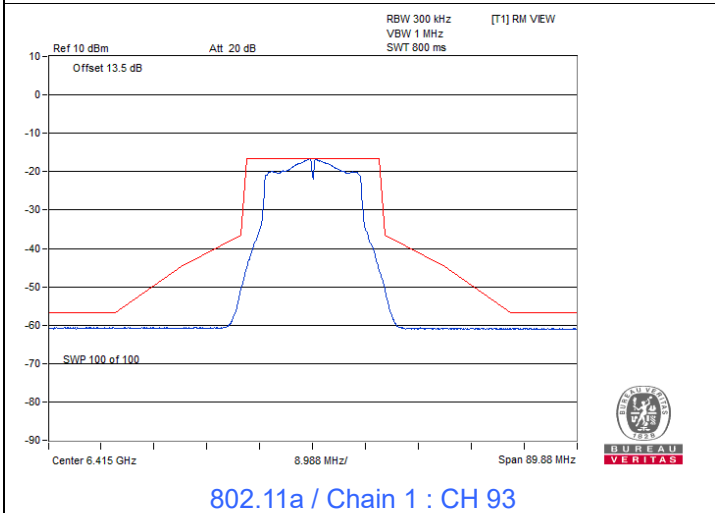
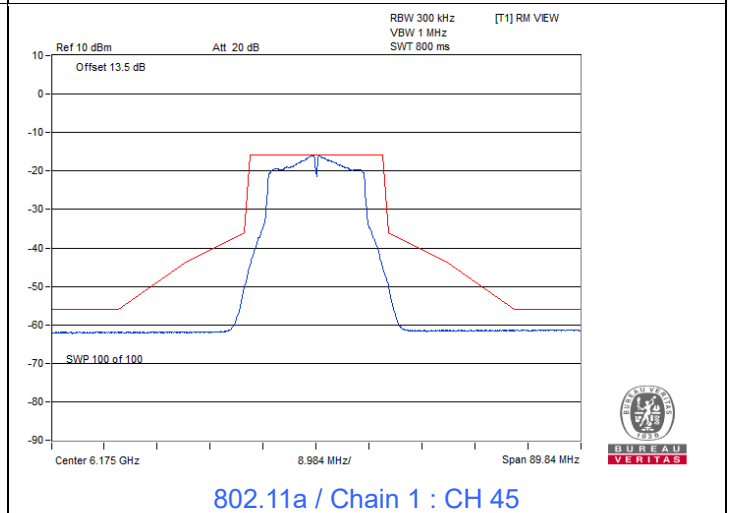
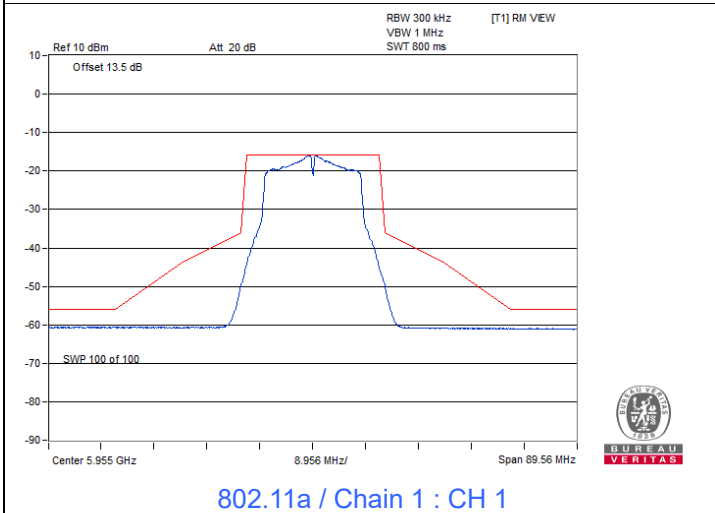
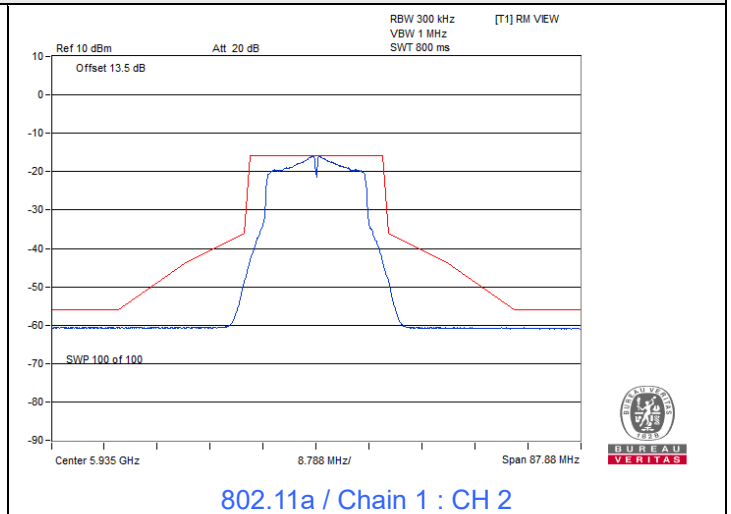
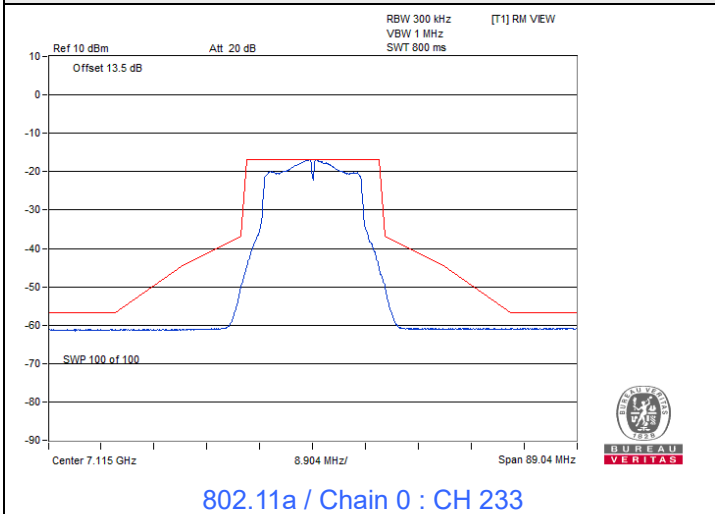

Spectrum Plot

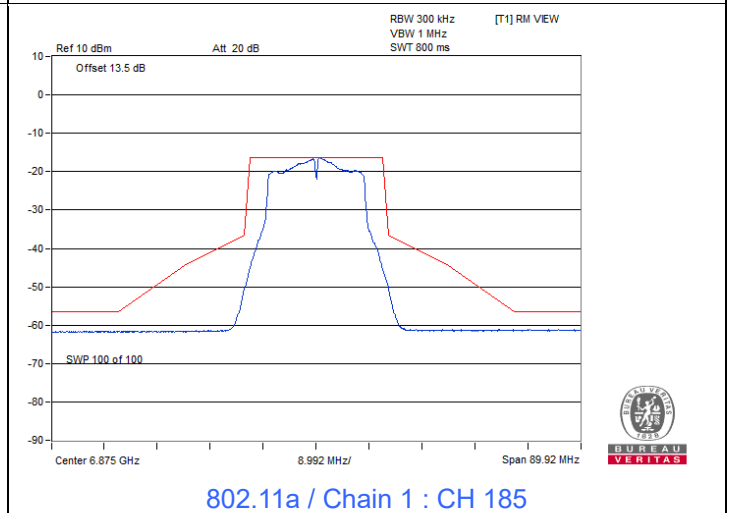
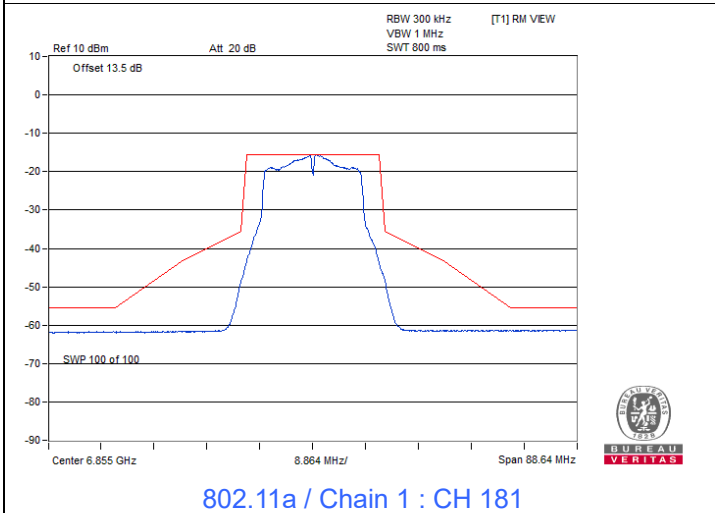
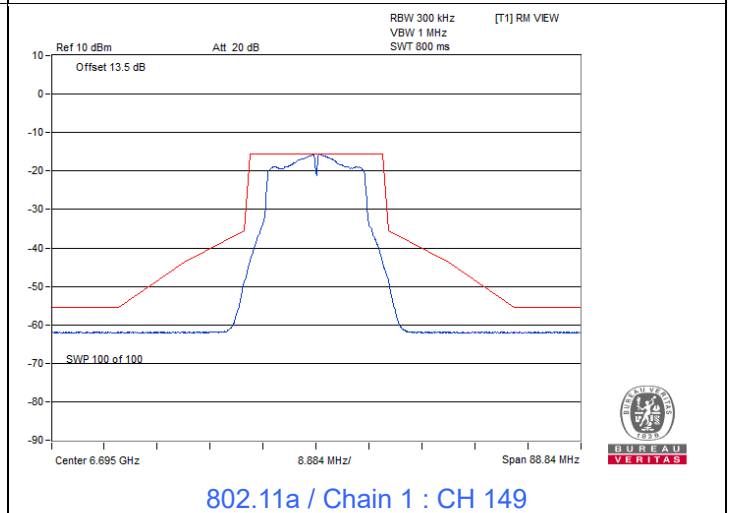
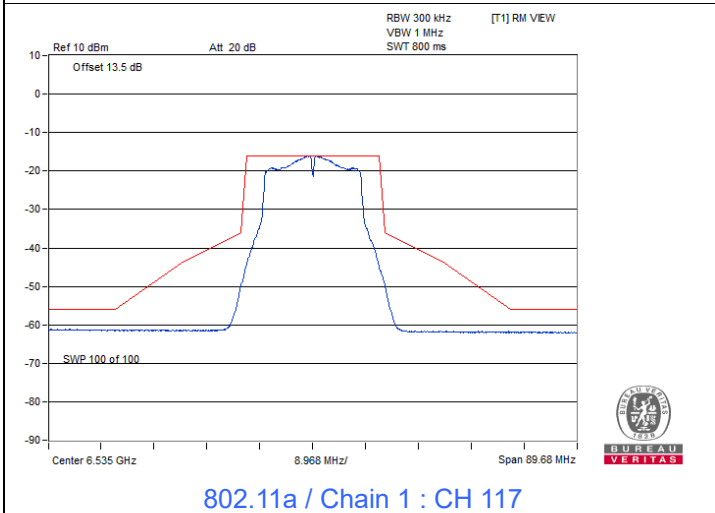
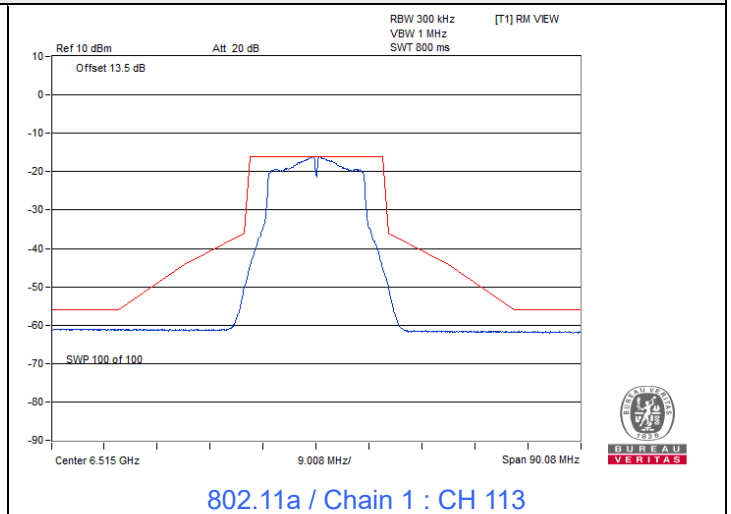
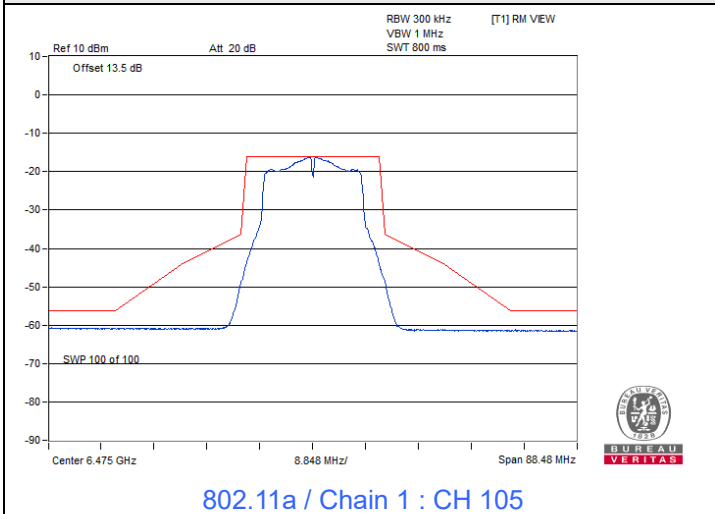

Spectrum Plot

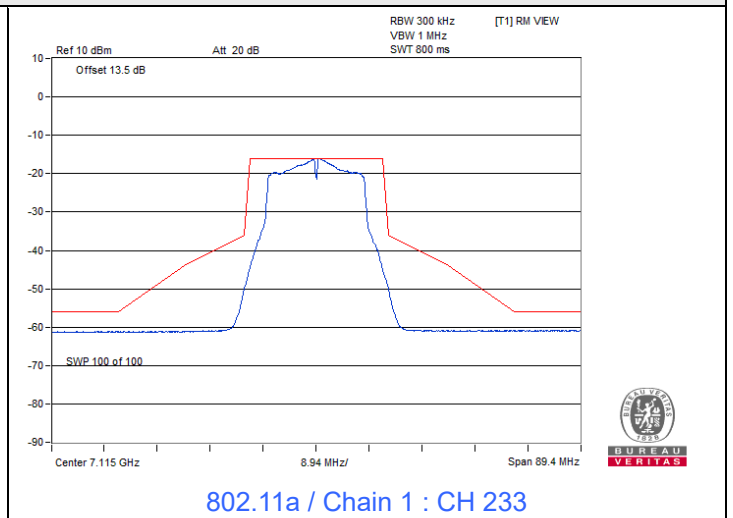
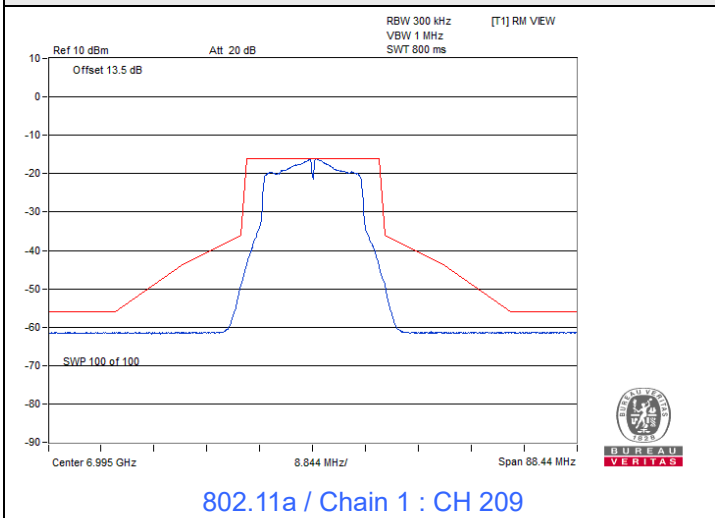

802.11be (EHT20)

Spectrum Plot

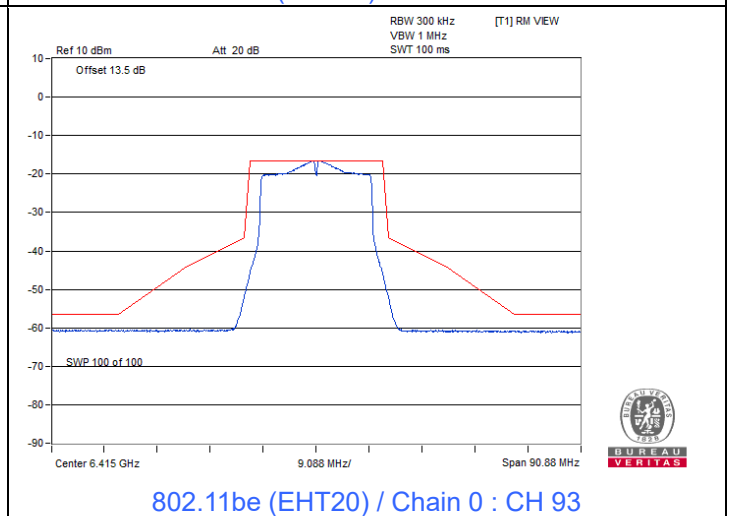
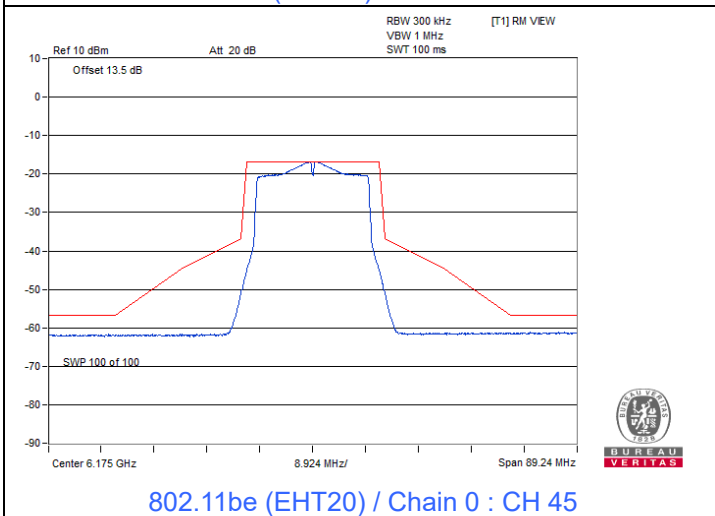
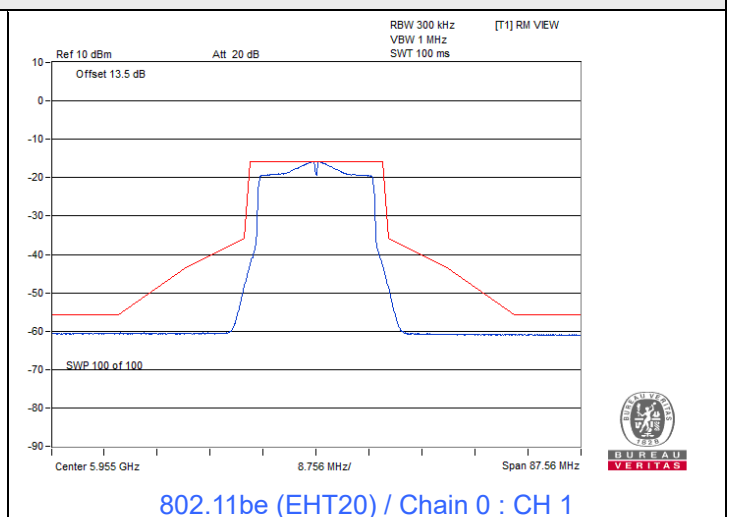
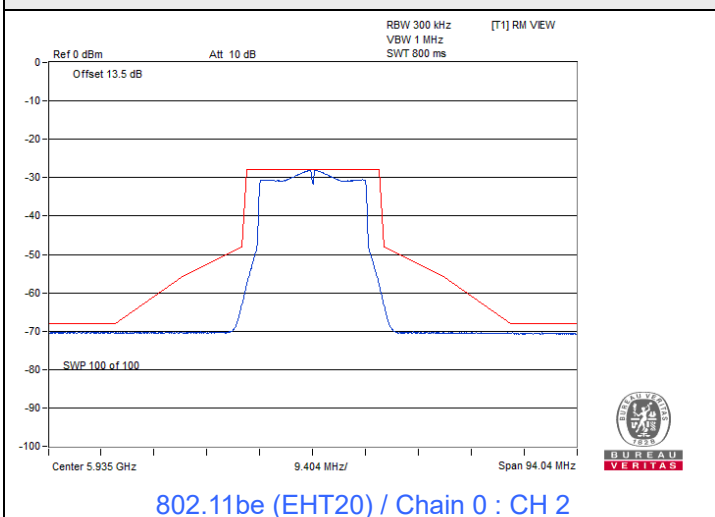

Spectrum Plot

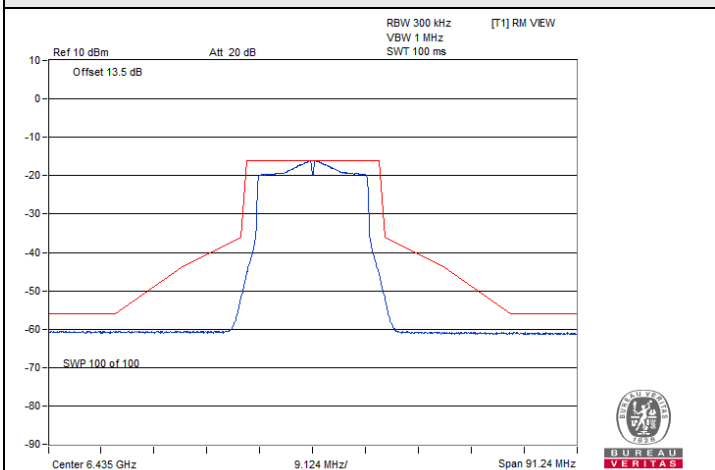

802.11be (EHT20) / Chain 0 : CH 97

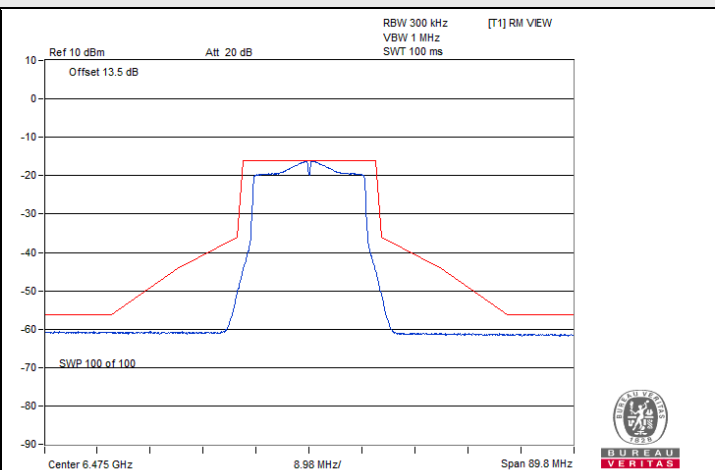

802.11be (EHT20) / Chain 0 : CH 105

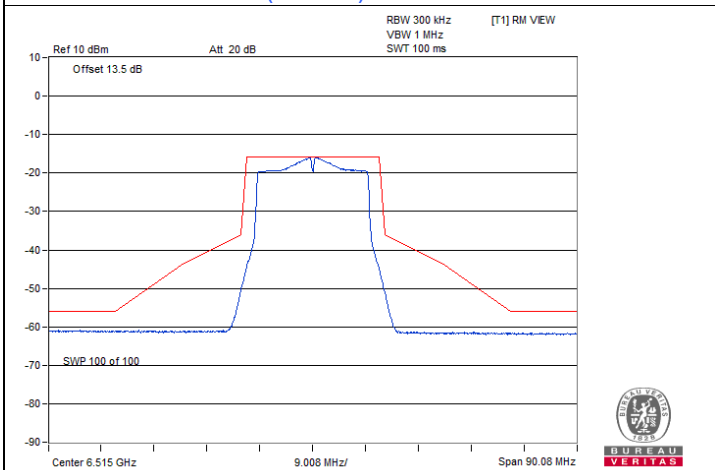

802.11be (EHT20) / Chain 0 : CH 113

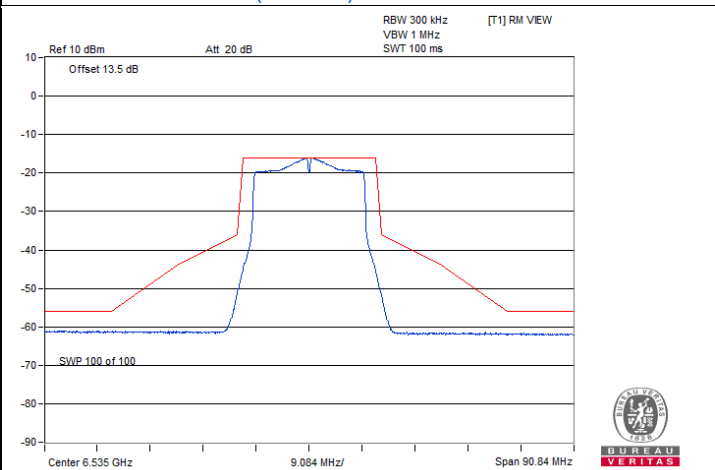

802.11be (EHT20) / Chain 0 : CH 117

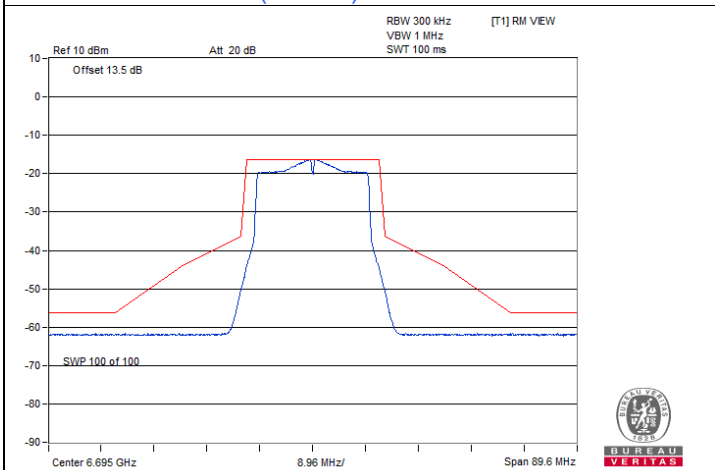

802.11be (EHT20) / Chain 0 : CH 149

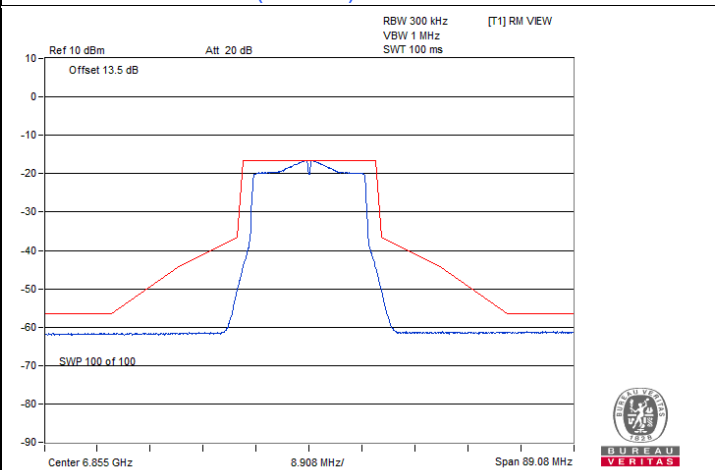

802.11be (EHT20) / Chain 0 : CH 181

Spectrum Plot

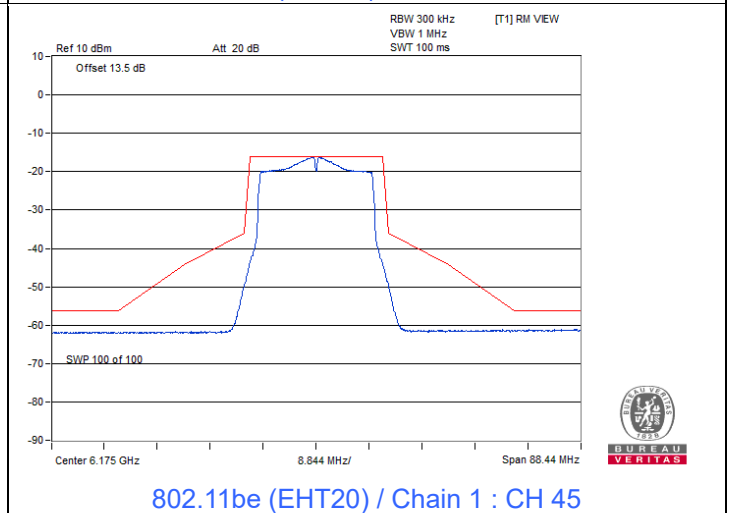
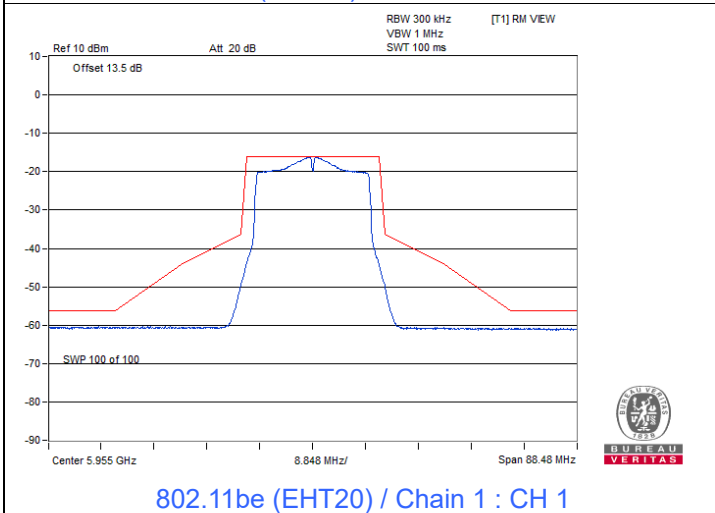
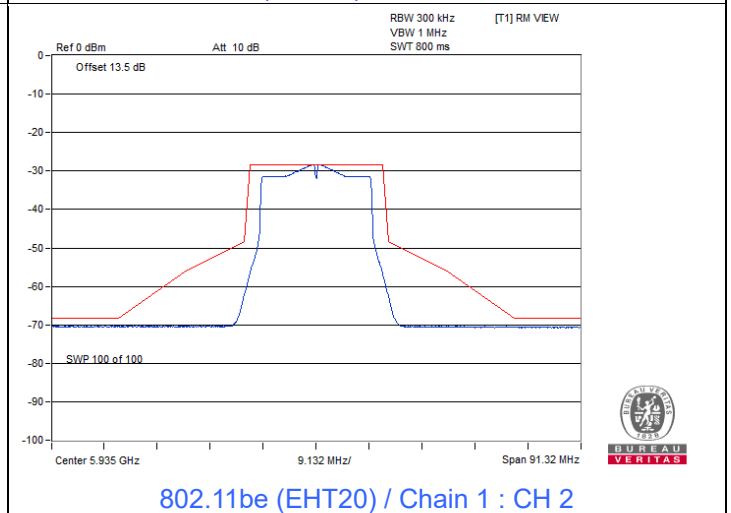
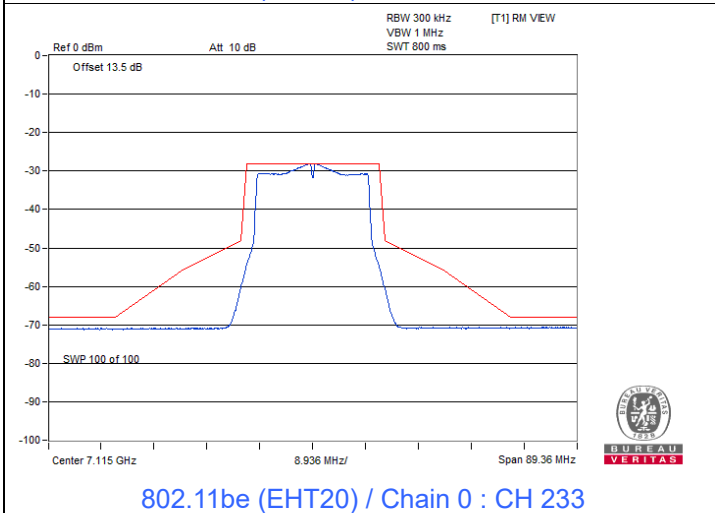
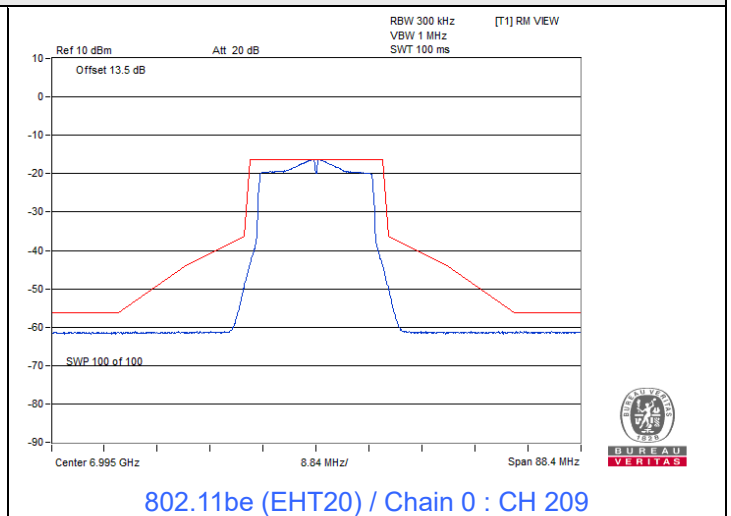
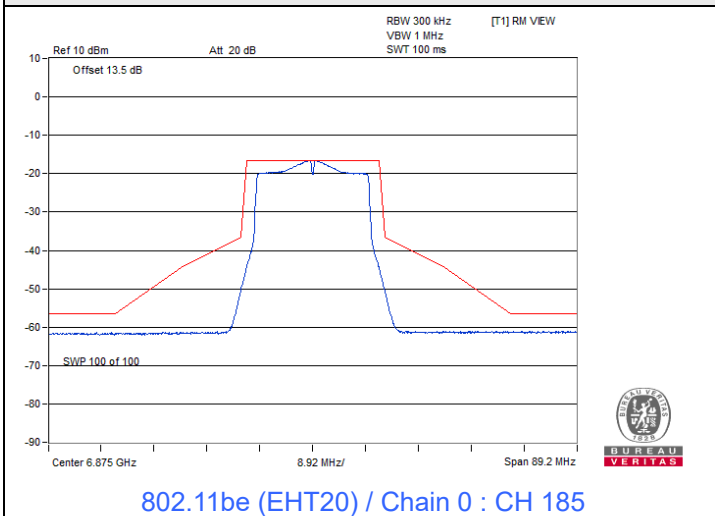

Spectrum Plot

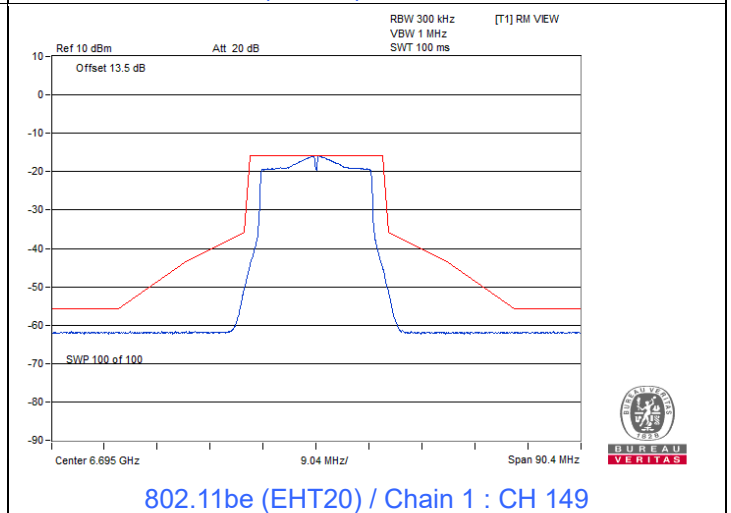
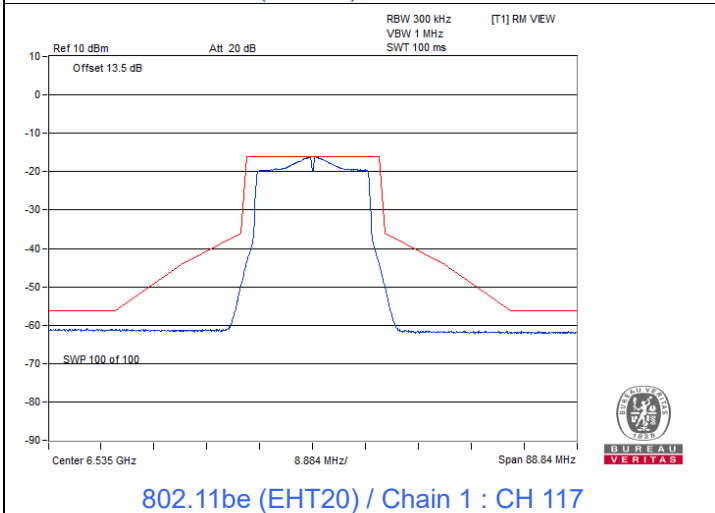
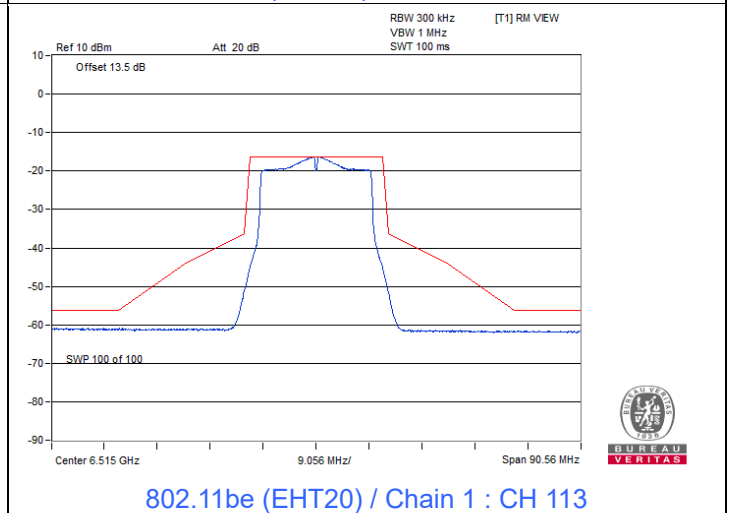
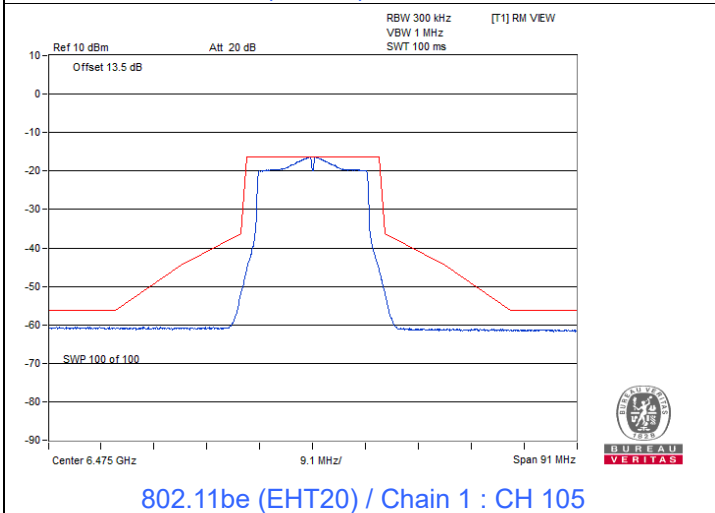
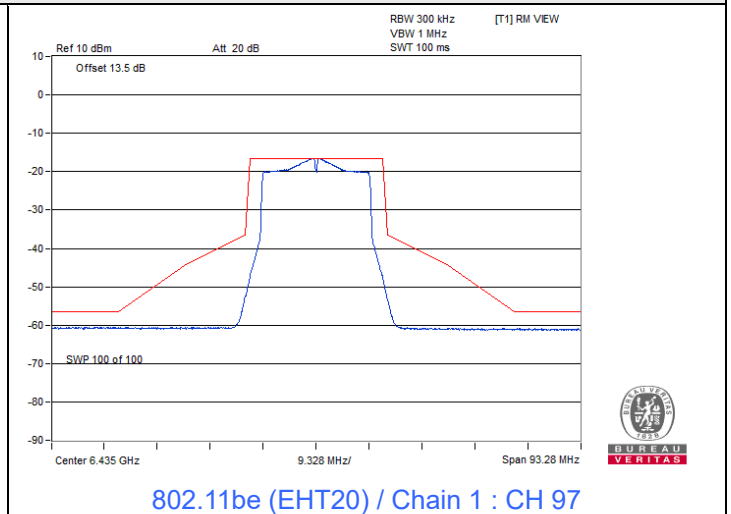
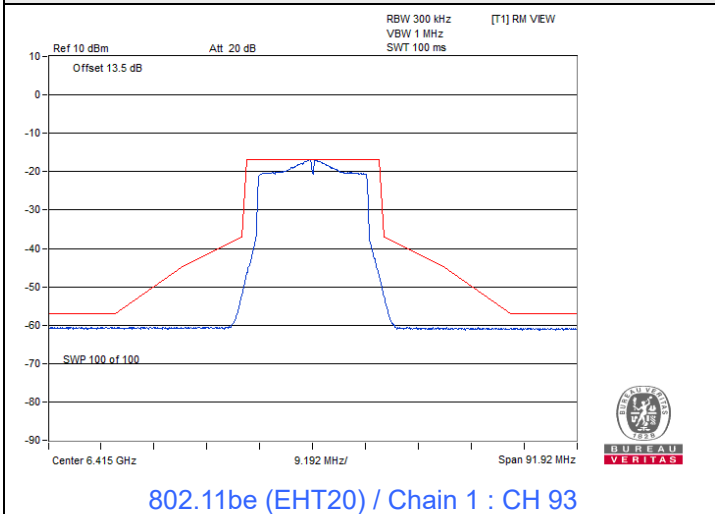

Spectrum Plot

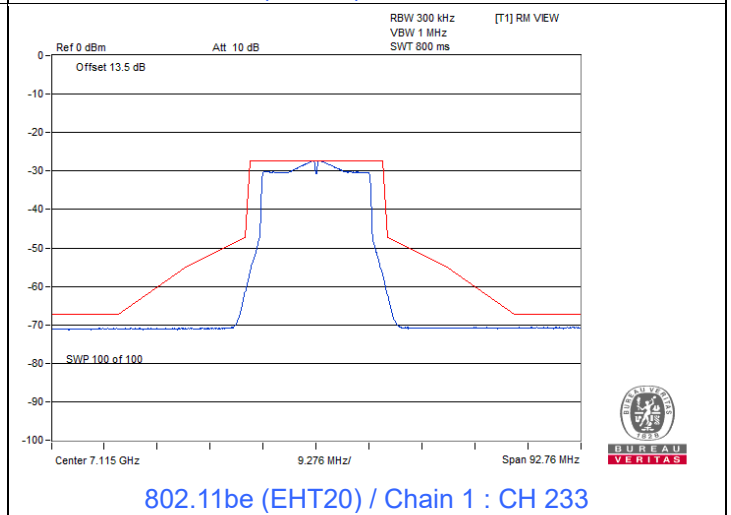
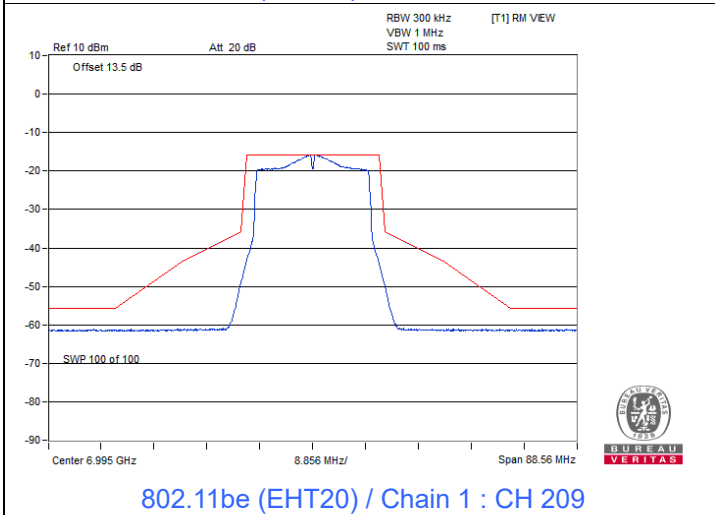
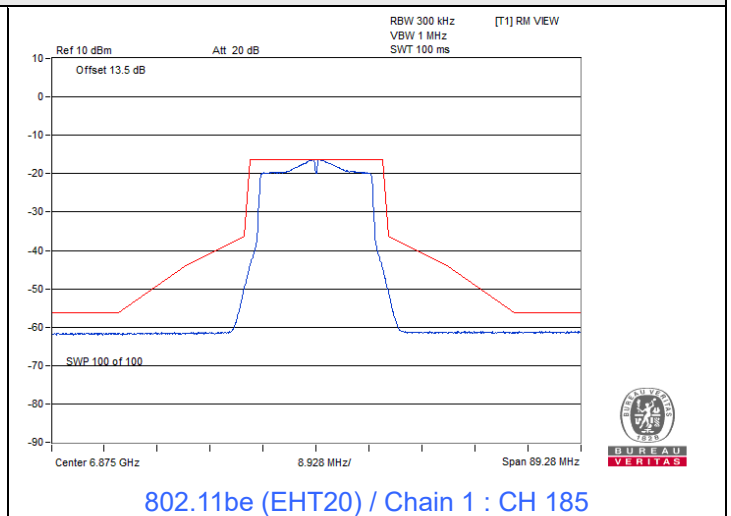
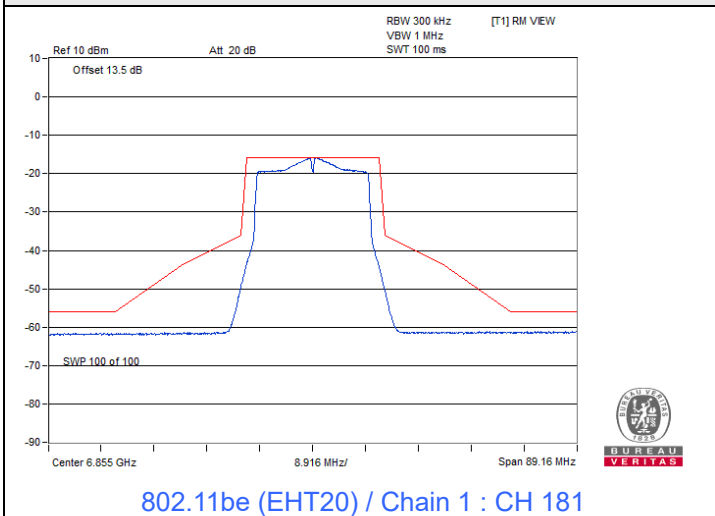

802.11be (EHT40)

Spectrum Plot

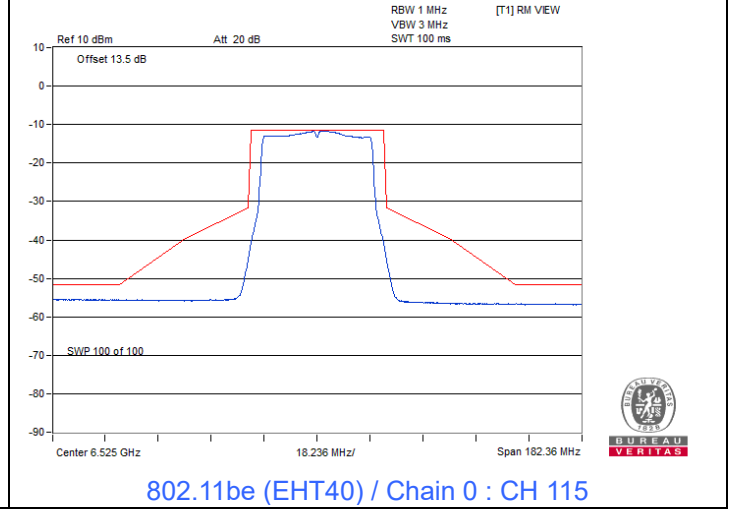
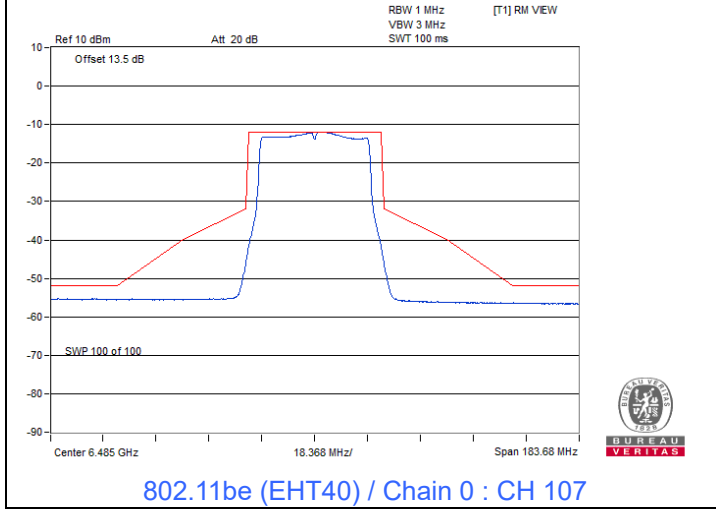
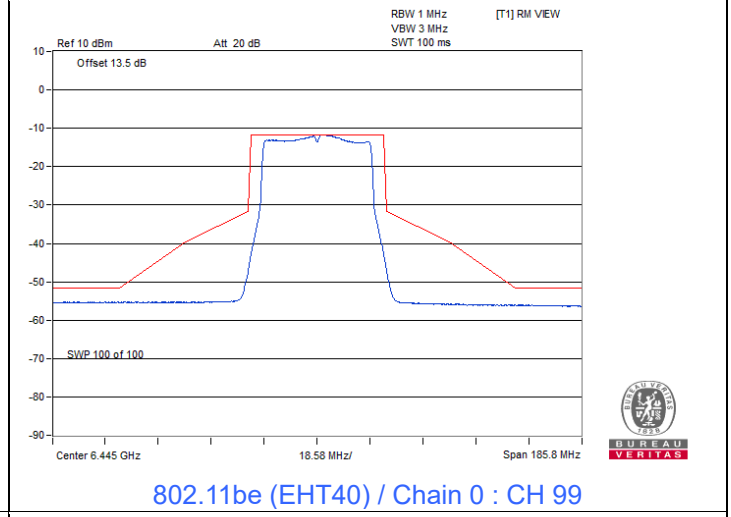
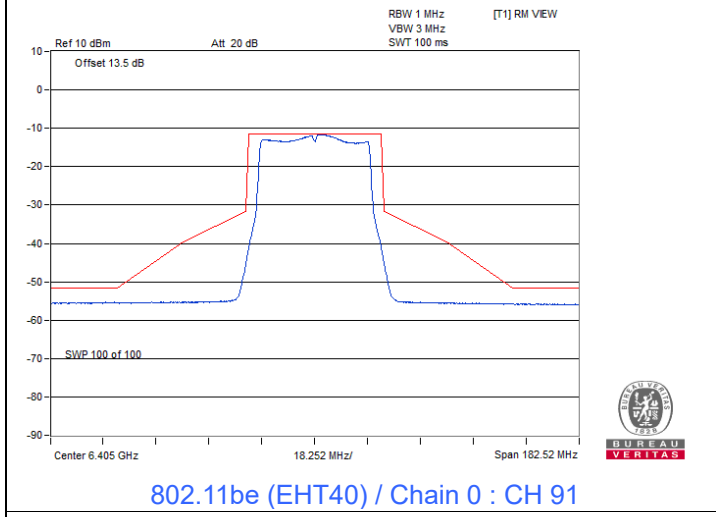
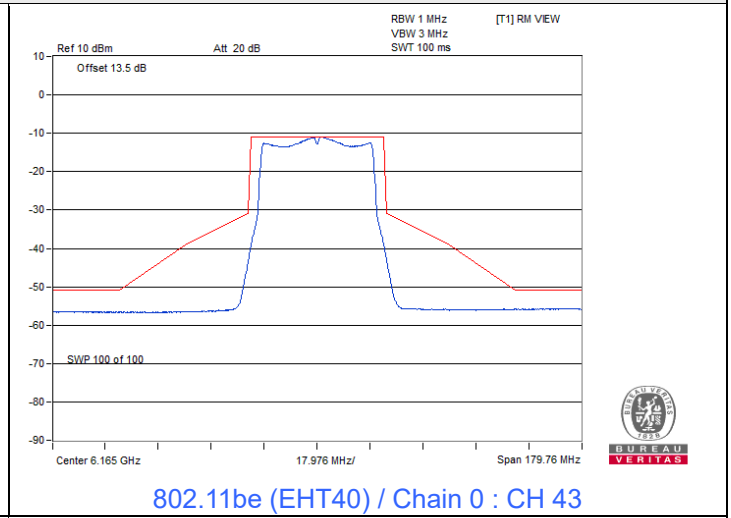
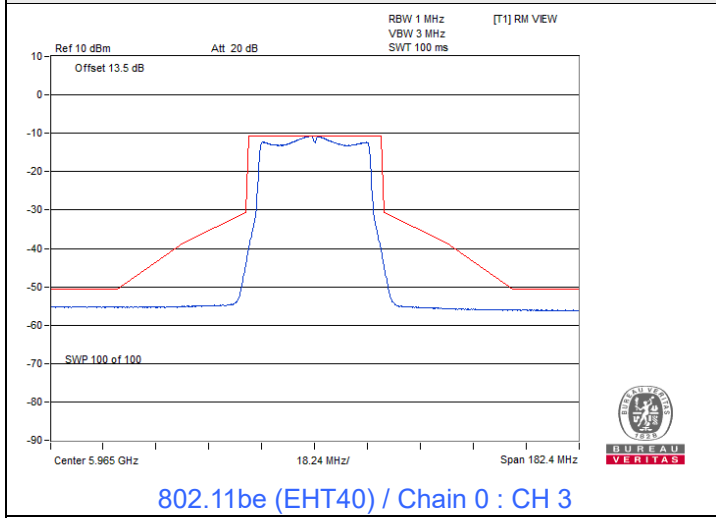

Spectrum Plot

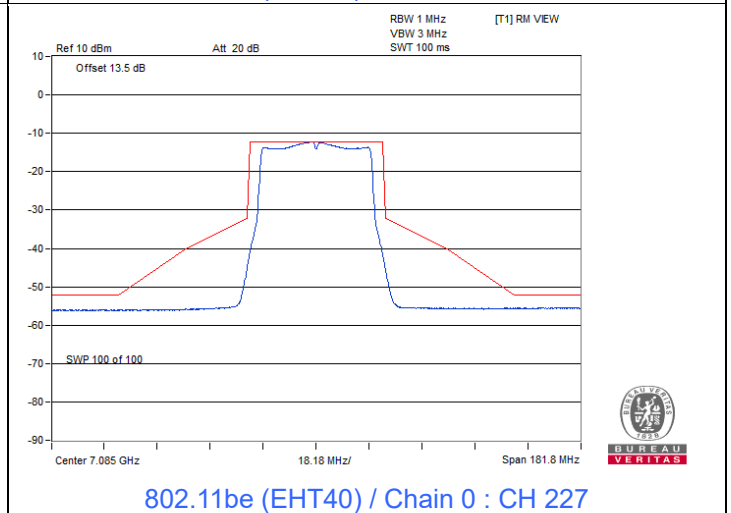
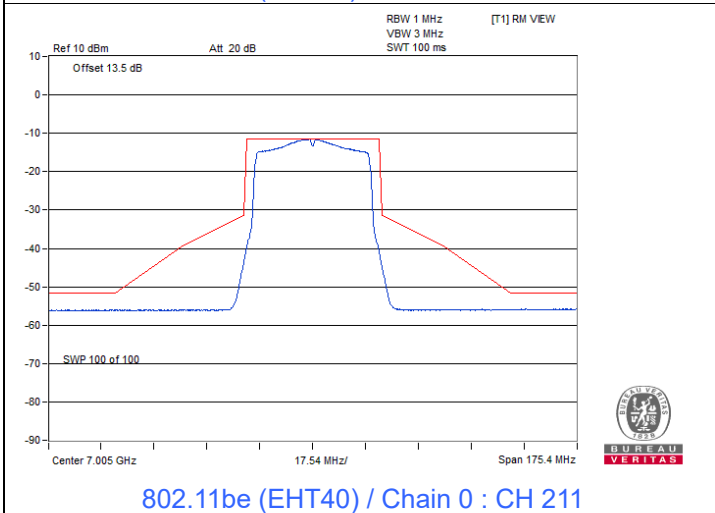
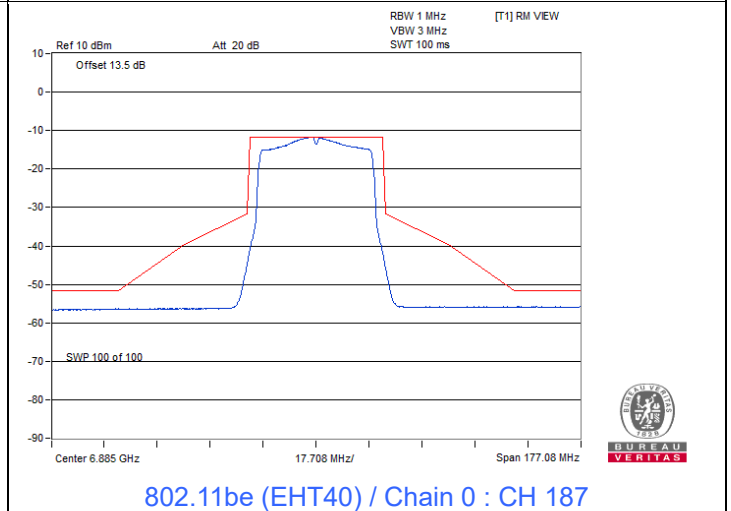
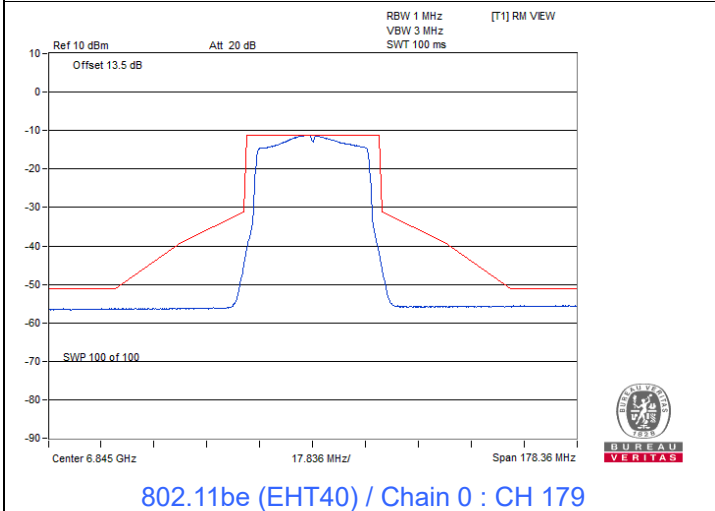
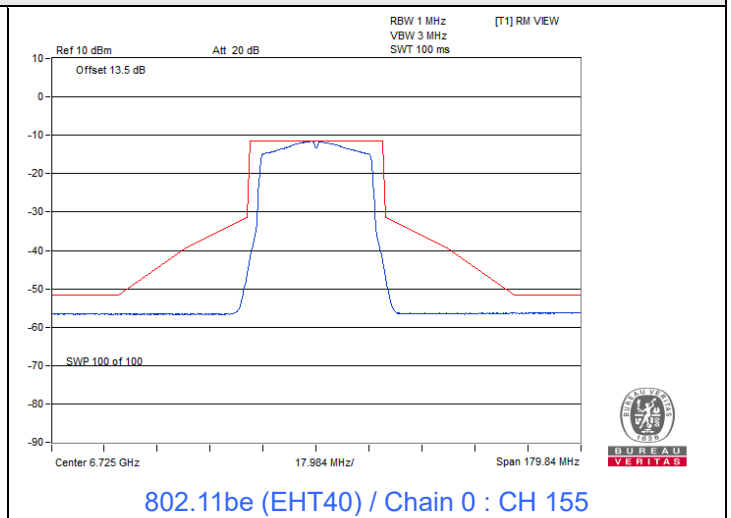
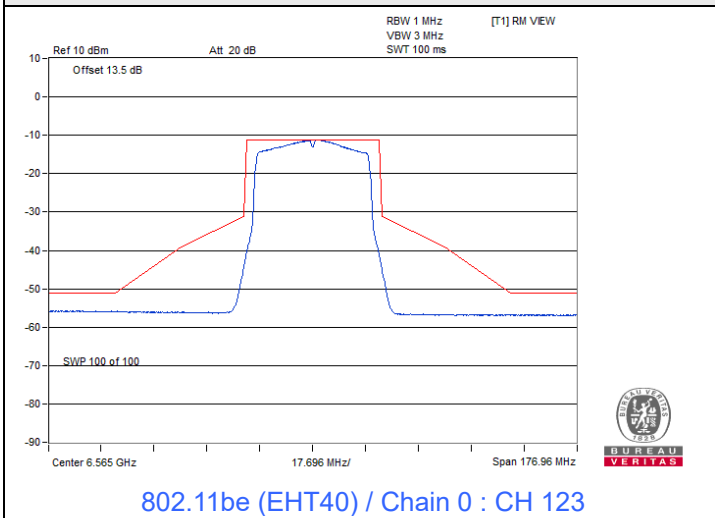

Spectrum Plot

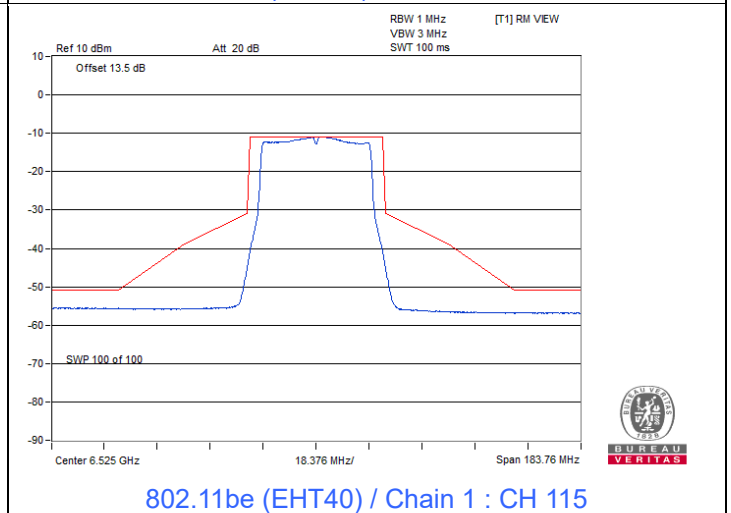
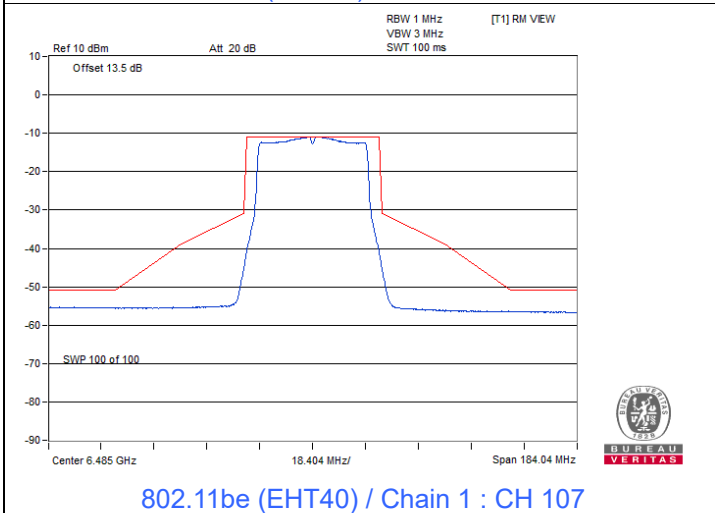
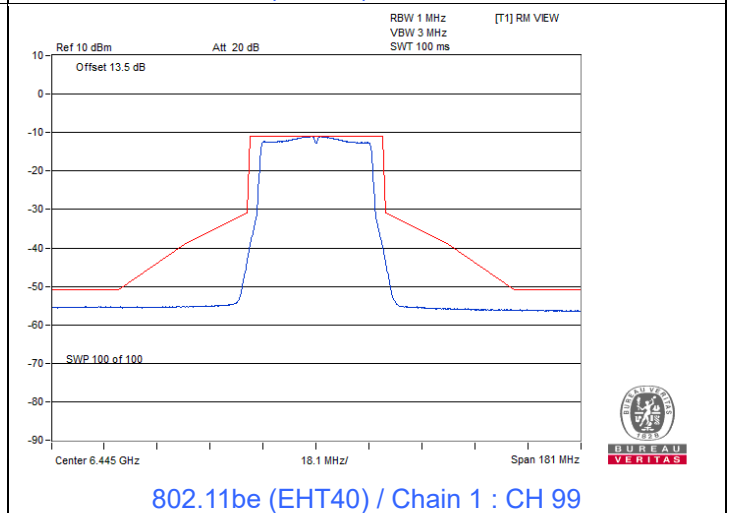
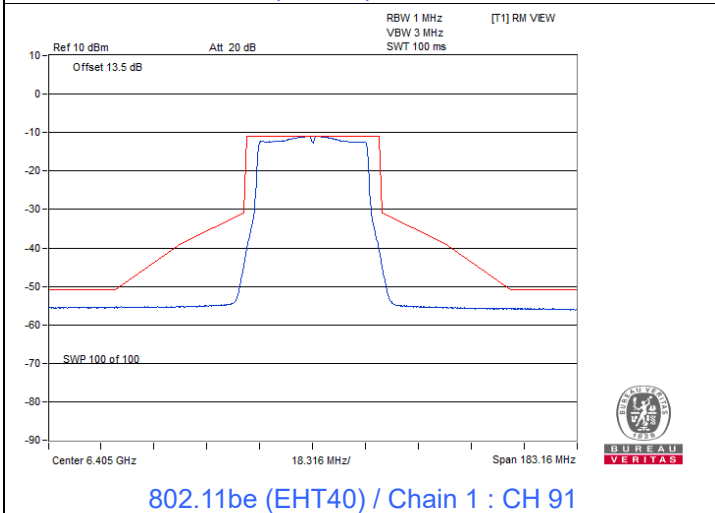
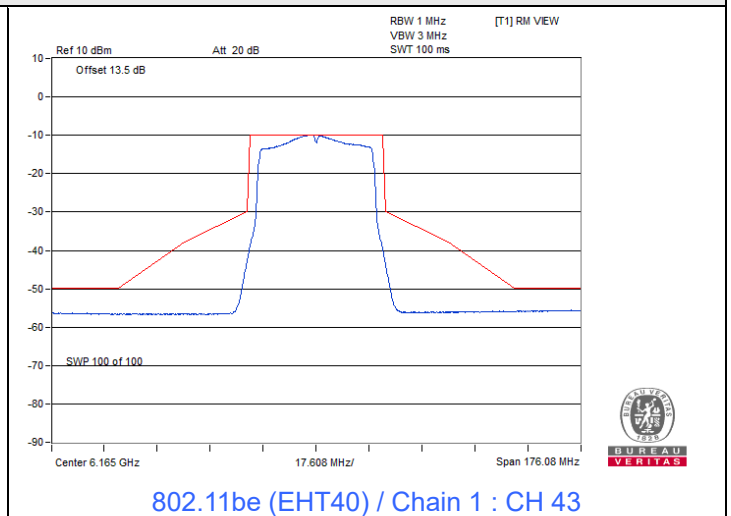
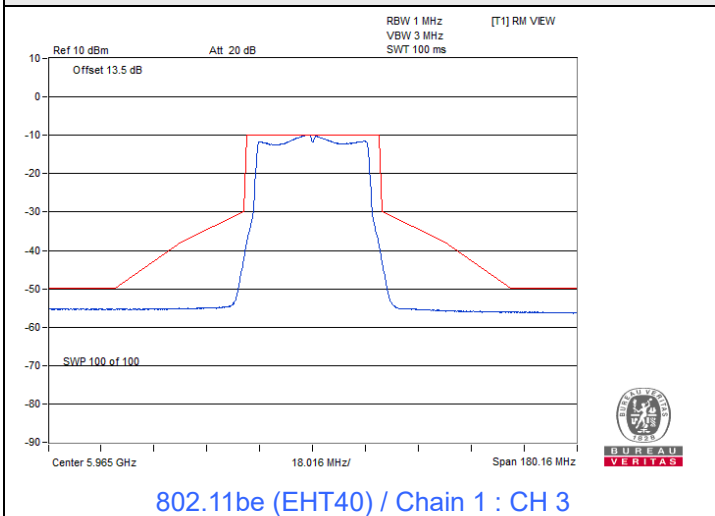

Spectrum Plot

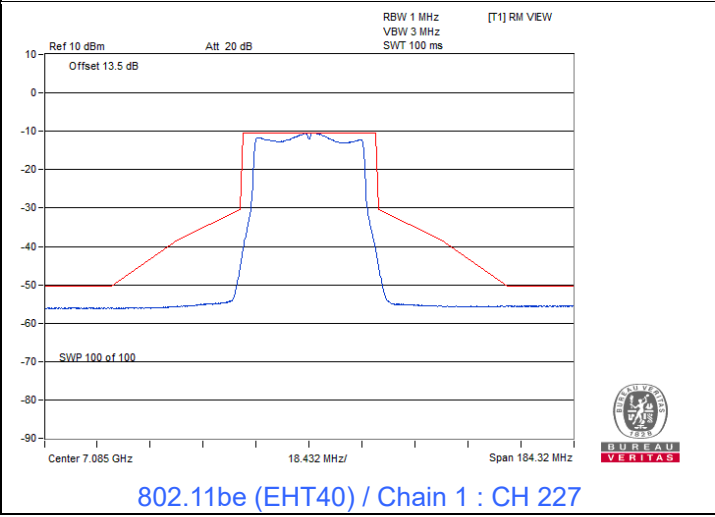
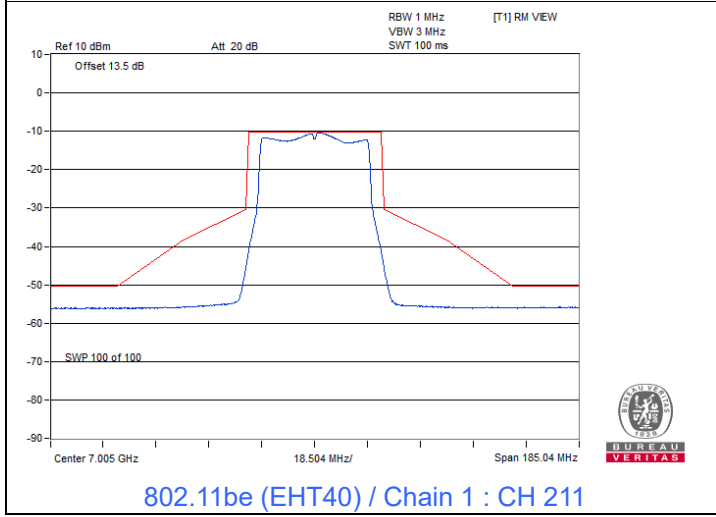
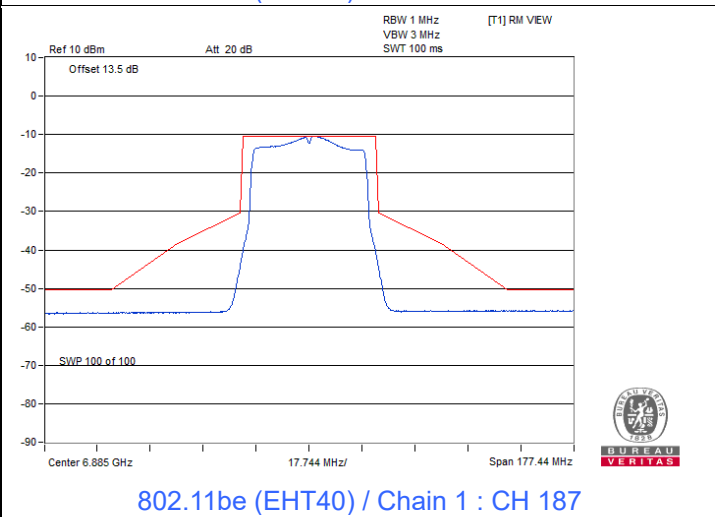
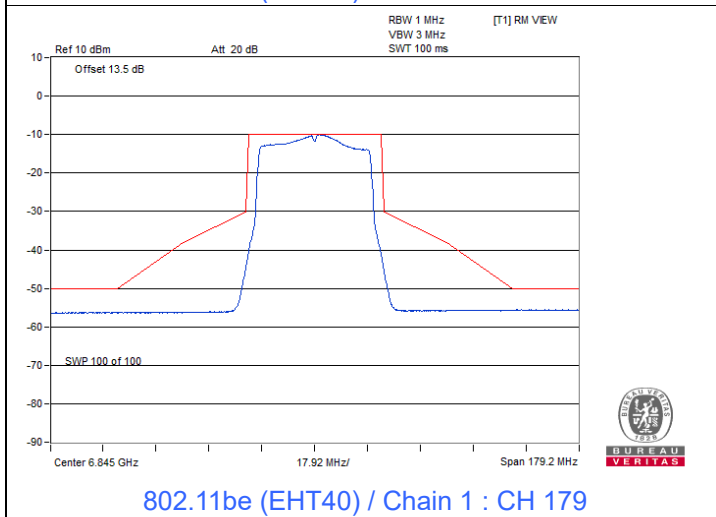
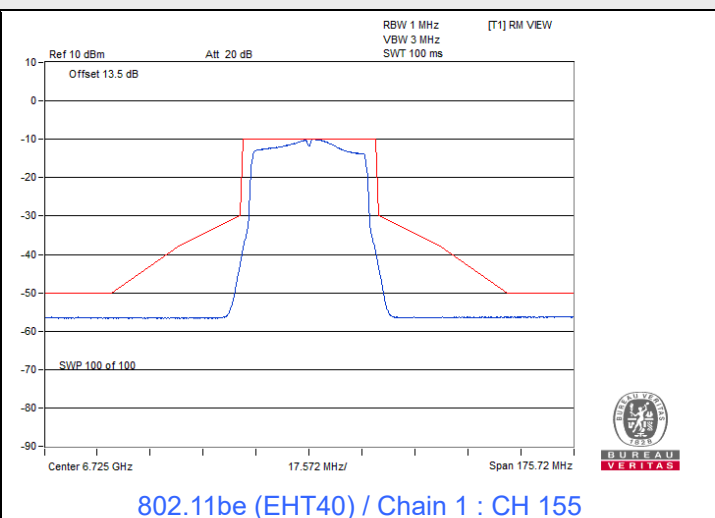
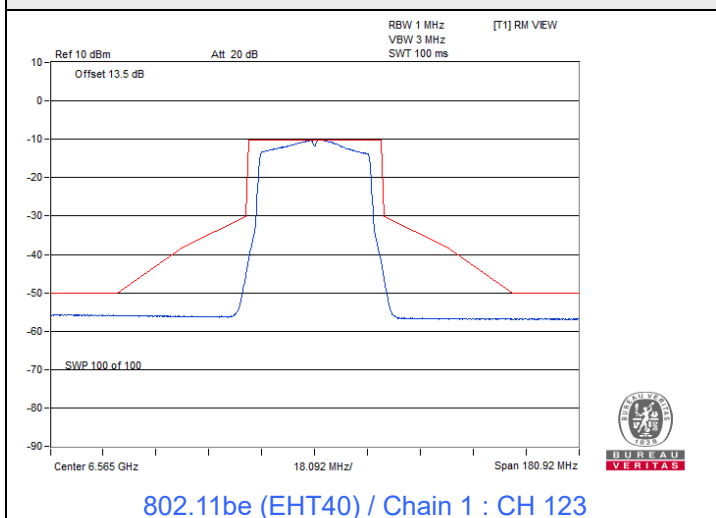

802.11be (EHT80)

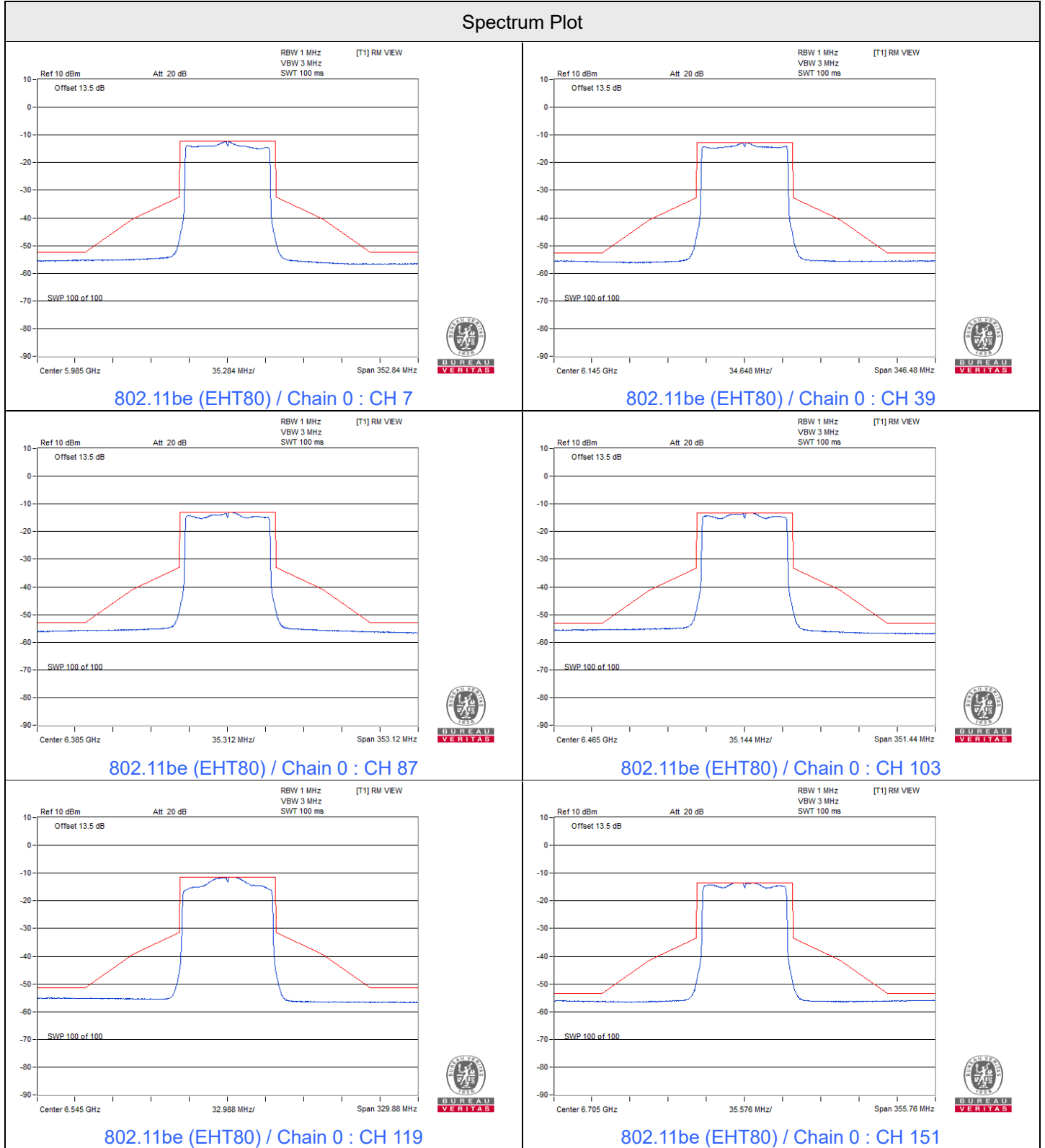

Spectrum Plot

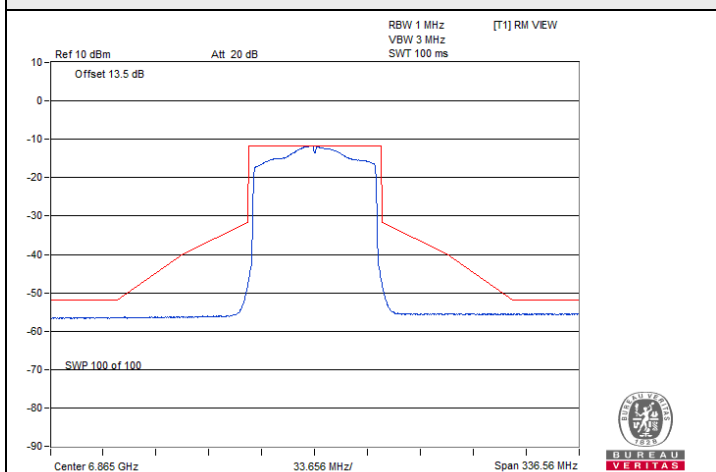

802.11be (EHT80) / Chain 0 : CH 183

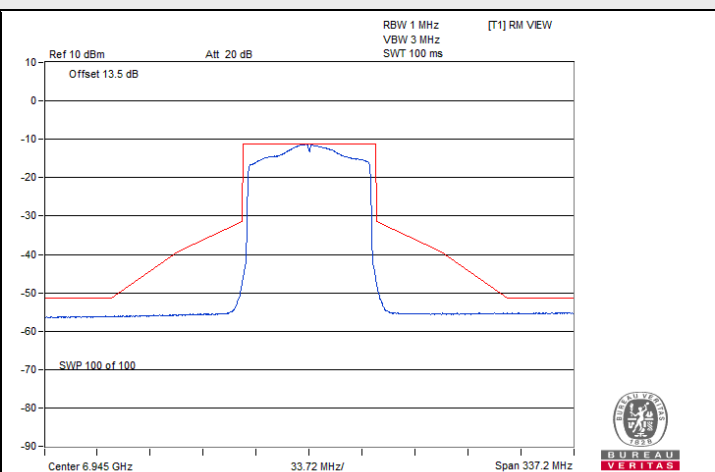

802.11be (EHT80) / Chain 0 : CH 199

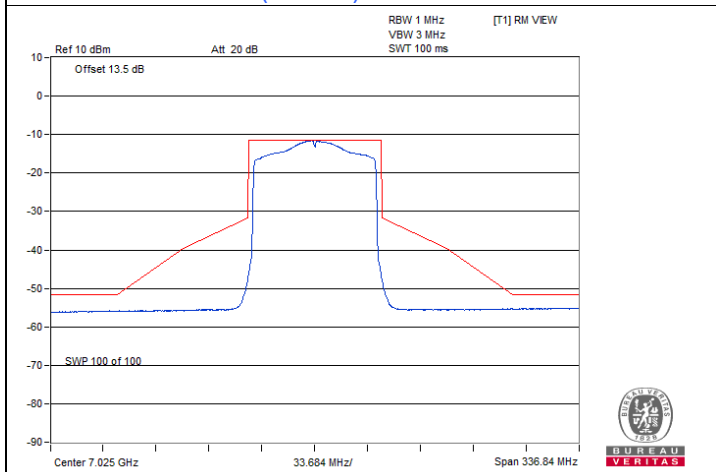

802.11be (EHT80) / Chain 0 : CH 215

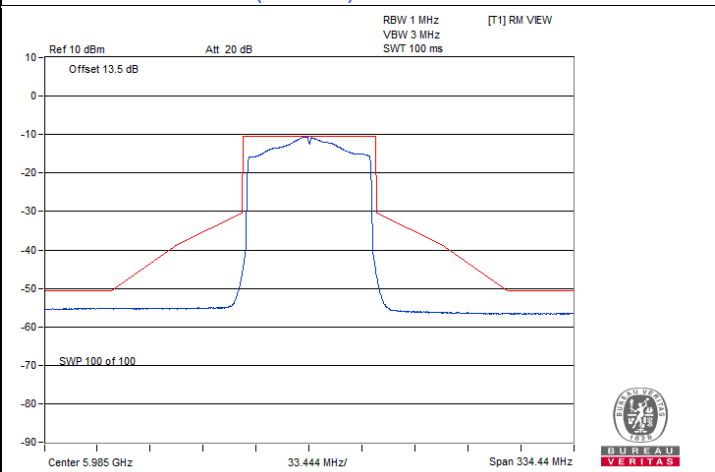

802.11be (EHT80) / Chain 1 : CH 7

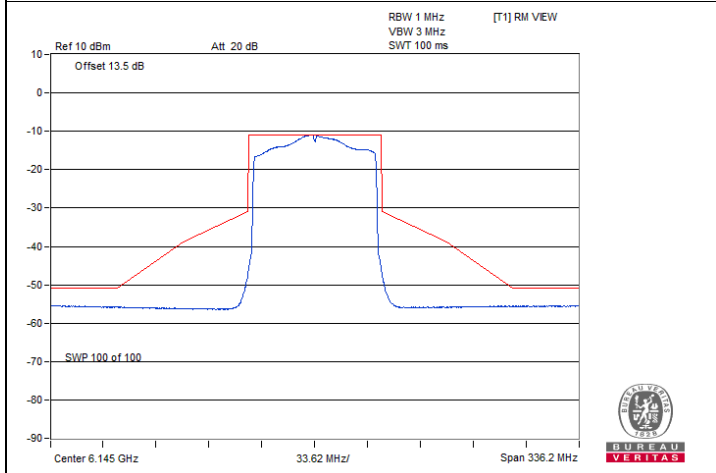

802.11be (EHT80) / Chain 1 : CH 39

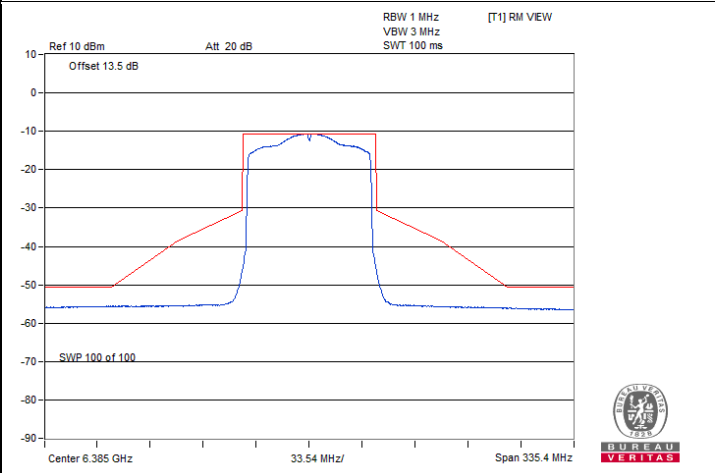

802.11be (EHT80) / Chain 1 : CH 87

Spectrum Plot

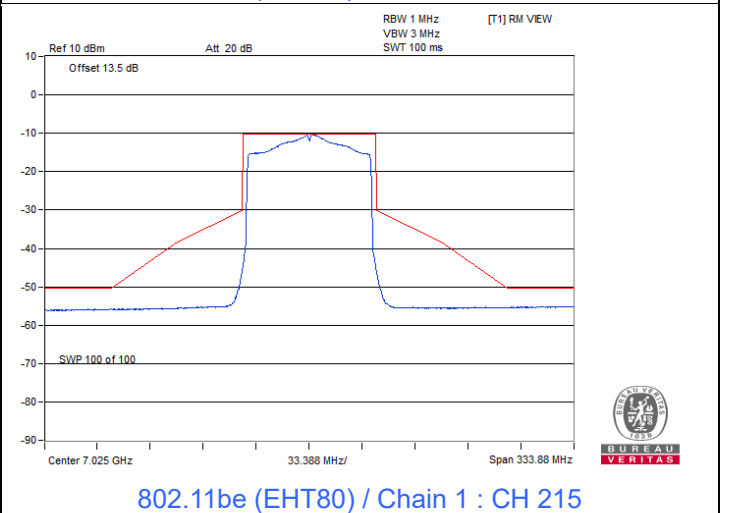
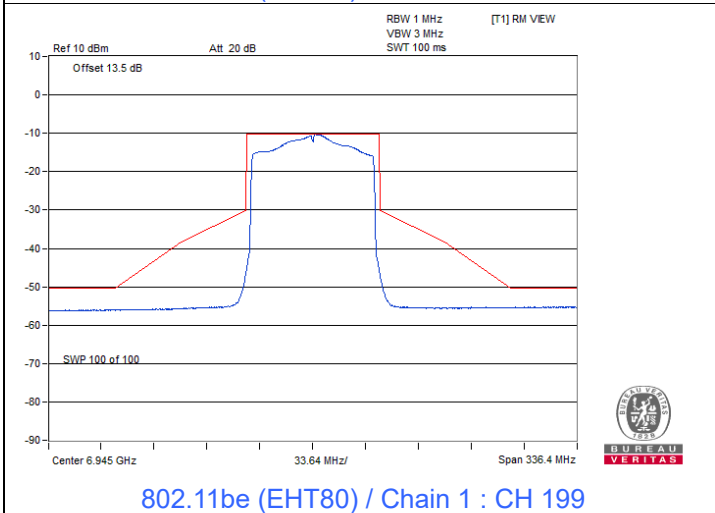
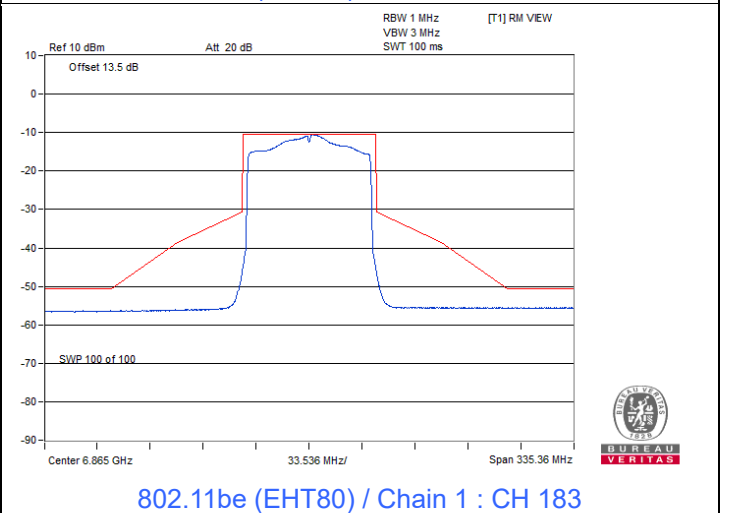
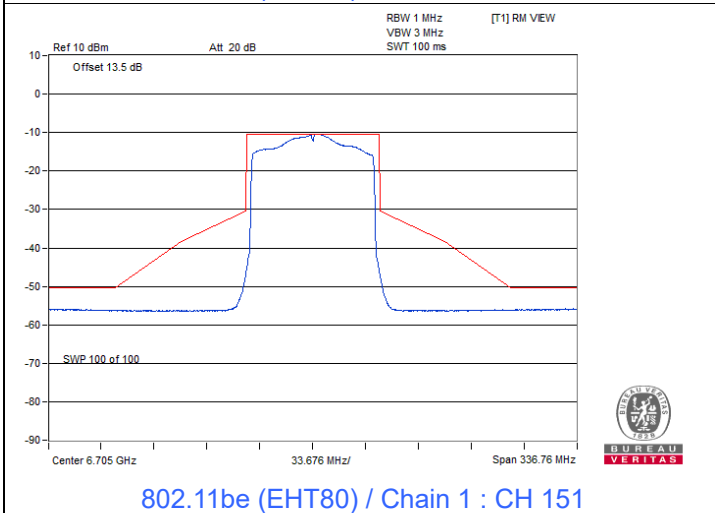
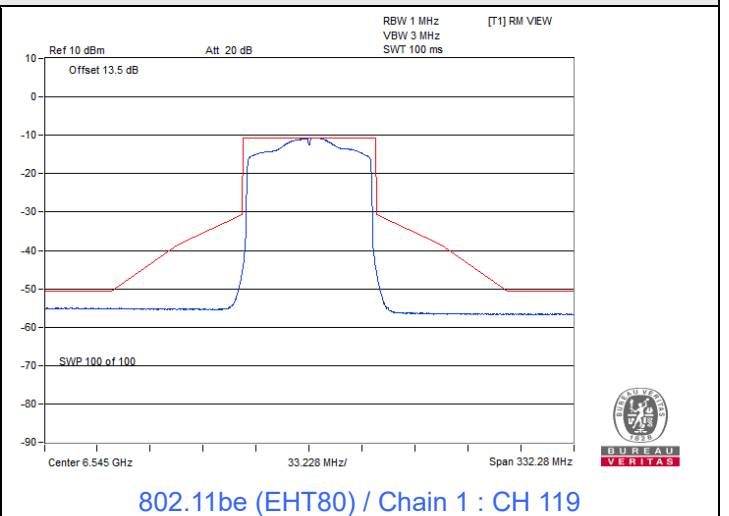
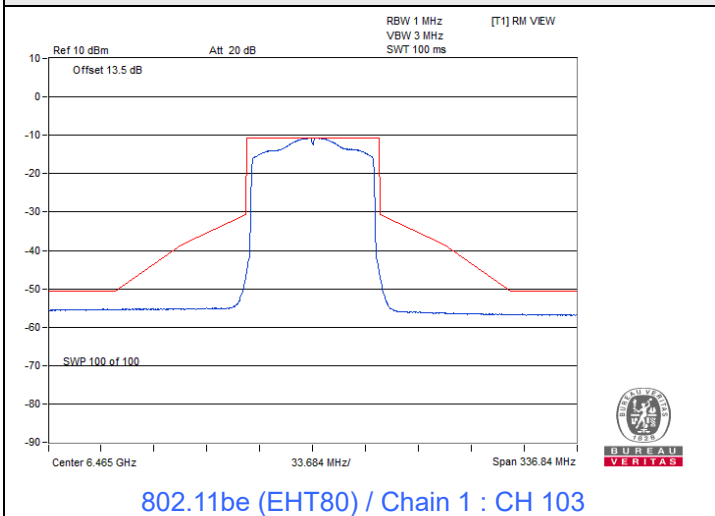

802.11be (EHT160)



Spectrum Plot

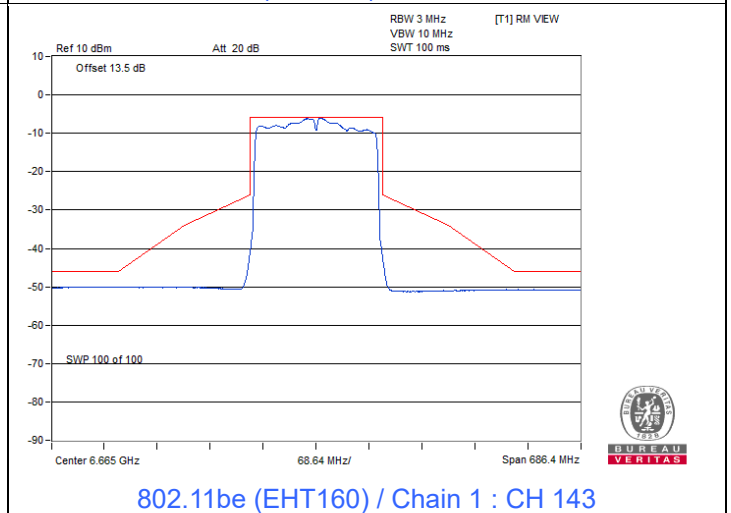
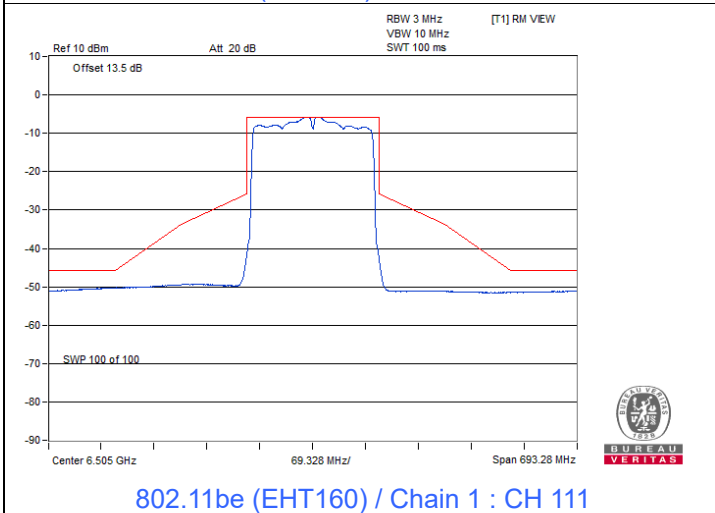
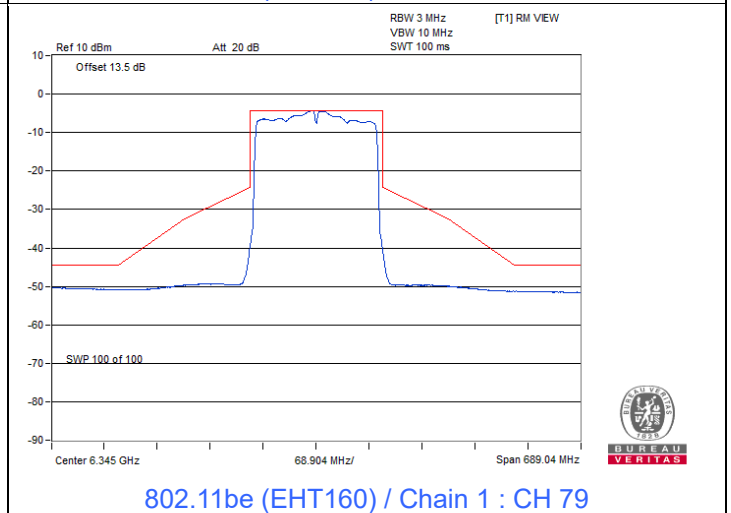
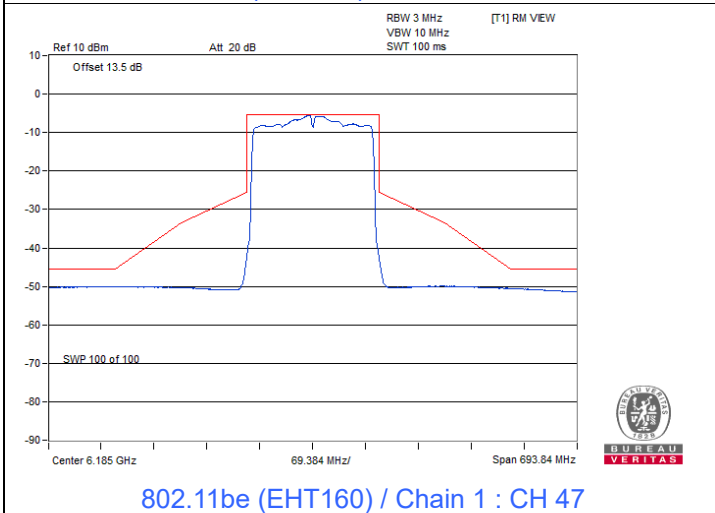
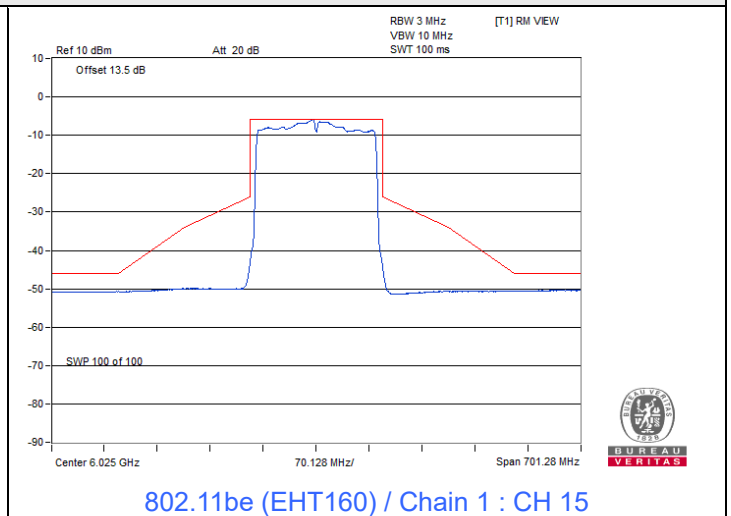
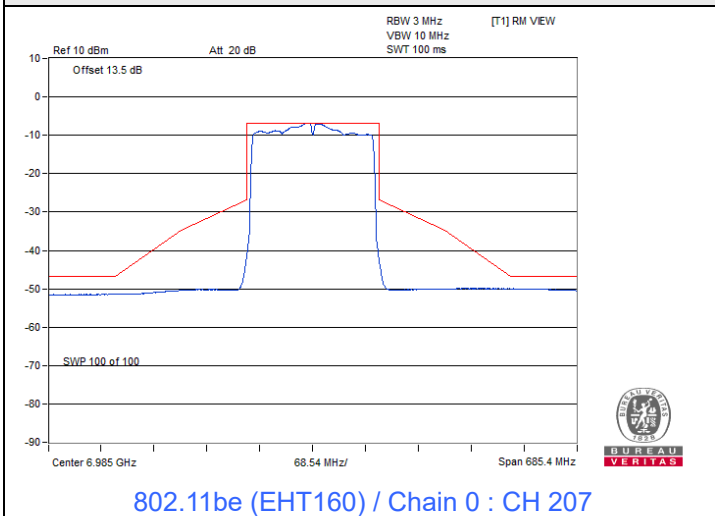

Spectrum Plot

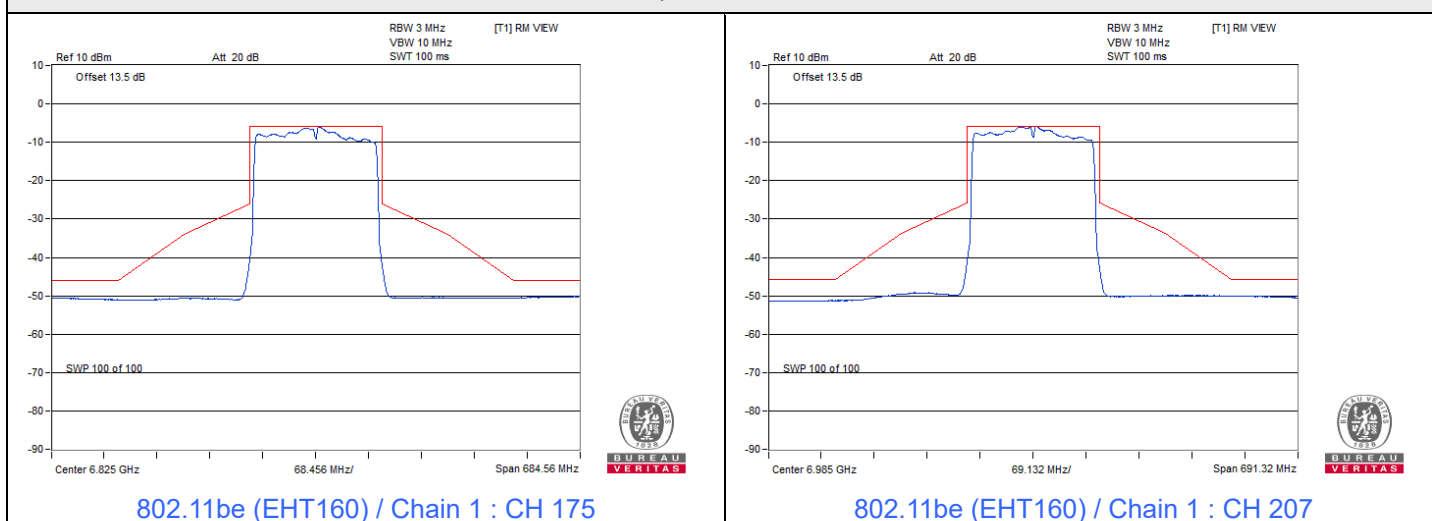

802.11be (EHT320)

Spectrum Plot

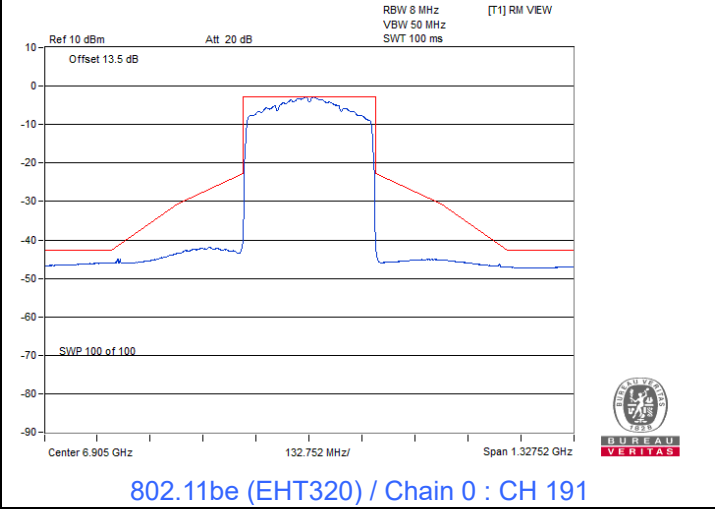
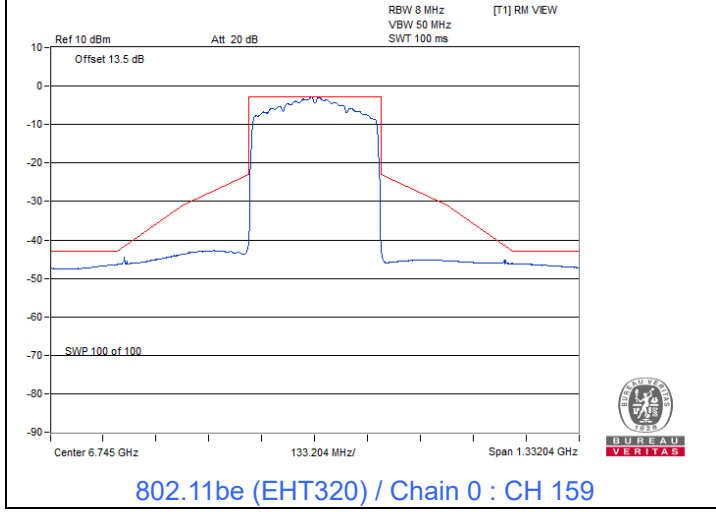
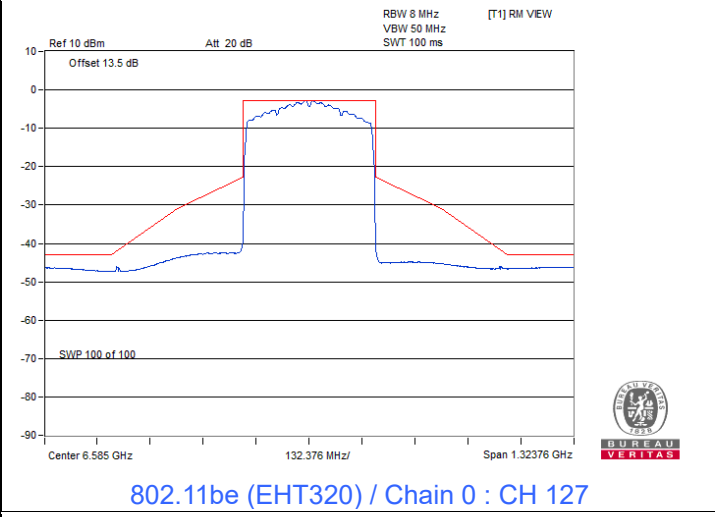
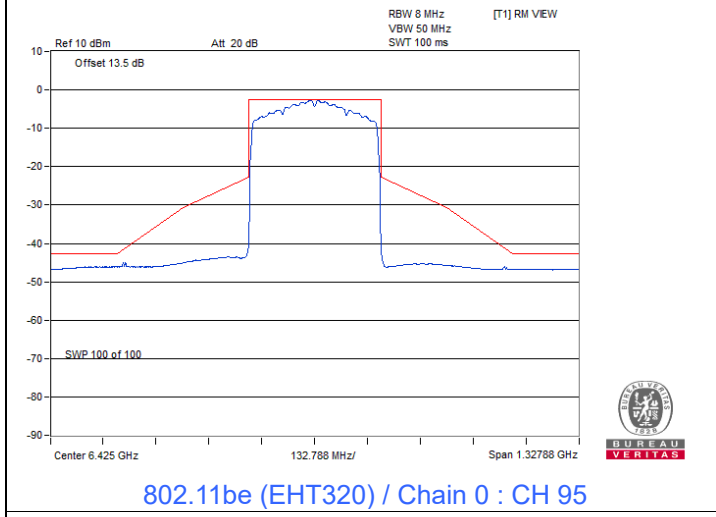
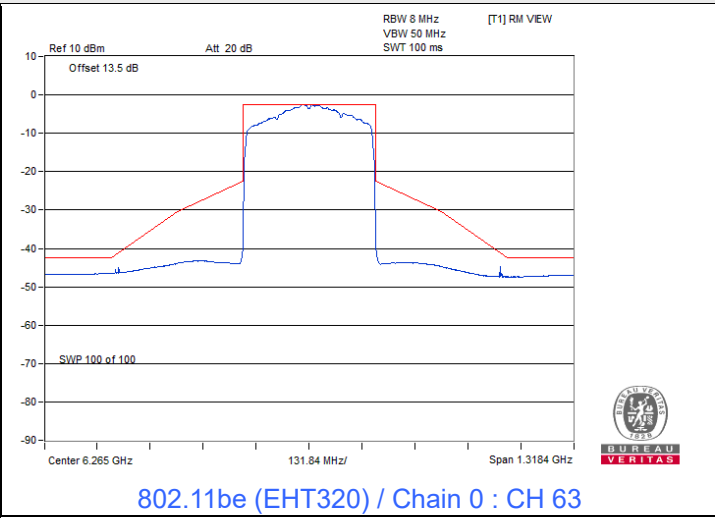
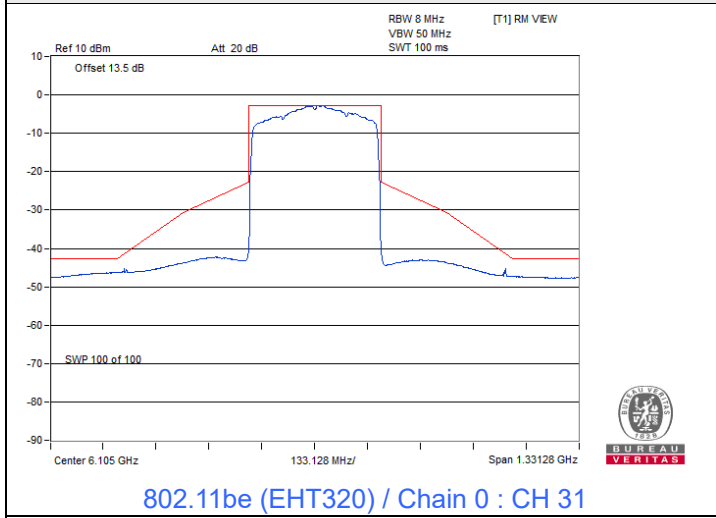

Spectrum Plot

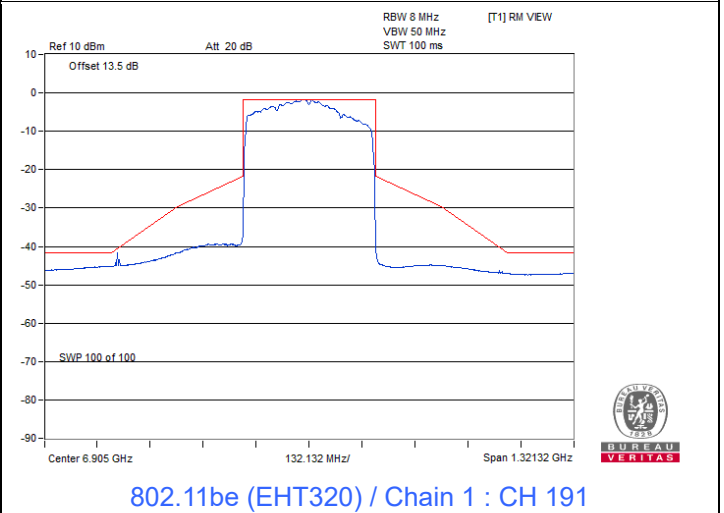
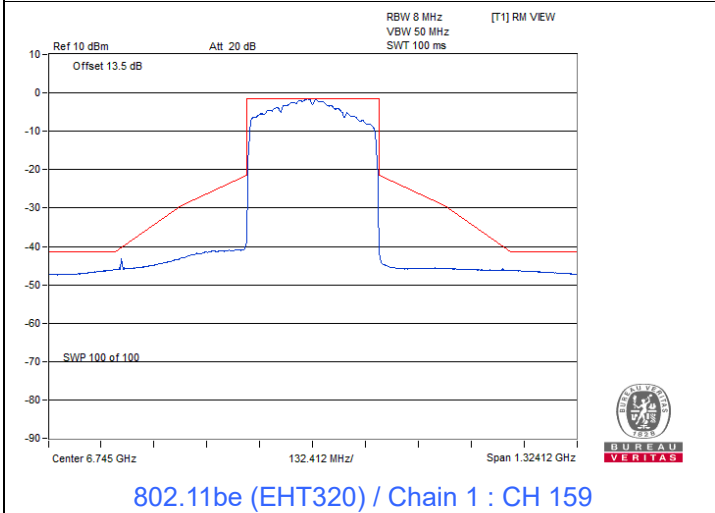
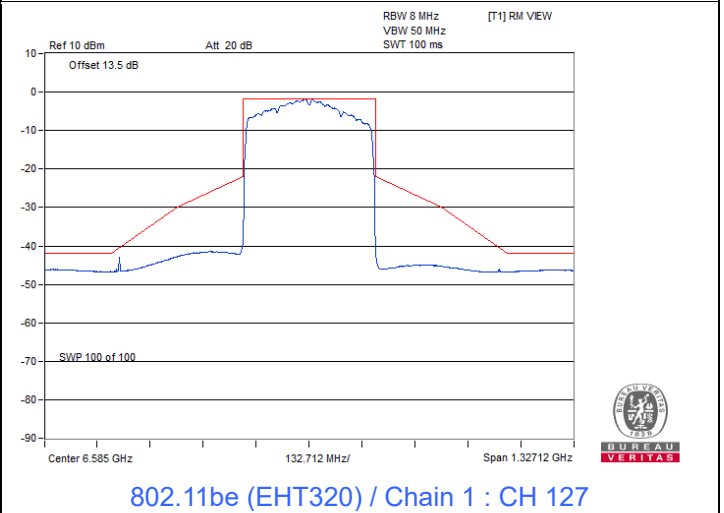
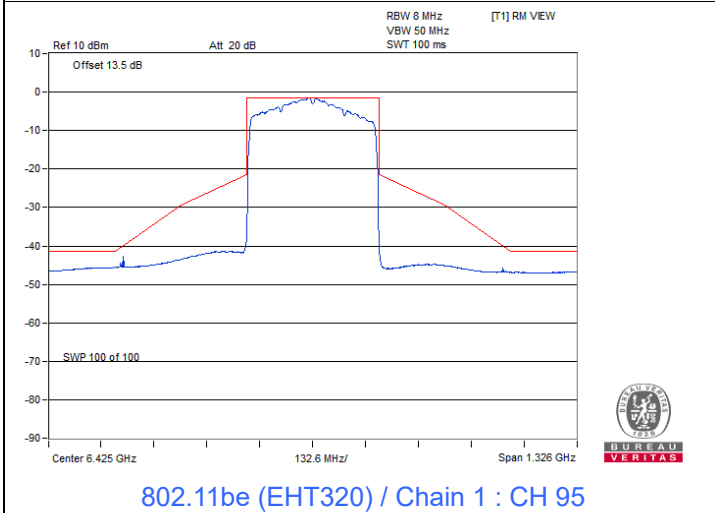
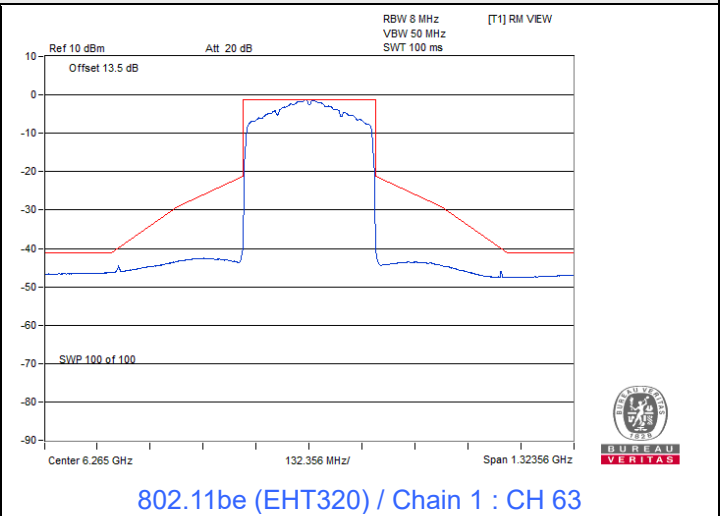
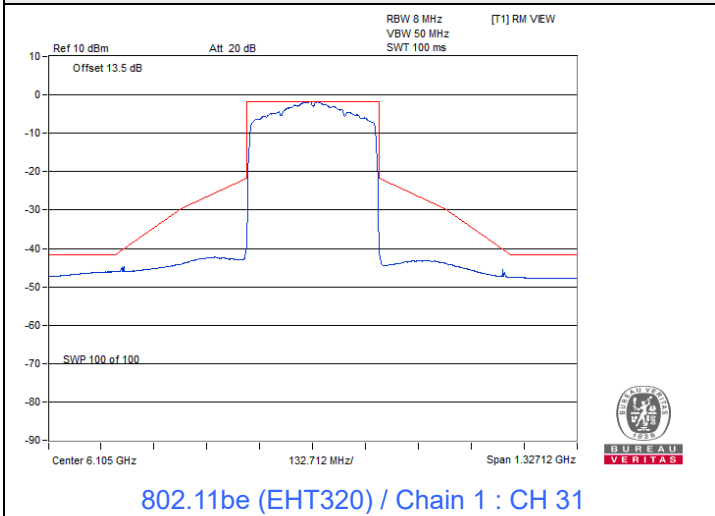

802.11be (EHT20) 26-tone RU

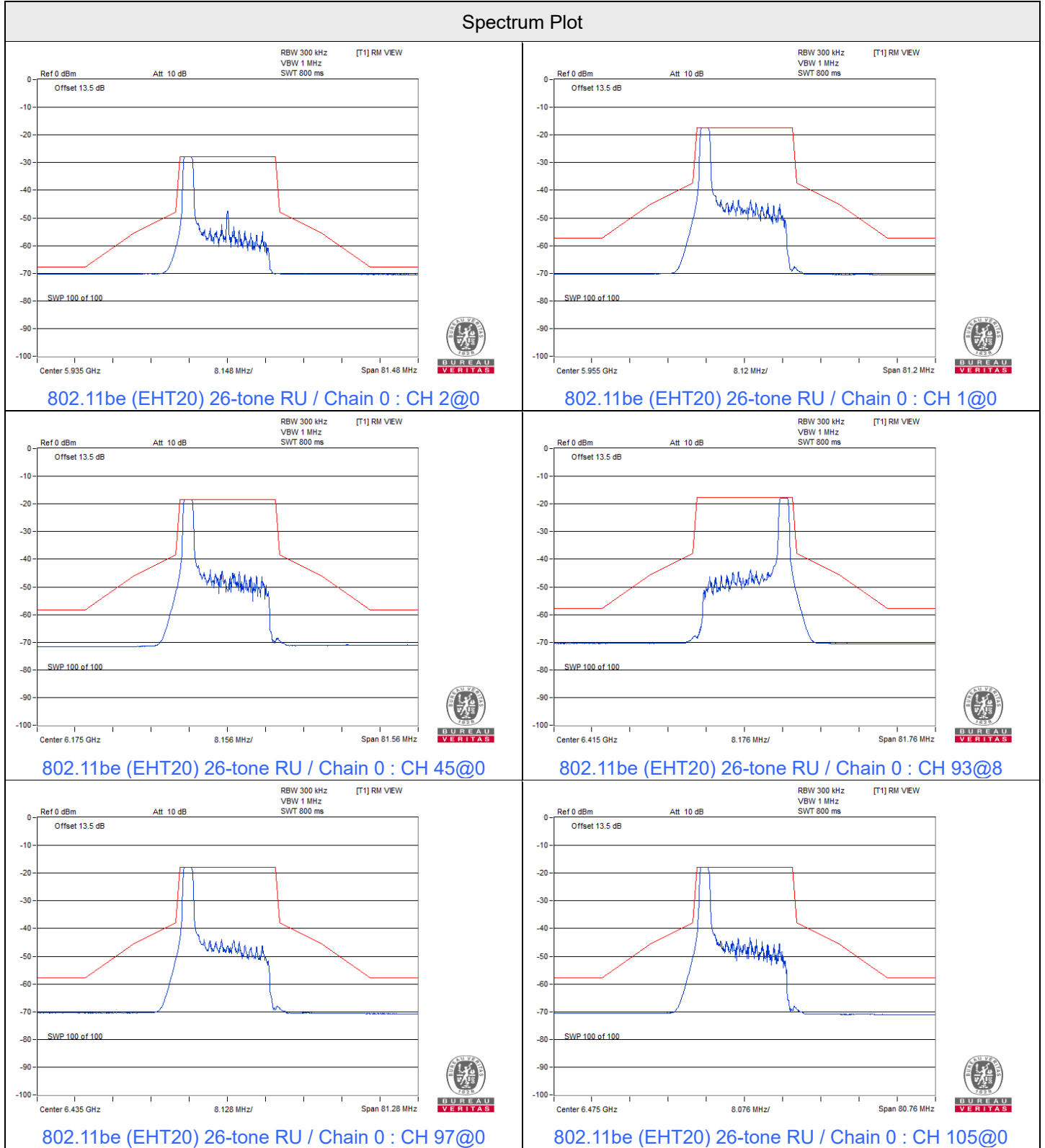

Spectrum Plot

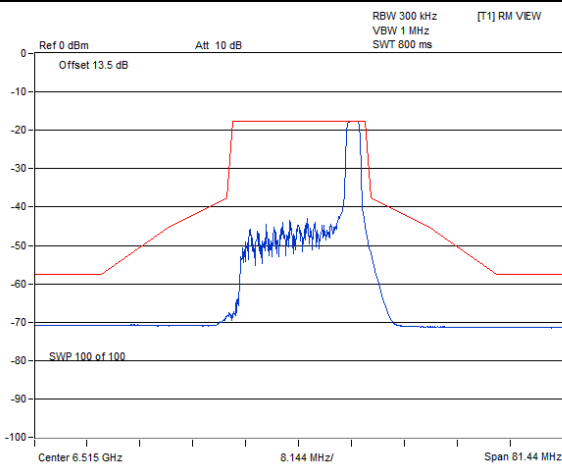

802.11be (EHT20) 26-tone RU / Chain 0 : CH 113@8

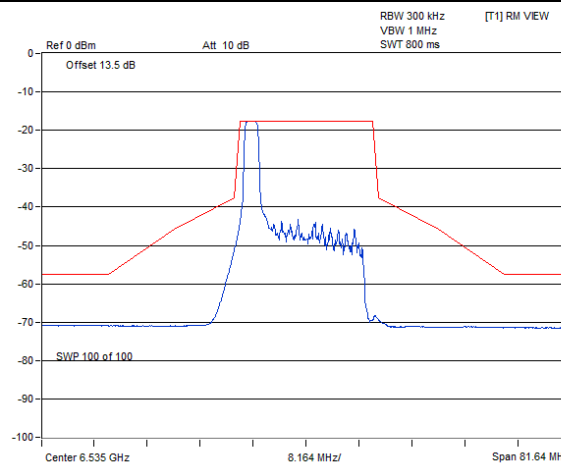

802.11be (EHT20) 26-tone RU / Chain 0 : CH 117@0

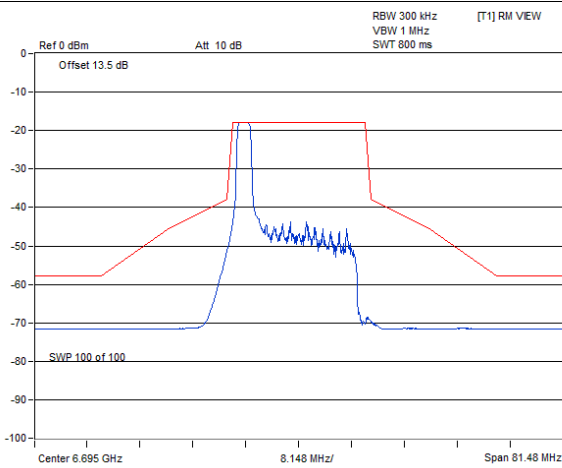

802.11be (EHT20) 26-tone RU / Chain 0 : CH 149@0

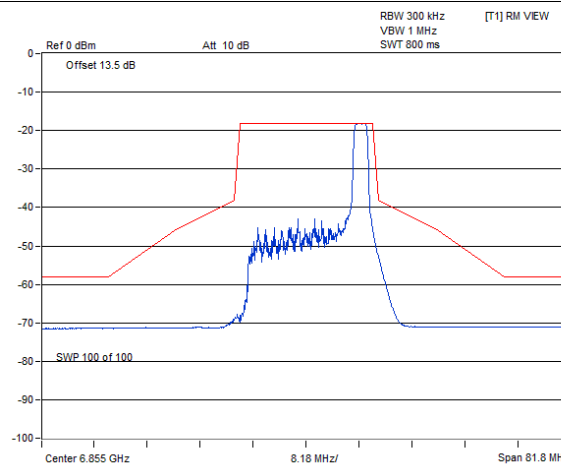

802.11be (EHT20) 26-tone RU / Chain 0 : CH 181@8

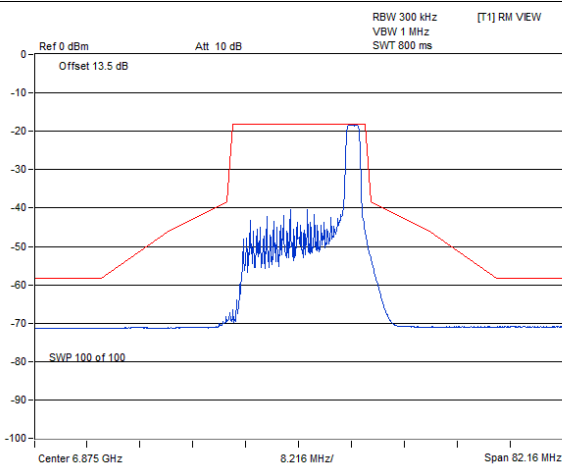

802.11be (EHT20) 26-tone RU / Chain 0 : CH 185@0

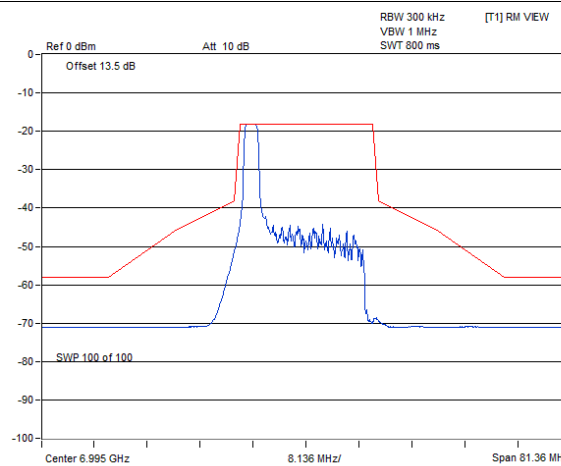

802.11be (EHT20) 26-tone RU / Chain 0 : CH 209@0

Spectrum Plot

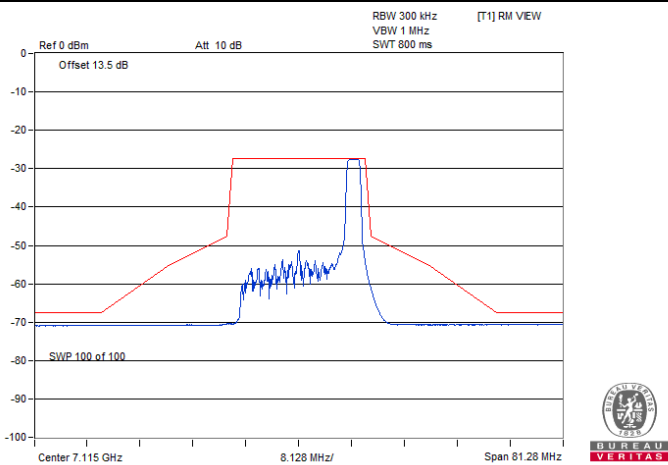

802.11be (EHT20) 26-tone RU / Chain 0 : CH 233@8

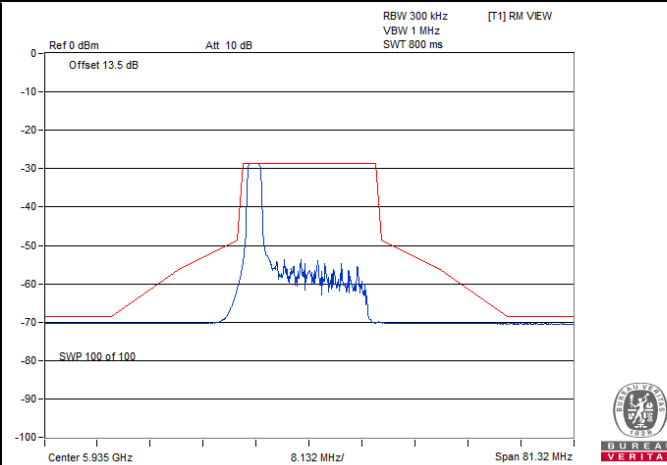

802.11be (EHT20) 26-tone RU / Chain 1 : CH 2@0

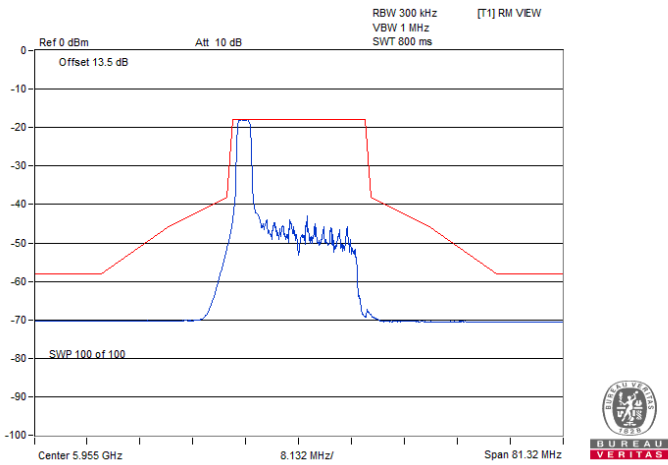

802.11be (EHT20) 26-tone RU / Chain 1 : CH 1@0

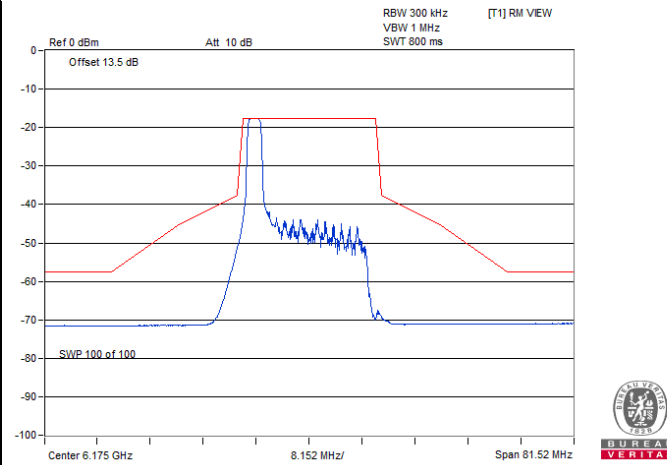

802.11be (EHT20) 26-tone RU / Chain 1 : CH 45@0

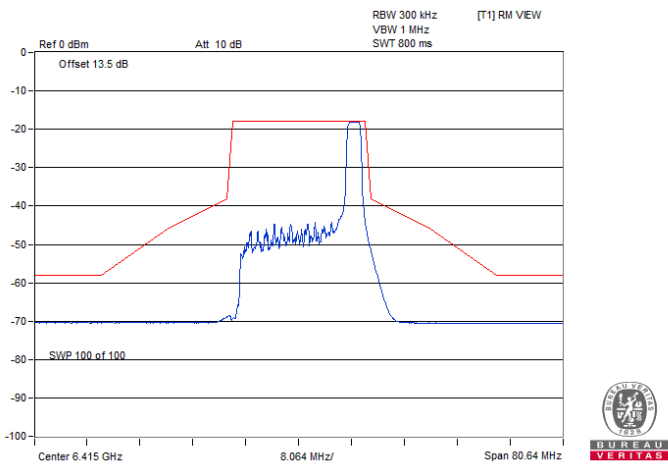

802.11be (EHT20) 26-tone RU / Chain 1 : CH 93@8

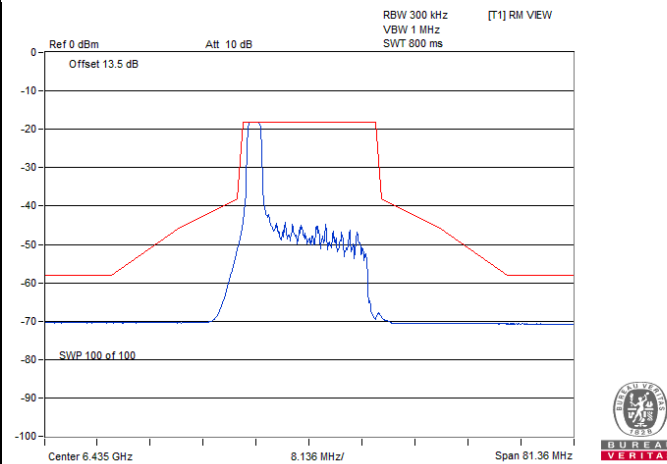

802.11be (EHT20) 26-tone RU / Chain 1 : CH 97@0

Spectrum Plot

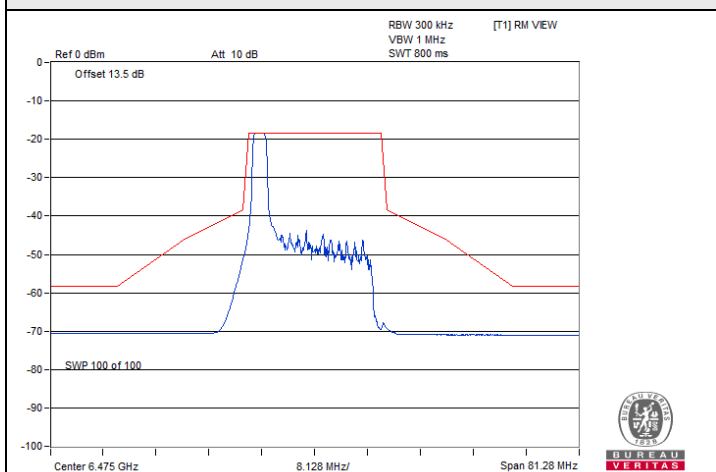

802.11be (EHT20) 26-tone RU / Chain 1 : CH 105@0

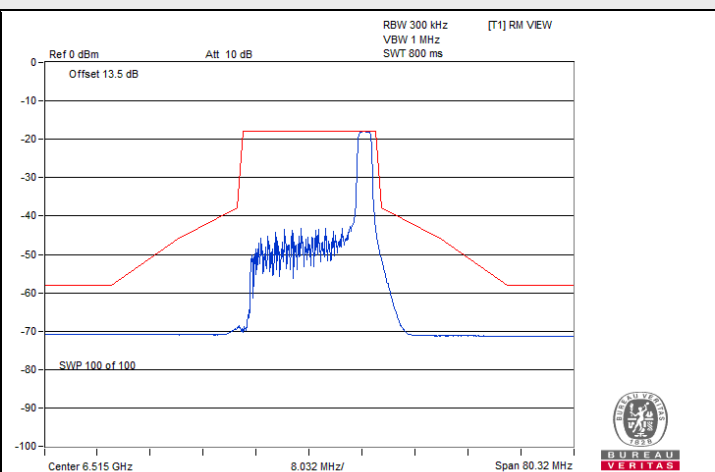

802.11be (EHT20) 26-tone RU / Chain 1 : CH 113@8

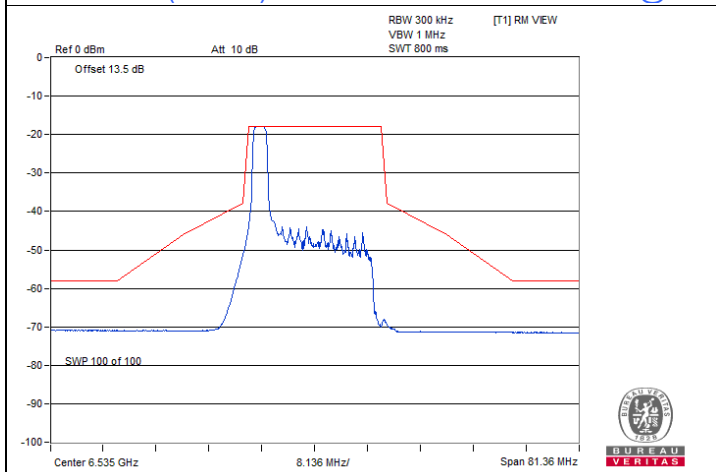

802.11be (EHT20) 26-tone RU / Chain 1 : CH 117@0

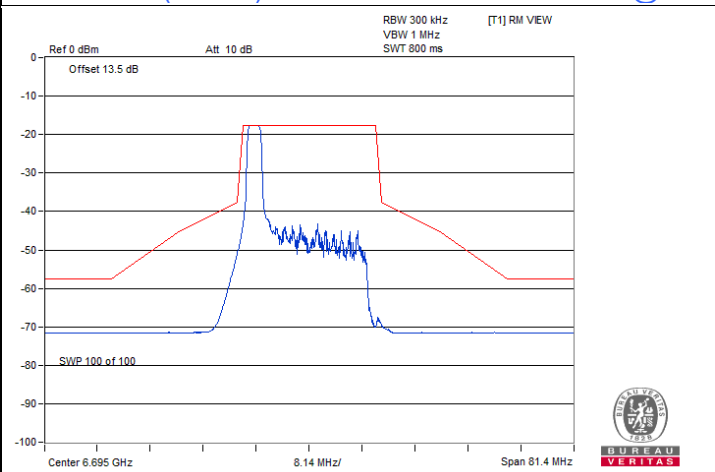

802.11be (EHT20) 26-tone RU / Chain 1 : CH 149@0

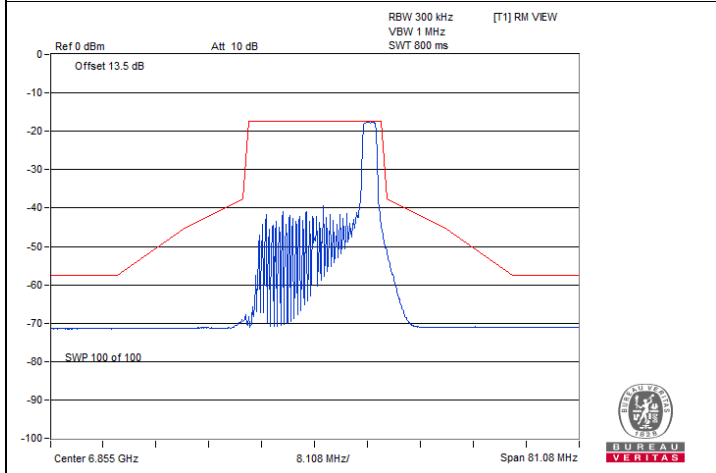

802.11be (EHT20) 26-tone RU / Chain 1 : CH 181@8

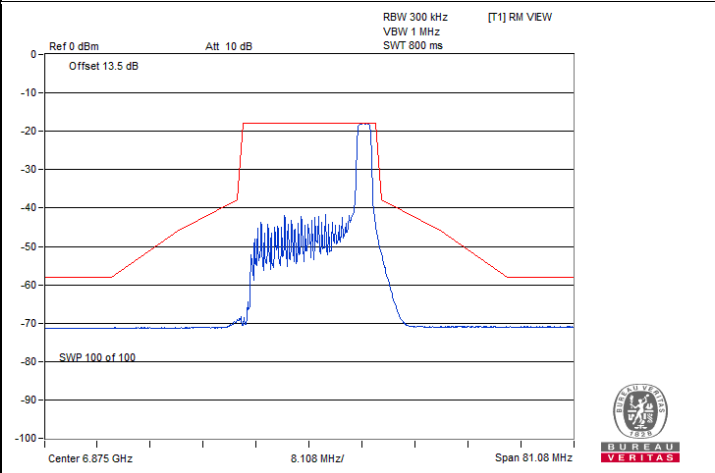

802.11be (EHT20) 26-tone RU / Chain 1 : CH 185@0

Spectrum Plot

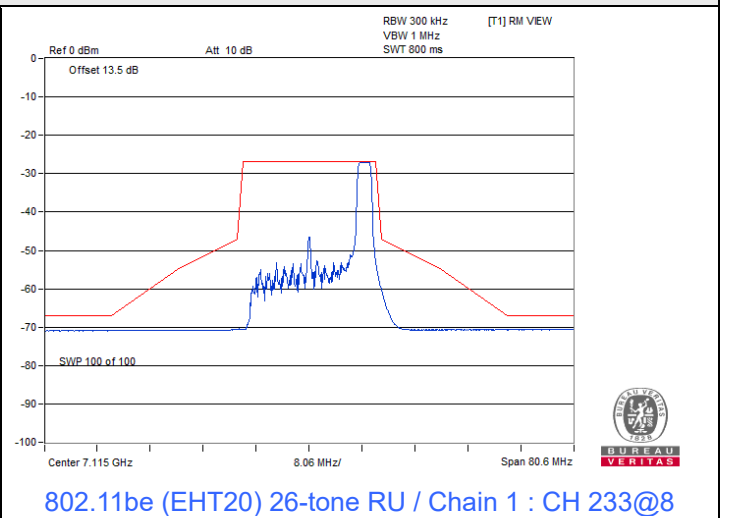
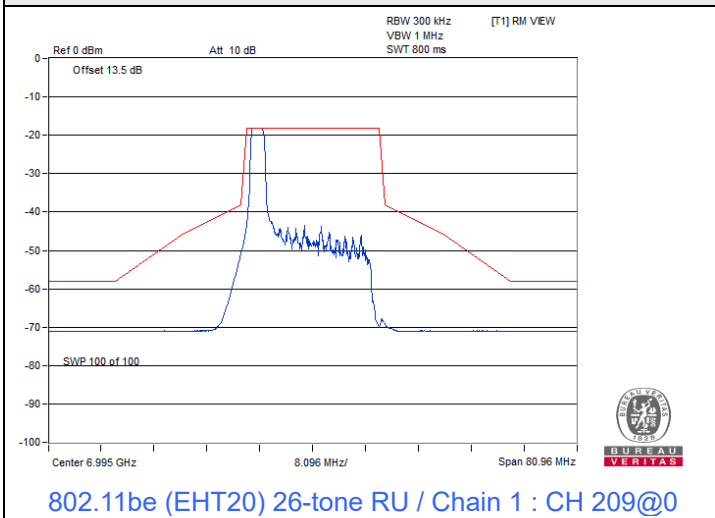

802.11be (EHT20) 52-tone RU

Spectrum Plot

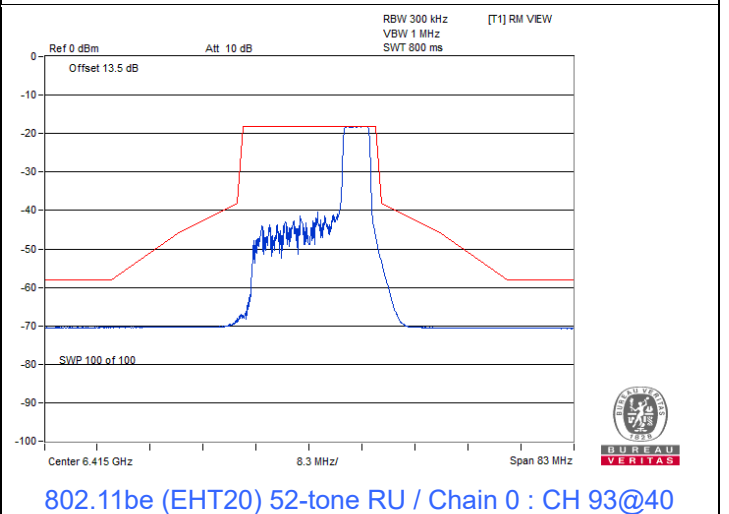
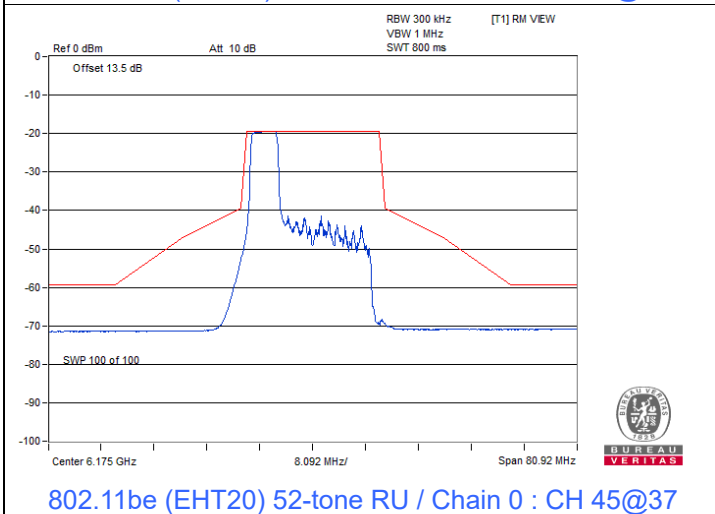
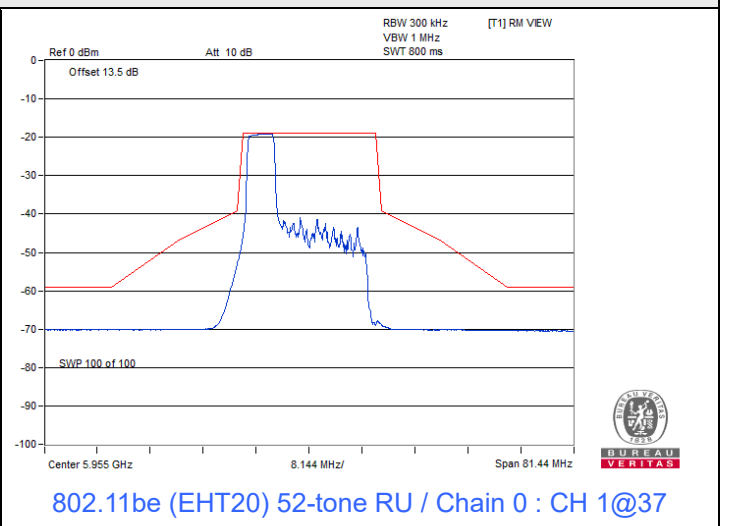
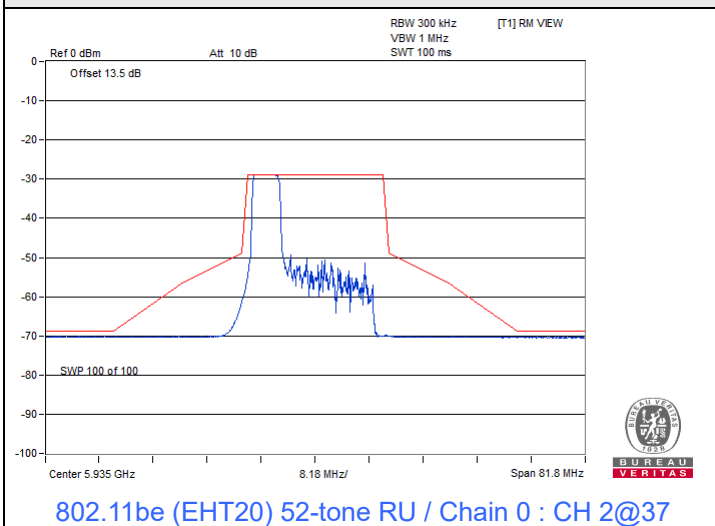

Spectrum Plot

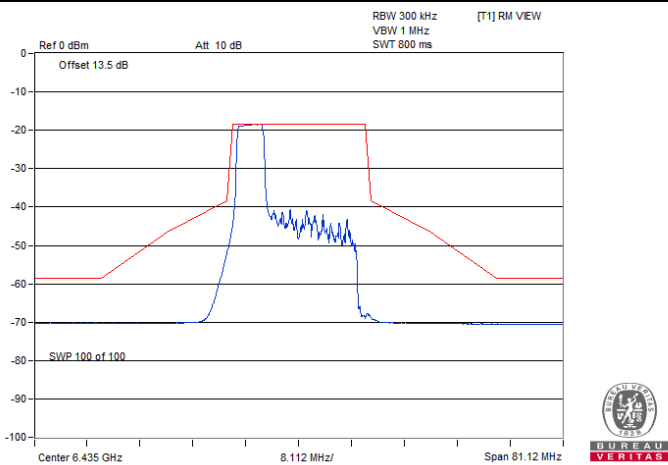

802.11be (EHT20) 52-tone RU / Chain 0 : CH 97@37

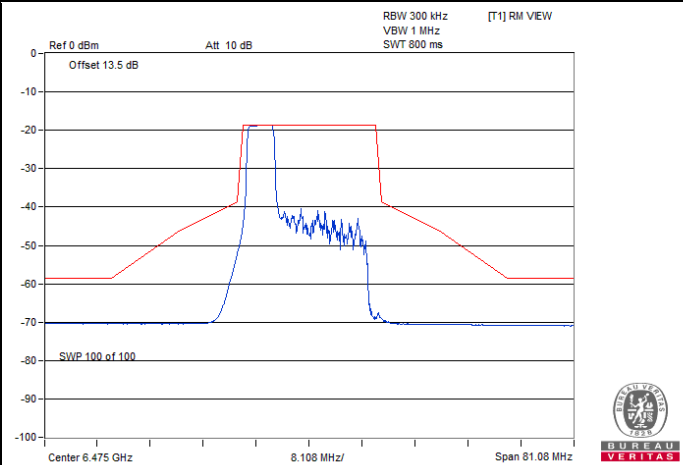

802.11be (EHT20) 52-tone RU / Chain 0 : CH 105@37

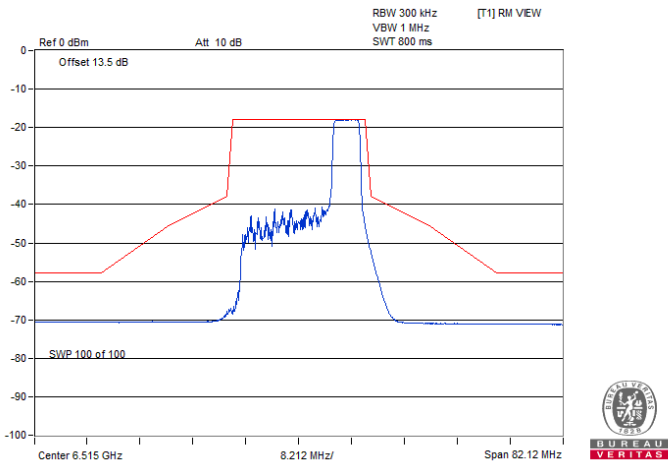

802.11be (EHT20) 52-tone RU / Chain 0 : CH 113@40

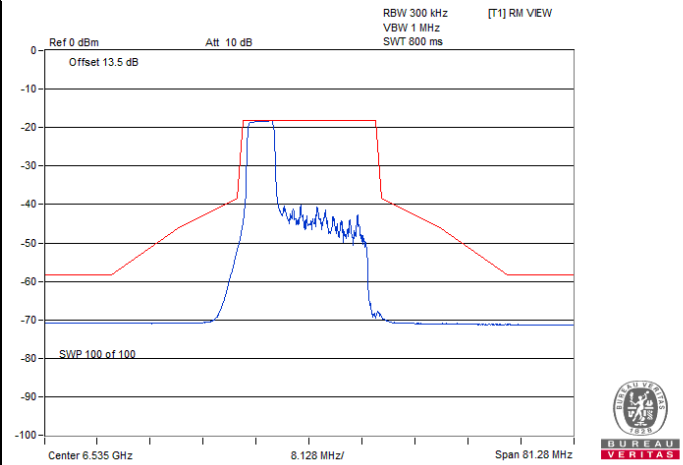

802.11be (EHT20) 52-tone RU / Chain 0 : CH 117@37

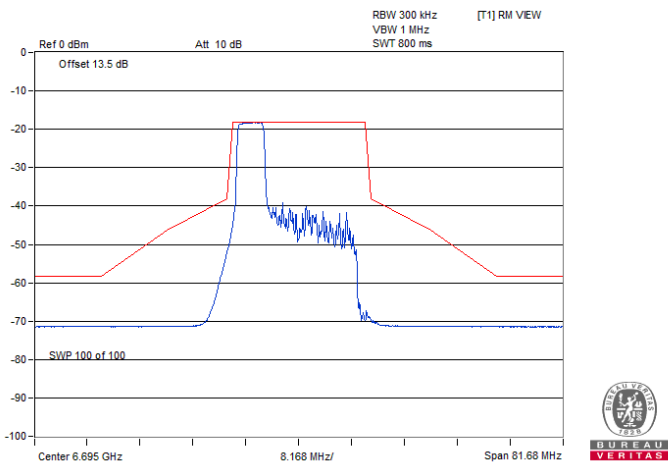

802.11be (EHT20) 52-tone RU / Chain 0 : CH 149@37

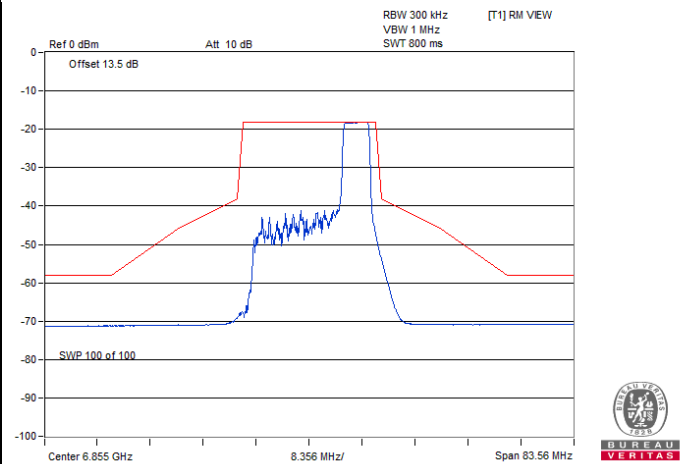

802.11be (EHT20) 52-tone RU / Chain 0 : CH 181@40

Spectrum Plot

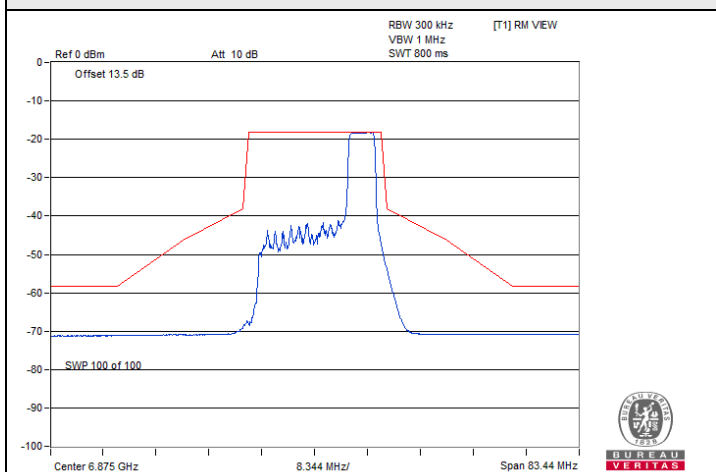

802.11be (EHT20) 52-tone RU / Chain 0 : CH 185@37

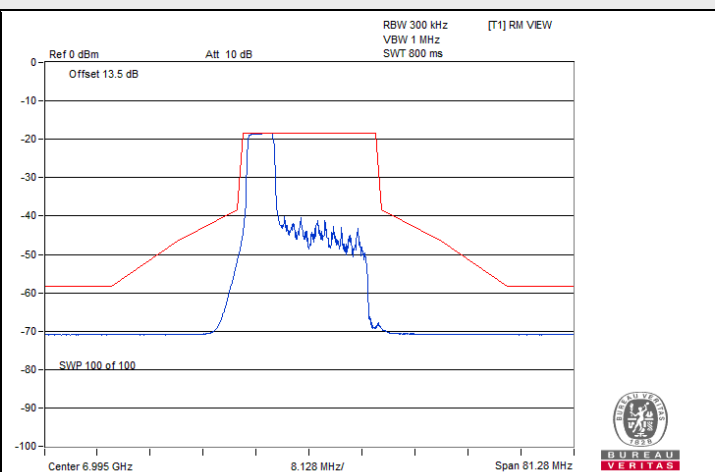

802.11be (EHT20) 52-tone RU / Chain 0 : CH 209@37

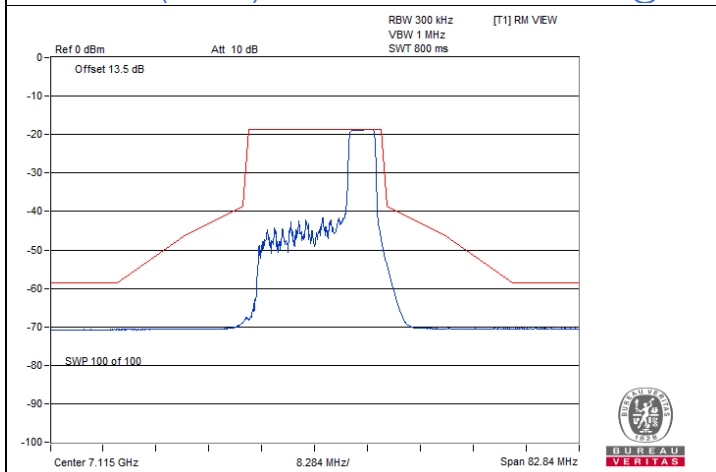

802.11be (EHT20) 52-tone RU / Chain 0 : CH 233@40

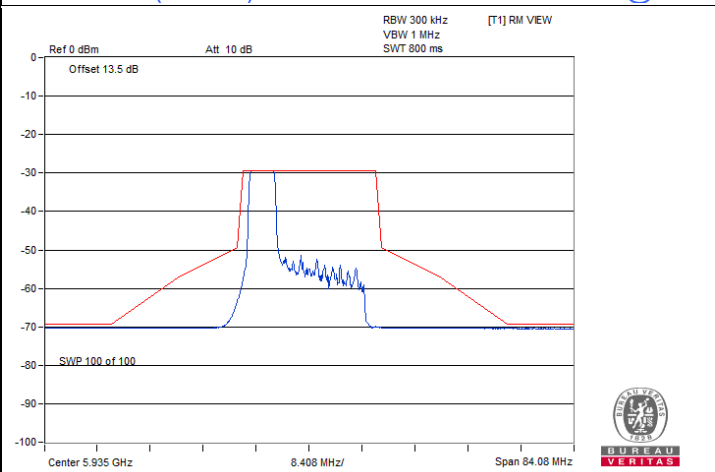

802.11be (EHT20) 52-tone RU / Chain 1 : CH 2@0

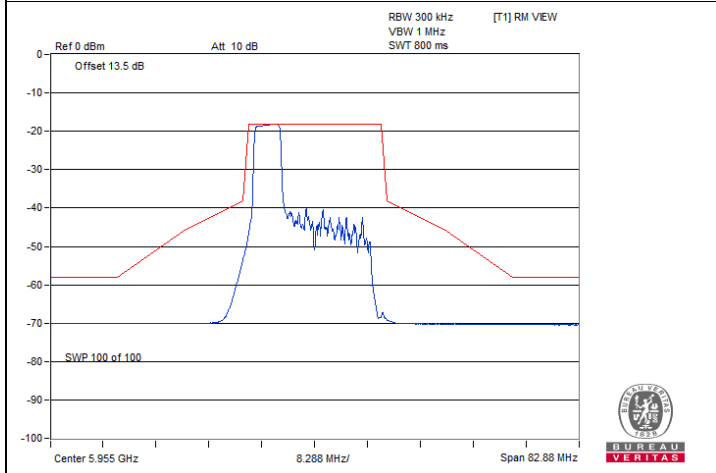

802.11be (EHT20) 52-tone RU / Chain 1 : CH 1@37

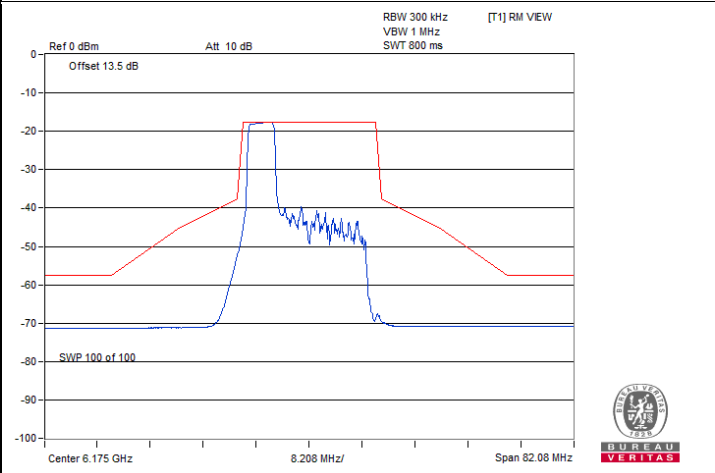

802.11be (EHT20) 52-tone RU / Chain 1 : CH 45@37

Spectrum Plot

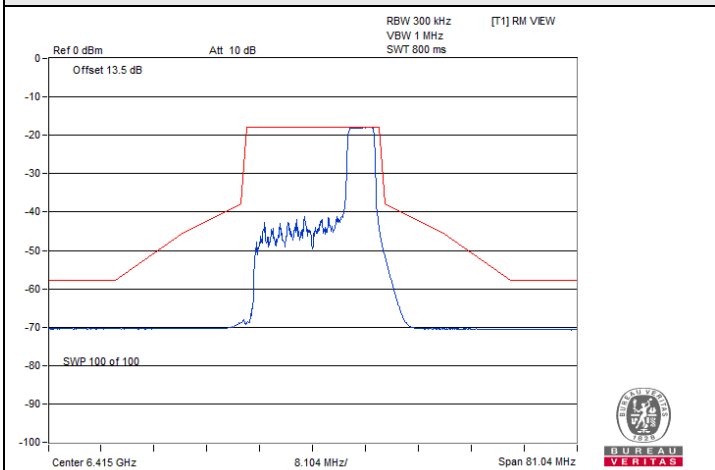

802.11be (EHT20) 52-tone RU / Chain 1 : CH 93@40

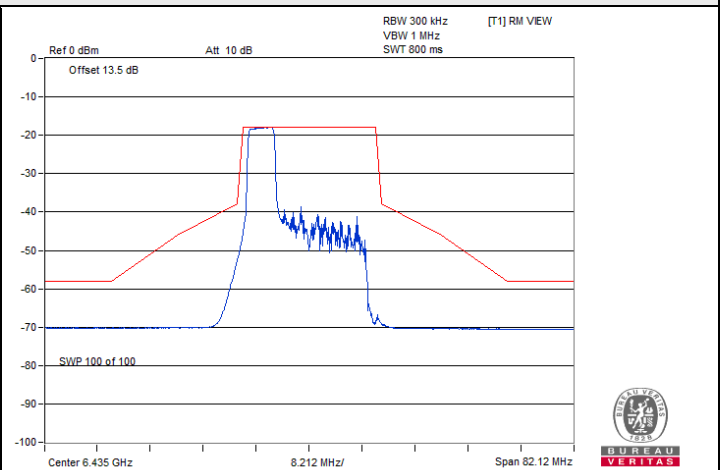

802.11be (EHT20) 52-tone RU / Chain 1 : CH 97@37

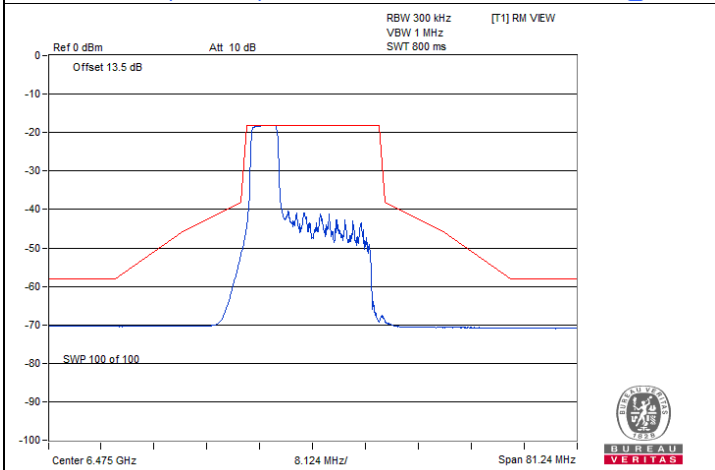

802.11be (EHT20) 52-tone RU / Chain 1 : CH 105@37

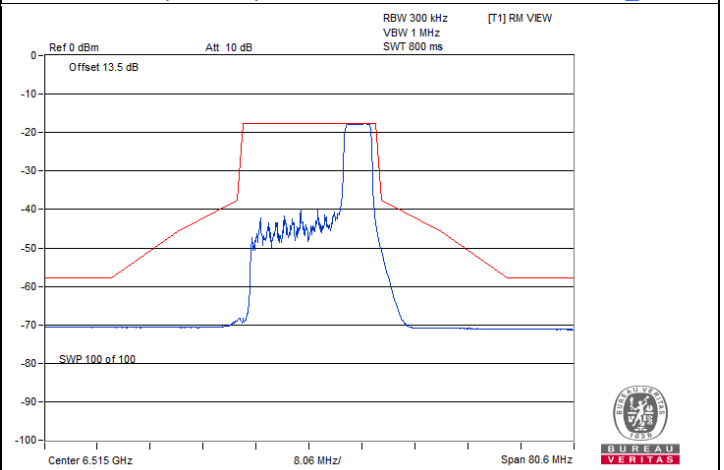

802.11be (EHT20) 52-tone RU / Chain 1 : CH 113@40

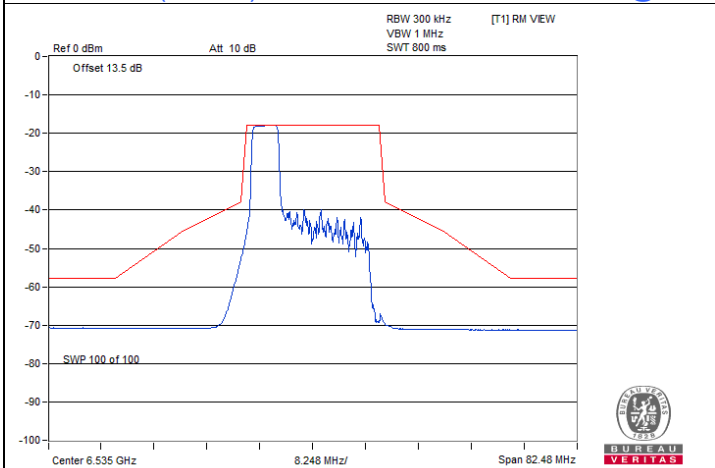

802.11be (EHT20) 52-tone RU / Chain 1 : CH 117@37

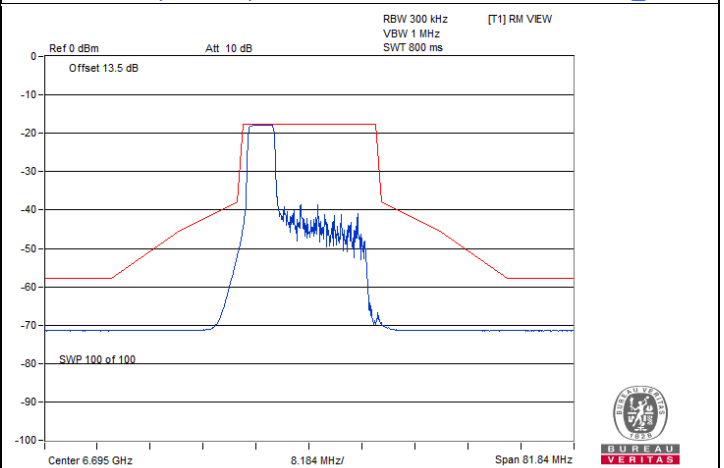

802.11be (EHT20) 52-tone RU / Chain 1 : CH 149@37

Spectrum Plot

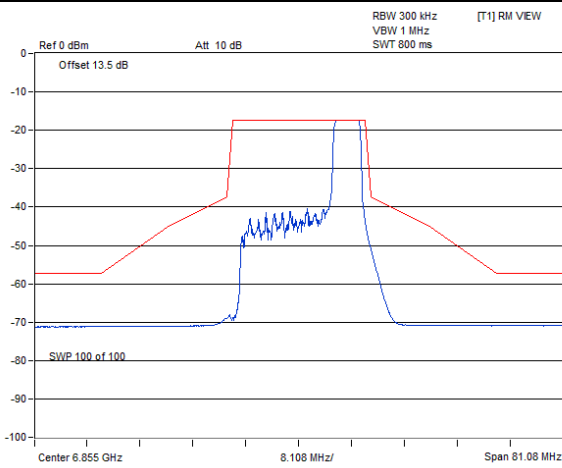

802.11be (EHT20) 52-tone RU / Chain 1 : CH 181@40

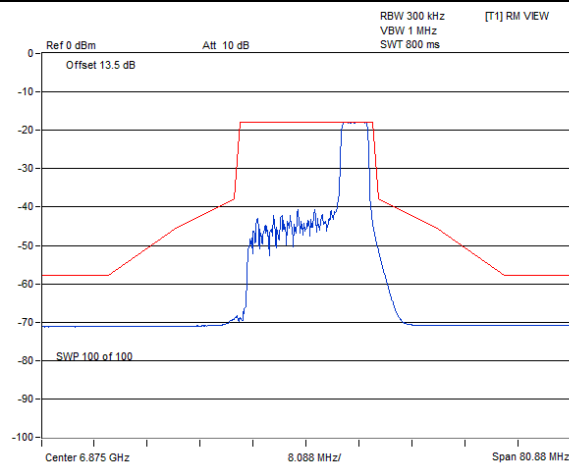

802.11be (EHT20) 52-tone RU / Chain 1 : CH 185@37

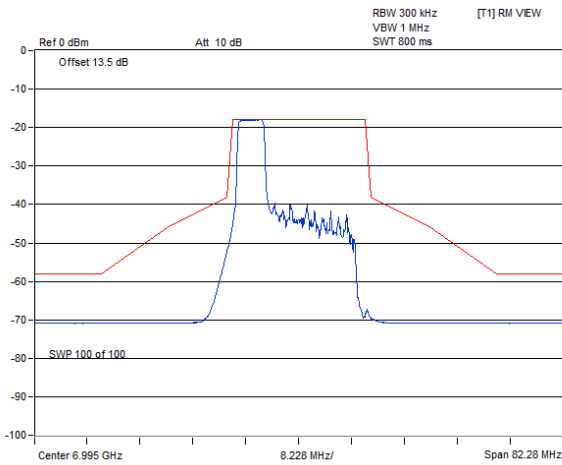

802.11be (EHT20) 52-tone RU / Chain 1 : CH 209@37

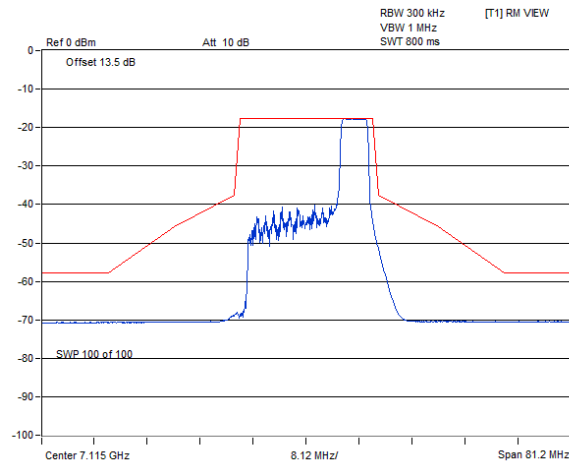

802.11be (EHT20) 52-tone RU / Chain 1 : CH 233@40

802.11be (EHT20) 106-tone RU

Spectrum Plot

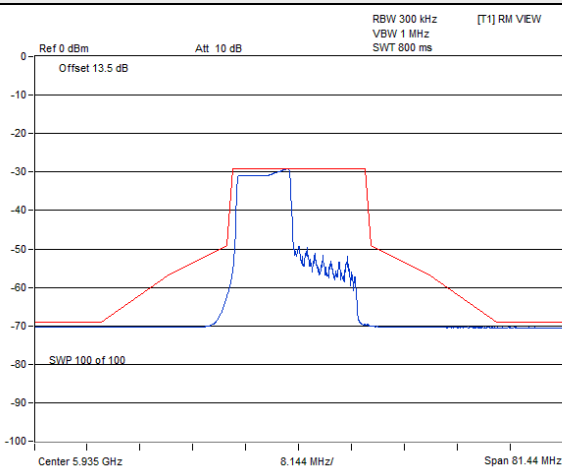

802.11be (EHT20) 106-tone RU / Chain 0 : CH 2@53

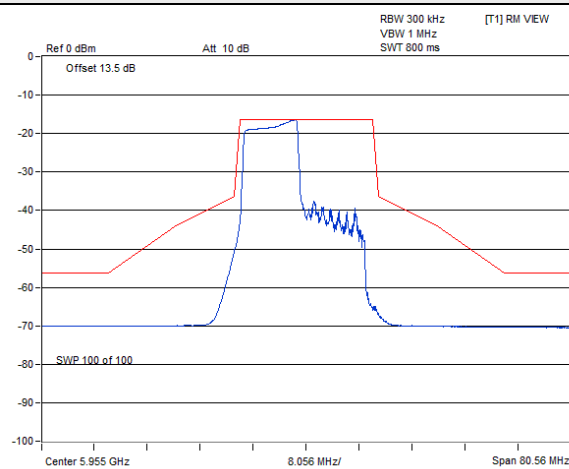

802.11be (EHT20) 106-tone RU / Chain 0 : CH 1@53

Spectrum Plot

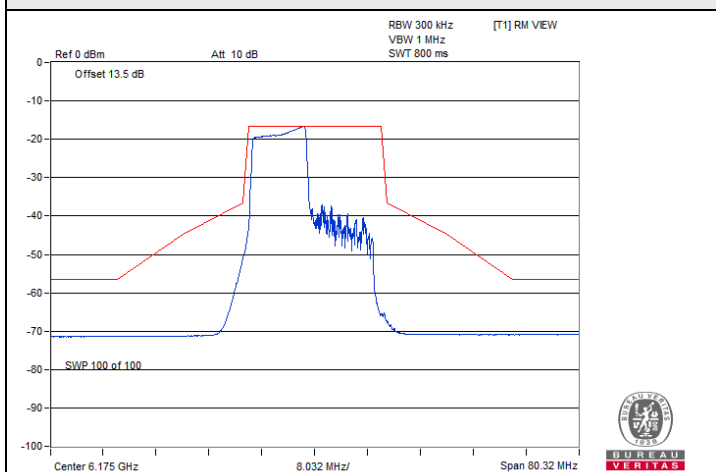

802.11be (EHT20) 106-tone RU / Chain 0 : CH 45@53

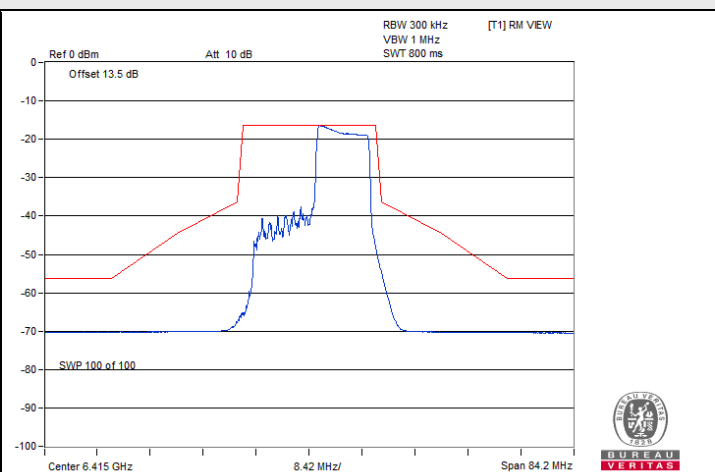

802.11be (EHT20) 106-tone RU / Chain 0 : CH 93@54

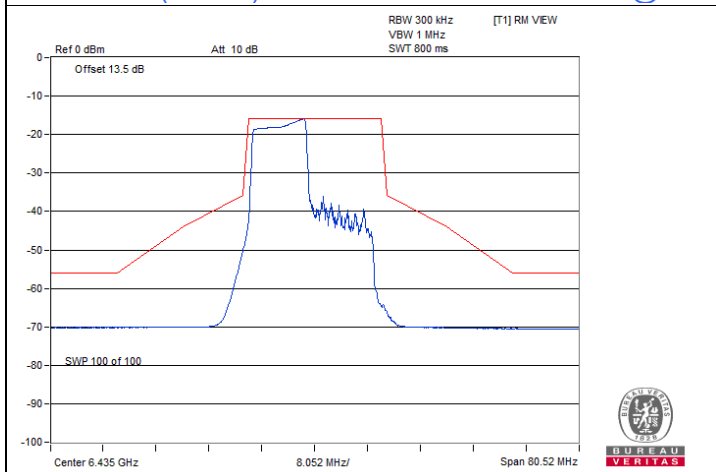

802.11be (EHT20) 106-tone RU / Chain 0 : CH 97@53

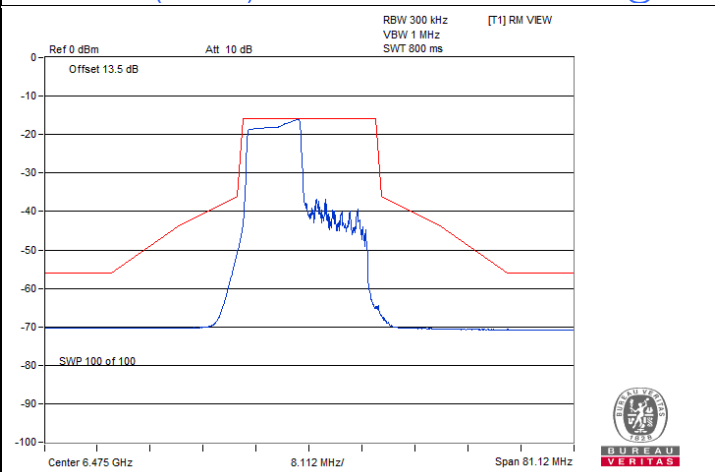

802.11be (EHT20) 106-tone RU / Chain 0 : CH 105@53

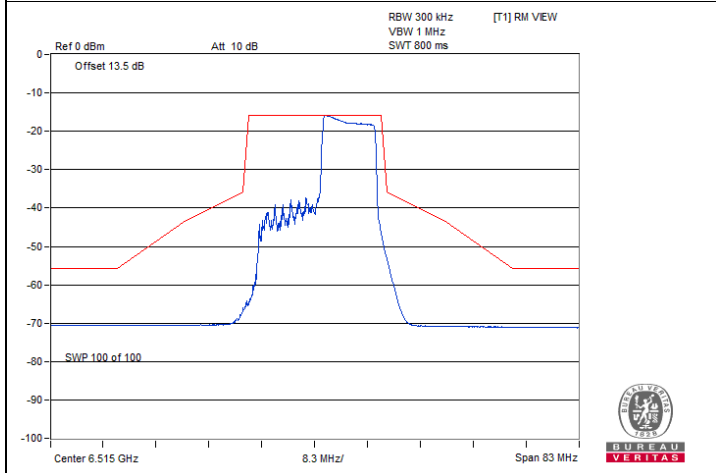

802.11be (EHT20) 106-tone RU / Chain 0 : CH 113@54

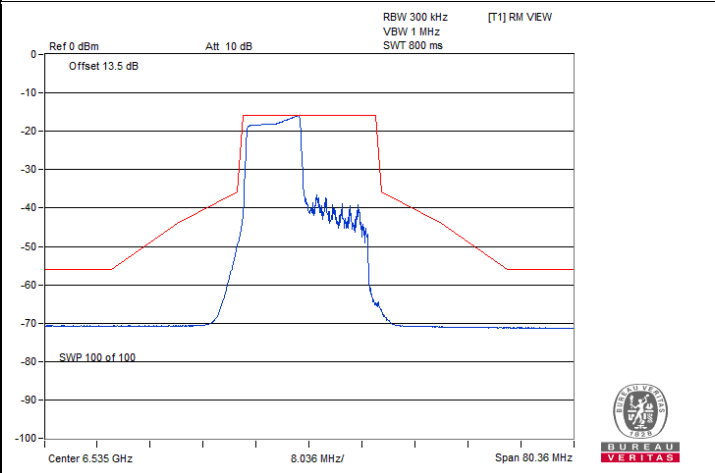

802.11be (EHT20) 106-tone RU / Chain 0 : CH 117@53

Spectrum Plot

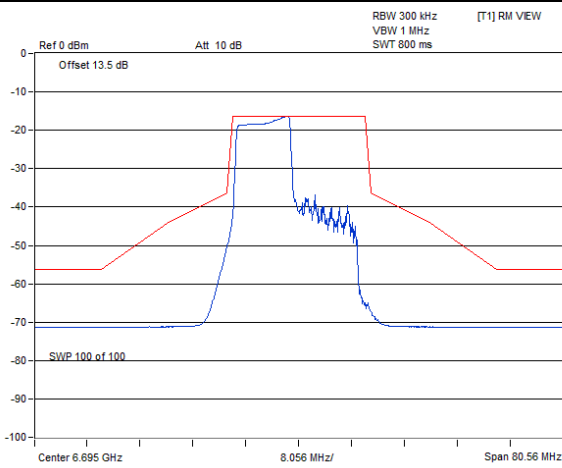

802.11be (EHT20) 106-tone RU / Chain 0 : CH 149@53

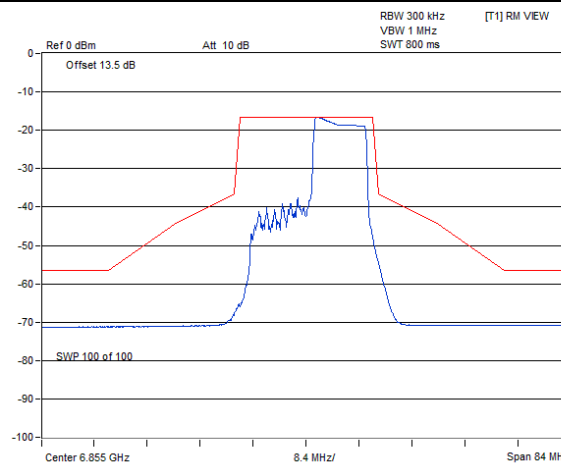

802.11be (EHT20) 106-tone RU / Chain 0 : CH 181@54

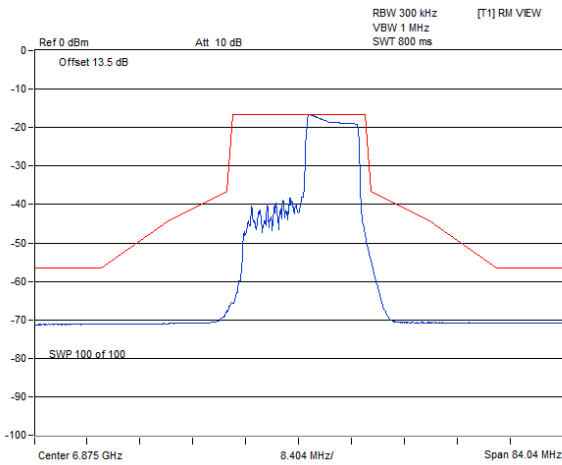

802.11be (EHT20) 106-tone RU / Chain 0 : CH 185@53

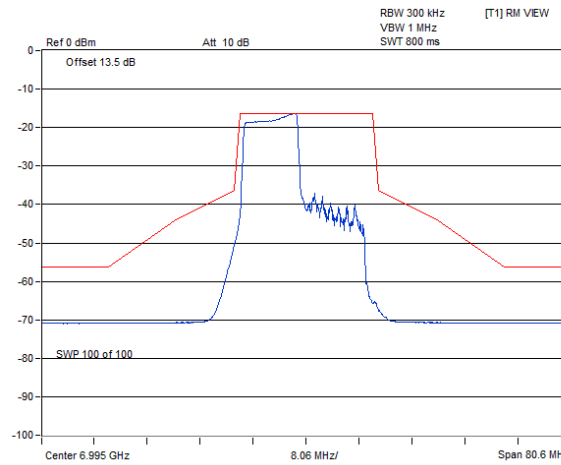

802.11be (EHT20) 106-tone RU / Chain 0 : CH 209@53

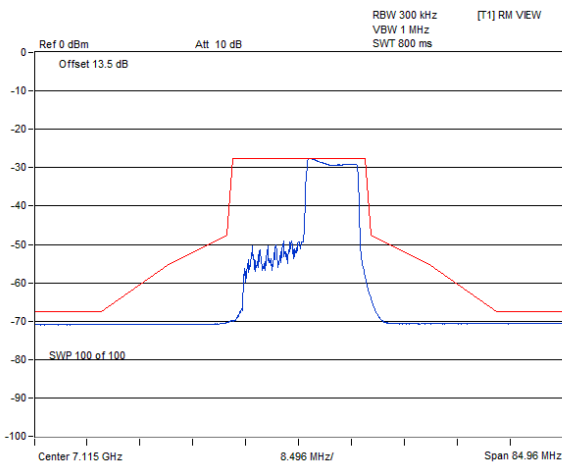

802.11be (EHT20) 106-tone RU / Chain 0 : CH 233@54

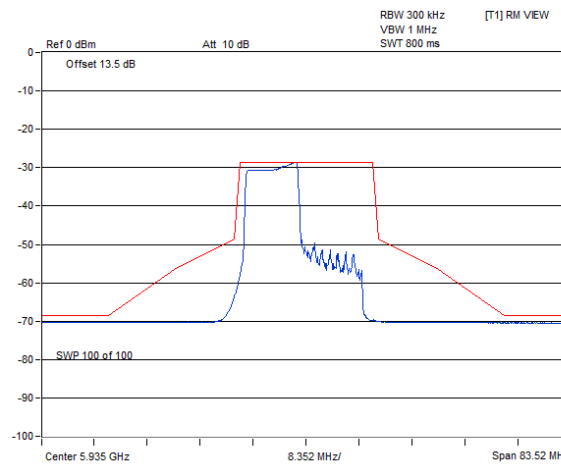

802.11be (EHT20) 106-tone RU / Chain 1 : CH 2@53

Spectrum Plot

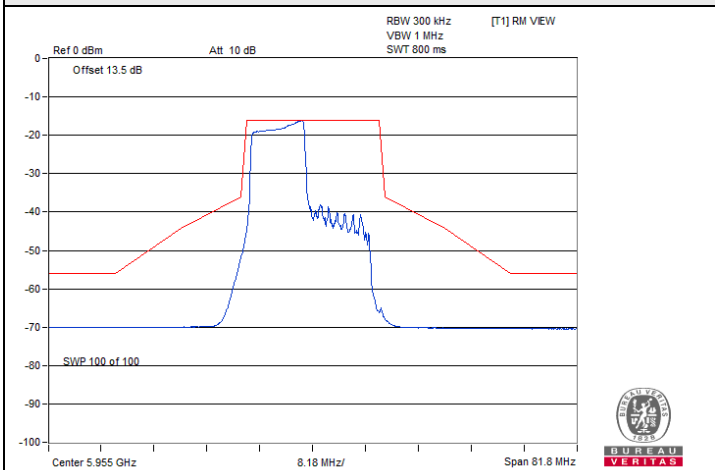

802.11be (EHT20) 106-tone RU / Chain 1 : CH 1@53

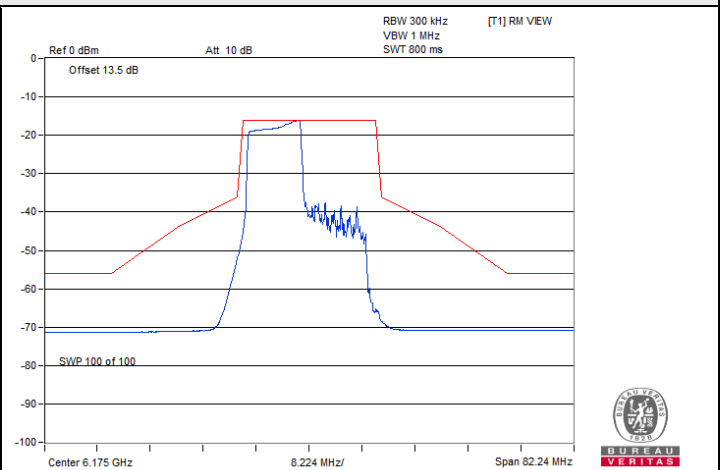

802.11be (EHT20) 106-tone RU / Chain 1 : CH 45@53

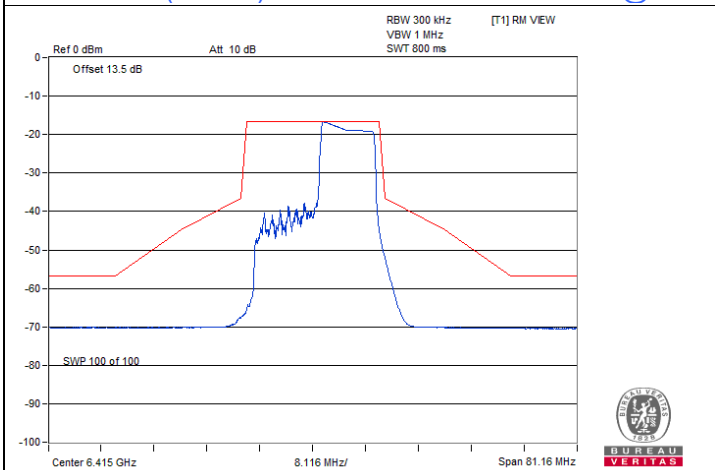

802.11be (EHT20) 106-tone RU / Chain 1 : CH 93@54

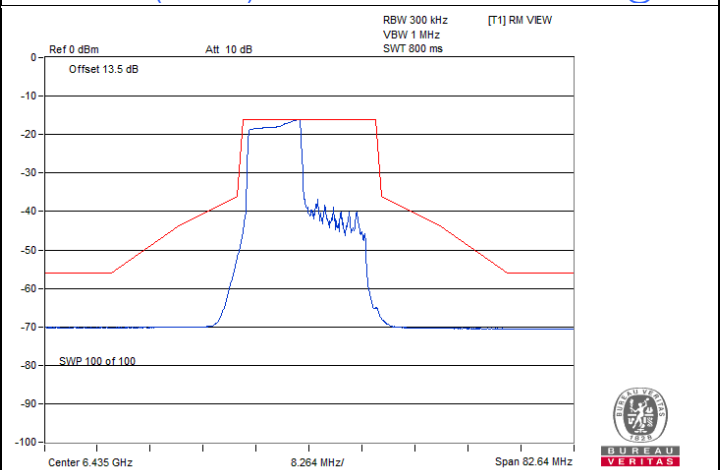

802.11be (EHT20) 106-tone RU / Chain 1 : CH 97@53

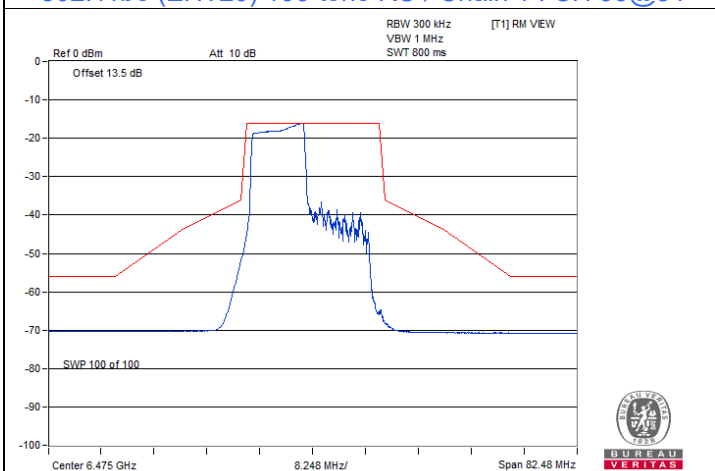

802.11be (EHT20) 106-tone RU / Chain 1 : CH 105@53

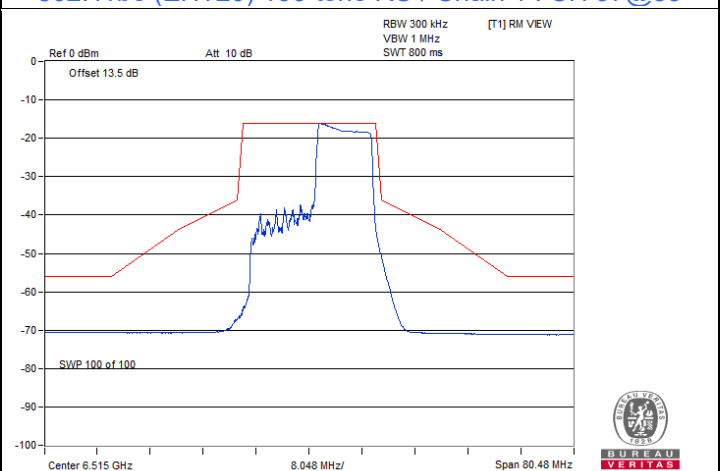

802.11be (EHT20) 106-tone RU / Chain 1 : CH 113@54

Spectrum Plot

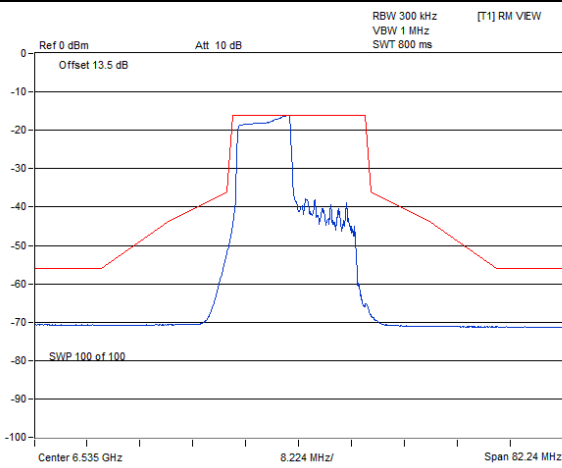

802.11be (EHT20) 106-tone RU / Chain 1 : CH 117@53

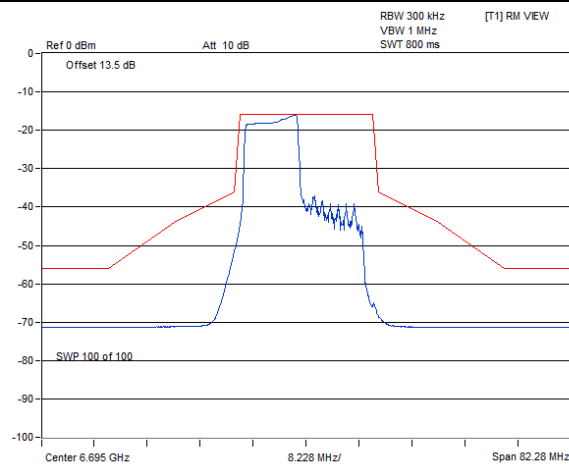

802.11be (EHT20) 106-tone RU / Chain 1 : CH 149@53

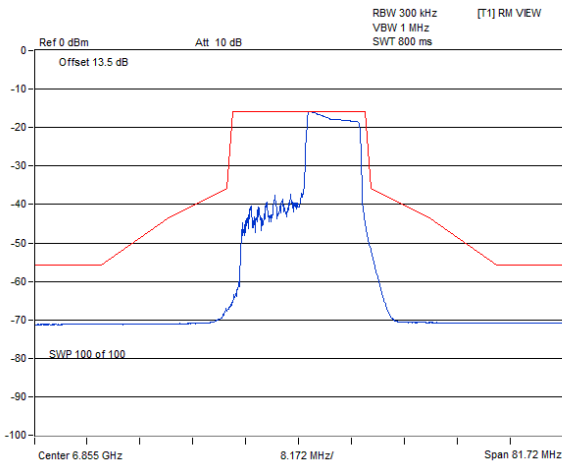

802.11be (EHT20) 106-tone RU / Chain 1 : CH 181@54

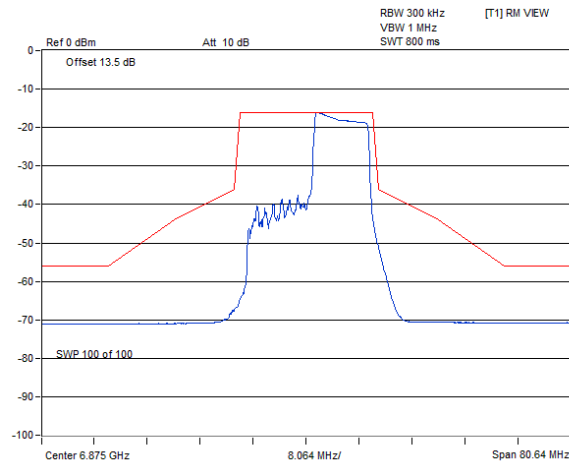

802.11be (EHT20) 106-tone RU / Chain 1 : CH 185@53

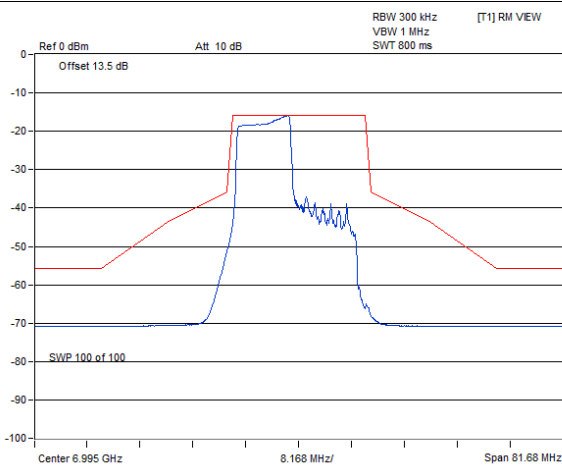

802.11be (EHT20) 106-tone RU / Chain 1 : CH 209@53

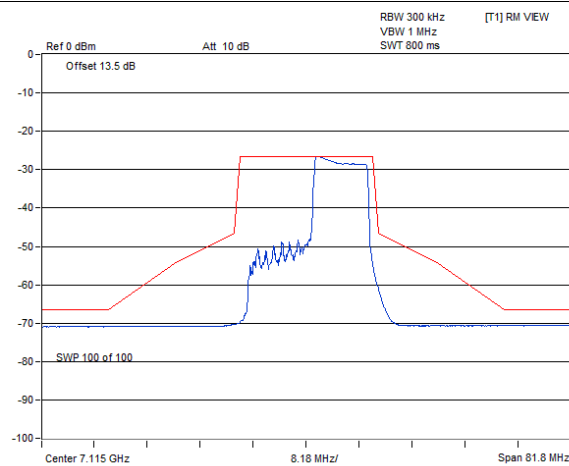

802.11be (EHT20) 106-tone RU / Chain 1 : CH 233@54

Mode C

Input Power:	3.3 Vdc	Environmental Conditions:	24°C, 64% RH	Tested By:	Eric Peng
--------------	---------	---------------------------	--------------	------------	-----------

802.11a

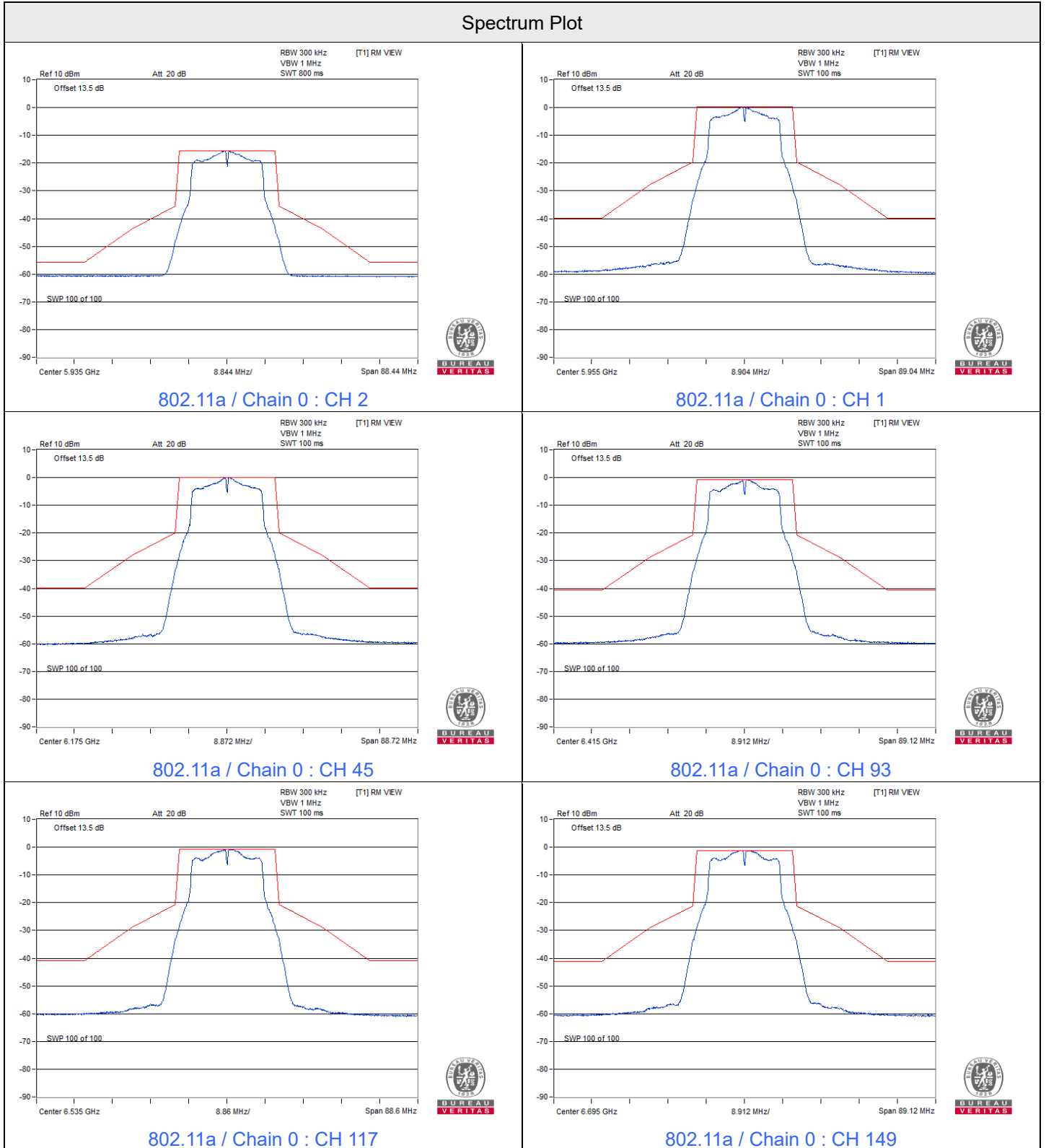

Spectrum Plot

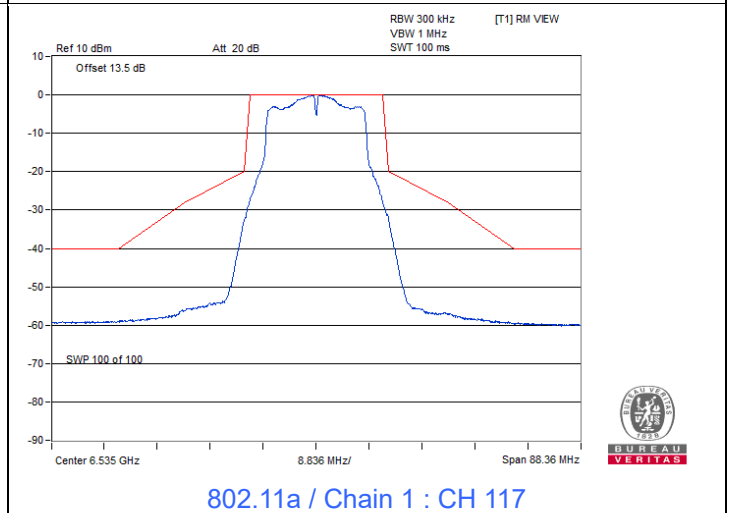
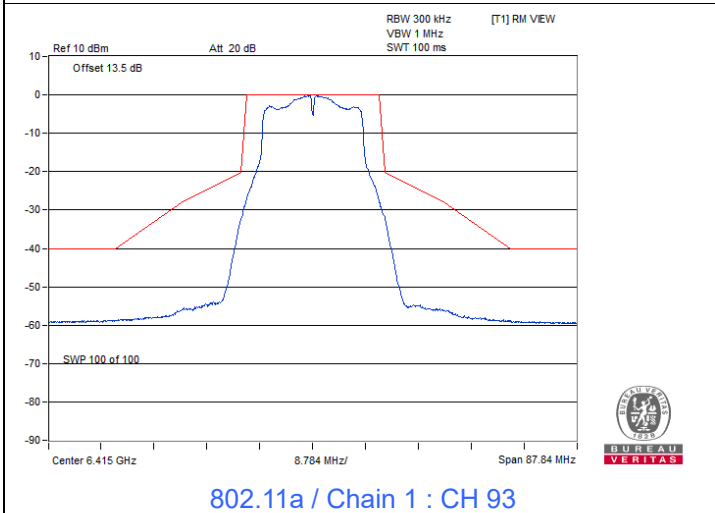
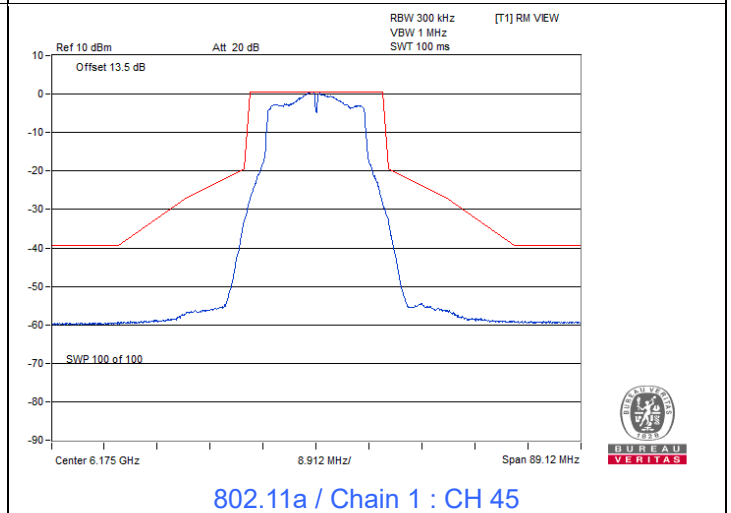
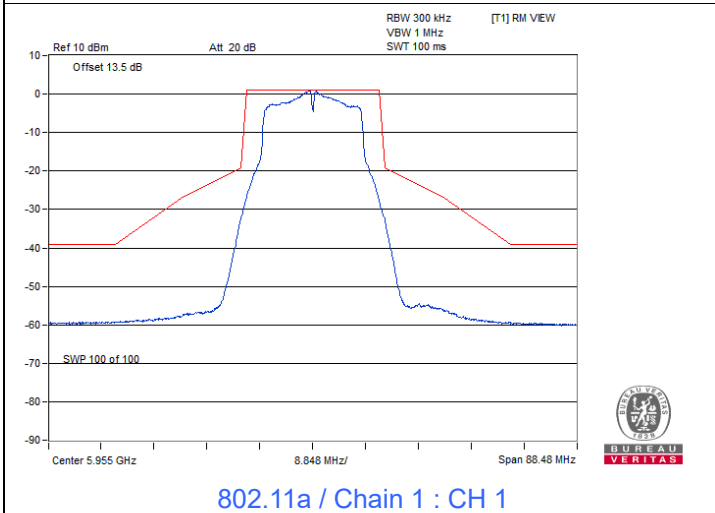
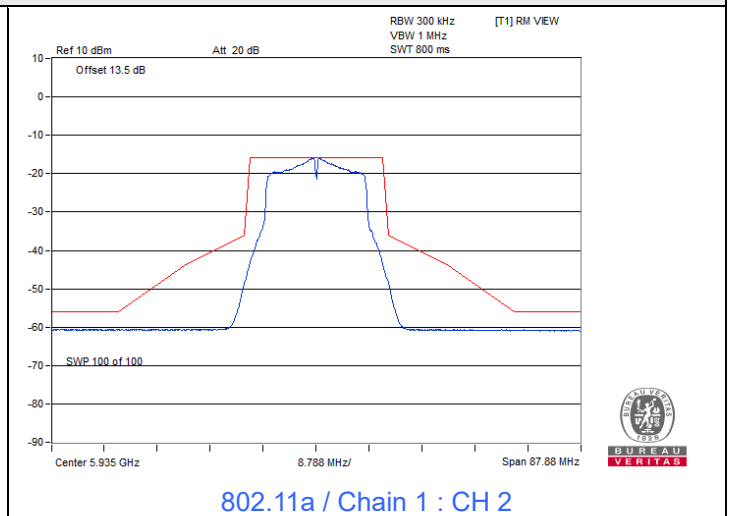
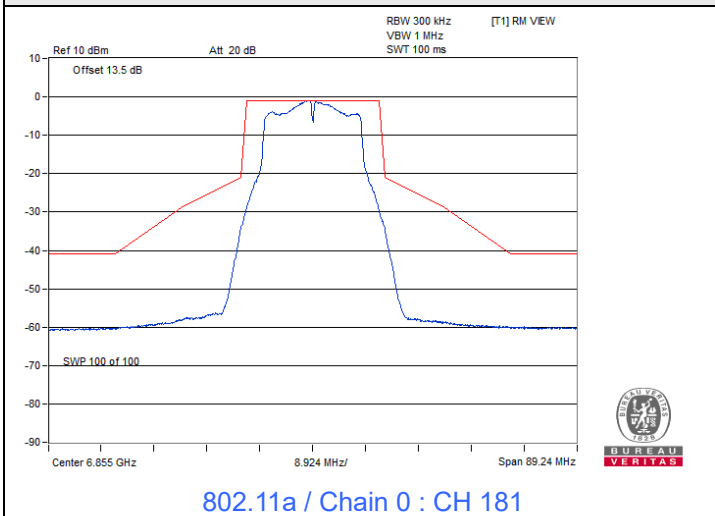

Spectrum Plot

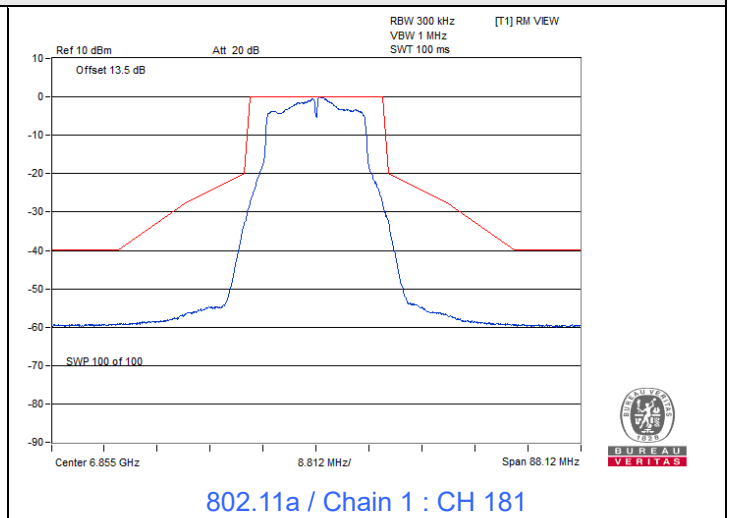
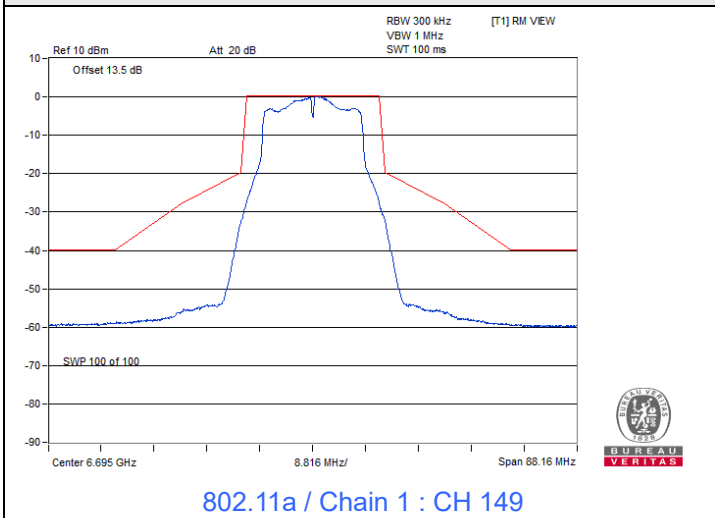

802.11be (EHT20)

Spectrum Plot

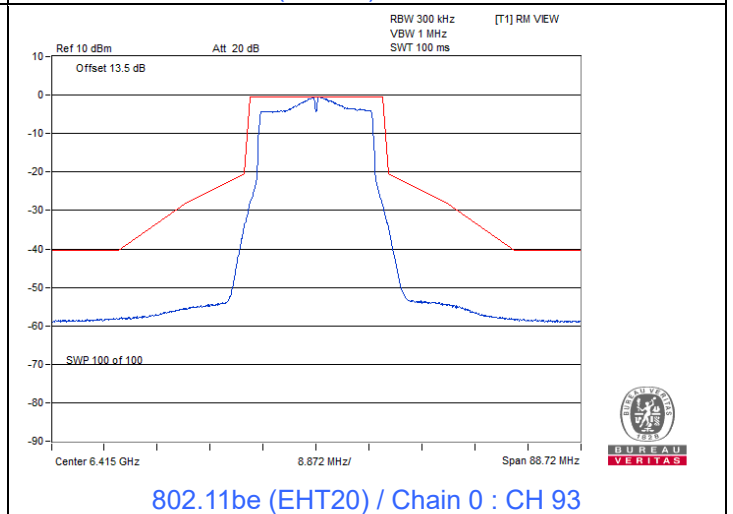
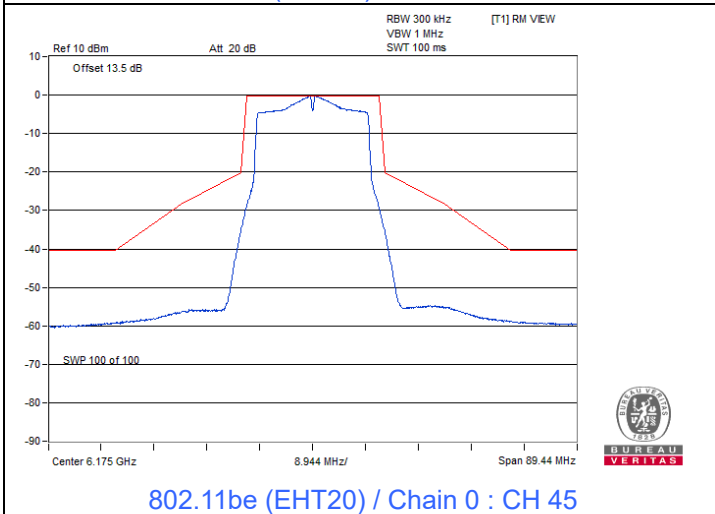
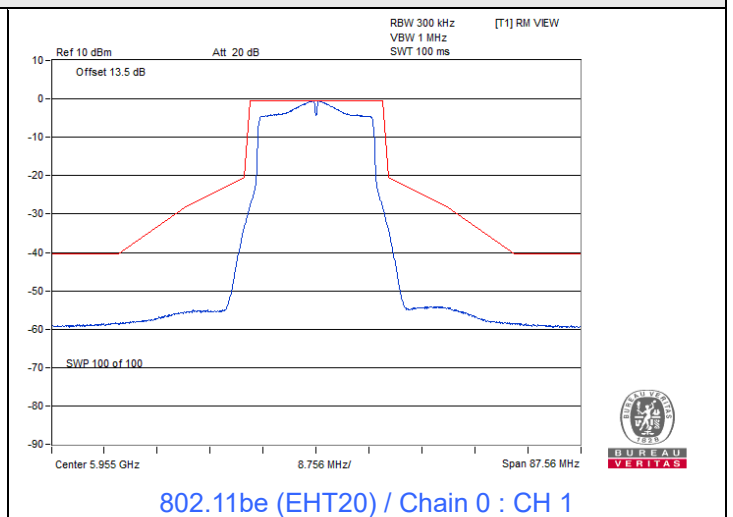
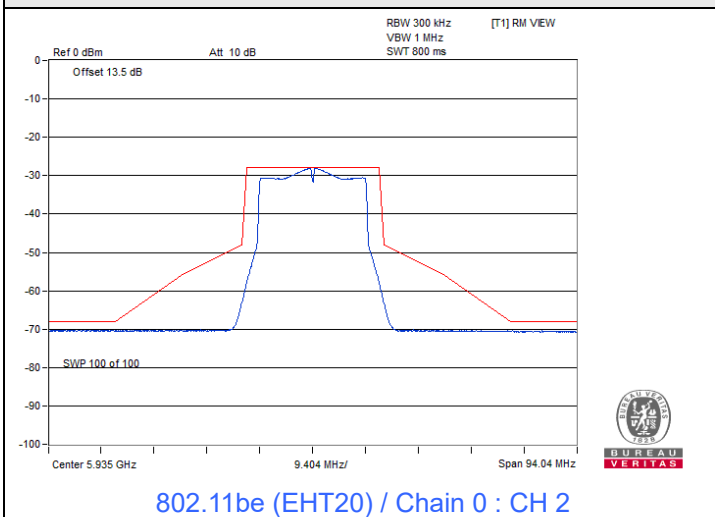

Spectrum Plot

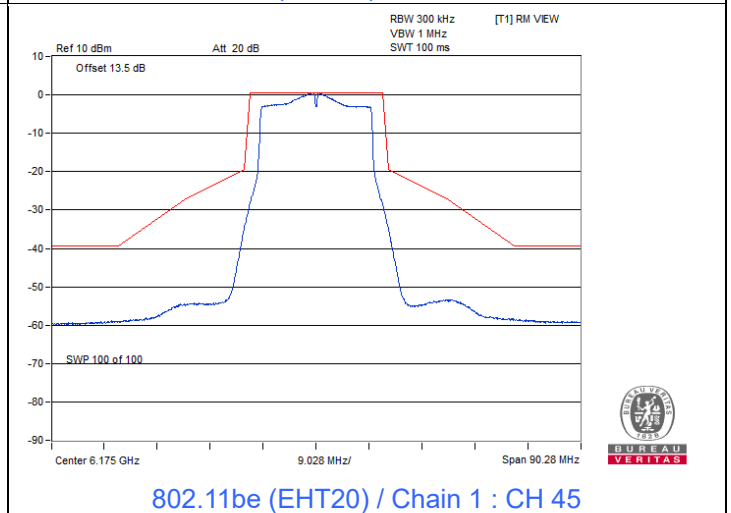
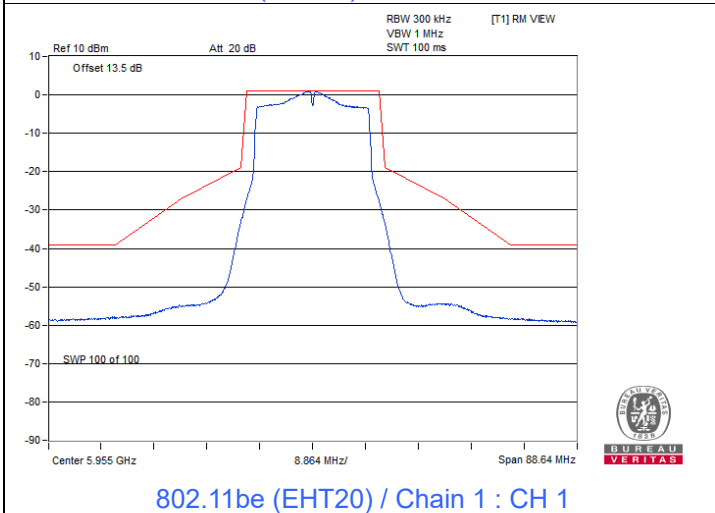
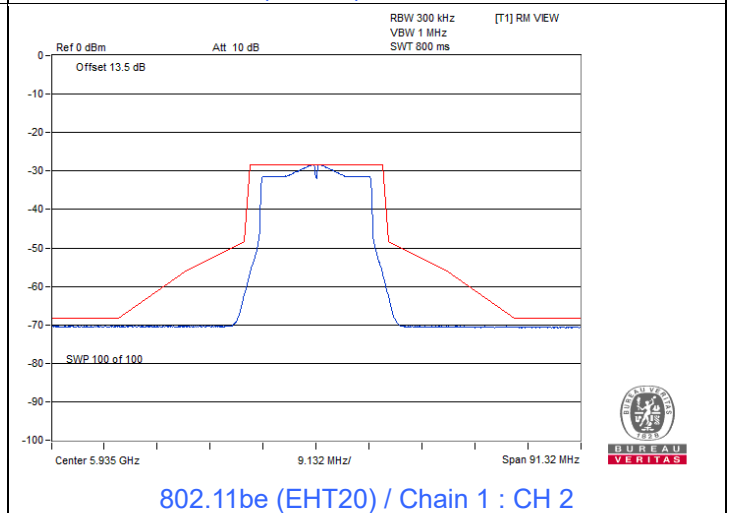
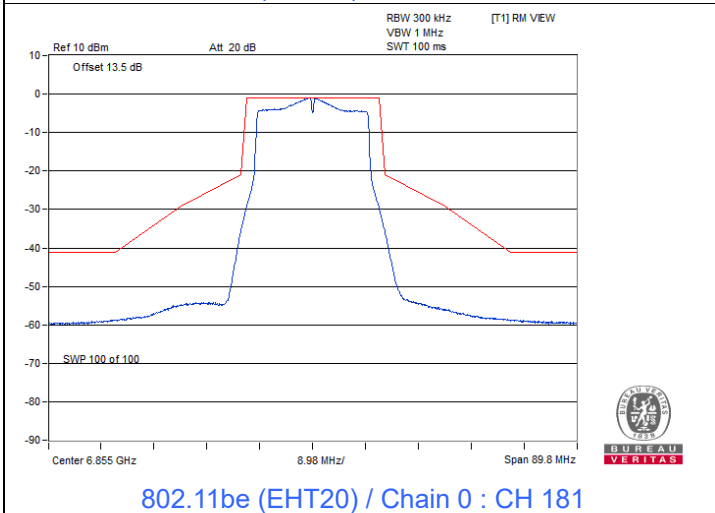
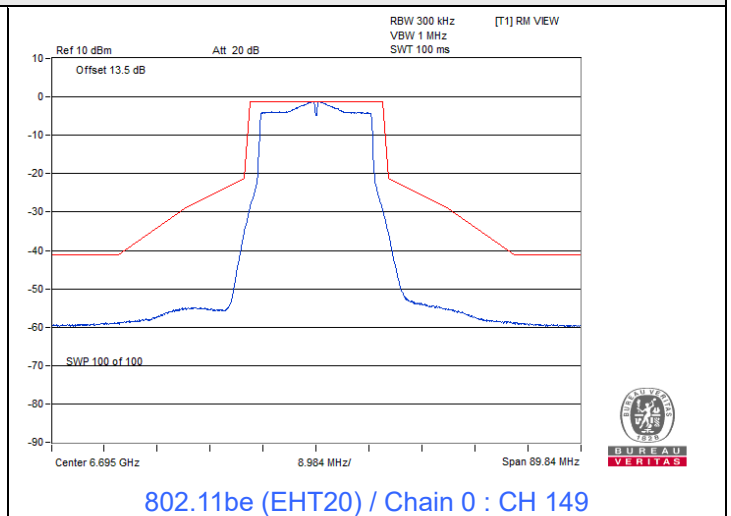
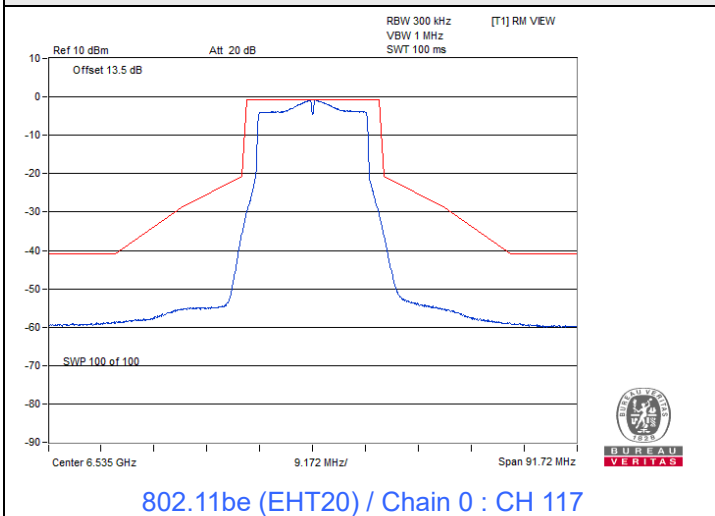

Spectrum Plot

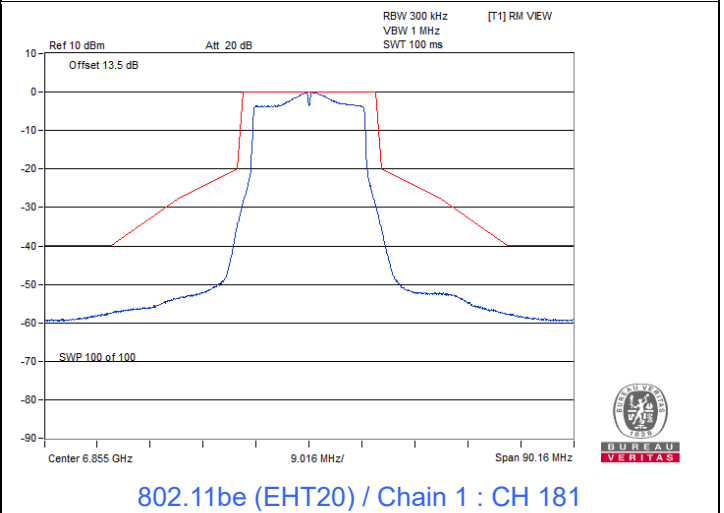
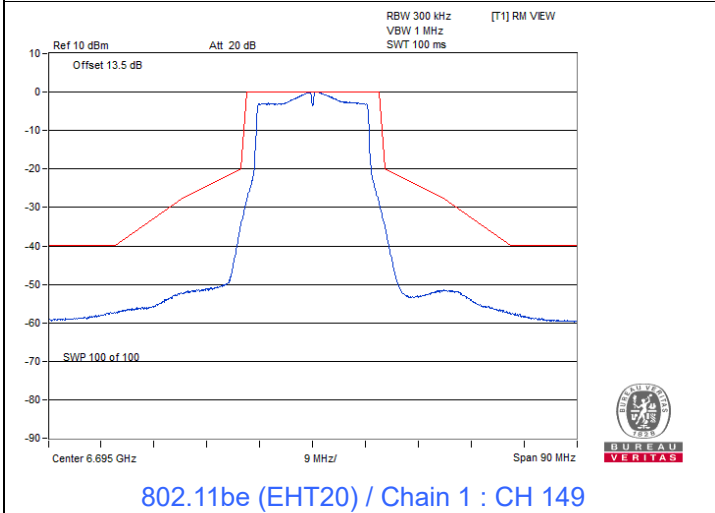
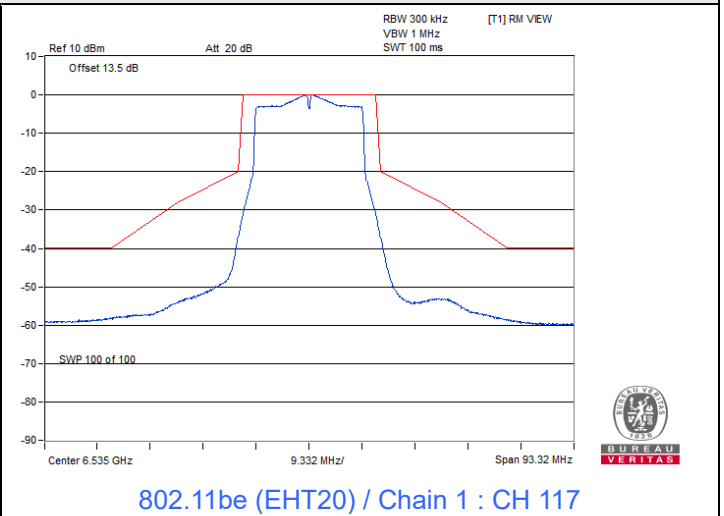
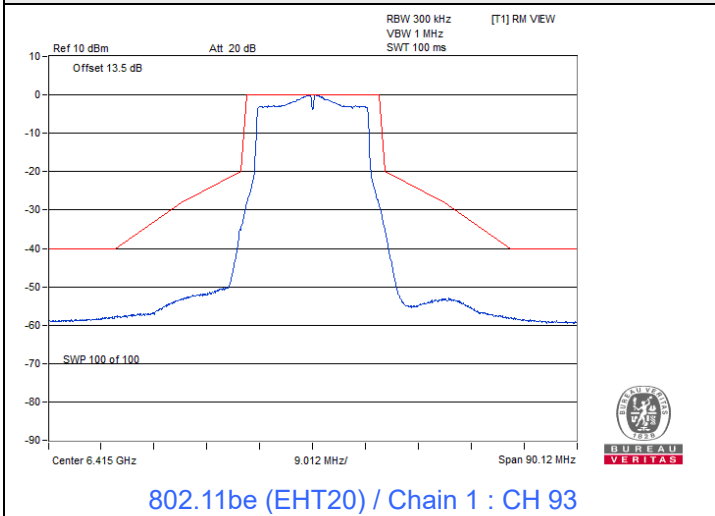

802.11be (EHT40)

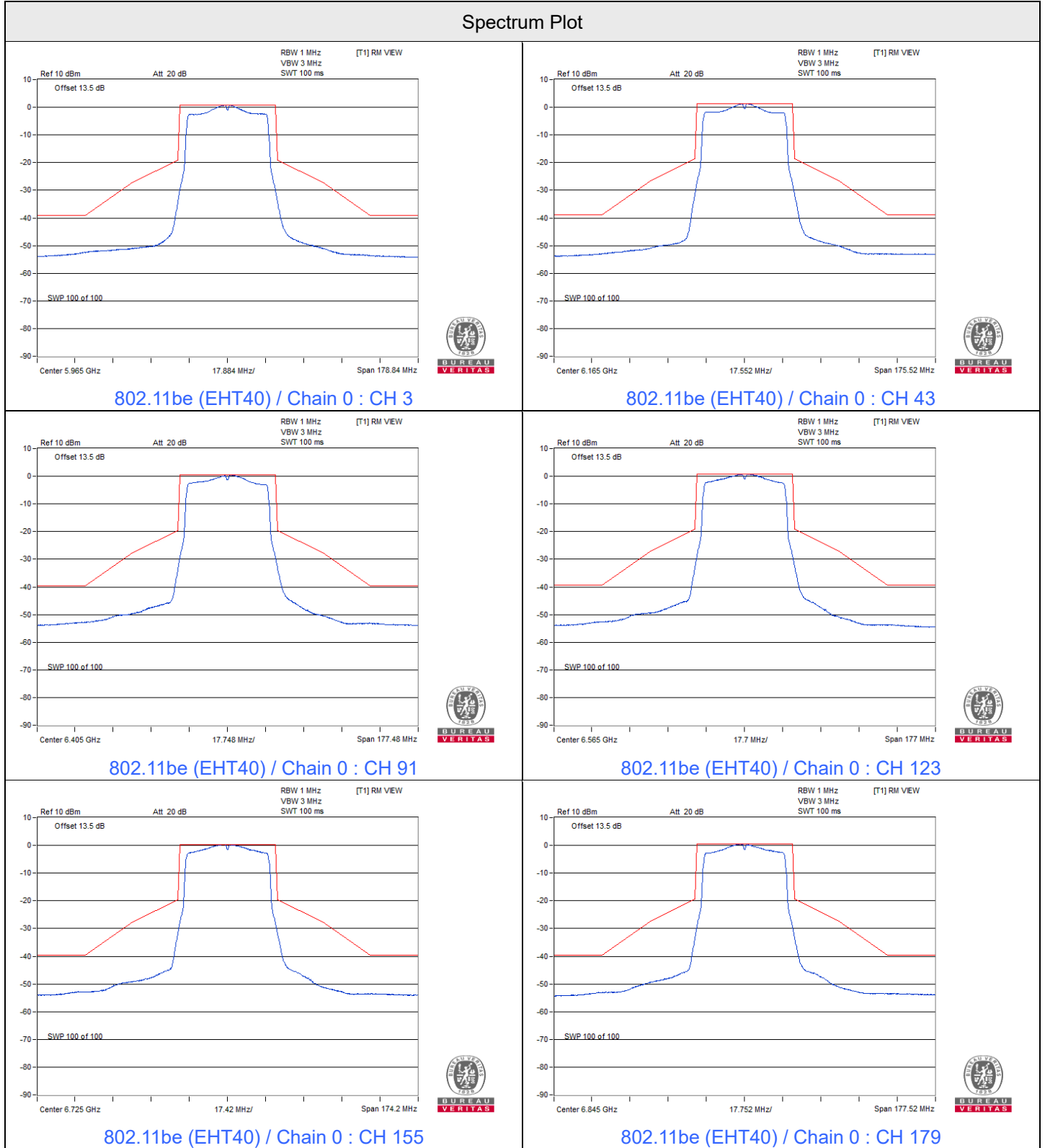

Spectrum Plot

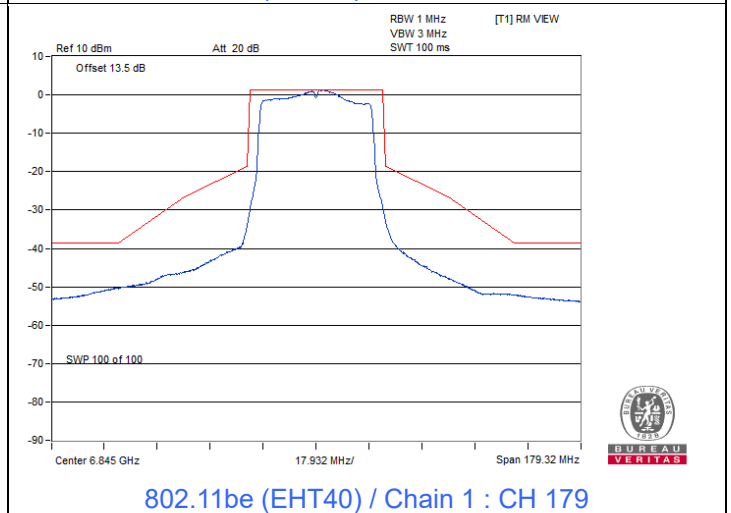
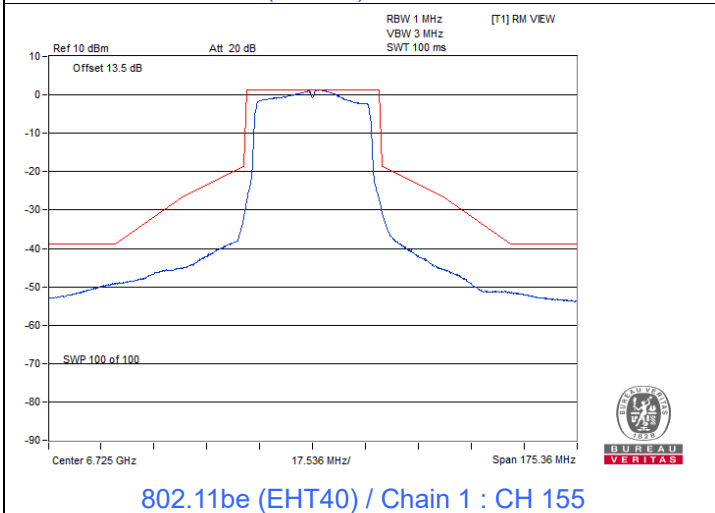
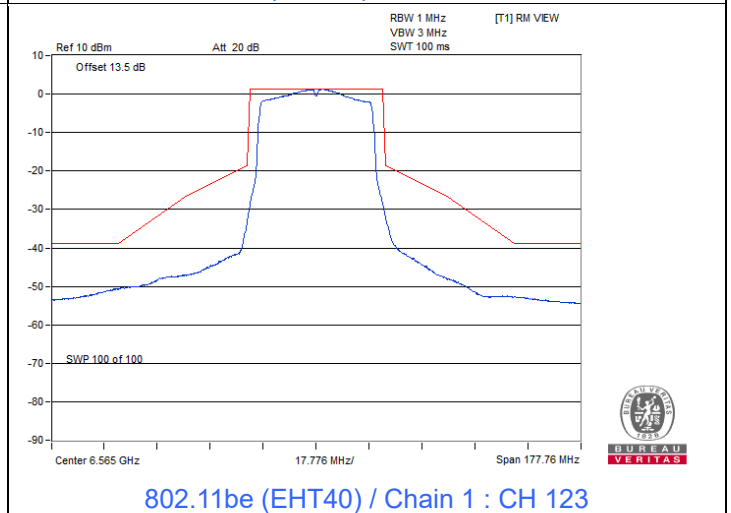
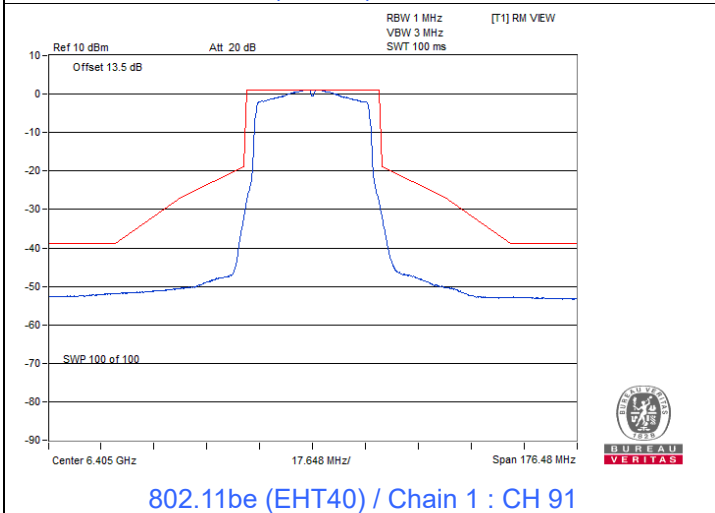
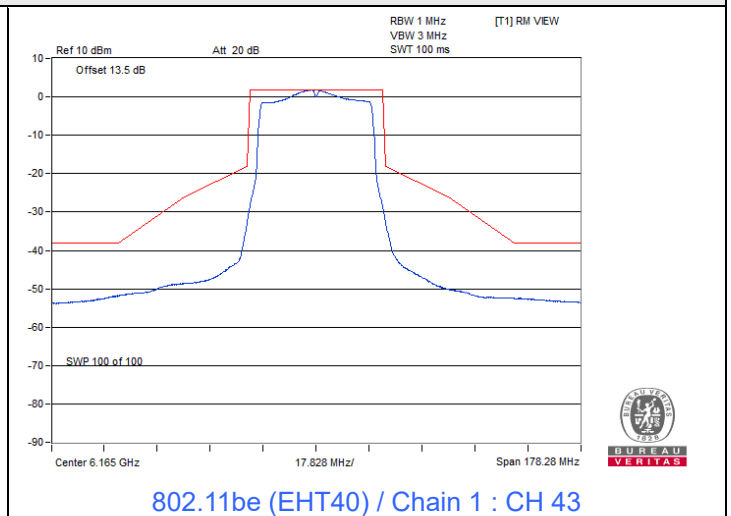
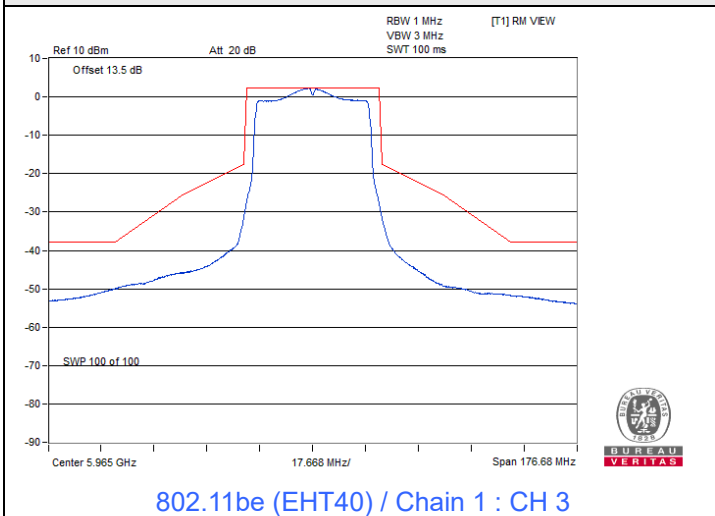

802.11be (EHT80)

Spectrum Plot

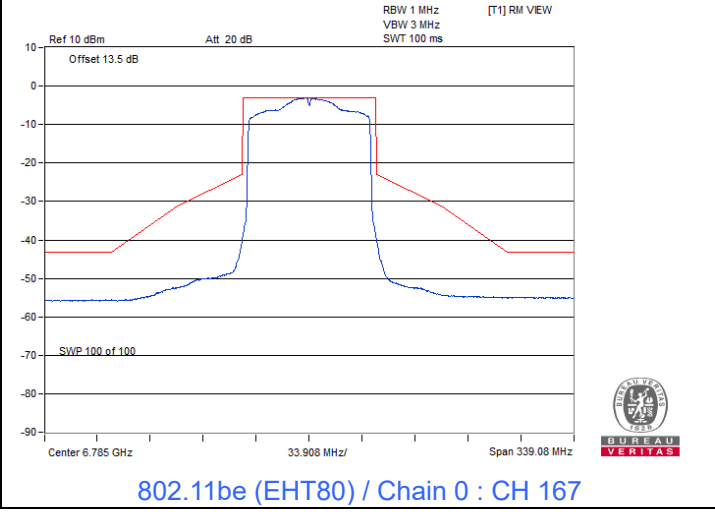
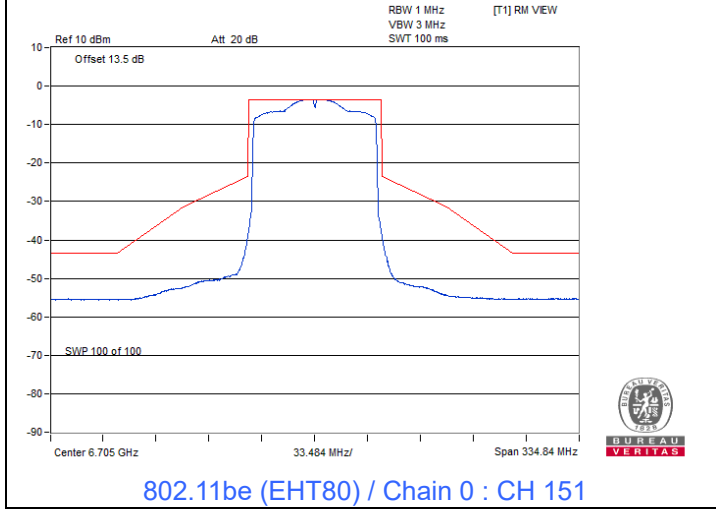
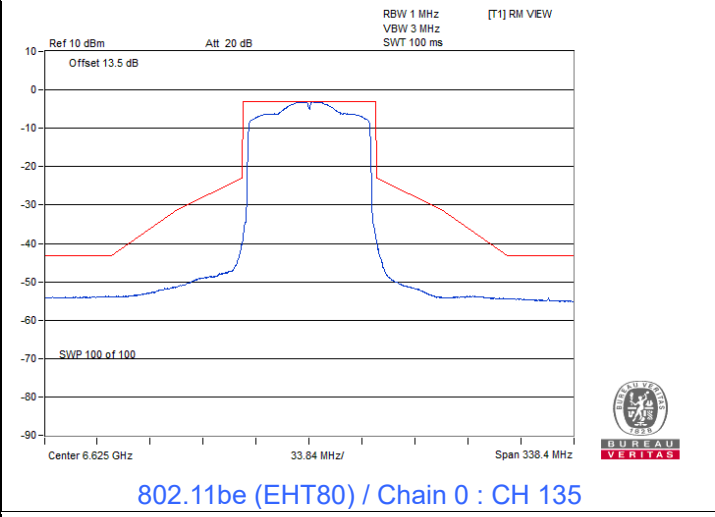
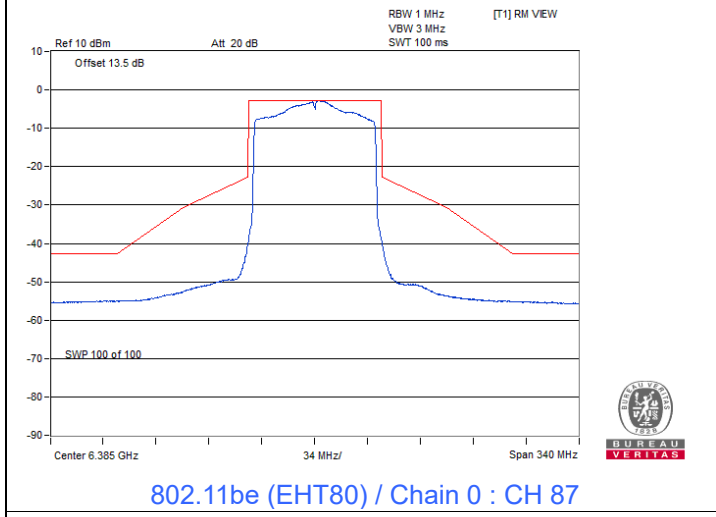
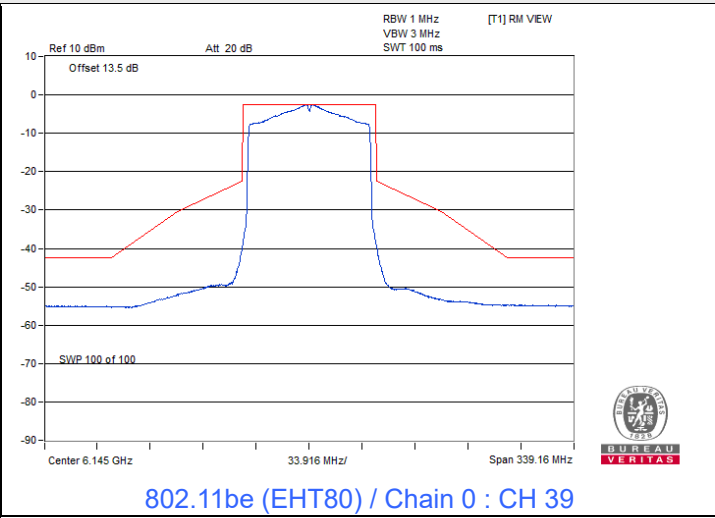
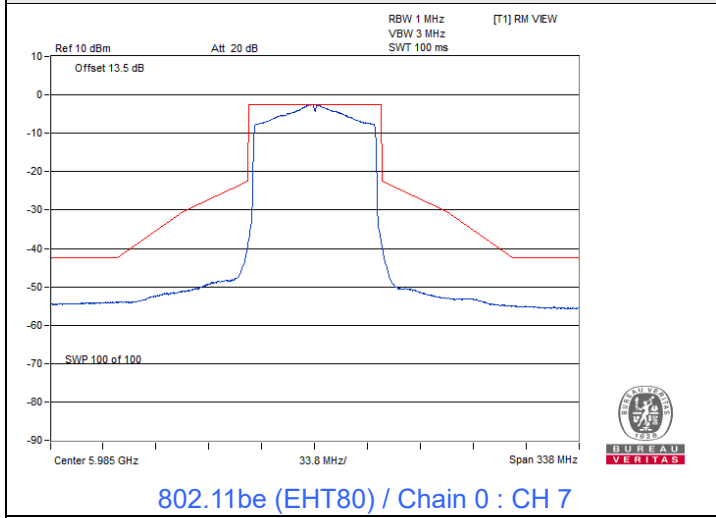

Spectrum Plot

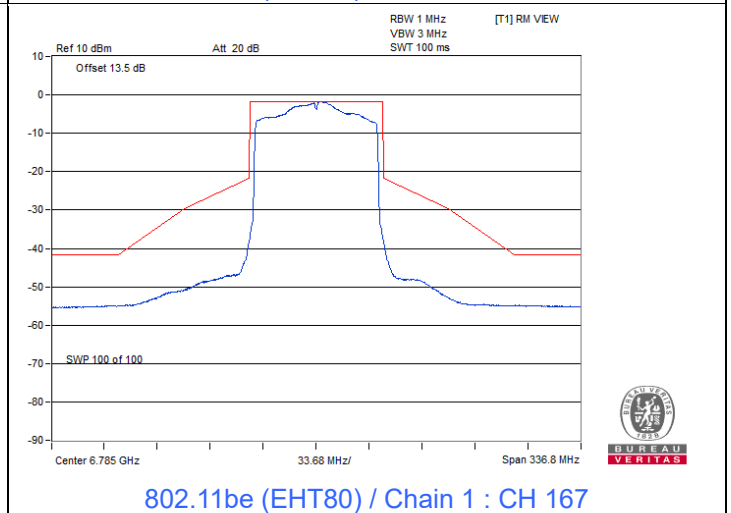
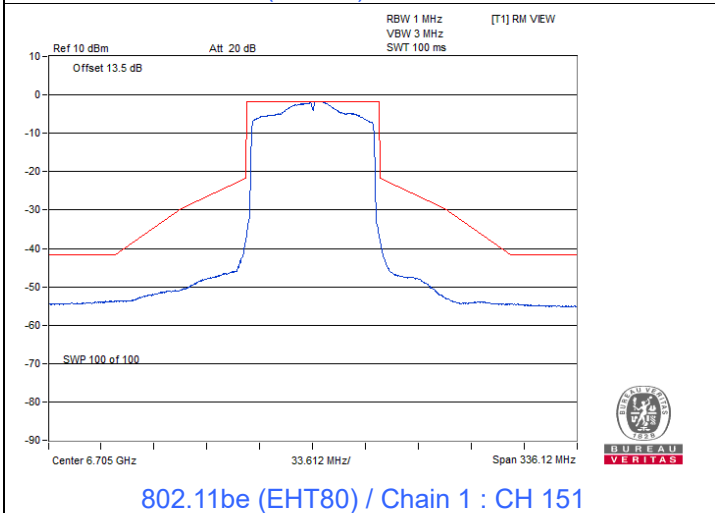
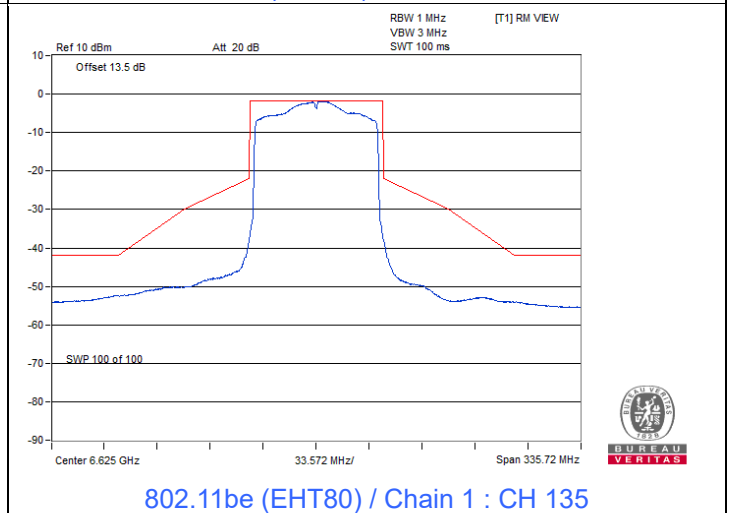
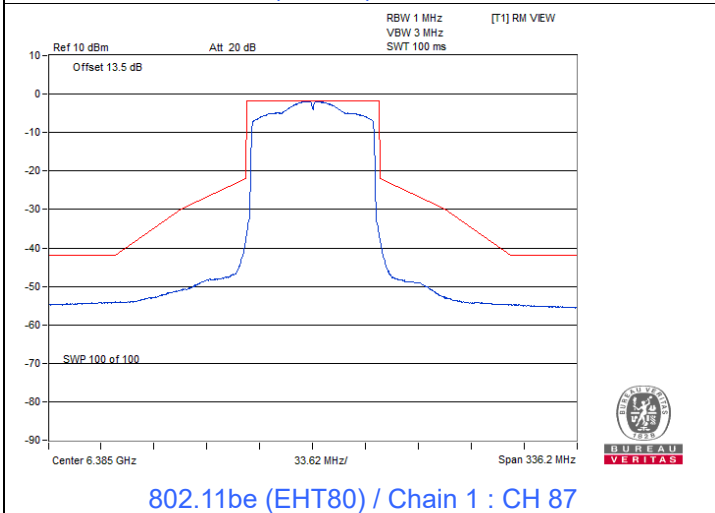
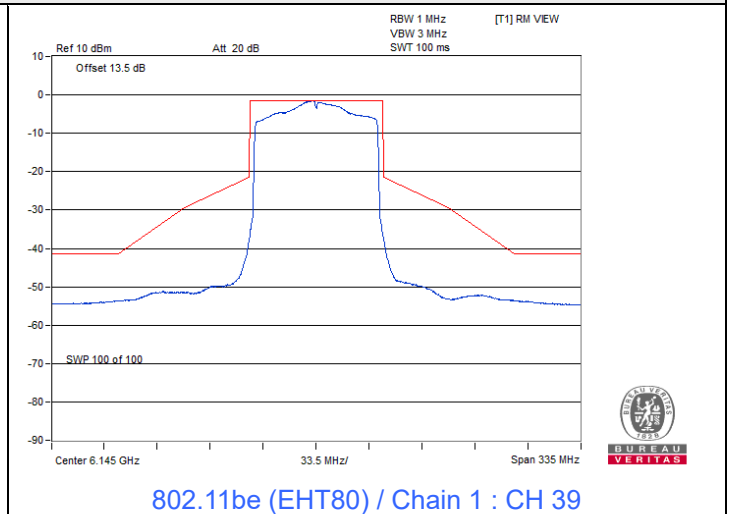
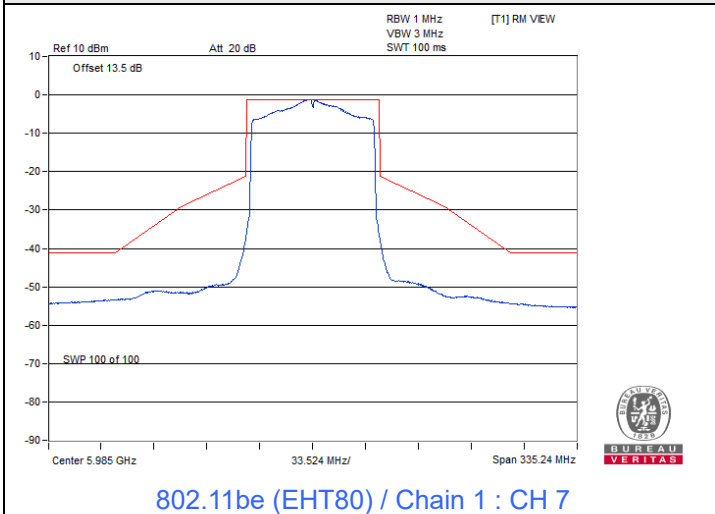

802.11be (EHT160)

Spectrum Plot

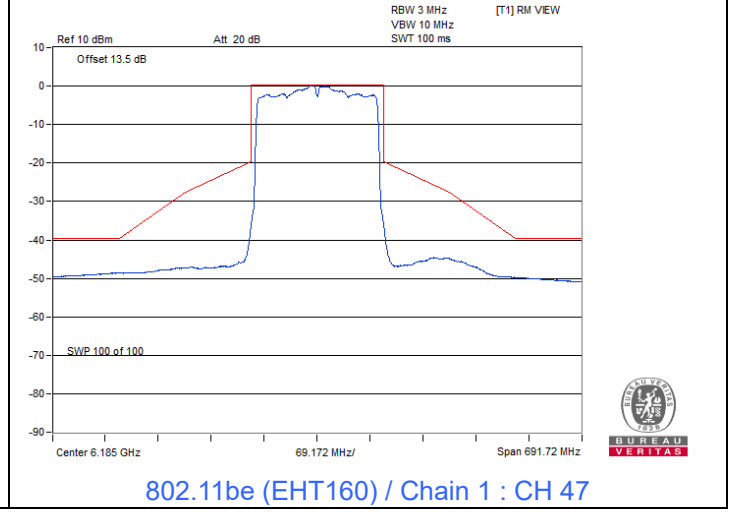
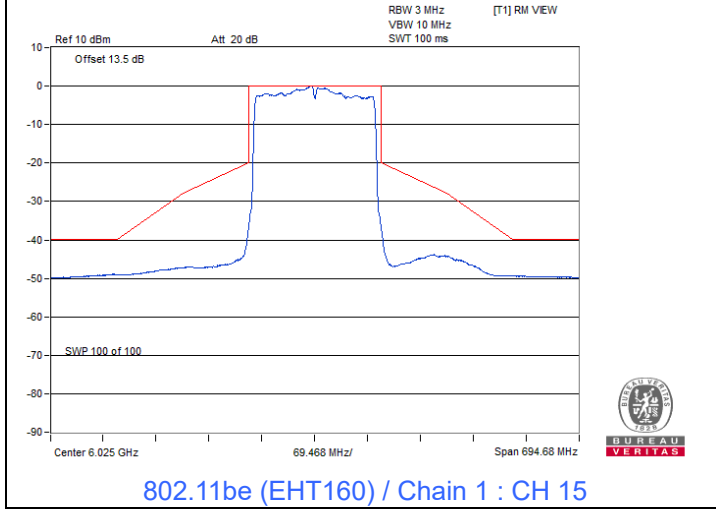
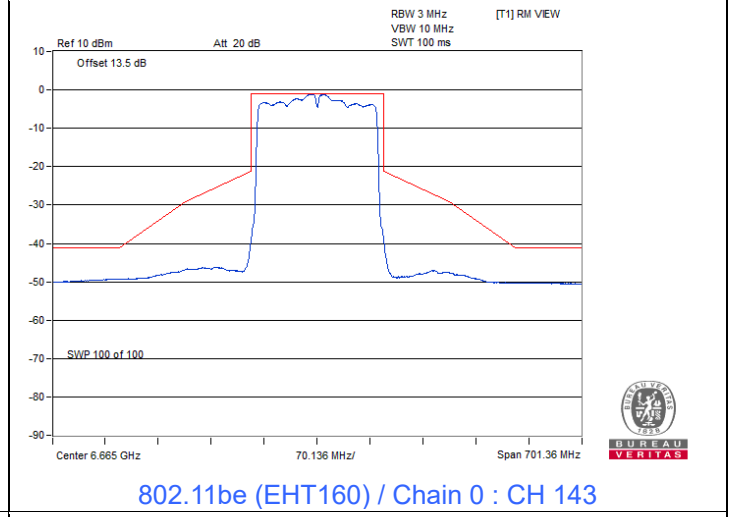
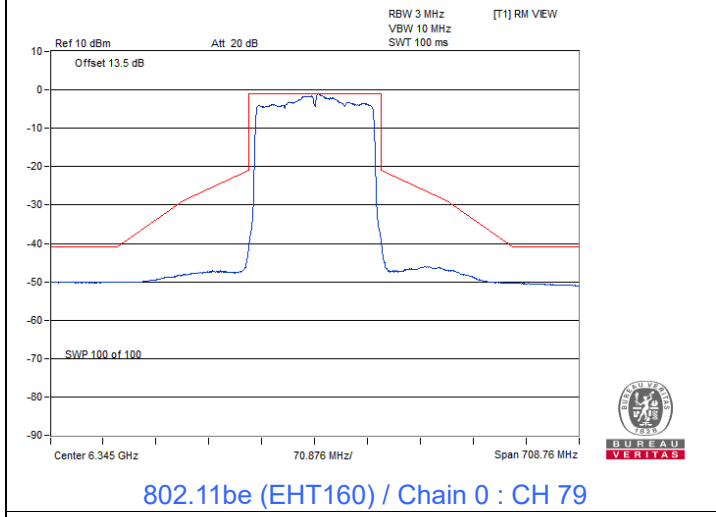
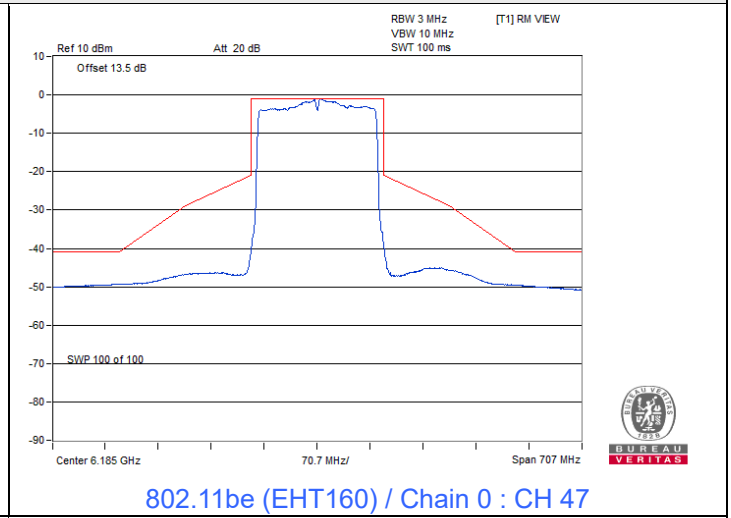
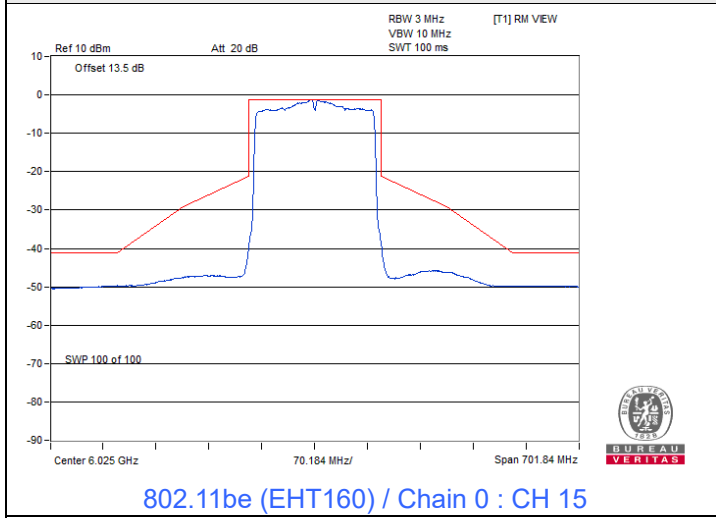

Spectrum Plot

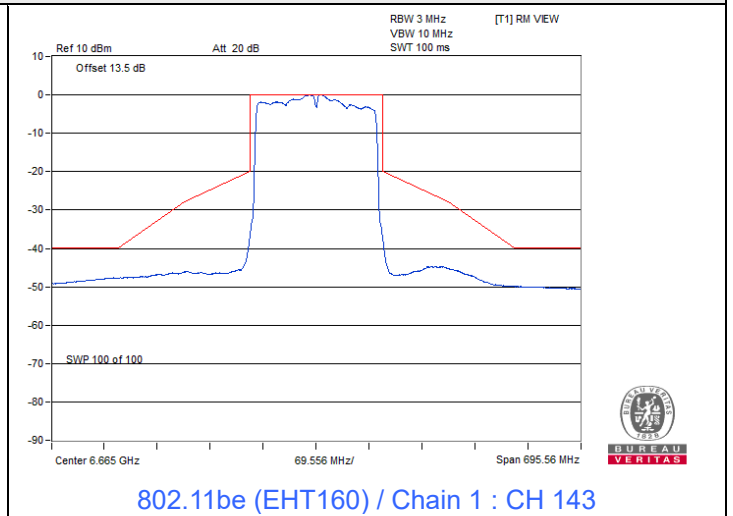
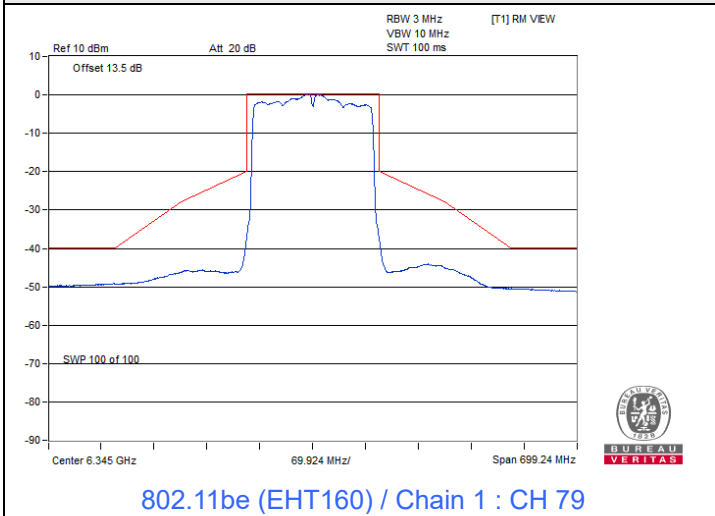

802.11be (EHT320)

Spectrum Plot

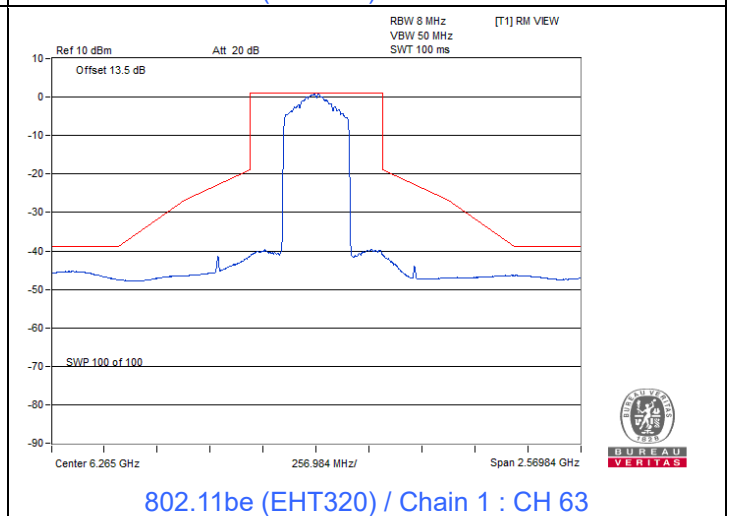
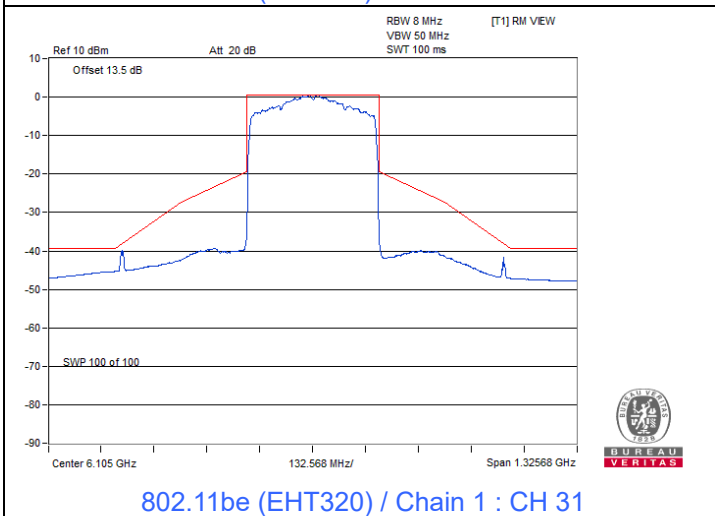
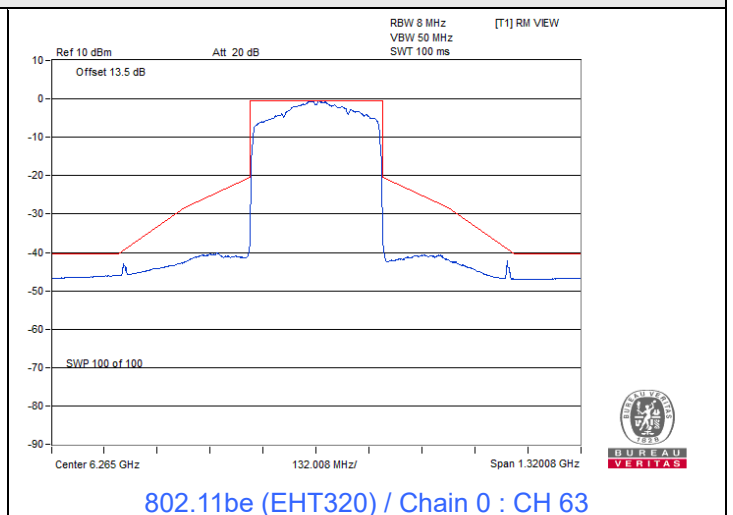
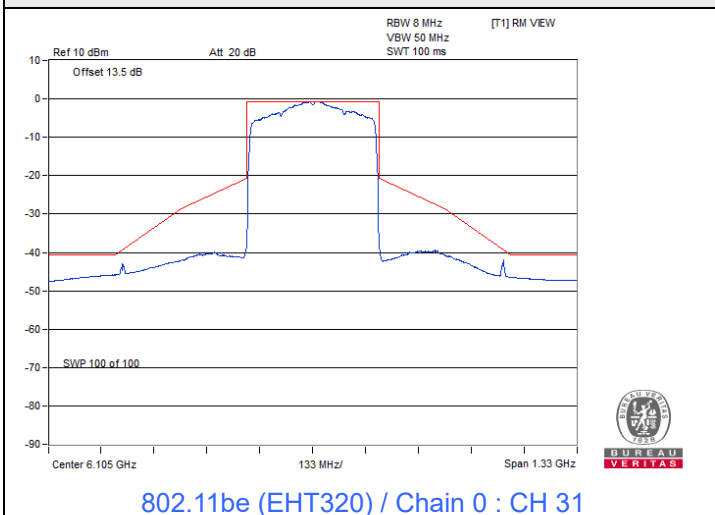

802.11be (EHT20) 26-tone RU

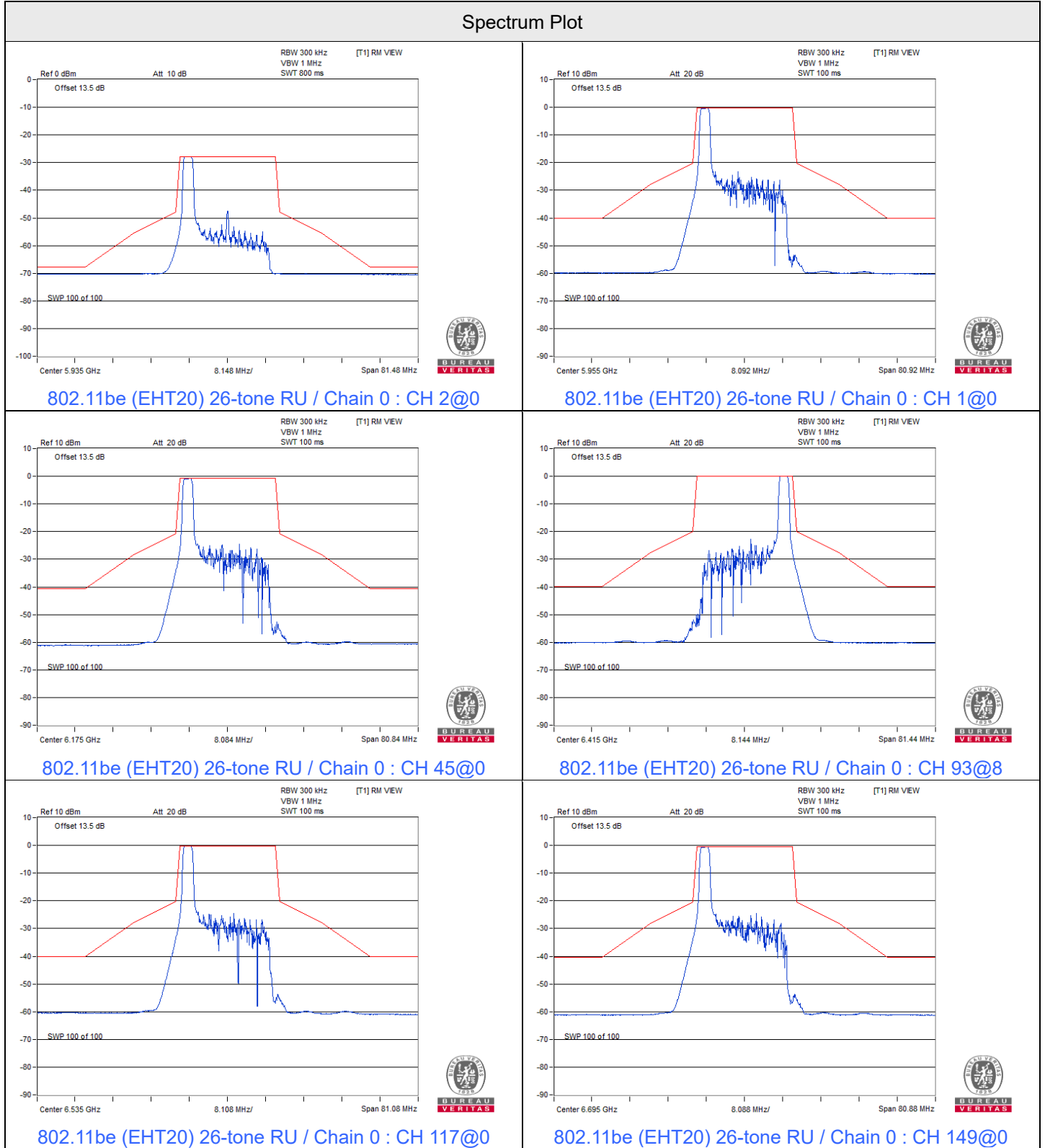

Spectrum Plot

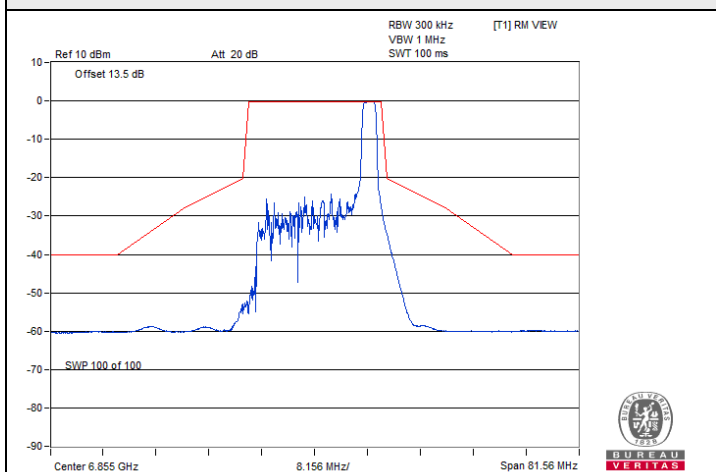

802.11be (EHT20) 26-tone RU / Chain 0 : CH 181@8

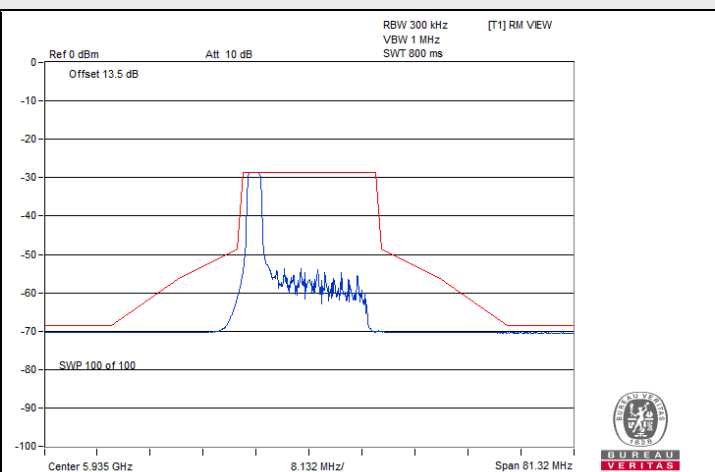

802.11be (EHT20) 26-tone RU / Chain 1 : CH 2@0

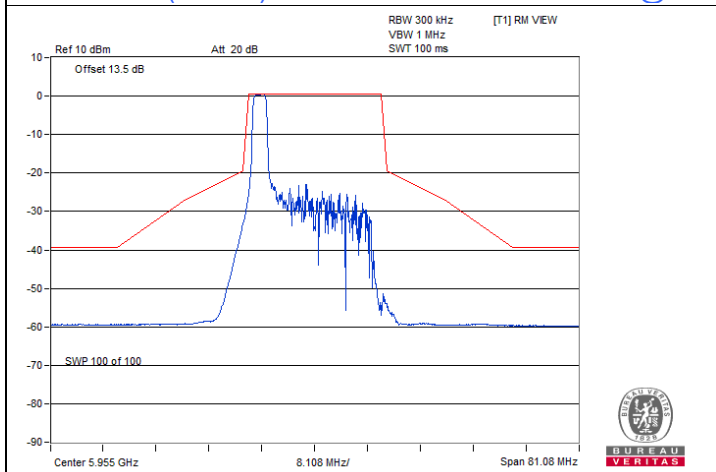

802.11be (EHT20) 26-tone RU / Chain 1 : CH 1@0

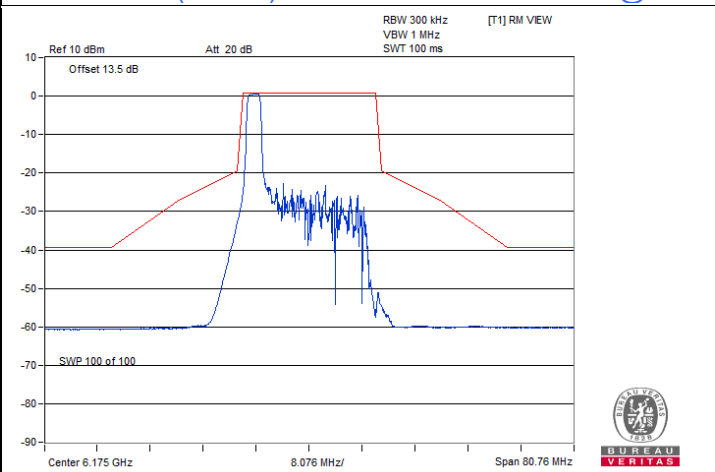

802.11be (EHT20) 26-tone RU / Chain 1 : CH 45@0

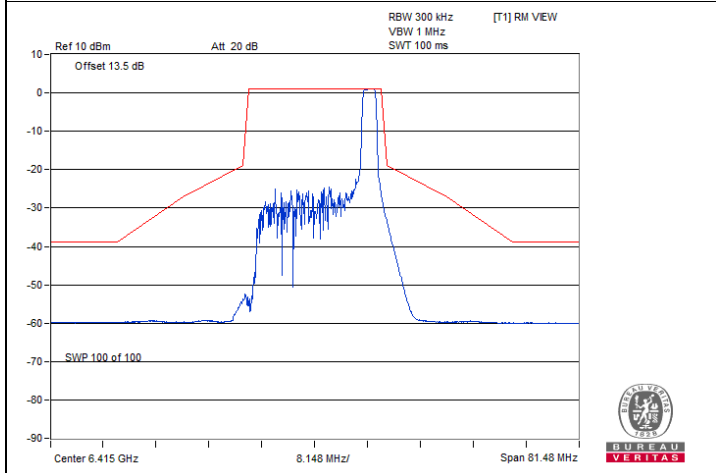

802.11be (EHT20) 26-tone RU / Chain 1 : CH 93@8

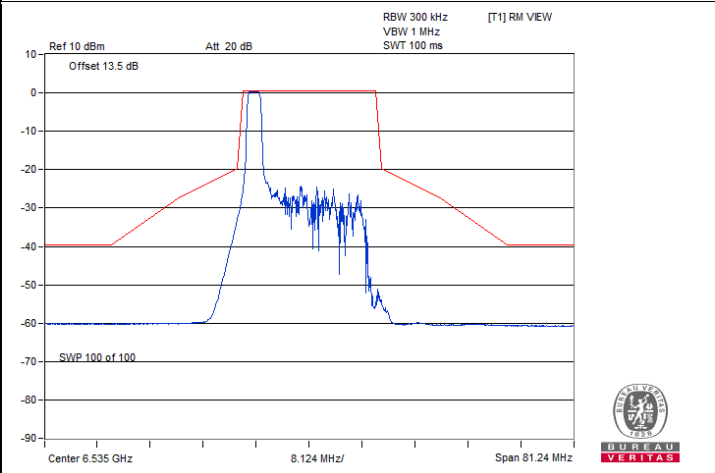

802.11be (EHT20) 26-tone RU / Chain 1 : CH 117@0

Spectrum Plot

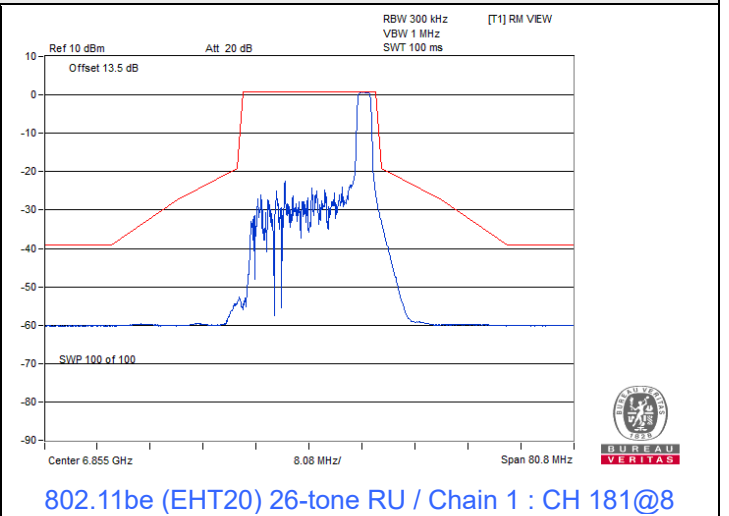
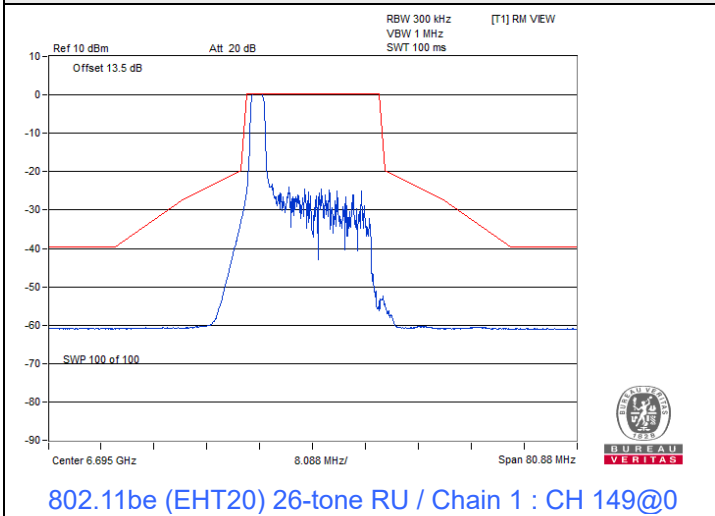

802.11be (EHT20) 52-tone RU

Spectrum Plot

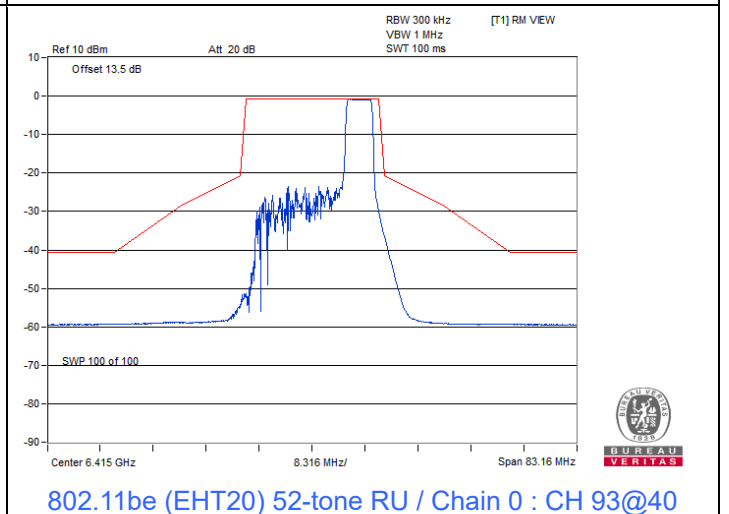
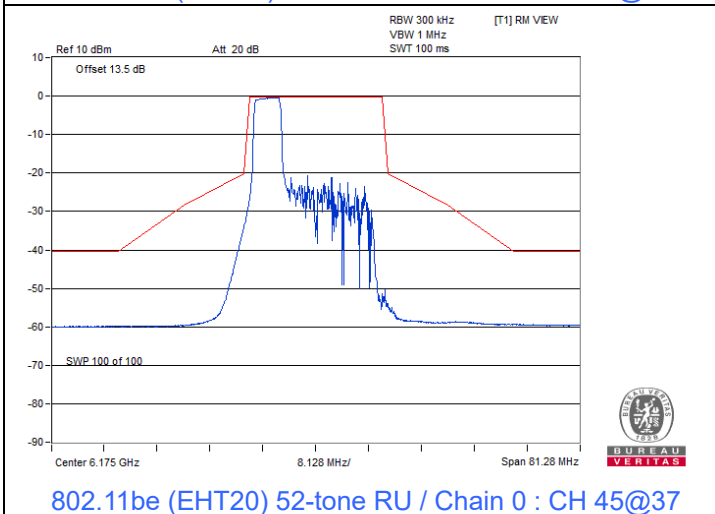
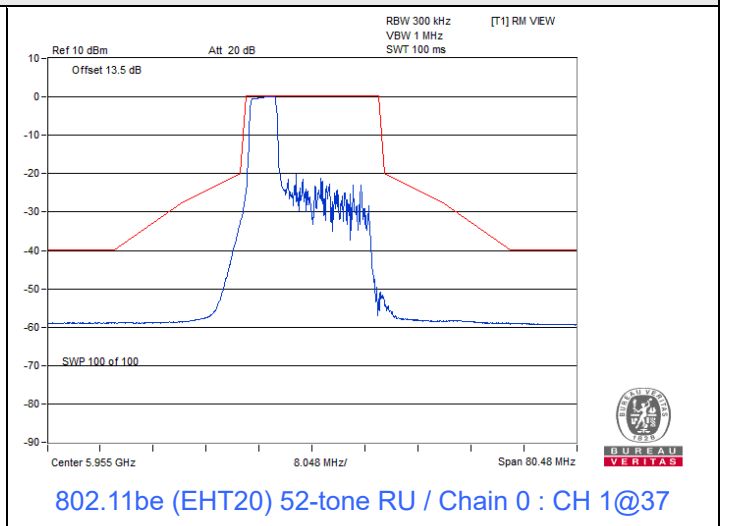
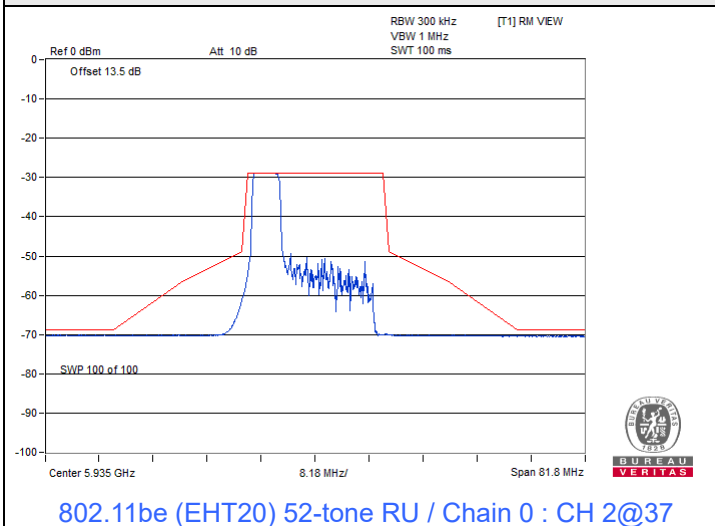

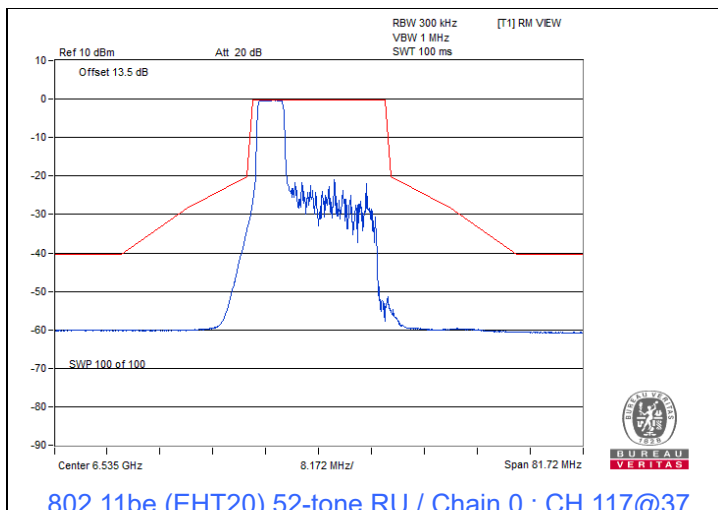

802.11be (EHT20) 52-tone RU / Chain 0 : CH 117@37

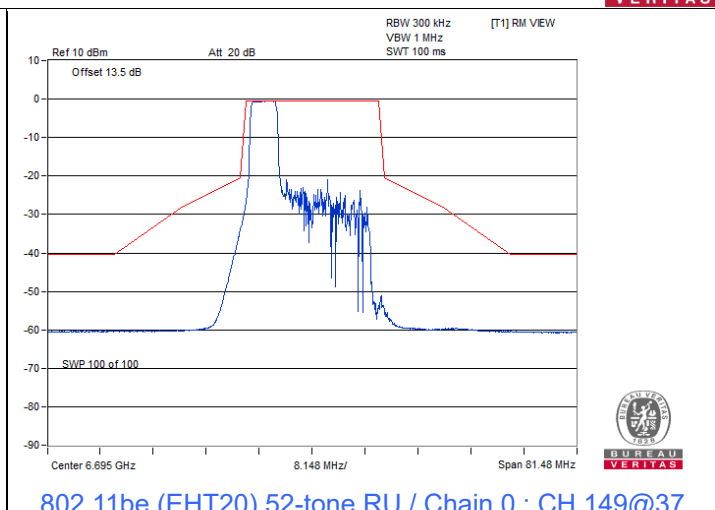

802.11be (EHT20) 52-tone RU / Chain 0 : CH 149@37

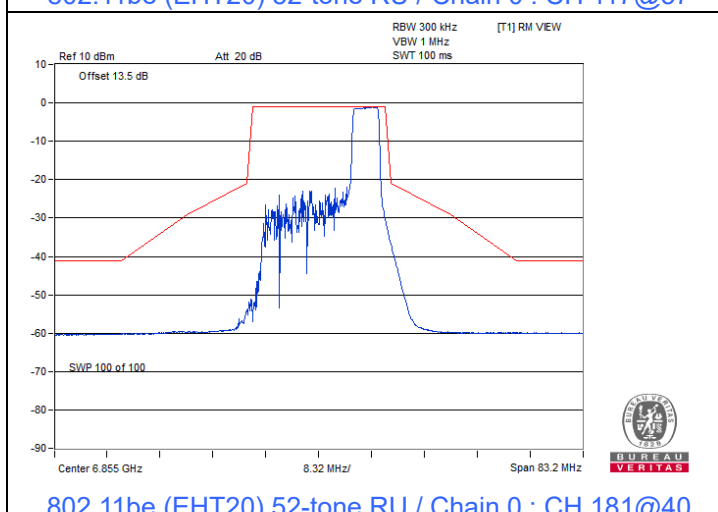

802.11be (EHT20) 52-tone RU / Chain 0 : CH 181@40

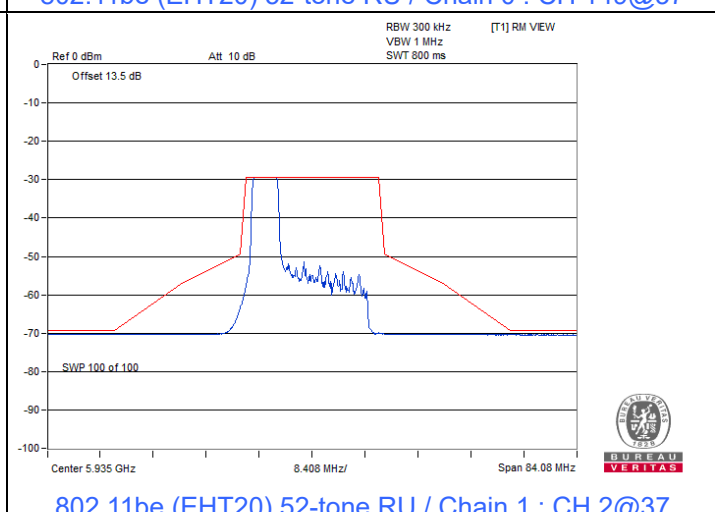

802.11be (EHT20) 52-tone RU / Chain 1 : CH 2@37

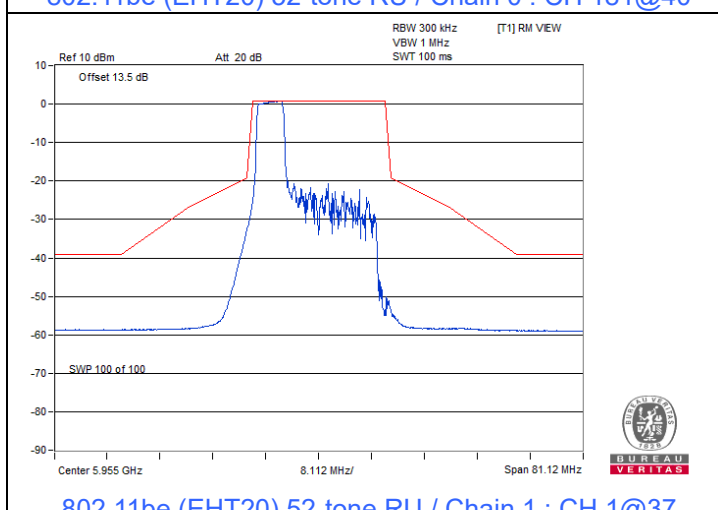

802.11be (EHT20) 52-tone RU / Chain 1 : CH 1@37

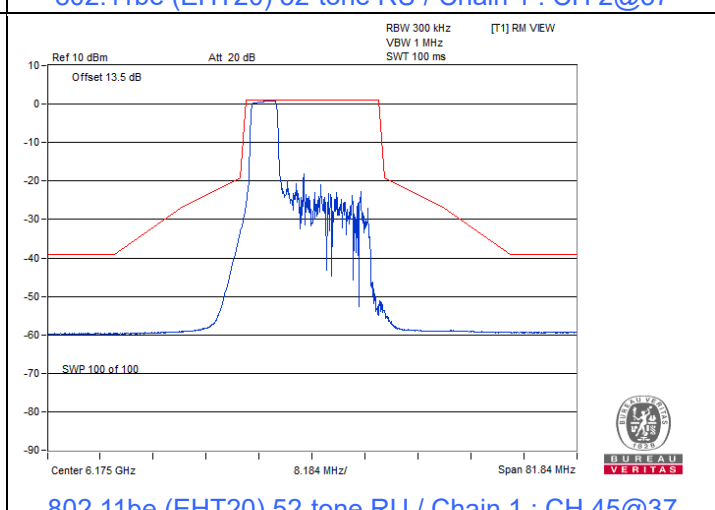

802.11be (EHT20) 52-tone RU / Chain 1 : CH 45@37

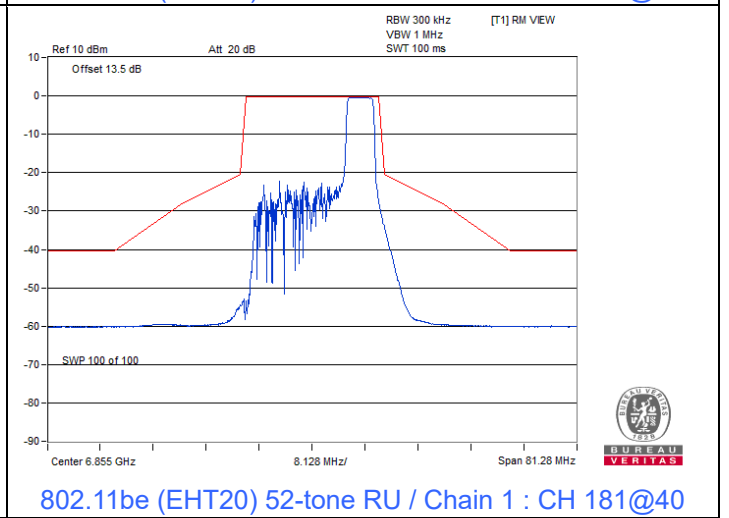
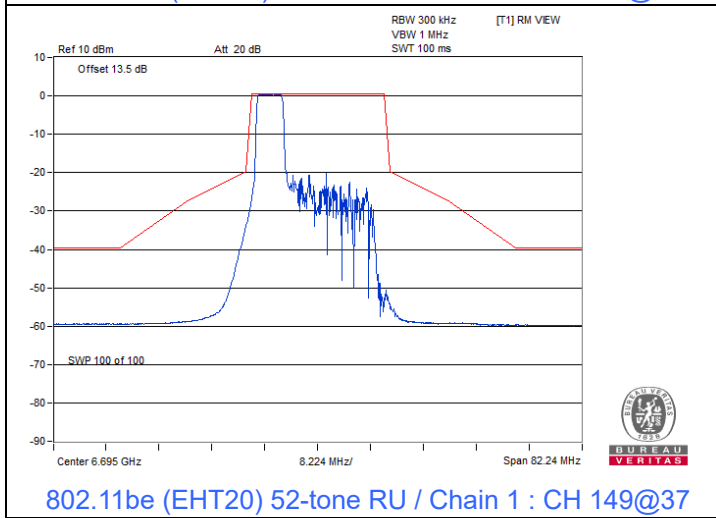
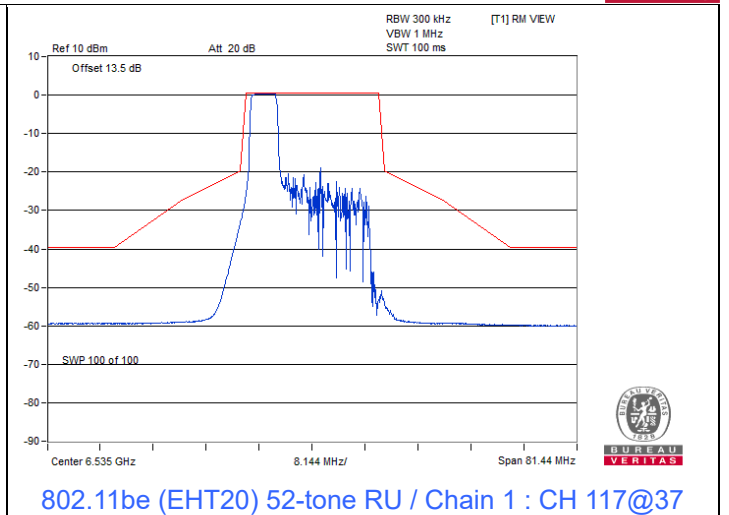
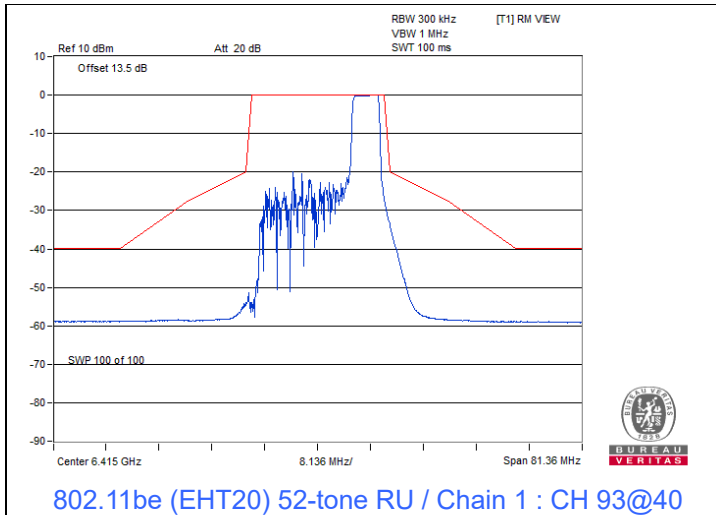

802.11be (EHT20) 106-tone RU

Spectrum Plot

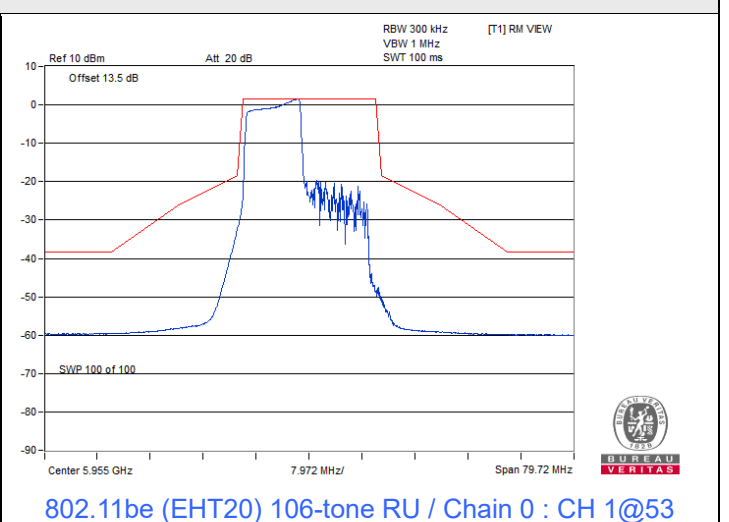
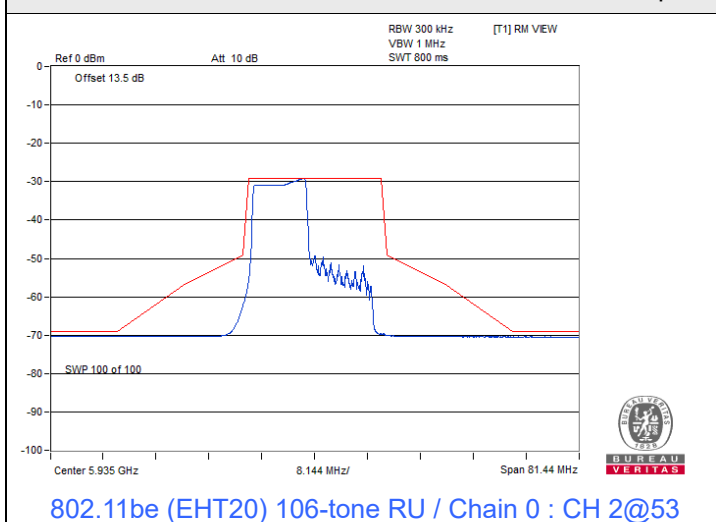

Spectrum Plot

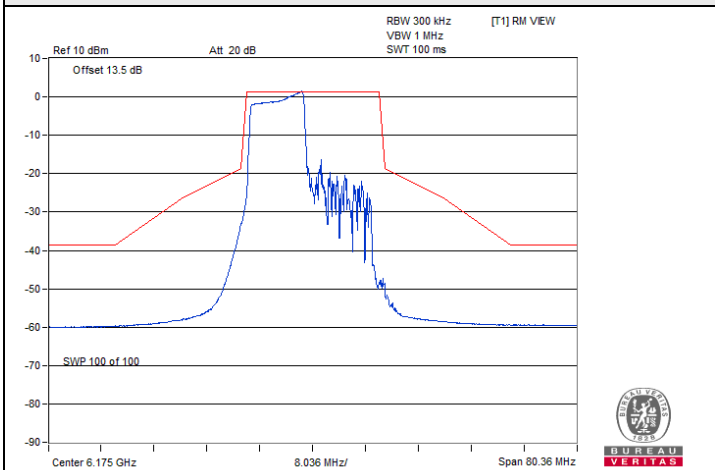

802.11be (EHT20) 106-tone RU / Chain 0 : CH 45@53

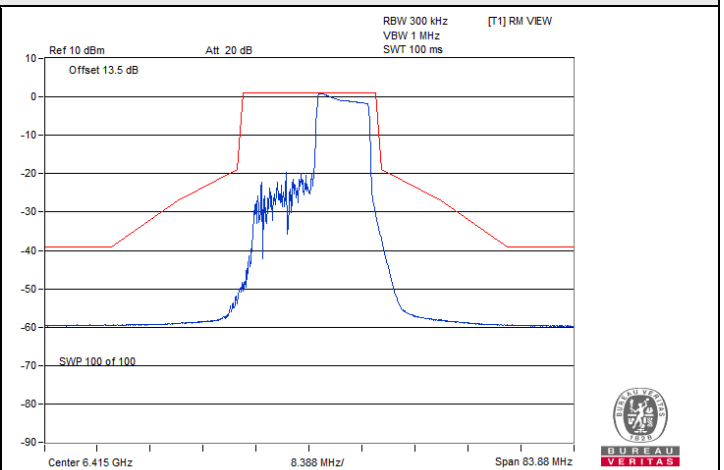

802.11be (EHT20) 106-tone RU / Chain 0 : CH 93@54

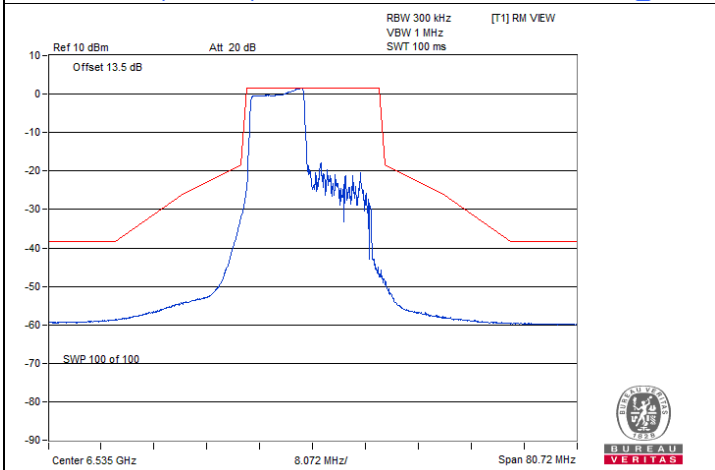

802.11be (EHT20) 106-tone RU / Chain 0 : CH 117@53

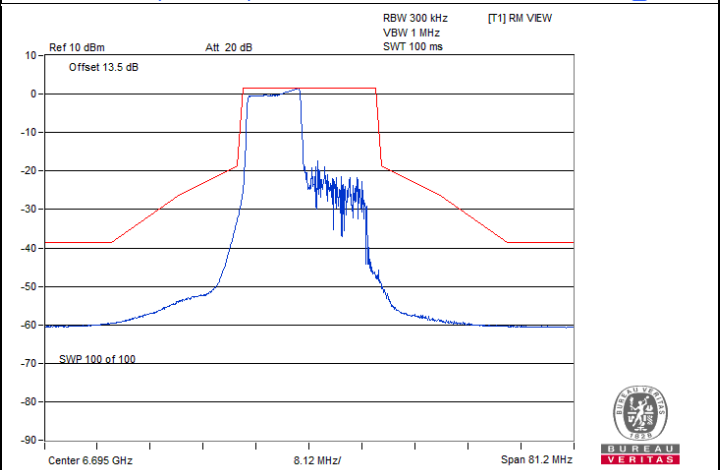

802.11be (EHT20) 106-tone RU / Chain 0 : CH 149@53

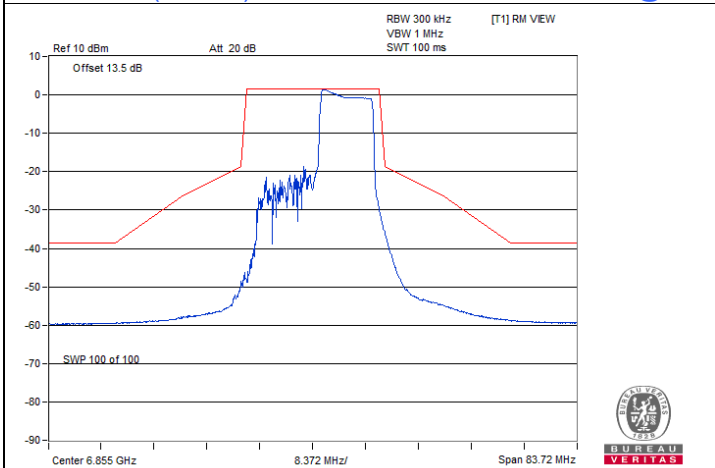

802.11be (EHT20) 106-tone RU / Chain 0 : CH 181@54

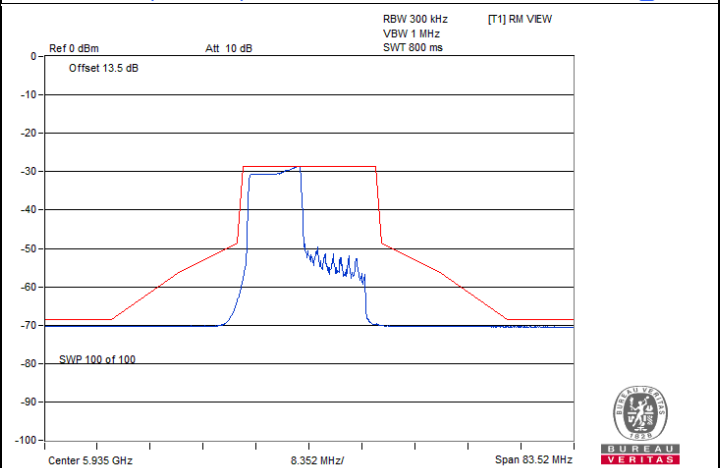

802.11be (EHT20) 106-tone RU / Chain 1 : CH 2@53

Spectrum Plot

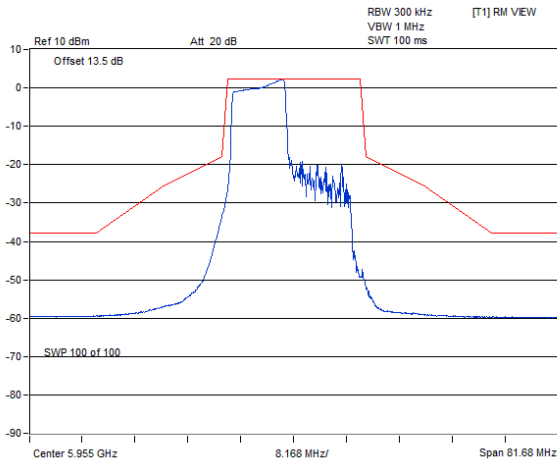

802.11be (EHT20) 106-tone RU / Chain 1 : CH 1@53

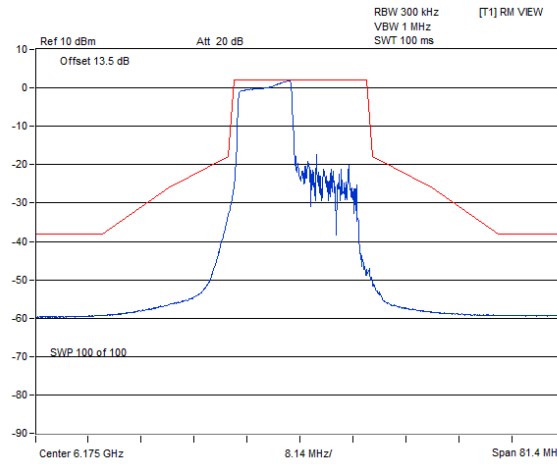

802.11be (EHT20) 106-tone RU / Chain 1 : CH 45@53

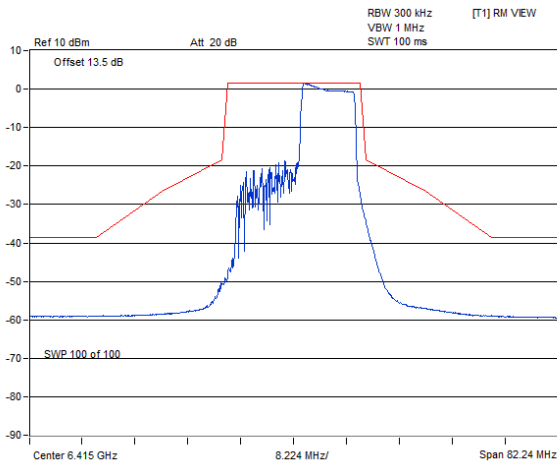

802.11be (EHT20) 106-tone RU / Chain 1 : CH 93@54

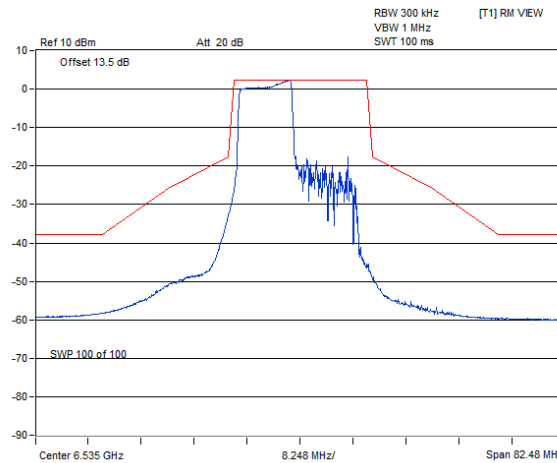

802.11be (EHT20) 106-tone RU / Chain 1 : CH 117@53

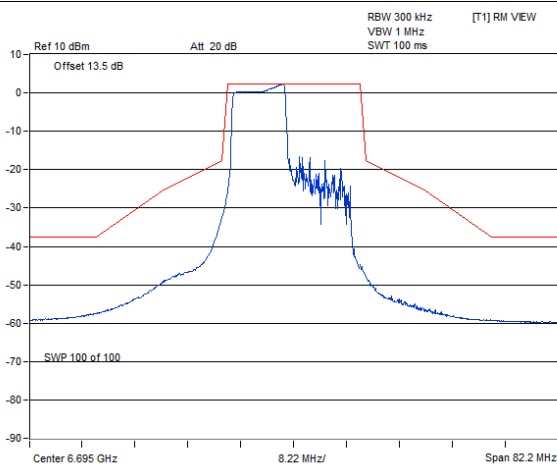

802.11be (EHT20) 106-tone RU / Chain 1 : CH 149@53

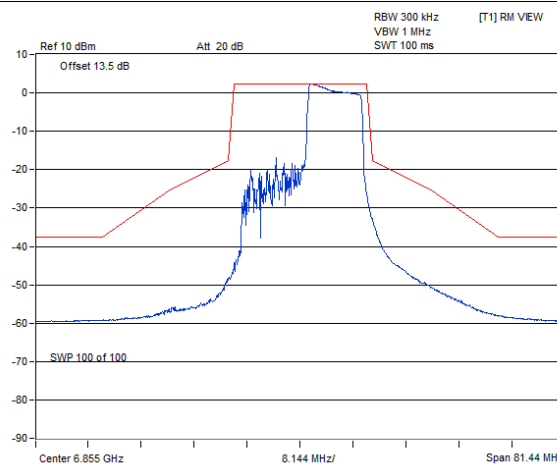

802.11be (EHT20) 106-tone RU / Chain 1 : CH 181@54

7.5 Occupied Bandwidth

Mode A

Input Power:	3.3 Vdc	Environmental Conditions:	24°C, 65% RH	Tested By:	Eric Peng
--------------	---------	---------------------------	--------------	------------	-----------

802.11a

Channel	Frequency (MHz)	Occupied Bandwidth (MHz)		Maximum Limit (MHz)	Test Result
		Chain 0	Chain 1		
2	5935	16.80	16.80	320	Pass
1	5955	16.74	16.80	320	Pass
45	6175	16.74	16.68	320	Pass
93	6415	16.74	16.80	320	Pass
97	6435	16.80	16.80	320	Pass
105	6475	16.80	16.80	320	Pass
113	6515	16.80	16.74	320	Pass
117	6535	16.74	16.68	320	Pass
149	6695	16.92	16.86	320	Pass
181	6855	16.86	16.74	320	Pass
185	6875	16.86	16.74	320	Pass
209	6995	16.86	16.80	320	Pass
233	7115	16.68	16.80	320	Pass

802.11be (EHT20)

Channel	Frequency (MHz)	Occupied Bandwidth (MHz)		Maximum Limit (MHz)	Test Result
		Chain 0	Chain 1		
2	5935	19.14	19.20	320	Pass
1	5955	18.96	18.90	320	Pass
45	6175	18.96	18.96	320	Pass
93	6415	19.02	19.02	320	Pass
97	6435	18.96	19.02	320	Pass
105	6475	18.96	18.96	320	Pass
113	6515	18.96	18.96	320	Pass
117	6535	18.96	18.90	320	Pass
149	6695	18.96	19.02	320	Pass
181	6855	18.90	18.96	320	Pass
185	6875	19.02	19.02	320	Pass
209	6995	19.02	18.90	320	Pass
233	7115	19.08	19.02	320	Pass

802.11be (EHT40)

Channel	Frequency (MHz)	Occupied Bandwidth (MHz)		Maximum Limit (MHz)	Test Result
		Chain 0	Chain 1		
3	5965	37.92	38.28	320	Pass
43	6165	38.28	37.92	320	Pass
91	6405	38.16	38.16	320	Pass
99	6445	38.16	38.16	320	Pass
107	6485	38.16	38.04	320	Pass
115	6525	38.16	38.28	320	Pass
123	6565	37.92	37.92	320	Pass
155	6725	37.80	38.04	320	Pass
179	6845	37.80	38.04	320	Pass
187	6885	37.92	38.04	320	Pass
211	7005	37.92	38.28	320	Pass
227	7085	38.28	38.16	320	Pass

802.11be (EHT80)

Channel	Frequency (MHz)	Occupied Bandwidth (MHz)		Maximum Limit (MHz)	Test Result
		Chain 0	Chain 1		
7	5985	77.52	76.80	320	Pass
39	6145	77.28	76.80	320	Pass
87	6385	77.76	76.56	320	Pass
103	6465	77.76	76.56	320	Pass
119	6545	76.56	76.80	320	Pass
151	6705	77.52	76.80	320	Pass
183	6865	77.76	76.80	320	Pass
199	6945	76.80	76.80	320	Pass
215	7025	76.80	76.56	320	Pass

802.11be (EHT160)

Channel	Frequency (MHz)	Occupied Bandwidth (MHz)		Maximum Limit (MHz)	Test Result
		Chain 0	Chain 1		
15	6025	156.96	156.96	320	Pass
47	6185	156.96	156.48	320	Pass
79	6345	156.96	156.48	320	Pass
111	6505	156.48	156.00	320	Pass
143	6665	156.48	156.48	320	Pass
175	6825	156.96	156.48	320	Pass
207	6985	156.48	156.48	320	Pass

802.11be (EHT320)

Channel	Frequency (MHz)	Occupied Bandwidth (MHz)		Maximum Limit (MHz)	Test Result
		Chain 0	Chain 1		
31	6105	312.96	311.04	320	Pass
63	6265	312.00	311.04	320	Pass
95	6425	312.00	311.04	320	Pass
127	6585	312.00	311.04	320	Pass
159	6745	311.04	311.04	320	Pass
191	6905	310.08	309.12	320	Pass

802.11be (EHT20) 26-tone RU

Channel	Frequency (MHz)	Occupied Bandwidth (MHz)		Maximum Limit (MHz)	Test Result
		Chain 0	Chain 1		
2	5935	18.54	18.48	320	Pass
1	5955	18.42	18.30	320	Pass
45	6175	18.36	17.88	320	Pass
93	6415	18.18	18.12	320	Pass
97	6435	17.94	18.48	320	Pass
105	6475	18.42	17.94	320	Pass
113	6515	18.24	17.82	320	Pass
117	6535	18.42	18.36	320	Pass
149	6695	18.12	17.76	320	Pass
181	6855	18.18	18.06	320	Pass
185	6875	18.30	17.64	320	Pass
209	6995	18.00	18.48	320	Pass
233	7115	18.06	18.42	320	Pass

802.11be (EHT20) 52-tone RU

Channel	Frequency (MHz)	Occupied Bandwidth (MHz)		Maximum Limit (MHz)	Test Result
		Chain 0	Chain 1		
2	5935	18.24	17.88	320	Pass
1	5955	18.06	17.94	320	Pass
45	6175	18.24	18.18	320	Pass
93	6415	18.18	18.00	320	Pass
97	6435	18.18	17.70	320	Pass
105	6475	17.34	17.46	320	Pass
113	6515	17.94	18.12	320	Pass
117	6535	18.00	17.22	320	Pass
149	6695	18.00	18.12	320	Pass
181	6855	18.12	18.00	320	Pass
185	6875	18.18	18.06	320	Pass
209	6995	18.00	17.82	320	Pass
233	7115	17.94	18.06	320	Pass

802.11be (EHT20) 106-tone RU

Channel	Frequency (MHz)	Occupied Bandwidth (MHz)		Maximum Limit (MHz)	Test Result
		Chain 0	Chain 1		
2	5935	16.98	17.82	320	Pass
1	5955	18.00	17.70	320	Pass
45	6175	17.94	17.64	320	Pass
93	6415	17.76	17.76	320	Pass
97	6435	18.06	17.70	320	Pass
105	6475	18.06	17.70	320	Pass
113	6515	17.82	17.82	320	Pass
117	6535	17.58	17.94	320	Pass
149	6695	17.94	18.06	320	Pass
181	6855	17.94	17.94	320	Pass
185	6875	17.94	17.88	320	Pass
209	6995	17.94	17.52	320	Pass
233	7115	18.00	18.06	320	Pass



Spectrum Plot of Maximum Value

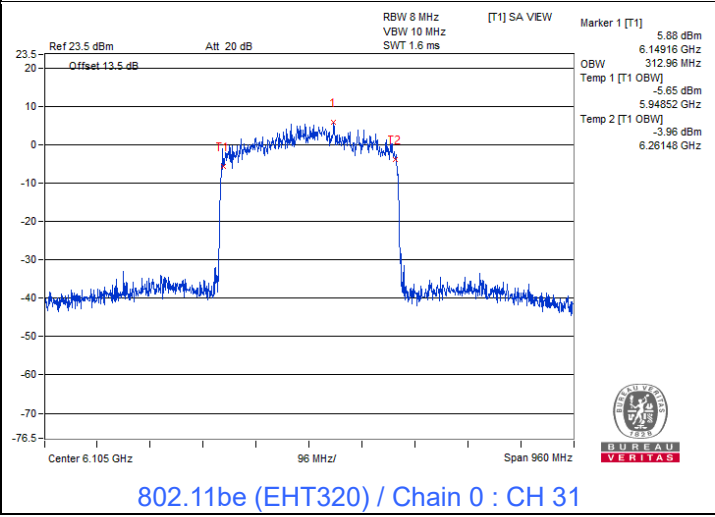
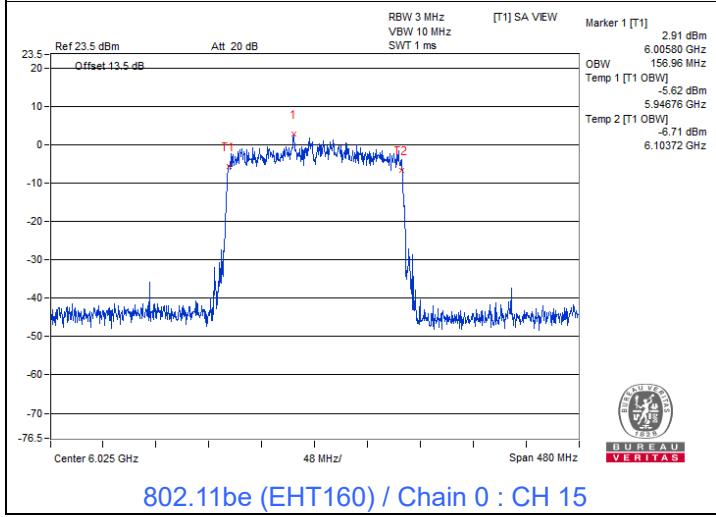
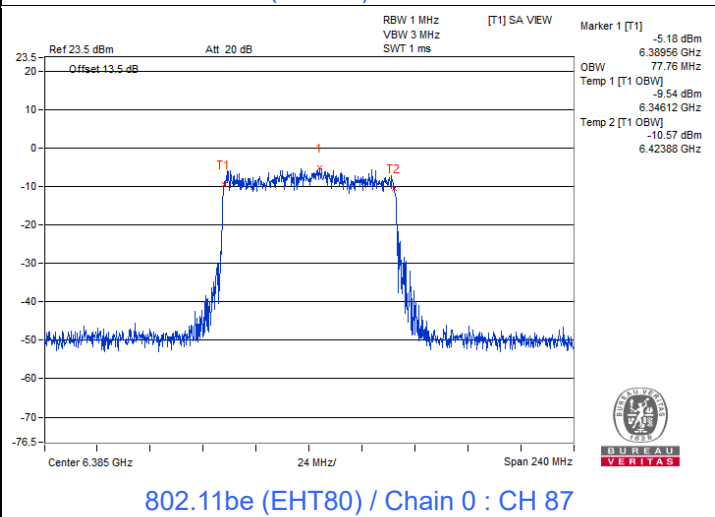
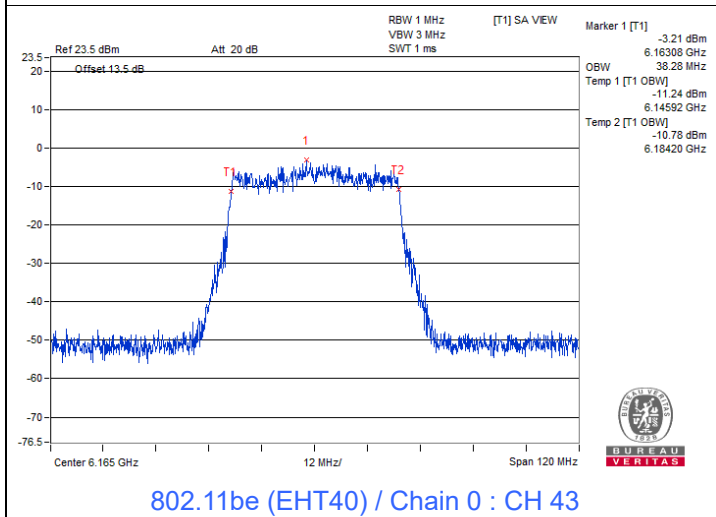
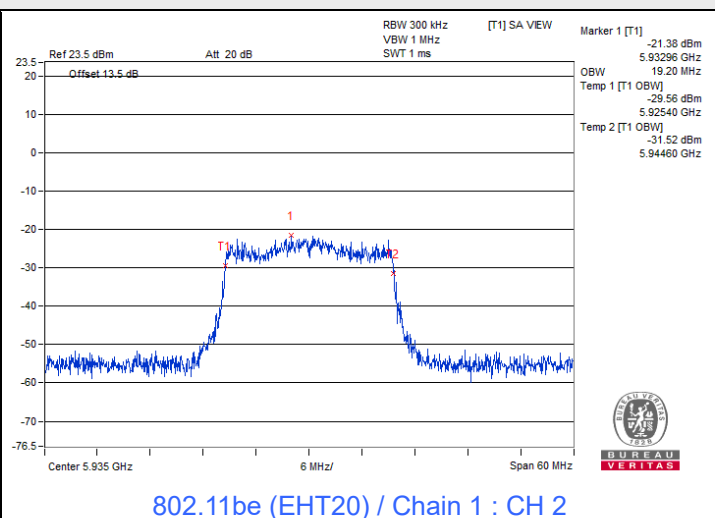
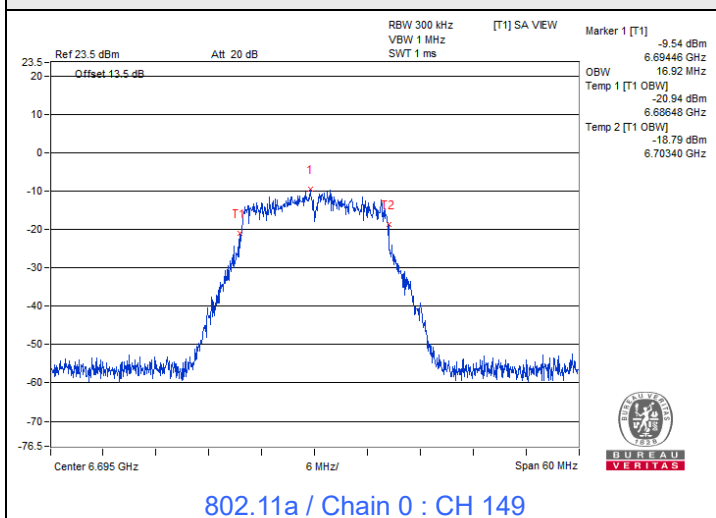

Spectrum Plot of Maximum Value

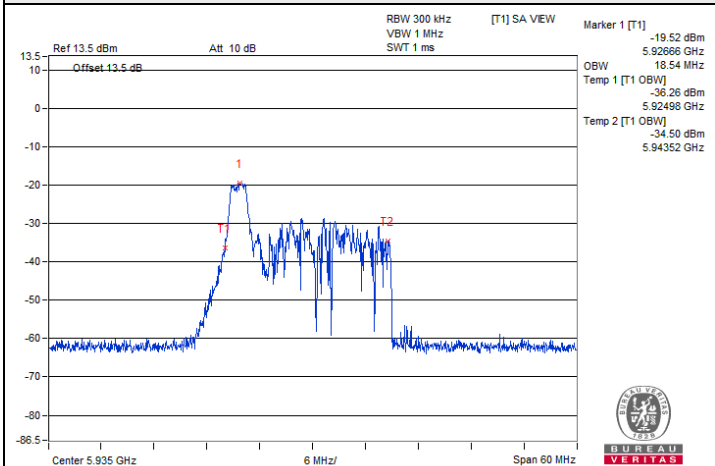

802.11be (EHT20) 26-tone RU / Chain 0 : CH 2

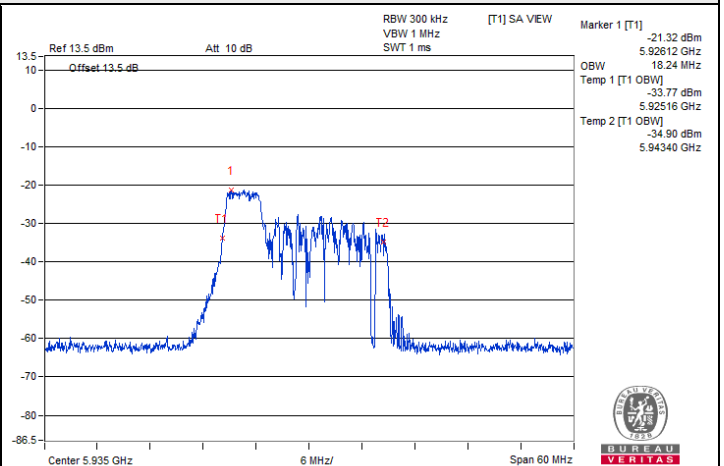

802.11be (EHT20) 52-tone RU / Chain 0 : CH 2

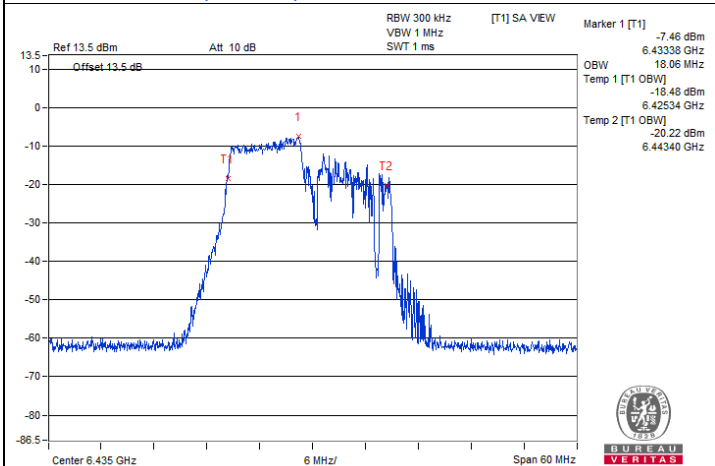

802.11be (EHT20) 106-tone RU / Chain 0 : CH 97@53

Mode C

Input Power:	3.3 Vdc	Environmental Conditions:	24°C, 64% RH	Tested By:	Eric Peng
--------------	---------	---------------------------	--------------	------------	-----------

802.11a

Channel	Frequency (MHz)	Occupied Bandwidth (MHz)		Maximum Limit (MHz)	Test Result
		Chain 0	Chain 1		
2	5935	16.80	16.80	320	Pass
1	5955	16.74	16.80	320	Pass
45	6175	16.74	16.80	320	Pass
93	6415	16.74	16.74	320	Pass
117	6535	16.74	16.74	320	Pass
149	6695	16.80	16.68	320	Pass
181	6855	16.80	16.74	320	Pass

802.11be (EHT20)

Channel	Frequency (MHz)	Occupied Bandwidth (MHz)		Maximum Limit (MHz)	Test Result
		Chain 0	Chain 1		
2	5935	19.14	19.20	320	Pass
1	5955	18.90	18.90	320	Pass
45	6175	18.90	19.02	320	Pass
93	6415	18.96	18.96	320	Pass
117	6535	18.96	18.90	320	Pass
149	6695	19.02	19.02	320	Pass
181	6855	18.96	18.96	320	Pass

802.11be (EHT40)

Channel	Frequency (MHz)	Occupied Bandwidth (MHz)		Maximum Limit (MHz)	Test Result
		Chain 0	Chain 1		
3	5965	38.04	37.92	320	Pass
43	6165	38.16	37.92	320	Pass
91	6405	37.80	38.04	320	Pass
123	6565	38.04	37.92	320	Pass
155	6725	37.80	37.92	320	Pass
179	6845	38.16	38.16	320	Pass

802.11be (EHT80)

Channel	Frequency (MHz)	Occupied Bandwidth (MHz)		Maximum Limit (MHz)	Test Result
		Chain 0	Chain 1		
7	5985	76.80	76.80	320	Pass
39	6145	76.80	76.56	320	Pass
87	6385	76.80	76.80	320	Pass
135	6625	76.56	76.56	320	Pass
151	6705	76.80	76.32	320	Pass
167	6785	76.80	76.80	320	Pass

802.11be (EHT160)

Channel	Frequency (MHz)	Occupied Bandwidth (MHz)		Maximum Limit (MHz)	Test Result
		Chain 0	Chain 1		
15	6025	156.96	156.96	320	Pass
47	6185	156.48	156.96	320	Pass
79	6345	157.44	156.48	320	Pass
143	6665	156.48	156.00	320	Pass

802.11be (EHT320)

Channel	Frequency (MHz)	Occupied Bandwidth (MHz)		Maximum Limit (MHz)	Test Result
		Chain 0	Chain 1		
31	6105	312.96	312.00	320	Pass
63	6265	310.08	311.04	320	Pass

802.11be (EHT20) 26-tone RU

Channel	Frequency (MHz)	Occupied Bandwidth (MHz)		Maximum Limit (MHz)	Test Result
		Chain 0	Chain 1		
2	5935	18.54	18.48	320	Pass
1	5955	18.36	18.18	320	Pass
45	6175	18.36	18.36	320	Pass
93	6415	18.06	18.48	320	Pass
117	6535	18.30	17.76	320	Pass
149	6695	18.12	18.12	320	Pass
181	6855	18.18	18.36	320	Pass

802.11be (EHT20) 52-tone RU

Channel	Frequency (MHz)	Occupied Bandwidth (MHz)		Maximum Limit (MHz)	Test Result
		Chain 0	Chain 1		
2	5935	18.24	17.88	320	Pass
1	5955	17.94	17.58	320	Pass
45	6175	18.18	18.06	320	Pass
93	6415	18.06	18.00	320	Pass
117	6535	18.06	17.70	320	Pass
149	6695	17.52	18.00	320	Pass
181	6855	18.18	17.88	320	Pass

802.11be (EHT20) 106-tone RU

Channel	Frequency (MHz)	Occupied Bandwidth (MHz)		Maximum Limit (MHz)	Test Result
		Chain 0	Chain 1		
2	5935	16.98	17.82	320	Pass
1	5955	17.22	17.94	320	Pass
45	6175	17.46	18.12	320	Pass
93	6415	17.94	17.82	320	Pass
117	6535	17.94	17.94	320	Pass
149	6695	18.06	17.16	320	Pass
181	6855	17.94	18.06	320	Pass

Spectrum Plot of Maximum Value

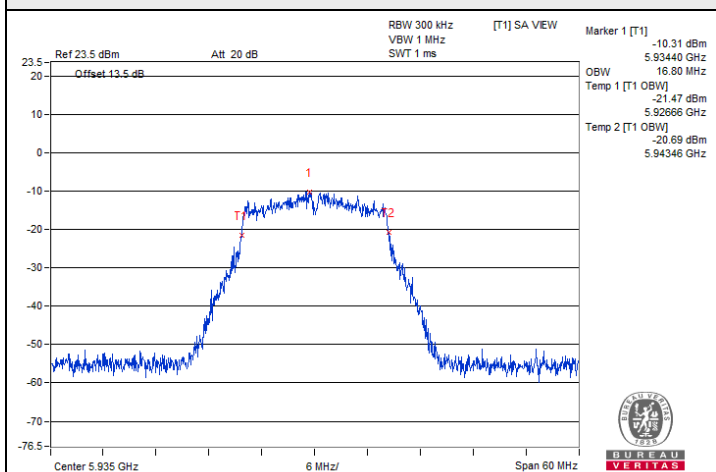

802.11a / Chain 0 : CH 2

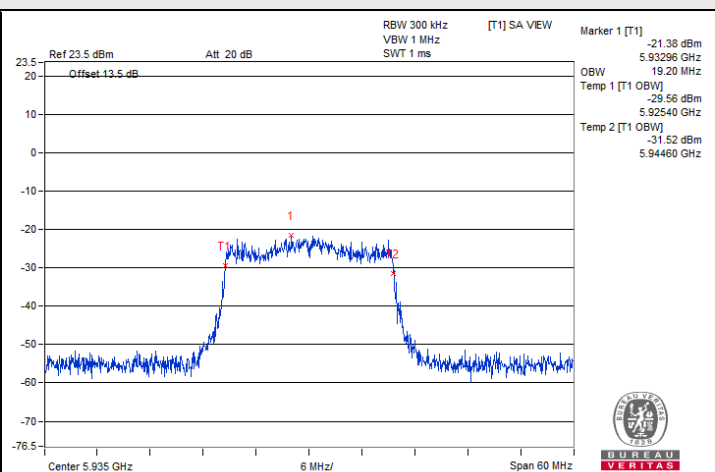

802.11be (EHT20) / Chain 1 : CH 2

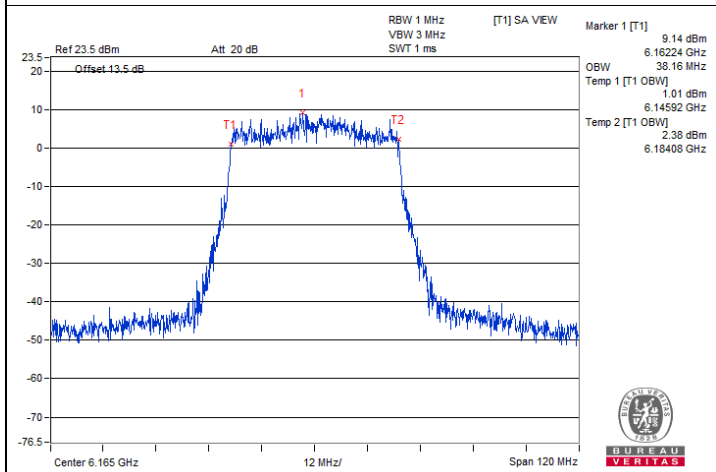

802.11be (EHT40) / Chain 0 : CH 43

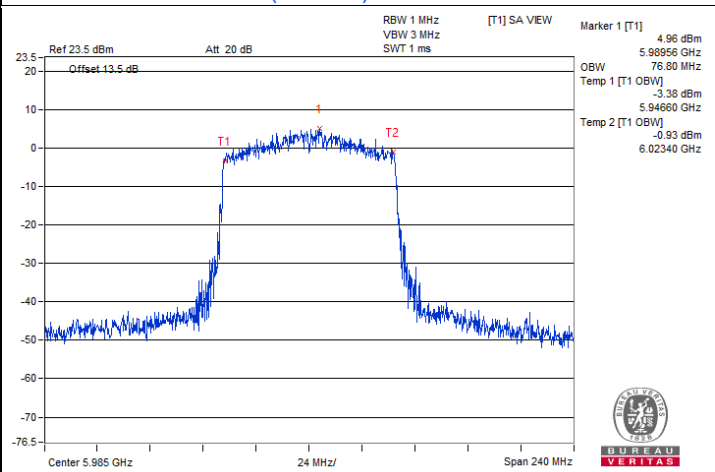

802.11be (EHT80) / Chain 0 : CH 7

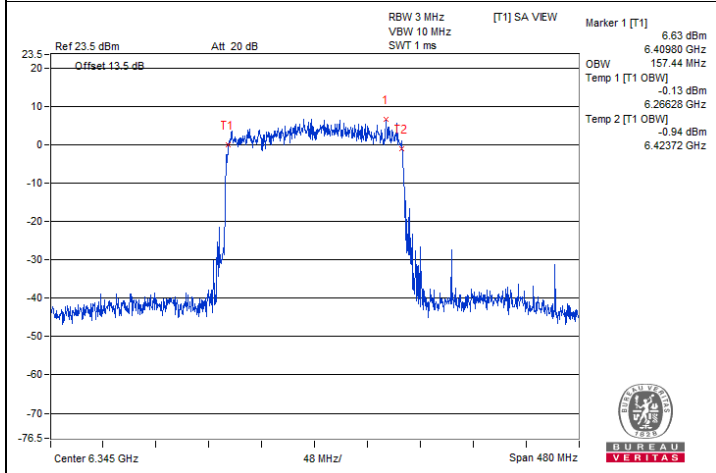

802.11be (EHT160) / Chain 0 : CH 79

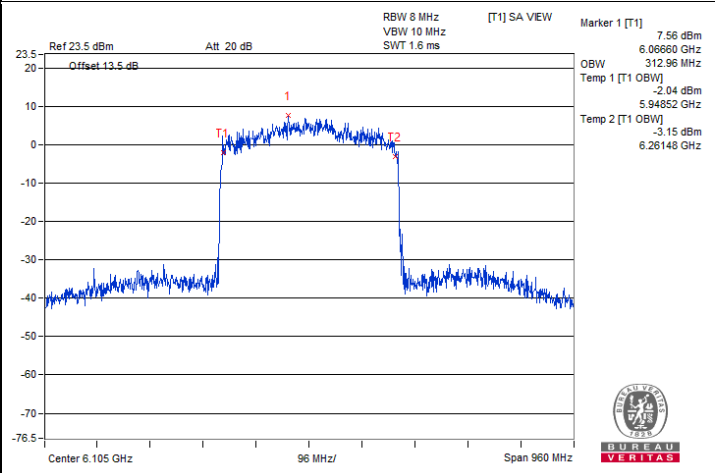

802.11be (EHT320) / Chain 0 : CH 31

Spectrum Plot of Maximum Value

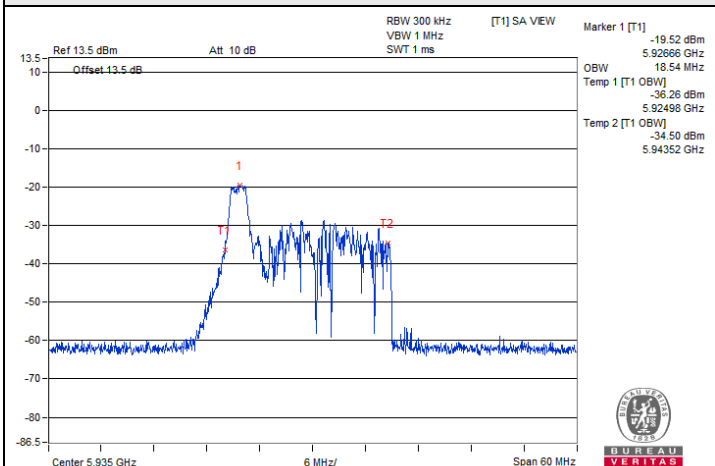

802.11be (EHT20) 26-tone RU / Chain 0 : CH 2

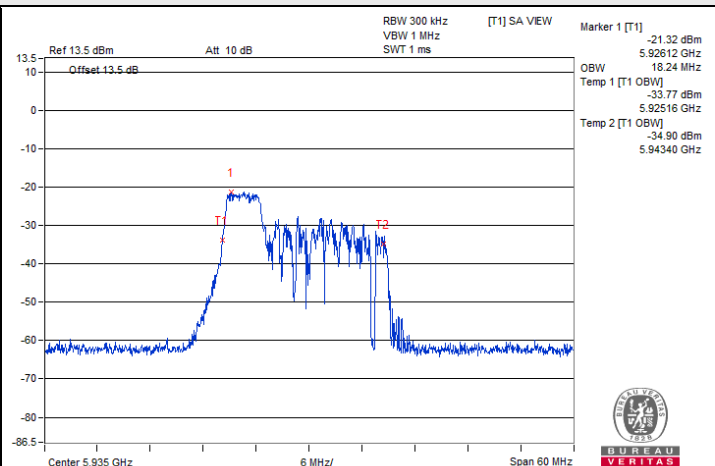

802.11be (EHT20) 52-tone RU / Chain 0 : CH 2

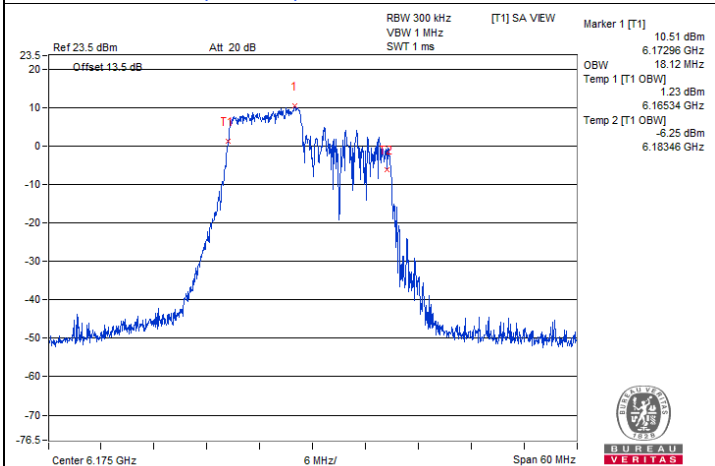

802.11be (EHT20) 106-tone RU / Chain 1 : CH 45@53

7.6 Frequency Stability

Mode A

Input Power:	3.3 Vdc	Environmental Conditions:	24°C, 65% RH	Tested By:	Eric Peng
--------------	---------	---------------------------	--------------	------------	-----------

802.11a

Frequency Stability Versus Temperature									
Operating Frequency: 5935 MHz									
Temp. (°C)	Power Supply (Vdc)	0 Minute		2 Minutes		5 Minutes		10 Minutes	
		Measured Frequency (MHz)	Test Result	Measured Frequency (MHz)	Test Result	Measured Frequency (MHz)	Test Result	Measured Frequency (MHz)	Test Result
70	3.3	5934.9943	Pass	5934.9942	Pass	5934.9966	Pass	5934.9955	Pass
60	3.3	5934.992	Pass	5934.9932	Pass	5934.9928	Pass	5934.9928	Pass
50	3.3	5934.9984	Pass	5935.0016	Pass	5934.9982	Pass	5934.9996	Pass
40	3.3	5935.0114	Pass	5935.0134	Pass	5935.0118	Pass	5935.015	Pass
30	3.3	5934.995	Pass	5934.9947	Pass	5934.994	Pass	5934.9961	Pass
20	3.3	5934.9925	Pass	5934.989	Pass	5934.9934	Pass	5934.9882	Pass
10	3.3	5935.0267	Pass	5935.0271	Pass	5935.0288	Pass	5935.0312	Pass
0	3.3	5935.0272	Pass	5935.0295	Pass	5935.0289	Pass	5935.0263	Pass
-10	3.3	5934.9912	Pass	5934.9876	Pass	5934.9914	Pass	5934.9907	Pass

Frequency Stability Versus Voltage									
Operating Frequency: 5935 MHz									
Temp. (°C)	Power Supply (Vdc)	0 Minute		2 Minutes		5 Minutes		10 Minutes	
		Measured Frequency (MHz)	Test Result	Measured Frequency (MHz)	Test Result	Measured Frequency (MHz)	Test Result	Measured Frequency (MHz)	Test Result
20	3.795	5934.9896	Pass	5934.9888	Pass	5934.9896	Pass	5934.9872	Pass
	3.3	5934.9925	Pass	5934.989	Pass	5934.9934	Pass	5934.9882	Pass
	2.805	5935.0015	Pass	5934.9975	Pass	5934.9979	Pass	5934.9982	Pass

7.7 Contention-based Protocol

Mode A

Input Power:	3.3 Vdc	Environmental Conditions:	25°C, 60% RH	Tested By:	Tobey Chen
--------------	---------	---------------------------	--------------	------------	------------

For U-NII-5

Contention Based Protocol Measurement										
Operation Mode	Channel Bandwidth (MHz)	Channel Number	Channel Freq. (MHz)	Injected Signal (AWGN)		Antenna Gain (dBi)	Path Loss (dB) (Note 3)	Adjusted Power (dBm)	Detection Limit	EUT TX Status
				Freq. (MHz)	Power (dBm)					
802.11be	20	1	5955	5955	-65.18	4.75	0	-69.93	-62	OFF
					-65.68	4.75	0	-70.43	-62	Minimal
					-77.25	4.75	0	-82	-62	ON
	320	31	6105	5950	-64.23	4.75	0	-68.98	-62	OFF
					-64.73	4.75	0	-69.48	-62	Minimal
					-77.25	4.75	0	-82	-62	ON
				6105	-64.36	4.75	0	-69.11	-62	OFF
					-64.86	4.75	0	-69.61	-62	Minimal
					-77.25	4.75	0	-82	-62	ON
				6260	-64.13	4.75	0	-68.88	-62	OFF
					-64.63	4.75	0	-69.38	-62	Minimal
					-77.25	4.75	0	-82	-62	ON

Notes:

1. After investigation (consider antenna gain and path loss) , the one representative port (Chain 0) was measured and presented in the report.
2. Adjusted Power (dBm) = Injected Signal (AWGN) Power (dBm) - Antenna Gain (dBi) + Path Loss (dB)
3. Antenna gain values include all the applicable path losses.

Contention Based Protocol Detection Probability															
Operation Mode	Channel Bandwidth (MHz)	AWGN Signal Freq. (MHz)	#01	#02	#03	#04	#05	#06	#07	#08	#09	#10	Detection Probability	Detection Limit	Test Result
802.11be	20	5955	v	v	v	v	v	v	v	v	v	v	100%	90%	Pass
	320	5950	v	x	v	v	v	v	v	v	v	v	90%	90%	Pass
		6105	v	v	v	x	v	v	v	v	v	v	90%	90%	Pass
		6260	v	v	v	v	x	v	v	v	v	v	90%	90%	Pass

Plots of EUT Tx waveform

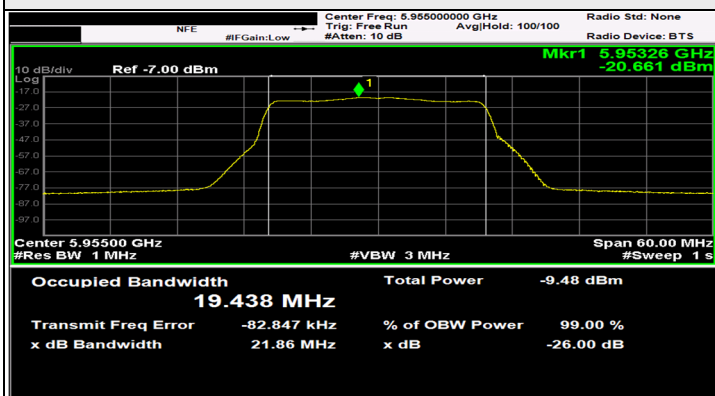

802.11be (HE20) / CH1

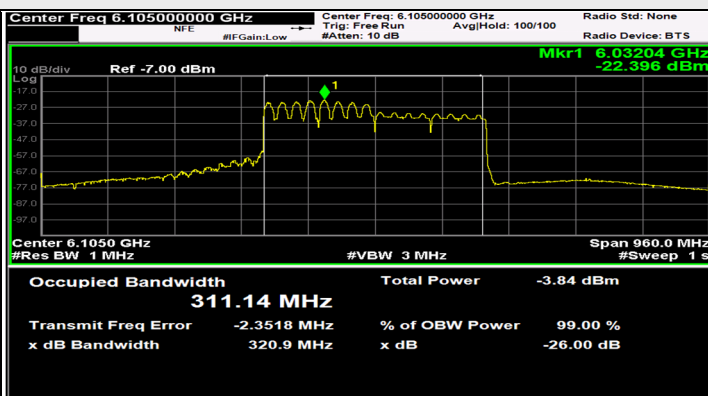

802.11be (HE320) / CH31

Plots of Injected signal (AWGN) level

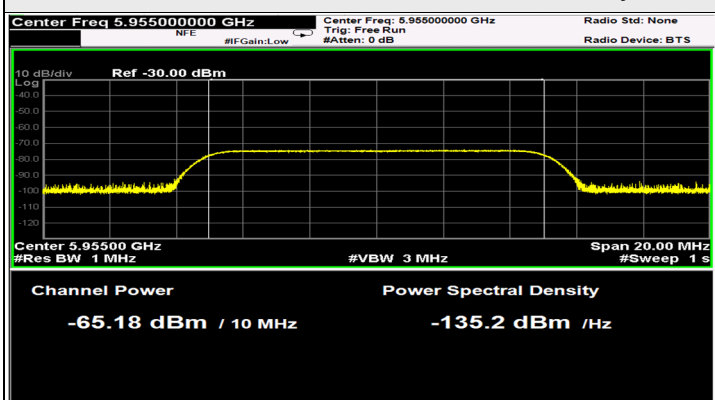

802.11be (HE20) / CH1

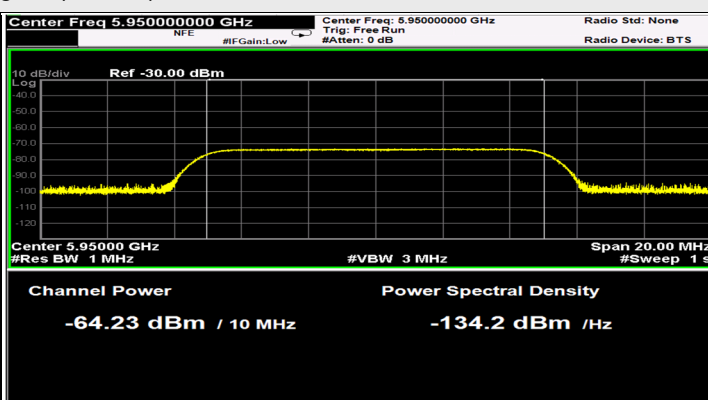

802.11be (HE320) / CH31(Low Edge)

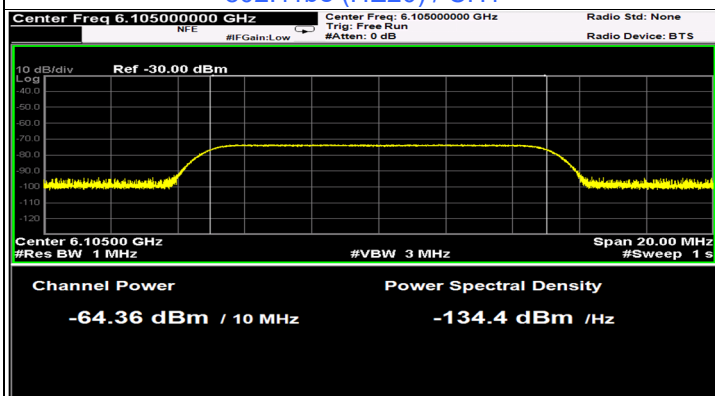

802.11be (HE320) / CH31(Middle)

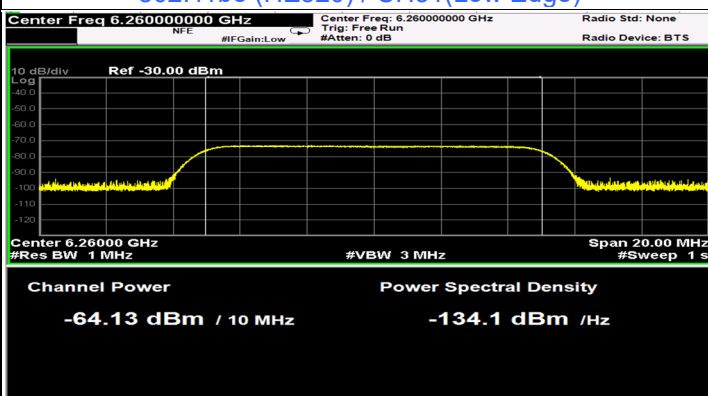

802.11be (HE320) / CH31(High Edge)



Plots of EUT ceased transmission in the time domain

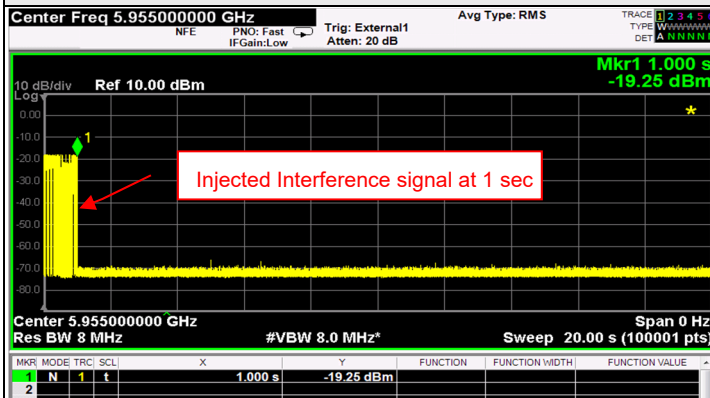

802.11be (HE20) / CH1

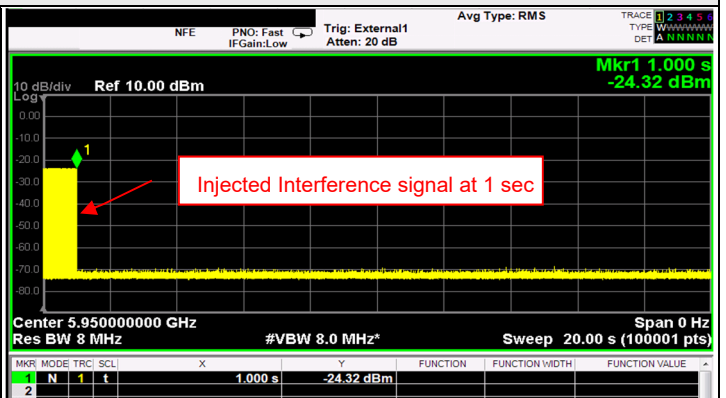

802.11be (HE320) / CH31(Low Edge)

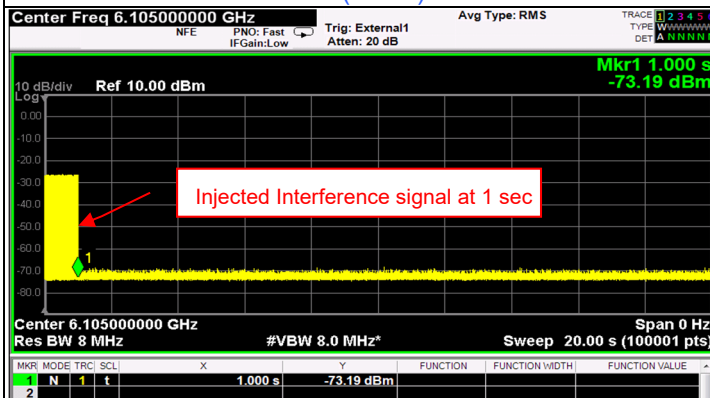

802.11be (HE320) / CH31(Middle)

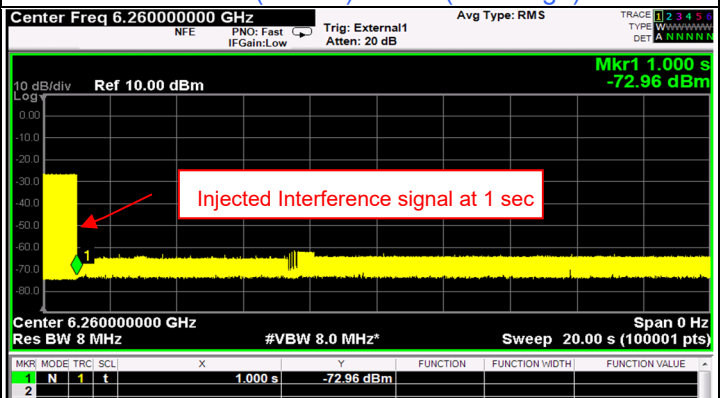

802.11be (HE320) / CH31(High Edge)



Contention Based Protocol Measurement											
Operation Mode	Channel Bandwidth (MHz)	Channel Number	Channel Freq. (MHz)	Injected Signal (AWGN)		Antenna Gain (dBi)	Path Loss (dB) (Note 3)	Adjusted Power (dBm)	Detection Limit	EUT TX Status	
				Freq. (MHz)	Power (dBm)						
802.11be	20	97	6435	6435	-64.37	4.29	0	-68.66	-62	OFF	
					-64.87	4.29	0	-69.16	-62	Minimal	
					-77.71	4.29	0	-82	-62	ON	
	320	95	6425	6425	-64.02	4.29	0	-68.31	-62	OFF	
					-64.52	4.29	0	-68.81	-62	Minimal	
					-77.71	4.29	0	-82	-62	ON	
		95	6425	6425	-64.21	4.29	0	-68.5	-62	OFF	
					-64.71	4.29	0	-69	-62	Minimal	
					-77.71	4.29	0	-82	-62	ON	
			6580	6425	6425	-64.11	4.29	0	-68.4	-62	OFF
						-64.61	4.29	0	-68.9	-62	Minimal
						-77.71	4.29	0	-82	-62	ON

Notes:

1. After investigation (consider antenna gain and path loss) , the one representative port (Chain 0) was measured and presented in the report.
2. Adjusted Power (dBm) = Injected Signal (AWGN) Power (dBm) - Antenna Gain (dBi) + Path Loss (dB)
3. Antenna gain values include all the applicable path losses.

Contention Based Protocol Detection Probability																
Operation Mode	Channel Bandwidth (MHz)	AWGN Signal Freq. (MHz)	Radio Device: BTS										Detection Probability	Detection Limit	Test Result	
			#01	#02	#03	#04	#05	#06	#07	#08	#09	#10				
802.11be	20	6435	v	v	v	v	v	v	v	v	v	v	v	100%	90%	Pass
	320	6270	v	x	v	v	v	v	v	v	v	v	v	90%	90%	Pass
		6425	v	v	v	v	v	x	v	v	v	v	v	90%	90%	Pass
		6580	v	v	v	v	x	v	v	v	v	v	v	90%	90%	Pass

