

ANTENNA INFORMATION

OEM	
ODM	Lenovo
Platform model name	Qualcomm
Intel platform (ex: Yes, No or NA)	No
Platform type (ex: regular NB, convertible PC, AIO...etc)	Regular NB
SAR minimum separation (mm)	8.6mm

Antenna manufacturer	INPAQ	
Address	No.5, Chunqiu Road, Panyang Industrial Park, Huangdai Town, Xiangcheng Zone, Suzhou City 215143, Jiangsu Province, China	
Antenna Part number	Main: DC330023K00	Aux: DC330023K10
Antenna type (ex: PIFA, Dipole...etc)	PIFA	

Antenna Peak gain w/ cable loss (dBi)*										
	2.4GHz 2400-2483.5 MHz	5.2GHz 5150-5250MHz	5.3GHz 5250-5350MHz	5.6GHz 5470-5725MHz	5.8GHz 5725-5850MHz	5.9GHz 5850-5895MHz	6.2GHz 5925-6425MHz	6.5GHz 6425-6525MHz	6.7GHz 6525-6875MHz	7.0 GHz 6875-7125MHz
Main	0.81	1.26	1.57	1.62	0.91	0.46	1.31	0.34	0.68	0.45
Aux	0.53	0.96	0.46	0.84	0.84	0.74	0.27	0.17	0.84	0.37

Cable Assembly Part Number and Information					
	Cable PN	Cable length(cm)	Cable diameter(mm)	Impedance(ohm)	Connector type
Main	SY113L/50-048	317	OD 1.13	50	I-pex:20565-001R-13
Aux	SY113L/50-050	297	OD 1.13	50	I-pex:20565-001R-13

* 3D Antenna Peak Gain required being test in system basis.

Antenna cable loss (dBi)*										
	2.4GHz 2400-2483.5 MHz	5.2GHz 5150-5250MHz	5.3GHz 5250-5350MHz	5.6GHz 5470-5725MHz	5.8GHz 5725-5850MHz	5.9GHz 5850-5895MHz	6.2GHz 5925-6425MHz	6.5GHz 6425-6525MHz	6.7GHz 6525-6875MHz	7.0 GHz 6875-7125MHz
Main	-0.85	-1.42	-1.53	-1.62	-1.68	-1.74	-1.81	-1.93	-2.06	-2.31
Aux	-0.91	-1.48	-1.59	-1.68	-1.74	-1.81	-1.87	-1.99	-2.12	-2.37

Table of Contents

Cover page	1
1. Intel Reference Gain and Type	3
2. Document Revision History	3
3. Test & System Description	
3.1 Measurement Method and System.....	4
3.2 Test setup.....	4
3.3 Equipment list.....	5
4. Radiation characteristics of antenna loaded in Host Platform	6
Annex A. Photographs	
A.1 Setup Photo.....	16
A.2 Test sample.....	17
Annex B. Antenna Location	
B.1 Antenna Host Platform Location Information.....	19
B.2 Antenna dimensional information for SAR evaluation.....	20

1. Intel Reference Gain and Type

Antenna Peak gain w/ cable loss (dBi)											
Band/Frequency		2.4GHz 2400-2483.5 MHz	5.2GHz 5150-5250MHz	5.3GHz 5250-5350MHz	5.6GHz 5470-5725MHz	5.8GHz 5725-5850MHz	5.9GHz 5850-5895MHz	6.2GHz 5925-6425MHz	6.5GHz 6425-6525MHz	6.7GHz 6525-6875MHz	7.0 GHz 6875-7125MHz
Design	EU/UK	3.00	5.00	5.00	5.00	5.00	5.00	5.00	5.00	5.00	5.00
PIFA	For WiFi 6E and earlier	3.24	3.64	3.73	4.77	4.97	4.72	4.83	4.30	5.37	5.59
	From WiFi 7	2.95	5.11	4.55	5.15	5.13	4.45	5.02	5.02	4.96	4.96
Dipole	For WiFi 6E and earlier	2.89	2.92	3.19	4.41	4.22	4.22	4.83	4.30	4.49	5.34
	From WiFi 7	2.95	4.03	4.11	5.15	5.13	4.45	5.02	4.71	4.49	4.96

3D Peak Antenna gain should be equal or greater than -2 dBi

If a host integrator plans to use a lower gain antenna of the same type, additional CBP(FCC)/EDT(EU) testing need to be performed while the module is installed in the host.

2. Document Revision History

Revision #	Revision Details	Issued Date
Rev. 00	First Issue	

3. Test & System Description

3.1 Measurement Method and System

1. Use a low-loss coaxial cable to connect the notebook fixture
2. Fix the notebook fixture on the turntable
3. Connect the jig to the network analyzer port, and use the antenna of the test probe to collect data

3.2 Test setup

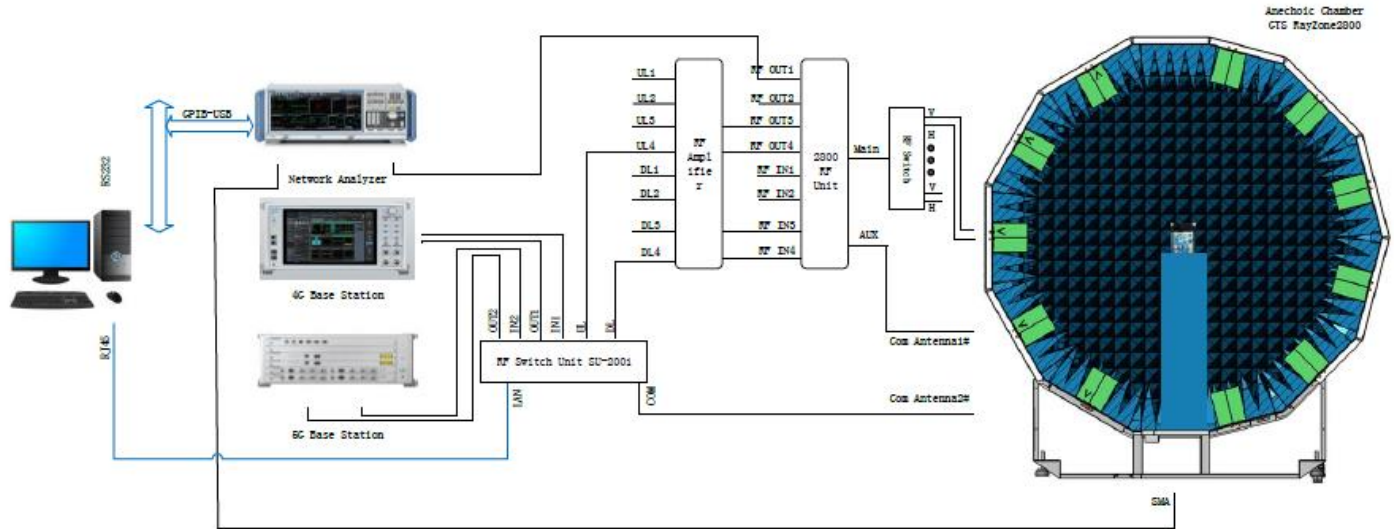

3.3 Equipment list

Number	Device	Manufacturer	Cal.Date	Cal.Due.Date
1	Anechoic Chamber	GTS	2022/6/15	2023/6/14
2	measurement antenna	GTS	2022/6/15	2023/6/14
3	Network Analyzer	Keysight	2022/6/15	2023/6/14
4	turn table control box	GTS	N/A	N/A
5	turn table control computer	GTS	N/A	N/A
6	test system host	GTS	N/A	N/A
7	RF line TX	Times	N/A	N/A
8	RF line RX	Times	N/A	N/A
9	cable 2m 1GHz-8.5GHz	Times	N/A	N/A
10	optical fiber line	Times	N/A	N/A

4. Radiation characteristics of antenna loaded in Host Platform

Main Antenna

Max Antenna 3D Radiation Pattern 2400 – 2483.5 MHz

Frequency (MHz)	Peak Gain w/ Cable Loss (dBi)
2400-2483.5	0.81

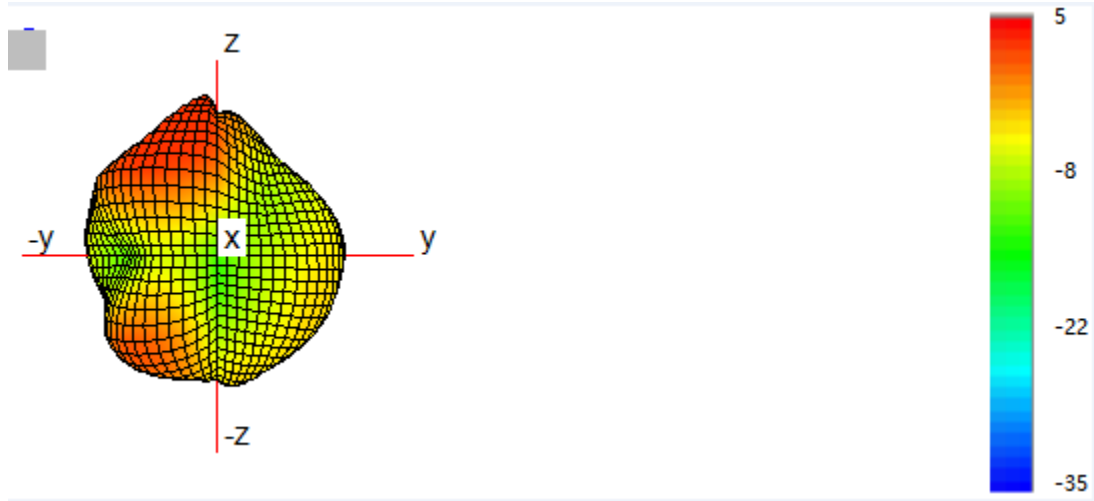

Max Antenna 3D Radiation Pattern 5150-5250 MHz

Frequency (MHz)	Peak Gain w/ Cable Loss (dBi)
5150-5250	1.26

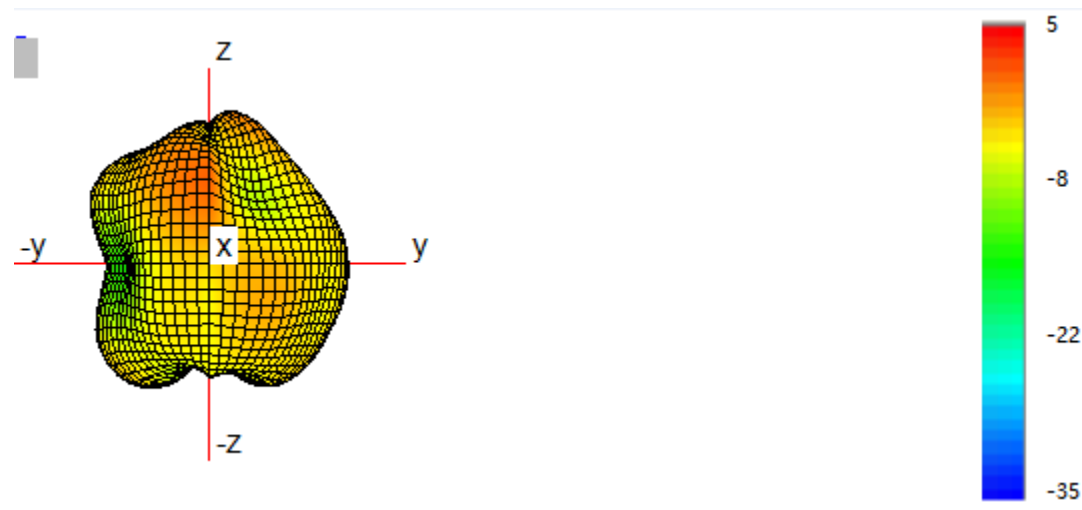

Max Antenna 3D Radiation Pattern 5250-5350 MHz

Frequency (MHz)	Peak Gain w/ Cable Loss (dBi)
5250-5350	1.57

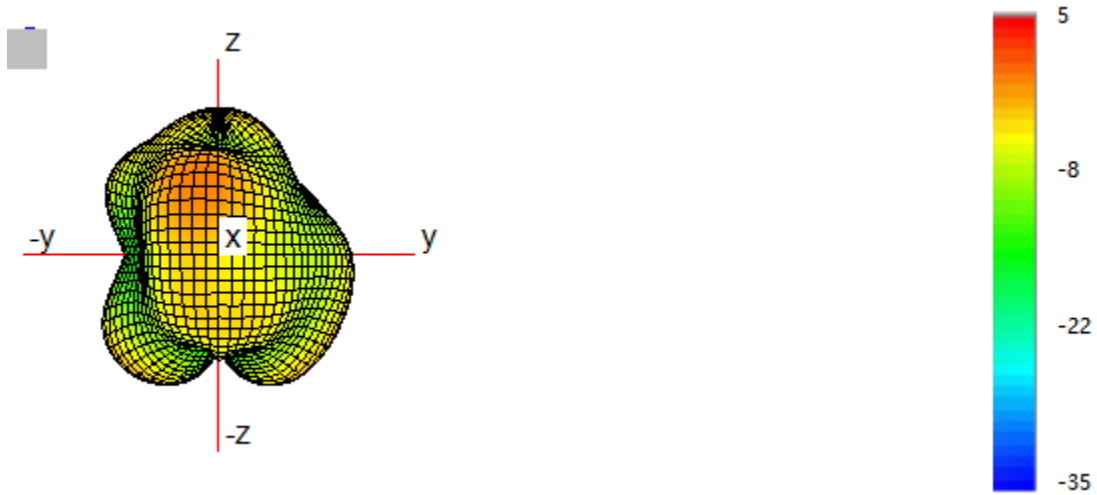

Max Antenna 3D Radiation Pattern 5470-5725 MHz

Frequency (MHz)	Peak Gain w/ Cable Loss (dBi)
5470-5725	1.62

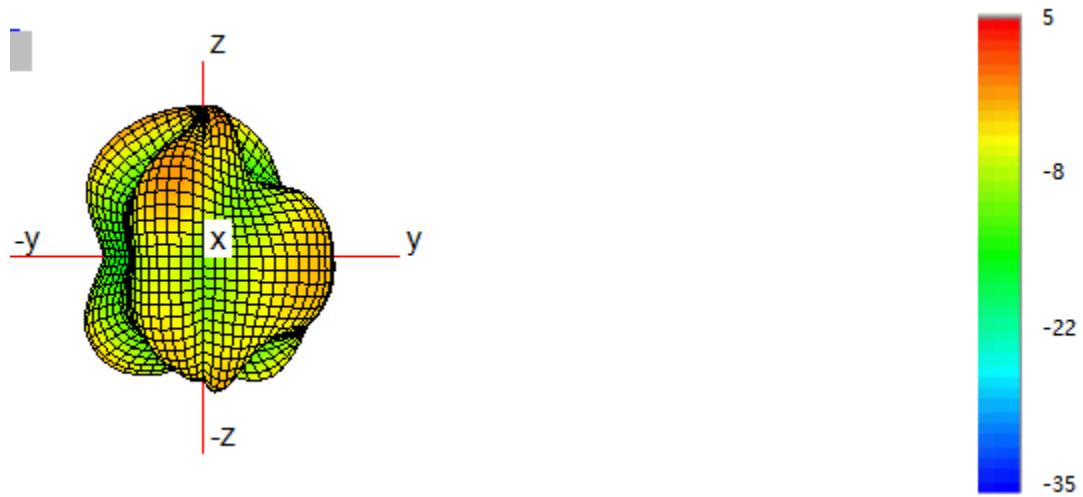

Max Antenna 3D Radiation Pattern 5725-5850 MHz

Frequency (MHz)	Peak Gain w/ Cable Loss (dBi)
5725-5850	0.91

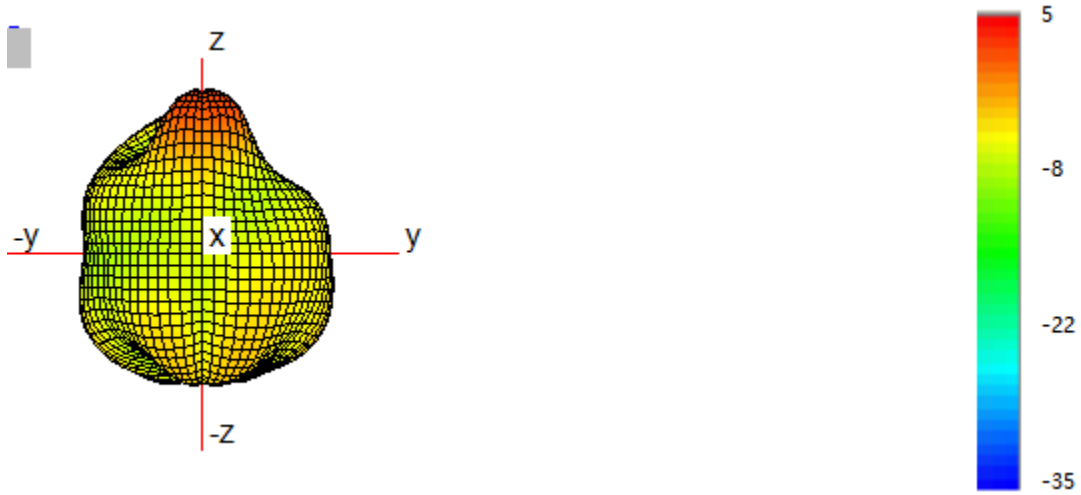

Max Antenna 3D Radiation Pattern 5850-5895 MHz

Frequency (MHz)	Peak Gain w/ Cable Loss (dBi)
5850-5895	0.46

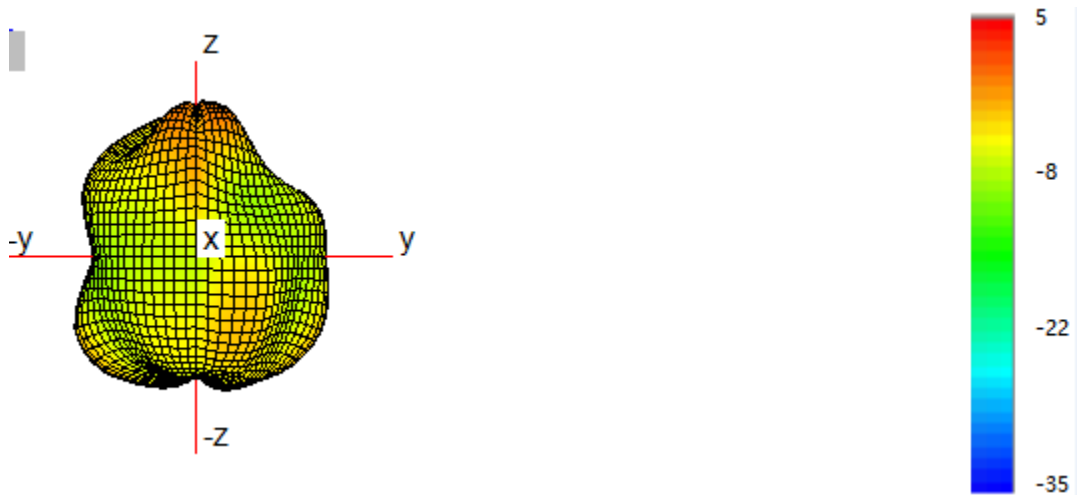

Max Antenna 3D Radiation Pattern 5925-6425 MHz

Frequency (MHz)	Peak Gain w/ Cable Loss (dBi)
5925-6425	1.31

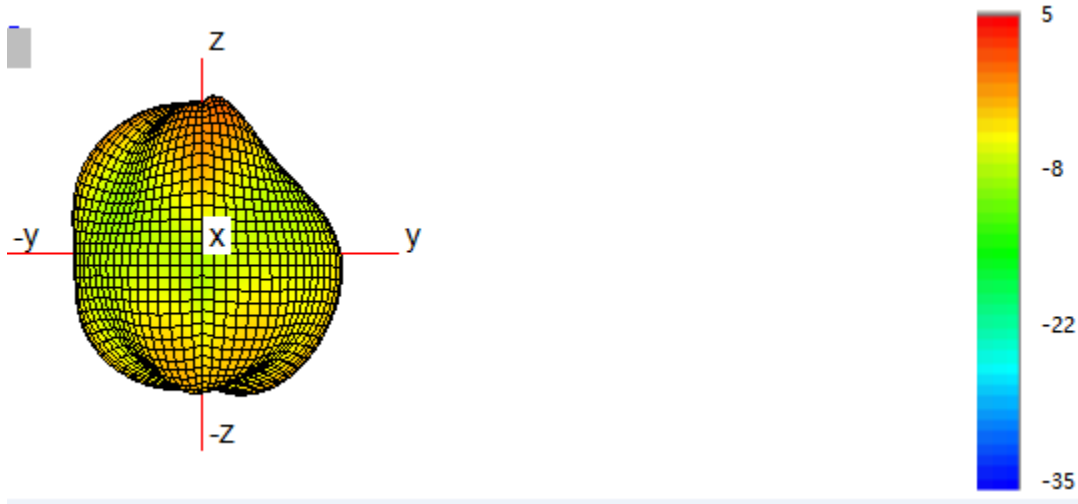

Max Antenna 3D Radiation Pattern 6425-6525 MHz

Frequency (MHz)	Peak Gain w/ Cable Loss (dBi)
6425-6525	0.34

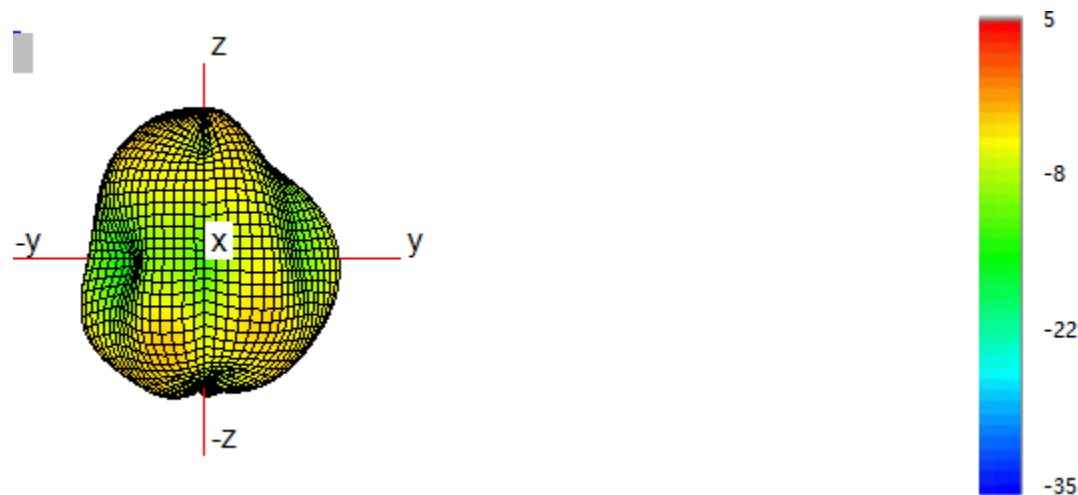

Max Antenna 3D Radiation Pattern 6525-6875 MHz

Frequency (MHz)	Peak Gain w/ Cable Loss (dBi)
6525-6875	0.68

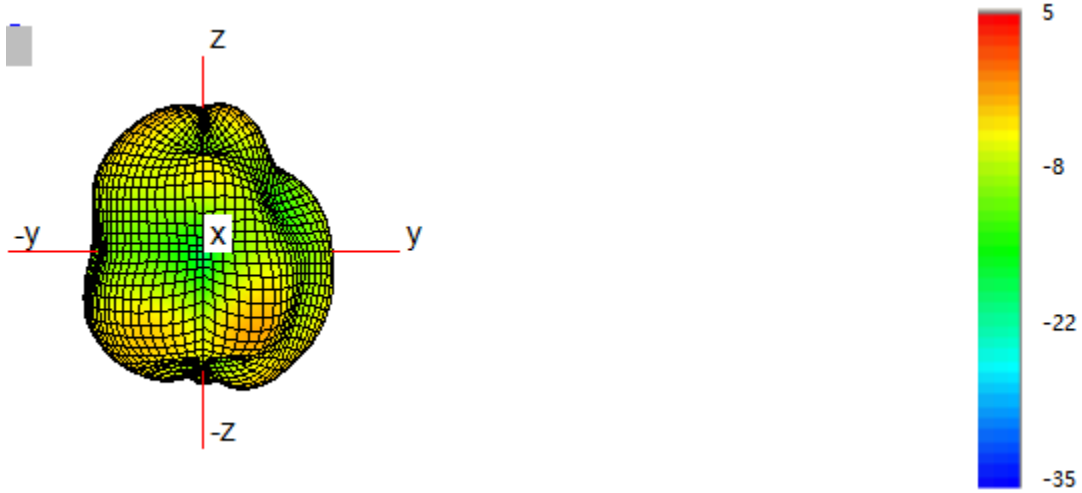

Max Antenna 3D Radiation Pattern 6875-7125 MHz

Frequency (MHz)	Peak Gain w/ Cable Loss (dBi)
6875-7125	0.45

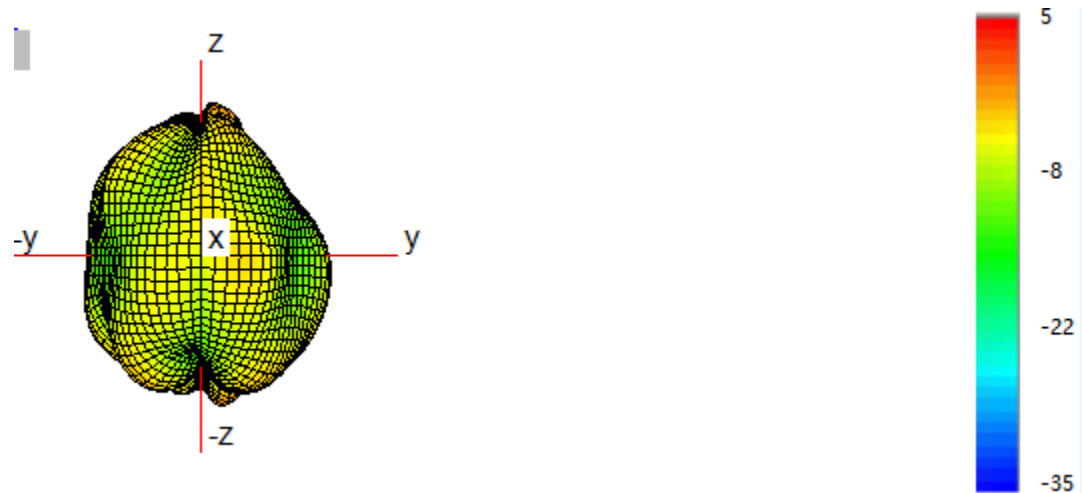

Auxiliary Antenna

Max Antenna 3D Radiation Pattern 2400 – 2483.5 MHz

Frequency (MHz)	Peak Gain w/ Cable Loss (dBi)
2400-2483.5	0.53

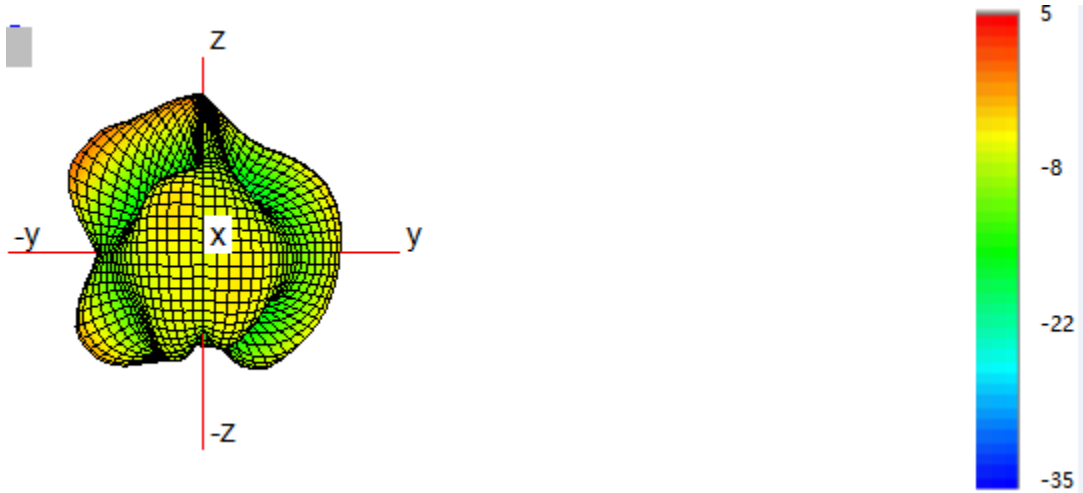

Max Antenna 3D Radiation Pattern 5150-5250 MHz

Frequency (MHz)	Peak Gain w/ Cable Loss (dBi)
5150-5250	0.96

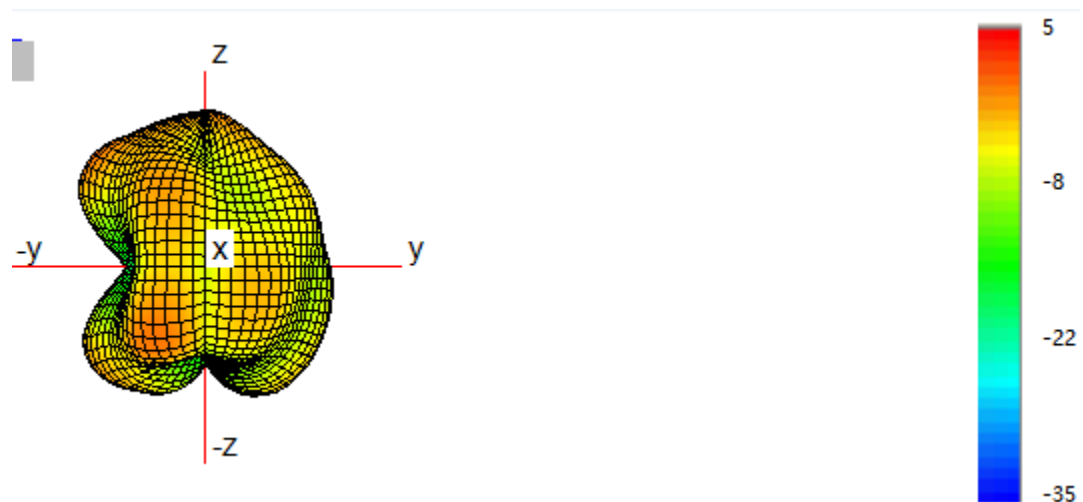

Max Antenna 3D Radiation Pattern 5250-5350 MHz

Frequency (MHz)	Peak Gain w/ Cable Loss (dBi)
5250-5350	0.46

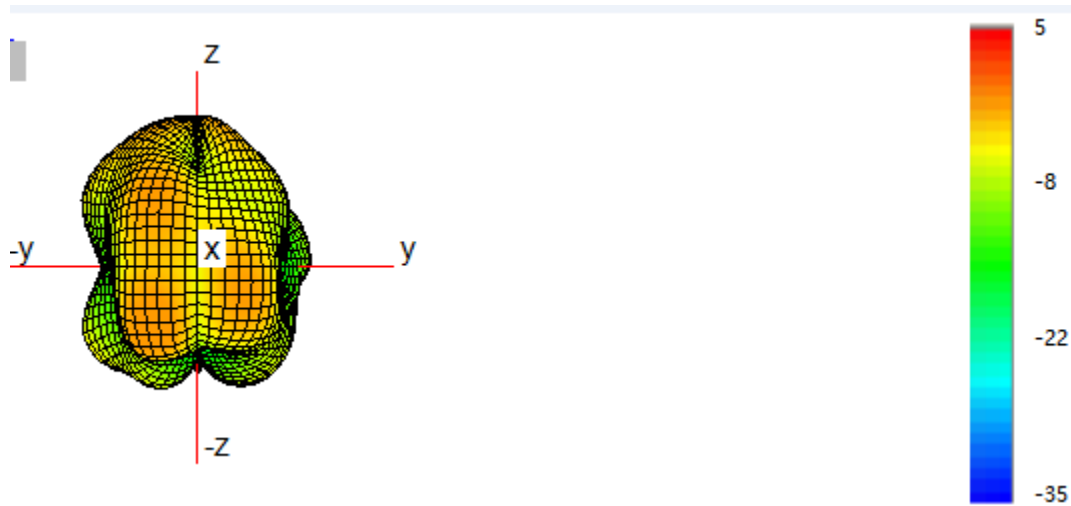

Max Antenna 3D Radiation Pattern 5470-5725 MHz

Frequency (MHz)	Peak Gain w/ Cable Loss (dBi)
5470-5725	0.84

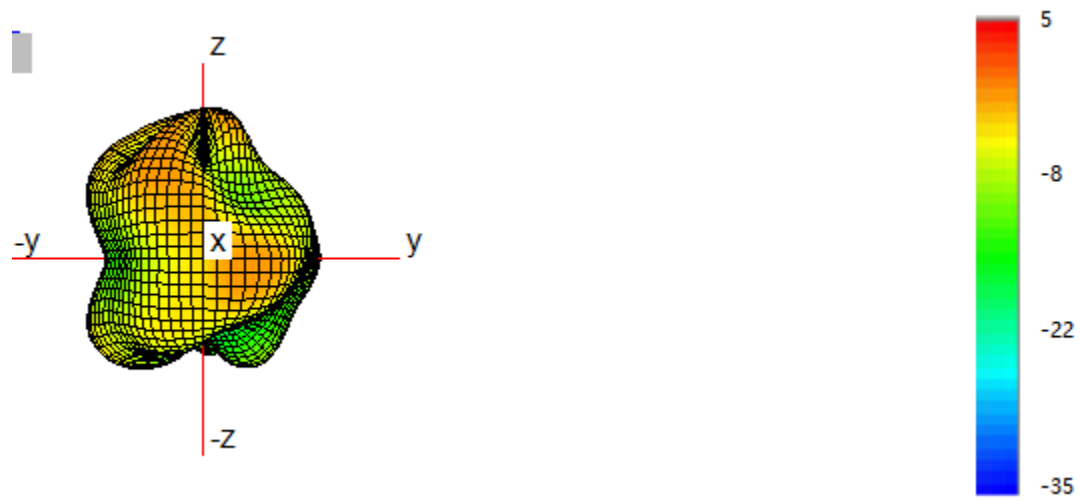

Max Antenna 3D Radiation Pattern 5725-5850 MHz

Frequency (MHz)	Peak Gain w/ Cable Loss (dBi)
5725-5850	0.84

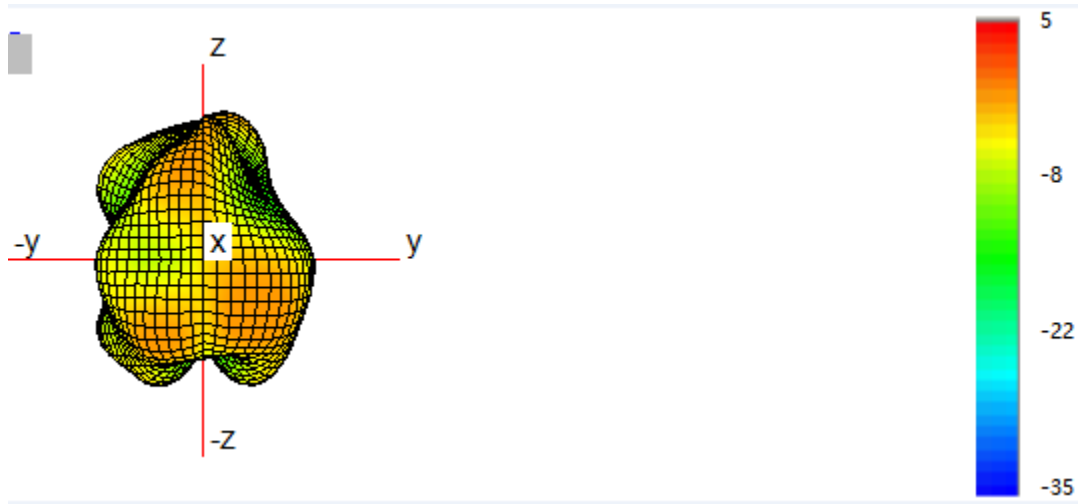

Max Antenna 3D Radiation Pattern 5850-5895 MHz

Frequency (MHz)	Peak Gain w/ Cable Loss (dBi)
5850-5895	0.74

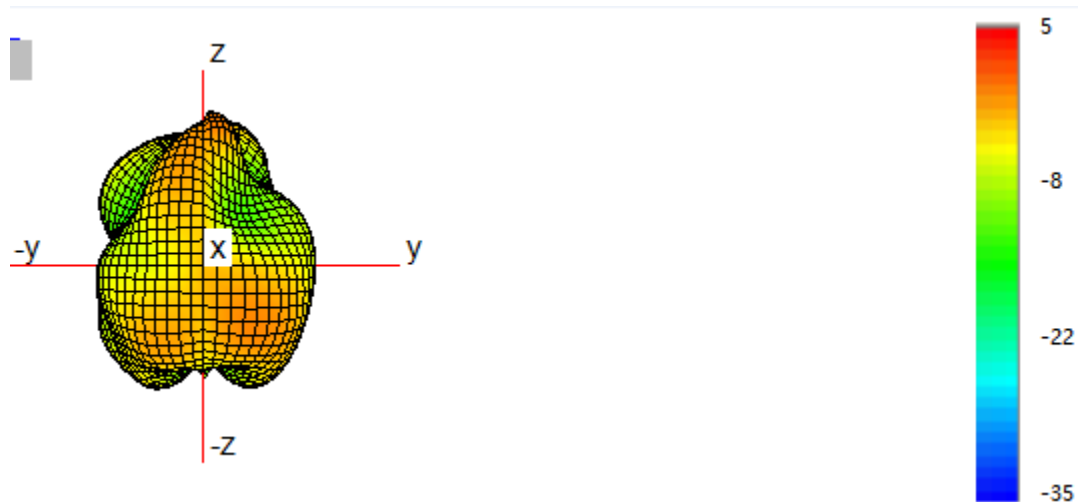

Max Antenna 3D Radiation Pattern 5925-6425 MHz

Frequency (MHz)	Peak Gain w/ Cable Loss (dBi)
5925-6425	0.27

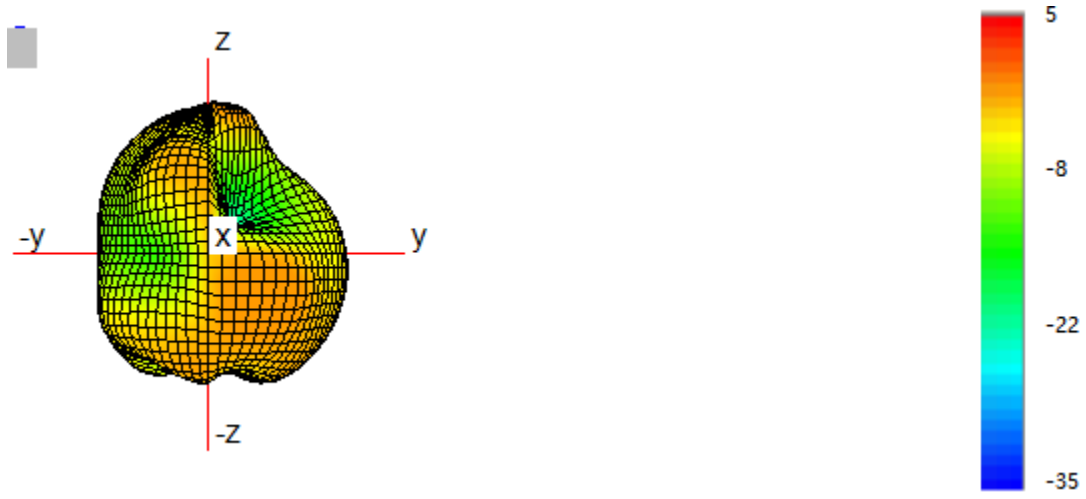

Max Antenna 3D Radiation Pattern 6425-6525 MHz

Frequency (MHz)	Peak Gain w/ Cable Loss (dBi)
6425-6525	0.17

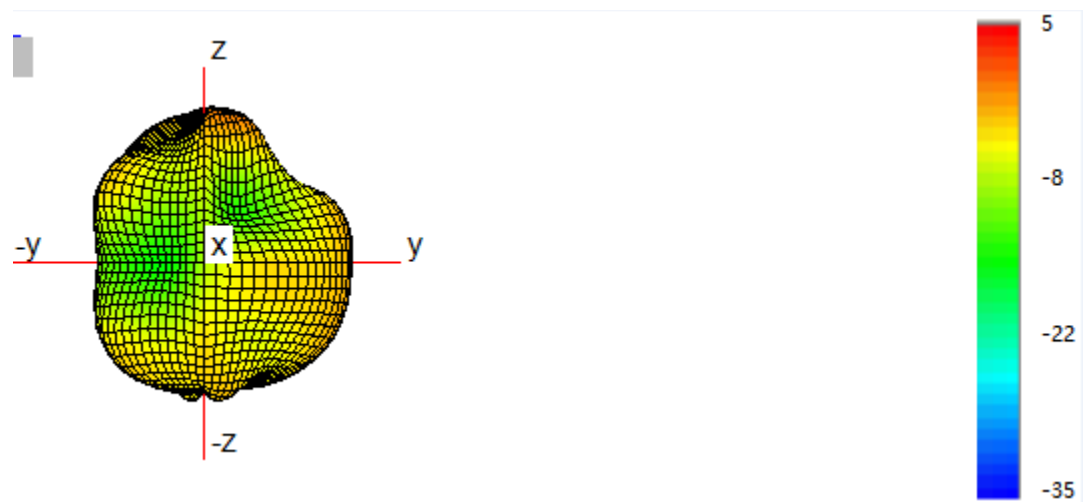

Max Antenna 3D Radiation Pattern 6525-6875 MHz

Frequency (MHz)	Peak Gain w/ Cable Loss (dBi)
6525-6875	0.84

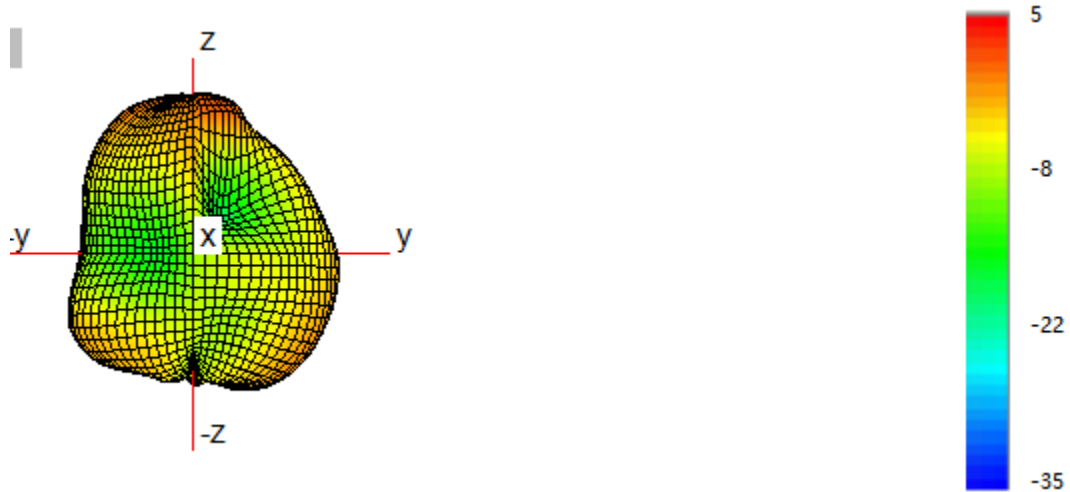

Max Antenna 3D Radiation Pattern 6875-7125 MHz

Frequency (MHz)	Peak Gain w/ Cable Loss (dBi)
6875-7125	0.37

