

# TEST REPORT

## CERTIFICATE OF CONFORMITY

**Standard:** 47 CFR FCC Part 15, Subpart C (Section 15.247)  
**Report No.:** RFBWIN-WTW-P23020421C  
**FCC ID:** J9C-QCNCM825  
**Product:** Qualcomm WiFi 7/BT Combo module  
**Brand:** Qualcomm  
**Model No.:** QCNCM825  
**Received Date:** 2023/10/17  
**Test Date:** 2023/11/7 ~ 2023/11/23  
**Issued Date:** 2023/12/15

**Applicant:** Qualcomm Technologies, Inc.  
**Address:** 5775 Morehouse Drive, San Diego, CA 92121-1714  
**Issued By:** Bureau Veritas Consumer Products Services (H.K.) Ltd., Taoyuan Branch  
Hsin Chu Laboratory  
**Lab Address:** E-2, No.1, Li Hsin 1st Road, Hsinchu Science Park, Hsinchu City 300, Taiwan  
**Test Location:** E-2, No.1, Li Hsin 1st Road, Hsinchu Science Park, Hsinchu City 300, Taiwan  
**FCC Registration /** 723255 / TW2022  
**Designation Number:**

Approved by: \_\_\_\_\_



, Date: \_\_\_\_\_

2023/12/15

Wen Yu / Assistant Manager

This test report consists of 73 pages in total. It may be duplicated completely for legal use with the approval of the applicant. It should not be reproduced except in full, without the written approval of our laboratory. The test results in the report only apply to the tested sample. The test results in this report are traceable to the national or international standards.



Prepared by : Phoenix Huang / Specialist

This report is governed by, and incorporates by reference, the Conditions of Testing as posted at the date of issuance of this report at <http://www.bureauveritas.com/home/about-us/our-business/cps/about-us/terms-conditions/> and is intended for your exclusive use. Any copying or replication of this report to or for any other person or entity, or use of our name or trademark, is permitted only with our prior written permission. This report sets forth our findings solely with respect to the test samples identified herein. The results set forth in this report are not indicative or representative of the quality or characteristics of the lot from which a test sample was taken or any similar or identical product unless specifically and expressly noted. Our report includes all of the tests requested by you and the results thereof based upon the information that you provided to us. Measurement uncertainty is only provided upon request for accredited tests. Statements of conformity are based on simple acceptance criteria without taking measurement uncertainty into account, unless otherwise requested in writing. You have 60 days from date of issuance of this report to notify us of any material error or omission caused by our negligence or if you require measurement uncertainty; provided, however, that such notice shall be in writing and shall specifically address the issue you wish to raise. A failure to raise such issue within the prescribed time shall constitute your unqualified acceptance of the completeness of this report, the tests conducted and the correctness of the report contents.

## Table of Contents

<b>Release Control Record</b> .....	<b>4</b>
<b>1 Certificate</b> .....	<b>5</b>
<b>2 Summary of Test Results</b> .....	<b>6</b>
2.1 Measurement Uncertainty .....	6
2.2 Supplementary Information .....	6
<b>3 General Information</b> .....	<b>7</b>
3.1 General Description .....	7
3.2 Antenna Description of EUT .....	8
3.3 Channel List .....	9
3.4 Test Mode Applicability and Tested Channel Detail .....	10
3.5 Duty Cycle of Test Signal .....	11
3.6 Test Program Used and Operation Descriptions .....	12
3.7 Connection Diagram of EUT and Peripheral Devices .....	12
3.8 Configuration of Peripheral Devices and Cable Connections .....	13
<b>4 Test Instruments</b> .....	<b>14</b>
4.1 RF Output Power .....	14
4.2 Number of Hopping Frequency Used .....	14
4.3 Dwell Time on Each Channel .....	14
4.4 Hopping Channel Separation .....	14
4.5 20 dB Bandwidth .....	14
4.6 Conducted Out of Band Emissions .....	14
4.7 AC Power Conducted Emissions .....	15
4.8 Unwanted Emissions below 1 GHz .....	16
4.9 Unwanted Emissions above 1 GHz .....	17
<b>5 Limits of Test Items</b> .....	<b>18</b>
5.1 RF Output Power .....	18
5.2 Number of Hopping Frequency Used .....	18
5.3 Dwell Time on Each Channel .....	18
5.4 Hopping Channel Separation .....	18
5.5 20 dB Bandwidth .....	18
5.6 Conducted Out of Band Emissions .....	18
5.7 AC Power Conducted Emissions .....	18
5.8 Unwanted Emissions below 1 GHz .....	19
5.9 Unwanted Emissions above 1 GHz .....	19
<b>6 Test Arrangements</b> .....	<b>20</b>
6.1 RF Output Power .....	20
6.1.1 Test Setup .....	20
6.1.2 Test Procedure .....	20
6.2 Number of Hopping Frequency Used .....	20
6.2.1 Test Setup .....	20
6.2.2 Test Procedure .....	20
6.3 Dwell Time on Each Channel .....	21
6.3.1 Test Setup .....	21
6.3.2 Test Procedure .....	21
6.4 Hopping Channel Separation .....	21
6.4.1 Test Setup .....	21
6.4.2 Test Procedure .....	21
6.5 20 dB Bandwidth .....	22
6.5.1 Test Setup .....	22
6.5.2 Test Procedure .....	22
6.6 Conducted Out of Band Emissions .....	22
6.6.1 Test Setup .....	22
6.6.2 Test Procedure .....	22
6.7 AC Power Conducted Emissions .....	23



6.7.1	Test Setup .....	23
6.7.2	Test Procedure .....	23
6.8	Unwanted Emissions below 1 GHz .....	24
6.8.1	Test Setup .....	24
6.8.2	Test Procedure .....	25
6.9	Unwanted Emissions above 1 GHz .....	27
6.9.1	Test Setup .....	27
6.9.2	Test Procedure .....	27
<b>7</b>	<b>Test Results of Test Item .....</b>	<b>29</b>
7.1	RF Output Power .....	29
7.2	Number of Hopping Frequency Used .....	30
7.3	Dwell Time on Each Channel .....	32
7.4	Hopping Channel Separation .....	33
7.5	20 dB Bandwidth .....	34
7.6	Conducted Out of Band Emissions .....	35
7.7	AC Power Conducted Emissions .....	38
7.8	Unwanted Emissions below 1 GHz .....	42
7.9	Unwanted Emissions above 1 GHz .....	48
<b>8</b>	<b>Pictures of Test Arrangements .....</b>	<b>72</b>
<b>9</b>	<b>Information of the Testing Laboratories .....</b>	<b>73</b>

## Release Control Record

Issue No.	Description	Date Issued
RFBWIN-WTW-P23020421C	Original release.	2023/12/15

## 1 Certificate

**Product:** Qualcomm WiFi 7/BT Combo module

**Brand:** Qualcomm

**Test Model:** QCNCM825

**Sample Status:** Engineering sample

**Applicant:** Qualcomm Technologies, Inc.

**Test Date:** 2023/11/7 ~ 2023/11/23

**Standard:** 47 CFR FCC Part 15, Subpart C (Section 15.247)

**Measurement procedure:** ANSI C63.10-2013  
KDB 558074 D01 15.247 Meas Guidance v05r02  
KDB 662911 D01 Multiple Transmitter Output v02r01

The above equipment has been tested by **Bureau Veritas Consumer Products Services (H.K.) Ltd., Taoyuan Branch**, and found compliance with the requirement of the above standards. The test record, data evaluation & Equipment Under Test (EUT) configurations represented herein are true and accurate accounts of the measurements of the sample's RF characteristics under the conditions specified in this report.

## 2 Summary of Test Results

47 CFR FCC Part 15, Subpart C (Section 15.247)			
Standard / Clause	Test Item	Result	Remark
15.247 (a)(1)	RF Output Power	Pass	Meet the requirement of limit.
15.247(a)(1) (iii)	Number of Hopping Frequency Used	Pass	Meet the requirement of limit.
15.247(a)(1) (iii)	Dwell Time on Each Channel	Pass	Meet the requirement of limit.
15.247(a)(1)	Hopping Channel Separation	Pass	Meet the requirement of limit.
15.247(a)(1)	20 dB Bandwidth	-	Refer to Note 1
15.247(d)	Conducted Out of Band Emissions	Pass	Meet the requirement of limit.
15.207	AC Power Conducted Emissions	Pass	Minimum passing margin is -12.17 dB at 0.58359 MHz
15.205 / 15.209 / 15.247(d)	Unwanted Emissions below 1 GHz	Pass	Minimum passing margin is -3.5 dB at 309.34 MHz
15.205 / 15.209 / 15.247(d)	Unwanted Emissions above 1 GHz	Pass	Minimum passing margin is -5.08 dB at 23857.7 MHz
15.203	Antenna Requirement	Pass	Antenna connector is MHF 4L not a standard connector.

### Notes:

1. If the Frequency Hopping System operating in 2400-2483.5 MHz band and the output power less than 125 mW. The hopping channel carrier frequencies separated by a minimum of 25 kHz or two-thirds of the 20 dB bandwidth of hopping channel whichever is greater.
2. Determining compliance based on the results of the compliance measurement, not taking into account measurement instrumentation uncertainty.

### 2.1 Measurement Uncertainty

Where relevant, the following measurement uncertainty levels have been estimated for tests performed on the EUT as specified in CISPR 16-4-2:

Measurement	Specification	Expanded Uncertainty (k=2) (±)
RF Output Power	-	1.1 dB
Number of Hopping Frequency Used	-	1050.00 Hz
Dwell Time on Each Channel	-	2.2 ms
Hopping Channel Separation	-	1050.00 Hz
20 dB Bandwidth	-	1050.00 Hz
Conducted Out of Band Emissions	9 kHz ~ 40 GHz	2.6 dB
AC Power Conducted Emissions	150 kHz ~ 30 MHz	1.9 dB
Unwanted Emissions below 1 GHz	9 kHz ~ 30 MHz	3.1 dB
	30 MHz ~ 1 GHz	5.5 dB
Unwanted Emissions above 1 GHz	1 GHz ~ 18 GHz	5.1 dB
	18 GHz ~ 40 GHz	5.3 dB

The other instruments specified are routine verified to remain within the calibrated levels, no measurement uncertainty is required to be calculated.

### 2.2 Supplementary Information

There is not any deviation from the test standards for the test method, and no modifications required for compliance.

### 3 General Information

#### 3.1 General Description

Product	Qualcomm WiFi 7/BT Combo module
Brand	Qualcomm
Test Model	QCNCM825
Status of EUT	Engineering sample
Power Supply Rating	3.3 Vdc from host equipment
Modulation Type	$\pi/4$ QPSK (HSL2, HSL3) $\pi/4$ DQPSK (HSL4) 8PSK (HSL5) D8PSK (HSL6)
Modulation Technology	FHSS
Transfer Rate	Up to 6 Mbps
Operating Frequency	2.404 GHz ~ 2.478 GHz
Number of Channel	Mode A: 37 Mode B: 38
Output Power	<b>1Tx:</b> 34.914 mW (15.43 dBm) <b>2Tx Beamforming:</b> 34.971 mW (15.44 dBm)

Note:

1. This report is prepared for FCC class II permissive change. The difference compared with the original design is as the following. And regarding the BOM change of the digital circuit of SKU No. NCM825A, the applicant has made appropriate assessment through the Class 1 permissive change process and complies with regulations.

◆ Add QHS function (Qualcomm Bluetooth High Speed Link) by software.

2. According to above conditions, all test items need to be performed. And all data are verified to meet the requirement.

3. The module has below variant designs as following table:

SKU No.	Support platform system and feature
NCM825	X86 platform, support DBS
NCM825A	Qualcomm platform, support DBS

4. There are Bluetooth (EDR, BLE, QHS) and WLAN (2.4 GHz & 5 GHz & 6 GHz) technology used for the EUT.

5. This module supports two modes, as shown in the table below. Since the power setting parameters and RF characteristics are the same, the test mainly uses mode A as the main representative mode. For additional details please refer to the document - "Theory of Operation" exhibit.

Mode	The Number of Channels
A	37
B	38

6. Simultaneously transmission condition.

Condition	Technology	
1	WLAN(2.4 GHz)_Ant 0+1	WLAN(5 GHz)_Ant 0+1
2	WLAN(2.4 GHz)_Ant 0+1	WLAN(6 GHz)_Ant 0+1
3	WLAN(5 GHz)_Ant 0+1	Bluetooth_Ant 0
4	WLAN(5 GHz)_Ant 0+1	Bluetooth_Ant 1
5	WLAN(5 GHz)_Ant 0+1	Bluetooth_Ant 0+1
6	WLAN(6 GHz)_Ant 0+1	Bluetooth_Ant 0
7	WLAN(6 GHz)_Ant 0+1	Bluetooth_Ant 1
8	WLAN(6 GHz)_Ant 0+1	Bluetooth_Ant 0+1
9	WLAN(2.4 GHz)_Ant 0	Bluetooth_Ant 1
10	WLAN(2.4 GHz)_Ant 1	Bluetooth_Ant 0

7. The above EUT information is declared by manufacturer and for more detailed features description, please refer to the manufacturer's specifications or User's Manual.

### 3.2 Antenna Description of EUT

1. The antenna information is listed as below.

Antenna Set	RF Chain No.	Brand	Model	Antenna Net Gain (dBi)	Frequency Range	Cable Loss (dB)	Antenna Type	Connector Type	Cable Length (mm)
1	Chain0/1	Hong-Bo	260-25094	3.53	2.4~2.4835 GHz	0.74	PIFA	MHF 4L	300
				3.06	5.15~5.25 GHz	1.16			
				3.07	5.25~5.35 GHz	1.18			
				4.81	5.47~5.725 GHz	1.26			
				4.2	5.725~5.850 GHz	1.28			
2	Chain0/1	Hong-Bo	260-25083	5.09	5.850~5.895 GHz	1.29	PIFA	MHF 4L	300
				5.14	5.925~6.425 GHz	1.35			
				5.09	6.425~6.525 GHz	1.38			
				5.16	6.525~6.875 GHz	1.45			
				5.12	6.875~7.125 GHz	1.50			
3	Chain0/1	Hong-Bo	260-25084	3.22	2.4~2.4835 GHz	0.49	Monopole	MHF 4L	200
				3.35	5.150~5.250 GHz	0.76			
				3.42	5.250~5.350 GHz	0.77			
				4.77	5.470~5.725 GHz	0.80			
				4.72	5.725~5.850 GHz	0.84			
				4.71	5.850~5.895 GHz	0.84			
				4.75	5.925~6.425 GHz	0.86			
				4.29	6.425~6.525 GHz	0.91			
				4.81	6.525~6.875 GHz	0.96			
				4.74	6.875~7.125 GHz	0.98			

**Note:**

1. QHS has diversity function and transmit chain 0 and chain 1 have been evaluated, the chain 0 will be used as representative test.
2. Max. gain was selected for the final test.

\* Detail antenna specification please refer to antenna datasheet and/or antenna measurement report.



### 3.3 Channel List

QHS channels:

RF Channel	Frequency (MHz)	RF Channel	Frequency (MHz)	RF Channel	Frequency (MHz)	RF Channel	Frequency (MHz)
1	2404	11	2424	21	2444	31	2464
2	2406	12*	2426	22	2446	32	2466
3	2408	13	2428	23	2448	33	2468
4	2410	14	2430	24	2450	34	2470
5	2412	15	2432	25	2452	35	2472
6	2414	16	2434	26	2454	36	2474
7	2416	17	2436	27	2456	37	2476
8	2418	18	2438	28	2458	38	2478
9	2420	19	2440	29	2460		
10	2422	20	2442	30	2462		

Note. \*Advertising channel and only mode B supported.

### 3.4 Test Mode Applicability and Tested Channel Detail

Pre-Scan:	<ol style="list-style-type: none"> <li>EUT has the following operations/ usages: SKU NCM825/ SKU NCM825A. Pre-scan these operations/ usages and find the worst case as a representative test condition.</li> <li>Pre-Scan has been conducted to determine the worst-case mode from all possible combinations between available modulations, data rates and antenna ports (if EUT with antenna diversity architecture).</li> </ol>
Worst Case:	1. SKU NCM825/ SKU NCM825A Worst Condition: SKU NCM825

Following channel(s) was (were) selected for the final test as listed below:

Test Item	EUT Configure Mode	Mode	Tx/Rx Antenna	Tested Channel	Modulation	Data Rate Parameter
RF Output Power	A	QHS	1Tx / 2Tx Beamforming	1, 18, 38	D8PSK	6Mbps
Number of Hopping Frequency Used	A	QHS	1Tx / 2Tx Beamforming	Hopping	D8PSK	6Mbps
Dwell Time on Each Channel	A	QHS	1Tx / 2Tx Beamforming	Hopping	D8PSK	6Mbps
Hopping Channel Separation	A	QHS	1Tx / 2Tx Beamforming	1, 18, 38	D8PSK	6Mbps
20 dB Bandwidth	A	QHS	1Tx / 2Tx Beamforming	1, 18, 38	D8PSK	6Mbps
Conducted Out of Band Emissions	A	QHS	1Tx / 2Tx Beamforming	Hopping 1, 38	D8PSK	6Mbps
AC Power Conducted Emissions	C	QHS	1T	1	D8PSK	6Mbps
			2Tx Beamforming	18	D8PSK	6Mbps
Unwanted Emissions below 1 GHz	A, B	QHS	1Tx	1	D8PSK	6Mbps
			2Tx Beamforming	18	D8PSK	6Mbps
Unwanted Emissions above 1 GHz	A, B	QHS	1Tx / 2Tx Beamforming	1, 18, 38	D8PSK	6Mbps
EUT Configure Mode:	A	EUT only (remove 50 ohm terminator and Connect to the appropriate equipment)				
	B	EUT with 50 ohm terminator				
	C	EUT with antenna				

### 3.5 Duty Cycle of Test Signal

**QHS 6M 1Tx:** Duty cycle = 2 ms / 100 ms x 100% = 2.0%

**QHS 6M 2Tx Beamforming:** Duty cycle = 1.8 ms / 100 ms x 100% = 1.8%

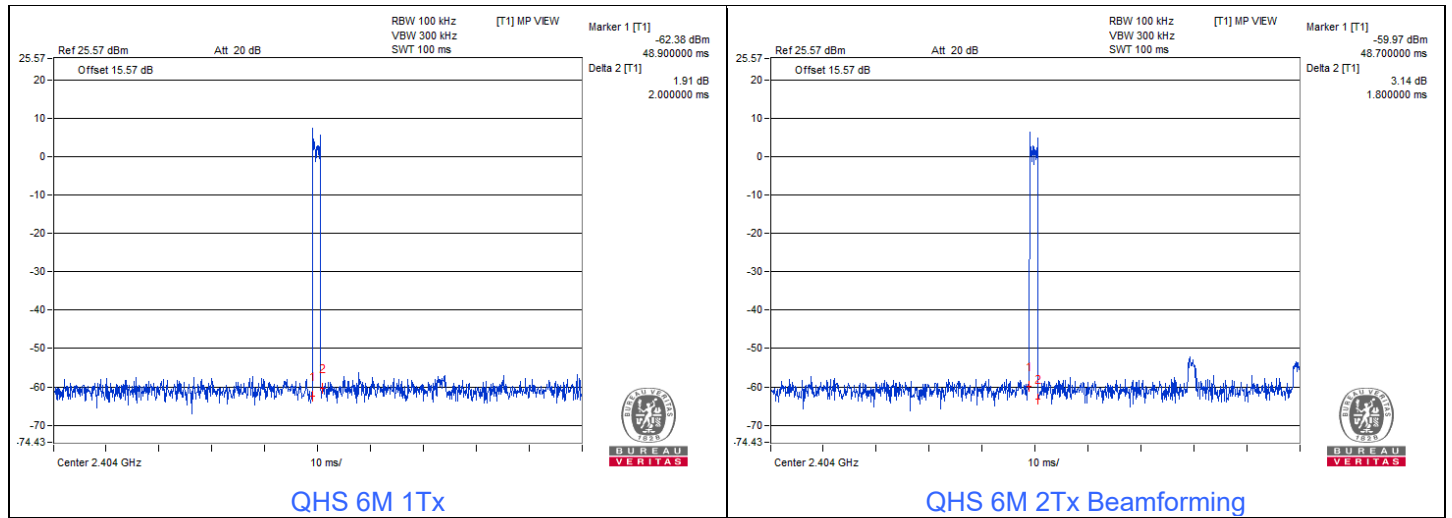

### 3.6 Test Program Used and Operation Descriptions

Controlling software (QRCT 4.0.00159.1) has been activated to set the EUT under transmission condition continuously at specific channel frequency.

### 3.7 Connection Diagram of EUT and Peripheral Devices

#### For AC Power Conducted Emission test

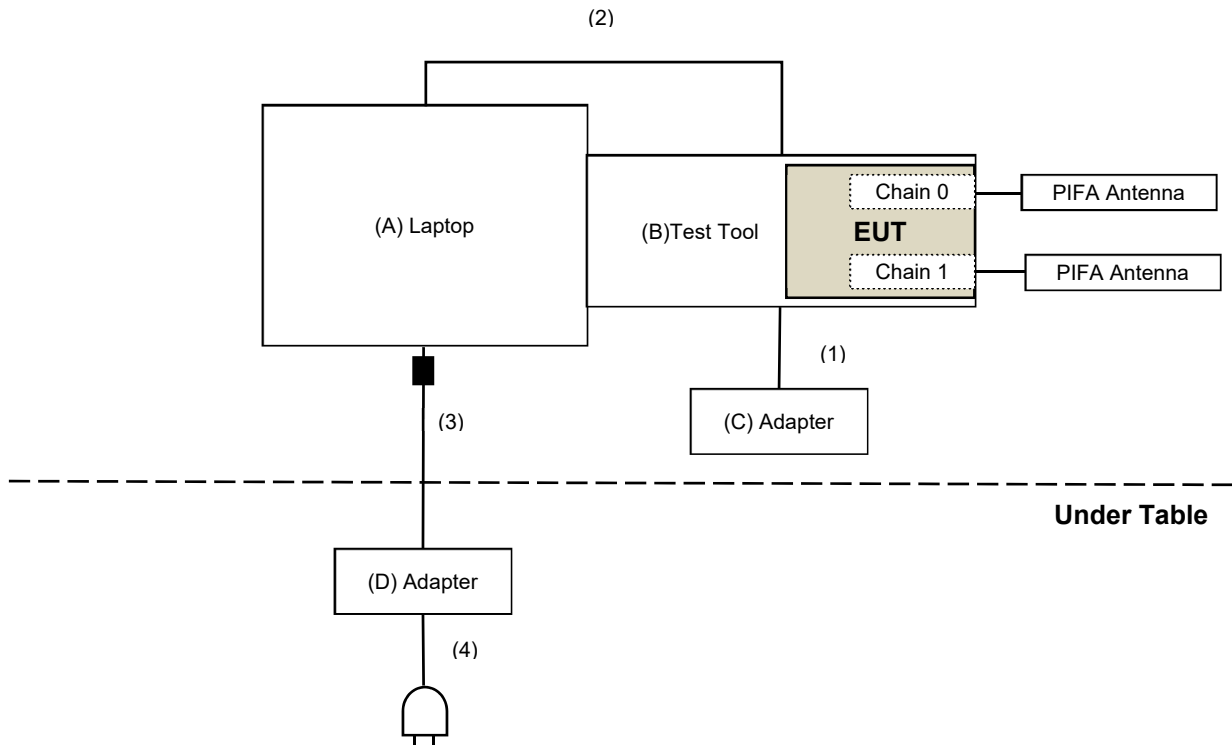

For Unwanted Emission test

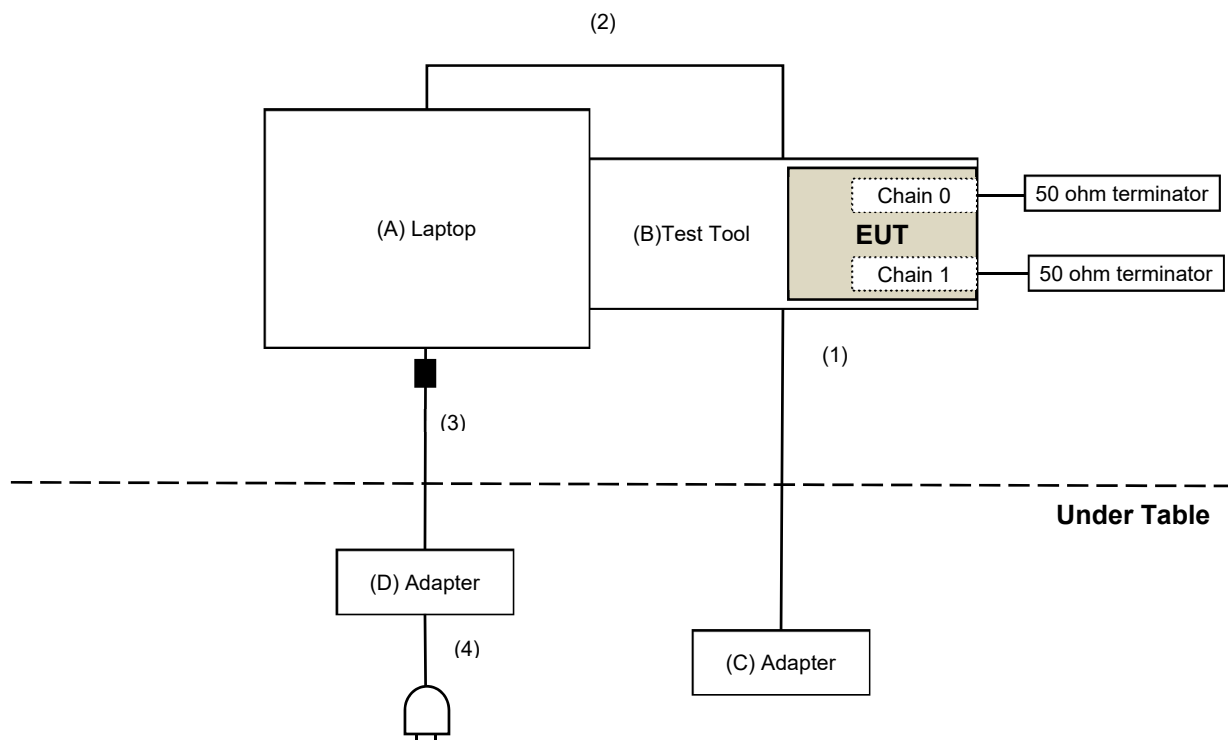

3.8 Configuration of Peripheral Devices and Cable Connections

ID	Product	Brand	Model No.	Serial No.	FCC ID	Remarks
A	Laptop	Dell	E5420	6FGHKV1	N/A	Provided by Lab
B	Test Tool	Qualcomm	N/A	N/A	N/A	Supplied by applicant
C	Adapter	PHIHONG	PSAA12A-120L6	N/A	N/A	Supplied by applicant
D	Adapter	Dell	LLA65NS2-01	N/A	N/A	Provided by Lab

ID	Cable Descriptions	Qty.	Length (m)	Shielding (Yes/No)	Cores (Qty.)	Remarks
1	DC Cable	1	1.2	No	0	Supplied by applicant
2	Micro USB Cable	1	0.6	Yes	0	Provided by Lab
3	DC Cable	1	1.8	No	1	Provided by Lab
4	AC Cable	1	1.5	No	0	Provided by Lab

## 4 Test Instruments

The calibration interval of the all test instruments are 12 months and the calibrations are traceable to NML/ROC and NIST/USA.

### 4.1 RF Output Power

Description Manufacturer	Model No.	Serial No.	Calibrated Date	Calibrated Until
Power Meter Anritsu	ML2495A	1529002	2023/6/17	2024/6/16
Pulse Power Sensor Anritsu	MA2411B	1726434	2023/6/19	2024/6/18

Notes:

1. The test was performed in Oven room 2.
2. Tested Date: 2023/11/17

### 4.2 Number of Hopping Frequency Used

Description Manufacturer	Model No.	Serial No.	Calibrated Date	Calibrated Until
MXA Signal Analyzer Keysight	N9020B	MY60112409	2023/2/18	2024/2/17
Software	ADT_RF Test Software V7.6.5.4	N/A	N/A	N/A

Notes:

1. The test was performed in Oven room 2.
2. Tested Date: 2023/11/17

### 4.3 Dwell Time on Each Channel

Refer to section 4.2 to get information of the instruments.

### 4.4 Hopping Channel Separation

Refer to section 4.2 to get information of the instruments.

### 4.5 20 dB Bandwidth

Refer to section 4.2 to get information of the instruments.

### 4.6 Conducted Out of Band Emissions

Refer to section 4.2 to get information of the instruments.

#### 4.7 AC Power Conducted Emissions

Description Manufacturer	Model No.	Serial No.	Calibrated Date	Calibrated Until
50 ohm terminal resistance Telegartner	50 ohm	3	2023/10/20	2024/10/19
EMI Test Receiver R&S	ESCS 30	847124/029	2023/10/18	2024/10/17
Fixed Attenuator STI	STI02-2200-10	005	2023/7/1	2024/6/30
LISN R&S	ESH3-Z5	835239/001	2023/4/6	2024/4/5
		848773/004	2023/10/13	2024/10/12
RF Coaxial Cable JYEBAO	5D-FB	COCCAB-001	2023/7/1	2024/6/30
Software BVADT	BVADT_Cond_V7.3.7.4	N/A	N/A	N/A

Notes:

1. The test was performed in Conduction 1
2. Tested Date: 2023/11/13

#### 4.8 Unwanted Emissions below 1 GHz

##### Mode A

Description Manufacturer	Model No.	Serial No.	Calibrated Date	Calibrated Until
MXA Signal Analyzer Keysight	N9020B	MY60112409	2023/2/18	2024/2/17
Software	ADT_RF Test Software V7.6.5.4	N/A	N/A	N/A

##### Notes:

1. The test was performed in Oven room 2.
2. Tested Date: 2023/11/7 ~ 2023/11/9

##### Mode B

Description Manufacturer	Model No.	Serial No.	Calibrated Date	Calibrated Until
Bi_Log Antenna Schwarzbeck	VULB 9168	9168-0842	2023/10/12	2024/10/11
Boresight Antenna Tower & Turn Table Max-Full	MF-7802BS	MF780208530	N/A	N/A
EMI Test Receiver R&S	ESR3	102528	2023/2/10	2024/2/9
Fixed Attenuator Mini-Circuits	UNAT-5+	PAD-ATT5-02	2022/12/28	2023/12/27
Loop Antenna Electro-Metrics	EM-6879	264	2023/2/21	2024/2/20
MXA Signal Analyzer Keysight	N9020B	MY60112410	2023/3/6	2024/3/5
Preamplifier EMCI	EMC330N	980538	2023/4/6	2024/4/5
	EMC001340	980142	2023/5/8	2024/5/7
PXA Signal Analyzer Keysight	N9030B	MY57141948	2023/5/19	2024/5/18
RF Coaxial Cable JYEBAO	5D-FB	LOOPCAB-001	2022/12/19	2023/12/18
		LOOPCAB-002	2022/12/19	2023/12/18
RF Coaxial Cable PEWC	8D	966-5-1	2023/4/6	2024/4/5
		966-5-2	2023/4/6	2024/4/5
		966-5-3	2023/4/6	2024/4/5
Software	ADT_Radiated_V8.7.08	N/A	N/A	N/A

##### Notes:

1. The test was performed in 966 Chamber No. 5.
2. Tested Date: 2023/11/13



#### 4.9 Unwanted Emissions above 1 GHz

##### Mode A

Description Manufacturer	Model No.	Serial No.	Calibrated Date	Calibrated Until
MXA Signal Analyzer Keysight	N9020B	MY60112409	2023/2/18	2024/2/17
Software	ADT_RF Test Software V7.6.5.4	N/A	N/A	N/A

##### Notes:

1. The test was performed in Oven room 2.
2. Tested Date: 2023/11/8 ~ 2023/11/23

##### Mode B

Description Manufacturer	Model No.	Serial No.	Calibrated Date	Calibrated Until
Boresight Antenna Tower & Turn Table Max-Full	MF-7802BS	MF780208530	N/A	N/A
EMI Test Receiver R&S	ESR3	102528	2023/2/10	2024/2/9
Horn Antenna Schwarzbeck	BBHA 9120D	9120D-1819	2023/11/12	2024/11/11
	BBHA 9170	9170-739	2023/11/12	2024/11/11
MXA Signal Analyzer Keysight	N9020B	MY60112410	2023/3/6	2024/3/5
Preamplifier EMCI	EMC12630SE	980509	2023/4/7	2024/4/6
	EMC184045SE	980387	2023/8/9	2024/8/8
RF Coaxial Cable EMCI	EMC-KM-KM-4000	200214	2023/2/20	2024/2/19
	EMC102-KM-KM-1200	160924	2023/8/9	2024/8/8
	EMC104-SM-SM-1500	180503	2023/4/7	2024/4/6
	EMC104-SM-SM-2000	180501	2023/4/7	2024/4/6
	EMC104-SM-SM-6000	180506	2023/4/7	2024/4/6
Software	ADT_Radiated_V8.7.08	N/A	N/A	N/A

##### Notes:

1. The test was performed in 966 Chamber No. 5.
2. Tested Date: 2023/11/13

## 5 Limits of Test Items

### 5.1 RF Output Power

The Maximum Output Power Measurement is 125 mW (21 dBm).

Per KDB 662911 D01 Multiple Transmitter Output Method of conducted output power measurement on IEEE 802.11 devices,

Array Gain = 0 dB (i.e., no array gain) for  $N_{ANT} \leq 4$ ;

Array Gain = 0 dB (i.e., no array gain) for channel widths  $\geq 40$  MHz for any  $N_{ANT}$ ;

Array Gain =  $5 \log(N_{ANT}/N_{SS})$  dB or 3 dB, whichever is less, for 20-MHz channel widths with  $N_{ANT} \geq 5$ .

For power measurements on all other devices: Array Gain =  $10 \log(N_{ANT}/N_{SS})$  dB.

### 5.2 Number of Hopping Frequency Used

At least 15 channels frequencies, and should be equally spaced.

### 5.3 Dwell Time on Each Channel

The average time of occupancy on any channel shall not be greater than 0.4 seconds within a period of 0.4 seconds multiplied by the number of hopping channels employed.

### 5.4 Hopping Channel Separation

At least 25 kHz or two-third of 20 dB hopping channel bandwidth (whichever is greater).

### 5.5 20 dB Bandwidth

Maximum bandwidth is not specified.

### 5.6 Conducted Out of Band Emissions

Below 20 dB of the highest emission level of operating band (in 100 kHz Resolution Bandwidth).

### 5.7 AC Power Conducted Emissions

Frequency (MHz)	Conducted Limit (dBuV)	
	Quasi-peak	Average
0.15 - 0.5	66 - 56	56 - 46
0.50 - 5.0	56	46
5.0 - 30.0	60	50

Notes:

1. The lower limit shall apply at the transition frequencies.
2. The limit decreases in line with the logarithm of the frequency in the range of 0.15 to 0.50 MHz.

## 5.8 Unwanted Emissions below 1 GHz

Radiated emissions up to 1 GHz which fall in the restricted bands must comply with the radiated emission limits specified as below table. Other emissions shall be at least 20 dB below the highest level of the desired power:

Frequencies (MHz)	Field Strength (microvolts/meter)	Measurement Distance (meters)
0.009 ~ 0.490	2400/F(kHz)	300
0.490 ~ 1.705	24000/F(kHz)	30
1.705 ~ 30.0	30	30
30 ~ 88	100	3
88 ~ 216	150	3
216 ~ 960	200	3
Above 960	500	3

Notes:

1. The lower limit shall apply at the transition frequencies.
2. Emission level (dBuV/m) = 20 log Emission level (uV/m).

## 5.9 Unwanted Emissions above 1 GHz

Radiated emissions above 1 GHz which fall in the restricted bands must comply with the radiated emission limits specified as below table. Other emissions shall be at least 20 dB below the highest level of the desired power:

Frequencies (MHz)	Field Strength (microvolts/meter)	Measurement Distance (meters)
Above 960	500	3

Notes:

1. The lower limit shall apply at the transition frequencies.
2. Emission level (dBuV/m) = 20 log Emission level (uV/m).
3. For frequencies above 1000 MHz, the field strength limits are based on average detector, however, the peak field strength of any emission shall not exceed the maximum permitted average limits, specified above by more than 20 dB under any condition of modulation.

## 6 Test Arrangements

### 6.1 RF Output Power

#### 6.1.1 Test Setup

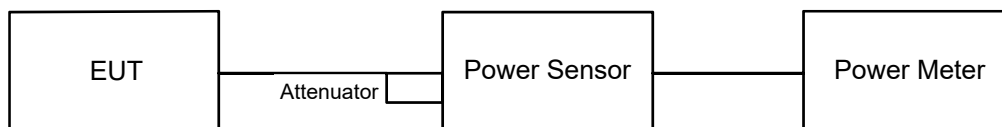

#### 6.1.2 Test Procedure

##### Peak Power:

A peak power sensor was used on the output port of the EUT. A power meter was used to read the response of the peak power sensor. Record the power level.

##### Average Power:

Average power sensor was used to perform output power measurement, trigger and gating function of wide band power meter is enabled to measure max output power of TX on burst. Duty factor is not added to measured value.

### 6.2 Number of Hopping Frequency Used

#### 6.2.1 Test Setup

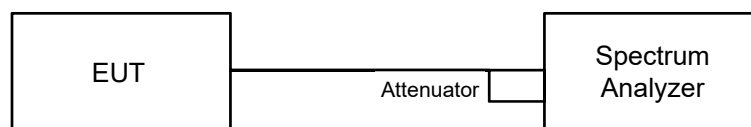

#### 6.2.2 Test Procedure

- Check the calibration of the measuring instrument (SA) using either an internal calibrator or a known signal from an external generator.
- Turn on the EUT and connect its antenna terminal to measurement via a low loss cable. Then set it to any one measured frequency within its operating range and make sure the instrument is operated in its linear range.
- Set the SA on MaxHold Mode, and then keep the EUT in hopping mode. Record all the signals from each channel until each one has been recorded.
- Set the SA on View mode and then plot the result on SA screen.
- Repeat above procedures until all frequencies measured were complete.

### 6.3 Dwell Time on Each Channel

#### 6.3.1 Test Setup

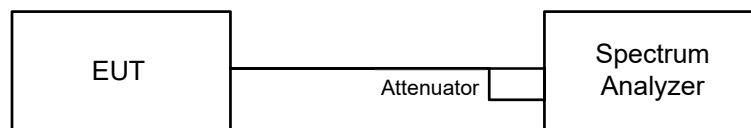

#### 6.3.2 Test Procedure

- Check the calibration of the measuring instrument (SA) using either an internal calibrator or a known signal from an external generator.
- Turn on the EUT and connect its antenna terminal to measurement via a low loss cable. Then set it to any one measured frequency within its operating range and make sure the instrument is operated in its linear range.
- Adjust the center frequency of SA on any frequency be measured and set SA to zero span mode. And then, set RBW and VBW of spectrum analyzer to proper value.
- Measure the time duration of one transmission on the measured frequency. And then plot the result with time difference of this time duration.
- Repeat above procedures until all different time-slot modes have been completed.

### 6.4 Hopping Channel Separation

#### 6.4.1 Test Setup

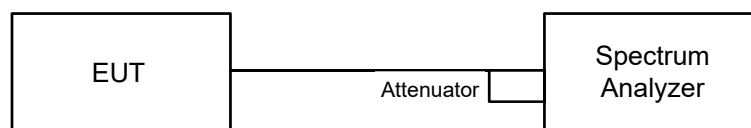

#### 6.4.2 Test Procedure

- Check the calibration of the measuring instrument using either an internal calibrator or a known signal from an external generator.
- Turn on the EUT and connect it to measurement instrument. Then set it to any one convenient frequency within its operating range.
- By using the MaxHold function record the separation of two adjacent channels.
- Measure the frequency difference of these two adjacent channels by SA MARK function. And then plot the result on SA screen.
- Repeat above procedures until all frequencies measured were complete.

## 6.5 20 dB Bandwidth

### 6.5.1 Test Setup

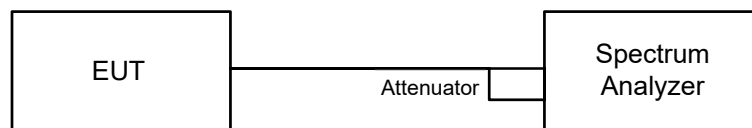

### 6.5.2 Test Procedure

- Check the calibration of the measuring instrument using either an internal calibrator or a known signal from an external generator.
- Turn on the EUT and connect it to measurement instrument. Then set it to any one convenient frequency within its operating range. Set a reference level on the measuring instrument equal to the highest peak value.
- Measure the frequency difference of two frequencies that were attenuated 20 dB from the reference level. Record the frequency difference as the emission bandwidth.
- Repeat above procedures until all frequencies measured were complete.

## 6.6 Conducted Out of Band Emissions

### 6.6.1 Test Setup

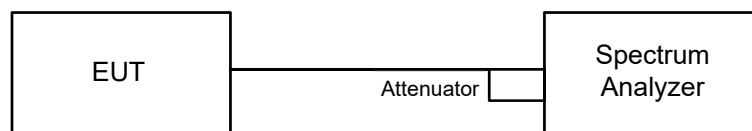

### 6.6.2 Test Procedure

#### MEASUREMENT PROCEDURE REF

- Set the RBW = 100 kHz.
- Set the VBW  $\geq$  300 kHz.
- Detector = peak.
- Sweep time = auto couple.
- Trace mode = max hold.
- Allow trace to fully stabilize.
- Use the peak marker function to determine the maximum power level in any 100 kHz band segment within the fundamental EBW.

#### MEASUREMENT PROCEDURE OOB

- Set RBW = 100 kHz.
- Set VBW  $\geq$  300 kHz.
- Detector = peak.
- Sweep = auto couple.
- Trace Mode = max hold.
- Allow trace to fully stabilize.
- Use the peak marker function to determine the maximum amplitude level.

## 6.7 AC Power Conducted Emissions

### 6.7.1 Test Setup

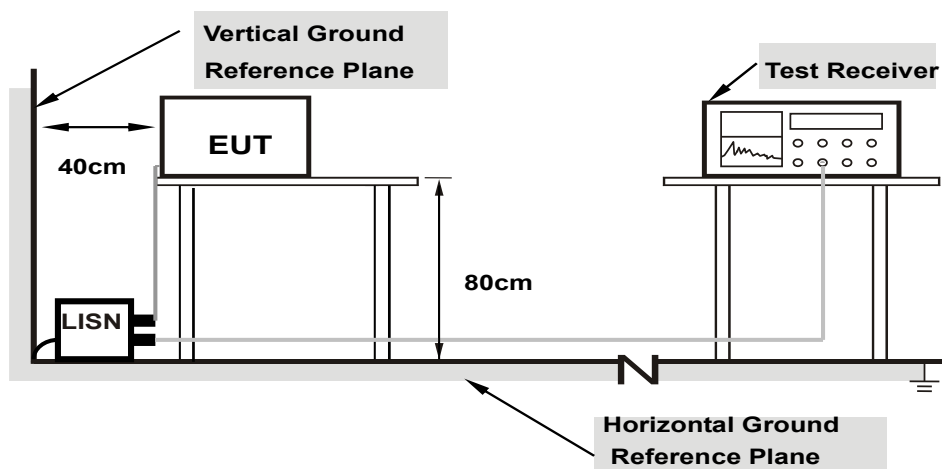

**Note: 1.Support units were connected to second LISN.**

For the actual test configuration, please refer to the attached file (Test Setup Photo).

### 6.7.2 Test Procedure

- The EUT was placed on a 0.8 meter to the top of table and placed 0.4 meters from the conducting wall of the shielded room with EUT being connected to the power mains through a line impedance stabilization network (LISN). Other support units were connected to the power mains through another LISN. The two LISNs provide 50 ohm/ 50 uH of coupling impedance for the measuring instrument.
- Both lines of the power mains connected to the EUT were checked for maximum conducted interference.
- The frequency range from 150 kHz to 30 MHz was searched. Emission levels under (Limit – 20 dB) was not recorded.

Note: The resolution bandwidth and video bandwidth of test receiver is 9 kHz for quasi-peak detection (QP) and average detection (AV) at frequency 0.15 MHz-30 MHz.

## 6.8 Unwanted Emissions below 1 GHz

### 6.8.1 Test Setup

**For Radiated Configuration:**

**For Radiated emission below 30 MHz**

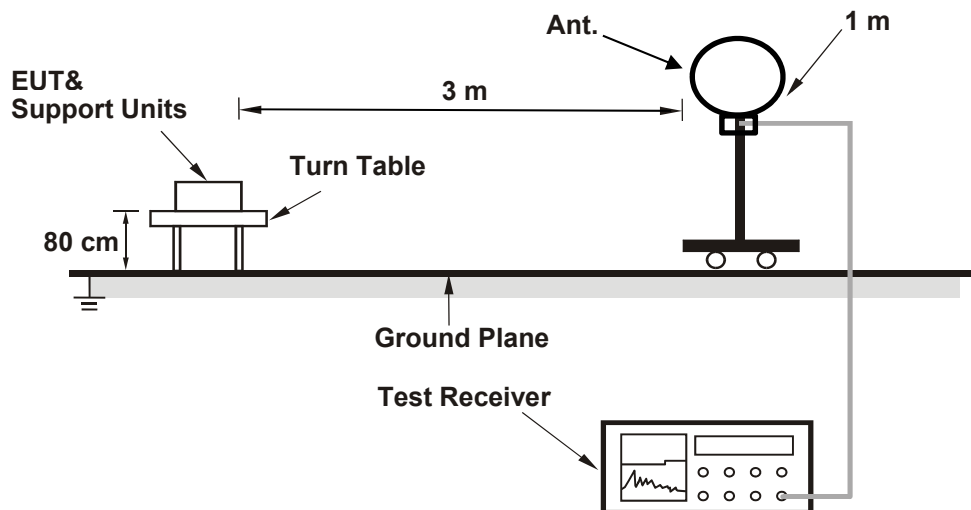

**For Radiated emission above 30 MHz**

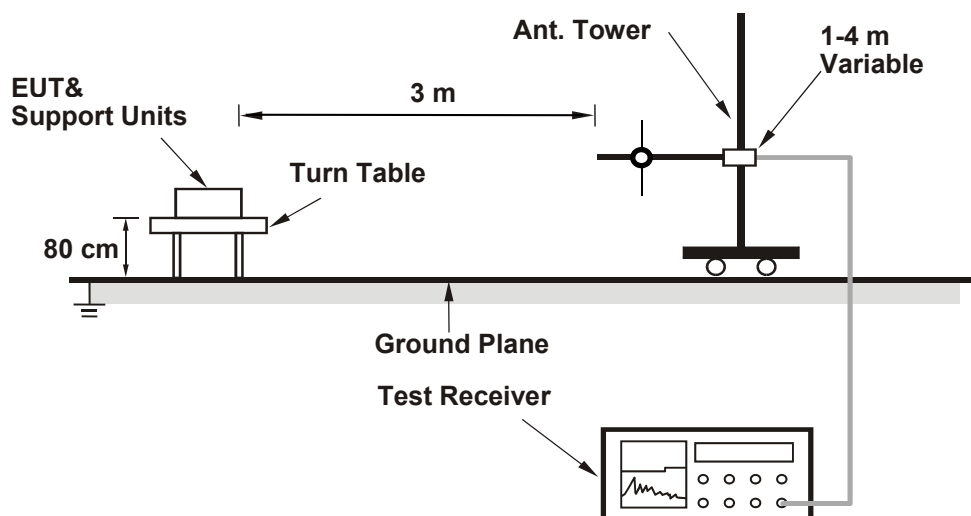

**For Conducted Configuration:**

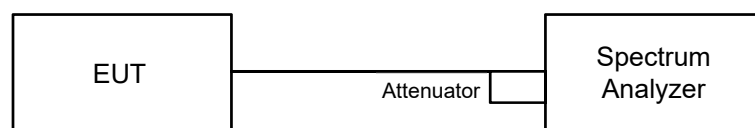

For the actual test configuration, please refer to the attached file (Test Setup Photo).



## 6.8.2 Test Procedure

### Radiated versus Conducted Measurement.

The unwanted emission limits in both the restricted and non-restricted bands are based on antenna-port conducted measurements in conjunction with cabinet emissions tests are permitted to demonstrate compliance.

The following steps was performed:

- a. Cabinet emissions measurements. Radiated measurement was performed to ensure that cabinet emissions are below the emission limits. For the cabinet-emission measurements the antenna was replaced by a termination matching the nominal impedance of the antenna.
- b. Conducted tests was performed using equipment that matches the nominal impedance of the antenna assembly used with the EUT.
- c. EIRP calculation. A value representative of an upper bound on out-of-band antenna gain (in dBi) shall be added to the measured antenna-port conducted emission power to compute EIRP within the specified measurement bandwidth. (For emissions in the restricted bands, additional calculations are required to convert EIRP to field strength at the specified distance.) The upper bound on antenna gain for a device with a single RF output shall be selected as the maximum in-band gain of the antenna across all operating bands or 2 dBi, whichever is greater.
- d. EIRP adjustments for multiple outputs. (Follow the procedures specified in FCC KDB Publication 662911)
- e. For all of Radiation emission test

#### **For Radiated emission below 30 MHz**

- e-1.1. The EUT was placed on the top of a rotating table 0.8 meters above the ground at 3 meter chamber room for test. The table was rotated 360 degrees to determine the position of the highest radiation.
- e-1.2. The EUT was set 3 meters away from the interference-receiving antenna, which was mounted on the top of a variable-height antenna tower.
- e-1.3. Parallel, perpendicular, and ground-parallel orientations of the antenna are set to make the measurement.
- e-1.4. For each suspected emission, the EUT was arranged to its worst case and the rotatable table was turned from 0 degrees to 360 degrees to find the maximum reading.
- e-1.5. The test-receiver system was set to Quasi-Peak Detect Function and Specified Bandwidth with Maximum Hold Mode, except for the frequency band (9 kHz to 90 kHz and 110 kHz to 490 kHz) set to average detect function and peak detect function.

#### Notes:

1. The resolution bandwidth and video bandwidth of test receiver/spectrum analyzer is 200 Hz at frequency below 150 kHz.
2. The resolution bandwidth and video bandwidth of test receiver/spectrum analyzer is 9 kHz or 10 kHz at frequency (150 kHz to 30 MHz).
3. All modes of operation were investigated and the worst-case emissions are reported.
4. KDB 414788 OATS and Chamber Correlation Justification
  - Based on FCC 15.31(f)(2):measurements may be performed at a distance closer than that specified in the regulations; however, an attempts should be made to avoid making measurements in the near field.
  - OATs and chamber correlation testing had been performed and chamber measured test result is the worst case test result.

### For Radiated emission above 30 MHz

- e-2.1. The EUT was placed on the top of a rotating table 0.8 meters above the ground at 3 meter chamber room for test. The table was rotated 360 degrees to determine the position of the highest radiation.
- e-2.2. The EUT was set 3 meters away from the interference-receiving antenna, which was mounted on the top of a variable-height antenna tower.
- e-2.3. The height of antenna is varied from one meter to four meters above the ground to determine the maximum value of the field strength. Both horizontal and vertical polarizations of the antenna are set to make the measurement.
- e-2.4. For each suspected emission, the EUT was arranged to its worst case and then the antenna was tuned to heights from 1 meter to 4 meters and the rotatable table was turned from 0 degrees to 360 degrees to find the maximum reading.
- e-2.5. The test-receiver system was set to quasi-peak detect function and specified bandwidth with maximum hold mode when the test frequency is below 1 GHz.

#### Notes:

1. The resolution bandwidth and video bandwidth of test receiver/spectrum analyzer is 120 kHz for Quasi-peak detection (QP) at frequency below 1 GHz.
2. All modes of operation were investigated and the worst-case emissions are reported.

<b>Radiated versus Conducted Measurement</b>
<p><u>For Radiated measurement:</u> The level of unwanted emissions was measured when radiated by the cabinet or structure of the equipment with the antenna connector(s) terminated by a specified load (cabinet radiation).</p> <p><u>For Conducted measurement:</u> The level of unwanted emissions was measured as their power in a specified load (conducted spurious emissions).</p>
<b>Conducted Unwanted Emission Convert Formula</b>
<p>a. Emission Level (dBuV/m) = EIRP Level (dBm) – 20log(d) + 104.8 d = measurement distance in 3 meters.</p> <p>b. EIRP Level (dBm) = Raw Value(dBm) + Correction Factor(dB)</p> <p>c. Correction Factor is directional gain, and the composite gain will be used when signal support the correlated signal For the out of band spurious the gain for the specific band may have been used rather than the highest gain across all bands. For the band edge the gain for the specific band may have been used.</p> <p>Notes:</p> <ol style="list-style-type: none"> <li>1. In restricted bands below 1000 MHz, add upper bound on ground plane reflection: For frequencies between 30 MHz and 1000 MHz, add 4.7 dB.</li> <li>2. The conducted emission test was considered some factor to compute test result.</li> </ol>

## 6.9 Unwanted Emissions above 1 GHz

### 6.9.1 Test Setup

#### For Radiated Configuration:

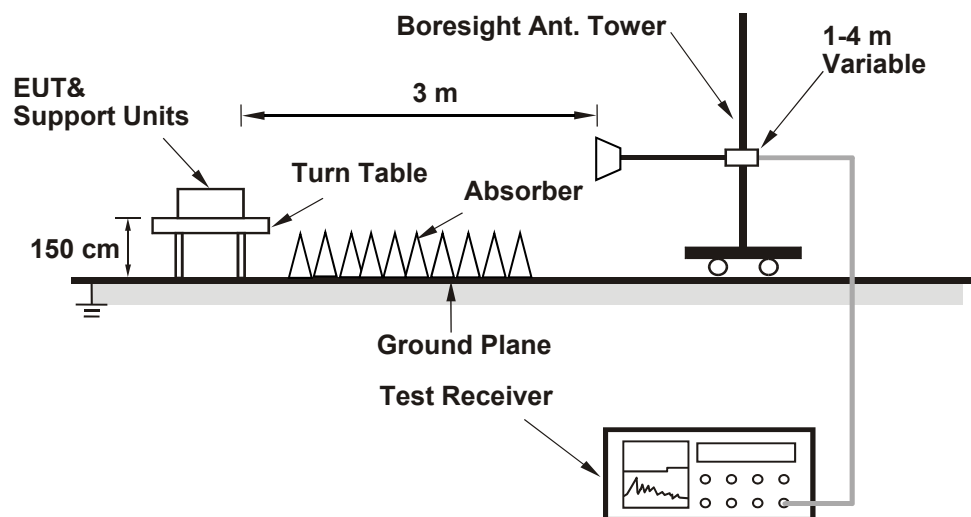

#### For Conducted Configuration:

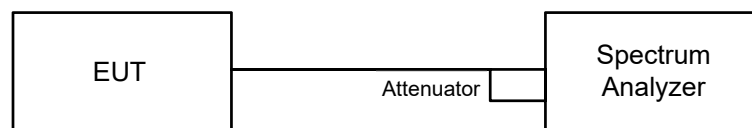

For the actual test configuration, please refer to the attached file (Test Setup Photo).

### 6.9.2 Test Procedure

#### Radiated versus Conducted Measurement.

The unwanted emission limits in both the restricted and non-restricted bands are based on antenna-port conducted measurements in conjunction with cabinet emissions tests are permitted to demonstrate compliance.

The following steps was performed:

- a. Cabinet emissions measurements. Radiated measurement was performed to ensure that cabinet emissions are below the emission limits. For the cabinet-emission measurements the antenna was replaced by a termination matching the nominal impedance of the antenna.
- b. Conducted tests was performed using equipment that matches the nominal impedance of the antenna assembly used with the EUT.
- c. EIRP calculation. A value representative of an upper bound on out-of-band antenna gain (in dBi) shall be added to the measured antenna-port conducted emission power to compute EIRP within the specified measurement bandwidth. (For emissions in the restricted bands, additional calculations are required to convert EIRP to field strength at the specified distance.) The upper bound on antenna gain for a device with a single RF output shall be selected as the maximum in-band gain of the antenna across all operating bands or 2 dBi, whichever is greater.
- d. EIRP adjustments for multiple outputs. (Follow the procedures specified in FCC KDB Publication 662911)
- e. For all of Radiation emission test
  - e-1. The EUT was placed on the top of a rotating table 1.5 meters above the ground at 3 meter chamber room for test. The table was rotated 360 degrees to determine the position of the highest radiation.
  - e-2. The EUT was set 3 meters away from the interference-receiving antenna, which was mounted on the top of a variable-height antenna tower.

- e-3. The height of antenna is varied from one meter to four meters above the ground to determine the maximum value of the field strength. Both horizontal and vertical polarizations of the antenna are set to make the measurement.
- e-4. For each suspected emission, the EUT was arranged to its worst case and then the antenna was tuned to heights from 1 meter to 4 meters and the rotatable table was turned from 0 degrees to 360 degrees to find the maximum reading.
- e-5. The test-receiver system was set to peak and average detects function and specified bandwidth with maximum hold mode when the test frequency is above 1 GHz. If the peak reading value also meets average limit, measurement with the average detector is unnecessary.

Notes:

1. The resolution bandwidth of test receiver/spectrum analyzer is 1 MHz and the video bandwidth is 3 MHz for Peak detection (PK) and Average detection (AV) at frequency above 1 GHz.
2. For fundamental and harmonic signal measurement, the resolution bandwidth of test receiver/spectrum analyzer is 1 MHz and the video bandwidth is  $\geq 1/T$  (Duty cycle < 98%) or 10 Hz (Duty cycle  $\geq 98\%$ ) for Average detection (AV) at frequency above 1 GHz.
3. All modes of operation were investigated and the worst-case emissions are reported.

<b>Radiated versus Conducted Measurement</b>
<p><u>For Radiated measurement:</u> The level of unwanted emissions was measured when radiated by the cabinet or structure of the equipment with the antenna connector(s) terminated by a specified load (cabinet radiation).</p> <p><u>For Conducted measurement:</u> The level of unwanted emissions was measured as their power in a specified load (conducted spurious emissions).</p> <p><u>For Verified radiated measurement:</u> The level of unwanted emissions was measured when radiated by the cabinet or structure of the equipment with the antenna connector(s) terminated by a specified load (cabinet radiation).</p>
<b>Conducted Unwanted Emission Convert Formula</b>
<p>a. Emission Level (dBuV/m) = EIRP Level (dBm) – 20log(d) + 104.8 d = measurement distance in 3 meters.</p> <p>b. EIRP Level (dBm) = Raw Value(dBm) + Correction Factor(dB).</p> <p>c. Correction Factor is directional gain, and the composite gain will be used when signal support the correlated signal For the out of band spurious the gain for the specific band may have been used rather than the highest gain across all bands. For the band edge the gain for the specific band may have been used.</p> <p>Note: The conducted emission test was considered some factor to compute test result.</p>

a. Emission Level (dBuV/m) = EIRP Level (dBm) – 20log(d) + 104.8

d = measurement distance in 3 meters.

b. EIRP Level (dBm) = Raw Value(dBm) + Correction Factor(dB).

c. Correction Factor is directional gain, and the composite gain will be used when signal support the correlated signal

For the out of band spurious the gain for the specific band may have been used rather than the highest gain across all bands.

For the band edge the gain for the specific band may have been used.

Note:

The conducted emission test was considered some factor to compute test result.

## 7 Test Results of Test Item

### 7.1 RF Output Power

Input Power:	3.3 Vdc	Environmental Conditions:	25°C, 60% RH	Tested By:	Kevin Ko
--------------	---------	---------------------------	--------------	------------	----------

#### For Peak Power

##### QHS 6M 1Tx

Chan.	Chan. Freq. (MHz)	Peak Power (mW)	Peak Power (dBm)	Power Limit (dBm)	Test Result
1	2404	34.914	15.43	21	Pass
18	2438	34.514	15.38	21	Pass
38	2478	31.405	14.97	21	Pass

Note: The antenna gain is 3.53 dBi < 6 dBi, so the output power limit shall not be reduced.

##### QHS 6M 2Tx Beamforming

Chan.	Chan. Freq. (MHz)	Peak Power (dBm)		Total Power (mW)	Total Power (dBm)	Power Limit (dBm)	Test Result
		Chain 0	Chain 1				
1	2404	11.75	12.56	32.993	15.18	20.46	Pass
18	2438	11.97	12.84	34.971	15.44	20.46	Pass
38	2478	11.30	12.06	29.559	14.71	20.46	Pass

#### Notes:

- Directional gain = gain of antenna element + 10 log (2 of TX antenna elements)
- The directional gain is 6.54 dBi > 6 dBi, so the output power limit shall be reduced to 21-(6.54-6) = 20.46 dBm.

#### For Average Power

##### QHS 6M 1Tx

Chan.	Chan. Freq. (MHz)	Average Power (mW)	Average Power (dBm)
1	2404	23.988	13.80
18	2438	23.714	13.75
38	2478	19.907	12.99

##### QHS 6M 2Tx Beamforming

Chan.	Chan. Freq. (MHz)	Average Power (dBm)		Total Average Power (mW)	Total Average Power (dBm)
		Chain 0	Chain 1		
1	2404	8.95	9.63	17.036	12.31
18	2438	9.25	9.76	17.876	12.52
38	2478	8.54	8.83	14.783	11.70

## 7.2 Number of Hopping Frequency Used

Input Power:	3.3 Vdc	Environmental Conditions:	25°C, 60% RH	Tested By:	Kevin Ko
--------------	---------	---------------------------	--------------	------------	----------

### QHS 6M 1Tx

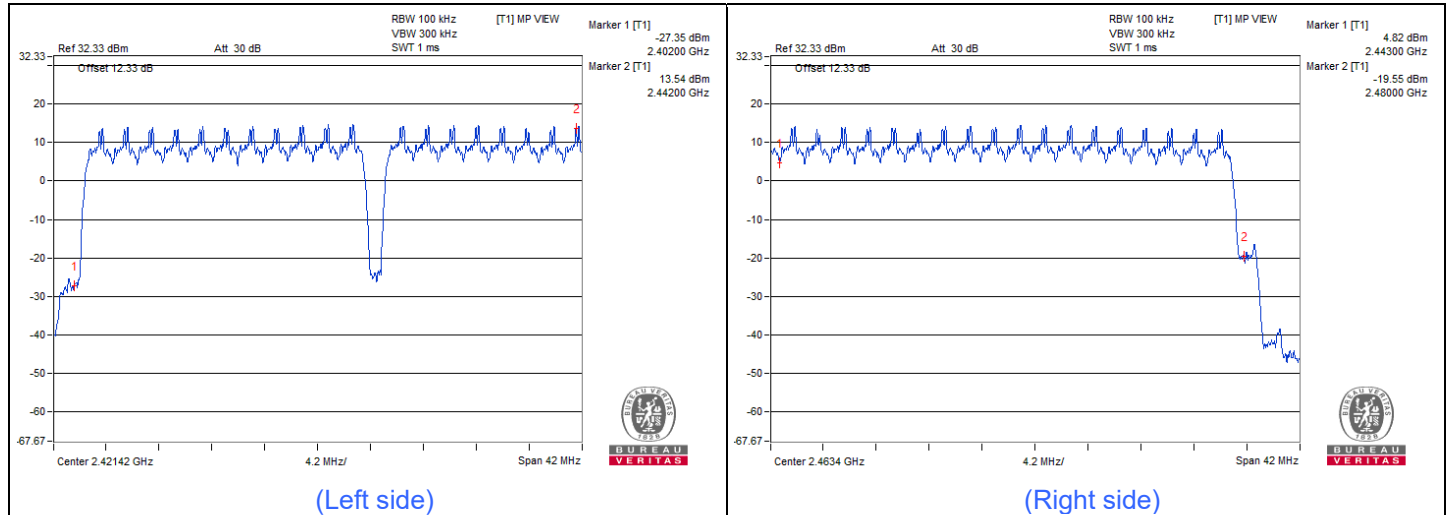

Note: There are 37 hopping frequencies in the hopping mode. On the plots, it shows that the hopping frequencies are equally spaced.

### QHS 6M 2Tx Beamforming

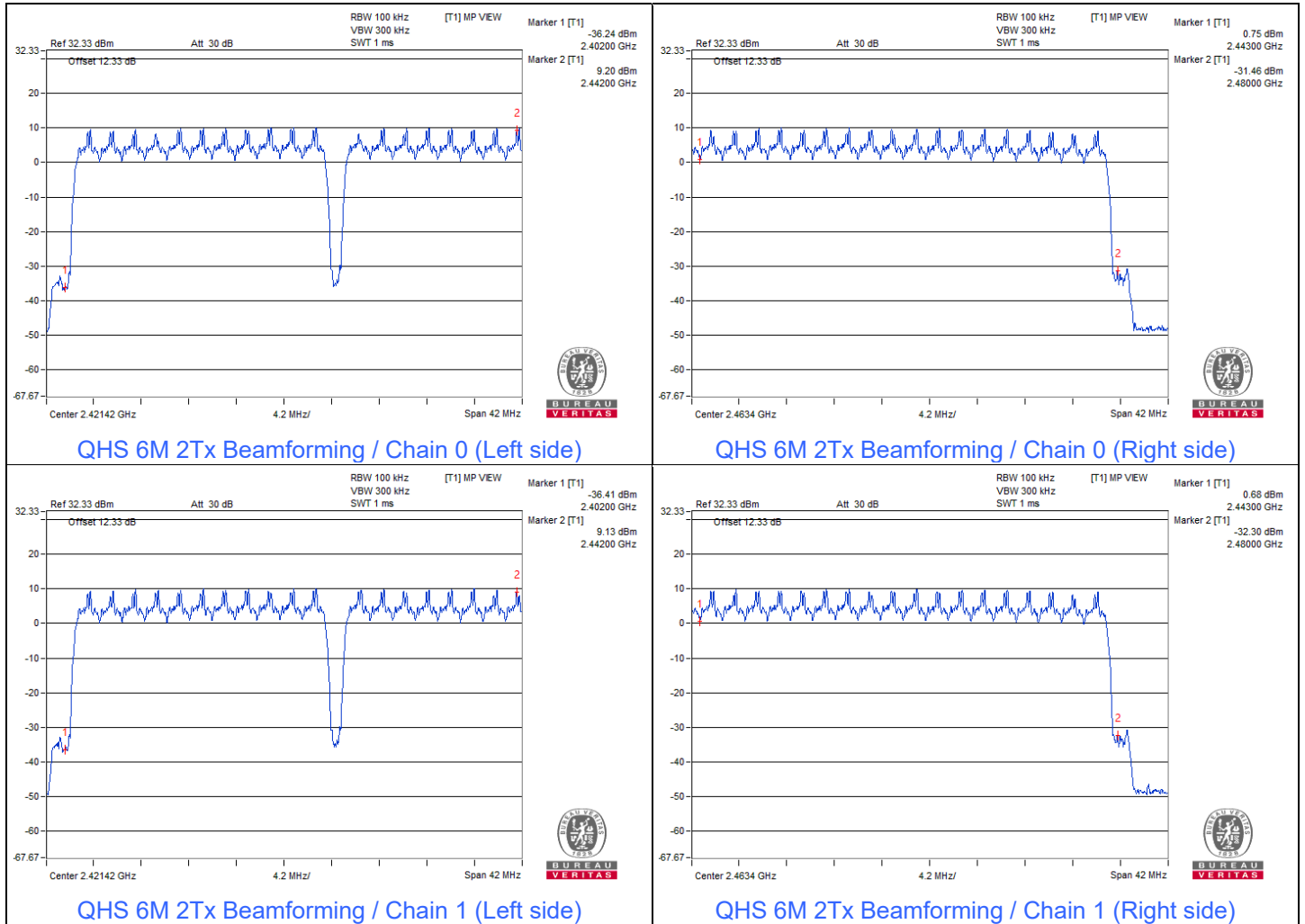

Note: There are 37 hopping frequencies in the hopping mode. On the plots, it shows that the hopping frequencies are equally spaced.

### 7.3 Dwell Time on Each Channel

Input Power:	3.3 Vdc	Environmental Conditions:	25°C, 60% RH	Tested By:	Kevin Ko
--------------	---------	---------------------------	--------------	------------	----------

#### QHS 6M 1Tx

Mode	Number of transmission in 14.8 sec	Length of transmission time (msec)	Result (msec)	Limit (msec)	Test Result
FHSS	18 (times / 5 sec) * 2.96 = 54 times	1.568	84.672	400	Pass

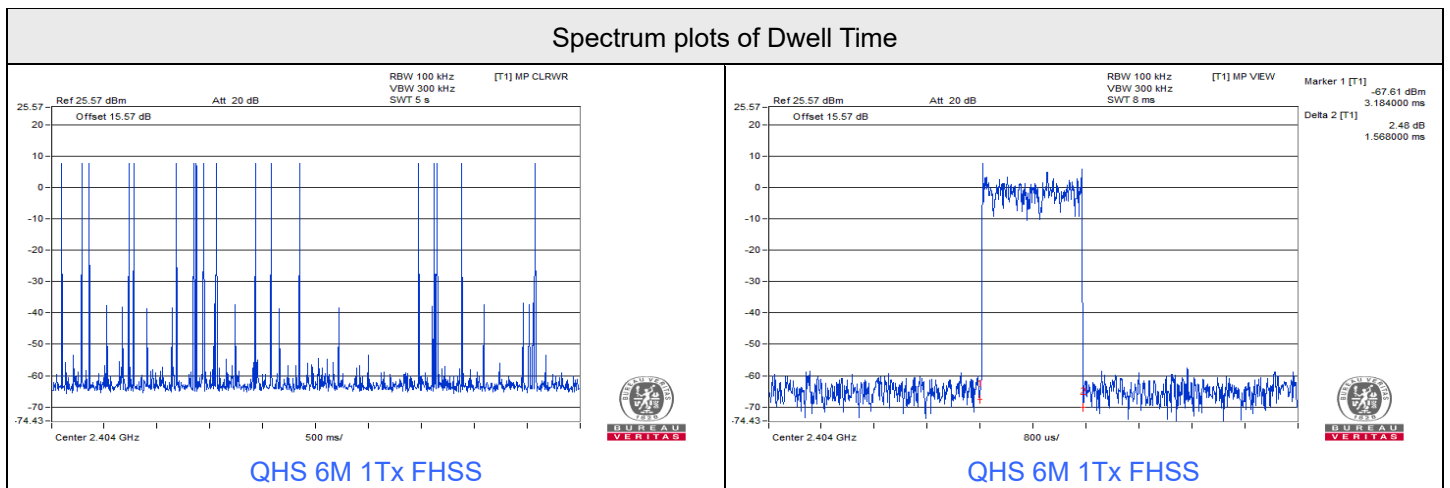

#### QHS 6M 2Tx Beamforming

Mode	Number of transmission in 14.8 sec	Length of transmission time (msec)	Result (msec)	Limit (msec)	Test Result
FHSS	16 (times / 5 sec) * 2.96 = 48 times	1.6	76.8	400	Pass

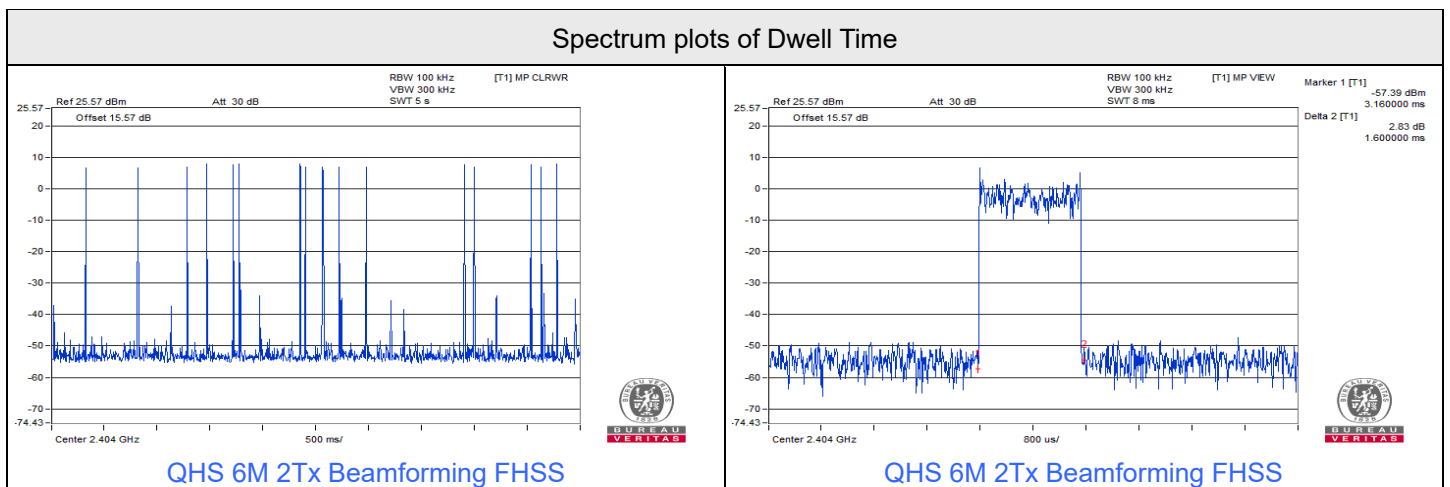



### 7.4 Hopping Channel Separation

Input Power:	3.3 Vdc	Environmental Conditions:	25°C, 60% RH	Tested By:	Kevin Ko
--------------	---------	---------------------------	--------------	------------	----------

#### QHS 6M 1Tx

Channel	Frequency (MHz)	Hopping Channel Separation (MHz)	Minimum Limit (MHz)	Test Result
1	2404	2.00	1.68	Pass
18	2438	2.00	1.68	Pass
38	2478	2.00	1.69	Pass

Note: The minimum limit is two-third 20dB bandwidth.

#### QHS 6M 2Tx Beamforming

Channel	Frequency (MHz)	Hopping Channel Separation (MHz)		Minimum Limit (MHz)	Test Result
		Chain 0	Chain 1		
1	2404	2.00	2.00	1.68	Pass
18	2438	2.01	2.01	1.68	Pass
38	2478	2.00	2.01	1.68	Pass

Note: The minimum limit is two-third 20dB bandwidth.

Spectrum Plot of Minimum Value

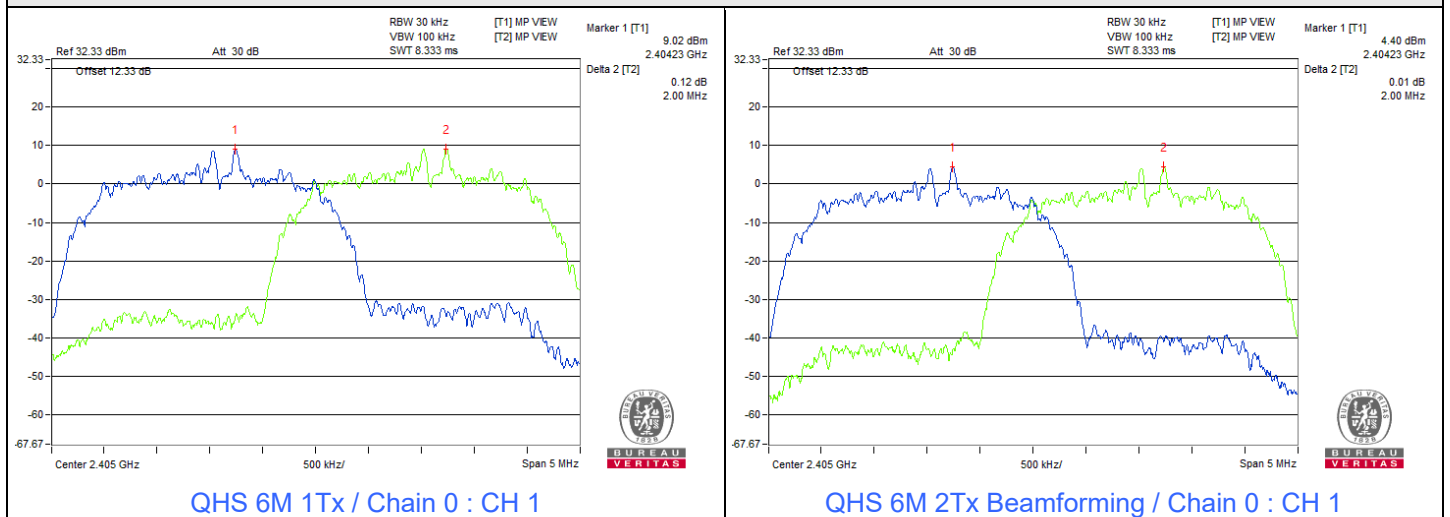

### 7.5 20 dB Bandwidth

Input Power:	3.3 Vdc	Environmental Conditions:	25°C, 60% RH	Tested By:	Kevin Ko
--------------	---------	---------------------------	--------------	------------	----------

#### QHS 6M 1Tx

Channel	Frequency (MHz)	20dB Bandwidth (MHz)
1	2404	2.52
18	2438	2.52
38	2478	2.53

#### QHS 6M 2Tx Beamforming

Channel	Frequency (MHz)	20dB Bandwidth (MHz)	
		Chain 0	Chain 1
1	2404	2.52	2.52
18	2438	2.52	2.52
38	2478	2.53	2.52

Spectrum Plot of Minimum Value

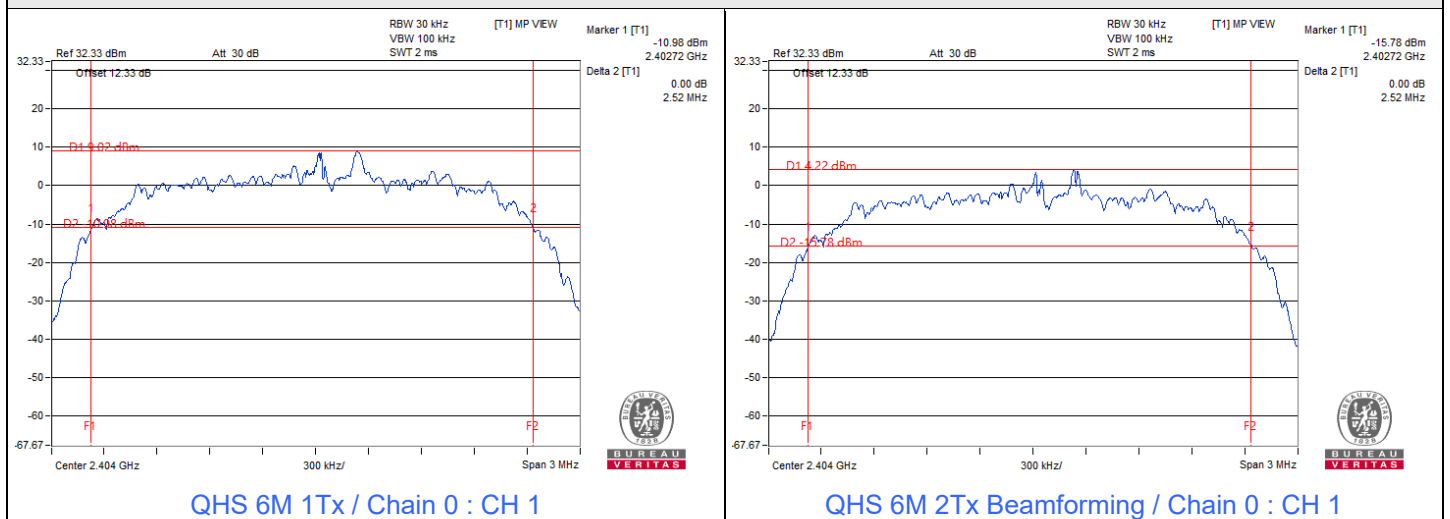

## 7.6 Conducted Out of Band Emissions

Input Power:	3.3 Vdc	Environmental Conditions:	25°C, 60% RH	Tested By:	Kevin Ko
--------------	---------	---------------------------	--------------	------------	----------

### QHS 6M 1Tx

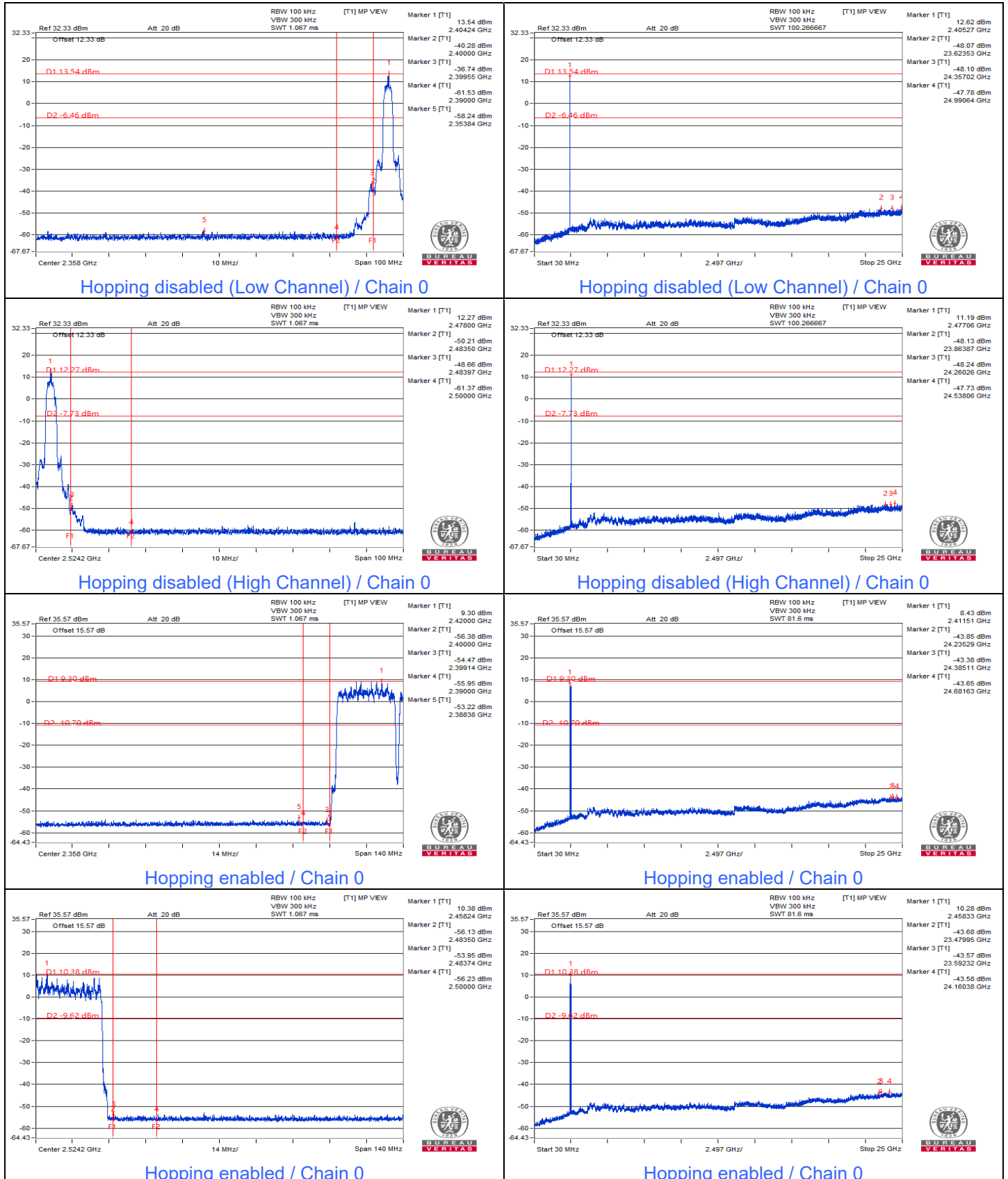



# QHS 6M 2Tx Beamforming

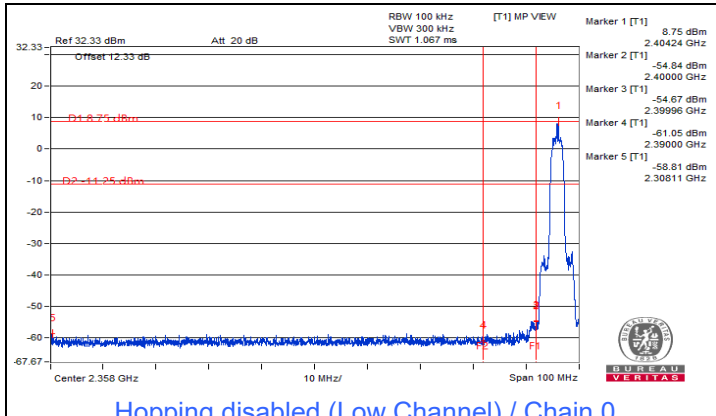

Hopping disabled (Low Channel) / Chain 0

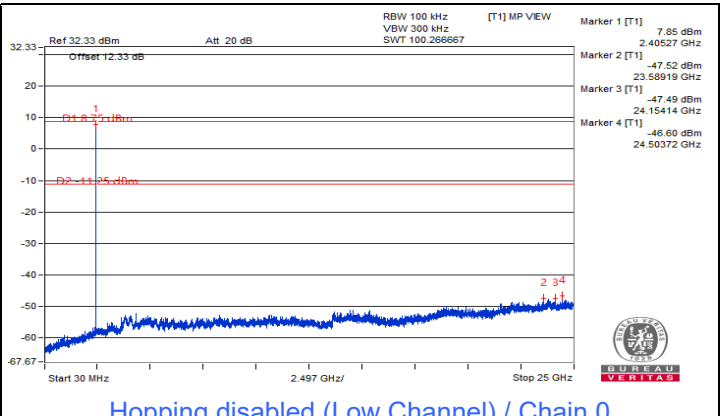

Hopping disabled (Low Channel) / Chain 0

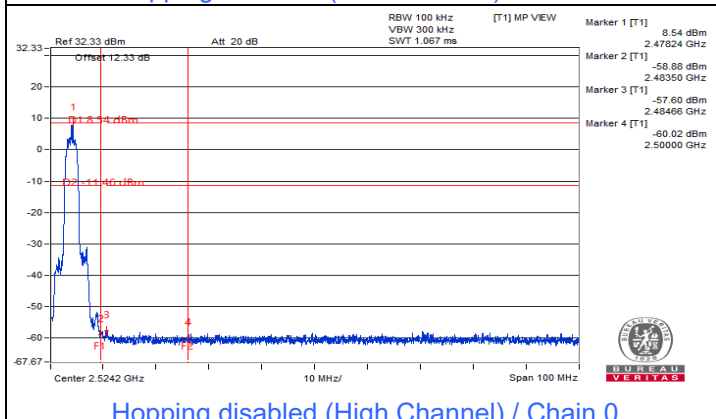

Hopping disabled (High Channel) / Chain 0

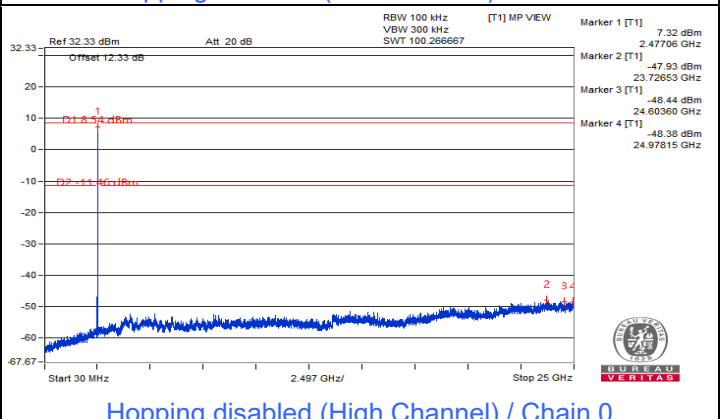

Hopping disabled (High Channel) / Chain 0

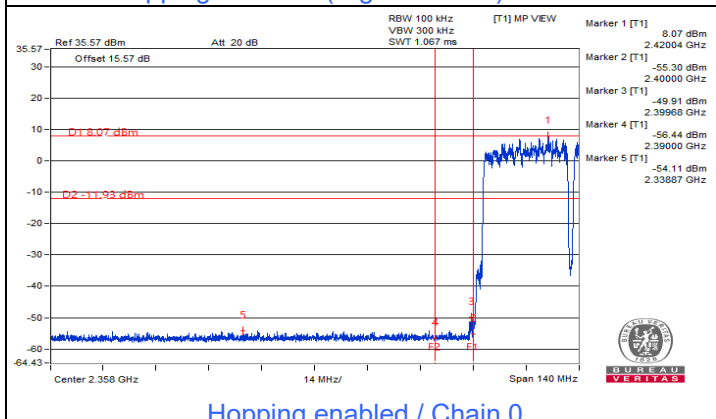

Hopping enabled / Chain 0

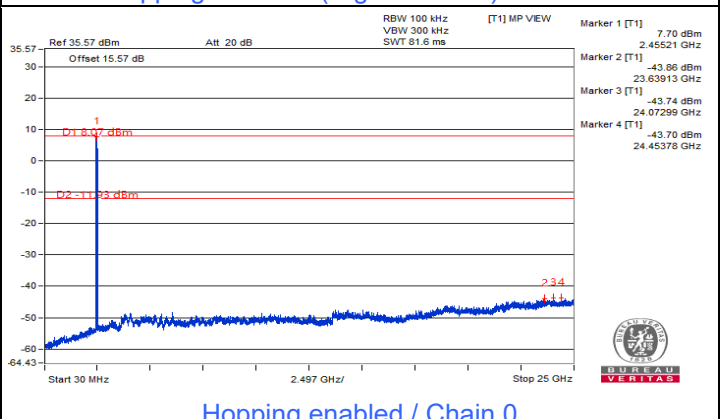

Hopping enabled / Chain 0

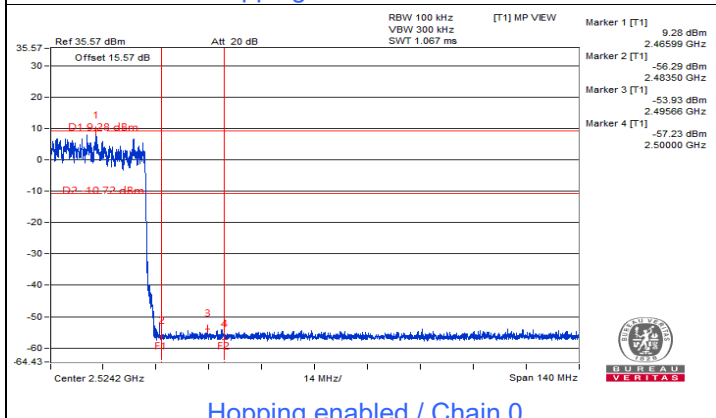

Hopping enabled / Chain 0



Hopping enabled / Chain 0

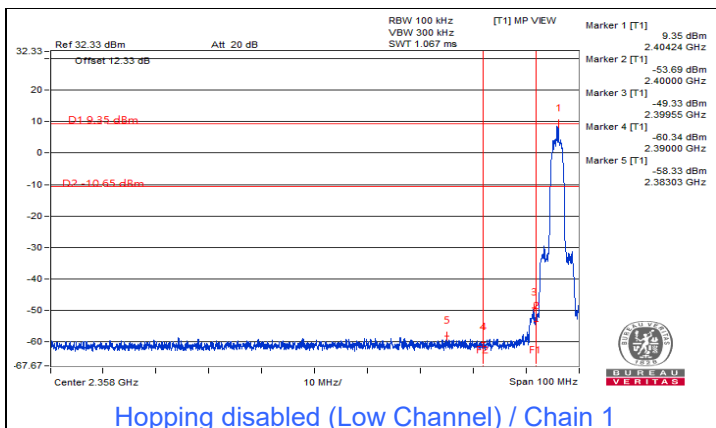

Hopping disabled (Low Channel) / Chain 1

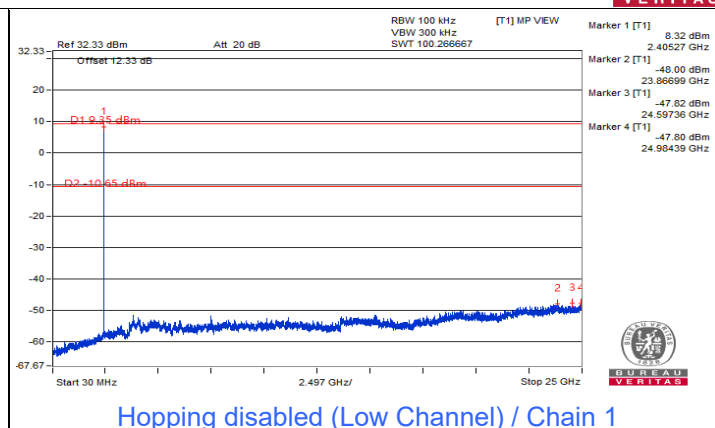

Hopping disabled (Low Channel) / Chain 1

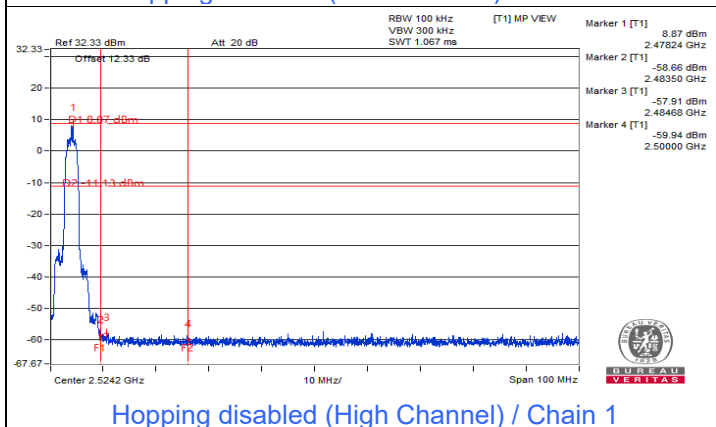

Hopping disabled (High Channel) / Chain 1

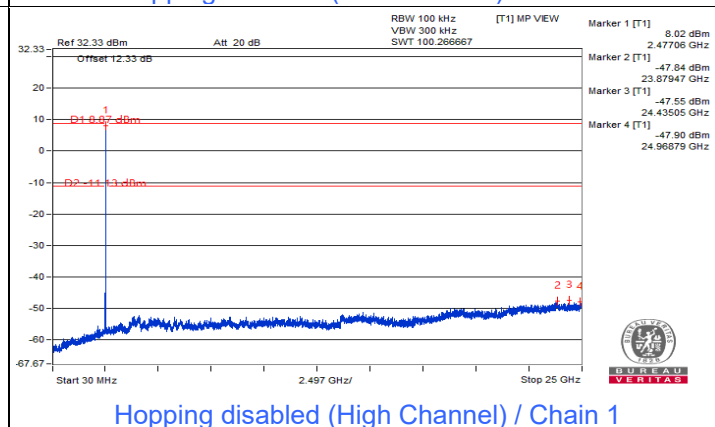

Hopping disabled (High Channel) / Chain 1

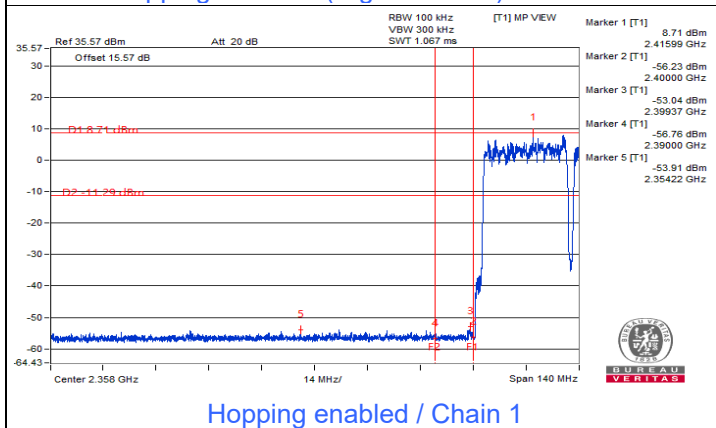

Hopping enabled / Chain 1



Hopping enabled / Chain 1

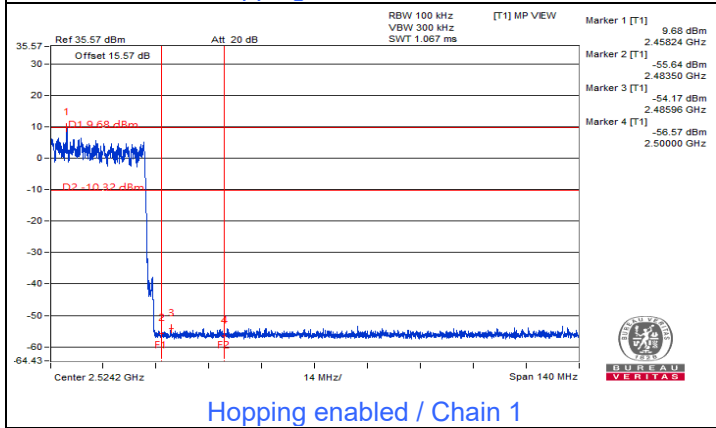

Hopping enabled / Chain 1

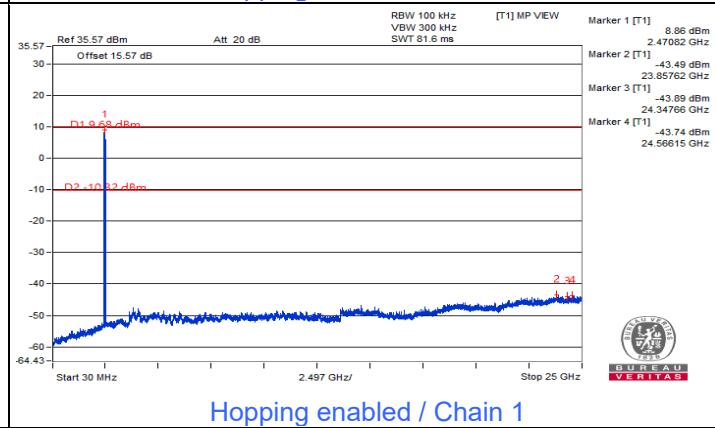

Hopping enabled / Chain 1

## 7.7 AC Power Conducted Emissions

1Tx

RF Mode	QHS 6M	Channel	CH 1 : 2404 MHz
Frequency Range	150 kHz ~ 30 MHz	Detector Function & Resolution Bandwidth	Quasi-Peak (QP) / Average (AV), 9 kHz
Input Power (System)	120 Vac, 60 Hz	Environmental Conditions	24°C, 70% RH
Tested By	Sampson Chen		

Phase Of Power : Line (L)										
No	Frequency (MHz)	Correction Factor (dB)	Reading Value (dBuV)		Emission Level (dBuV)		Limit (dBuV)		Margin (dB)	
			Q.P.	AV.	Q.P.	AV.	Q.P.	AV.	Q.P.	AV.
1	0.15781	9.94	31.59	21.20	41.53	31.14	65.58	55.58	-24.05	-24.44
<b>2</b>	<b>0.58359</b>	<b>9.96</b>	<b>32.54</b>	<b>23.87</b>	<b>42.50</b>	<b>33.83</b>	<b>56.00</b>	<b>46.00</b>	<b>-13.50</b>	<b>-12.17</b>
3	3.44922	10.15	19.88	10.52	30.03	20.67	56.00	46.00	-25.97	-25.33
4	13.60156	10.91	28.70	19.97	39.61	30.88	60.00	50.00	-20.39	-19.12
5	16.69531	11.13	29.86	23.31	40.99	34.44	60.00	50.00	-19.01	-15.56
6	28.97266	11.74	22.35	14.88	34.09	26.62	60.00	50.00	-25.91	-23.38

### Remarks:

1. Q.P. and AV. are abbreviations of quasi-peak and average individually.
2. The emission levels of other frequencies were very low against the limit.
3. Margin value = Emission level – Limit value
4. Correction factor = Insertion loss + Cable loss
5. Emission Level = Correction Factor + Reading Value

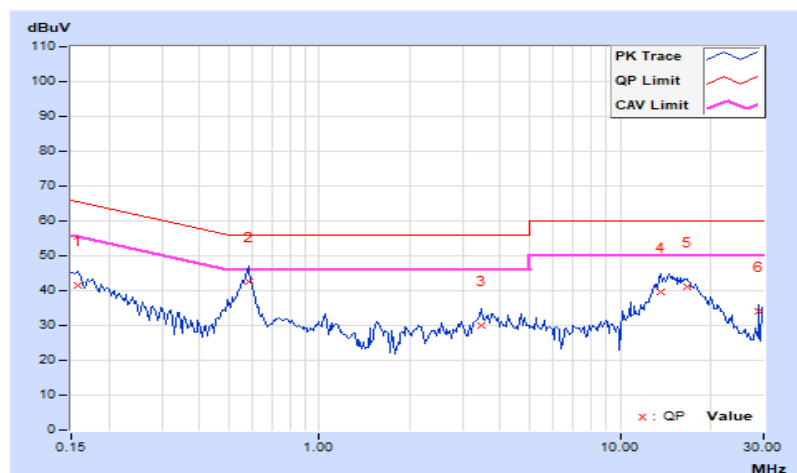

<b>RF Mode</b>	QHS 6M	<b>Channel</b>	CH 1 : 2404 MHz
<b>Frequency Range</b>	150 kHz ~ 30 MHz	<b>Detector Function &amp; Resolution Bandwidth</b>	Quasi-Peak (QP) / Average (AV), 9 kHz
<b>Input Power (System)</b>	120 Vac, 60 Hz	<b>Environmental Conditions</b>	24°C, 70% RH
<b>Tested By</b>	Sampson Chen		

Phase Of Power : Neutral (N)										
No	Frequency (MHz)	Correction Factor (dB)	Reading Value (dBuV)		Emission Level (dBuV)		Limit (dBuV)		Margin (dB)	
			Q.P.	AV.	Q.P.	AV.	Q.P.	AV.	Q.P.	AV.
1	0.15781	10.00	29.93	18.35	39.93	28.35	65.58	55.58	-25.65	-27.23
2	0.58359	10.02	26.61	18.22	36.63	28.24	56.00	46.00	-19.37	-17.76
3	1.10156	10.05	20.04	15.74	30.09	25.79	56.00	46.00	-25.91	-20.21
4	14.00391	10.83	27.48	19.35	38.31	30.18	60.00	50.00	-21.69	-19.82
5	17.17188	10.99	28.41	21.00	39.40	31.99	60.00	50.00	-20.60	-18.01
6	20.58203	11.15	23.47	17.20	34.62	28.35	60.00	50.00	-25.38	-21.65

**Remarks:**

1. Q.P. and AV. are abbreviations of quasi-peak and average individually.
2. The emission levels of other frequencies were very low against the limit.
3. Margin value = Emission level – Limit value
4. Correction factor = Insertion loss + Cable loss
5. Emission Level = Correction Factor + Reading Value

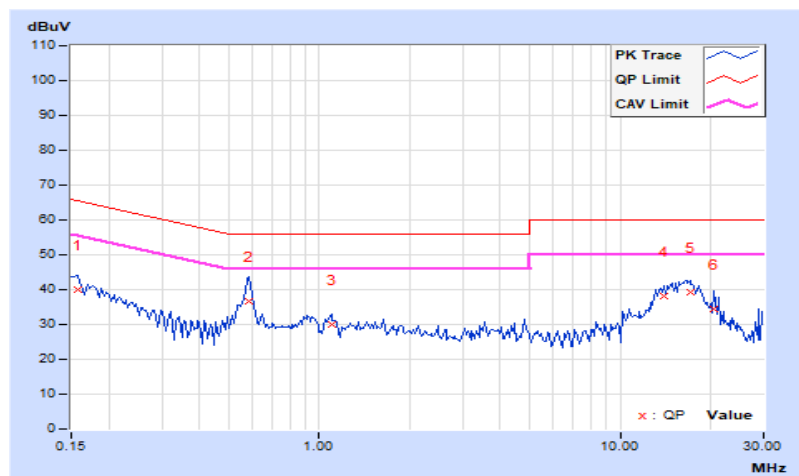

## 2Tx Beamforming

<b>RF Mode</b>	QHS 6M	<b>Channel</b>	CH 18 : 2438 MHz
<b>Frequency Range</b>	150 kHz ~ 30 MHz	<b>Detector Function &amp; Resolution Bandwidth</b>	Quasi-Peak (QP) / Average (AV), 9 kHz
<b>Input Power (System)</b>	120 Vac, 60 Hz	<b>Environmental Conditions</b>	24°C, 70% RH
<b>Tested By</b>	Sampson Chen		

Phase Of Power : Line (L)										
No	Frequency (MHz)	Correction Factor (dB)	Reading Value (dBuV)		Emission Level (dBuV)		Limit (dBuV)		Margin (dB)	
			Q.P.	AV.	Q.P.	AV.	Q.P.	AV.	Q.P.	AV.
1	0.15781	9.94	31.50	21.24	41.44	31.18	65.58	55.58	-24.14	-24.40
2	0.18906	9.94	28.08	15.54	38.02	25.48	64.08	54.08	-26.06	-28.60
3	0.58359	9.96	32.58	23.83	42.54	33.79	56.00	46.00	-13.46	-12.21
4	3.37500	10.14	18.35	8.36	28.49	18.50	56.00	46.00	-27.51	-27.50
5	16.77344	11.14	30.24	23.82	41.38	34.96	60.00	50.00	-18.62	-15.04
6	23.63281	11.52	23.01	13.45	34.53	24.97	60.00	50.00	-25.47	-25.03

### Remarks:

1. Q.P. and AV. are abbreviations of quasi-peak and average individually.
2. The emission levels of other frequencies were very low against the limit.
3. Margin value = Emission level – Limit value
4. Correction factor = Insertion loss + Cable loss
5. Emission Level = Correction Factor + Reading Value

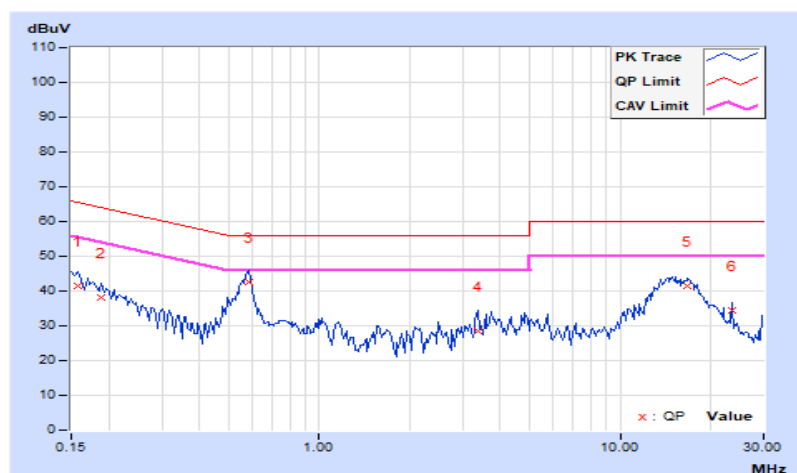



<b>RF Mode</b>	QHS 6M	<b>Channel</b>	CH 18 : 2438 MHz
<b>Frequency Range</b>	150 kHz ~ 30 MHz	<b>Detector Function &amp; Resolution Bandwidth</b>	Quasi-Peak (QP) / Average (AV), 9 kHz
<b>Input Power (System)</b>	120 Vac, 60 Hz	<b>Environmental Conditions</b>	24°C, 70% RH
<b>Tested By</b>	Sampson Chen		

Phase Of Power : Neutral (N)										
No	Frequency (MHz)	Correction Factor (dB)	Reading Value (dBuV)		Emission Level (dBuV)		Limit (dBuV)		Margin (dB)	
			Q.P.	AV.	Q.P.	AV.	Q.P.	AV.	Q.P.	AV.
1	0.15781	10.00	29.81	17.99	39.81	27.99	65.58	55.58	-25.77	-27.59
2	0.20859	10.00	25.68	12.53	35.68	22.53	63.26	53.26	-27.58	-30.73
3	0.59141	10.02	27.90	21.21	37.92	31.23	56.00	46.00	-18.08	-14.77
4	13.99219	10.83	27.17	18.90	38.00	29.73	60.00	50.00	-22.00	-20.27
5	16.80859	10.97	28.77	20.74	39.74	31.71	60.00	50.00	-20.26	-18.29
6	28.97266	11.36	22.55	15.16	33.91	26.52	60.00	50.00	-26.09	-23.48

**Remarks:**

1. Q.P. and AV. are abbreviations of quasi-peak and average individually.
2. The emission levels of other frequencies were very low against the limit.
3. Margin value = Emission level – Limit value
4. Correction factor = Insertion loss + Cable loss
5. Emission Level = Correction Factor + Reading Value

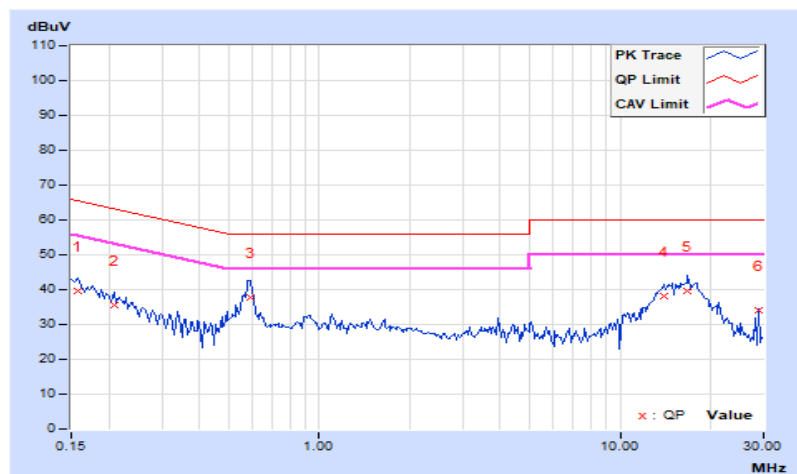

## 7.8 Unwanted Emissions below 1 GHz

### Mode A

#### 1Tx

RF Mode	QHS 6M	Channel	CH 1 : 2404 MHz
Frequency Range	30 MHz ~ 1 GHz	Input Power (System)	120 Vac, 60 Hz
Environmental Conditions	22°C, 55% RH	Tested By	Kevin Ko

Conducted Unwanted Emissions							
No.	Frequency (MHz)	Emission Level (dBuV/m)	Limit (dBuV/m)	Margin (dB)	Raw Value Chain 0 (dBm)	Correction Factor (dB)	EIRP Level (dBm)
1	32.06	29.91 PK	40	-10.09	-75.21	9.86	-65.35
2	147.73	26.82 PK	43.5	-16.68	-78.3	9.86	-68.44
3	267.77	27.3 PK	46	-18.7	-77.82	9.86	-67.96
4	468.8	28.64 PK	46	-17.36	-76.48	9.86	-66.62
5	748.28	28.17 PK	46	-17.83	-76.95	9.86	-67.09
6	857.29	28.45 PK	46	-17.55	-76.67	9.86	-66.81

#### Notes:

1. Margin value = Emission Level - Limit value
2. The frequency range 9 kHz ~ 30 MHz: all emissions are more than 20 dB below the limit, therefore do not be recorded in this report.

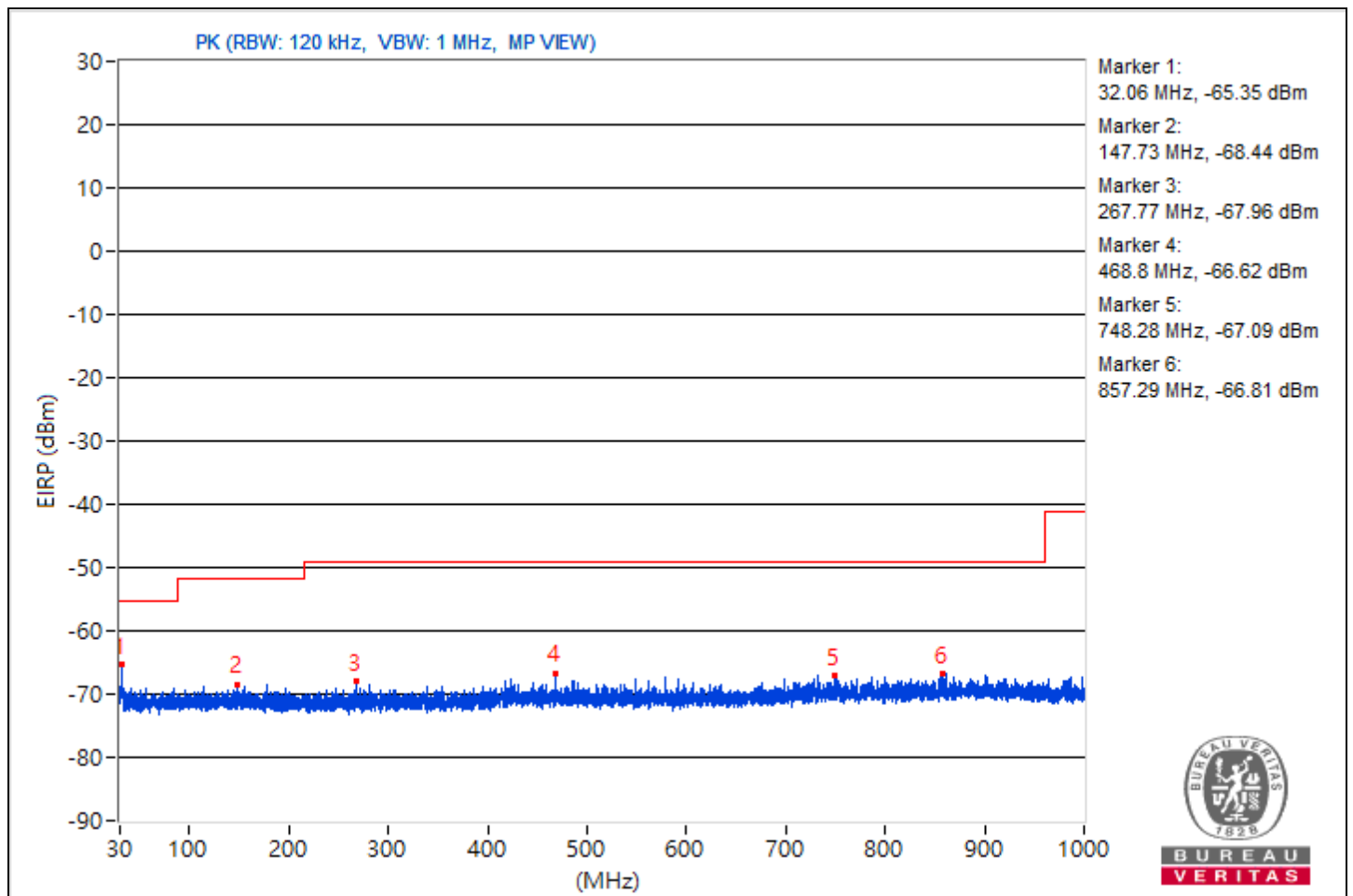

## 2Tx Beamforming

RF Mode	QHS 6M	Channel	CH 18 : 2438 MHz
Frequency Range	30 MHz ~ 1 GHz	Input Power (System)	120 Vac, 60 Hz
Environmental Conditions	22°C, 55% RH	Tested By	Kevin Ko

Conducted Unwanted Emissions								
No.	Frequency (MHz)	Emission Level (dBuV/m)	Limit (dBuV/m)	Margin (dB)	Raw Value Chain 0 (dBm)	Raw Value Chain 1 (dBm)	Correction Factor (dB)	EIRP Level (dBm)
1	33.27	26.79 PK	40	-13.21	-83.54	-85.33	12.87	-68.47
2	196.35	26.88 PK	43.5	-16.62	-85.04	-83.05	12.87	-68.38
3	385.99	27.14 PK	46	-18.86	-82.52	-86.28	12.87	-68.12
4	523.37	27.66 PK	46	-18.34	-85.16	-82.19	12.87	-67.6
5	700.63	28.06 PK	46	-17.94	-85.34	-81.61	12.87	-67.2
6	917.31	28.73 PK	46	-17.27	-83.59	-81.48	12.87	-66.53

### Notes:

1. Margin value = Emission Level - Limit value
2. The frequency range 9 kHz ~ 30 MHz: all emissions are more than 20 dB below the limit, therefore do not be recorded in this report.

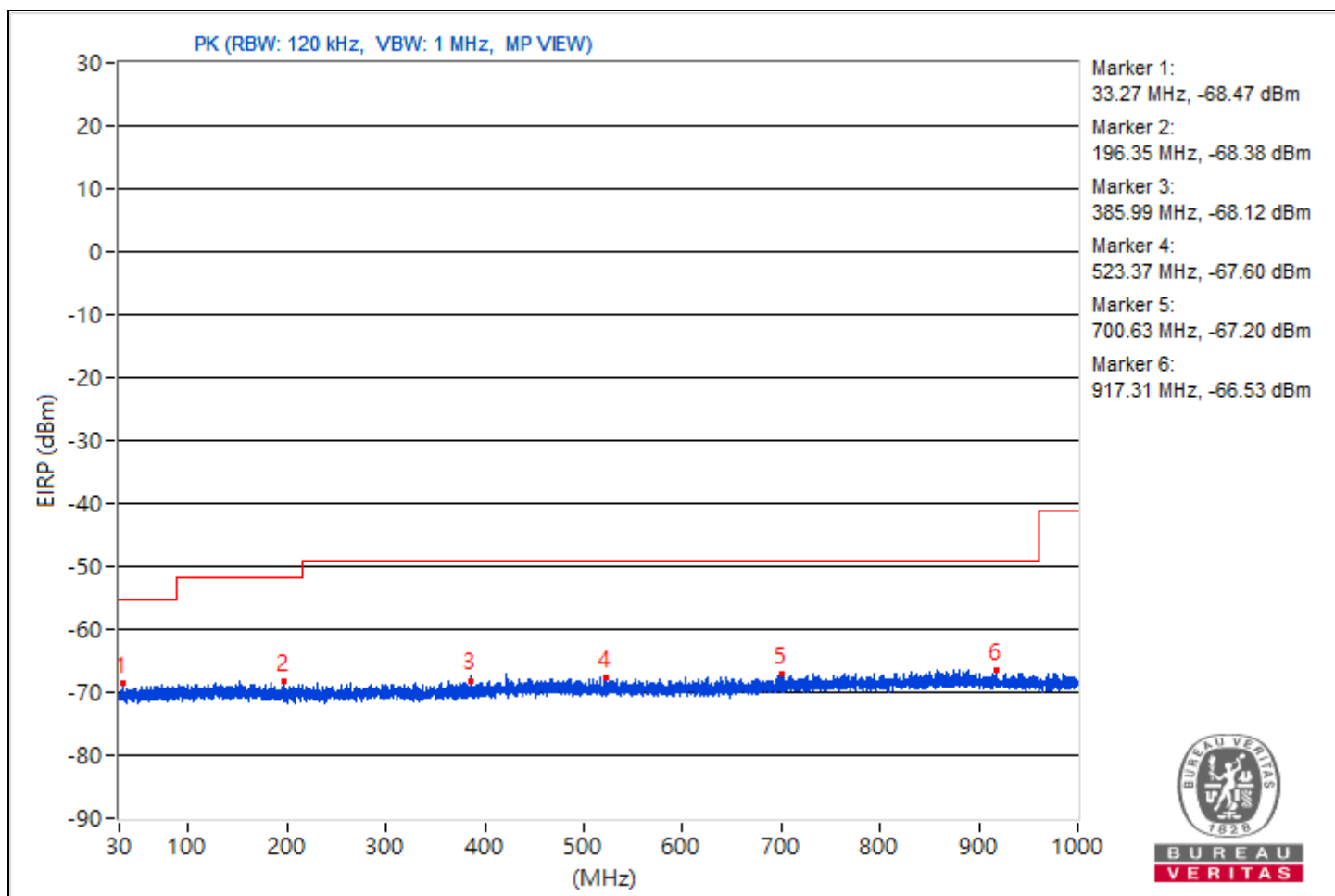

## Mode B

### 1Tx

<b>RF Mode</b>	QHS 6M	<b>Channel</b>	CH 1 : 2404 MHz
<b>Frequency Range</b>	30 MHz ~ 1 GHz	<b>Detector Function &amp; Bandwidth</b>	QP: RB=120kHz, DET=Quasi-Peak
<b>Input Power (System)</b>	120 Vac, 60 Hz	<b>Environmental Conditions</b>	23°C, 73% RH
<b>Tested By</b>	Sampson Chen		

#### Antenna Polarity & Test Distance : Horizontal at 3 m

No	Frequency (MHz)	Emission Level (dBuV/m)	Limit (dBuV/m)	Margin (dB)	Antenna Height (m)	Table Angle (Degree)	Raw Value (dBuV)	Correction Factor (dB/m)
1	53.17	35.2 QP	40.0	-4.8	1.00 H	76	47.9	-12.7
2	116.56	38.1 QP	43.5	-5.4	1.50 H	150	53.3	-15.2
3	229.93	35.8 QP	46.0	-10.2	2.00 H	107	51.1	-15.3
4	310.80	42.1 QP	46.0	-3.9	1.00 H	194	53.6	-11.5
5	456.32	29.0 QP	46.0	-17.0	2.00 H	80	36.9	-7.9
6	502.19	39.2 QP	46.0	-6.8	1.50 H	264	46.3	-7.1

#### Remarks:

1. Emission Level(dBuV/m) = Raw Value(dBuV) + Correction Factor(dB/m)
2. Correction Factor(dB/m) = Antenna Factor(dB/m) + Cable Factor(dB) – Pre-Amplifier Factor(dB)
3. Margin value = Emission Level – Limit value
4. The other emission levels were very low against the limit of frequency range 30 MHz ~ 1 GHz.
5. The frequency range 9 kHz ~ 30 MHz: all emissions are more than 20 dB below the limit, therefore do not be recorded in this report.

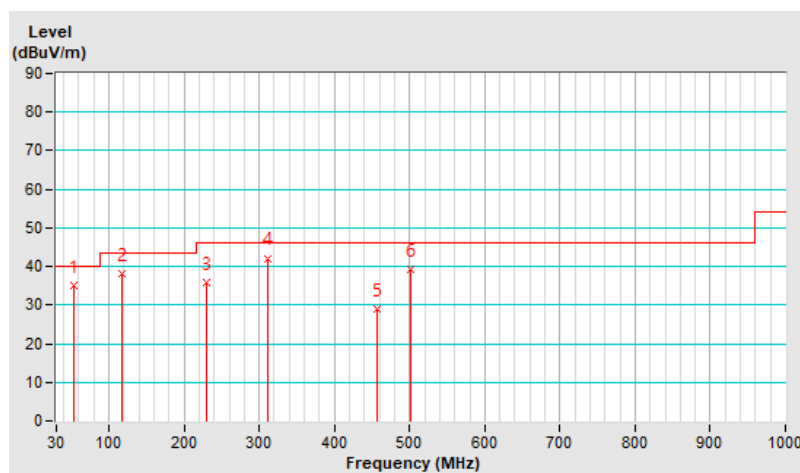

<b>RF Mode</b>	QHS 6M	<b>Channel</b>	CH 1 : 2404 MHz
<b>Frequency Range</b>	30 MHz ~ 1 GHz	<b>Detector Function &amp; Bandwidth</b>	QP: RB=120kHz, DET=Quasi-Peak
<b>Input Power (System)</b>	120 Vac, 60 Hz	<b>Environmental Conditions</b>	25°C, 68% RH
<b>Tested By</b>	Sampson Chen		

Antenna Polarity & Test Distance : Vertical at 3 m								
No	Frequency (MHz)	Emission Level (dBuV/m)	Limit (dBuV/m)	Margin (dB)	Antenna Height (m)	Table Angle (Degree)	Raw Value (dBuV)	Correction Factor (dB/m)
1	47.23	33.3 QP	40.0	-6.7	1.50 V	194	45.9	-12.6
2	104.84	37.7 QP	43.5	-5.8	1.50 V	294	54.1	-16.4
3	206.87	36.8 QP	43.5	-6.7	1.50 V	106	52.9	-16.1
4	300.56	40.1 QP	46.0	-5.9	2.00 V	150	52.0	-11.9
5	429.59	30.6 QP	46.0	-15.4	2.00 V	197	39.3	-8.7
6	518.78	39.0 QP	46.0	-7.0	1.50 V	255	45.6	-6.6

**Remarks:**

1. Emission Level(dBuV/m) = Raw Value(dBuV) + Correction Factor(dB/m)
2. Correction Factor(dB/m) = Antenna Factor(dB/m) + Cable Factor(dB) – Pre-Amplifier Factor(dB)
3. Margin value = Emission Level – Limit value
4. The other emission levels were very low against the limit of frequency range 30 MHz ~ 1 GHz.
5. The frequency range 9 kHz ~ 30 MHz: all emissions are more than 20 dB below the limit, therefore do not be recorded in this report.

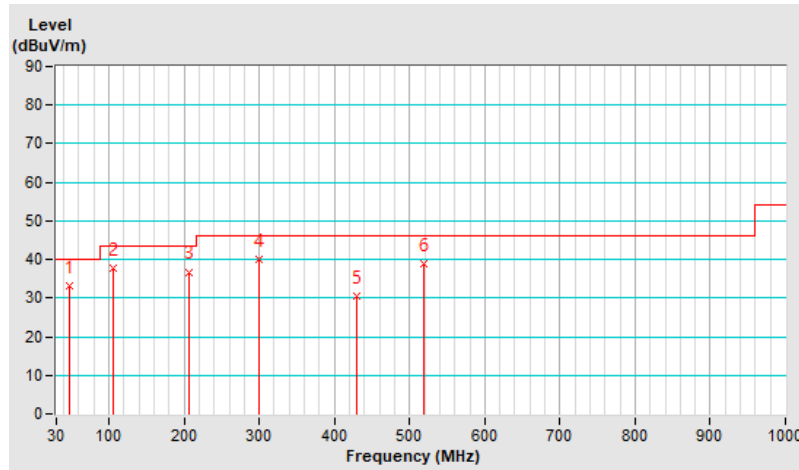

## 2Tx Beamforming

RF Mode	QHS 6M	Channel	CH 18 : 2438 MHz
Frequency Range	30 MHz ~ 1 GHz	Detector Function & Bandwidth	QP: RB=120kHz, DET=Quasi-Peak
Input Power (System)	120 Vac, 60 Hz	Environmental Conditions	23°C, 73% RH
Tested By	Sampson Chen		

Antenna Polarity & Test Distance : Horizontal at 3 m								
No	Frequency (MHz)	Emission Level (dBuV/m)	Limit (dBuV/m)	Margin (dB)	Antenna Height (m)	Table Angle (Degree)	Raw Value (dBuV)	Correction Factor (dB/m)
1	54.02	34.7 QP	40.0	-5.3	1.50 H	97	47.6	-12.9
2	118.23	38.5 QP	43.5	-5.0	2.00 H	147	53.5	-15.0
3	232.23	36.0 QP	46.0	-10.0	1.50 H	94	51.0	-15.0
<b>4</b>	<b>309.34</b>	<b>42.5 QP</b>	<b>46.0</b>	<b>-3.5</b>	<b>1.50 H</b>	<b>207</b>	<b>54.1</b>	<b>-11.6</b>
5	455.23	29.2 QP	46.0	-16.8	1.50 H	85	37.0	-7.8
6	503.46	39.0 QP	46.0	-7.0	2.00 H	280	46.1	-7.1

### Remarks:

1. Emission Level(dBuV/m) = Raw Value(dBuV) + Correction Factor(dB/m)
2. Correction Factor(dB/m) = Antenna Factor(dB/m) + Cable Factor(dB) – Pre-Amplifier Factor(dB)
3. Margin value = Emission Level – Limit value
4. The other emission levels were very low against the limit of frequency range 30 MHz ~ 1 GHz.
5. The frequency range 9 kHz ~ 30 MHz: all emissions are more than 20 dB below the limit, therefore do not be recorded in this report.

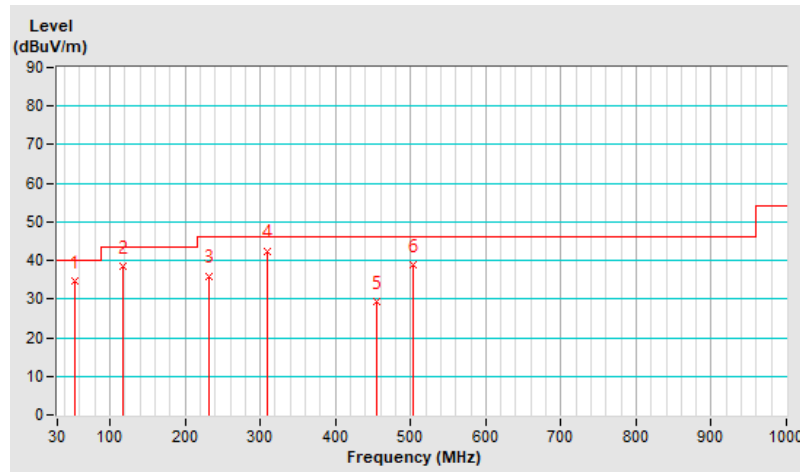

<b>RF Mode</b>	QHS 6M	<b>Channel</b>	CH 18 : 2438 MHz
<b>Frequency Range</b>	30 MHz ~ 1 GHz	<b>Detector Function &amp; Bandwidth</b>	QP: RB=120kHz, DET=Quasi-Peak
<b>Input Power (System)</b>	120 Vac, 60 Hz	<b>Environmental Conditions</b>	25°C, 68% RH
<b>Tested By</b>	Sampson Chen		

Antenna Polarity & Test Distance : Vertical at 3 m								
No	Frequency (MHz)	Emission Level (dBuV/m)	Limit (dBuV/m)	Margin (dB)	Antenna Height (m)	Table Angle (Degree)	Raw Value (dBuV)	Correction Factor (dB/m)
1	48.31	34.0 QP	40.0	-6.0	2.00 V	207	46.5	-12.5
2	105.64	38.0 QP	43.5	-5.5	2.00 V	157	54.4	-16.4
3	208.32	37.0 QP	43.5	-6.5	2.00 V	156	53.1	-16.1
4	302.22	39.8 QP	46.0	-6.2	2.00 V	165	51.7	-11.9
5	430.64	29.9 QP	46.0	-16.1	1.50 V	207	38.4	-8.5
6	522.03	39.2 QP	46.0	-6.8	2.00 V	211	45.8	-6.6

**Remarks:**

1. Emission Level(dBuV/m) = Raw Value(dBuV) + Correction Factor(dB/m)
2. Correction Factor(dB/m) = Antenna Factor(dB/m) + Cable Factor(dB) – Pre-Amplifier Factor(dB)
3. Margin value = Emission Level – Limit value
4. The other emission levels were very low against the limit of frequency range 30 MHz ~ 1 GHz.
5. The frequency range 9 kHz ~ 30 MHz: all emissions are more than 20 dB below the limit, therefore do not be recorded in this report.

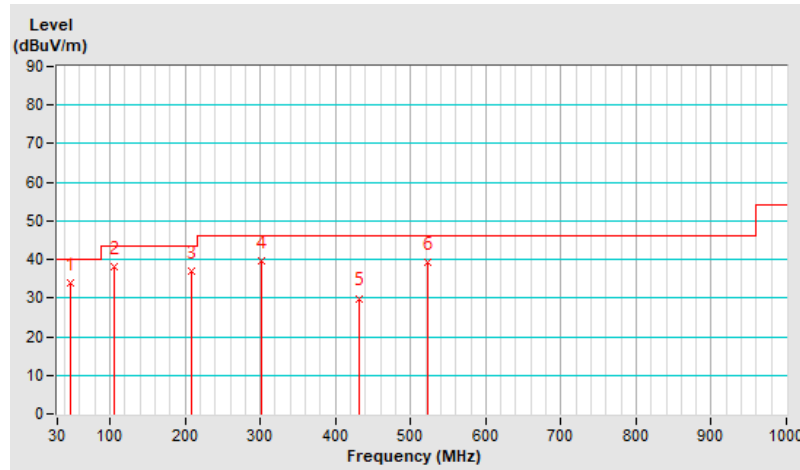

## 7.9 Unwanted Emissions above 1 GHz

### Mode A

### 1Tx

### Conducted Unwanted Emissions

RF Mode	QHS 6M	Channel	CH 1 : 2404 MHz
Frequency Range	1 GHz ~ 25 GHz	Input Power (System)	120 Vac, 60 Hz
Environmental Conditions	22°C, 55% RH	Tested By	Kevin Ko

Conducted Unwanted Emissions							
No.	Frequency (MHz)	Emission Level (dBuV/m)	Limit (dBuV/m)	Margin (dB)	Raw Value Chain 0 (dBm)	Correction Factor (dB)	EIRP Level (dBm)
1	2321.76	50.28 PK	74	-23.72	-50.14	5.16	-44.98
2	2247.63	32.61 AV	54	-21.39	-67.81	5.16	-62.65
3	4001.91	55.11 PK	74	-18.89	-45.31	5.16	-40.15
4	3730.78	39.25 AV	54	-14.75	-61.17	5.16	-56.01
5	10674.76	55.51 PK	74	-18.49	-44.91	5.16	-39.75
6	15681.33	40.26 AV	54	-13.74	-60.16	5.16	-55
7	23902.5	60.48 PK	74	-13.52	-39.94	5.16	-34.78
8	23899.7	43.48 AV	54	-10.52	-56.94	5.16	-51.78

Note: Margin value = Emission Level - Limit value

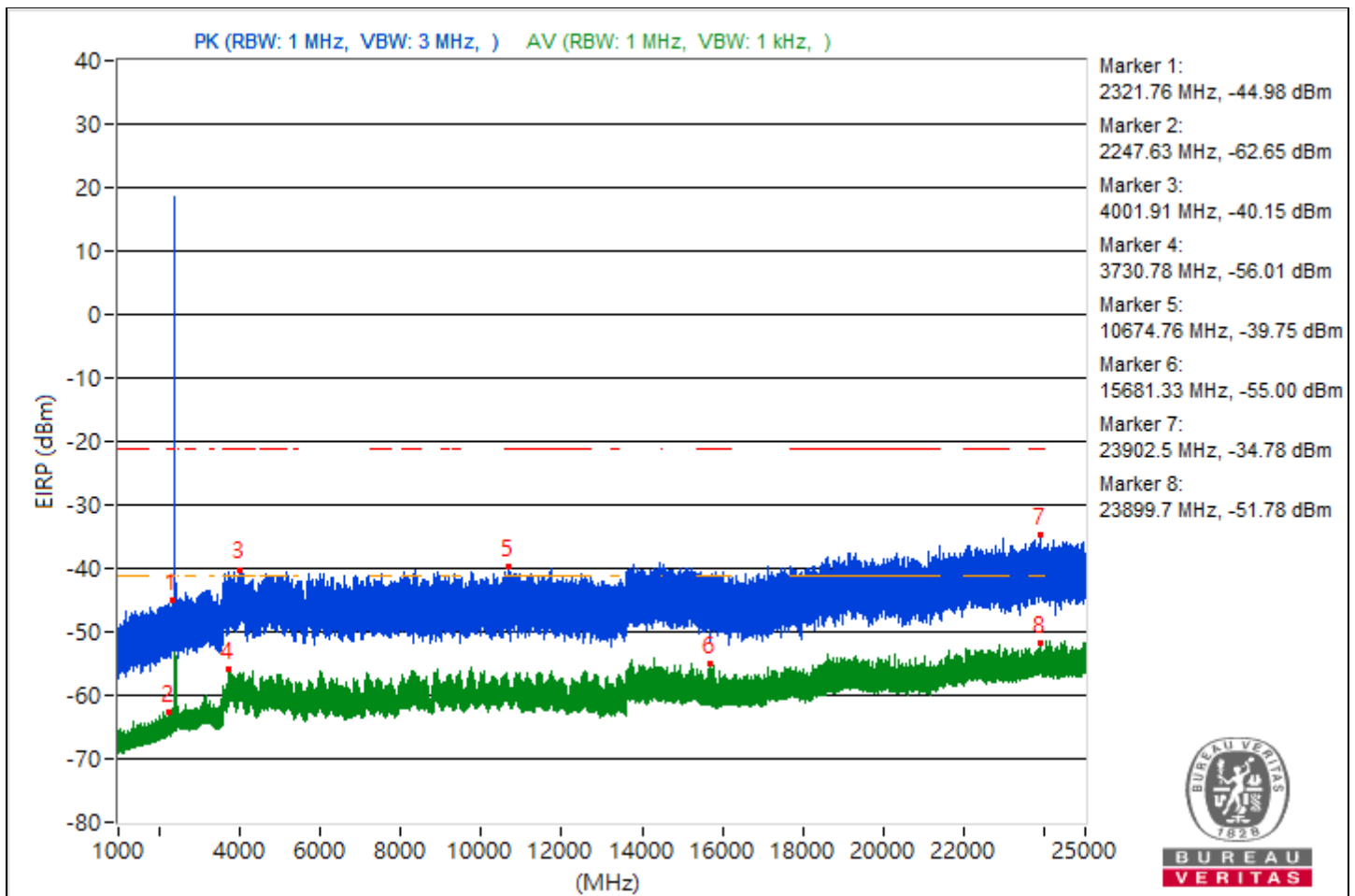





RF Mode	QHS 6M	Channel	CH 18 : 2438 MHz
Frequency Range	1 GHz ~ 25 GHz	Input Power (System)	120 Vac, 60 Hz
Environmental Conditions	22°C, 55% RH	Tested By	Kevin Ko

Conducted Unwanted Emissions							
No.	Frequency (MHz)	Emission Level (dBuV/m)	Limit (dBuV/m)	Margin (dB)	Raw Value Chain 0 (dBm)	Correction Factor (dB)	EIRP Level (dBm)
1	2242.03	49.23 PK	74	-24.77	-51.19	5.16	-46.03
2	2333.97	32.97 AV	54	-21.03	-67.45	5.16	-62.29
3	4092.06	55.28 PK	74	-18.72	-45.14	5.16	-39.98
4	3796.5	39.98 AV	54	-14.02	-60.44	5.16	-55.28
5	14474.22	56.01 PK	74	-17.99	-44.41	5.16	-39.25
6	11752	39.52 AV	54	-14.48	-60.9	5.16	-55.74
7	23788.4	59.29 PK	74	-14.71	-41.13	5.16	-35.97
8	23797.7	44.1 AV	54	-9.9	-56.32	5.16	-51.16

Note: Margin value = Emission Level - Limit value

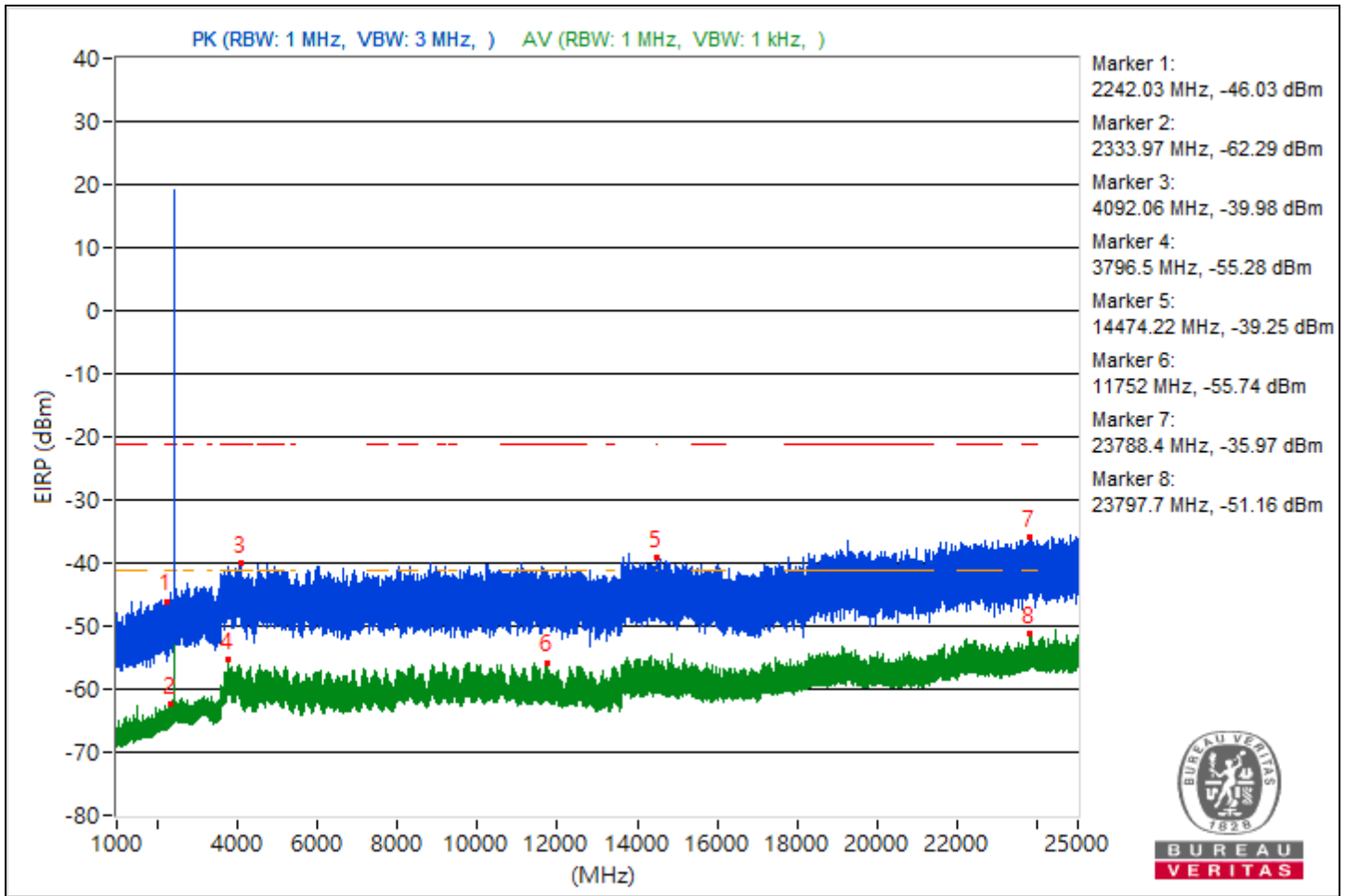

RF Mode	QHS 6M	Channel	CH 38 : 2478 MHz
Frequency Range	1 GHz ~ 25 GHz	Input Power (System)	120 Vac, 60 Hz
Environmental Conditions	22°C, 55% RH	Tested By	Kevin Ko

Conducted Unwanted Emissions							
No.	Frequency (MHz)	Emission Level (dBUV/m)	Limit (dBUV/m)	Margin (dB)	Raw Value Chain 0 (dBm)	Correction Factor (dB)	EIRP Level (dBm)
1	2331.09	49.93 PK	74	-24.07	-50.49	5.16	-45.33
2	2200.03	33.18 AV	54	-20.82	-67.24	5.16	-62.08
3	4726.1	55.69 PK	74	-18.31	-44.73	5.16	-39.57
4	4028.04	39.54 AV	54	-14.46	-60.88	5.16	-55.72
5	10675.82	55.5 PK	74	-18.5	-44.92	5.16	-39.76
6	12594.67	39.86 AV	54	-14.14	-60.56	5.16	-55.4
7	23775.5	60.14 PK	74	-13.86	-40.28	5.16	-35.12
8	23903.7	44.08 AV	54	-9.92	-56.34	5.16	-51.18

Note: Margin value = Emission Level - Limit value

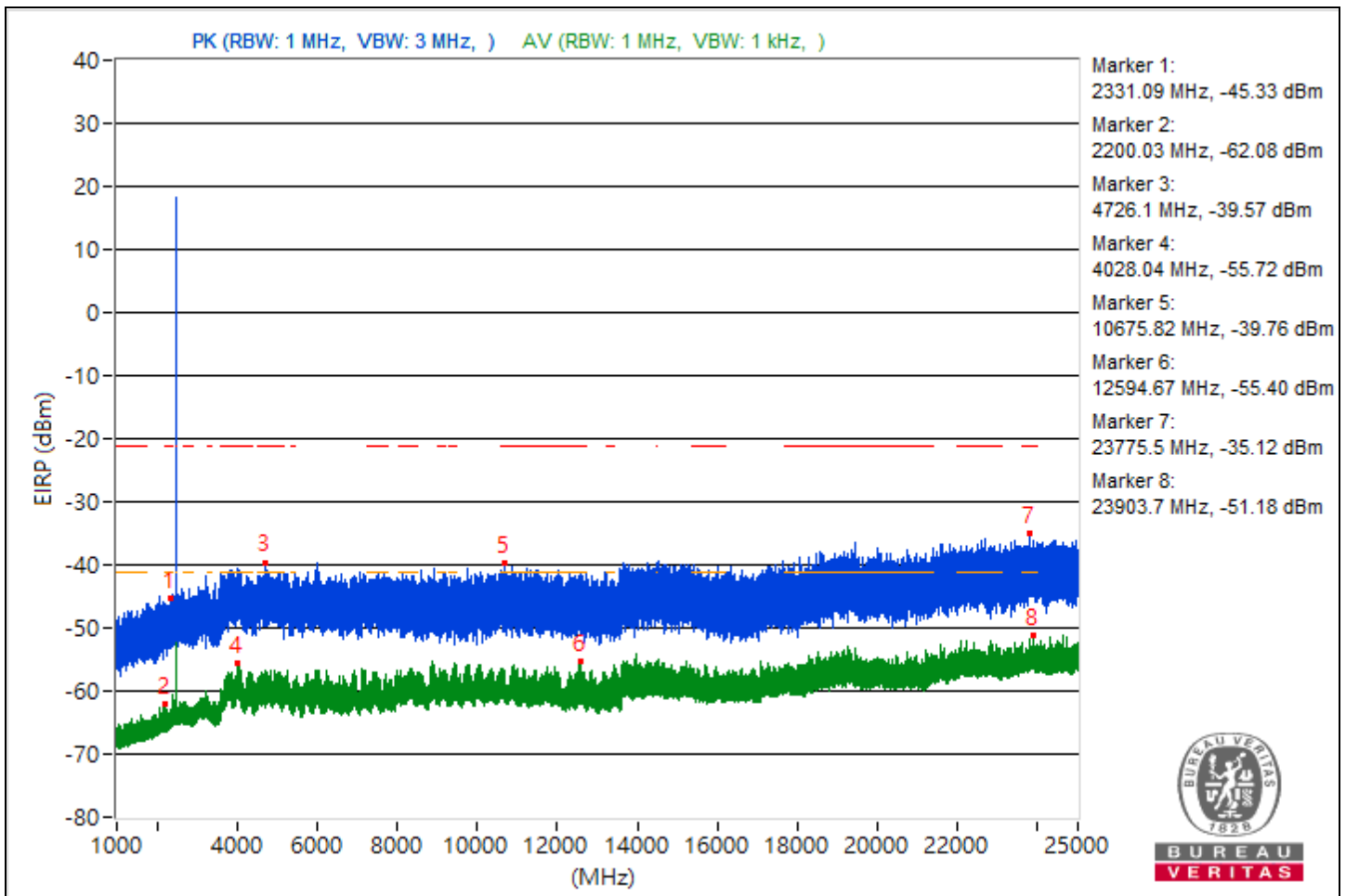

### Conducted Band Edges

RF Mode	QHS 6M	Channel	CH 1 : 2404 MHz
Frequency Range	2.31 GHz ~ 2.5 GHz	Input Power (System)	120 Vac, 60 Hz
Environmental Conditions	22°C, 55% RH	Tested By	Kevin Ko

Conducted Band Edge							
No.	Frequency (MHz)	Emission Level (dBuV/m)	Limit (dBuV/m)	Margin (dB)	Raw Value Chain 0 (dBm)	Correction Factor (dB)	EIRP Level (dBm)
1	*2403.98	113.28 PK			14.49	3.53	18.02
2	*2403.98	107.91 AV			9.12	3.53	12.65
3	2361.42	49.34 PK	74	-24.66	-49.45	3.53	-45.92
4	2387.24	32.83 AV	54	-21.17	-65.96	3.53	-62.43
5	2494.63	49.47 PK	74	-24.53	-49.32	3.53	-45.79
6	2496.11	33.56 AV	54	-20.44	-65.23	3.53	-61.7

Notes:

1. Margin value = Emission Level - Limit value
2. " \* ": Fundamental frequency, the limit was restricted at the RF Output Power.

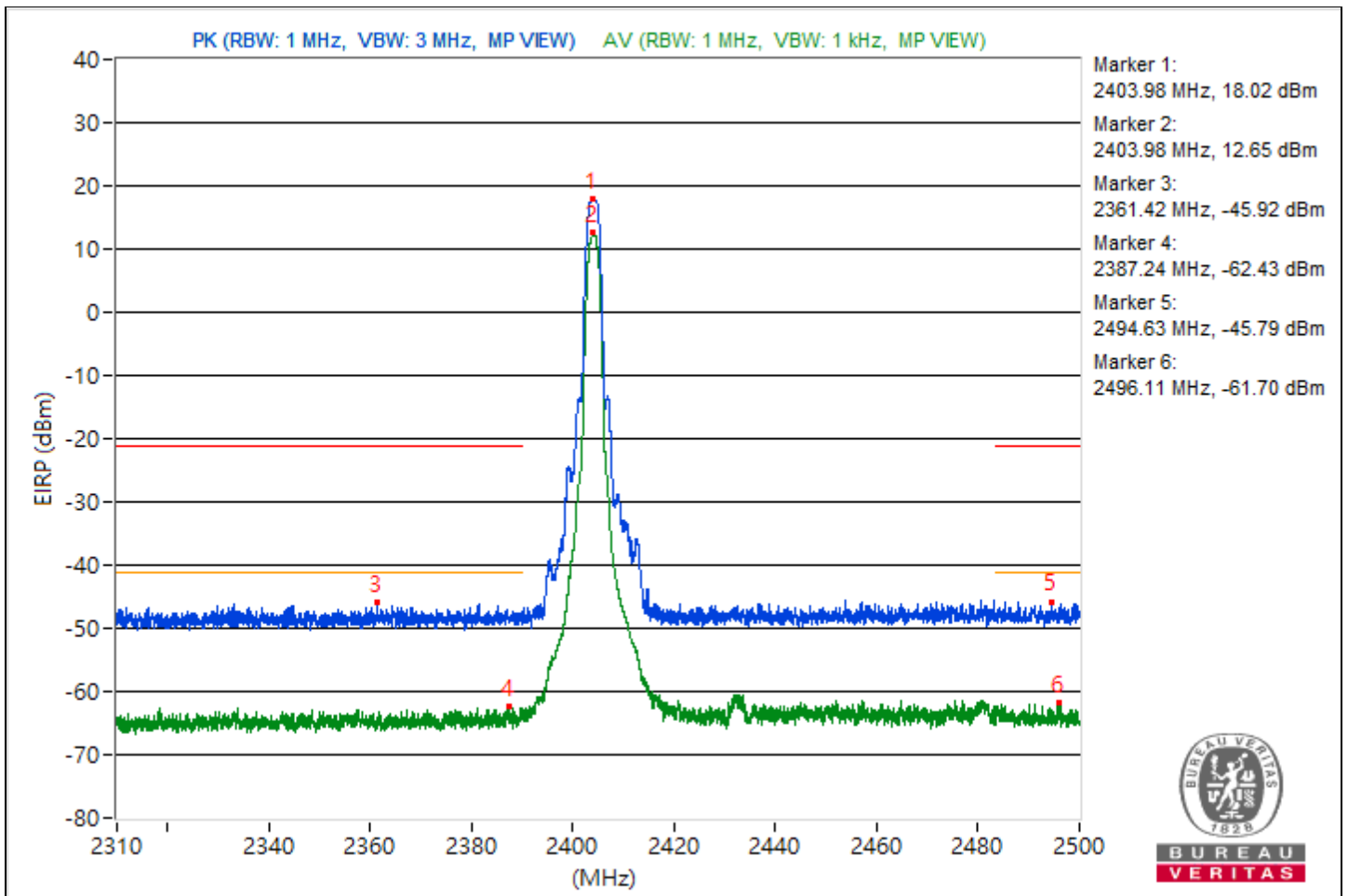

RF Mode	QHS 6M	Channel	CH 18 : 2438 MHz
Frequency Range	2.31 GHz ~ 2.5 GHz	Input Power (System)	120 Vac, 60 Hz
Environmental Conditions	22°C, 55% RH	Tested By	Kevin Ko

Conducted Band Edge							
No.	Frequency (MHz)	Emission Level (dBuV/m)	Limit (dBuV/m)	Margin (dB)	Raw Value Chain 0 (dBm)	Correction Factor (dB)	EIRP Level (dBm)
1	*2437.73	113.19 PK			14.4	3.53	17.93
2	*2437.99	107.8 AV			9.01	3.53	12.54
3	2337.74	50.15 PK	74	-23.85	-48.64	3.53	-45.11
4	2383.74	30.95 AV	54	-23.05	-67.84	3.53	-64.31
5	2483.99	50.07 PK	74	-23.93	-48.72	3.53	-45.19
6	2499.81	30.28 AV	54	-23.72	-68.51	3.53	-64.98

- Notes:
- Margin value = Emission Level - Limit value
  - " \* " : Fundamental frequency, the limit was restricted at the RF Output Power.

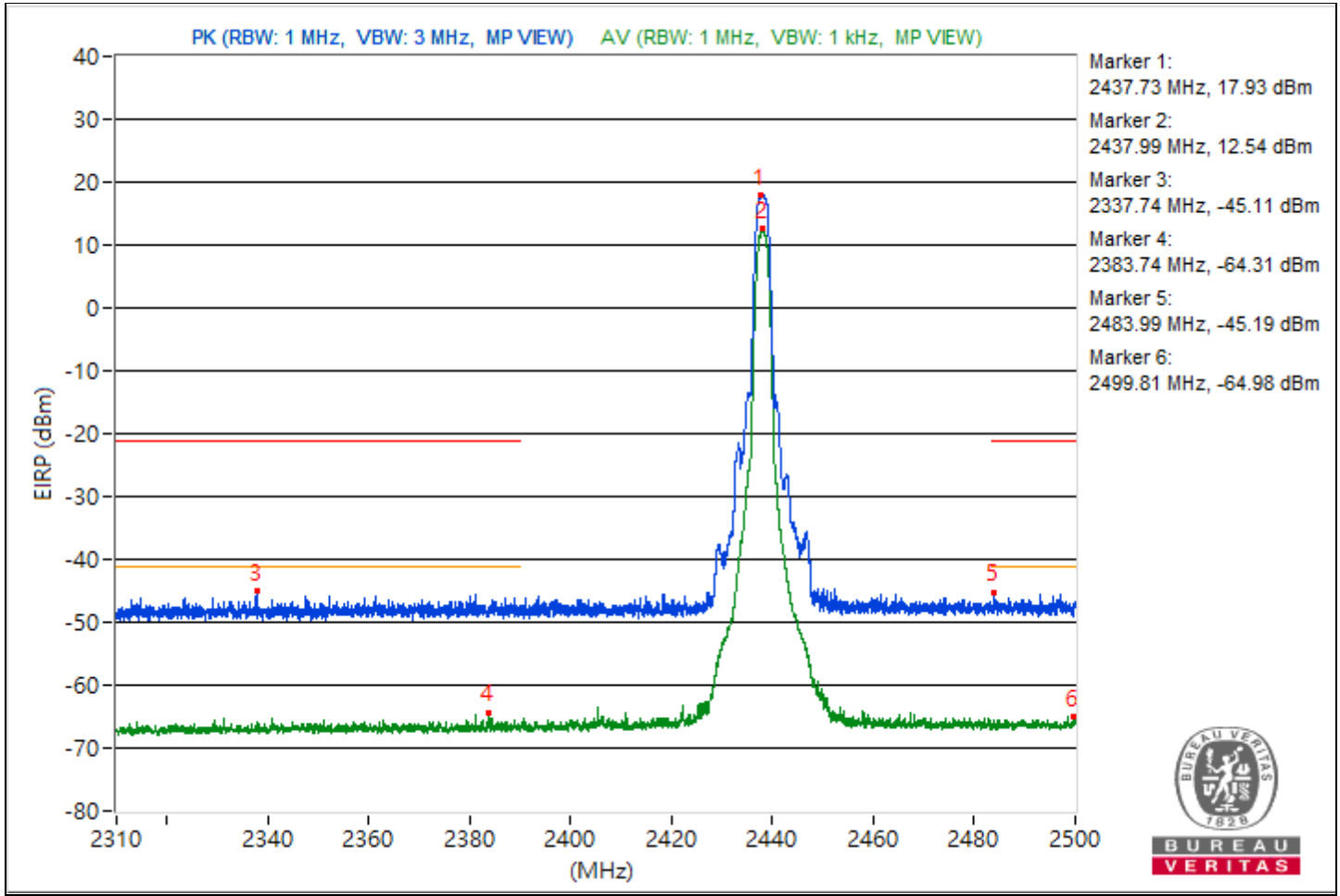

RF Mode	QHS 6M	Channel	CH 38 : 2478 MHz
Frequency Range	2.31 GHz ~ 2.5 GHz	Input Power (System)	120 Vac, 60 Hz
Environmental Conditions	22°C, 55% RH	Tested By	Kevin Ko

Conducted Band Edge							
No.	Frequency (MHz)	Emission Level (dBuV/m)	Limit (dBuV/m)	Margin (dB)	Raw Value Chain 0 (dBm)	Correction Factor (dB)	EIRP Level (dBm)
1	*2477.98	112.88 PK			14.09	3.53	17.62
2	*2477.96	107.45 AV			8.66	3.53	12.19
3	2384.39	49.98 PK	74	-24.02	-48.81	3.53	-45.28
4	2389.8	33.57 AV	54	-20.43	-65.22	3.53	-61.69
5	2483.5	62.05 PK	74	-11.95	-36.74	3.53	-33.21
6	2483.5	47.78 AV	54	-6.22	-51.01	3.53	-47.48

Notes:

1. Margin value = Emission Level - Limit value
2. " \* " : Fundamental frequency, the limit was restricted at the RF Output Power.

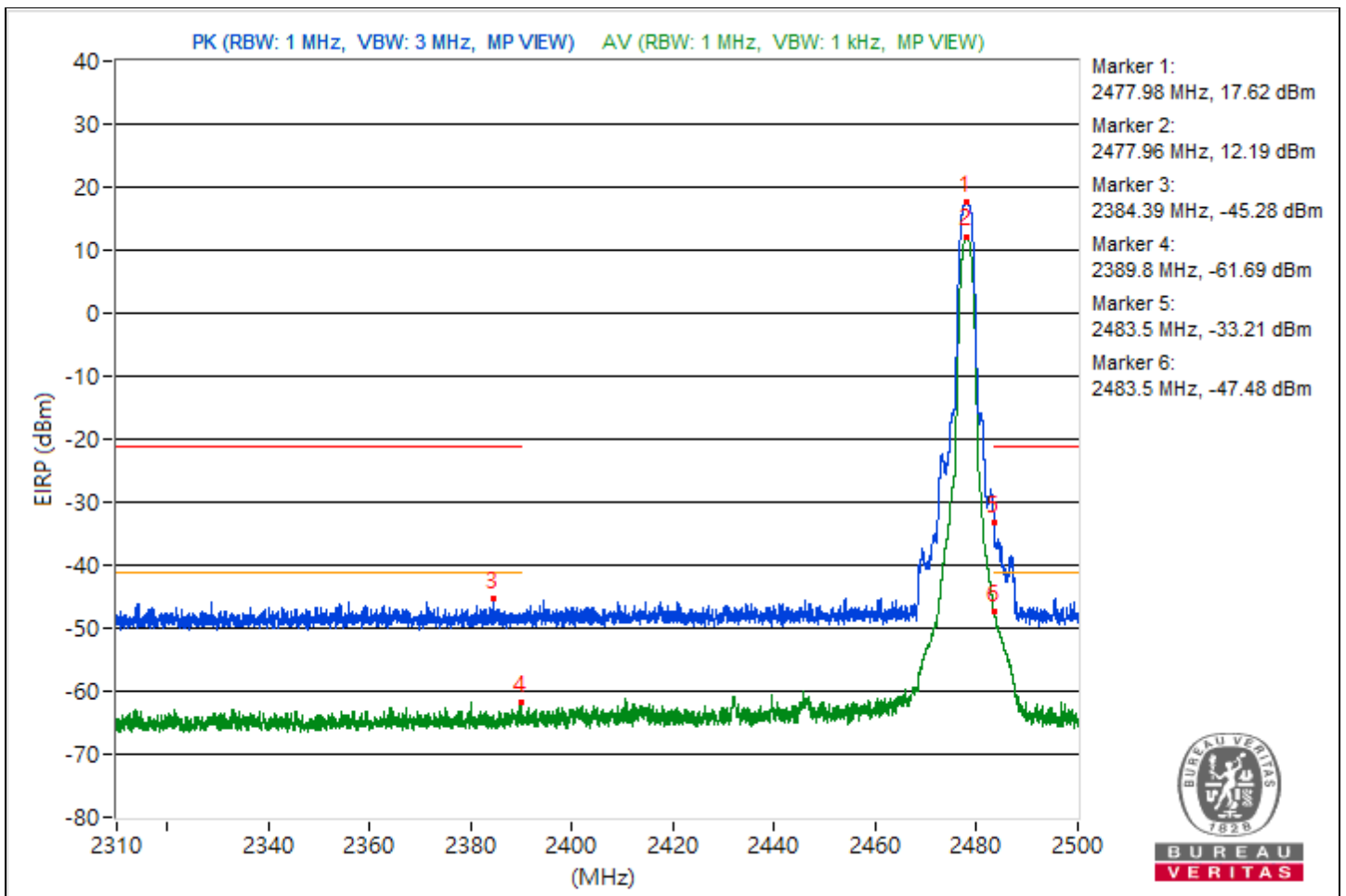

## 2Tx Beamforming

### Conducted Unwanted Emissions

RF Mode	QHS 6M	Channel	CH 1 : 2404 MHz
Frequency Range	1 GHz ~ 25 GHz	Input Power (System)	120 Vac, 60 Hz
Environmental Conditions	22°C, 55% RH	Tested By	Kevin Ko

Conducted Unwanted Emissions								
No.	Frequency (MHz)	Emission Level (dBUV/m)	Limit (dBUV/m)	Margin (dB)	Raw Value Chain 0 (dBm)	Raw Value Chain 1 (dBm)	Correction Factor (dB)	EIRP Level (dBm)
1	2324.48	55.29 PK	74	-18.71	-53.12	-49.76	8.17	-39.97
2	2315.07	38.34 AV	54	-15.66	-69.77	-66.89	8.17	-56.92
3	3991.1	59.73 PK	74	-14.27	-48.34	-45.53	8.17	-35.53
4	5050.2	44.33 AV	54	-9.67	-65.25	-60.31	8.17	-50.93
5	14473.16	59.96 PK	74	-14.04	-50.41	-44.45	8.17	-35.3
6	15381.69	44.56 AV	54	-9.44	-60.29	-64.42	8.17	-50.7
7	23884.5	64.31 PK	74	-9.69	-43.95	-40.85	8.17	-30.95
8	23913.4	48.45 AV	54	-5.55	-59.68	-56.71	8.17	-46.81

Note: Margin value = Emission Level - Limit value

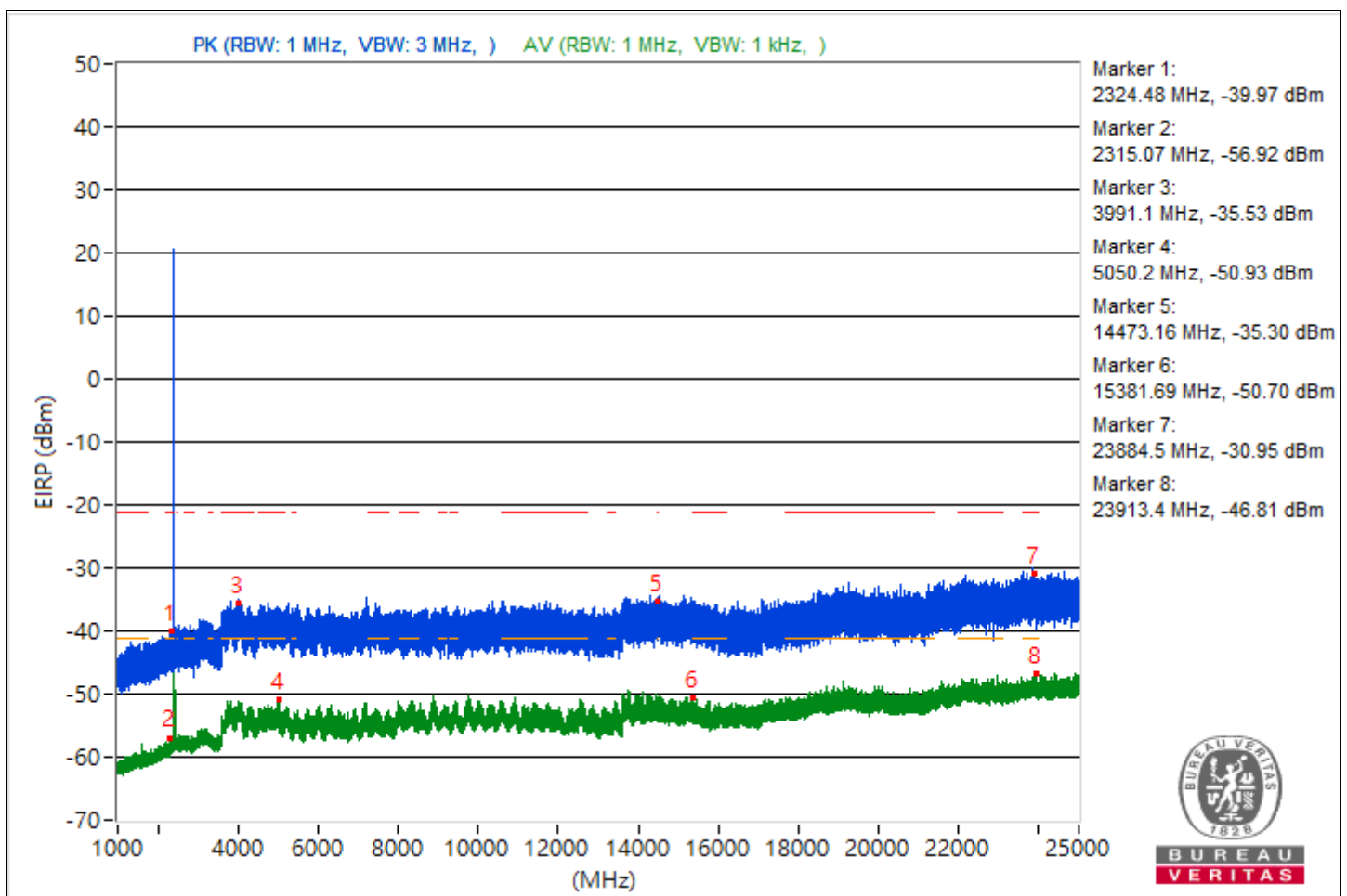

RF Mode	QHS 6M	Channel	CH 18 : 2438 MHz
Frequency Range	1 GHz ~ 25 GHz	Input Power (System)	120 Vac, 60 Hz
Environmental Conditions	22°C, 55% RH	Tested By	Kevin Ko

Conducted Unwanted Emissions								
No.	Frequency (MHz)	Emission Level (dBuV/m)	Limit (dBuV/m)	Margin (dB)	Raw Value Chain 0 (dBm)	Raw Value Chain 1 (dBm)	Correction Factor (dB)	EIRP Level (dBm)
1	2239.23	55.17 PK	74	-18.83	-50.52	-52.19	8.17	-40.09
2	2249.73	37.58 AV	54	-16.42	-67.93	-69.85	8.17	-57.68
3	4021.28	60.22 PK	74	-13.78	-48.45	-44.76	8.17	-35.04
4	4027.89	44.86 AV	54	-9.14	-60.93	-62.34	8.17	-50.4
5	14478.13	60.83 PK	74	-13.17	-44.21	-47.71	8.17	-34.43
6	14491.56	44.59 AV	54	-9.41	-60.47	-63.36	8.17	-50.67
7	23861.4	66.01 PK	74	-7.99	-38.37	-44.5	8.17	-29.25
8	23860.5	48.12 AV	54	-5.88	-60.46	-56.83	8.17	-47.14

Note: Margin value = Emission Level - Limit value

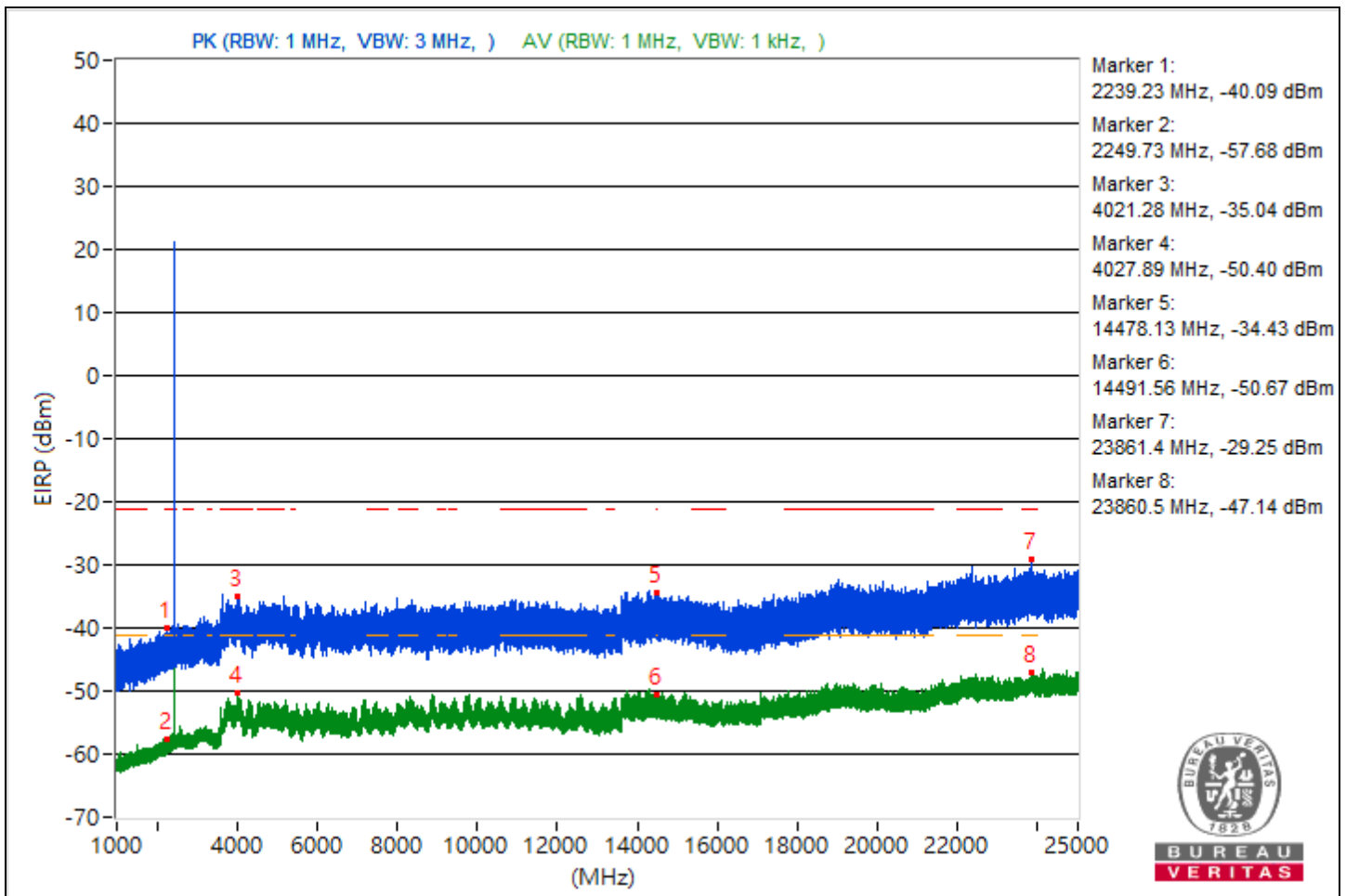

RF Mode	QHS 6M	Channel	CH 38 : 2478 MHz
Frequency Range	1 GHz ~ 25 GHz	Input Power (System)	120 Vac, 60 Hz
Environmental Conditions	22°C, 55% RH	Tested By	Kevin Ko

Conducted Unwanted Emissions								
No.	Frequency (MHz)	Emission Level (dBuV/m)	Limit (dBuV/m)	Margin (dB)	Raw Value Chain 0 (dBm)	Raw Value Chain 1 (dBm)	Correction Factor (dB)	EIRP Level (dBm)
1	2335.37	54.94 PK	74	-19.06	-54.18	-49.85	8.17	-40.32
2	2334.98	37.73 AV	54	-16.27	-69.13	-68.11	8.17	-57.53
3	4034.73	60.13 PK	74	-13.87	-44.71	-48.87	8.17	-35.13
4	4064.44	44.5 AV	54	-9.5	-64.17	-60.48	8.17	-50.76
5	10713.78	60.54 PK	74	-13.46	-47.68	-44.63	8.17	-34.72
6	12569.87	44.44 AV	54	-9.56	-63.6	-60.58	8.17	-50.82
7	23666.2	64.37 PK	74	-9.63	-45.2	-40.27	8.17	-30.89
<b>8</b>	<b>23857.7</b>	<b>48.92 AV</b>	<b>54</b>	<b>-5.08</b>	<b>-58.72</b>	<b>-56.58</b>	<b>8.17</b>	<b>-46.34</b>

Note: Margin value = Emission Level - Limit value

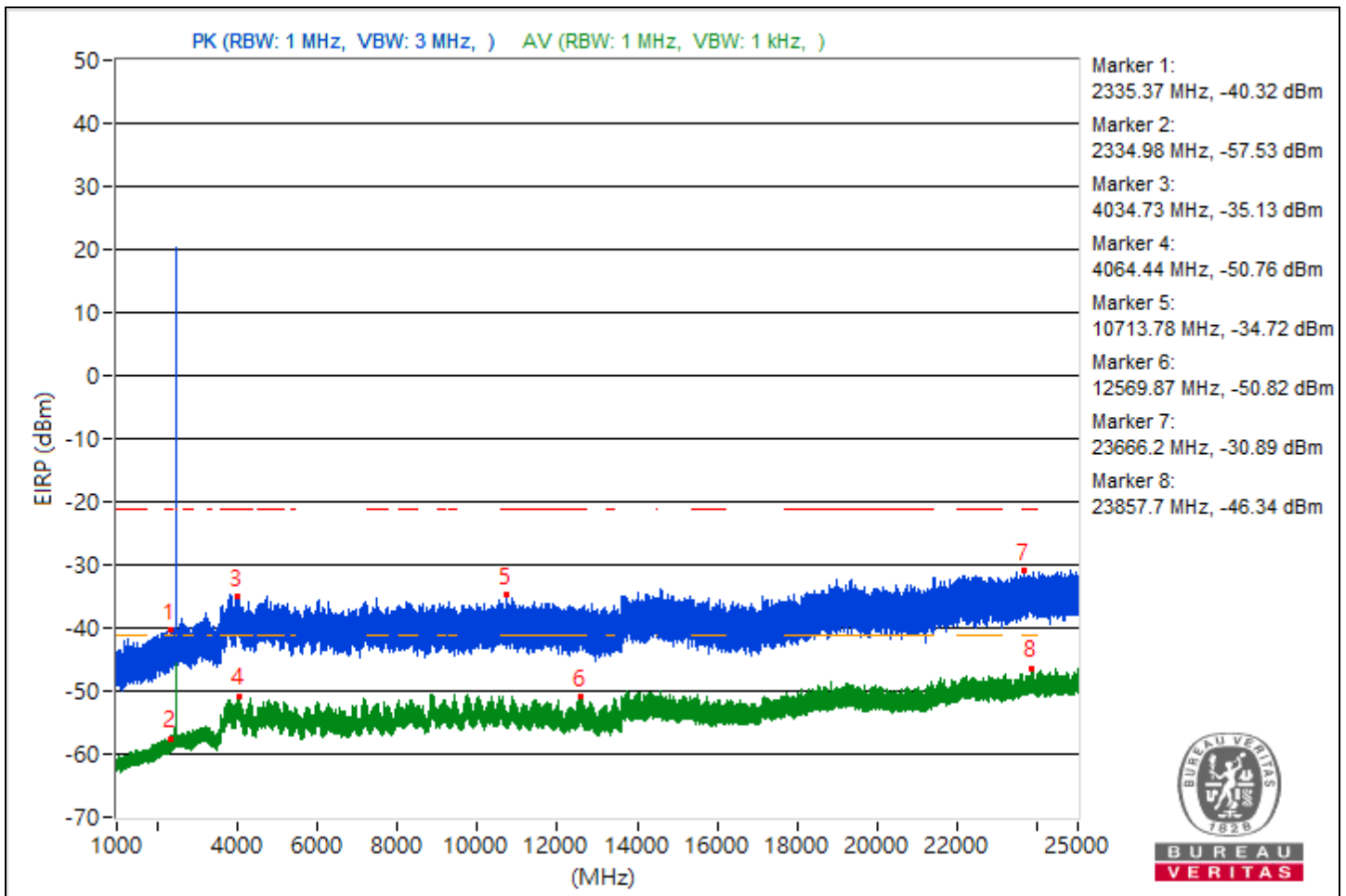





### Conducted Band Edges

RF Mode	QHS 6M	Channel	CH 1 : 2404 MHz
Frequency Range	2.31 GHz ~ 2.5 GHz	Input Power (System)	120 Vac, 60 Hz
Environmental Conditions	22°C, 55% RH	Tested By	Kevin Ko

Conducted Band Edge								
No.	Frequency (MHz)	Emission Level (dBuV/m)	Limit (dBuV/m)	Margin (dB)	Raw Value Chain 0 (dBm)	Raw Value Chain 1 (dBm)	Correction Factor (dB)	EIRP Level (dBm)
1	*2404.22	114.93 PK			9.77	10.45	6.54	19.67
2	*2403.88	109.56 AV			4.34	5.13	6.54	14.3
3	2350.14	54.28 PK	74	-19.72	-51.75	-49.51	6.54	-40.98
4	2389.23	38.26 AV	54	-15.74	-67.38	-65.85	6.54	-57
5	2490.1	55.23 PK	74	-18.77	-48.66	-50.68	6.54	-40.03
6	2484.04	38.43 AV	54	-15.57	-67.36	-65.41	6.54	-56.83

Notes:

1. Margin value = Emission Level - Limit value
2. " \* " : Fundamental frequency, the limit was restricted at the RF Output Power.

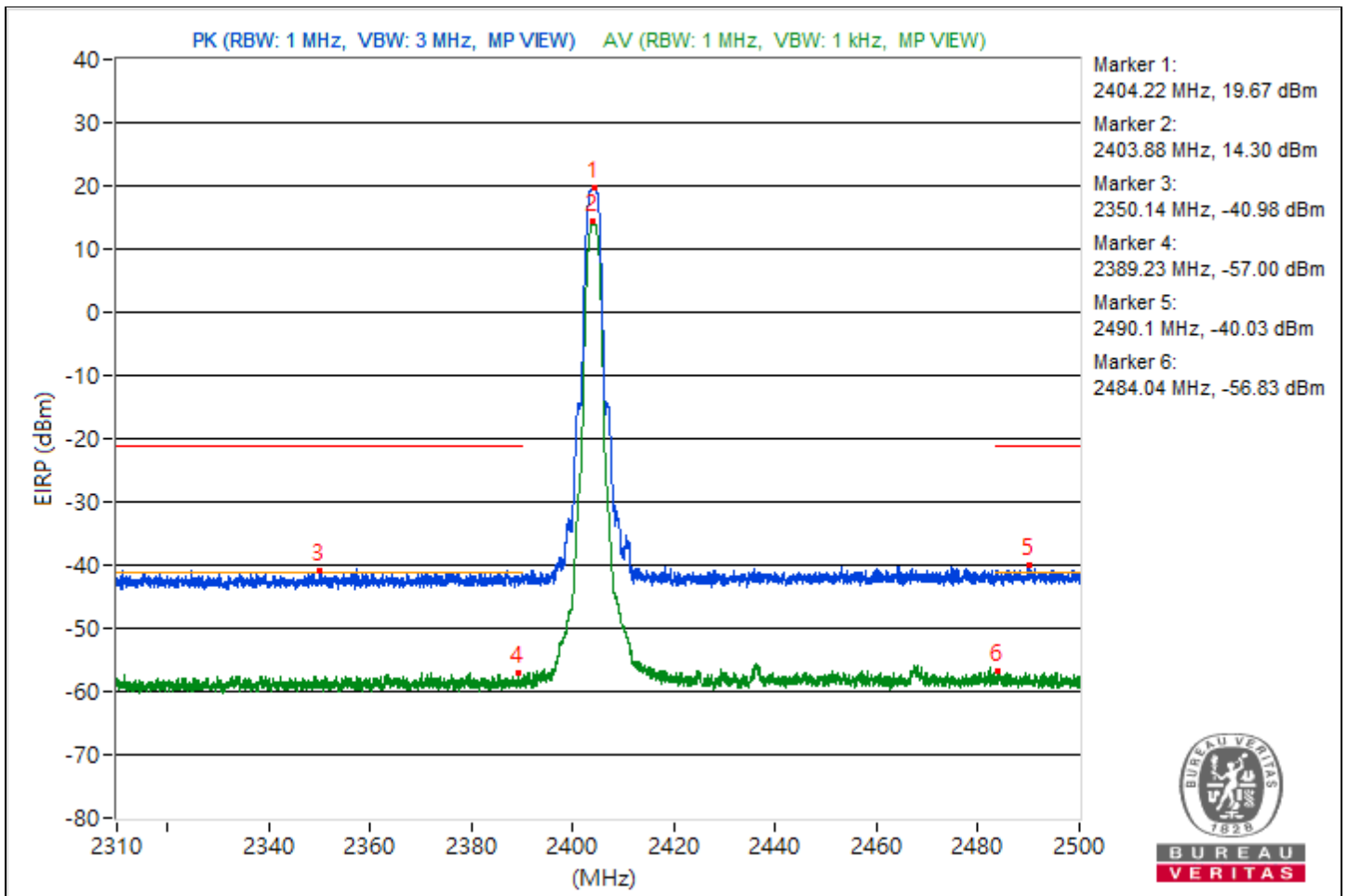

RF Mode	QHS 6M	Channel	CH 18 : 2438 MHz
Frequency Range	2.31 GHz ~ 2.5 GHz	Input Power (System)	120 Vac, 60 Hz
Environmental Conditions	22°C, 55% RH	Tested By	Kevin Ko

Conducted Band Edge								
No.	Frequency (MHz)	Emission Level (dBuV/m)	Limit (dBuV/m)	Margin (dB)	Raw Value Chain 0 (dBm)	Raw Value Chain 1 (dBm)	Correction Factor (dB)	EIRP Level (dBm)
1	*2437.97	114.83 PK			9.72	10.3	6.54	19.57
2	*2437.82	109.35 AV			4.32	4.99	6.54	14.09
3	2379.11	54.27 PK	74	-19.73	-49.78	-51.46	6.54	-40.99
4	2385.91	35.4 AV	54	-18.6	-68.68	-70.1	6.54	-59.86
5	2492.21	54.69 PK	74	-19.31	-50.62	-49.3	6.54	-40.57
6	2494.25	35.79 AV	54	-18.21	-68.26	-69.93	6.54	-59.47

Notes:

1. Margin value = Emission Level - Limit value
2. " \* " : Fundamental frequency, the limit was restricted at the RF Output Power.

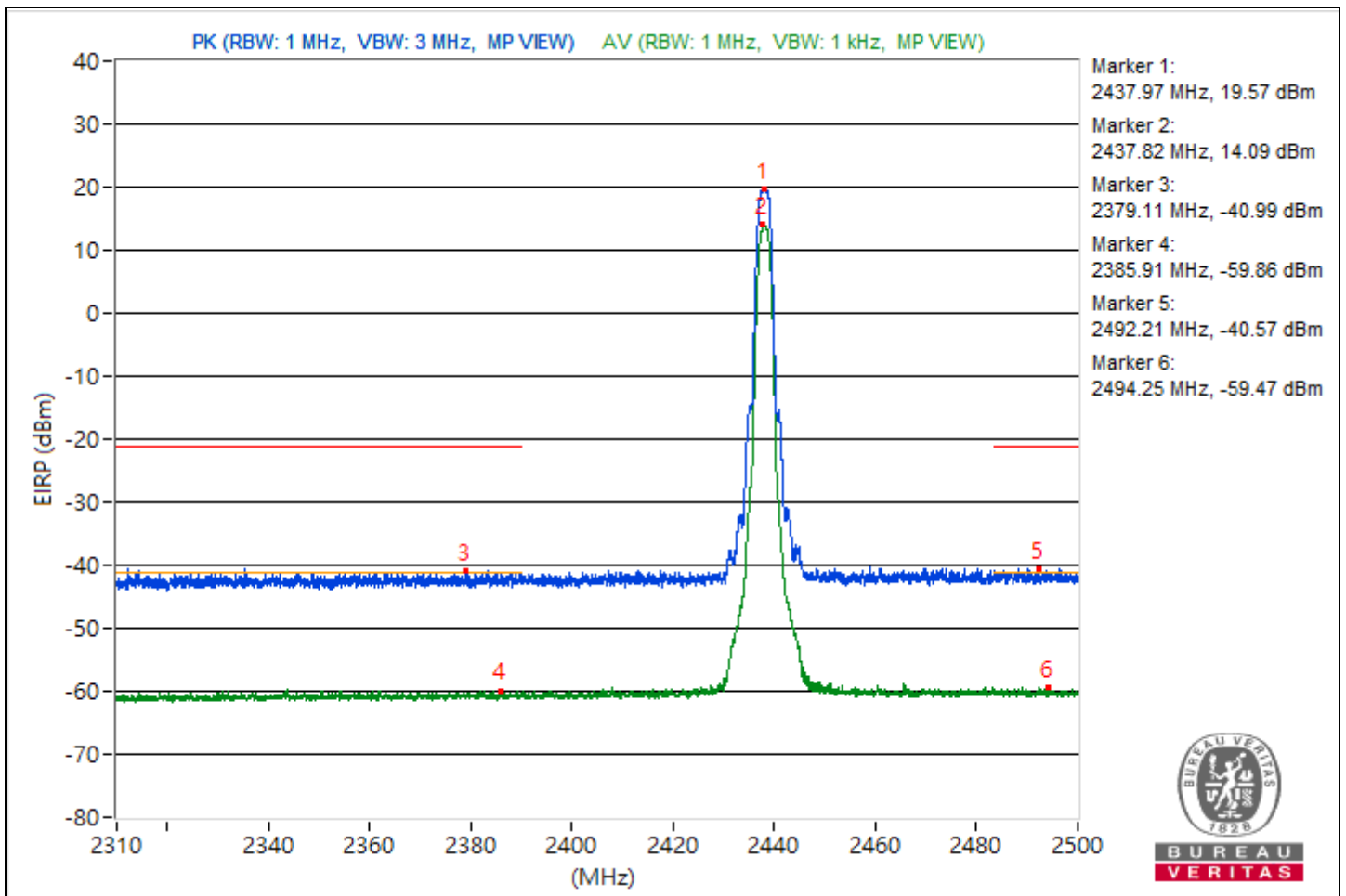

RF Mode	QHS 6M	Channel	CH 38 : 2478 MHz
Frequency Range	2.31 GHz ~ 2.5 GHz	Input Power (System)	120 Vac, 60 Hz
Environmental Conditions	22°C, 55% RH	Tested By	Kevin Ko

Conducted Band Edge								
No.	Frequency (MHz)	Emission Level (dBuV/m)	Limit (dBuV/m)	Margin (dB)	Raw Value Chain 0 (dBm)	Raw Value Chain 1 (dBm)	Correction Factor (dB)	EIRP Level (dBm)
1	*2477.98	114.31 PK			9.32	9.68	6.54	19.05
2	*2478.1	108.95 AV			3.86	4.4	6.54	13.69
3	2349.97	54.61 PK	74	-19.39	-51.65	-49.11	6.54	-40.65
4	2373.67	38.14 AV	54	-15.86	-67.56	-65.7	6.54	-57.12
5	2483.52	57.49 PK	74	-16.51	-46.19	-48.85	6.54	-37.77
6	2483.5	44.7 AV	54	-9.3	-60.65	-59.63	6.54	-50.56

Notes:

1. Margin value = Emission Level - Limit value
2. " \* " : Fundamental frequency, the limit was restricted at the RF Output Power.

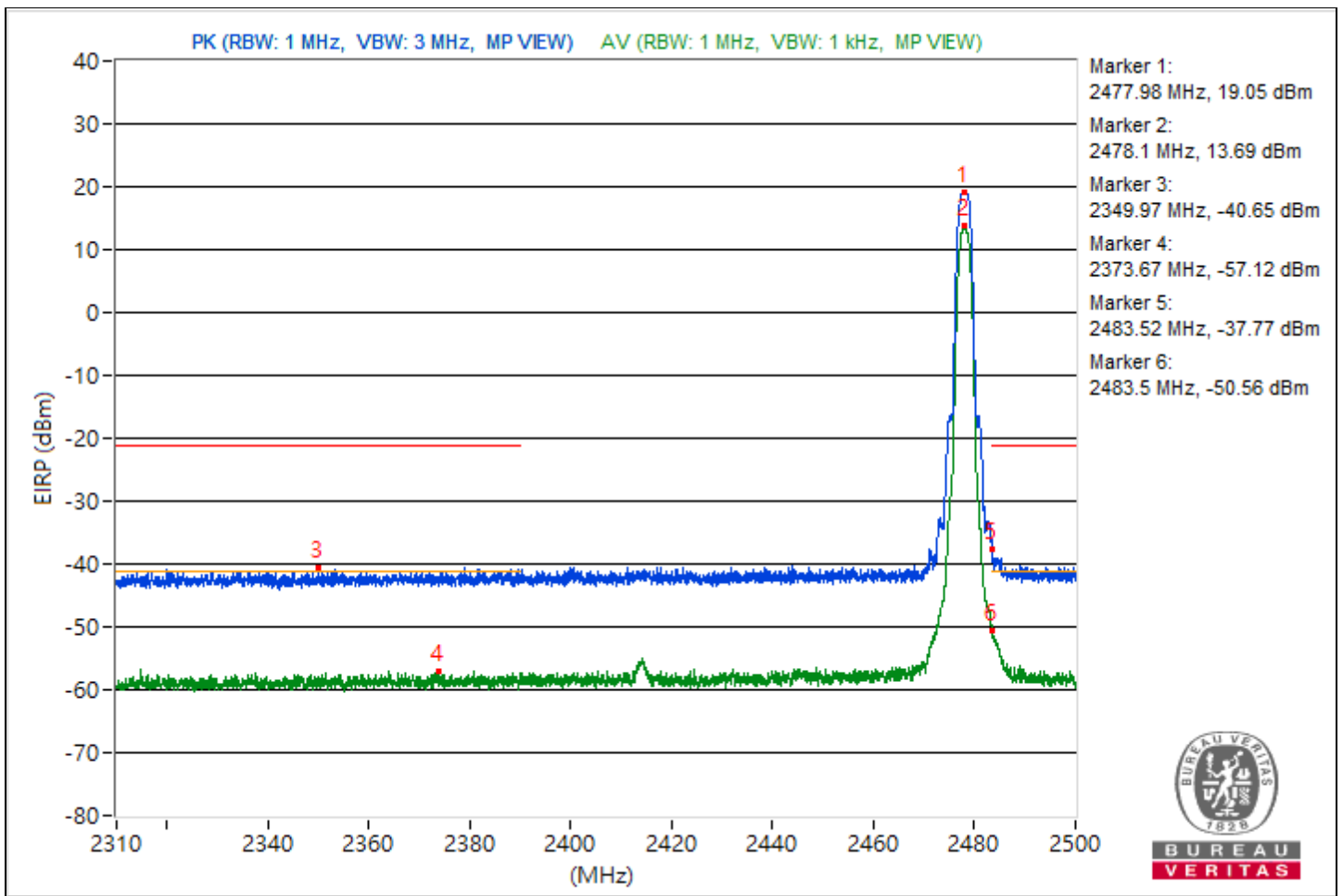

Mode B

1Tx

<b>RF Mode</b>	QHS 6M	<b>Channel</b>	CH 1 : 2404 MHz
<b>Frequency Range</b>	1 GHz ~ 25 GHz	<b>Detector Function &amp; Bandwidth</b>	PK: RB=1 MHz, VB=3 MHz, DET=Peak AV: RB=1 MHz, VB=1 kHz, DET=Peak
<b>Input Power (System)</b>	120 Vac, 60 Hz	<b>Environmental Conditions</b>	23°C, 71% RH
<b>Tested By</b>	Sampson Chen		

Antenna Polarity & Test Distance : Horizontal at 3 m								
No	Frequency (MHz)	Emission Level (dBuV/m)	Limit (dBuV/m)	Margin (dB)	Antenna Height (m)	Table Angle (Degree)	Raw Value (dBuV)	Correction Factor (dB/m)
1	4808.00	41.4 PK	74.0	-32.6	1.29 H	295	39.4	2.0
2	4808.00	30.5 AV	54.0	-23.5	1.29 H	295	28.5	2.0

Remarks:

1. Emission Level(dBuV/m) = Raw Value(dBuV) + Correction Factor(dB/m)
2. Correction Factor(dB/m) = Antenna Factor(dB/m) + Cable Factor(dB) – Pre-Amplifier Factor(dB)
3. Margin value = Emission Level – Limit value
4. The other emission levels were very low against the limit.

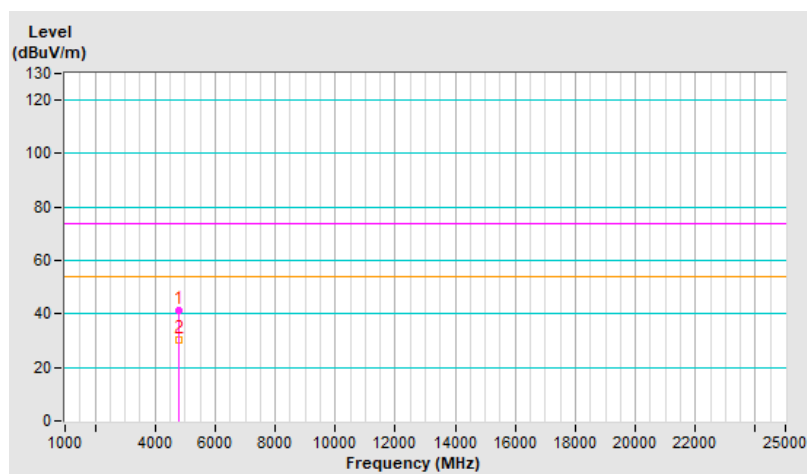

<b>RF Mode</b>	QHS 6M	<b>Channel</b>	CH 1 : 2404 MHz
<b>Frequency Range</b>	1 GHz ~ 25 GHz	<b>Detector Function &amp; Bandwidth</b>	PK: RB=1 MHz, VB=3 MHz, DET=Peak AV: RB=1 MHz, VB=1 kHz, DET=Peak
<b>Input Power (System)</b>	120 Vac, 60 Hz	<b>Environmental Conditions</b>	23°C, 71% RH
<b>Tested By</b>	Sampson Chen		

Antenna Polarity & Test Distance : Vertical at 3 m								
No	Frequency (MHz)	Emission Level (dBuV/m)	Limit (dBuV/m)	Margin (dB)	Antenna Height (m)	Table Angle (Degree)	Raw Value (dBuV)	Correction Factor (dB/m)
1	4808.00	40.7 PK	74.0	-33.3	1.63 V	133	38.7	2.0
2	4808.00	30.8 AV	54.0	-23.2	1.63 V	133	28.8	2.0

**Remarks:**

1. Emission Level(dBuV/m) = Raw Value(dBuV) + Correction Factor(dB/m)
2. Correction Factor(dB/m) = Antenna Factor(dB/m) + Cable Factor(dB) – Pre-Amplifier Factor(dB)
3. Margin value = Emission Level – Limit value
4. The other emission levels were very low against the limit.

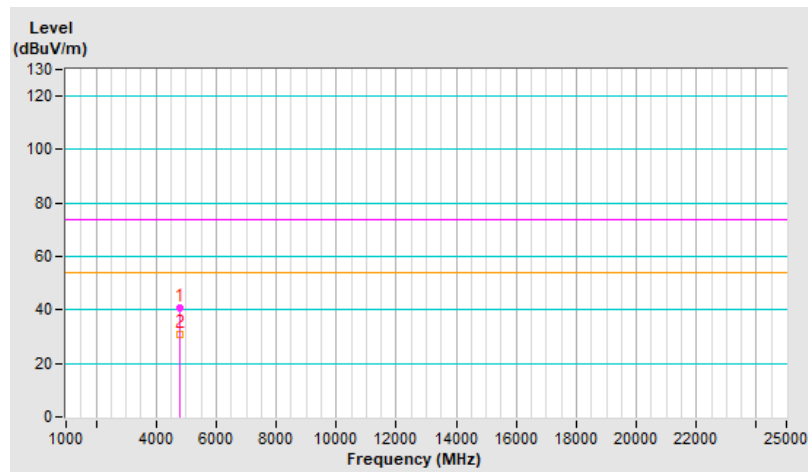



<b>RF Mode</b>	QHS 6M	<b>Channel</b>	CH 18 : 2438 MHz
<b>Frequency Range</b>	1 GHz ~ 25 GHz	<b>Detector Function &amp; Bandwidth</b>	PK: RB=1 MHz, VB=3 MHz, DET=Peak AV: RB=1 MHz, VB=1 kHz, DET=Peak
<b>Input Power (System)</b>	120 Vac, 60 Hz	<b>Environmental Conditions</b>	23°C, 71% RH
<b>Tested By</b>	Sampson Chen		

**Antenna Polarity & Test Distance : Horizontal at 3 m**

No	Frequency (MHz)	Emission Level (dBuV/m)	Limit (dBuV/m)	Margin (dB)	Antenna Height (m)	Table Angle (Degree)	Raw Value (dBuV)	Correction Factor (dB/m)
1	4876.00	41.4 PK	74.0	-32.6	1.31 H	305	39.3	2.1
2	4876.00	30.6 AV	54.0	-23.4	1.31 H	305	28.5	2.1
3	7314.00	47.1 PK	74.0	-26.9	1.85 H	182	39.4	7.7
4	7314.00	34.8 AV	54.0	-19.2	1.85 H	182	27.1	7.7

**Remarks:**

1. Emission Level(dBuV/m) = Raw Value(dBuV) + Correction Factor(dB/m)
2. Correction Factor(dB/m) = Antenna Factor(dB/m) + Cable Factor(dB) – Pre-Amplifier Factor(dB)
3. Margin value = Emission Level – Limit value
4. The other emission levels were very low against the limit.

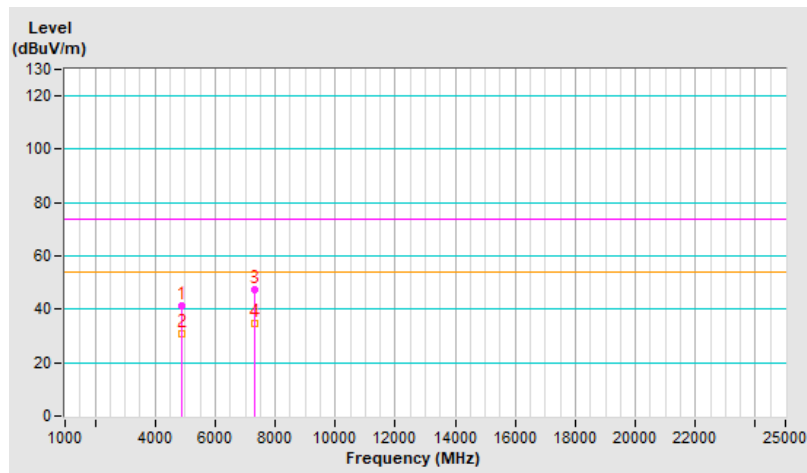

<b>RF Mode</b>	QHS 6M	<b>Channel</b>	CH 18 : 2438 MHz
<b>Frequency Range</b>	1 GHz ~ 25 GHz	<b>Detector Function &amp; Bandwidth</b>	PK: RB=1 MHz, VB=3 MHz, DET=Peak AV: RB=1 MHz, VB=1 kHz, DET=Peak
<b>Input Power (System)</b>	120 Vac, 60 Hz	<b>Environmental Conditions</b>	23°C, 71% RH
<b>Tested By</b>	Sampson Chen		

Antenna Polarity & Test Distance : Vertical at 3 m								
No	Frequency (MHz)	Emission Level (dBuV/m)	Limit (dBuV/m)	Margin (dB)	Antenna Height (m)	Table Angle (Degree)	Raw Value (dBuV)	Correction Factor (dB/m)
1	4876.00	41.1 PK	74.0	-32.9	1.60 V	131	39.0	2.1
2	4876.00	31.0 AV	54.0	-23.0	1.60 V	131	28.9	2.1
3	7314.00	46.0 PK	74.0	-28.0	1.84 V	259	38.3	7.7
4	7314.00	34.2 AV	54.0	-19.8	1.84 V	259	26.5	7.7

**Remarks:**

1. Emission Level(dBuV/m) = Raw Value(dBuV) + Correction Factor(dB/m)
2. Correction Factor(dB/m) = Antenna Factor(dB/m) + Cable Factor(dB) – Pre-Amplifier Factor(dB)
3. Margin value = Emission Level – Limit value
4. The other emission levels were very low against the limit.

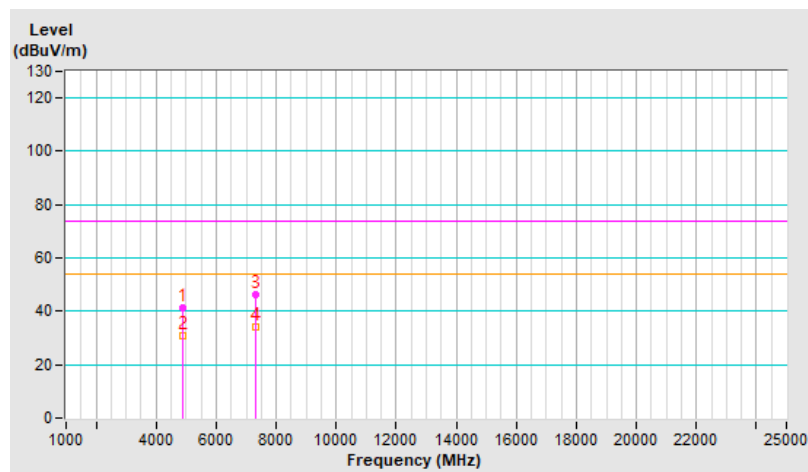

<b>RF Mode</b>	QHS 6M	<b>Channel</b>	CH 38 : 2478 MHz
<b>Frequency Range</b>	1 GHz ~ 25 GHz	<b>Detector Function &amp; Bandwidth</b>	PK: RB=1 MHz, VB=3 MHz, DET=Peak AV: RB=1 MHz, VB=1 kHz, DET=Peak
<b>Input Power (System)</b>	120 Vac, 60 Hz	<b>Environmental Conditions</b>	23°C, 71% RH
<b>Tested By</b>	Sampson Chen		

Antenna Polarity & Test Distance : Horizontal at 3 m								
No	Frequency (MHz)	Emission Level (dBuV/m)	Limit (dBuV/m)	Margin (dB)	Antenna Height (m)	Table Angle (Degree)	Raw Value (dBuV)	Correction Factor (dB/m)
1	4956.00	40.8 PK	74.0	-33.2	1.34 H	291	38.6	2.2
2	4956.00	30.1 AV	54.0	-23.9	1.34 H	291	27.9	2.2
3	7434.00	46.2 PK	74.0	-27.8	1.83 H	175	38.4	7.8
4	7434.00	33.9 AV	54.0	-20.1	1.83 H	175	26.1	7.8

**Remarks:**

1. Emission Level(dBuV/m) = Raw Value(dBuV) + Correction Factor(dB/m)
2. Correction Factor(dB/m) = Antenna Factor(dB/m) + Cable Factor(dB) – Pre-Amplifier Factor(dB)
3. Margin value = Emission Level – Limit value
4. The other emission levels were very low against the limit.

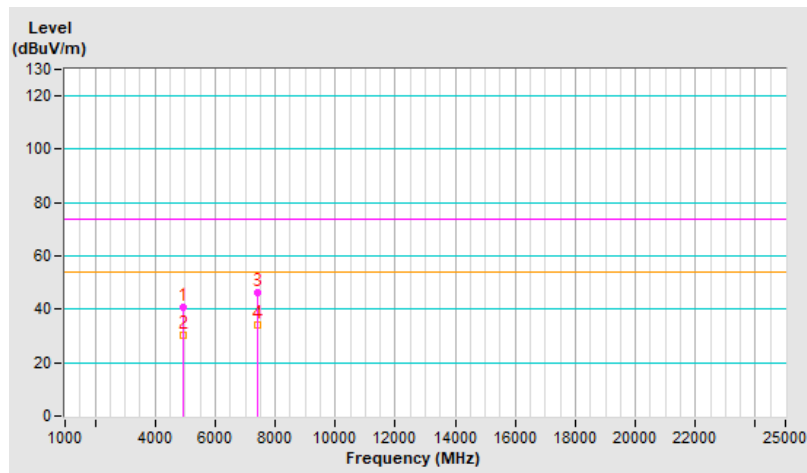



<b>RF Mode</b>	QHS 6M	<b>Channel</b>	CH 38 : 2478 MHz
<b>Frequency Range</b>	1 GHz ~ 25 GHz	<b>Detector Function &amp; Bandwidth</b>	PK: RB=1 MHz, VB=3 MHz, DET=Peak AV: RB=1 MHz, VB=1 kHz, DET=Peak
<b>Input Power (System)</b>	120 Vac, 60 Hz	<b>Environmental Conditions</b>	23°C, 71% RH
<b>Tested By</b>	Sampson Chen		

Antenna Polarity & Test Distance : Vertical at 3 m								
No	Frequency (MHz)	Emission Level (dBuV/m)	Limit (dBuV/m)	Margin (dB)	Antenna Height (m)	Table Angle (Degree)	Raw Value (dBuV)	Correction Factor (dB/m)
1	4956.00	41.1 PK	74.0	-32.9	1.60 V	134	38.9	2.2
2	4956.00	31.3 AV	54.0	-22.7	1.60 V	134	29.1	2.2
3	7434.00	46.2 PK	74.0	-27.8	1.89 V	249	38.4	7.8
4	7434.00	34.6 AV	54.0	-19.4	1.89 V	249	26.8	7.8

**Remarks:**

1. Emission Level(dBuV/m) = Raw Value(dBuV) + Correction Factor(dB/m)
2. Correction Factor(dB/m) = Antenna Factor(dB/m) + Cable Factor(dB) – Pre-Amplifier Factor(dB)
3. Margin value = Emission Level – Limit value
4. The other emission levels were very low against the limit.

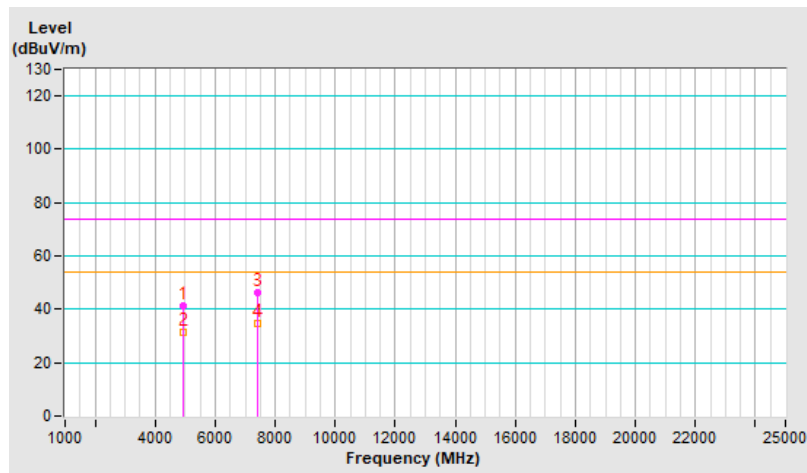

## 2Tx Beamforming

<b>RF Mode</b>	QHS 6M	<b>Channel</b>	CH 1 : 2404 MHz
<b>Frequency Range</b>	1 GHz ~ 25 GHz	<b>Detector Function &amp; Bandwidth</b>	PK: RB=1 MHz, VB=3 MHz, DET=Peak AV: RB=1 MHz, VB=1 kHz, DET=Peak
<b>Input Power (System)</b>	120 Vac, 60 Hz	<b>Environmental Conditions</b>	23°C, 71% RH
<b>Tested By</b>	Sampson Chen		

Antenna Polarity & Test Distance : Horizontal at 3 m								
No	Frequency (MHz)	Emission Level (dBuV/m)	Limit (dBuV/m)	Margin (dB)	Antenna Height (m)	Table Angle (Degree)	Raw Value (dBuV)	Correction Factor (dB/m)
1	4808.00	41.4 PK	74.0	-32.6	1.29 H	303	39.4	2.0
2	4808.00	31.9 AV	54.0	-22.1	1.29 H	303	29.9	2.0

### Remarks:

1. Emission Level(dBuV/m) = Raw Value(dBuV) + Correction Factor(dB/m)
2. Correction Factor(dB/m) = Antenna Factor(dB/m) + Cable Factor(dB) – Pre-Amplifier Factor(dB)
3. Margin value = Emission Level – Limit value
4. The other emission levels were very low against the limit.

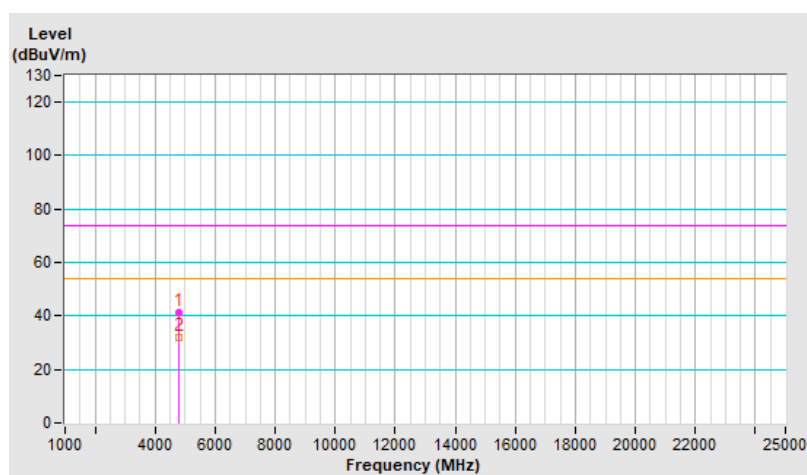



<b>RF Mode</b>	QHS 6M	<b>Channel</b>	CH 1 : 2404 MHz
<b>Frequency Range</b>	1 GHz ~ 25 GHz	<b>Detector Function &amp; Bandwidth</b>	PK: RB=1 MHz, VB=3 MHz, DET=Peak AV: RB=1 MHz, VB=1 kHz, DET=Peak
<b>Input Power (System)</b>	120 Vac, 60 Hz	<b>Environmental Conditions</b>	23°C, 71% RH
<b>Tested By</b>	Sampson Chen		

Antenna Polarity & Test Distance : Vertical at 3 m								
No	Frequency (MHz)	Emission Level (dBuV/m)	Limit (dBuV/m)	Margin (dB)	Antenna Height (m)	Table Angle (Degree)	Raw Value (dBuV)	Correction Factor (dB/m)
1	4808.00	42.4 PK	74.0	-31.6	1.70 V	124	40.4	2.0
2	4808.00	32.1 AV	54.0	-21.9	1.70 V	124	30.1	2.0

**Remarks:**

1. Emission Level(dBuV/m) = Raw Value(dBuV) + Correction Factor(dB/m)
2. Correction Factor(dB/m) = Antenna Factor(dB/m) + Cable Factor(dB) – Pre-Amplifier Factor(dB)
3. Margin value = Emission Level – Limit value
4. The other emission levels were very low against the limit.

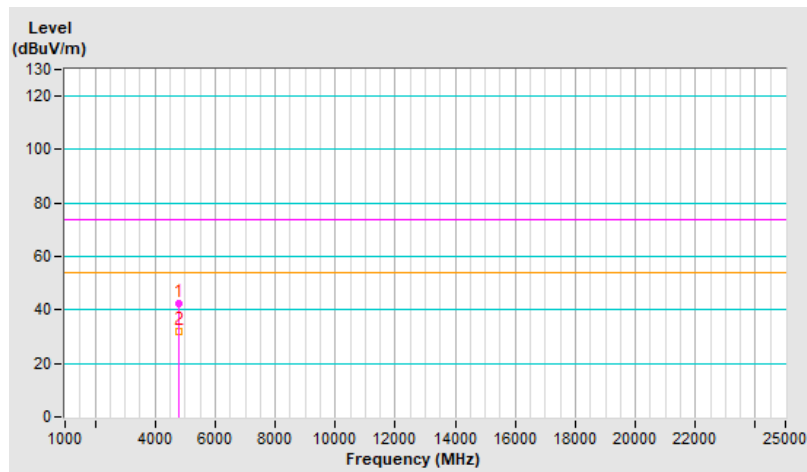



<b>RF Mode</b>	QHS 6M	<b>Channel</b>	CH 18 : 2438 MHz
<b>Frequency Range</b>	1 GHz ~ 25 GHz	<b>Detector Function &amp; Bandwidth</b>	PK: RB=1 MHz, VB=3 MHz, DET=Peak AV: RB=1 MHz, VB=1 kHz, DET=Peak
<b>Input Power (System)</b>	120 Vac, 60 Hz	<b>Environmental Conditions</b>	23°C, 71% RH
<b>Tested By</b>	Sampson Chen		

Antenna Polarity & Test Distance : Horizontal at 3 m								
No	Frequency (MHz)	Emission Level (dBuV/m)	Limit (dBuV/m)	Margin (dB)	Antenna Height (m)	Table Angle (Degree)	Raw Value (dBuV)	Correction Factor (dB/m)
1	4876.00	41.5 PK	74.0	-32.5	1.39 H	296	39.4	2.1
2	4876.00	32.0 AV	54.0	-22.0	1.39 H	296	29.9	2.1
3	7314.00	46.0 PK	74.0	-28.0	1.79 H	149	38.3	7.7
4	7314.00	35.4 AV	54.0	-18.6	1.79 H	149	27.7	7.7

**Remarks:**

1. Emission Level(dBuV/m) = Raw Value(dBuV) + Correction Factor(dB/m)
2. Correction Factor(dB/m) = Antenna Factor(dB/m) + Cable Factor(dB) – Pre-Amplifier Factor(dB)
3. Margin value = Emission Level – Limit value
4. The other emission levels were very low against the limit.

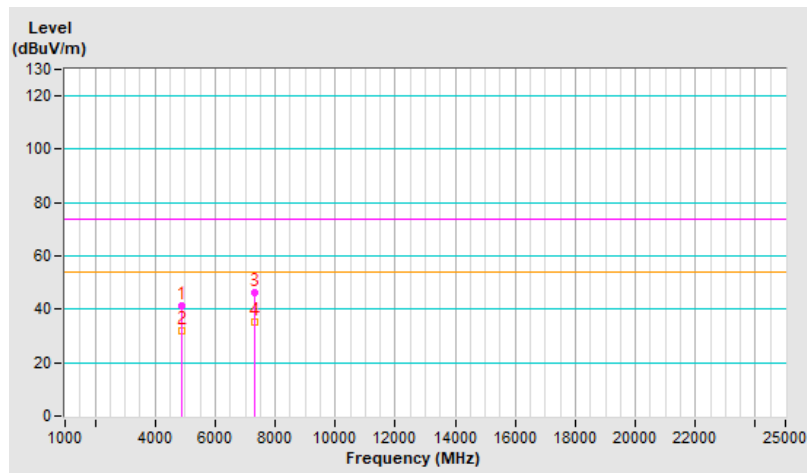



<b>RF Mode</b>	QHS 6M	<b>Channel</b>	CH 18 : 2438 MHz
<b>Frequency Range</b>	1 GHz ~ 25 GHz	<b>Detector Function &amp; Bandwidth</b>	PK: RB=1 MHz, VB=3 MHz, DET=Peak AV: RB=1 MHz, VB=1 kHz, DET=Peak
<b>Input Power (System)</b>	120 Vac, 60 Hz	<b>Environmental Conditions</b>	23°C, 71% RH
<b>Tested By</b>	Sampson Chen		

Antenna Polarity & Test Distance : Vertical at 3 m								
No	Frequency (MHz)	Emission Level (dBuV/m)	Limit (dBuV/m)	Margin (dB)	Antenna Height (m)	Table Angle (Degree)	Raw Value (dBuV)	Correction Factor (dB/m)
1	4876.00	41.9 PK	74.0	-32.1	1.72 V	152	39.8	2.1
2	4876.00	31.7 AV	54.0	-22.3	1.72 V	152	29.6	2.1
3	7314.00	46.4 PK	74.0	-27.6	1.96 V	270	38.7	7.7
4	7314.00	35.6 AV	54.0	-18.4	1.96 V	270	27.9	7.7

**Remarks:**

1. Emission Level(dBuV/m) = Raw Value(dBuV) + Correction Factor(dB/m)
2. Correction Factor(dB/m) = Antenna Factor(dB/m) + Cable Factor(dB) – Pre-Amplifier Factor(dB)
3. Margin value = Emission Level – Limit value
4. The other emission levels were very low against the limit.

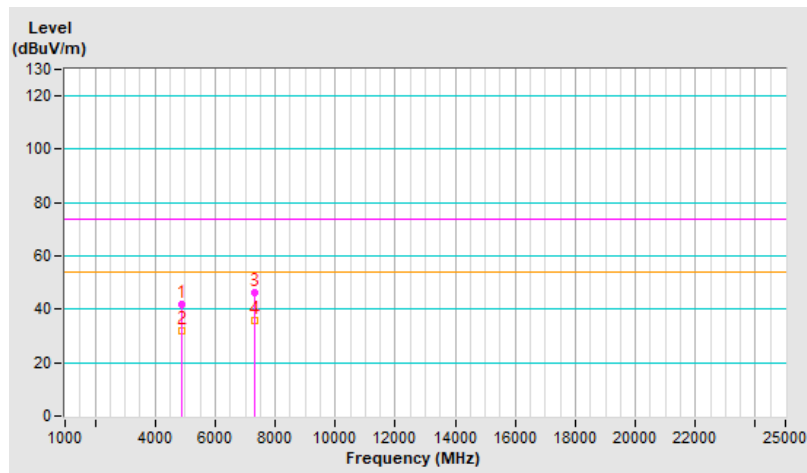

<b>RF Mode</b>	QHS 6M	<b>Channel</b>	CH 38 : 2478 MHz
<b>Frequency Range</b>	1 GHz ~ 25 GHz	<b>Detector Function &amp; Bandwidth</b>	PK: RB=1 MHz, VB=3 MHz, DET=Peak AV: RB=1 MHz, VB=1 kHz, DET=Peak
<b>Input Power (System)</b>	120 Vac, 60 Hz	<b>Environmental Conditions</b>	23°C, 71% RH
<b>Tested By</b>	Sampson Chen		

**Antenna Polarity & Test Distance : Horizontal at 3 m**

No	Frequency (MHz)	Emission Level (dBuV/m)	Limit (dBuV/m)	Margin (dB)	Antenna Height (m)	Table Angle (Degree)	Raw Value (dBuV)	Correction Factor (dB/m)
1	4956.00	40.8 PK	74.0	-33.2	1.31 H	286	38.6	2.2
2	4956.00	31.4 AV	54.0	-22.6	1.31 H	286	29.2	2.2
3	7434.00	46.3 PK	74.0	-27.7	1.74 H	143	38.5	7.8
4	7434.00	35.9 AV	54.0	-18.1	1.74 H	143	28.1	7.8

**Remarks:**

1. Emission Level(dBuV/m) = Raw Value(dBuV) + Correction Factor(dB/m)
2. Correction Factor(dB/m) = Antenna Factor(dB/m) + Cable Factor(dB) – Pre-Amplifier Factor(dB)
3. Margin value = Emission Level – Limit value
4. The other emission levels were very low against the limit.

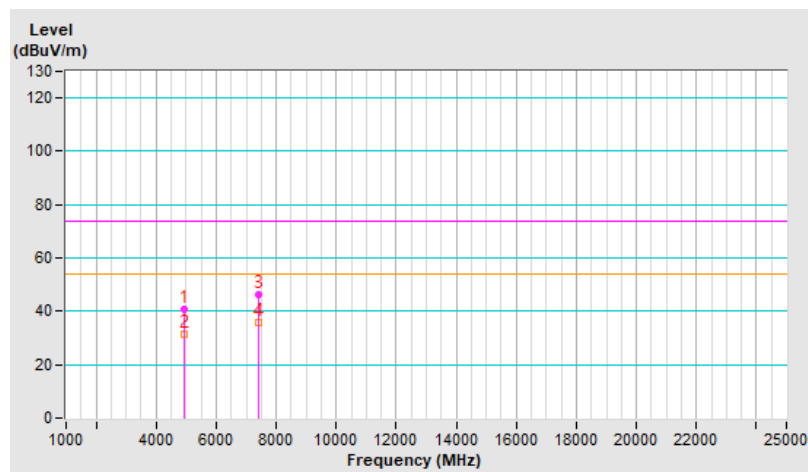

<b>RF Mode</b>	QHS 6M	<b>Channel</b>	CH 38 : 2478 MHz
<b>Frequency Range</b>	1 GHz ~ 25 GHz	<b>Detector Function &amp; Bandwidth</b>	PK: RB=1 MHz, VB=3 MHz, DET=Peak AV: RB=1 MHz, VB=1 kHz, DET=Peak
<b>Input Power (System)</b>	120 Vac, 60 Hz	<b>Environmental Conditions</b>	23°C, 71% RH
<b>Tested By</b>	Sampson Chen		

Antenna Polarity & Test Distance : Vertical at 3 m								
No	Frequency (MHz)	Emission Level (dBuV/m)	Limit (dBuV/m)	Margin (dB)	Antenna Height (m)	Table Angle (Degree)	Raw Value (dBuV)	Correction Factor (dB/m)
1	4956.00	42.1 PK	74.0	-31.9	1.71 V	147	39.9	2.2
2	4956.00	31.9 AV	54.0	-22.1	1.71 V	147	29.7	2.2
3	7434.00	46.3 PK	74.0	-27.7	1.88 V	243	38.5	7.8
4	7434.00	35.2 AV	54.0	-18.8	1.88 V	243	27.4	7.8

**Remarks:**

1. Emission Level(dBuV/m) = Raw Value(dBuV) + Correction Factor(dB/m)
2. Correction Factor(dB/m) = Antenna Factor(dB/m) + Cable Factor(dB) – Pre-Amplifier Factor(dB)
3. Margin value = Emission Level – Limit value
4. The other emission levels were very low against the limit.

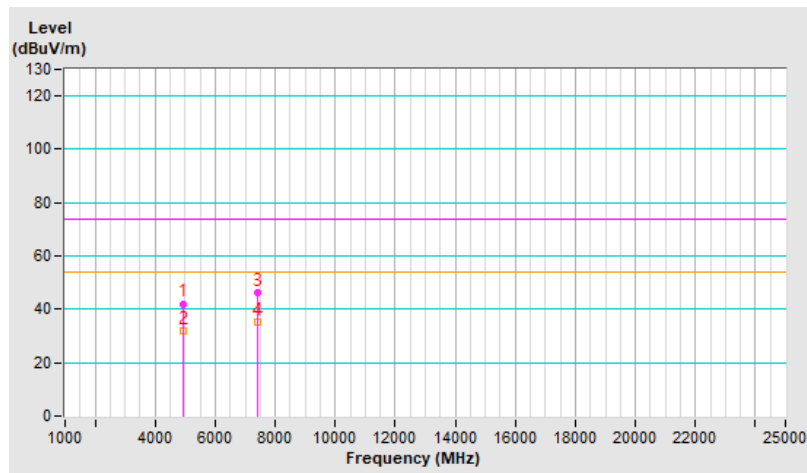

## 8 Pictures of Test Arrangements

Please refer to the attached file (Test Setup Photo)





## 9 Information of the Testing Laboratories

We, Bureau Veritas Consumer Products Services (H.K.) Ltd., Taoyuan Branch, were founded in 1988 to provide our best service in EMC, Radio, Telecom and Safety consultation. Our laboratories are FCC recognized accredited test firms and accredited according to ISO/IEC 17025.

If you have any comments, please feel free to contact us at the following:

**Lin Kou EMC/RF Lab**

Tel: 886-2-26052180

Fax: 886-2-26051924

**Hsin Chu EMC/RF/Telecom Lab**

Tel: 886-3-6668565

Fax: 886-3-6668323

**Hwa Ya EMC/RF/Safety Lab**

Tel: 886-3-3183232

Fax: 886-3-3270892

**Email:** [service.adt@bureauveritas.com](mailto:service.adt@bureauveritas.com)

**Web Site:** <http://ee.bureauveritas.com.tw>

The address and road map of all our labs can be found in our web site also.

--- END ---