



**FCC CFR47 PART 15 SUBPART C
INDUSTRY CANADA RSS-210 ISSUE 7**

CERTIFICATION TEST REPORT

FOR

**EA544D_3 ETHERNET ADAPTER CARD FOR 2.4 / 5 GHz AP APPLICATIONS_NON
DFS**

MODEL NUMBER: 65-VN663-P3

**FCC ID: J9C-EA544D3
IC: 2723A-EA544D3**

REPORT NUMBER: 09U12689-6

ISSUE DATE: JULY 31, 2009

Prepared for
**QUALCOMM INC.
3165 KIFER ROAD
SANTA CLARA, CA 95051
USA**

Prepared by
**COMPLIANCE CERTIFICATION SERVICES
47173 BENICIA STREET
FREMONT, CA 94538, U.S.A.
TEL: (510) 771-1000
FAX: (510) 661-0888**



NVLAP LAB CODE 200065-0

Revision History

<u>Rev.</u>	<u>Issue Date</u>	<u>Revisions</u>	<u>Revised By</u>
--	7/31/2009	Initial Issue	F. Ibrahim

TABLE OF CONTENTS

1. ATTESTATION OF TEST RESULTS	5
2. TEST METHODOLOGY	6
3. FACILITIES AND ACCREDITATION	6
4. CALIBRATION AND UNCERTAINTY	6
4.1. MEASURING INSTRUMENT CALIBRATION	6
4.2. SAMPLE CALCULATION	6
4.3. MEASUREMENT UNCERTAINTY	6
5. EQUIPMENT UNDER TEST	7
5.1. DESCRIPTION OF EUT	7
5.2. MAXIMUM OUTPUT POWER	7
5.3. DESCRIPTION OF AVAILABLE ANTENNAS	7
5.4. SOFTWARE AND FIRMWARE	8
5.5. WORST-CASE CONFIGURATION AND MODE	8
5.6. DESCRIPTION OF TEST SETUP	9
6. TEST AND MEASUREMENT EQUIPMENT	11
7. ANTENNA PORT TEST RESULTS	12
7.1. 2.4 GHz BAND CHANNEL TESTS FOR 802.11b MODE	12
7.1.1. 6 dB BANDWIDTH	12
7.1.2. 99% & 26 dB BANDWIDTH	15
7.1.3. OUTPUT POWER	18
7.1.4. AVERAGE POWER	25
7.1.5. POWER SPECTRAL DENSITY	26
7.1.6. CONDUCTED SPURIOUS EMISSIONS	29
7.2. 2.4 GHz BAND CHANNEL TESTS FOR 802.11g MODE	33
7.2.1. 6 dB BANDWIDTH	33
7.2.2. 99% & 26 dB BANDWIDTH	36
7.2.3. OUTPUT POWER	39
7.2.4. AVERAGE POWER	46
7.2.5. POWER SPECTRAL DENSITY	47
7.2.6. CONDUCTED SPURIOUS EMISSIONS	50
7.3. 2.4 GHz BAND CHANNEL TESTS FOR 802.11n HT20 MODE	54
7.3.1. 6 dB BANDWIDTH	54
7.3.2. 99% & 26 dB BANDWIDTH	57
7.3.3. OUTPUT POWER	60
7.3.4. AVERAGE POWER	67
7.3.5. POWER SPECTRAL DENSITY	68
7.3.6. CONDUCTED SPURIOUS EMISSIONS	71
7.4. 2.4 GHz BAND CHANNEL TESTS FOR 802.11n HT40 MODE	75

- 7.4.1. 6 dB BANDWIDTH 75
- 7.4.2. 99% & 26 dB BANDWIDTH..... 78
- 7.4.3. OUTPUT POWER 81
- 7.4.4. AVERAGE POWER 88
- 7.4.5. POWER SPECTRAL DENSITY 89
- 7.4.6. CONDUCTED SPURIOUS EMISSIONS..... 92
- 7.5. 5.8 GHz BAND CHANNEL TESTS FOR 802.11a MODE 96
 - 7.5.1. 6 dB BANDWIDTH 96
 - 7.5.2. 99% & 26 dB BANDWIDTH..... 99
 - 7.5.3. OUTPUT POWER 102
 - 7.5.4. AVERAGE POWER 109
 - 7.5.5. POWER SPECTRAL DENSITY 110
 - 7.5.6. CONDUCTED SPURIOUS EMISSIONS..... 113
- 7.6. 5.8 GHz BAND CHANNEL TESTS FOR 802.11n HT20 MODE 117
 - 7.6.1. 6 dB BANDWIDTH 117
 - 7.6.2. 99% & 26 dB BANDWIDTH..... 120
 - 7.6.3. OUTPUT POWER 123
 - 7.6.4. AVERAGE POWER 130
 - 7.6.5. POWER SPECTRAL DENSITY 131
 - 7.6.6. CONDUCTED SPURIOUS EMISSIONS..... 134
- 7.7. 5.8 GHz BAND CHANNEL TESTS FOR 802.11n HT40 MODE 138
 - 7.7.1. 6 dB BANDWIDTH 138
 - 7.7.2. 99% & 26 dB BANDWIDTH..... 140
 - 7.7.3. OUTPUT POWER 142
 - 7.7.4. AVERAGE POWER 147
 - 7.7.5. POWER SPECTRAL DENSITY 148
 - 7.7.6. CONDUCTED SPURIOUS EMISSIONS..... 150
- 7.8. RECEIVER CONDUCTED SPURIOUS EMISSIONS 153
- 8. RADIATED TEST RESULTS 156**
 - 8.1. LIMITS AND PROCEDURE 156
 - 8.2. TRANSMITTER ABOVE 1 GHz 157
 - 8.2.1. 802.11b MODE IN THE 2.4 GHz BAND..... 157
 - 8.2.2. 802.11g MODE IN THE 2.4 GHz BAND..... 162
 - 8.2.3. 802.11n HT20 MODE IN THE 2.4 GHz BAND 167
 - 8.2.4. 802.11n HT40 MODE IN THE 2.4 GHz BAND 172
 - 8.2.5. 802.11a MODE IN THE 5.8 GHz BAND..... 177
 - 8.2.6. 802.11n HT20 MODE IN THE 5.8 GHz BAND 178
 - 8.2.7. 802.11n HT40 MODE IN THE 5.8 GHz BAND 179
 - 8.3. WORST-CASE BELOW 1 GHz..... 180
- 9. AC POWER LINE CONDUCTED EMISSIONS 182**
- 10. MAXIMUM PERMISSIBLE EXPOSURE 189**
- 11. SETUP PHOTOS 192**

1. ATTESTATION OF TEST RESULTS

COMPANY NAME: QUALCOMM, INC.
3165 KIFER RD
SANTA CLARA, CA 95051
U.S.A.

EUT DESCRIPTION: EA544D_3 ETHERNET ADAPTER CARD FOR 2.4 / 5 GHz AP APPLICATIONS_NON DFS

MODEL: 65-VN663-P3

SERIAL NUMBER: 7813 FOR ANTENNA PORT, 7908 FOR RADIATED EMISSIONS

DATE TESTED: JUNE 24 – JULY 18, 2009

APPLICABLE STANDARDS	
STANDARD	TEST RESULTS
CFR 47 Part 15 Subpart C	Pass
INDUSTRY CANADA RSS-210 Issue 7 Annex 8	Pass
INDUSTRY CANADA RSS-GEN Issue 2	Pass

Compliance Certification Services, Inc. (CCS) tested the above equipment in accordance with the requirements set forth in the above standards. All indications of Pass/Fail in this report are opinions expressed by CCS based on interpretations and/or observations of test results. Measurement Uncertainties were not taken into account and are published for informational purposes only. The test results show that the equipment tested is capable of demonstrating compliance with the requirements as documented in this report.

Note: The results documented in this report apply only to the tested sample, under the conditions and modes of operation as described herein. This document may not be altered or revised in any way unless done so by CCS and all revisions are duly noted in the revisions section. Any alteration of this document not carried out by CCS will constitute fraud and shall nullify the document. This report must not be used by the client to claim product certification, approval, or endorsement by NVLAP, NIST, any agency of the Federal Government, or any agency of any government.

Approved & Released For CCS By:

Tested By:



FRANK IBRAHIM
EMC SUPERVISOR
COMPLIANCE CERTIFICATION SERVICES

VIEN TRAN
EMC ENGINEER
COMPLIANCE CERTIFICATION SERVICES

2. TEST METHODOLOGY

The tests documented in this report were performed in accordance with ANSI C63.4-2003, FCC CFR 47 Part 2, FCC CFR 47 Part 15, RSS-GEN Issue 2, and RSS-210 Issue 7.

3. FACILITIES AND ACCREDITATION

The test sites and measurement facilities used to collect data are located at 47173 Benicia Street, Fremont, California, USA.

CCS is accredited by NVLAP, Laboratory Code 200065-0. The full scope of accreditation can be viewed at <http://www.ccsemc.com>.

4. CALIBRATION AND UNCERTAINTY

4.1. MEASURING INSTRUMENT CALIBRATION

The measuring equipment utilized to perform the tests documented in this report has been calibrated in accordance with the manufacturer's recommendations, and is traceable to recognized national standards.

4.2. SAMPLE CALCULATION

Where relevant, the following sample calculation is provided:

$$\begin{aligned} \text{Field Strength (dBuV/m)} &= \text{Measured Voltage (dBuV)} + \text{Antenna Factor (dB/m)} + \\ &\text{Cable Loss (dB)} - \text{Preamp Gain (dB)} \\ 36.5 \text{ dBuV} + 18.7 \text{ dB/m} + 0.6 \text{ dB} - 26.9 \text{ dB} &= 28.9 \text{ dBuV/m} \end{aligned}$$

4.3. MEASUREMENT UNCERTAINTY

Where relevant, the following measurement uncertainty levels have been estimated for tests performed on the apparatus:

PARAMETER	UNCERTAINTY
Conducted Disturbance, 0.15 to 30 MHz	3.52 dB
Radiated Disturbance, 30 to 1000 MHz	4.94 dB

Uncertainty figures are valid to a confidence level of 95%.

5. EQUIPMENT UNDER TEST

5.1. DESCRIPTION OF EUT

The EUT is an 802.11a/b/g/n WLAN transceiver module for 2.4 / 5 GHz AP Applications that do not include DFS bands. It is equipped with four identical transmitter / receiver chains and an Ethernet port.

The radio module is manufactured by Qualcomm, Inc.

5.2. MAXIMUM OUTPUT POWER

The transmitter has a maximum peak conducted output power as follows:

Frequency Range (MHz)	Mode	Output Power (dBm)	Output Power (mW)
2.4 GHz BAND			
2412 - 2462	802.11b	26.62	459.20
2412 - 2462	802.11g	24.96	313.33
2412 - 2462	802.11n HT20	24.99	315.50
2422 - 2452	802.11n HT40	26.09	406.44
5.8 GHz BAND			
5745 - 5825	802.11a	25.22	332.66
5745 - 5825	802.11n HT20	25.19	330.37
5755 - 5795	802.11n HT40	25.14	326.59

5.3. DESCRIPTION OF AVAILABLE ANTENNAS

The radio utilizes a dual band omni monopole (4 identical) antenna, each with a maximum gain of 2 dBi in the 2.4 GHz band and 3 dBi in the 5.8 GHz band.

For the 802.11a/b/g legacy modes the effective legacy antenna gain is:

Antenna Gain (dBi)	10 Log (# Tx Chains) (dB)	Effective Legacy Gain (dBi)
2	6.02	8.02
3	6.02	9.02

5.4. SOFTWARE AND FIRMWARE

The EUT driver software installed during testing was Qualcomm, rev. 0.0.500.5.

The test utility software used during emissions testing was PTT Gui, rev. 5.1.

5.5. WORST-CASE CONFIGURATION AND MODE

The EUT was tested as an external module connected to a host Laptop PC via a test fixture.

Worst-Case data rates were utilized from preliminary testing of the Chipset, worst-case data rates used during the testing are as follows:

802.11b Mode (20 MHz BW operation): 1 Mbps, CCK.

802.11g Mode (20 MHz BW operation): 6 Mbps, OFDM.

802.11n MIMO HT20 Mode: MCS31, 260 Mbps, 4 Spatial Streams.

802.11n MIMO HT40 Mode: MCS31, 540 Mbps, 4 Spatial Streams.

Worst-case mode and channel used for 30-1000 MHz radiated and power line conducted emissions was the mode and channel with the highest output power, that was determined to be 11b mode, mid channel.

For bandwidth measurement preliminary testing showed that there is no significant difference among different chains, so the measurements were performed using Chain 0.

For conducted spurious measurement preliminary testing showed that combiner is worst-case compared to individual chains; therefore final measurements were performed using combiner for all channels and modes.

For PSD measurement preliminary testing showed that combiner is worst-case compared to individual chains; therefore final measurements were performed using combiner for all channels and modes.

For Radiated Band Edge measurements preliminary testing showed that the worst case was vertical polarization, so final measurements were performed with vertical polarization.

5.6. DESCRIPTION OF TEST SETUP

SUPPORT EQUIPMENT

PERIPHERAL SUPPORT EQUIPMENT LIST				
Description	Manufacturer	Model	Serial Number	FCC ID
Laptop	IBM	T43 ThinkPad	L3-F9978 05/06	DoC
AC Adapter	IBM	08K8208	11S08K8208Z1Z6	DoC
AC Adapter	Phihong	PSA15R-050P	N/A	N/A
Serial (DB9)/USB	Keyspan	N/A	N/A	N/A
Test Fixture	N/A	N/A	N/A	N/A

I/O CABLES

I/O CABLE LIST						
Cable No.	Port	# of Identical Ports	Connecto Type	Cable Type	Cable Length	Remarks
1	AC	2	US 115V	Shielded	1m	For laptop & EUT
2	DC	2	DC	Un-shielded	2m	For laptop & EUT
3	USB	1	USB	Shielded	.8m	From laptop to USB Converter
4	Ethernet	1	RJ45	Un-shielded	1 m	From laptop to EUT
5	Cable	1	Riibon	Un-shielded	.4 m	Test Fixture to EUT

TEST SETUP

The EUT is installed in a host laptop computer via test fixture during the tests. Test software exercised the radio card.

SETUP DIAGRAM FOR TESTS

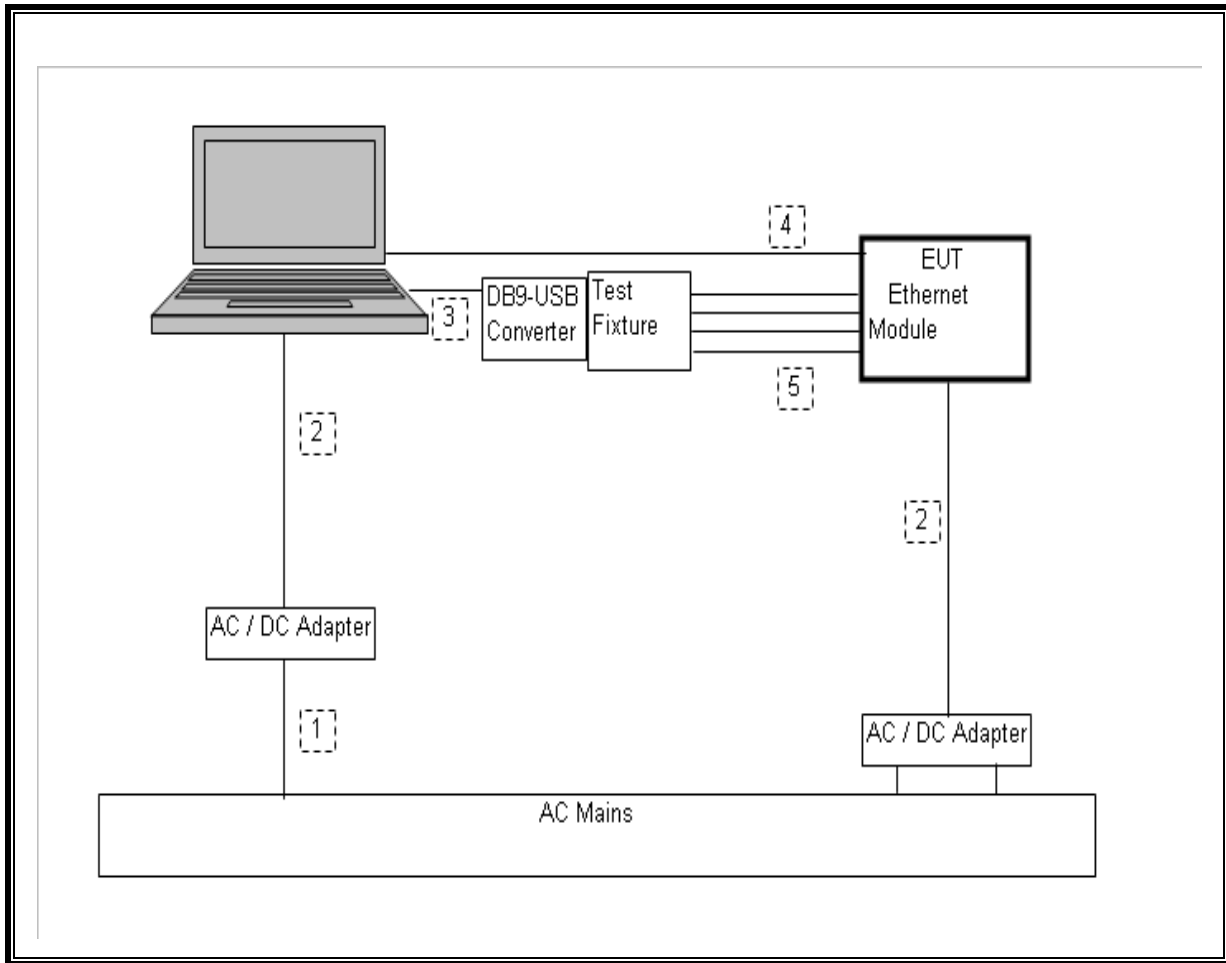

6. TEST AND MEASUREMENT EQUIPMENT

The following test and measurement equipment was utilized for the tests documented in this report:

TEST EQUIPMENT LIST					
Description	Manufacturer	Model	Asset	Cal Date	Cal Due
Spectrum Analyzer, 44 GHz	Agilent / HP	E4446A	C01069	01/05/09	01/05/10
Antenna, Bilog, 2 GHz	Sunol Sciences	JB1	C01011	01/14/09	01/14/10
Antenna, Horn, 18 GHz	EMCO	3115	C00945	04/22/09	04/22/10
Antenna, Horn, 26.5 GHz	ARA	MVH-1826/B	C00589	09/29/08	11/28/09
Antenna, Horn, 40 GHz	ARA	MVH-2640B	C00981	05/21/09	05/21/10
Preamplifier, 40 GHz	Miteq	NSP4000-SP2	C00990	10/11/08	10/11/09
Preamplifier, 1300 MHz	Agilent / HP	8447D	C00885	03/31/09	03/31/10
Preamplifier, 1-26GHz	Agilent / HP	8449B	C01052	08/05/08	08/05/09
Peak Power Meter	Boonton	4541	C01186	01/19/09	01/19/10
Peak Power Sensor	Boonton	4541	C01189	01/15/09	01/15/10
LISN, 30 MHz	FCC	LISN-50/250-25-2	N02625	10/29/08	10/29/09
EMI Test Receiver, 30 MHz	R & S	ESHS 20	N02396	02/06/08	08/06/09

7. ANTENNA PORT TEST RESULTS

7.1. 2.4 GHz BAND CHANNEL TESTS FOR 802.11b MODE

7.1.1. 6 dB BANDWIDTH

LIMITS

FCC §15.247 (a) (2)

IC RSS-210 A8.2 (a)

The minimum 6 dB bandwidth shall be at least 500 kHz.

TEST PROCEDURE

The transmitter output is connected to a spectrum analyzer. The RBW is set to 100 kHz and the VBW is set to 300 kHz. The sweep time is coupled.

RESULTS

Channel	Frequency (MHz)	6 dB BW (MHz)	Minimum Limit (MHz)
Low	2412	9.00	0.5
Middle	2437	8.58	0.5
High	2462	7.67	0.5

6 dB BANDWIDTH

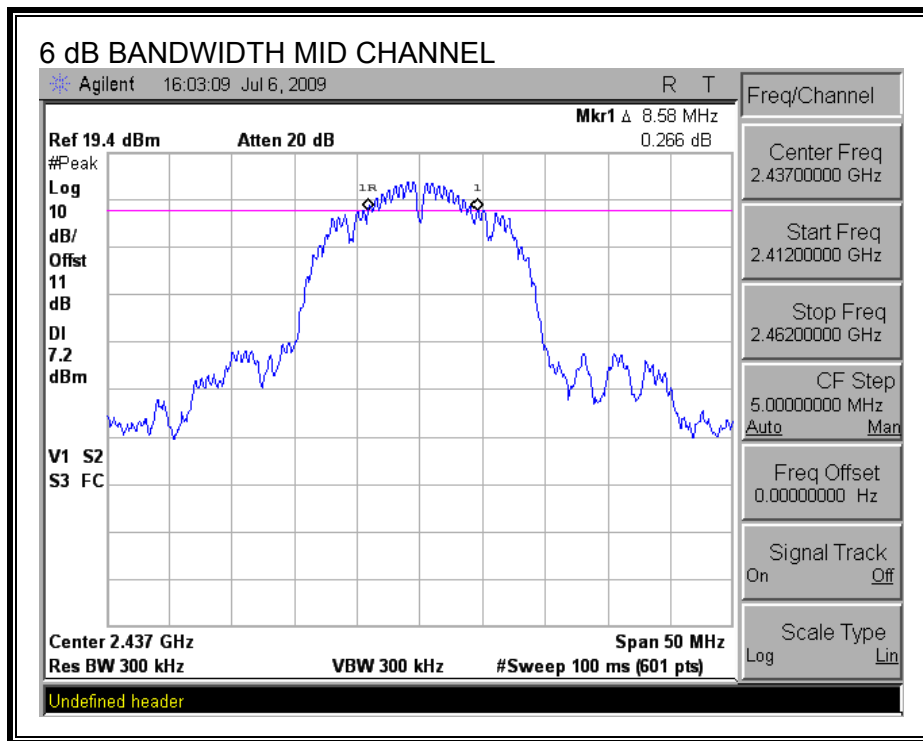
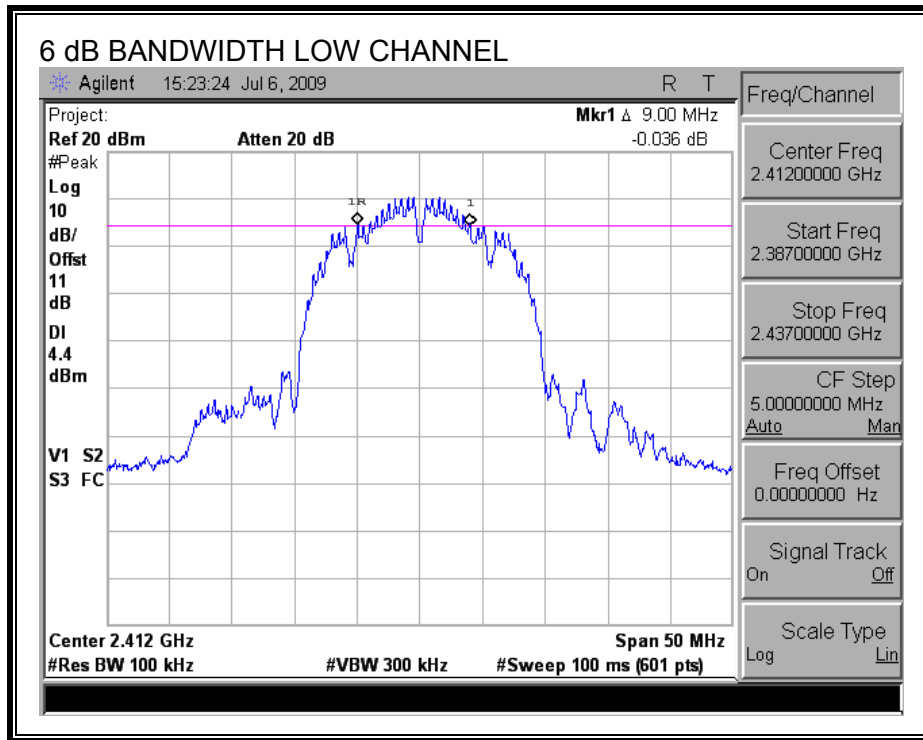

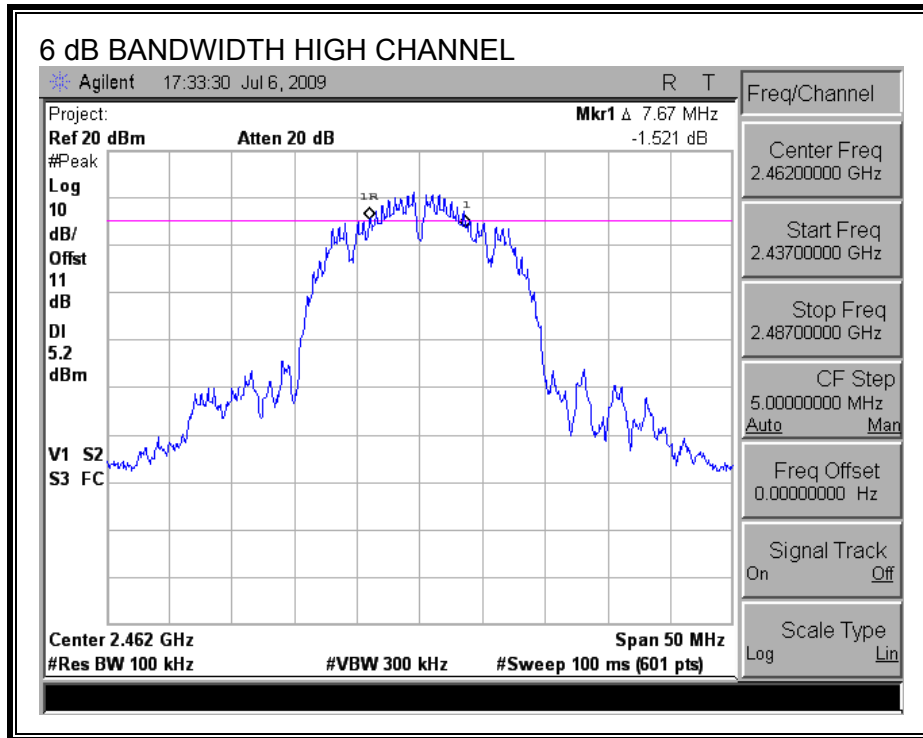

7.1.2. 99% & 26 dB BANDWIDTH

LIMITS

None; for reporting purposes only.

TEST PROCEDURE

The transmitter output is connected to the spectrum analyzer. The RBW is set to 1% to 3% of the bandwidth. The VBW is set to 3 times the RBW. The sweep time is coupled. The spectrum analyzer internal bandwidth measurement function is utilized.

RESULTS

Channel	Frequency (MHz)	99% OBW (MHz)	26 dB BW (MHz)
Low	2412	15.62	18.14
Middle	2437	15.63	18.70
High	2462	15.34	17.94

99% & 26 dB BANDWIDTH

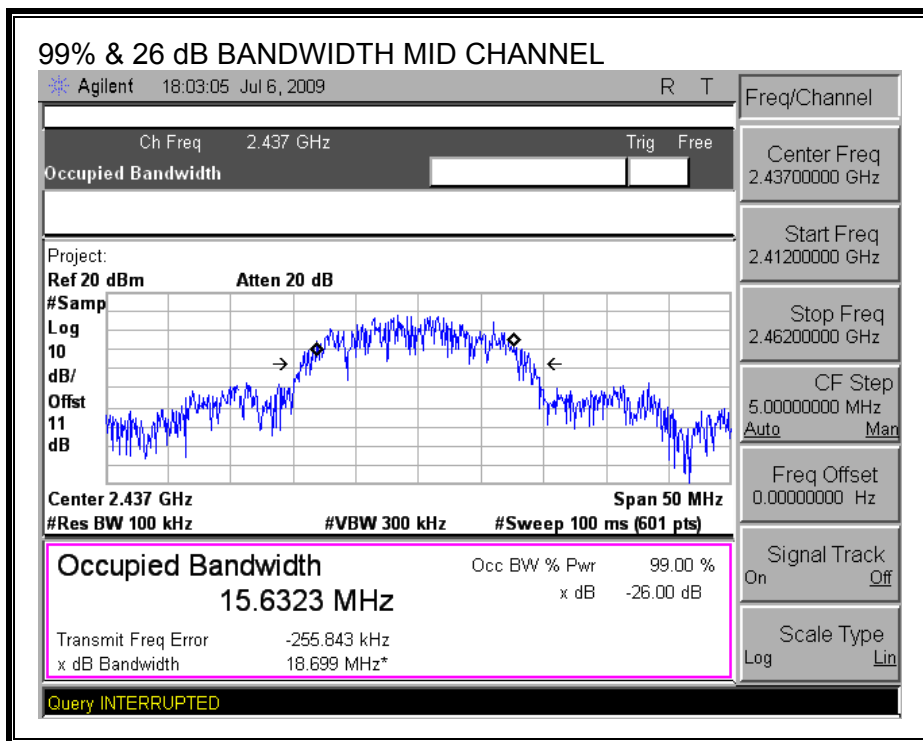
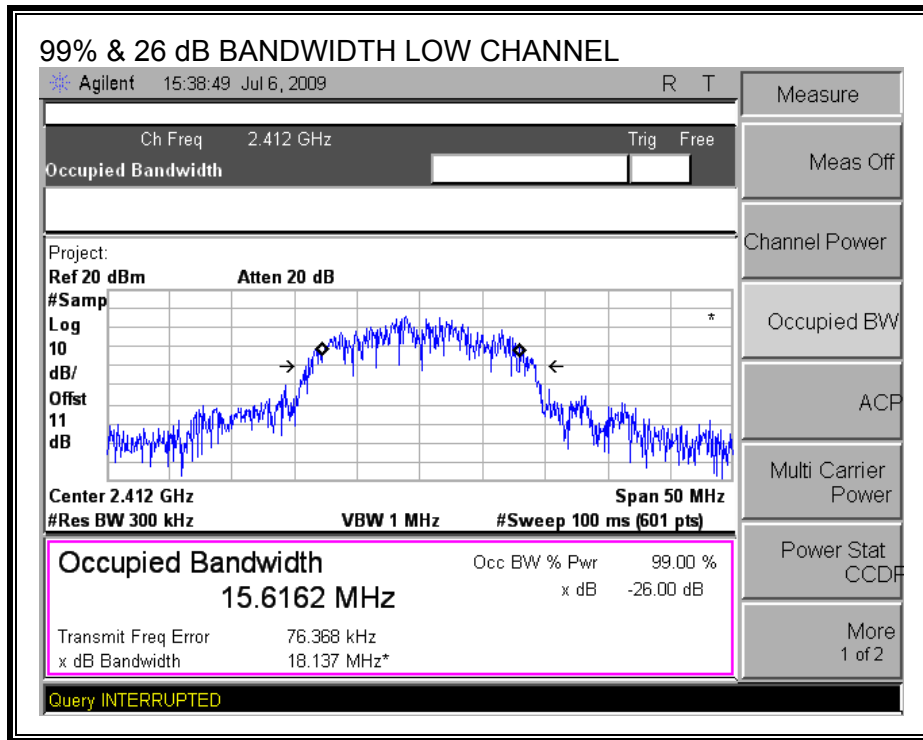

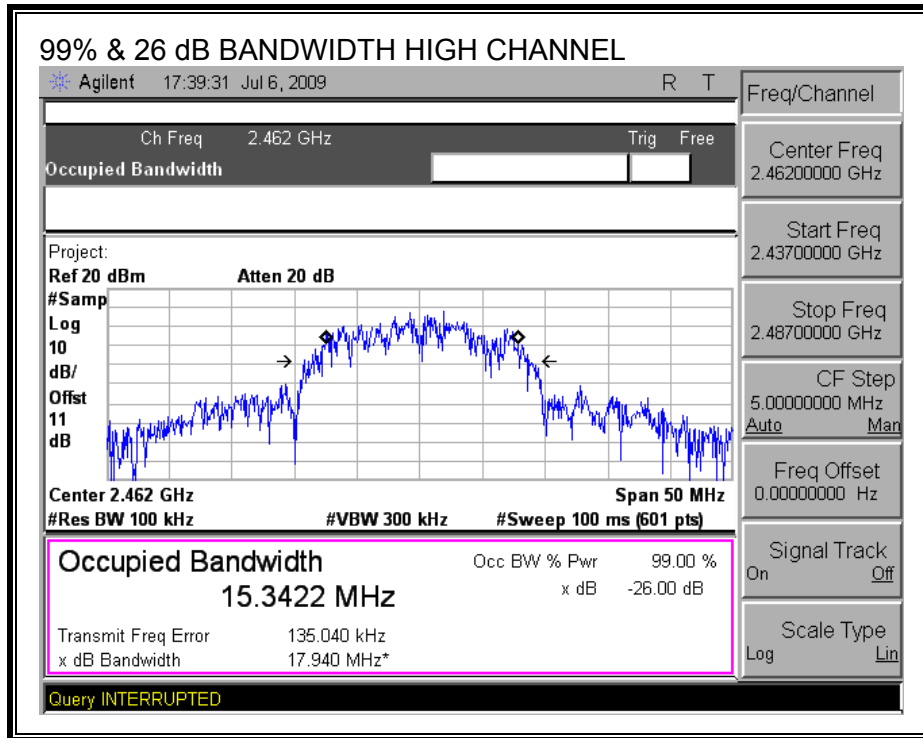

7.1.3. OUTPUT POWER

LIMITS

FCC §15.247 (b)

IC RSS-210 A8.4

TEST PROCEDURE

Output power was measured based on the use of RMS averaging over a time interval in accordance with FCC document "Measurement of Digital Transmission Systems Operating under Section 15.247", March 23, 2005.

RESULTS

Effective Legacy Mode Composite Gain of 4 Identical Antennas:

Antenna Gain (dBi)	10 Log (# Tx Chains) (dB)	Effective Legacy Gain (dBi)
2	6.02	8.02

The composite antenna gain is 8.02 dBi, therefore the limit is 27.98 dBm.

Channel	Frequency (MHz)	Chain 0 Power (dBm)	Chain 1 Power (dBm)	Chain 2 Power (dBm)	Chain 3 Power (dBm)	Total Power (dBm)	Limit (dBm)	Margin (dB)
Low	2412	18.12	17.14	17.22	17.24	23.47	27.92	-4.45
Mid	2437	20.26	20.60	20.63	20.87	26.62	27.92	-1.30
High	2462	18.27	18.44	18.18	18.72	24.43	27.92	-3.49

OUTPUT POWER, LOW CHANNEL

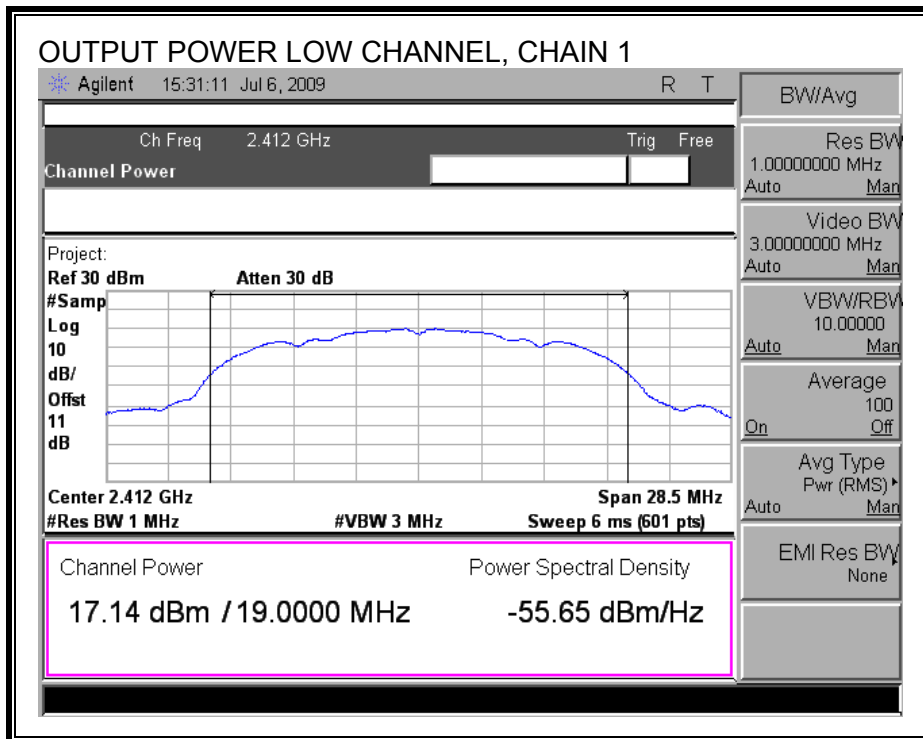
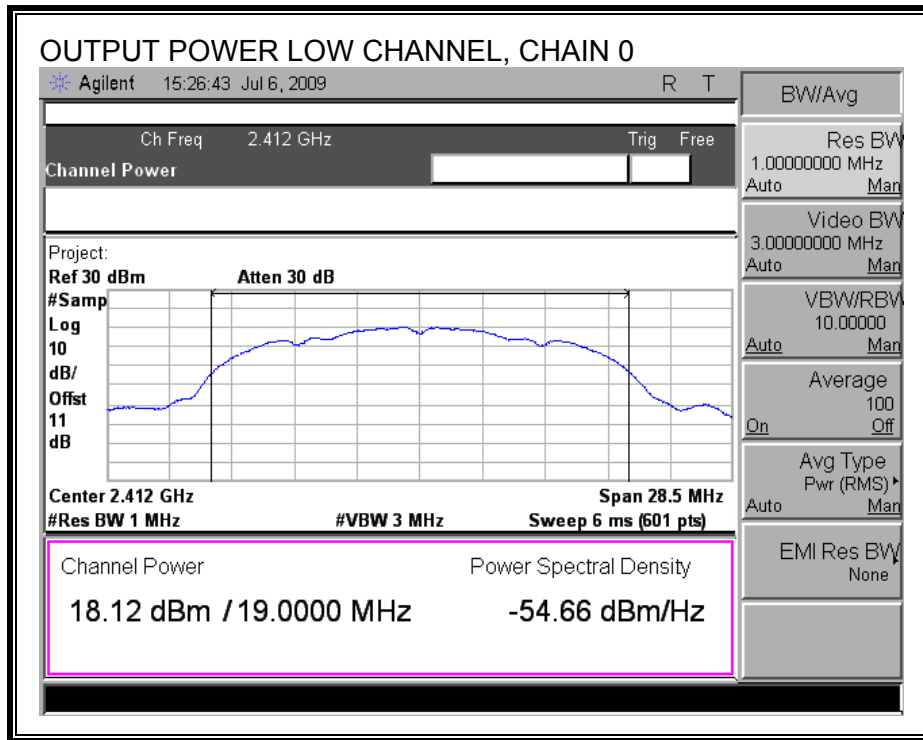

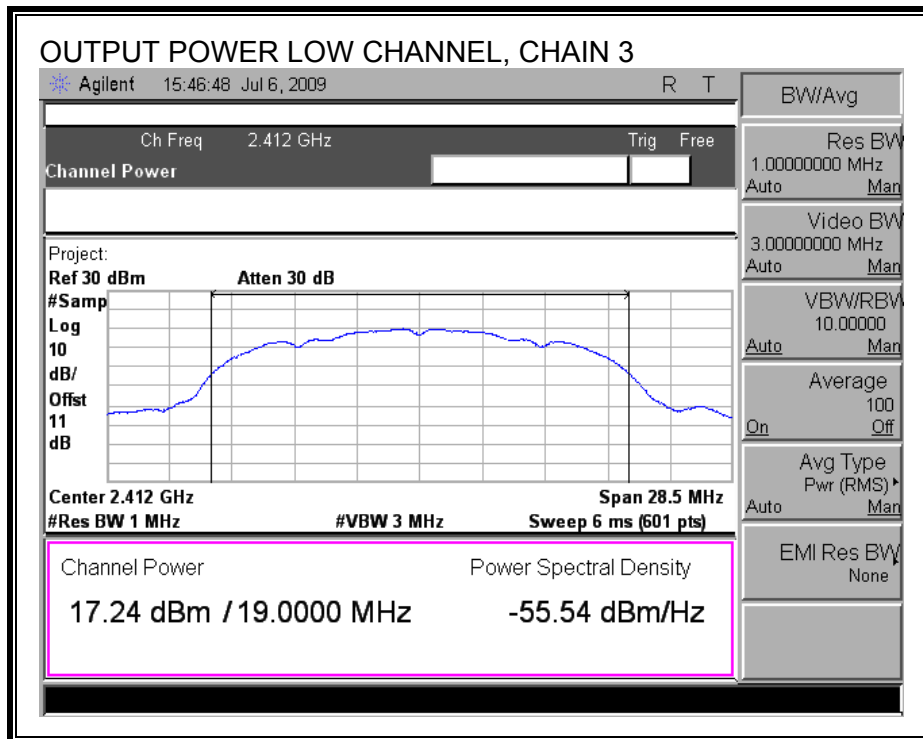
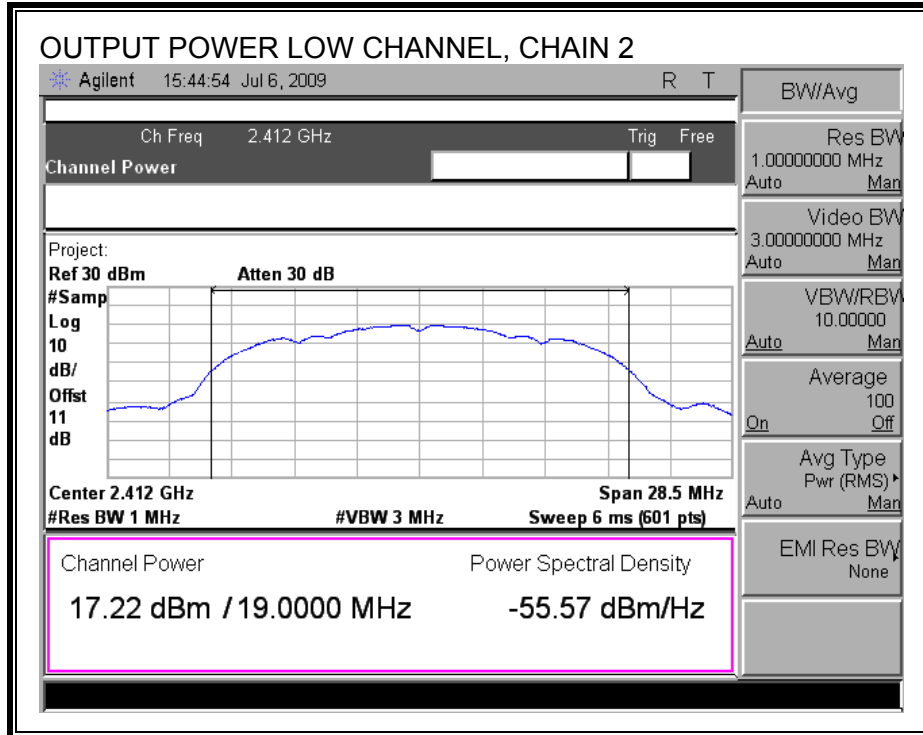

OUTPUT POWER, MID CHANNEL

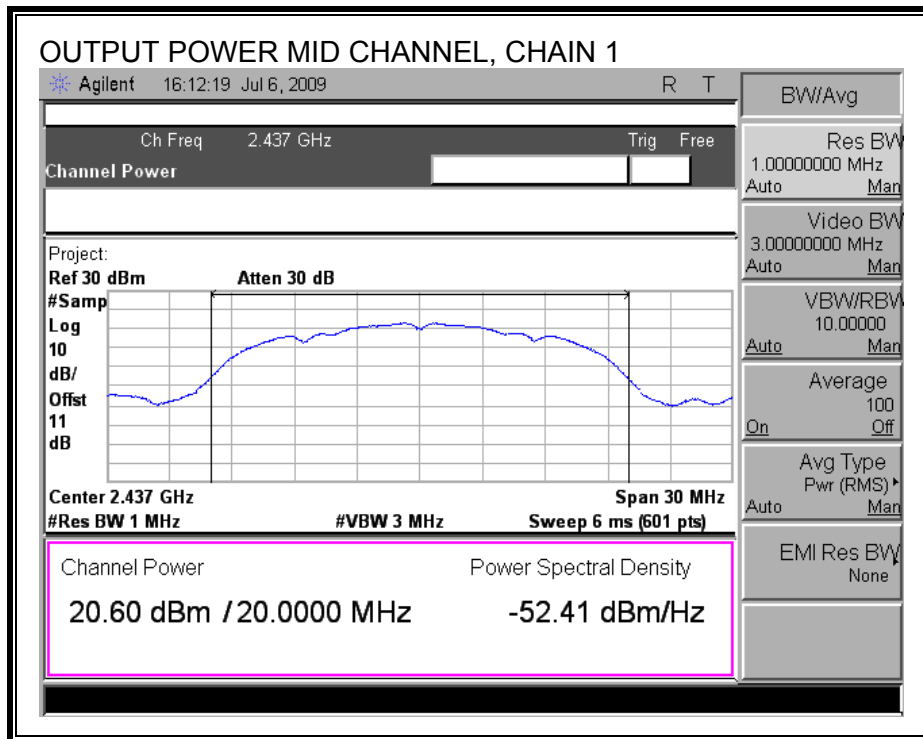
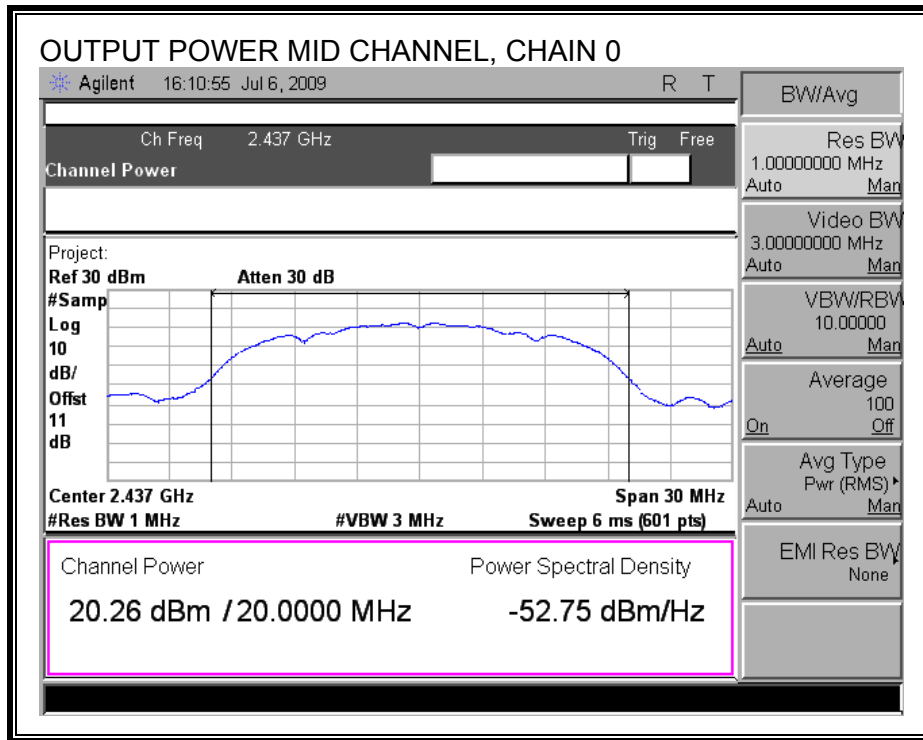

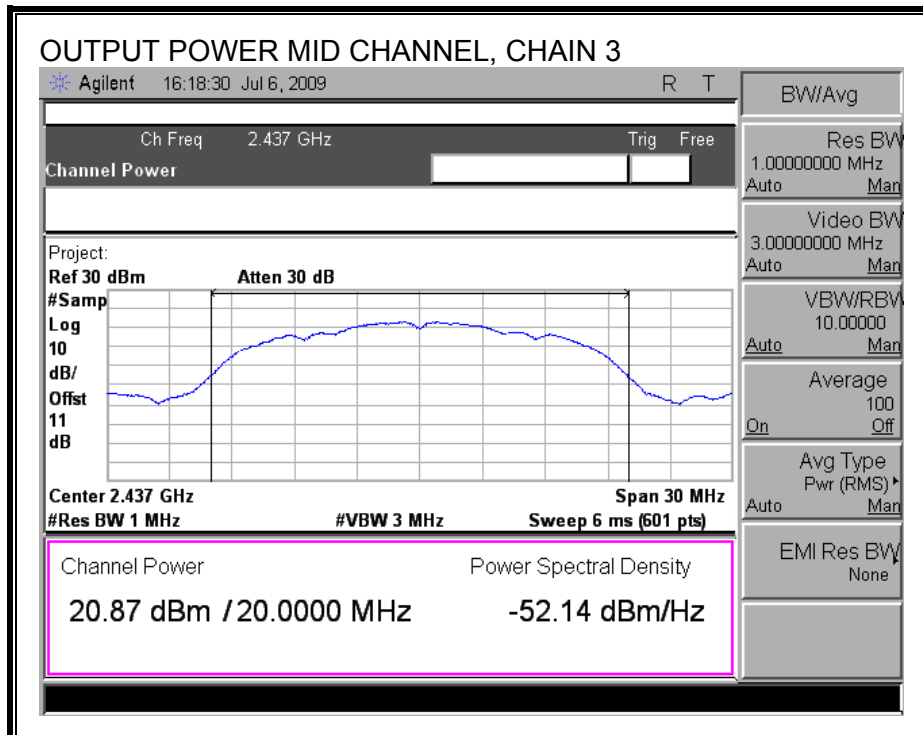
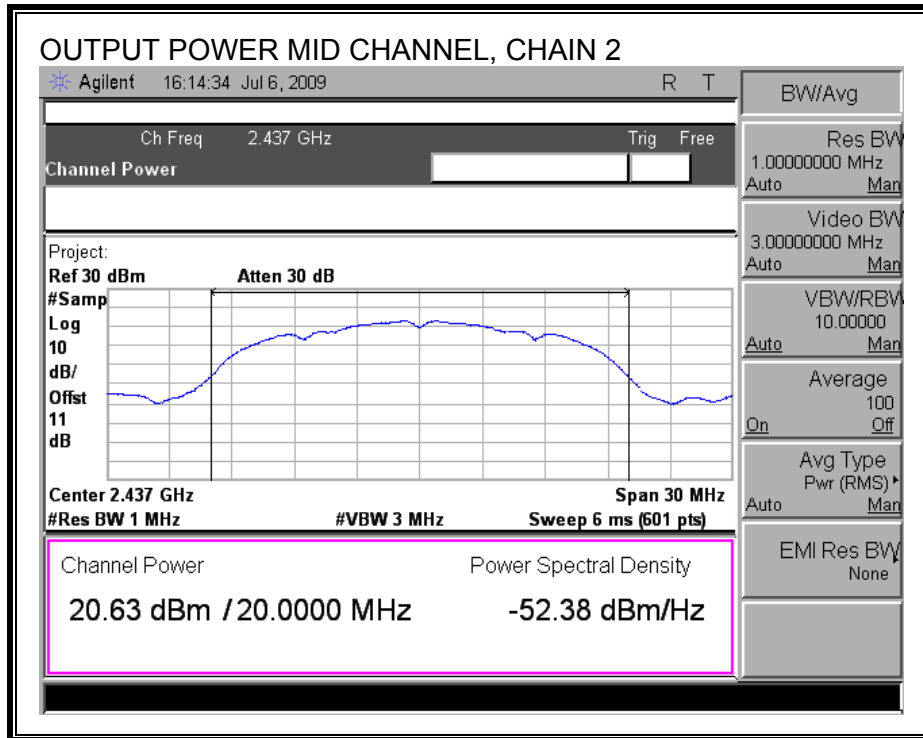

OUTPUT POWER, HIGH CHANNEL

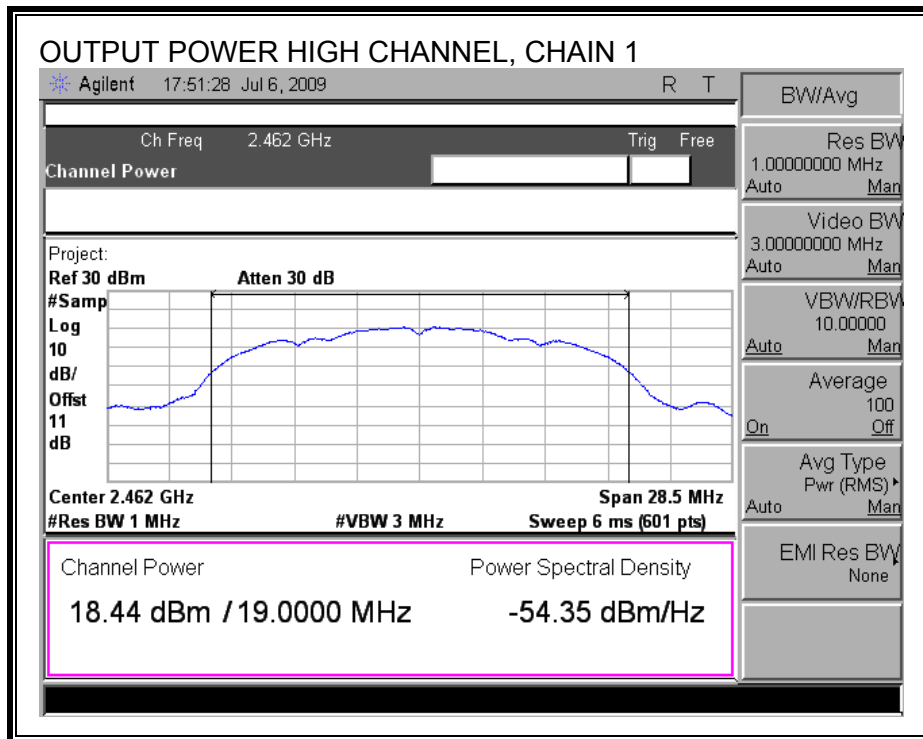
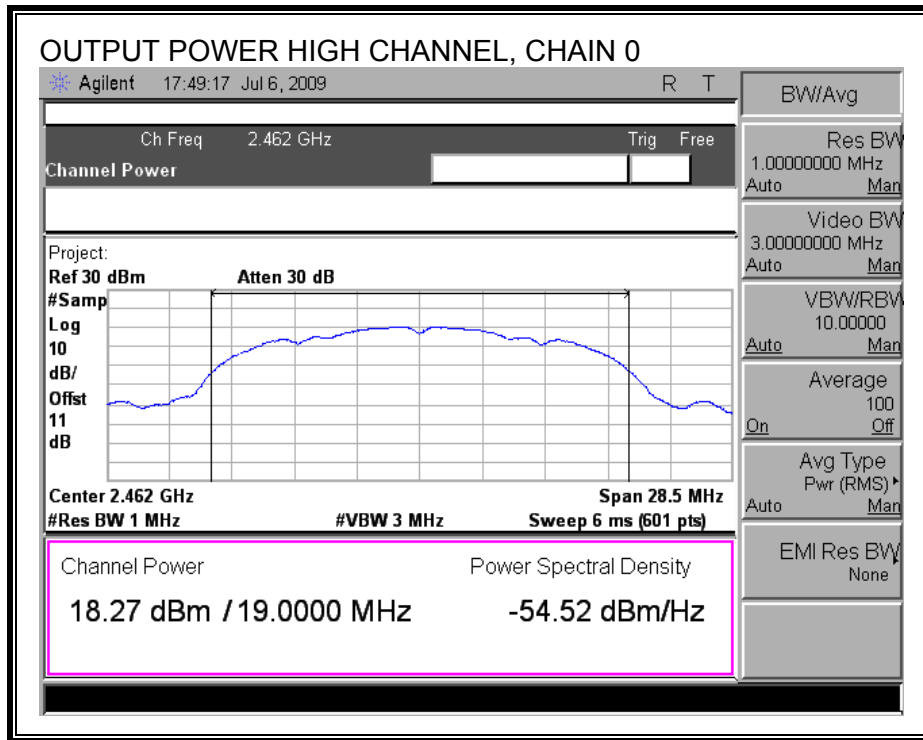

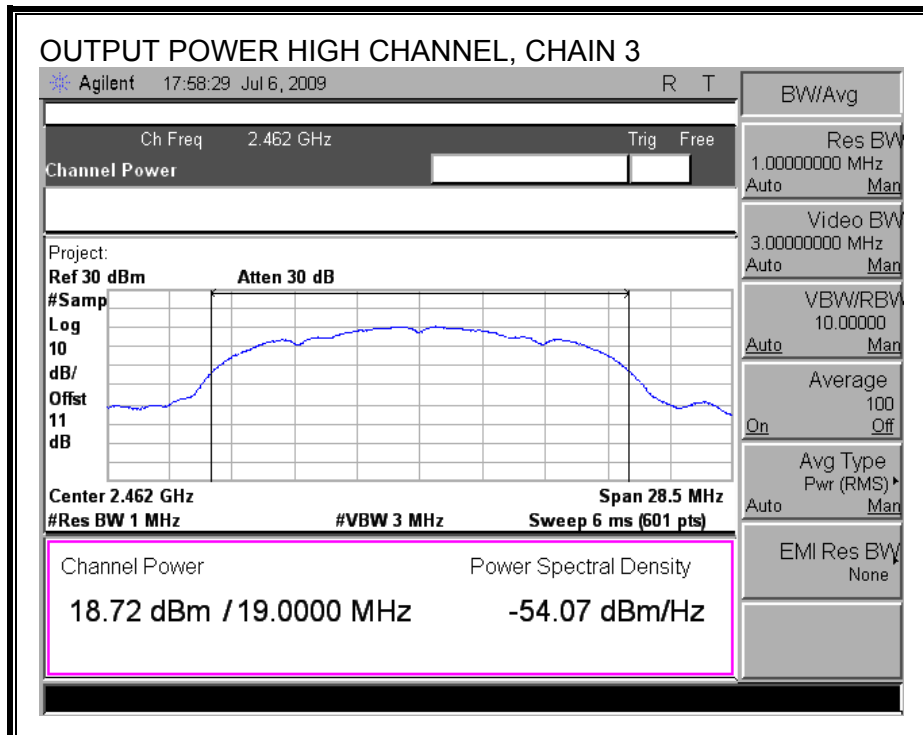
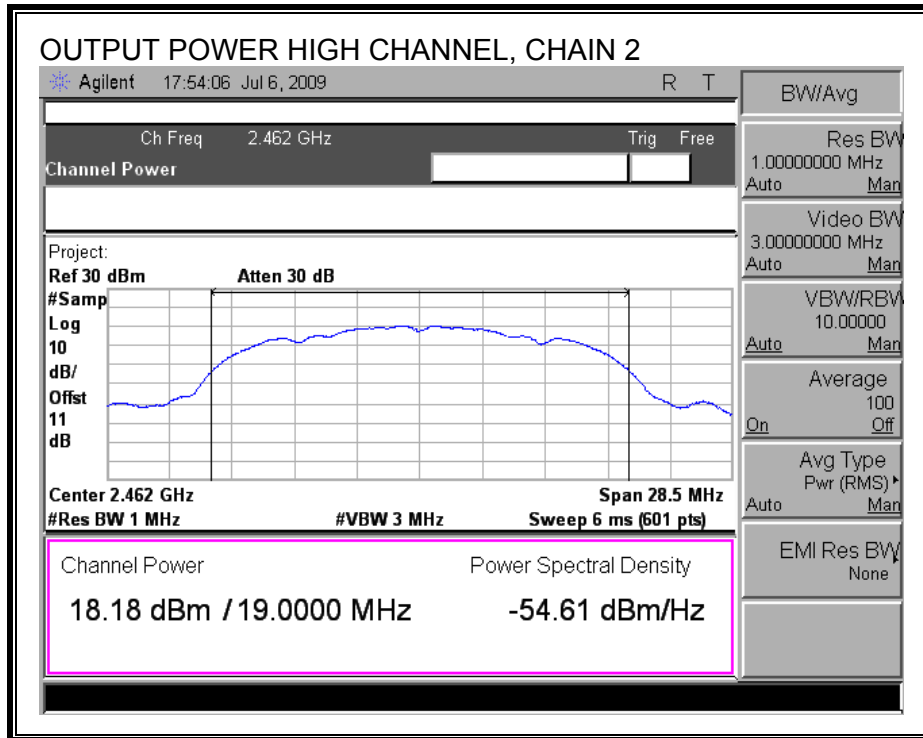

7.1.4. AVERAGE POWER

LIMITS

None; for reporting purposes only.

TEST PROCEDURE

The transmitter output is connected to a power meter.

The cable assembly insertion loss of 11 dB (including 10 dB pad and 1 dB cable) was entered as an offset in the power meter to allow for direct reading of power.

RESULTS

Channel	Frequency (MHz)	Chain 0 Power (dBm)	Chain 1 Power (dBm)	Chain 2 Power (dBm)	Chain 3 Power (dBm)
Low	2412	17.07	17.84	17.51	17.61
Middle	2437	20.44	20.69	20.51	20.66
High	2462	18.35	18.49	18.55	18.43

7.1.5. POWER SPECTRAL DENSITY

LIMITS

FCC §15.247 (e)

IC RSS-210 A8.2 (b)

The power spectral density conducted from the transmitter to the antenna shall not be greater than 8 dBm in any 3 kHz band during any time interval of continuous transmission.

TEST PROCEDURE

Output power was measured based on the use of RMS averaging over a time interval, therefore the power spectral density was measured using PSD Option 2 in accordance with FCC document "Measurement of Digital Transmission Systems Operating under Section 15.247", March 23, 2005.

Preliminary tests on individual chains, and on all chains with a combiner, were performed. The worst-case configuration was with a combiner, therefore final test were performed with all chains feeding a combiner.

RESULTS

Channel	Frequency (MHz)	PSD with Combiner (dBm)	Limit (dBm)	Margin (dB)
Low	2412	-8.97	8	-16.97
Middle	2437	-0.08	8	-8.08
High	2462	-7.32	8	-15.32

POWER SPECTRAL DENSITY

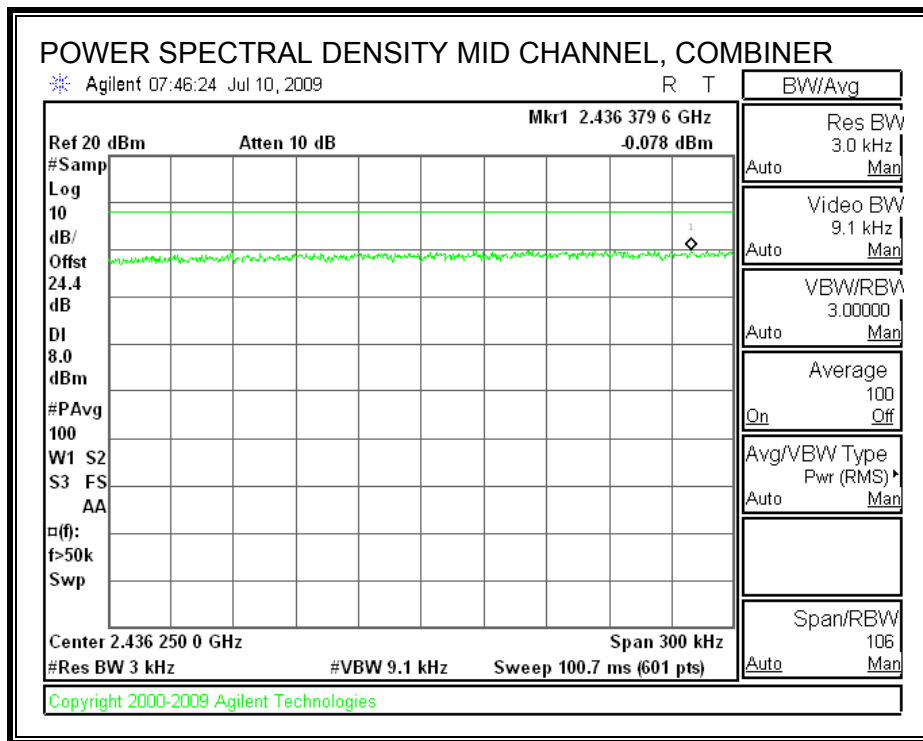
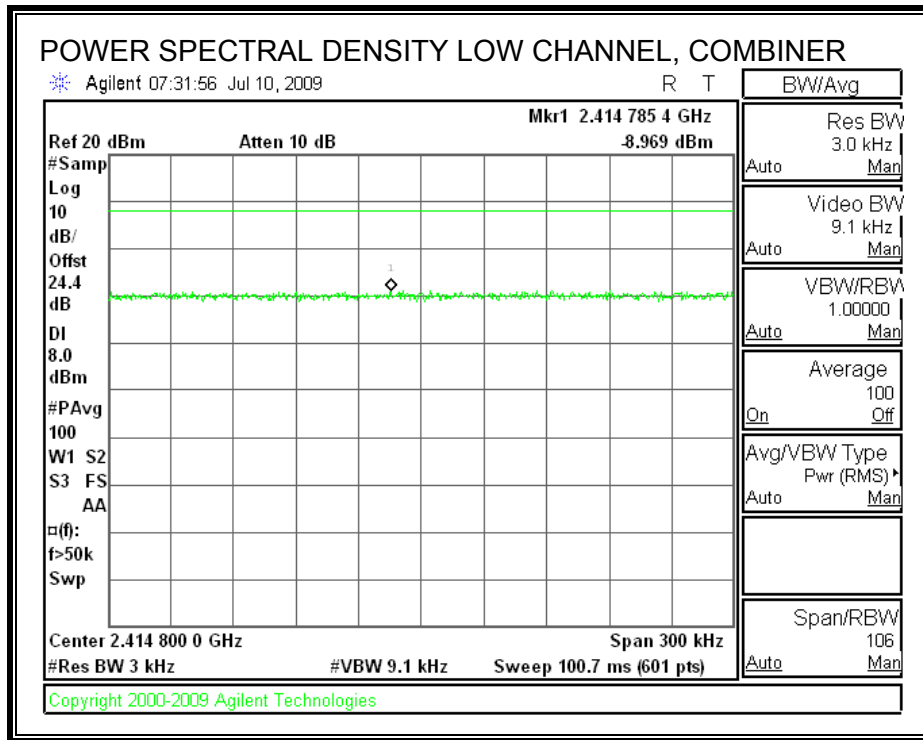

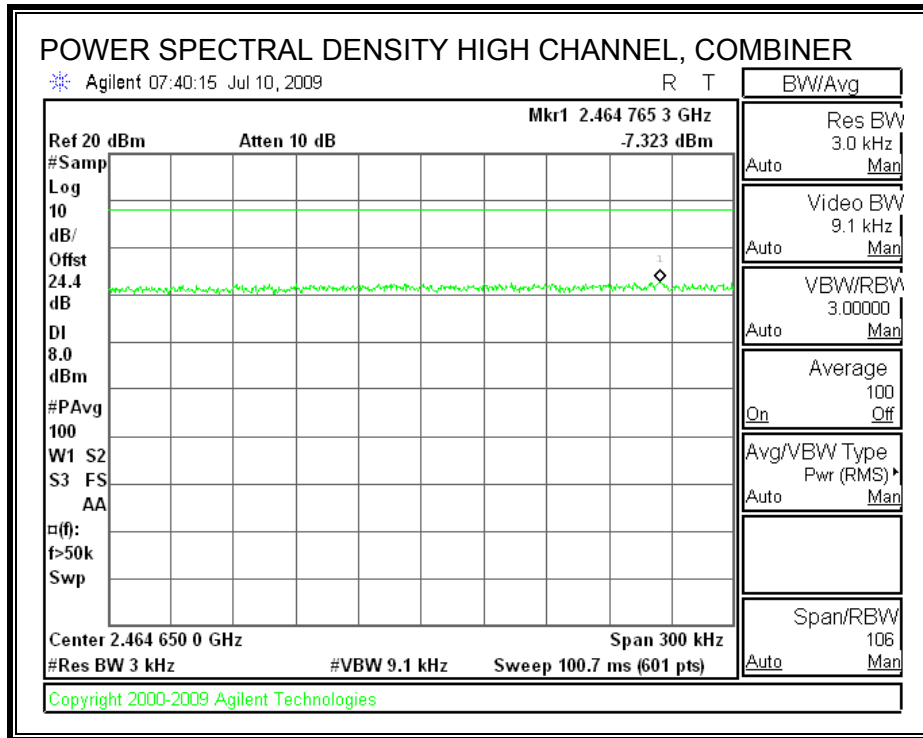

7.1.6. CONDUCTED SPURIOUS EMISSIONS

LIMITS

FCC §15.247 (d)

IC RSS-210 A8.5

Output power was measured based on the use of RMS averaging over a time interval, therefore the required attenuation is 30 dBc.

TEST PROCEDURE

The transmitter output is connected to a spectrum analyzer. The resolution bandwidth is set to 100 kHz. The video bandwidth is set to 300 kHz.

The spectrum from 30 MHz to 26 GHz is investigated with the transmitter set to the lowest, middle, and highest channels.

Preliminary tests on individual chains, and on all chains with a combiner, were performed. The worst-case configuration was with a combiner, therefore final test were performed with all chains feeding a combiner.

LOW CHANNEL SPURIOUS EMISSIONS

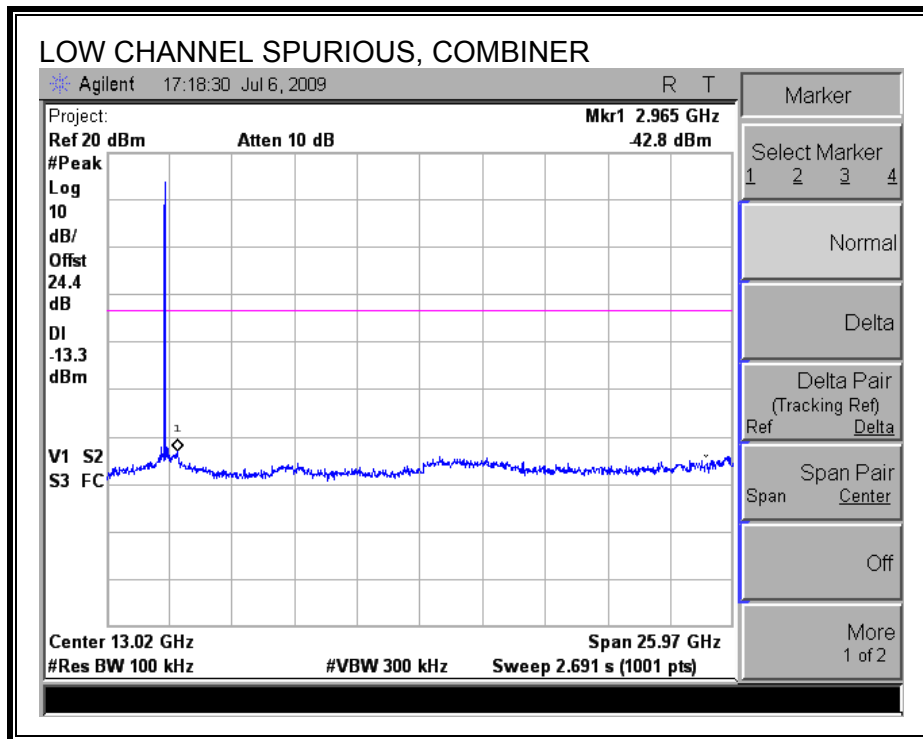
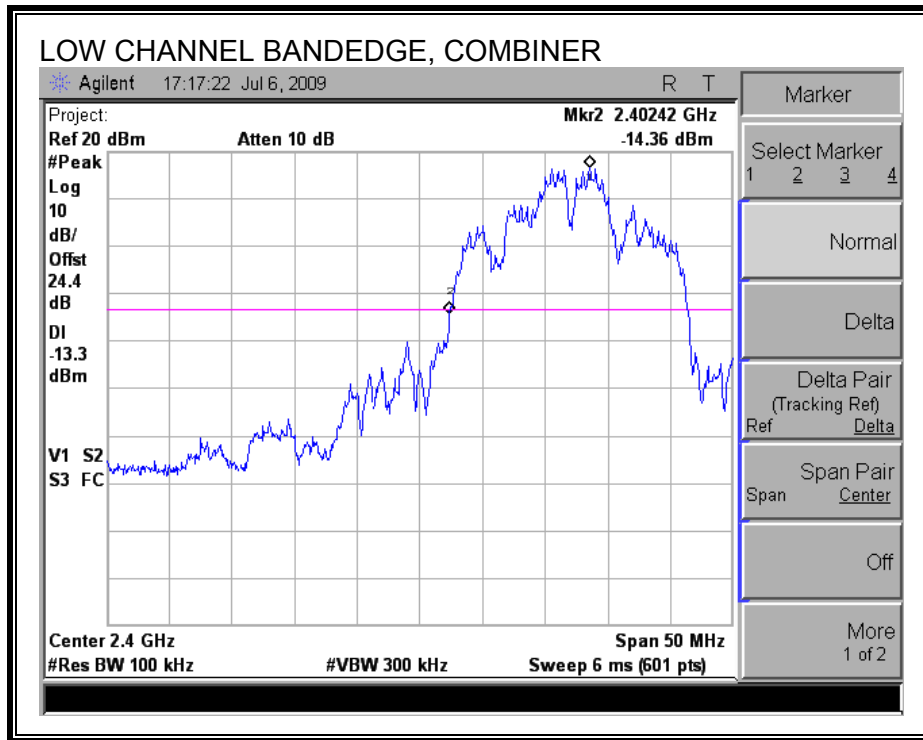

MID CHANNEL SPURIOUS EMISSIONS

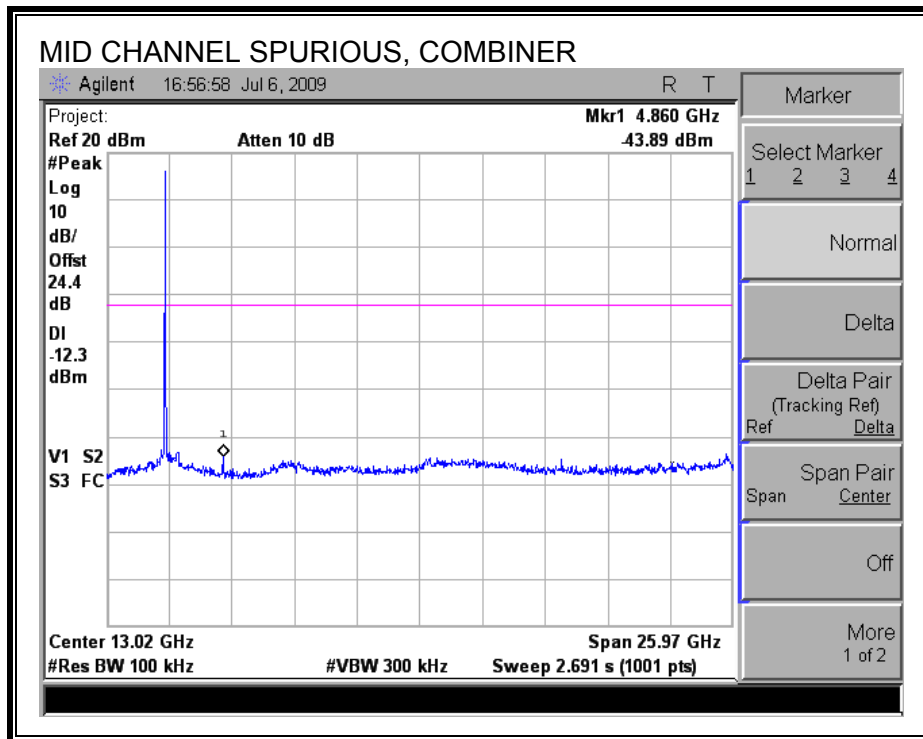
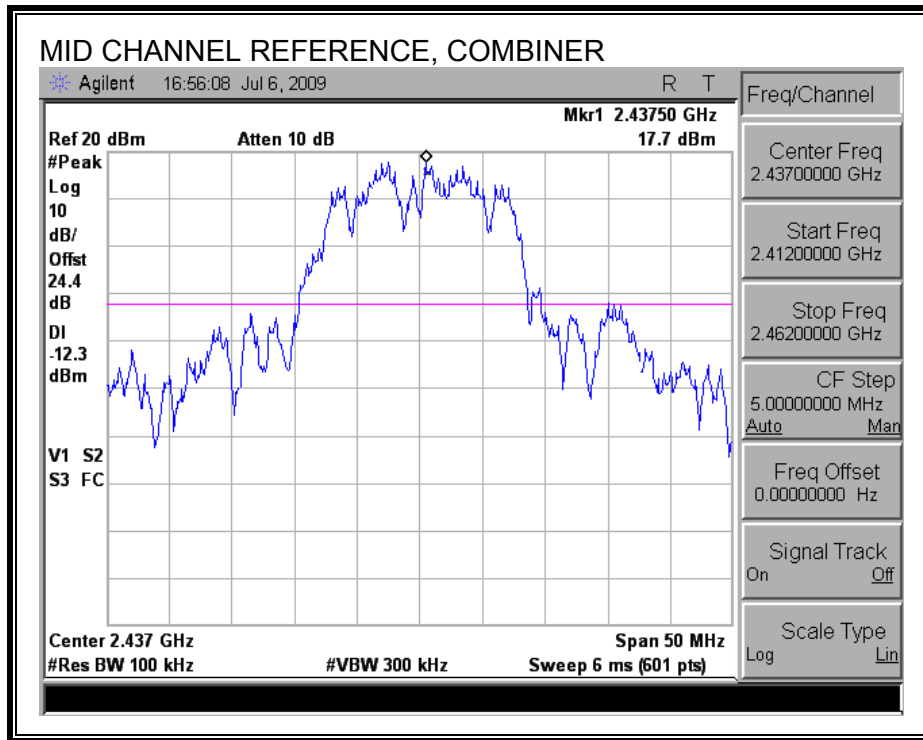

HIGH CHANNEL SPURIOUS EMISSIONS

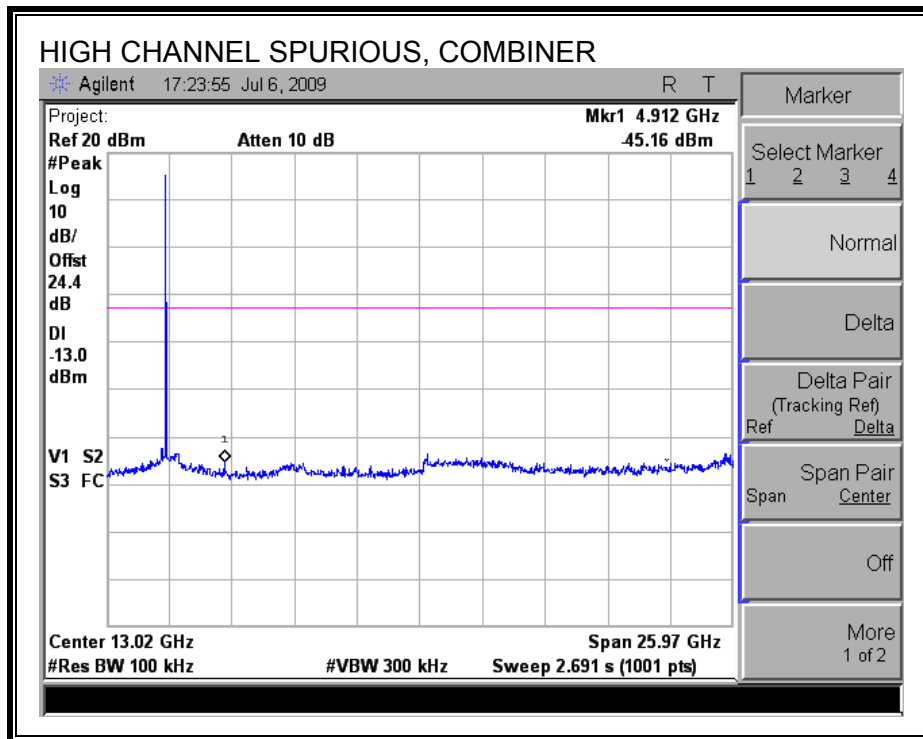
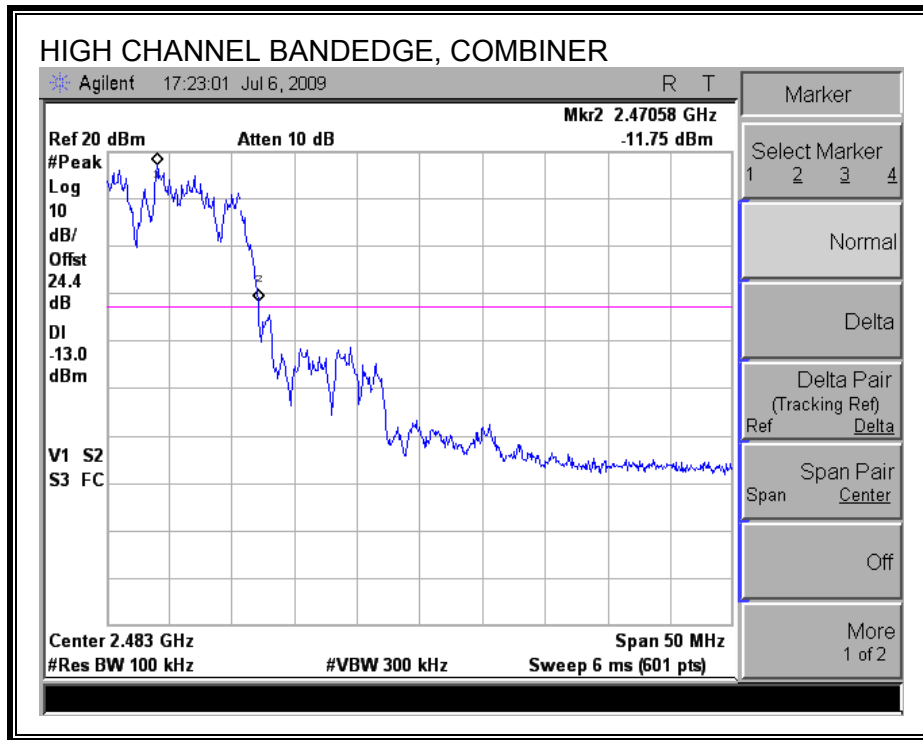

7.2. 2.4 GHz BAND CHANNEL TESTS FOR 802.11g MODE

7.2.1. 6 dB BANDWIDTH

LIMITS

FCC §15.247 (a) (2)

IC RSS-210 A8.2 (a)

The minimum 6 dB bandwidth shall be at least 500 kHz.

TEST PROCEDURE

The transmitter output is connected to a spectrum analyzer. The RBW is set to 100 kHz and the VBW is set to 300 kHz. The sweep time is coupled.

RESULTS

Channel	Frequency (MHz)	6 dB BW (MHz)	Minimum Limit (MHz)
Low	2412	16.33	0.5
Middle	2437	15.92	0.5
High	2462	16.33	0.5

6 dB BANDWIDTH

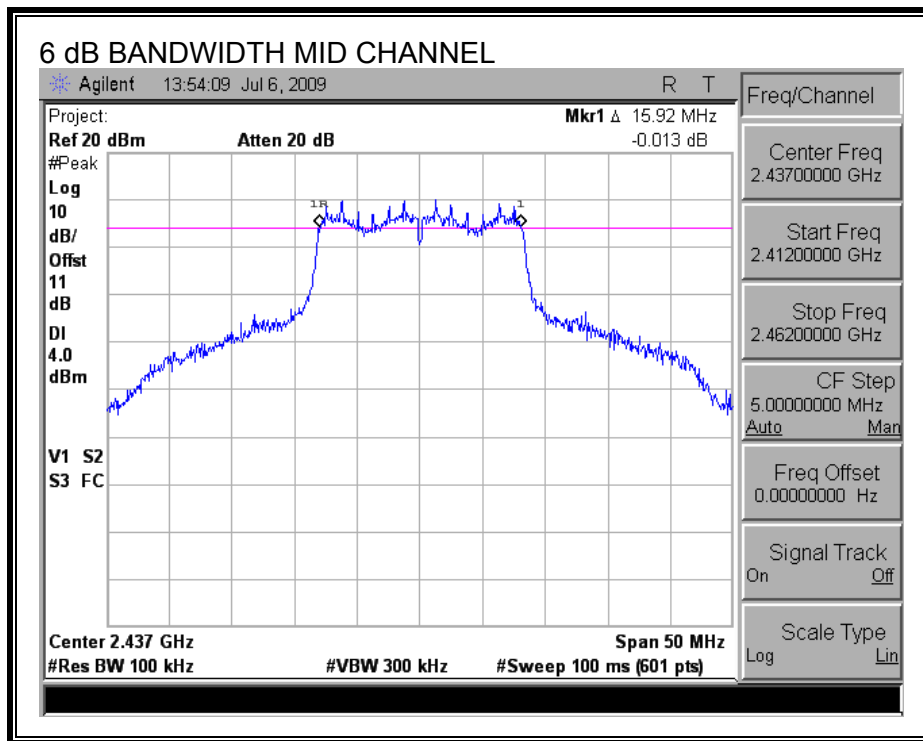
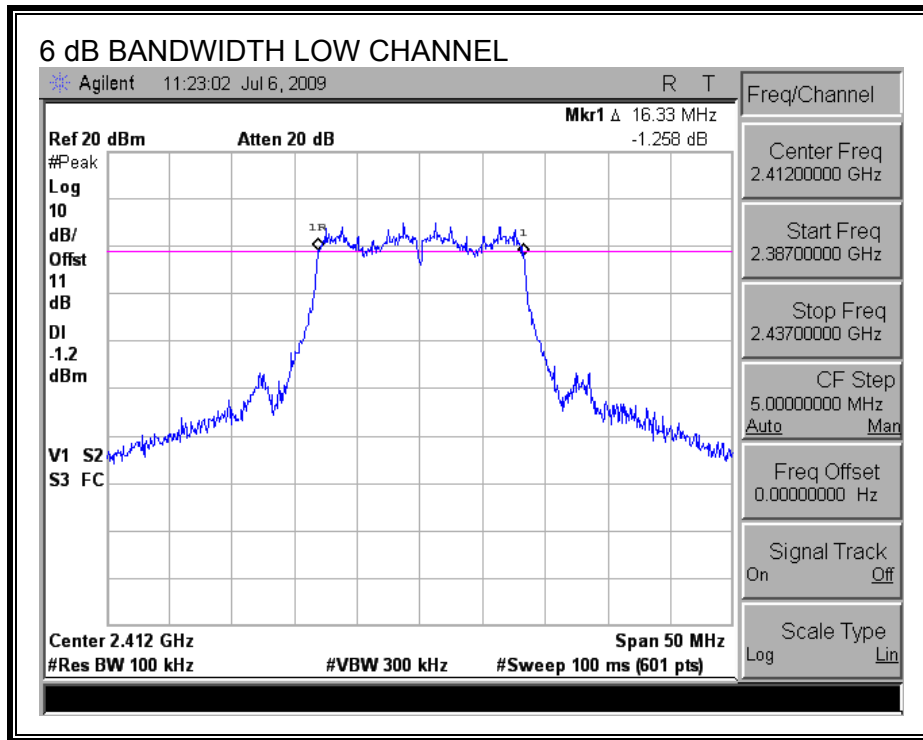

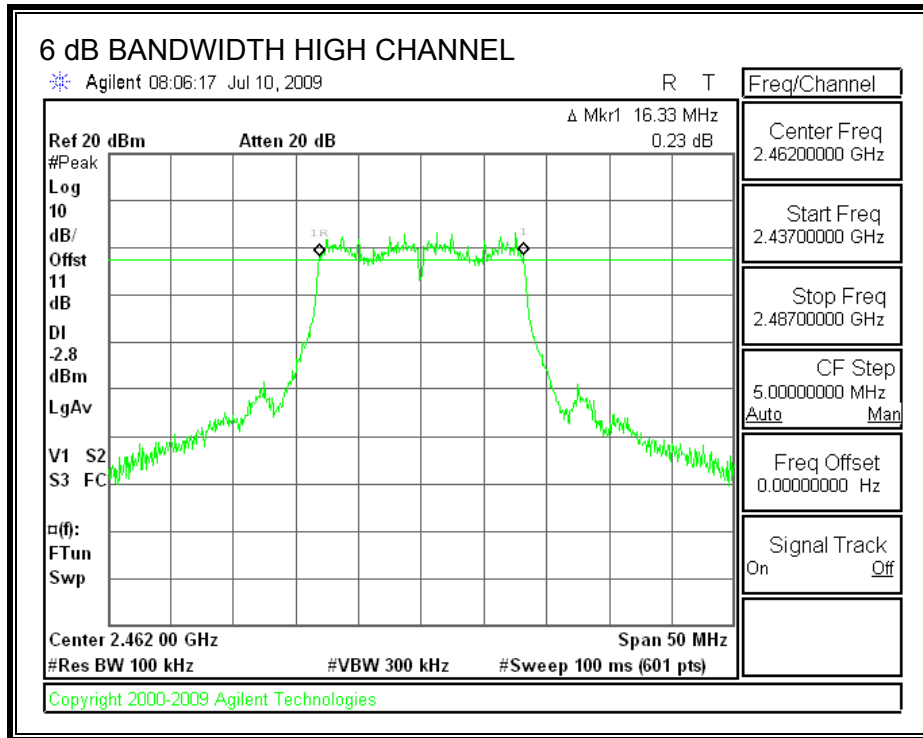

7.2.2. 99% & 26 dB BANDWIDTH

LIMITS

None; for reporting purposes only.

TEST PROCEDURE

The transmitter output is connected to the spectrum analyzer. The RBW is set to 1% to 3% of the bandwidth. The VBW is set to 3 times the RBW. The sweep time is coupled. The spectrum analyzer internal bandwidth measurement function is utilized.

RESULTS

Channel	Frequency (MHz)	99% OBW (MHz)	26 dB BW (MHz)
Low	2412	16.44	19.14
Middle	2437	16.45	22.78
High	2462	16.40	18.34

99% & 26 dB BANDWIDTH

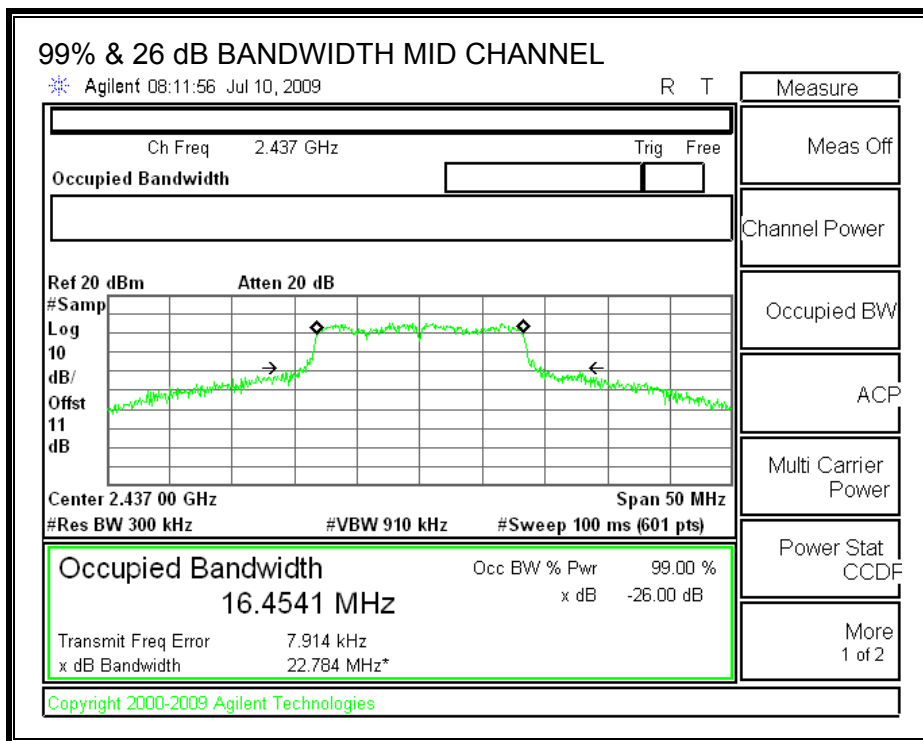
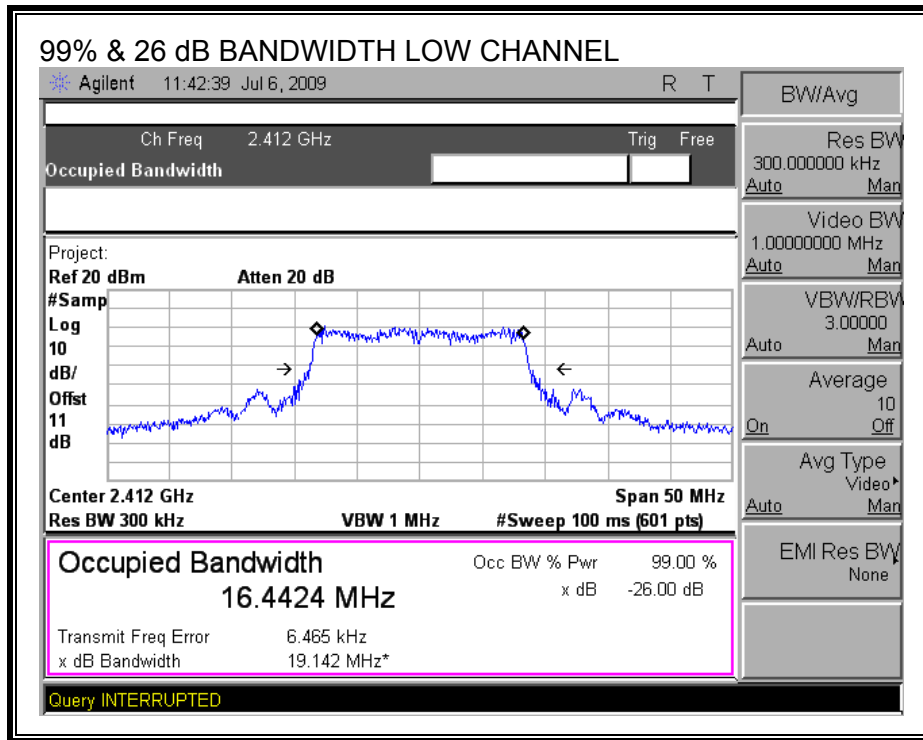

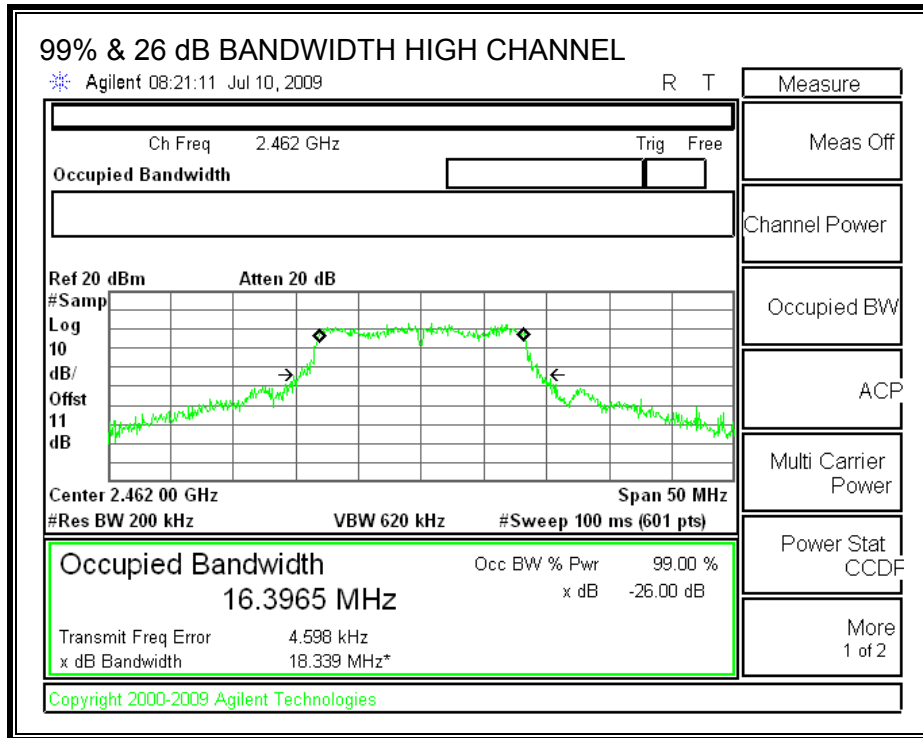

Measure

Meas Off

Channel Power

Occupied BW

ACP

Multi Carrier Power

Power Stat CCDF

More 1 of 2

7.2.3. OUTPUT POWER

LIMITS

FCC §15.247 (b)

IC RSS-210 A8.4

TEST PROCEDURE

Output power was measured based on the use of RMS averaging over a time interval in accordance with FCC document "Measurement of Digital Transmission Systems Operating under Section 15.247", March 23, 2005.

RESULTS

Effective Legacy Mode Composite Gain of 4 Identical Antennas:

Antenna Gain (dBi)	10 Log (# Tx Chains) (dB)	Effective Legacy Gain (dBi)
2	6.02	8.02

The composite antenna gain is 8.02 dBi, therefore the limit is 27.98 dBm.

Channel	Frequency (MHz)	Chain 0 Power (dBm)	Chain 1 Power (dBm)	Chain 2 Power (dBm)	Chain 3 Power (dBm)	Total Power (dBm)	Limit (dBm)	Margin (dB)
Low	2412	14.3	14.43	14.52	14.9	20.56	27.98	-7.42
Mid	2437	18.81	19.11	18.62	19.18	24.96	27.98	-3.02
High	2462	13.62	13.46	13.46	14.09	19.69	27.98	-8.29

OUTPUT POWER, LOW CHANNEL

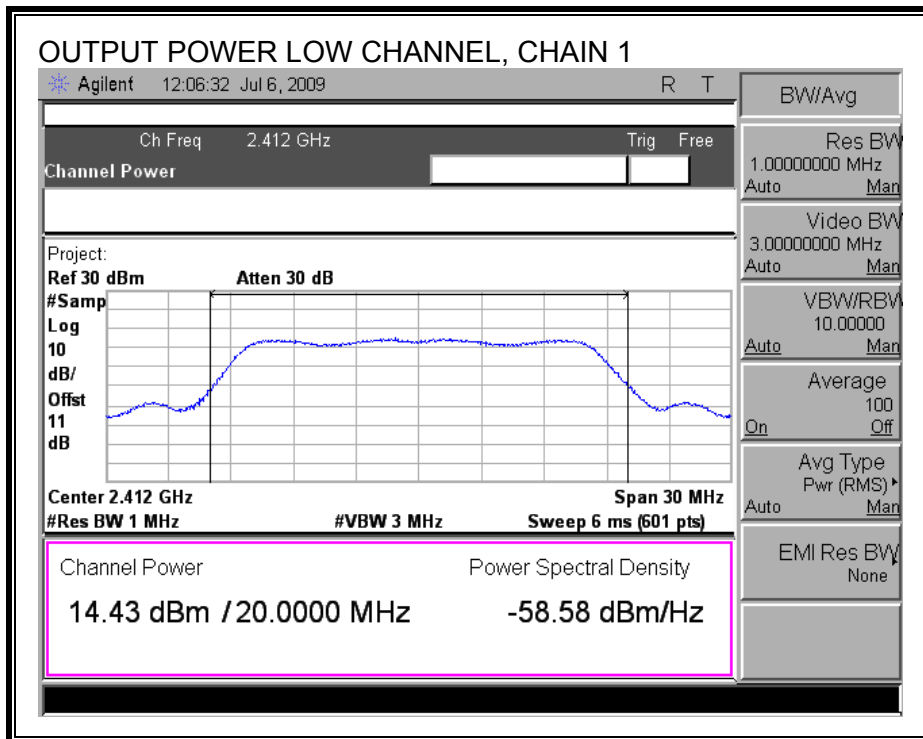
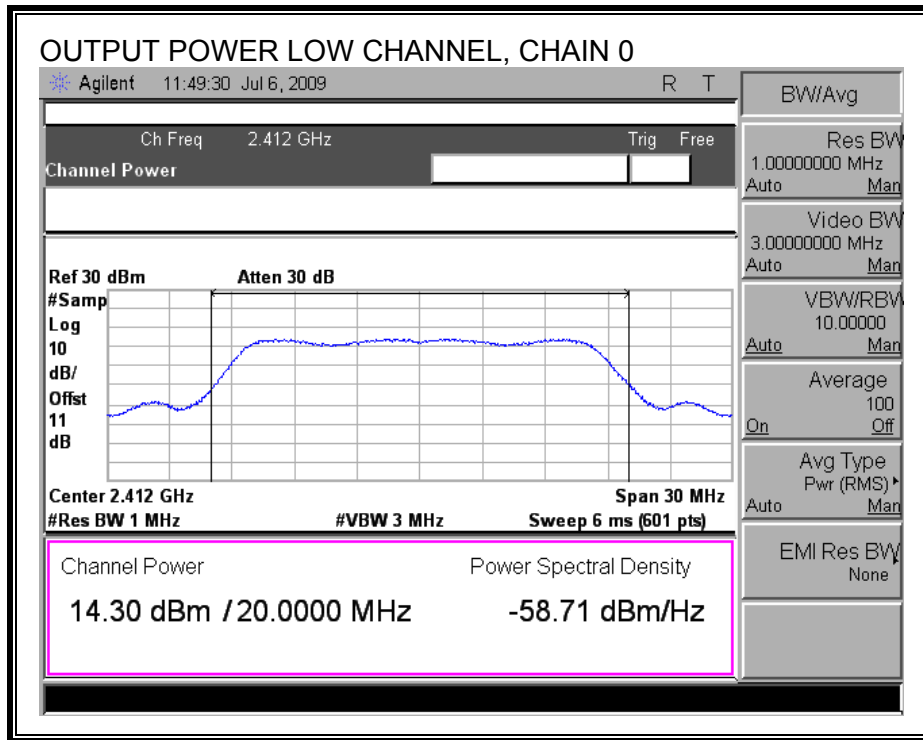

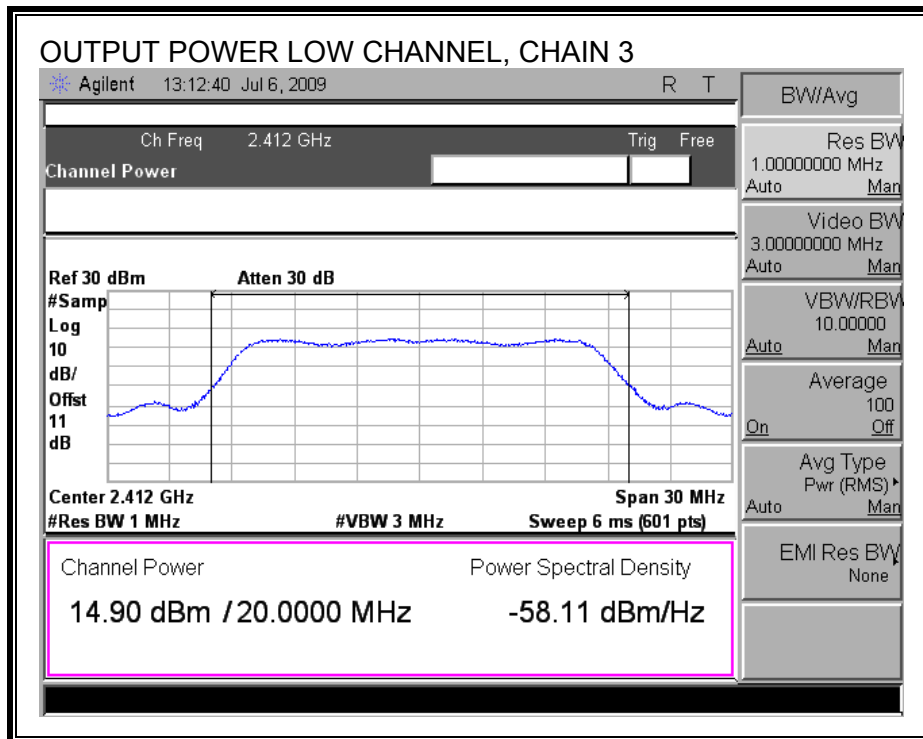
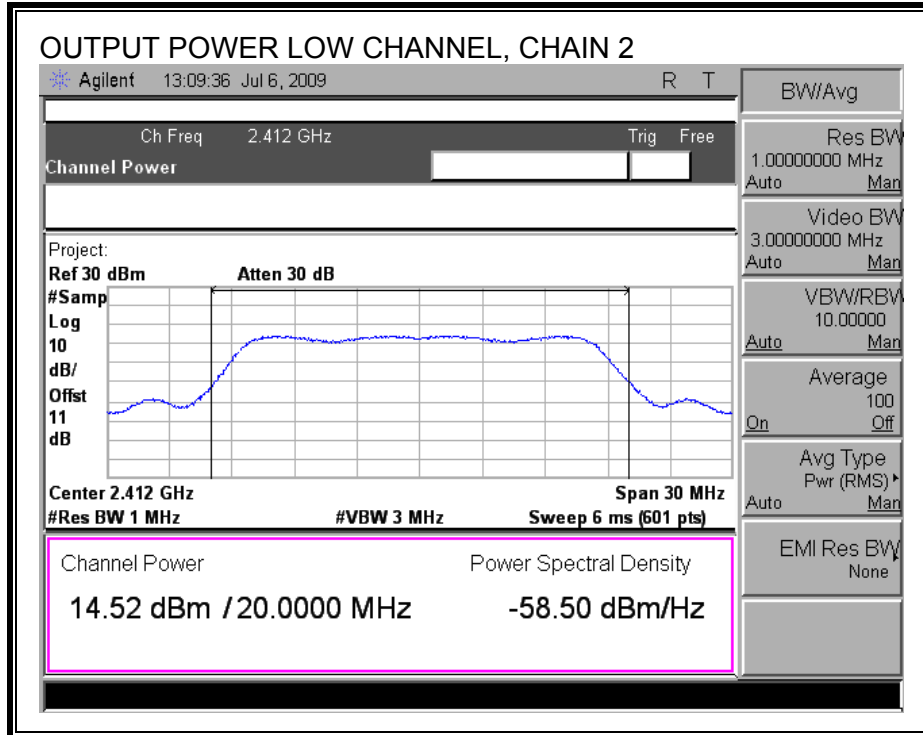

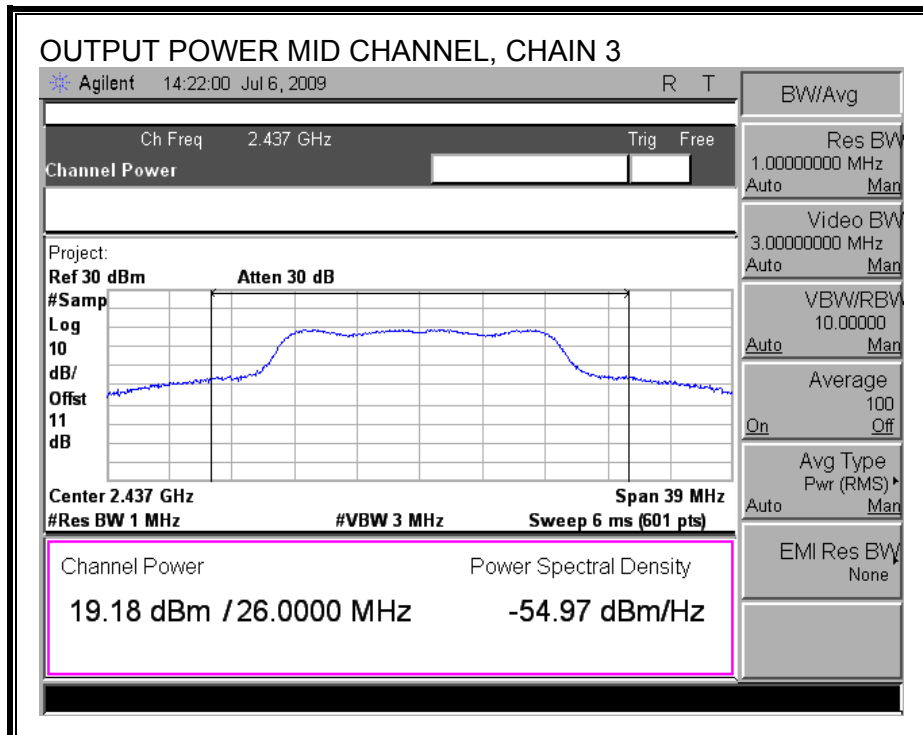
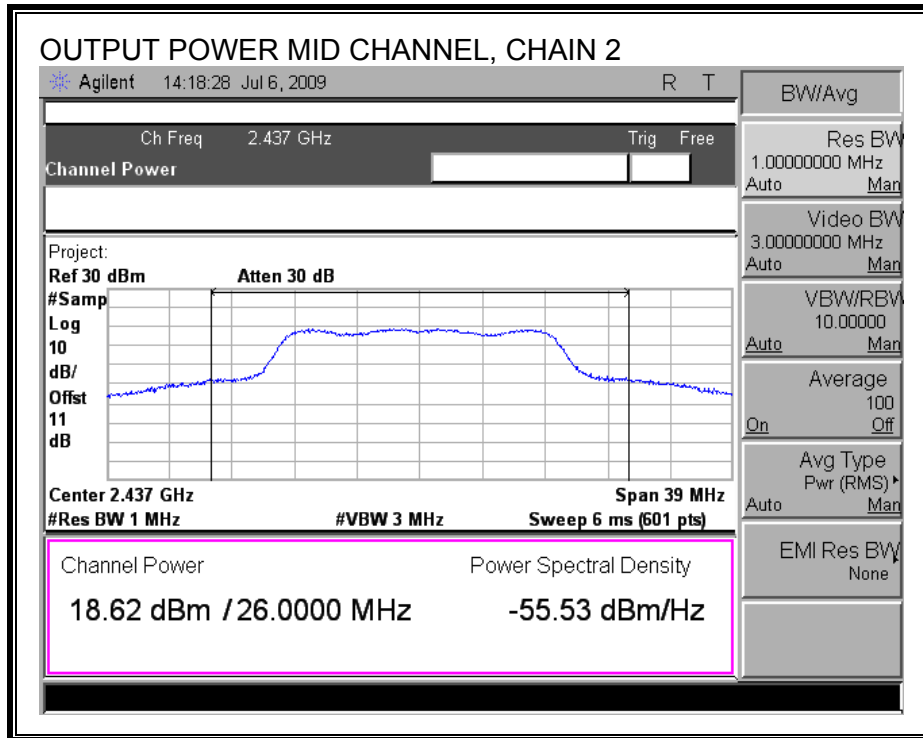

OUTPUT POWER, HIGH CHANNEL

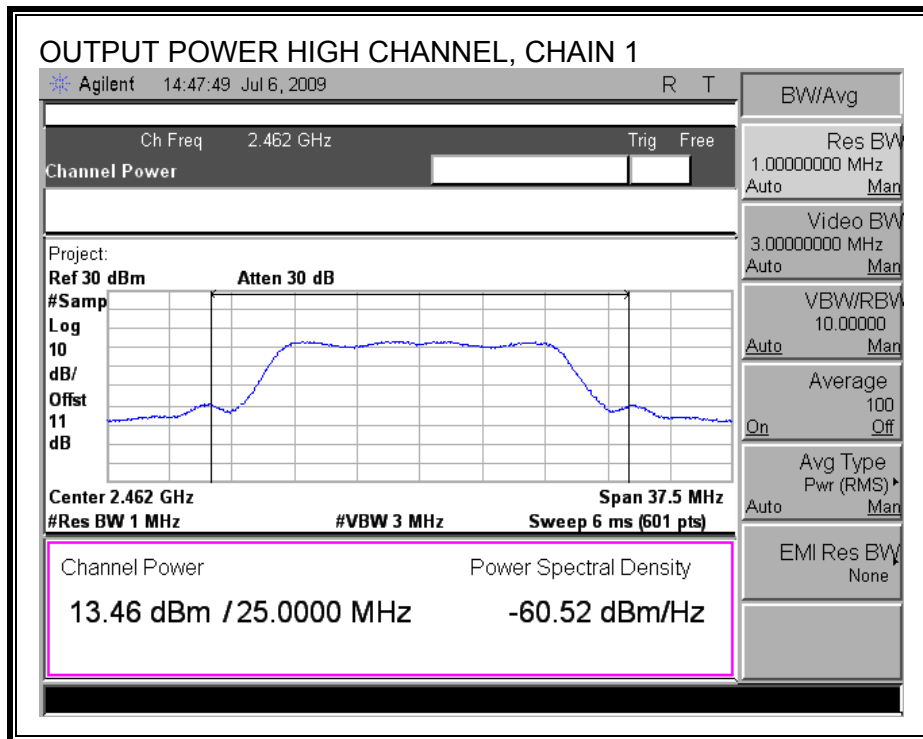
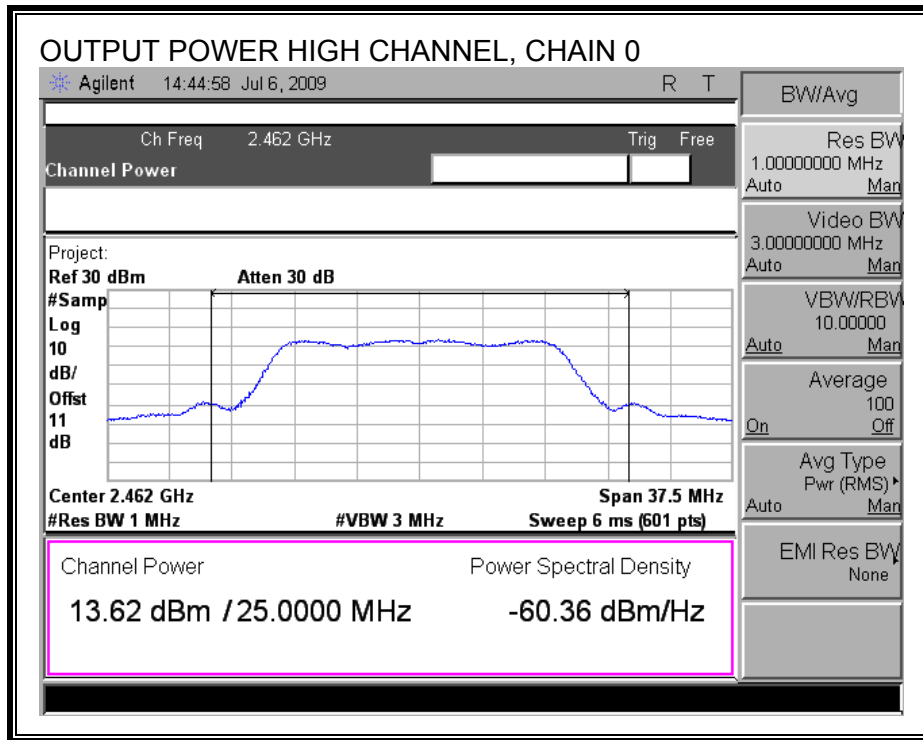

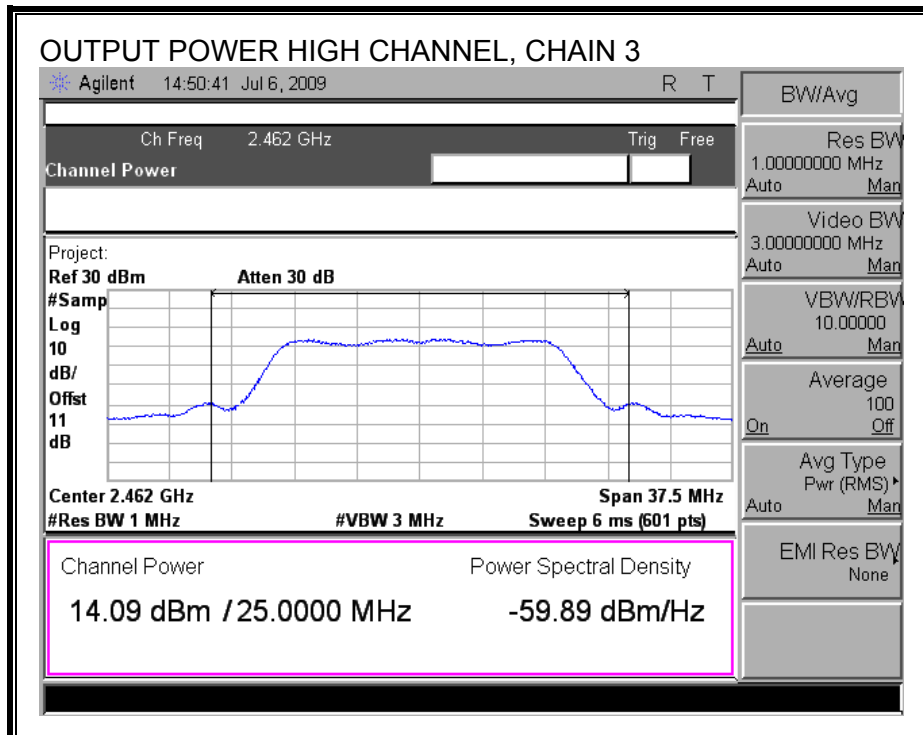
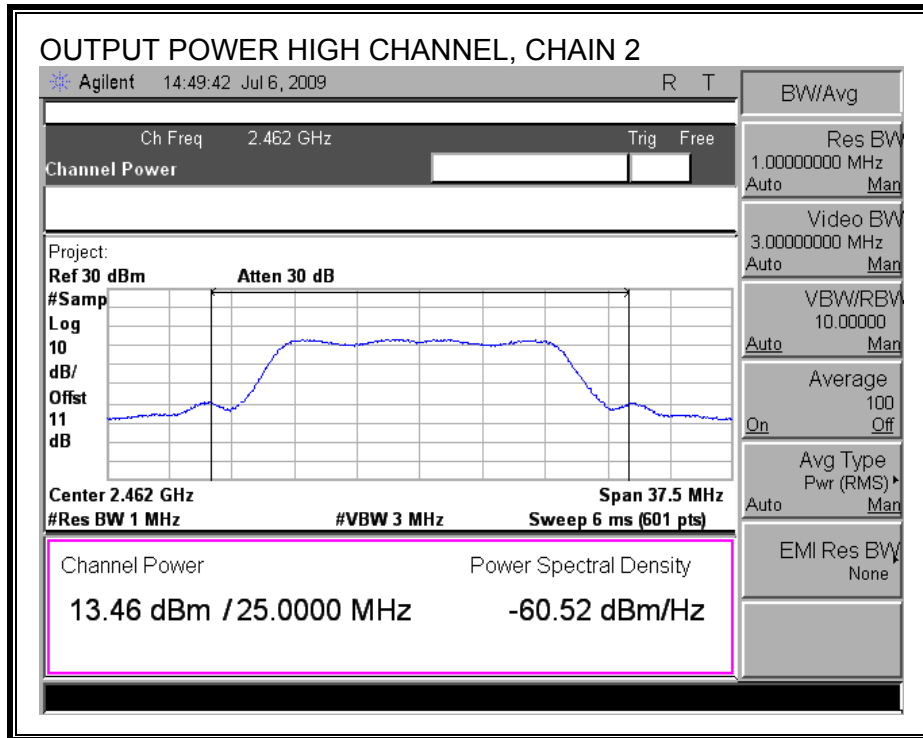

7.2.4. AVERAGE POWER

LIMITS

None; for reporting purposes only.

TEST PROCEDURE

The transmitter output is connected to a power meter.

The cable assembly insertion loss of 11 dB (including 10 dB pad and 1 dB cable) was entered as an offset in the power meter to allow for direct reading of power.

RESULTS

Channel	Frequency (MHz)	Chain 0 Power (dBm)	Chain 1 Power (dBm)	Chain 2 Power (dBm)	Chain 3 Power (dBm)
Low	2412.00	14.54	14.48	14.25	14.68
Middle	2437.00	18.92	19.26	19.07	19.01
High	2462.00	13.64	13.58	13.89	14.03

7.2.5. POWER SPECTRAL DENSITY

LIMITS

FCC §15.247 (e)

IC RSS-210 A8.2 (b)

The power spectral density conducted from the transmitter to the antenna shall not be greater than 8 dBm in any 3 kHz band during any time interval of continuous transmission.

TEST PROCEDURE

Output power was measured based on the use of RMS averaging over a time interval, therefore the power spectral density was measured using PSD Option 2 in accordance with FCC document "Measurement of Digital Transmission Systems Operating under Section 15.247", March 23, 2005.

Preliminary tests on individual chains, and on all chains with a combiner, were performed. The worst-case configuration was with a combiner, therefore final test were performed with all chains feeding a combiner.

RESULTS

Channel	Frequency (MHz)	PSD with Combiner (dBm)	Limit (dBm)	Margin (dB)
Low	2412	-12.25	8	-20.25
Middle	2437	-5.59	8	-13.59
High	2462	-10.85	8	-18.85

POWER SPECTRAL DENSITY

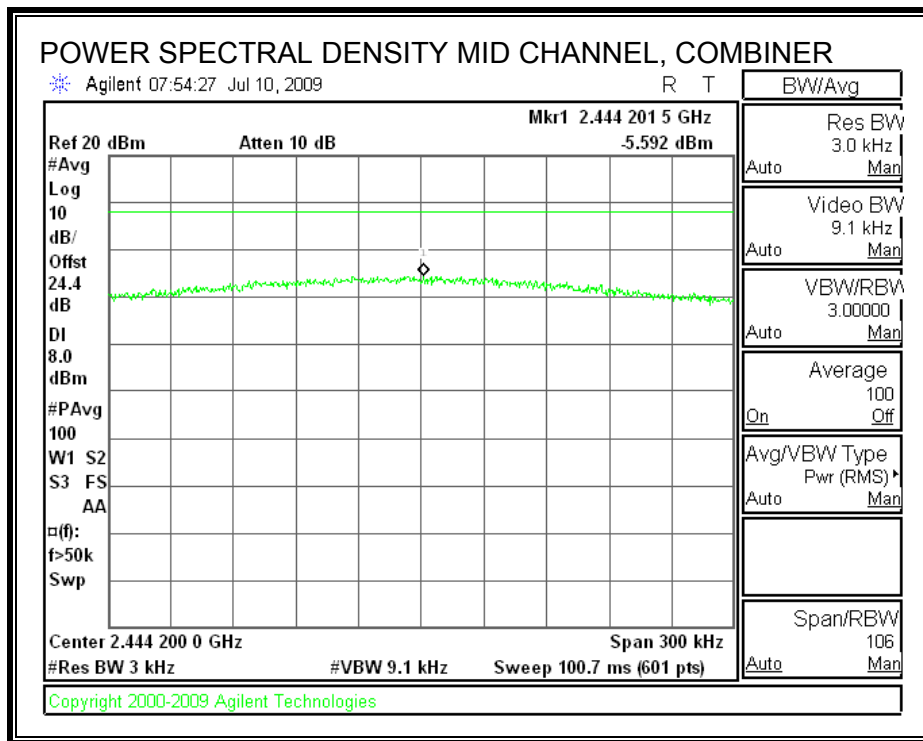
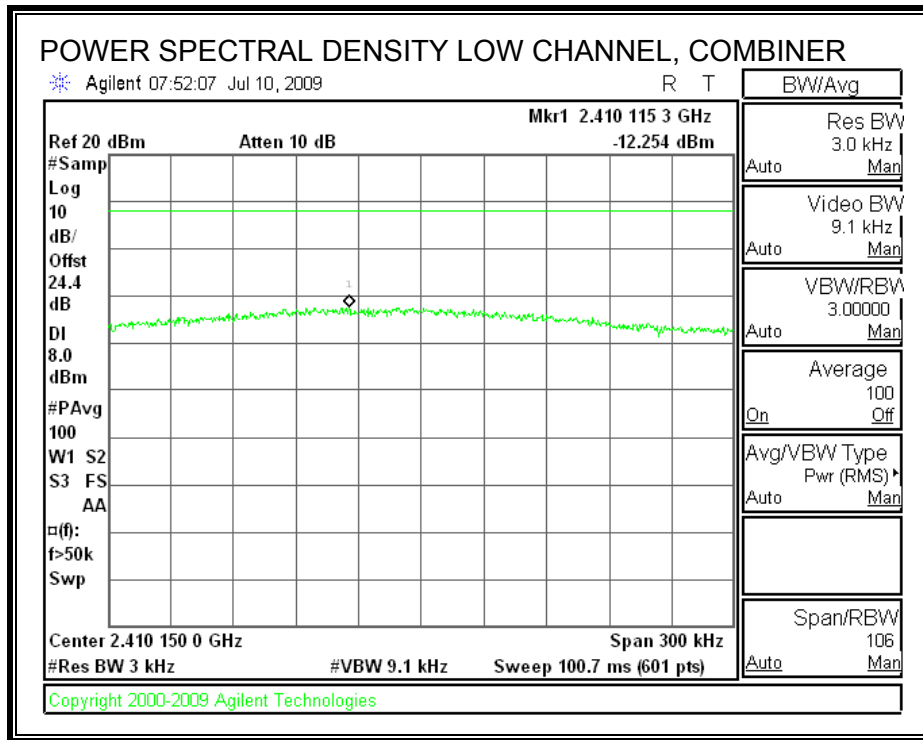

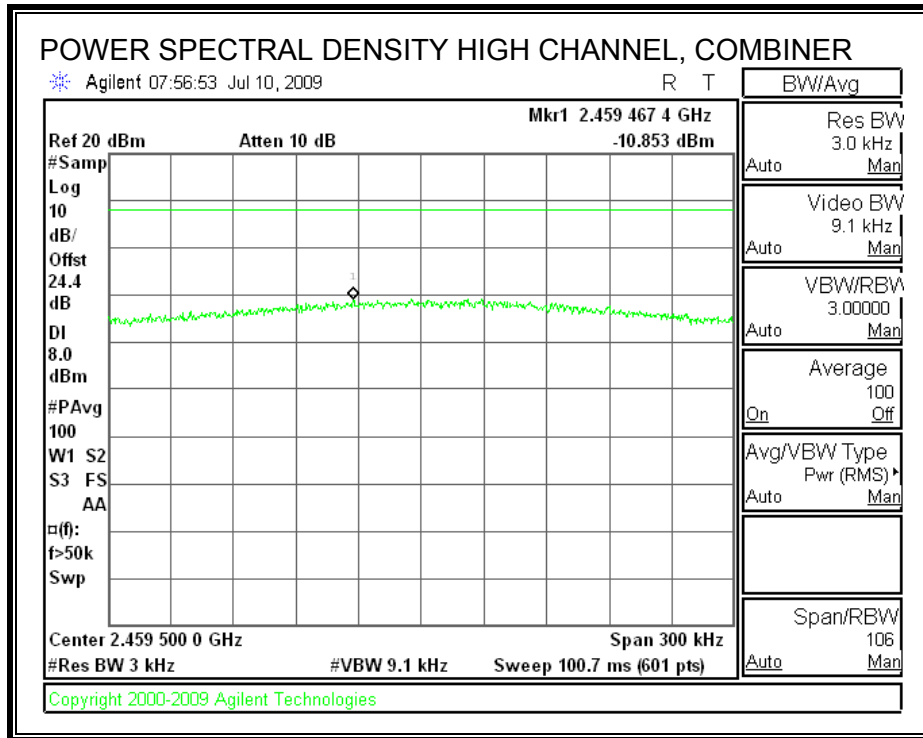

7.2.6. CONDUCTED SPURIOUS EMISSIONS

LIMITS

FCC §15.247 (d)

IC RSS-210 A8.5

Output power was measured based on the use of RMS averaging over a time interval, therefore the required attenuation is 30 dBc.

TEST PROCEDURE

The transmitter output is connected to a spectrum analyzer. The resolution bandwidth is set to 100 kHz. The video bandwidth is set to 300 kHz.

The spectrum from 30 MHz to 26 GHz is investigated with the transmitter set to the lowest, middle, and highest channels.

Preliminary tests on individual chains, and on all chains with a combiner, were performed. The worst-case configuration was with a combiner, therefore final test were performed with all chains feeding a combiner.

LOW CHANNEL SPURIOUS EMISSIONS

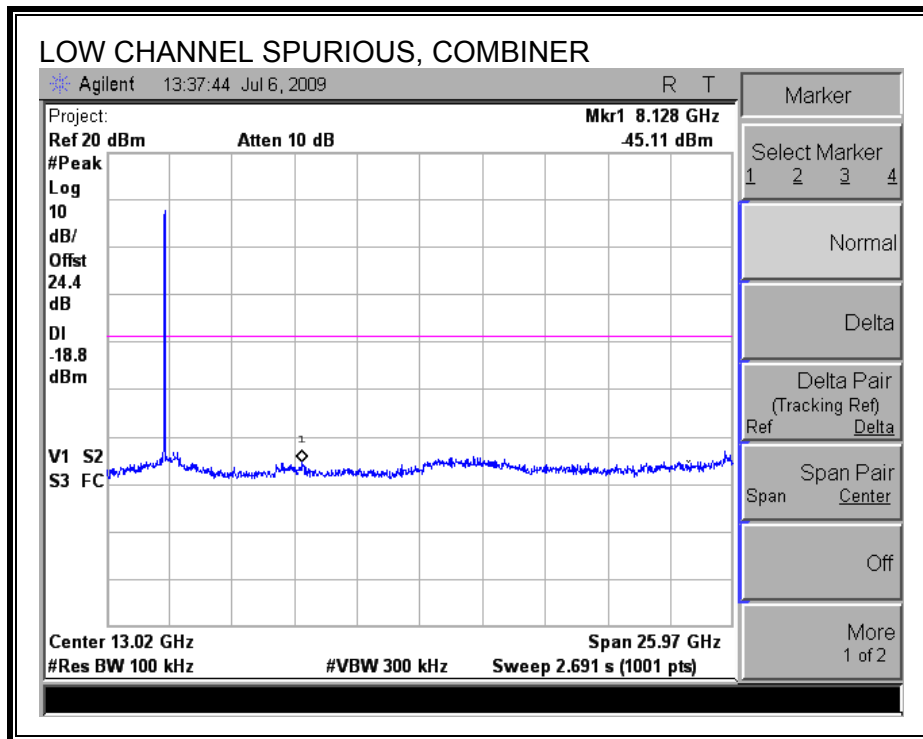
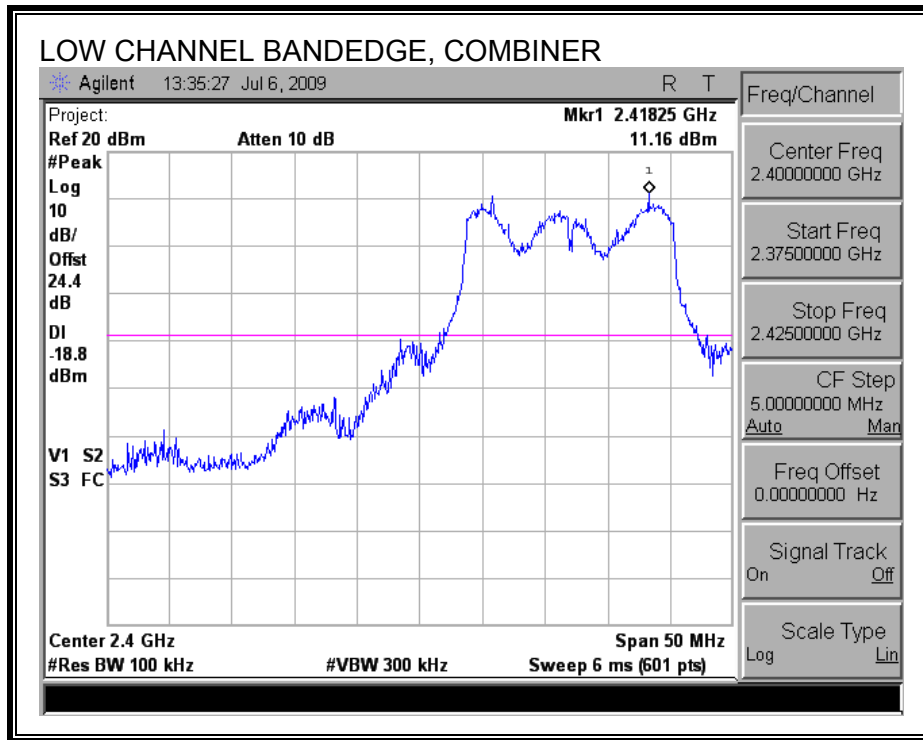

MID CHANNEL SPURIOUS EMISSIONS

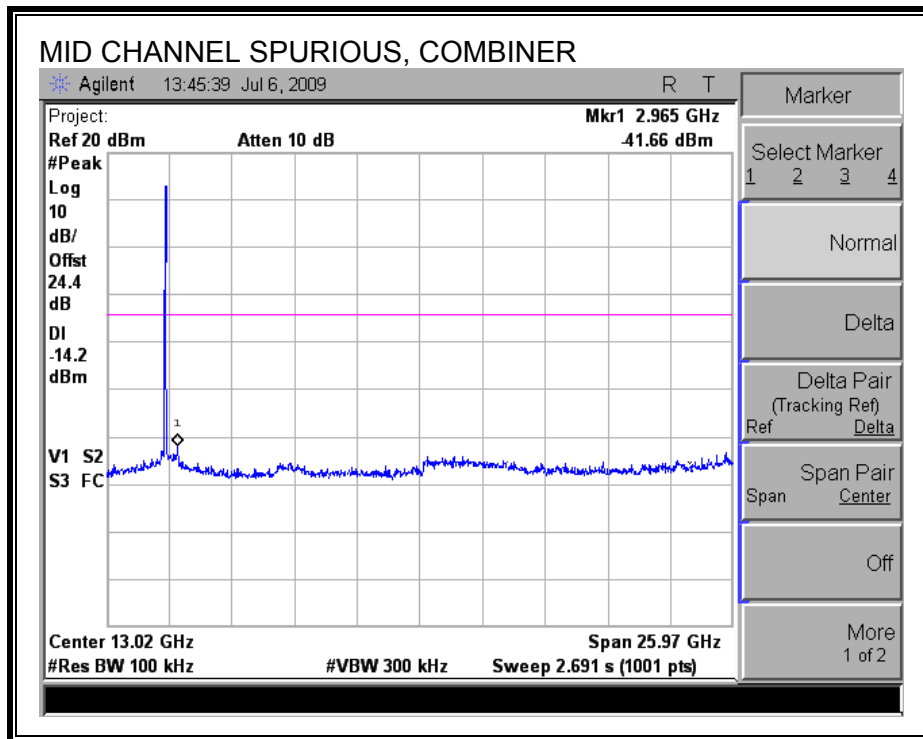
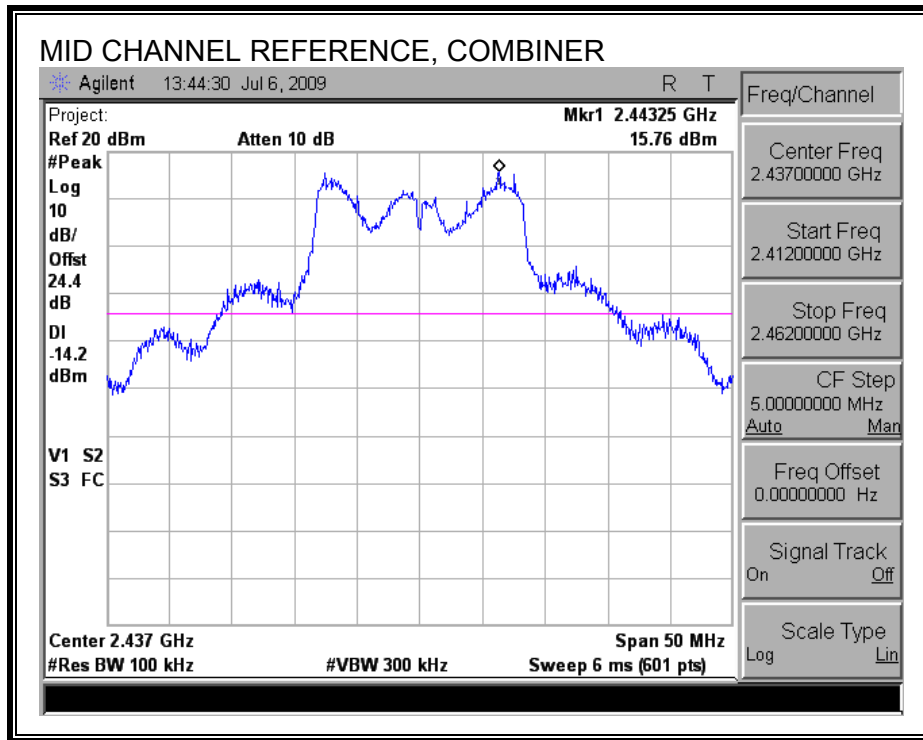

HIGH CHANNEL SPURIOUS EMISSIONS

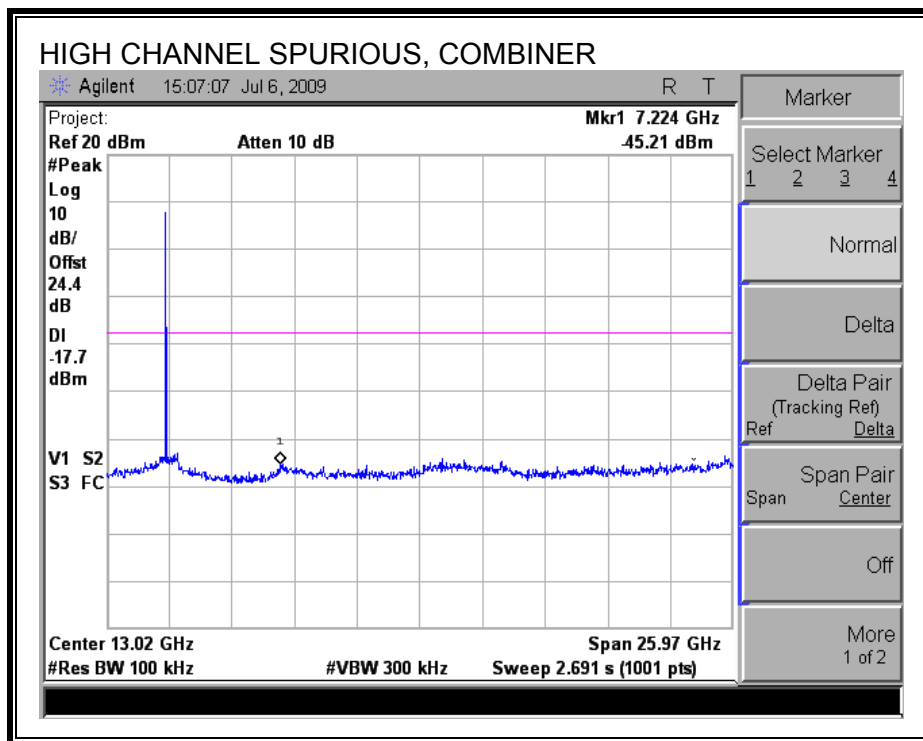
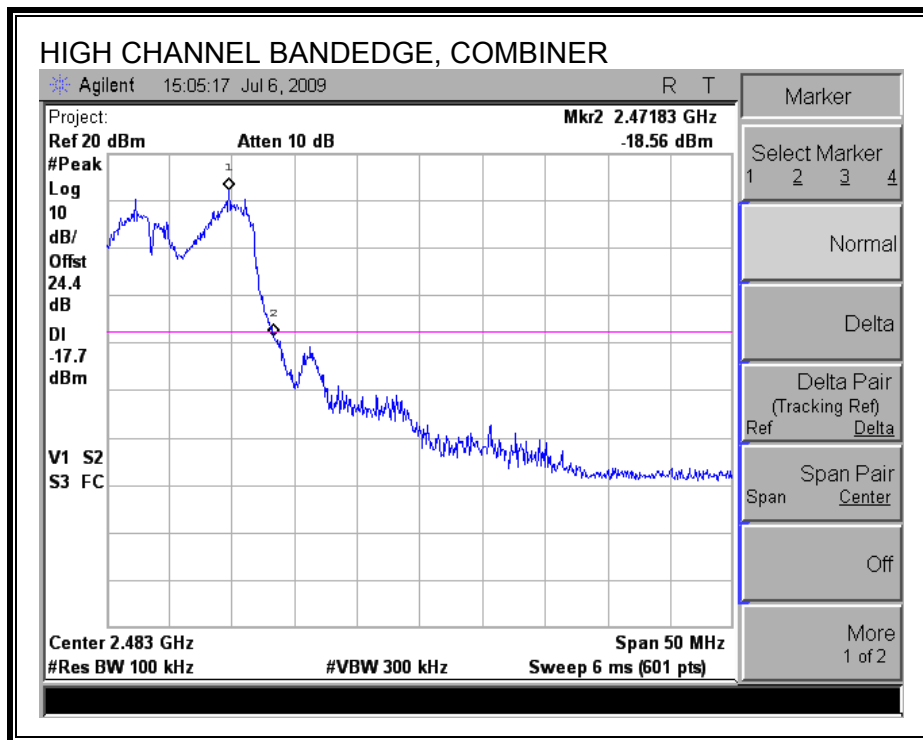

7.3. 2.4 GHz BAND CHANNEL TESTS FOR 802.11n HT20 MODE

7.3.1. 6 dB BANDWIDTH

LIMITS

FCC §15.247 (a) (2)

IC RSS-210 A8.2 (a)

The minimum 6 dB bandwidth shall be at least 500 kHz.

TEST PROCEDURE

The transmitter output is connected to a spectrum analyzer. The RBW is set to 100 kHz and the VBW is set to 300 kHz. The sweep time is coupled.

RESULTS

Channel	Frequency (MHz)	6 dB BW (MHz)	Minimum Limit (MHz)
Low	2412	17.08	0.5
Middle	2437	17.08	0.5
High	2462	16.08	0.5

6 dB BANDWIDTH

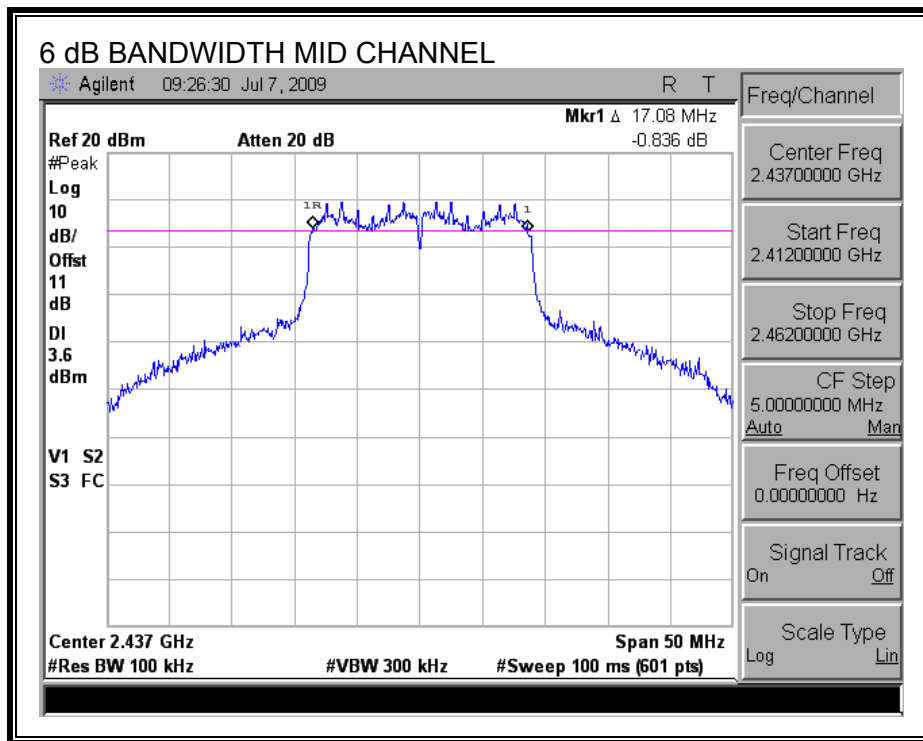
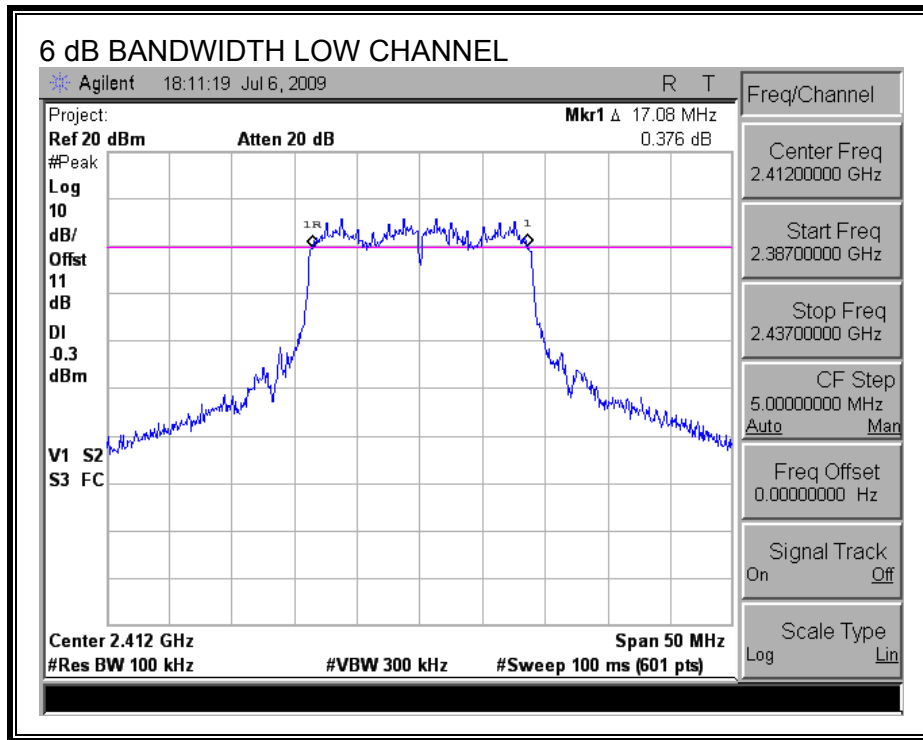

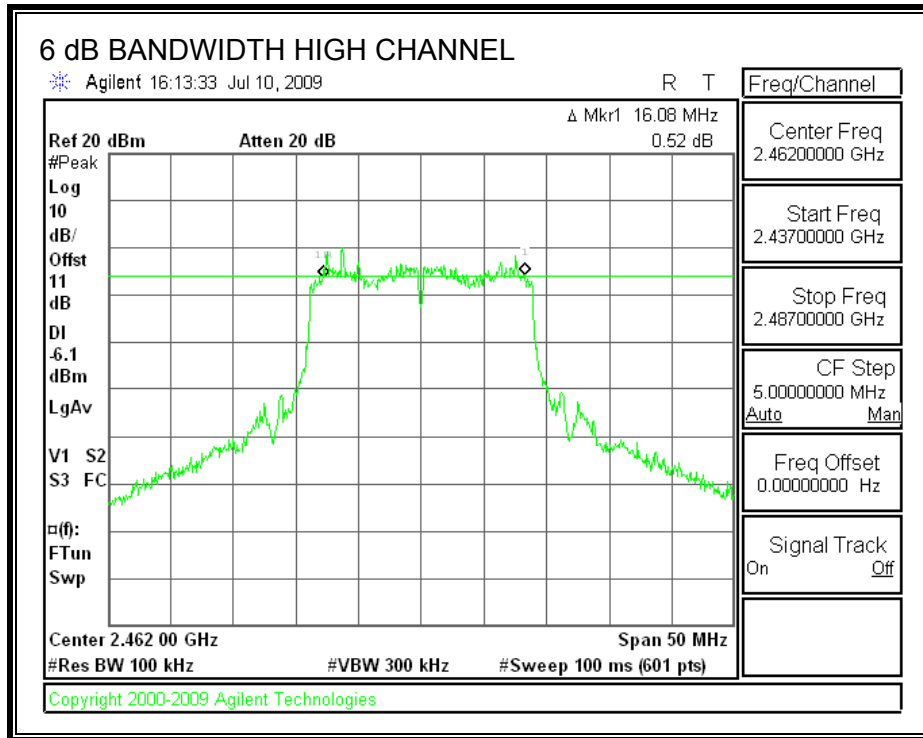

7.3.2. 99% & 26 dB BANDWIDTH

LIMITS

None; for reporting purposes only.

TEST PROCEDURE

The transmitter output is connected to the spectrum analyzer. The RBW is set to 1% to 3% of the bandwidth. The VBW is set to 3 times the RBW. The sweep time is coupled. The spectrum analyzer internal bandwidth measurement function is utilized.

RESULTS

Channel	Frequency (MHz)	99% OBW (MHz)	26 dB BW (MHz)
Low	2412	17.23	18.18
Middle	2437	17.31	17.90
High	2462	17.19	18.65

99% & 26 dB BANDWIDTH

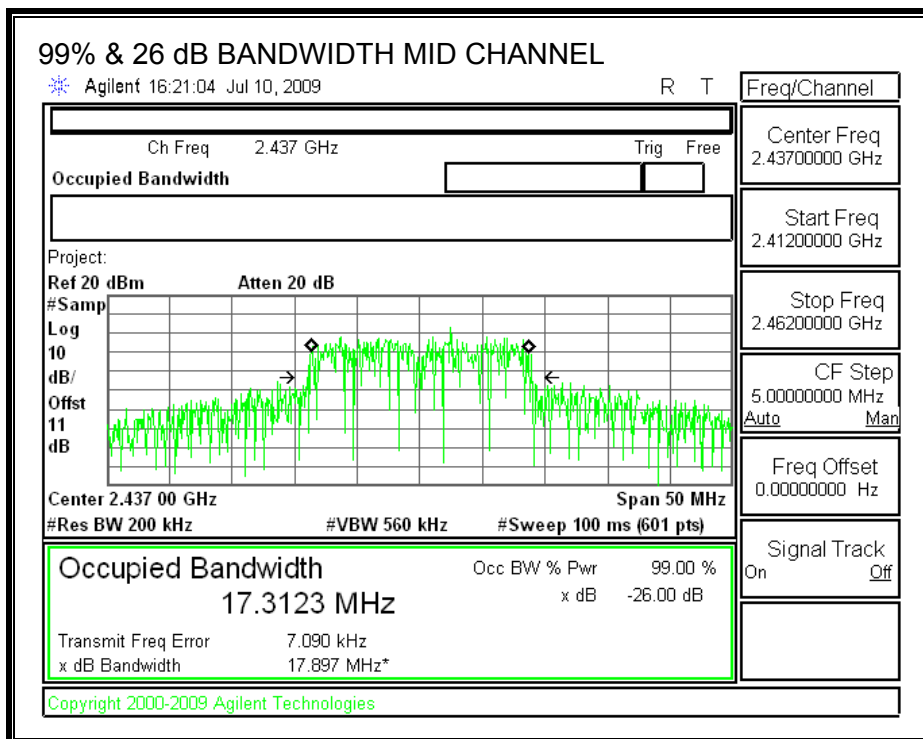
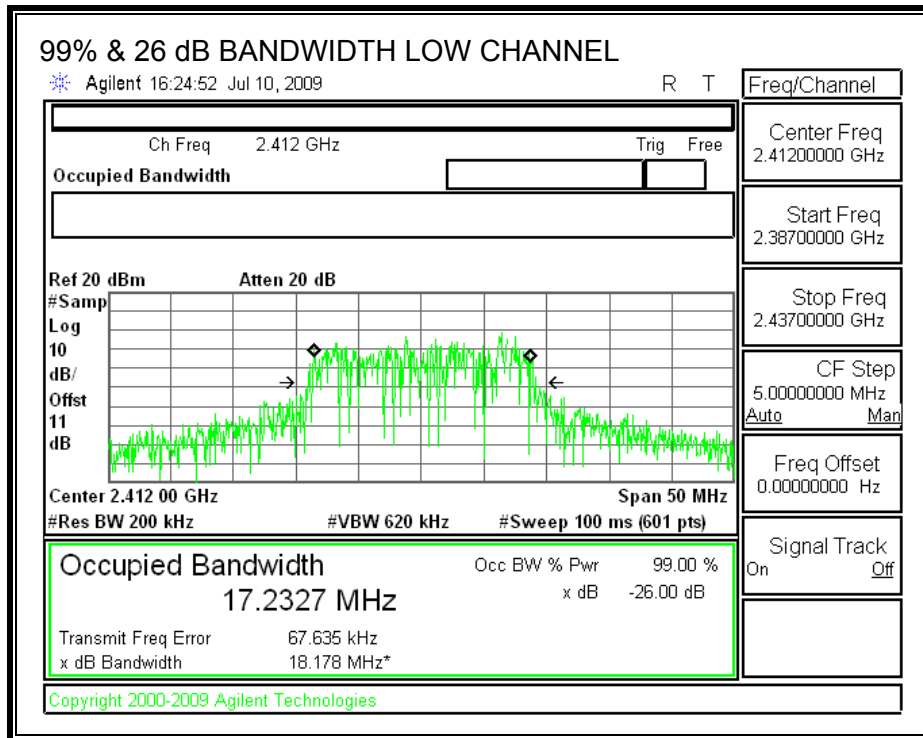

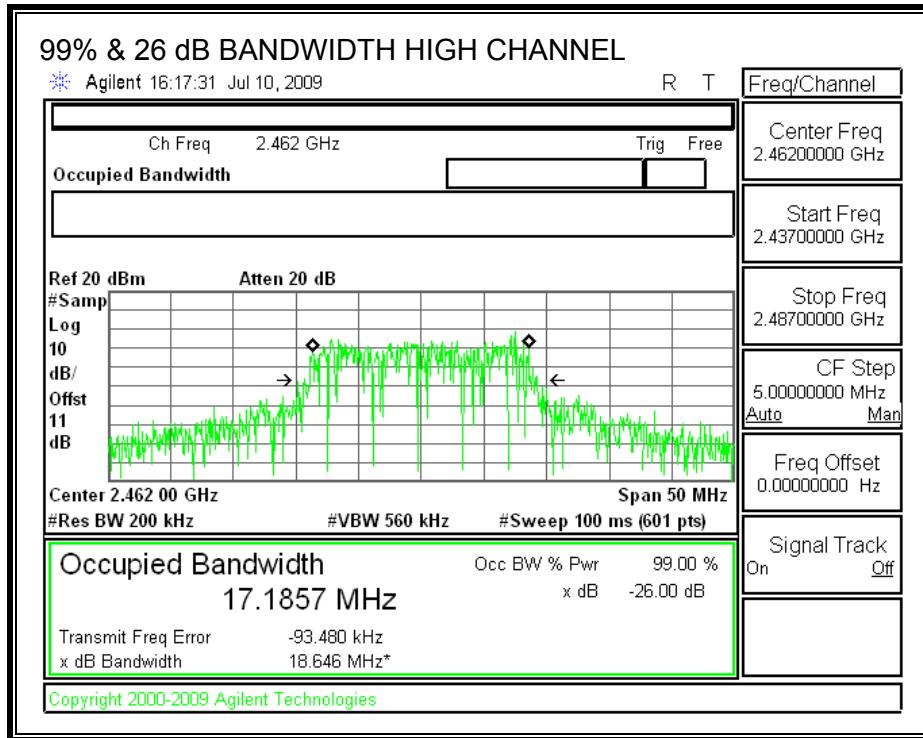

7.3.3. OUTPUT POWER

LIMITS

FCC §15.247 (b)

IC RSS-210 A8.4

TEST PROCEDURE

Output power was measured based on the use of RMS averaging over a time interval in accordance with FCC document "Measurement of Digital Transmission Systems Operating under Section 15.247", March 23, 2005.

RESULTS

The antenna gain is less than 6 dBi, therefore the limit is 30 dBm.

Channel	Frequency (MHz)	Chain 0 Power (dBm)	Chain 1 Power (dBm)	Chain 2 Power (dBm)	Chain 3 Power (dBm)	Total Power (dBm)	Limit (dBm)	Margin (dB)
Low	2412	14.23	15.17	14.67	14.68	20.72	30	-9.28
Mid	2437	18.86	19.05	19.00	18.97	24.99	30	-5.01
High	2462	14.45	14.53	14.37	14.48	20.48	30	-9.52

OUTPUT POWER, LOW CHANNEL

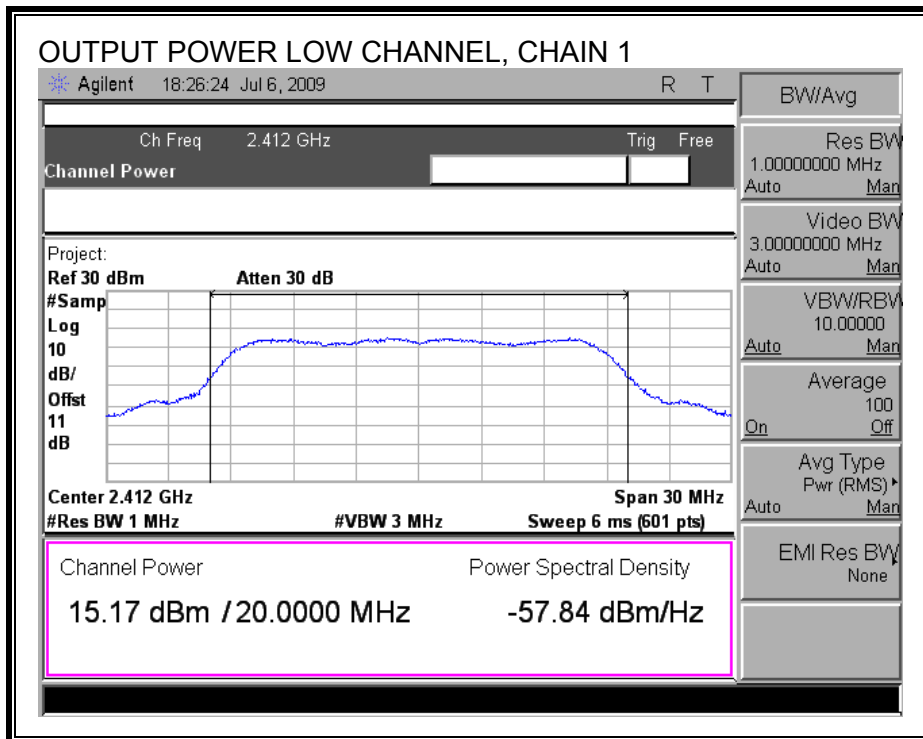
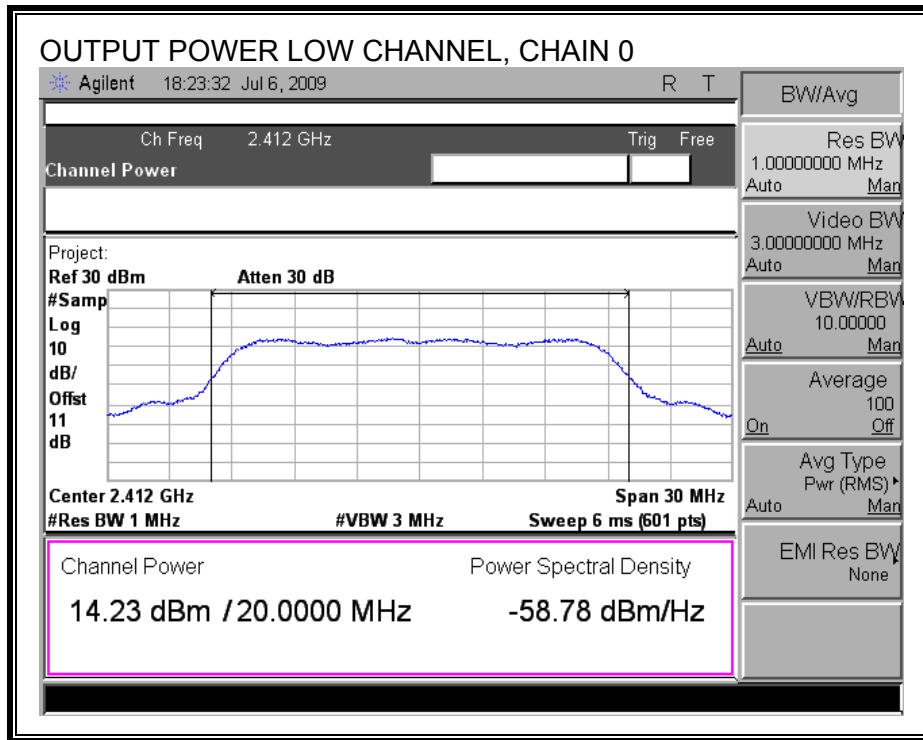

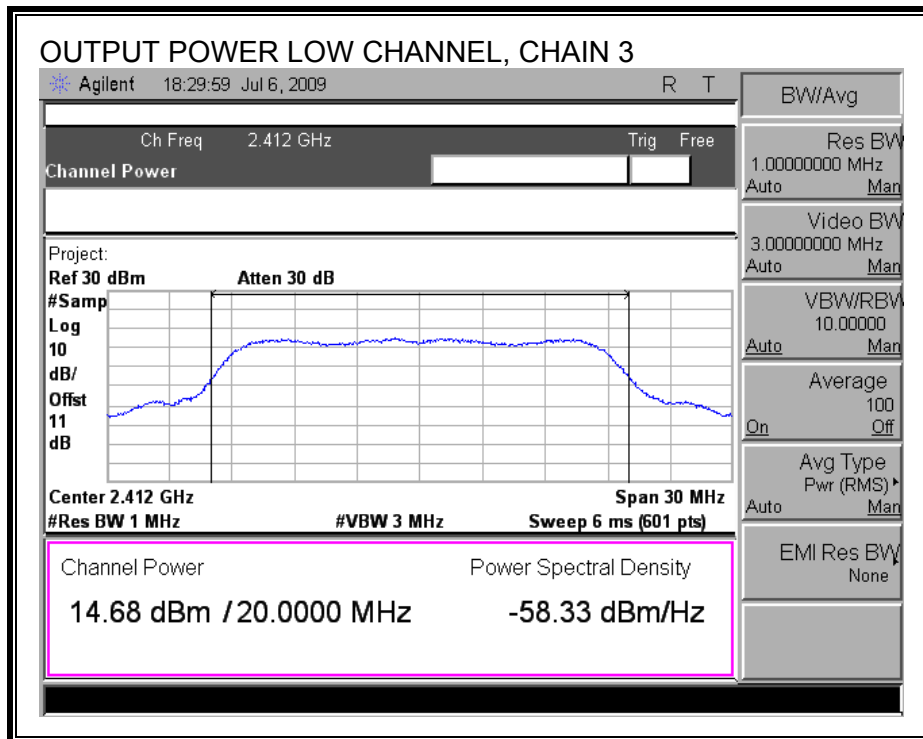
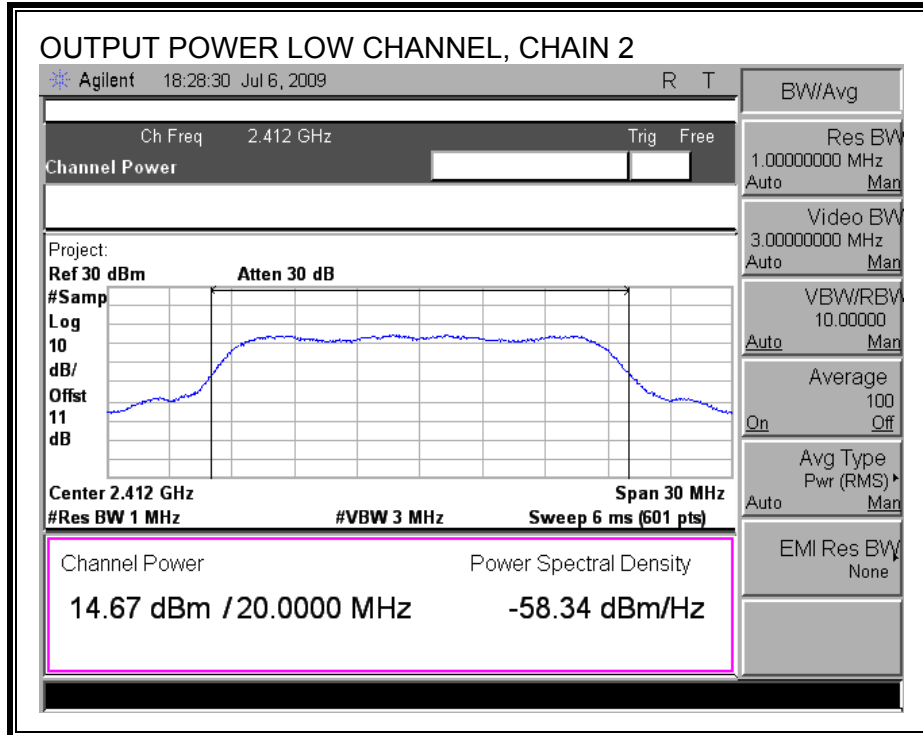

OUTPUT POWER, MID CHANNEL

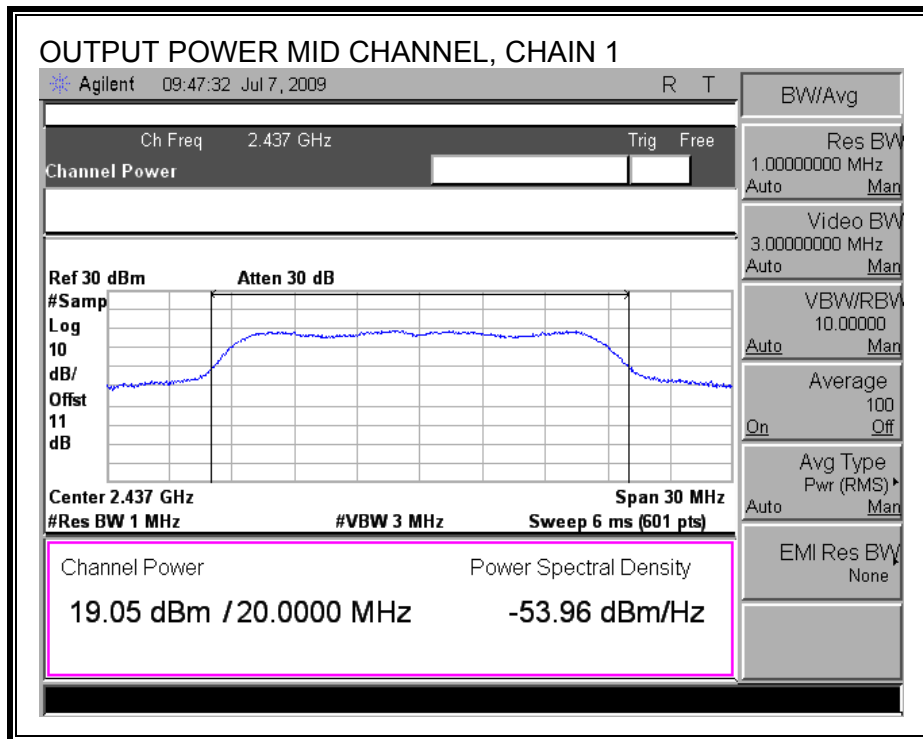
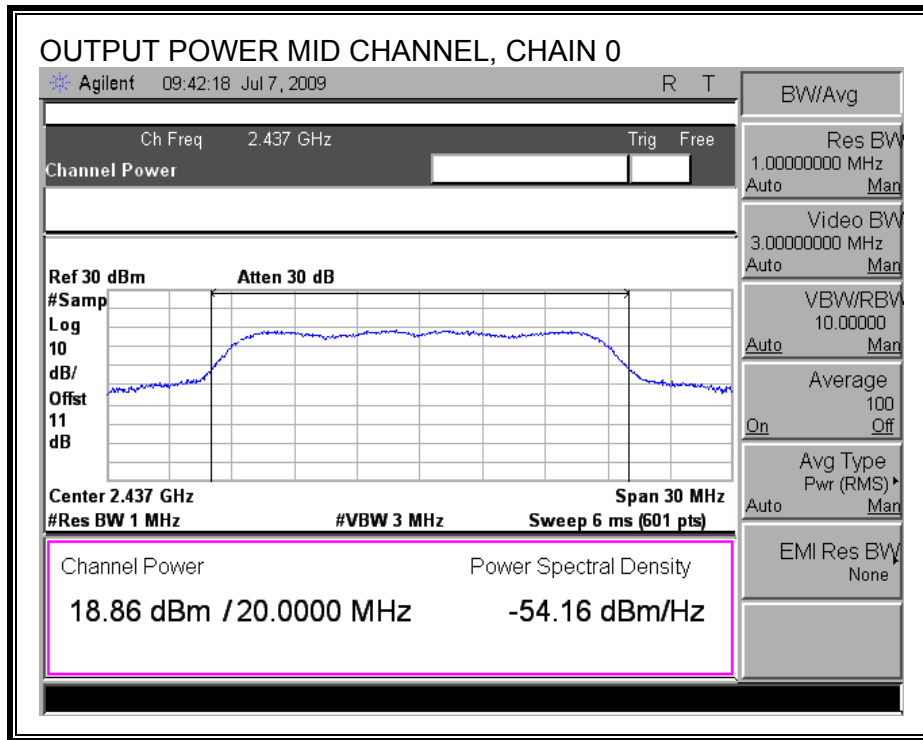

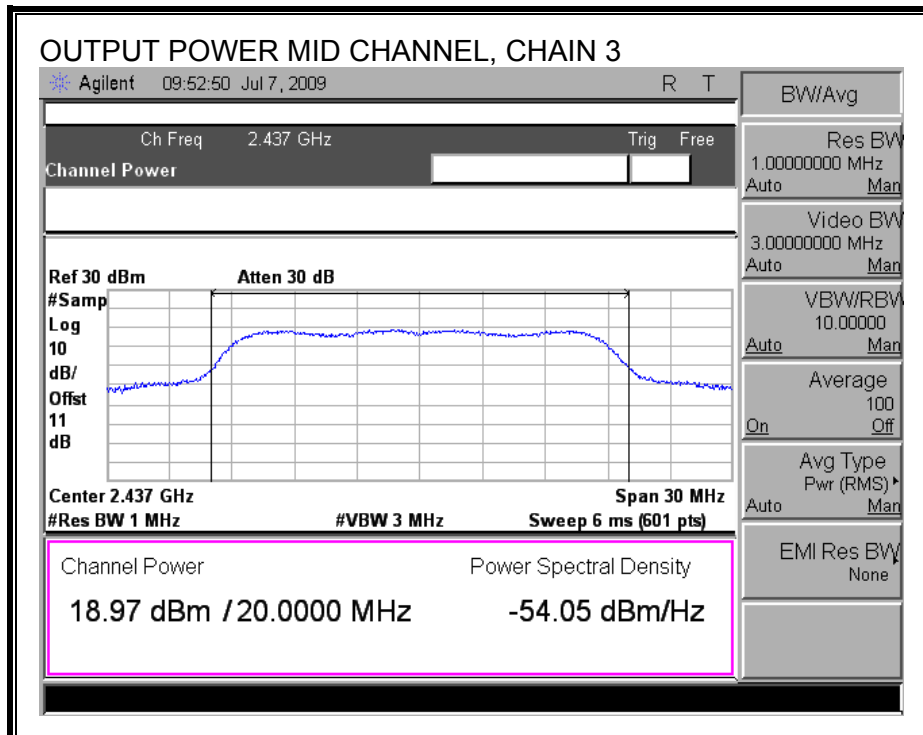
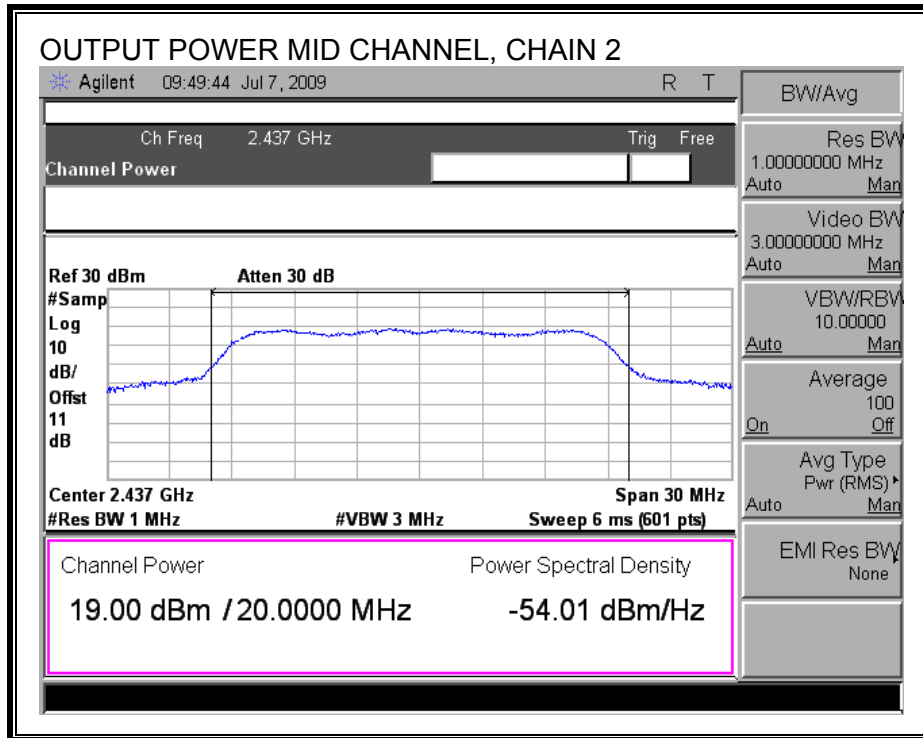

OUTPUT POWER, HIGH CHANNEL

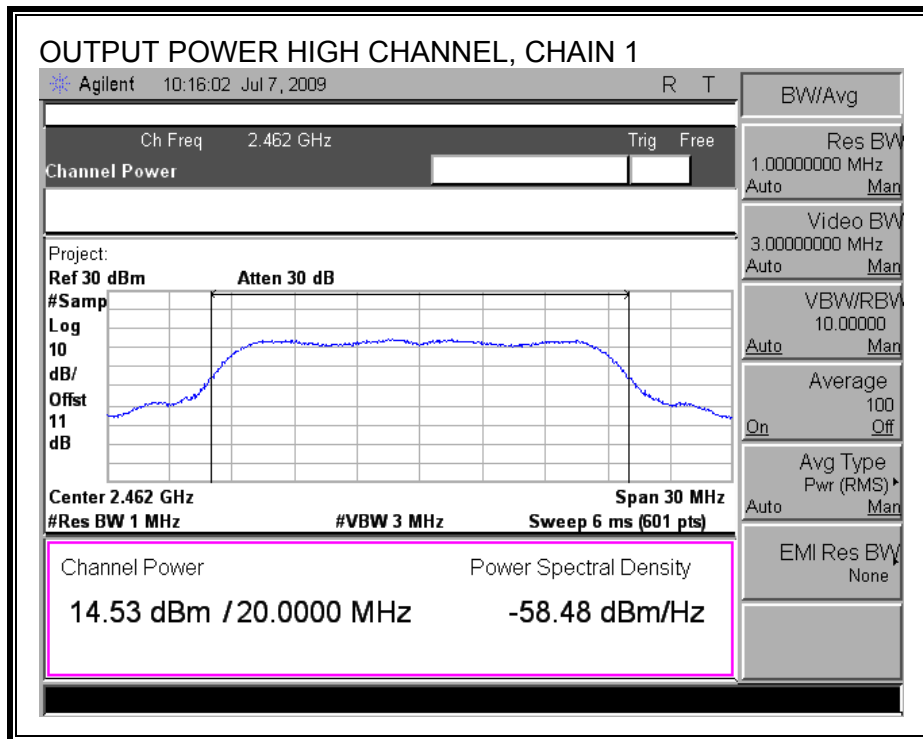
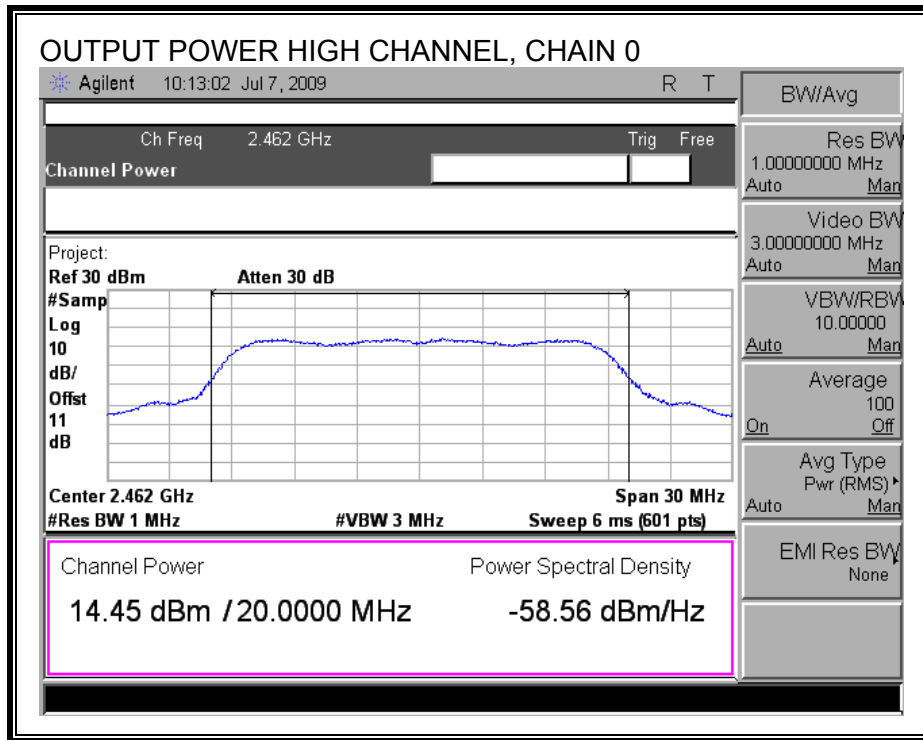

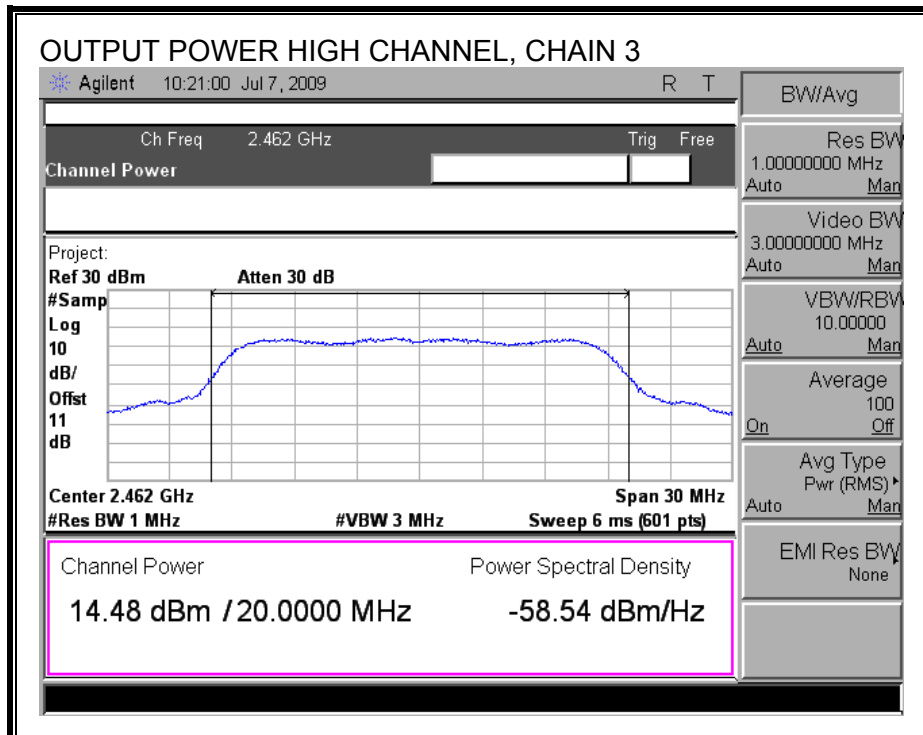
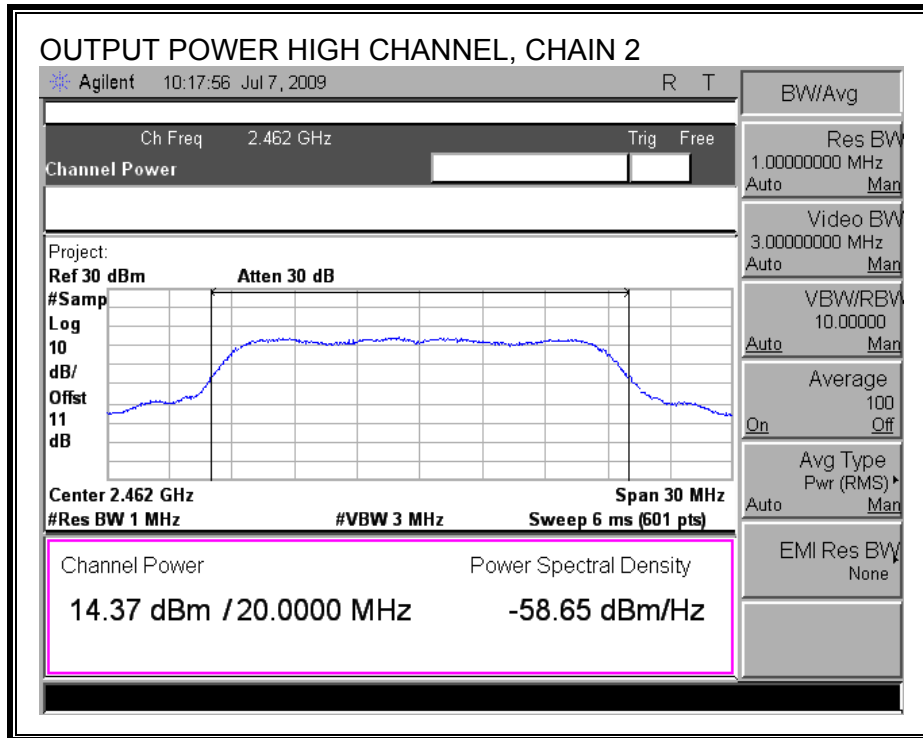

7.3.4. AVERAGE POWER

LIMITS

None; for reporting purposes only.

TEST PROCEDURE

The transmitter output is connected to a power meter.

The cable assembly insertion loss of 11 dB (including 10 dB pad and 1 dB cable) was entered as an offset in the power meter to allow for direct reading of power.

RESULTS

Channel	Frequency (MHz)	Chain 0 Power (dBm)	Chain 1 Power (dBm)	Chain 2 Power (dBm)	Chain 3 Power (dBm)
Low	2412.00	14.94	15.12	15.05	15.07
Middle	2437.00	18.98	19.17	19.01	19.10
High	2462.00	14.58	14.60	14.53	14.57

7.3.5. POWER SPECTRAL DENSITY

LIMITS

FCC §15.247 (e)

IC RSS-210 A8.2 (b)

The power spectral density conducted from the transmitter to the antenna shall not be greater than 8 dBm in any 3 kHz band during any time interval of continuous transmission.

TEST PROCEDURE

Output power was measured based on the use of RMS averaging over a time interval, therefore the power spectral density was measured using PSD Option 2 in accordance with FCC document "Measurement of Digital Transmission Systems Operating under Section 15.247", March 23, 2005.

Preliminary tests on individual chains, and on all chains with a combiner, were performed. The worst-case configuration was with a combiner, therefore final test were performed with all chains feeding a combiner.

RESULTS

Channel	Frequency (MHz)	PSD with Combiner (dBm)	Limit (dBm)	Margin (dB)
Low	2412	-22.14	8	-30.14
Middle	2437	-17.47	8	-25.47
High	2462	-26.21	8	-34.21

POWER SPECTRAL DENSITY

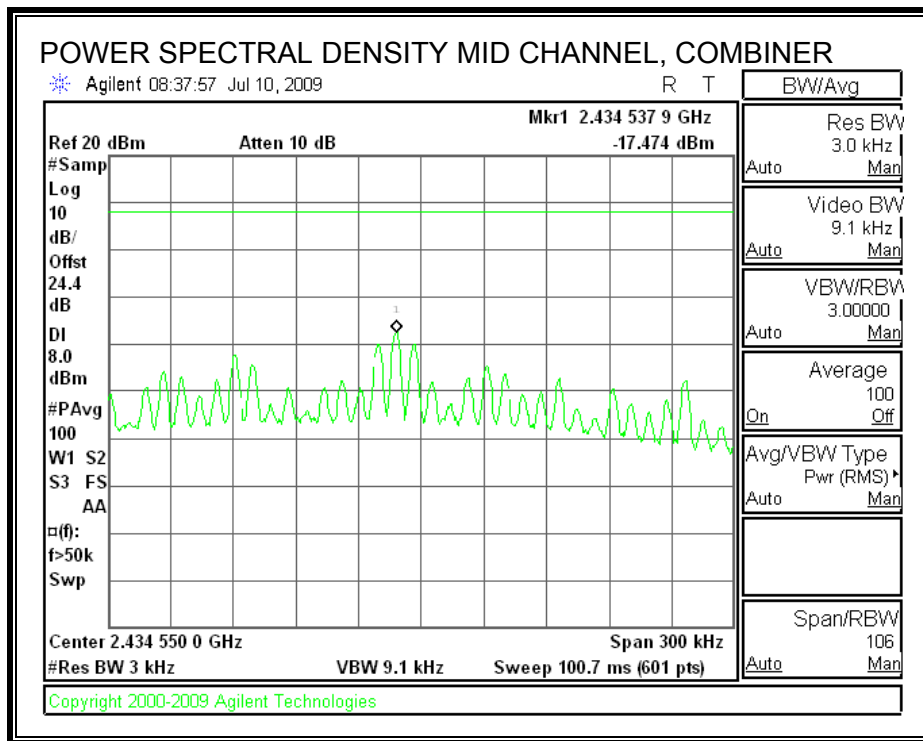
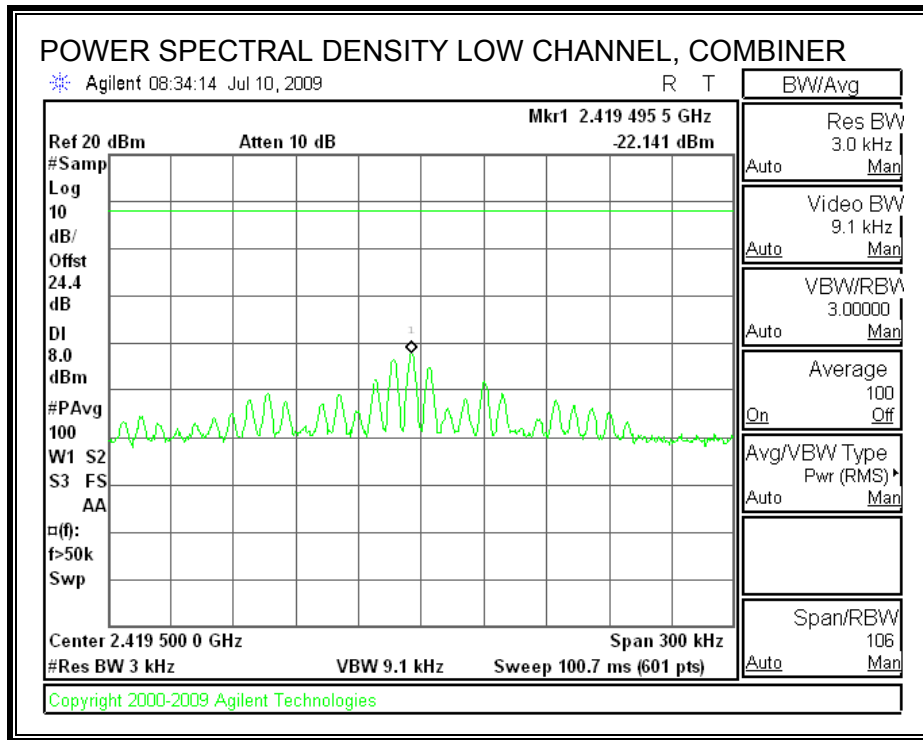

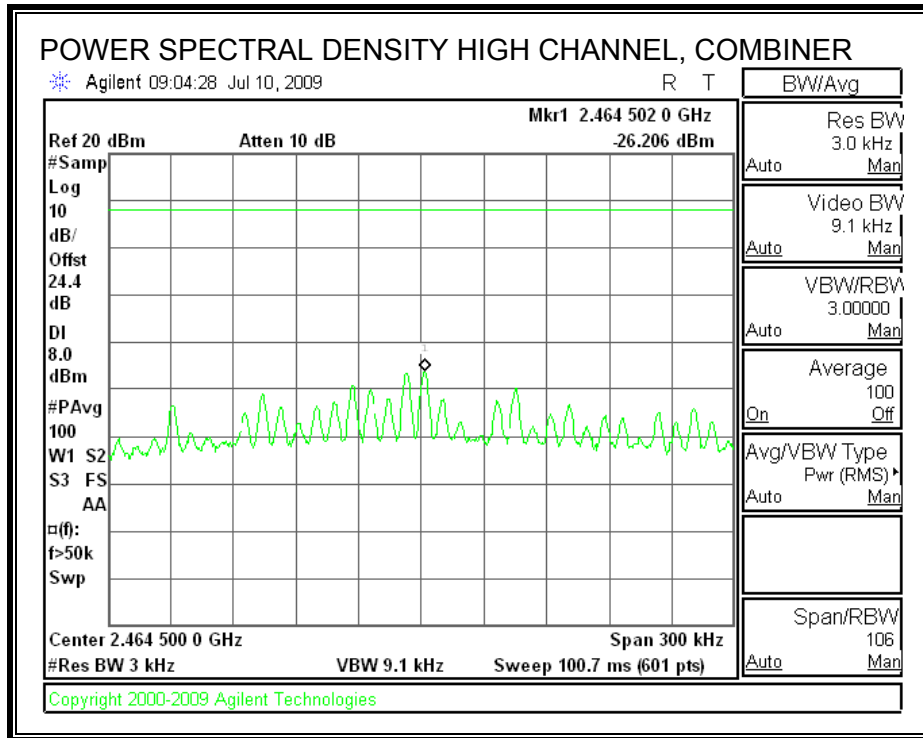

7.3.6. CONDUCTED SPURIOUS EMISSIONS

LIMITS

FCC §15.247 (d)

IC RSS-210 A8.5

Output power was measured based on the use of RMS averaging over a time interval, therefore the required attenuation is 30 dBc.

TEST PROCEDURE

The transmitter output is connected to a spectrum analyzer. The resolution bandwidth is set to 100 kHz. The video bandwidth is set to 300 kHz.

The spectrum from 30 MHz to 26 GHz is investigated with the transmitter set to the lowest, middle, and highest channels.

Preliminary tests on individual chains, and on all chains with a combiner, were performed. The worst-case configuration was with a combiner, therefore final test were performed with all chains feeding a combiner.

LOW CHANNEL SPURIOUS EMISSIONS

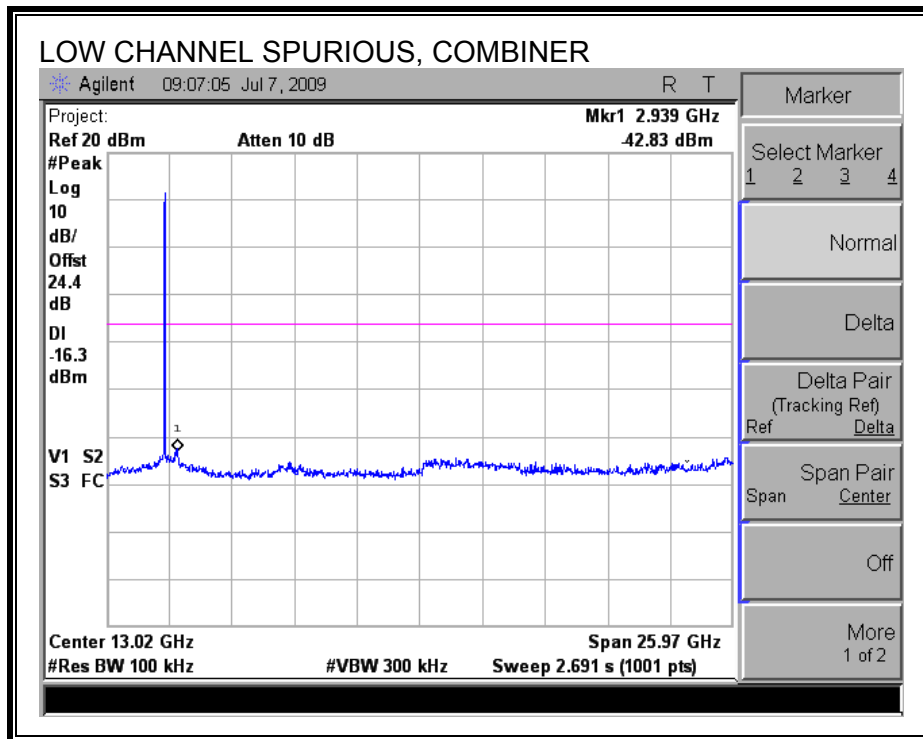
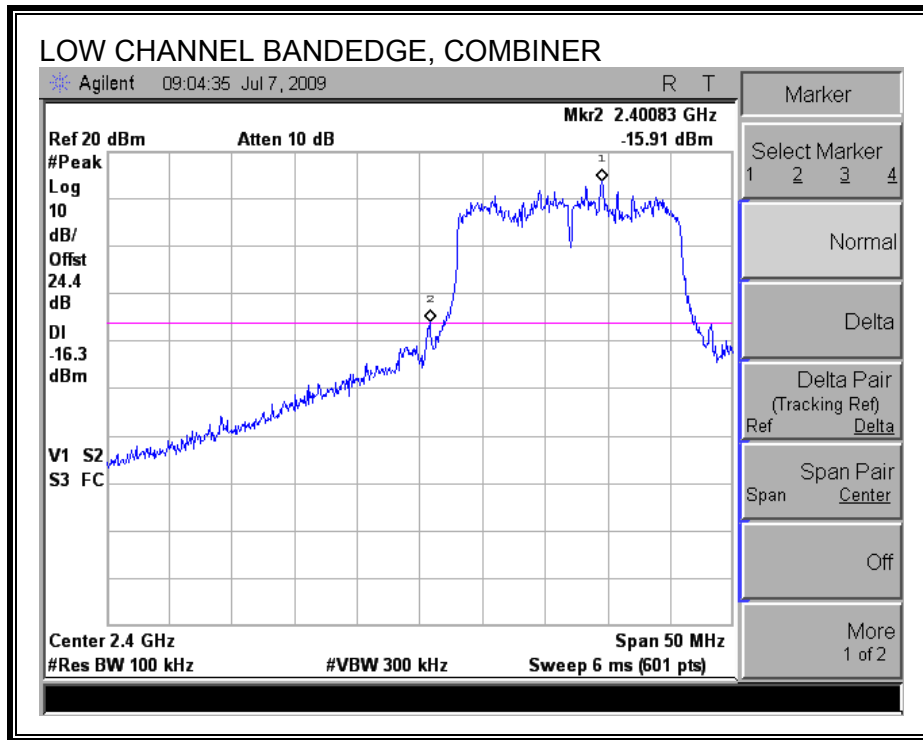

MID CHANNEL SPURIOUS EMISSIONS

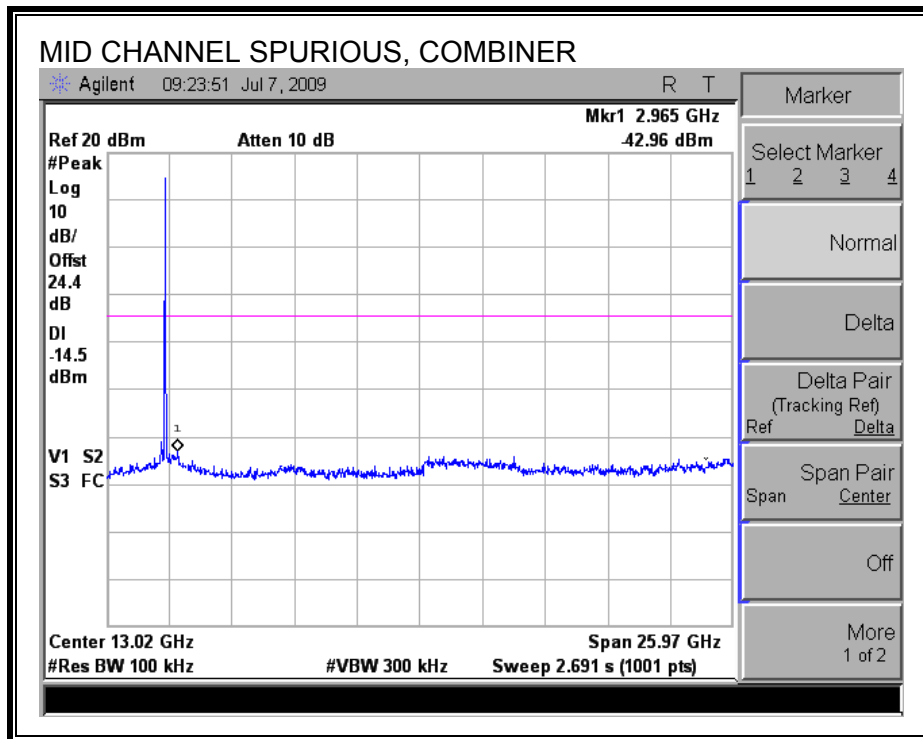
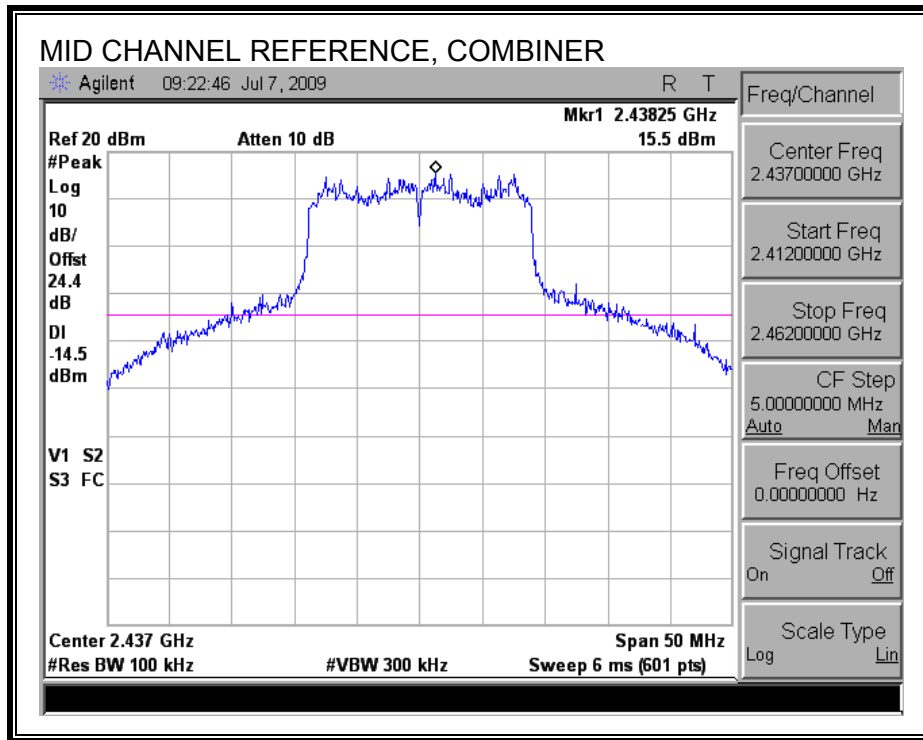

HIGH CHANNEL SPURIOUS EMISSIONS

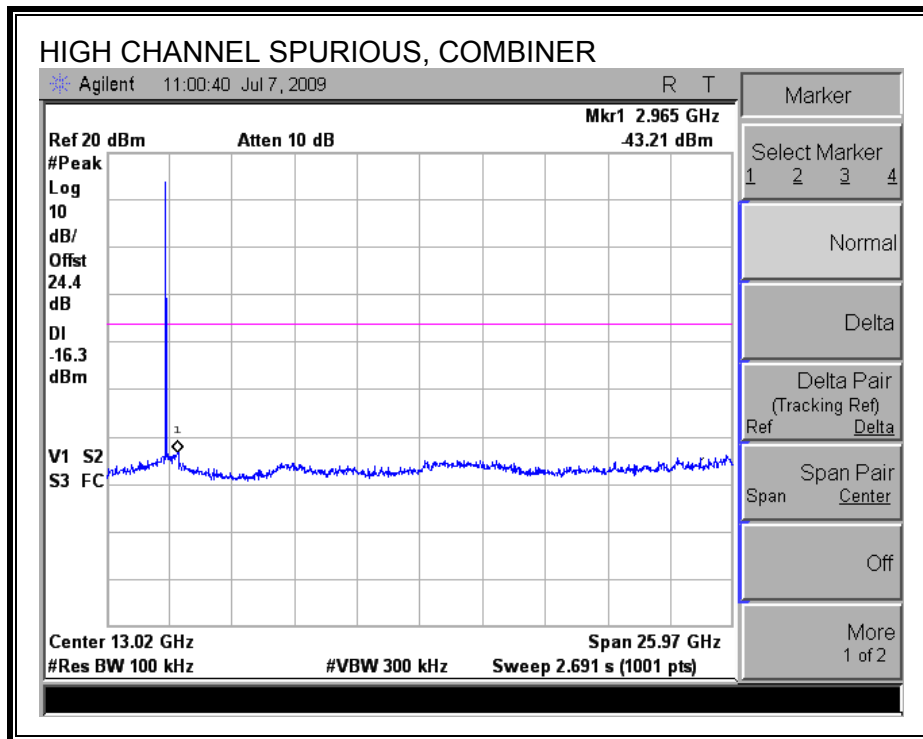
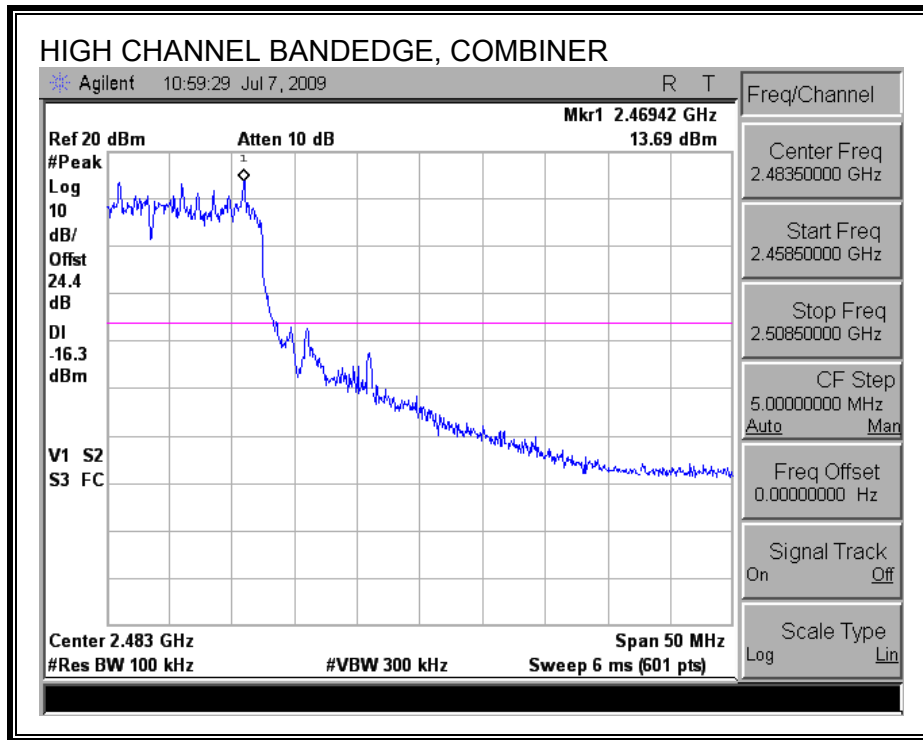

7.4. 2.4 GHz BAND CHANNEL TESTS FOR 802.11n HT40 MODE

7.4.1. 6 dB BANDWIDTH

LIMITS

FCC §15.247 (a) (2)

IC RSS-210 A8.2 (a)

The minimum 6 dB bandwidth shall be at least 500 kHz.

TEST PROCEDURE

The transmitter output is connected to a spectrum analyzer. The RBW is set to 100 kHz and the VBW is set to 300 kHz. The sweep time is coupled.

RESULTS

Channel	Frequency (MHz)	6 dB BW (MHz)	Minimum Limit (MHz)
Low	2422	35.33	0.5
Mid	2437	35.20	0.5
High	2452	35.33	0.5

6 dB BANDWIDTH

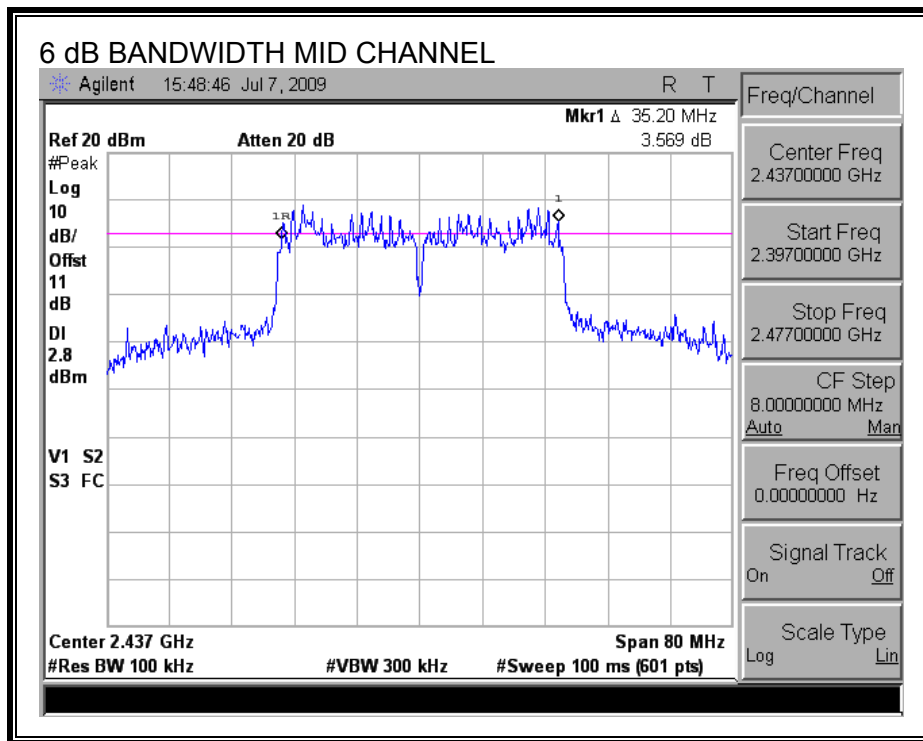
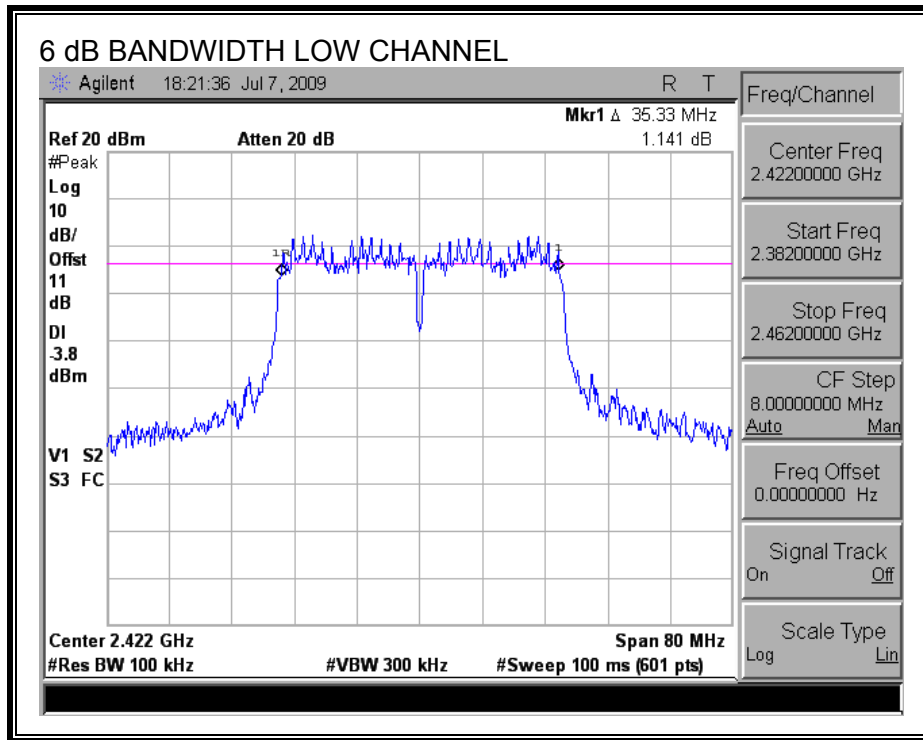

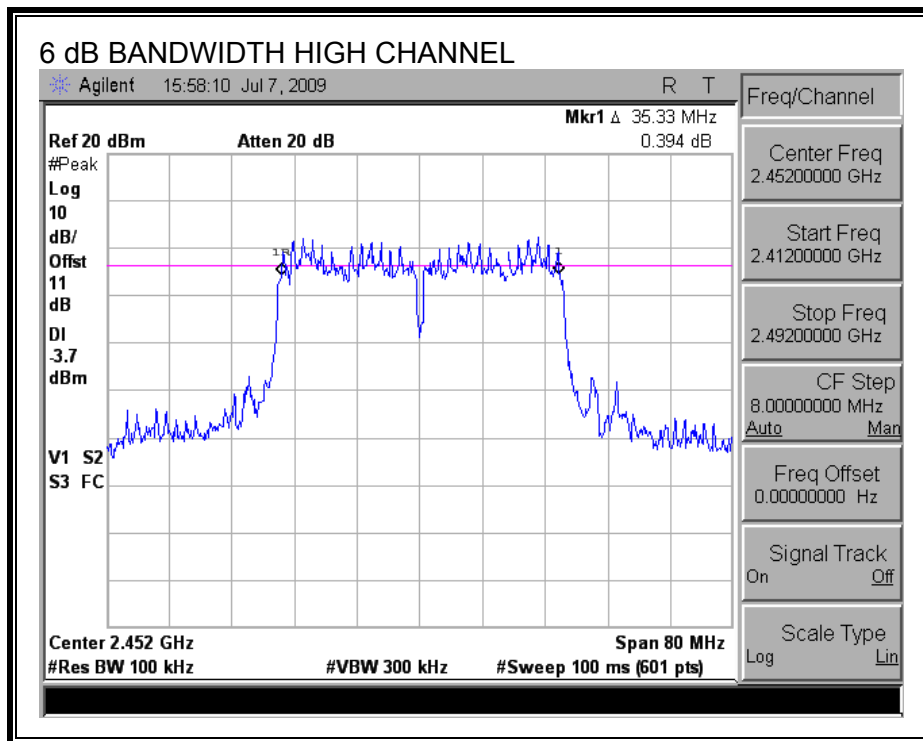

7.4.2. 99% & 26 dB BANDWIDTH

LIMITS

None; for reporting purposes only.

TEST PROCEDURE

The transmitter output is connected to the spectrum analyzer. The RBW is set to 1% to 3% of the bandwidth. The VBW is set to 3 times the RBW. The sweep time is coupled. The spectrum analyzer internal bandwidth measurement function is utilized.

RESULTS

Channel	Frequency (MHz)	99% OBW (MHz)	26 dB BW (MHz)
Low	2422	36.09	41.49
Mid	2437	36.34	64.76
High	2452	35.63	39.01

99% & 26 dB BANDWIDTH

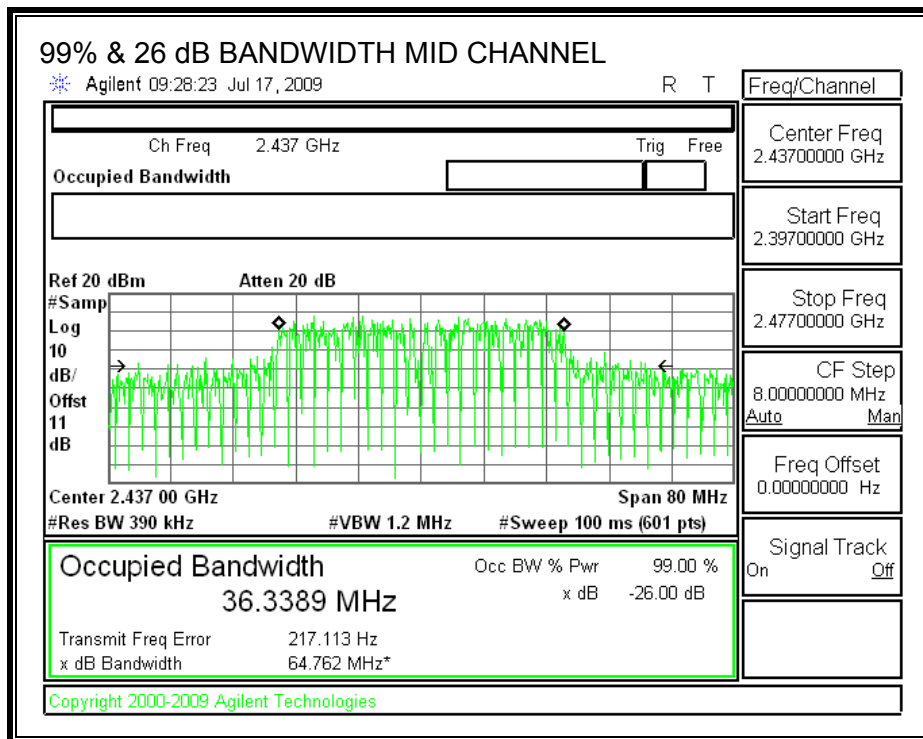
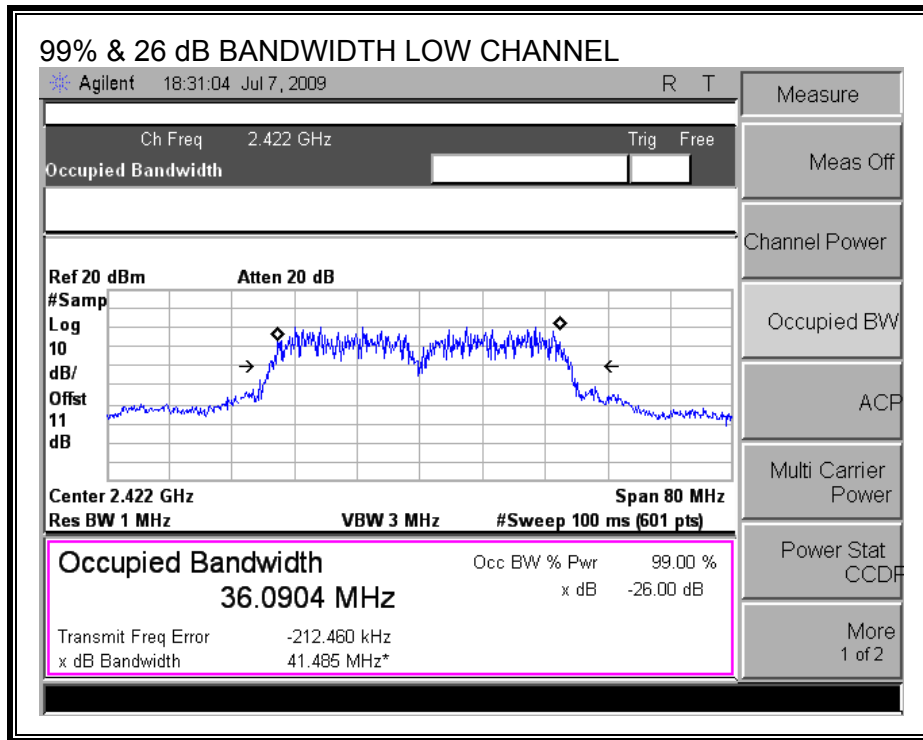

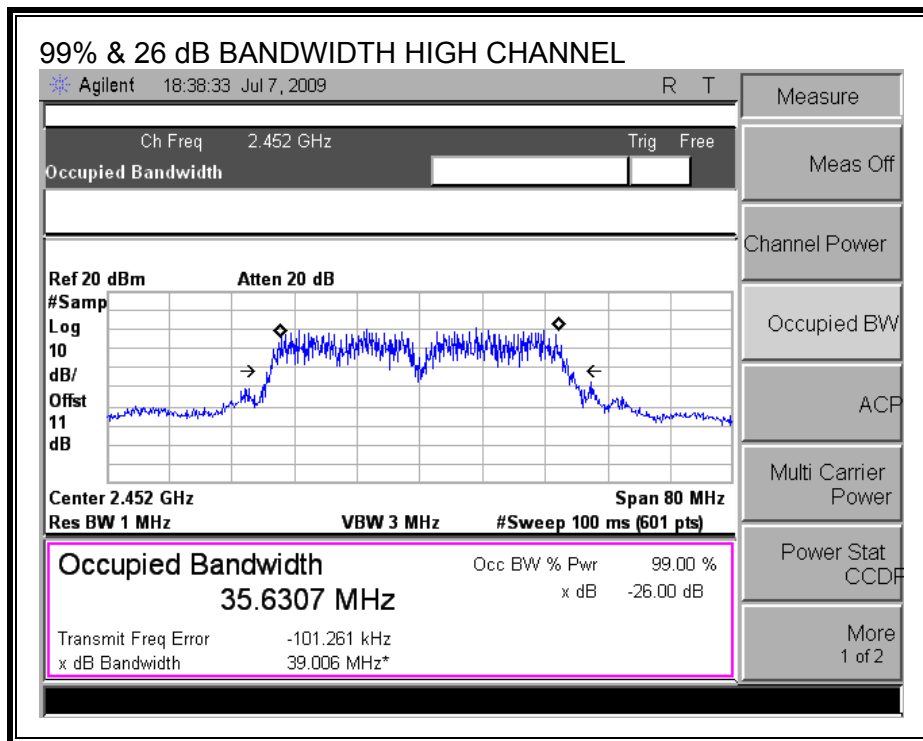

7.4.3. OUTPUT POWER

LIMITS

FCC §15.247 (b)

IC RSS-210 A8.4

TEST PROCEDURE

Output power was measured based on the use of RMS averaging over a time interval in accordance with FCC document "Measurement of Digital Transmission Systems Operating under Section 15.247", March 23, 2005.

RESULTS

The antenna gain is less than 6 dBi, therefore the limit is 30 dBm.

Channel	Frequency (MHz)	Chain 0 Power (dBm)	Chain 1 Power (dBm)	Chain 2 Power (dBm)	Chain 3 Power (dBm)	Total Power (dBm)	Limit (dBm)	Margin (dB)
Low	2422	20.47	20.17	19.89	19.73	26.09	30	-3.91
Mid	2437	19.42	19.98	19.91	20.08	25.88	30	-4.12
High	2452	13.54	13.57	13.56	13.61	19.59	30	-10.41

OUTPUT POWER, LOW CHANNEL

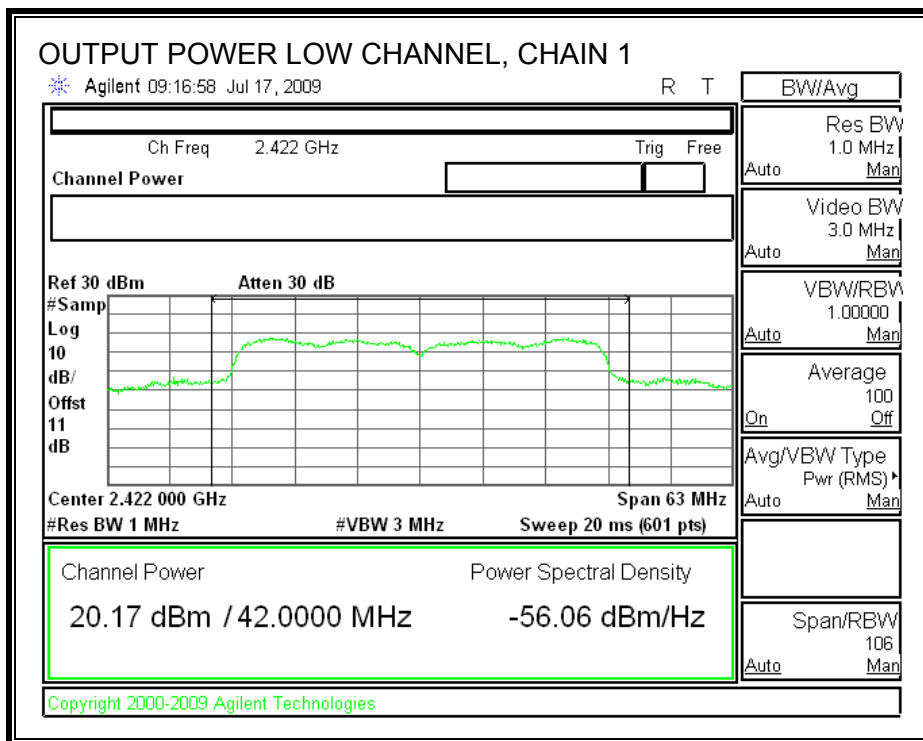
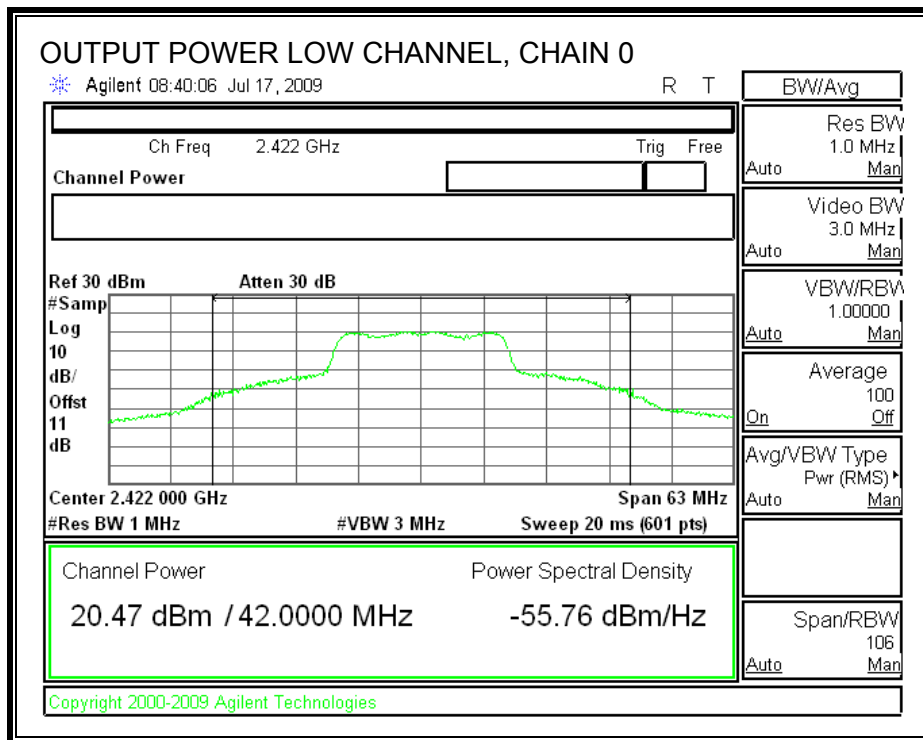

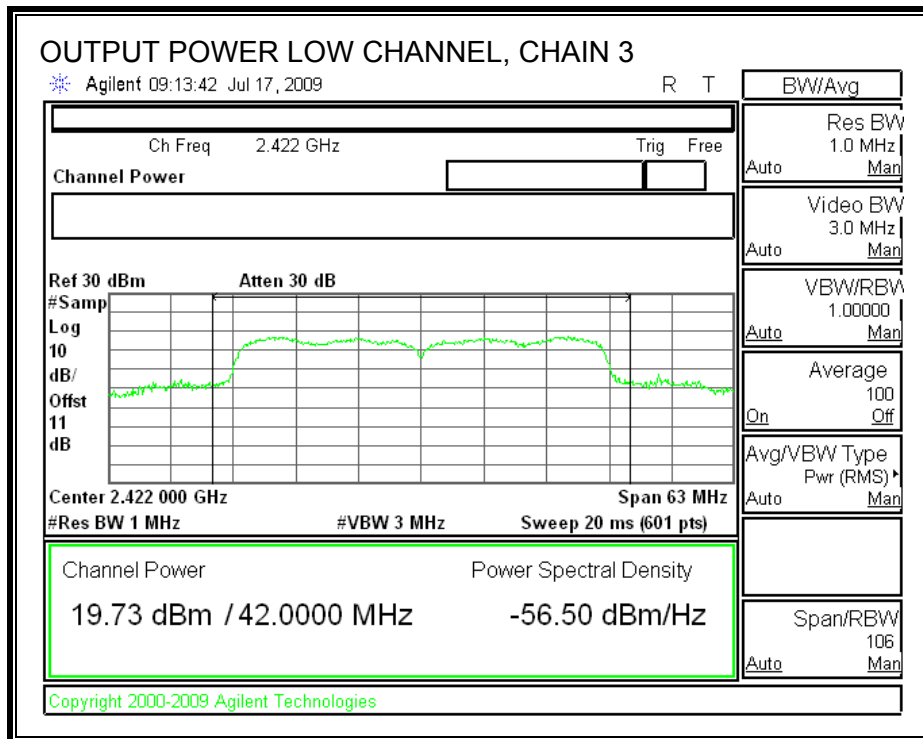
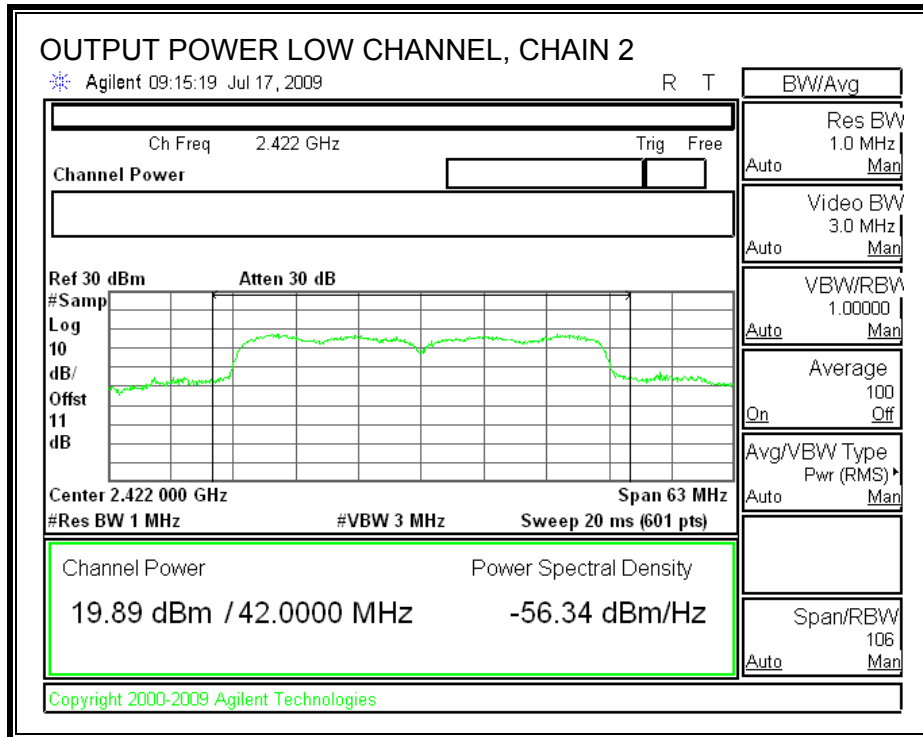

OUTPUT POWER, MID CHANNEL

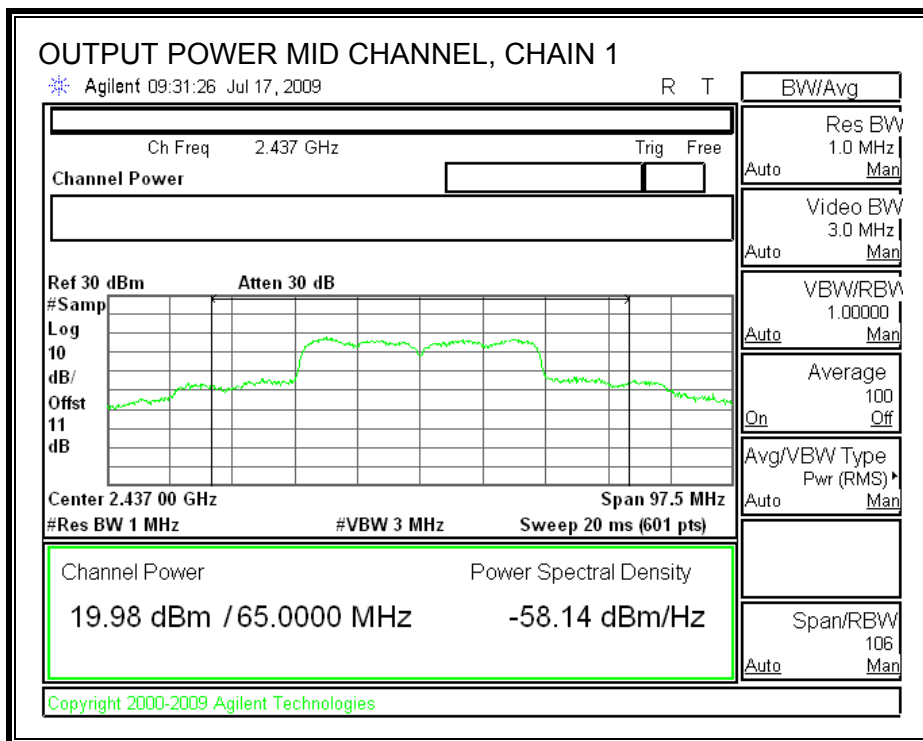
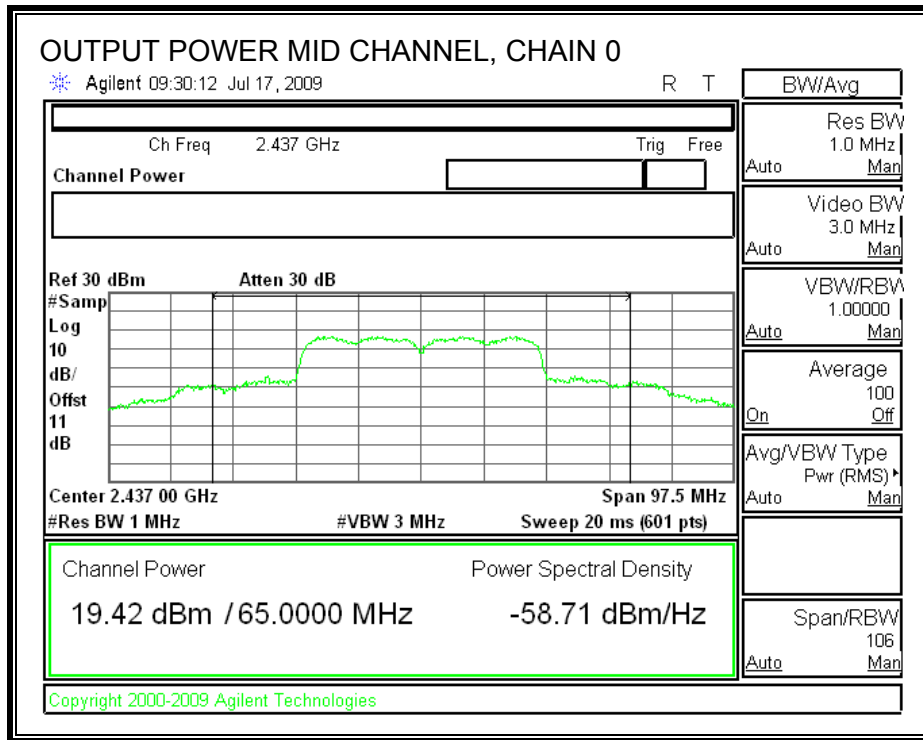

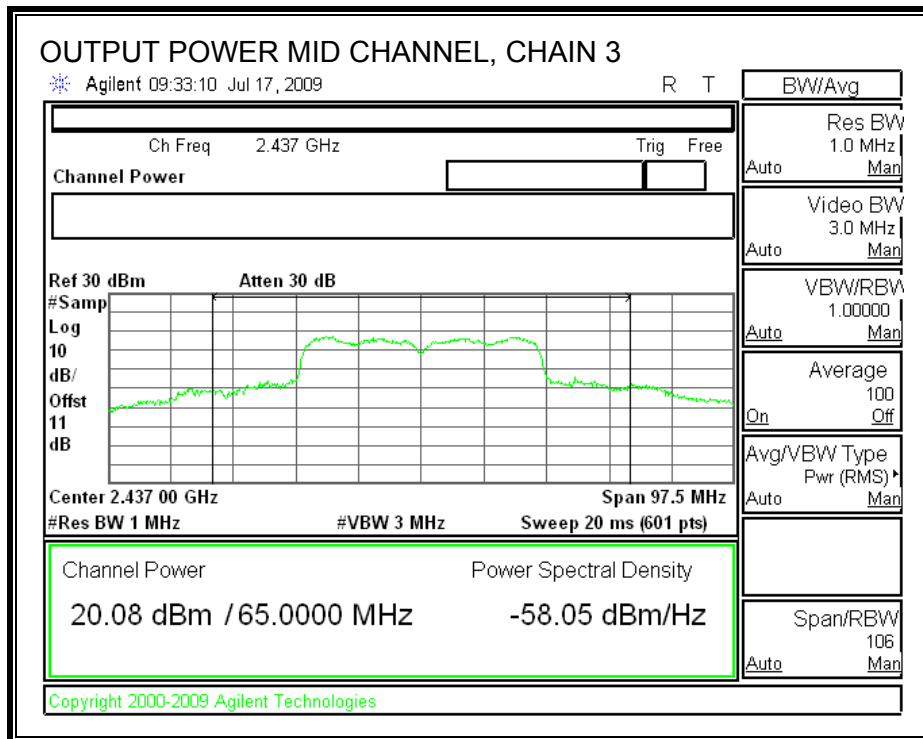
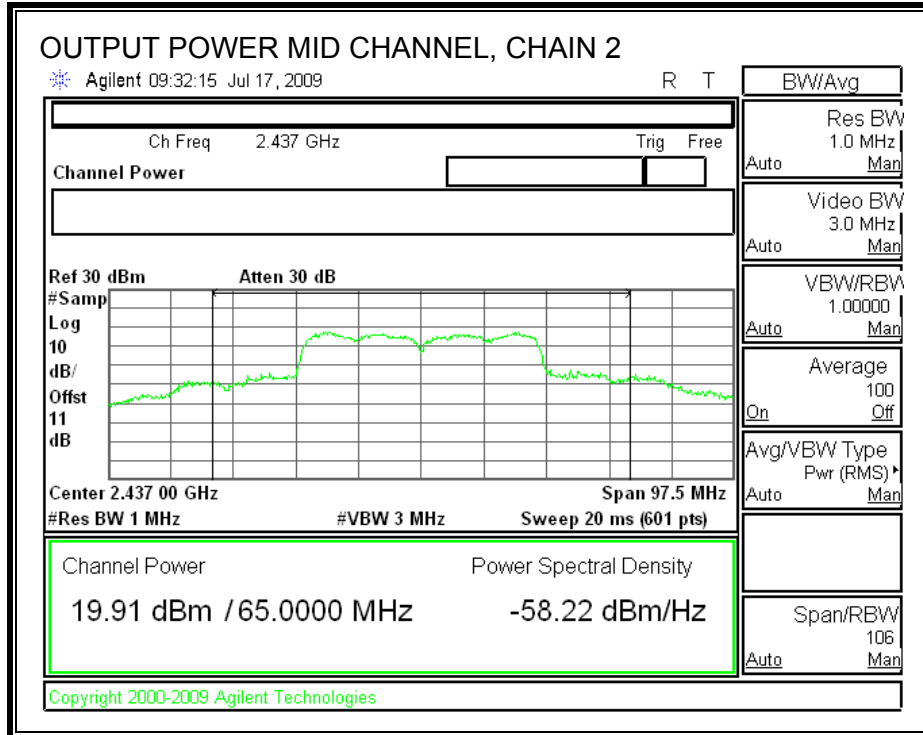

OUTPUT POWER, HIGH CHANNEL

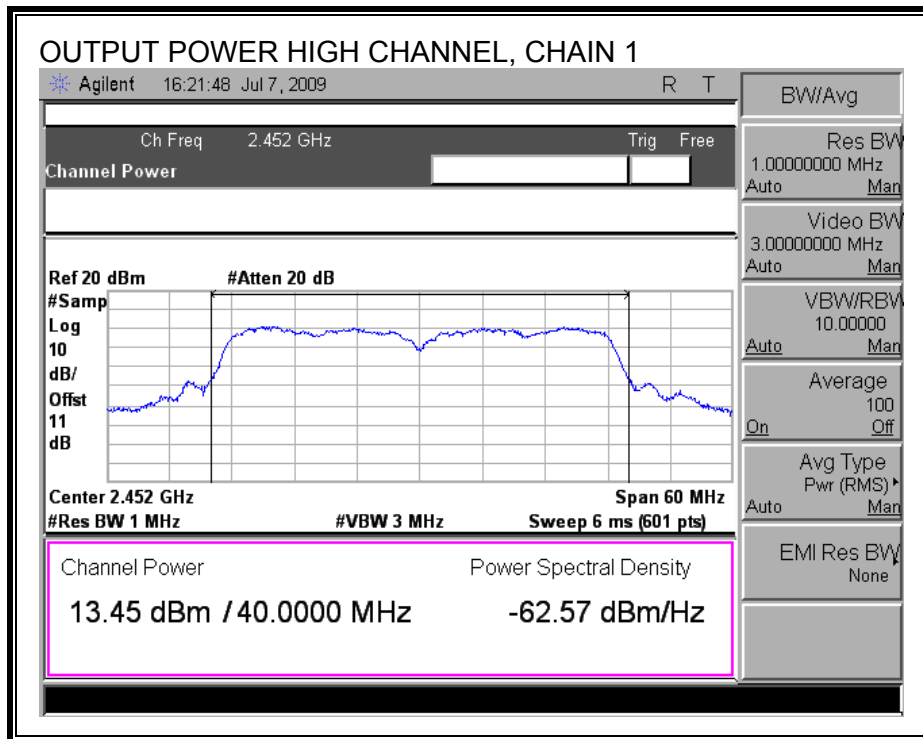
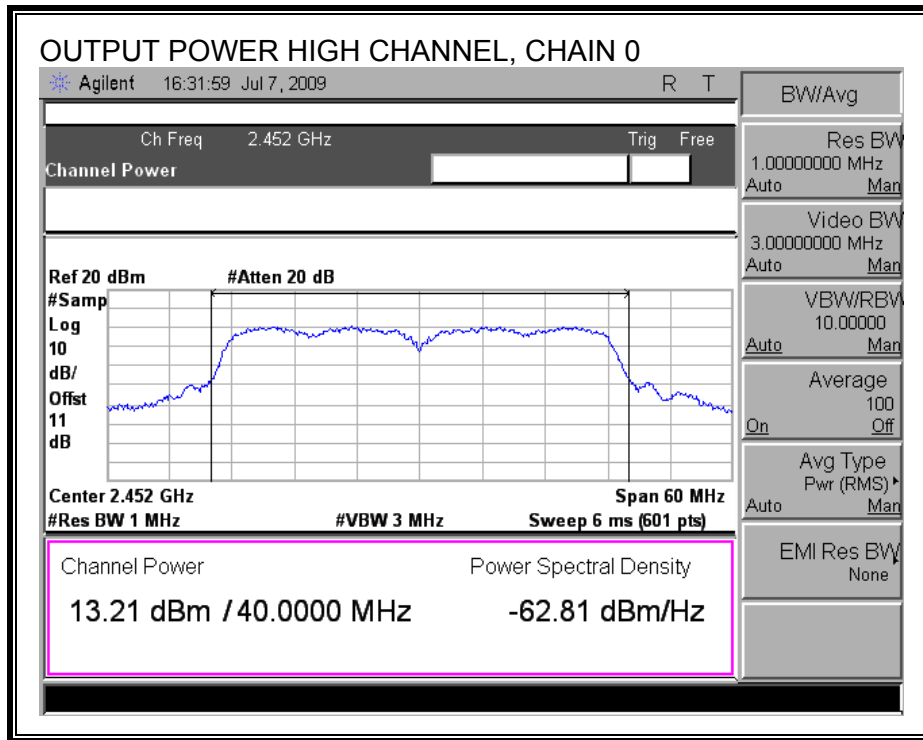

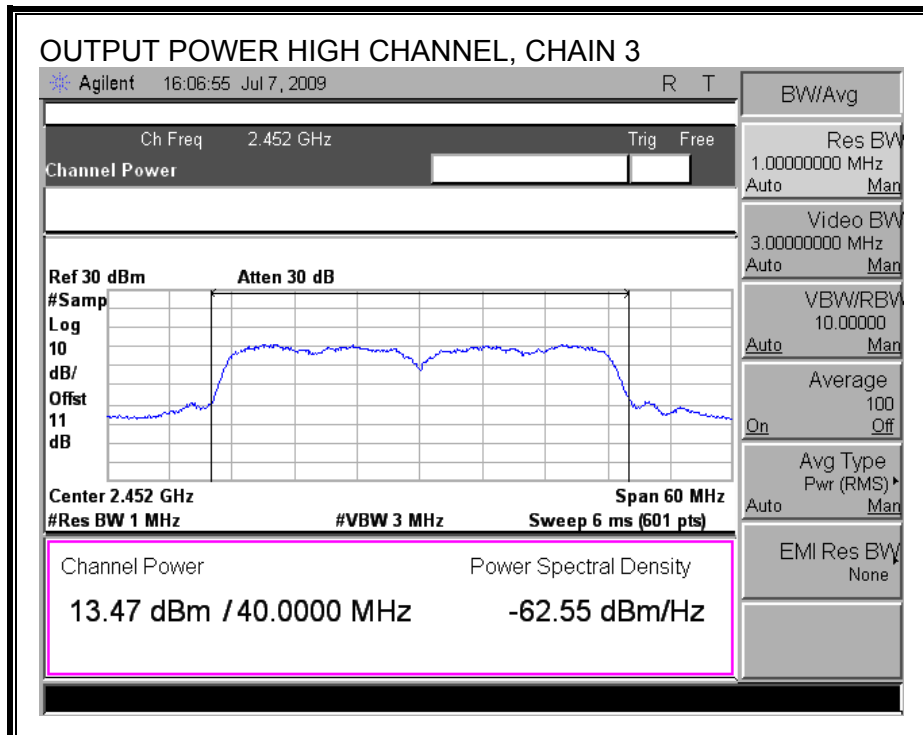
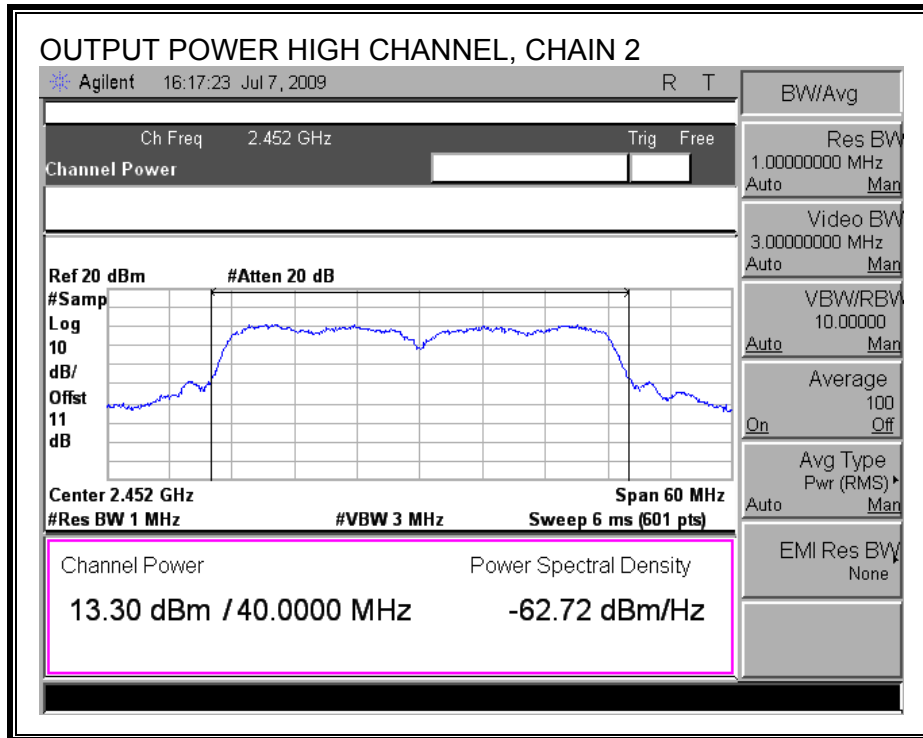

7.4.4. AVERAGE POWER

LIMITS

None; for reporting purposes only.

TEST PROCEDURE

The transmitter output is connected to a power meter.

The cable assembly insertion loss of 11 dB (including 10 dB pad and 1 dB cable) was entered as an offset in the power meter to allow for direct reading of power.

RESULTS

Channel	Frequency (MHz)	Chain 0 Power (dBm)	Chain 1 Power (dBm)	Chain 2 Power (dBm)	Chain 3 Power (dBm)
Low	2422.00	14.29	14.28	14.12	14.33
Mid	2437.00	19.55	19.68	19.67	19.74
High	2452.00	13.47	13.53	13.52	13.53

7.4.5. POWER SPECTRAL DENSITY

LIMITS

FCC §15.247 (e)

IC RSS-210 A8.2 (b)

The power spectral density conducted from the transmitter to the antenna shall not be greater than 8 dBm in any 3 kHz band during any time interval of continuous transmission.

TEST PROCEDURE

Output power was measured based on the use of RMS averaging over a time interval, therefore the power spectral density was measured using PSD Option 2 in accordance with FCC document "Measurement of Digital Transmission Systems Operating under Section 15.247", March 23, 2005.

Preliminary tests on individual chains, and on all chains with a combiner, were performed. The worst-case configuration was with a combiner, therefore final test were performed with all chains feeding a combiner.

RESULTS

Channel	Frequency (MHz)	PSD with Combiner (dBm)	Limit (dBm)	Margin (dB)
Low	2422	-19.31	8	-27.31
Mid	2437	-22.60	8	-30.60
High	2452	-22.64	8	-30.64

POWER SPECTRAL DENSITY

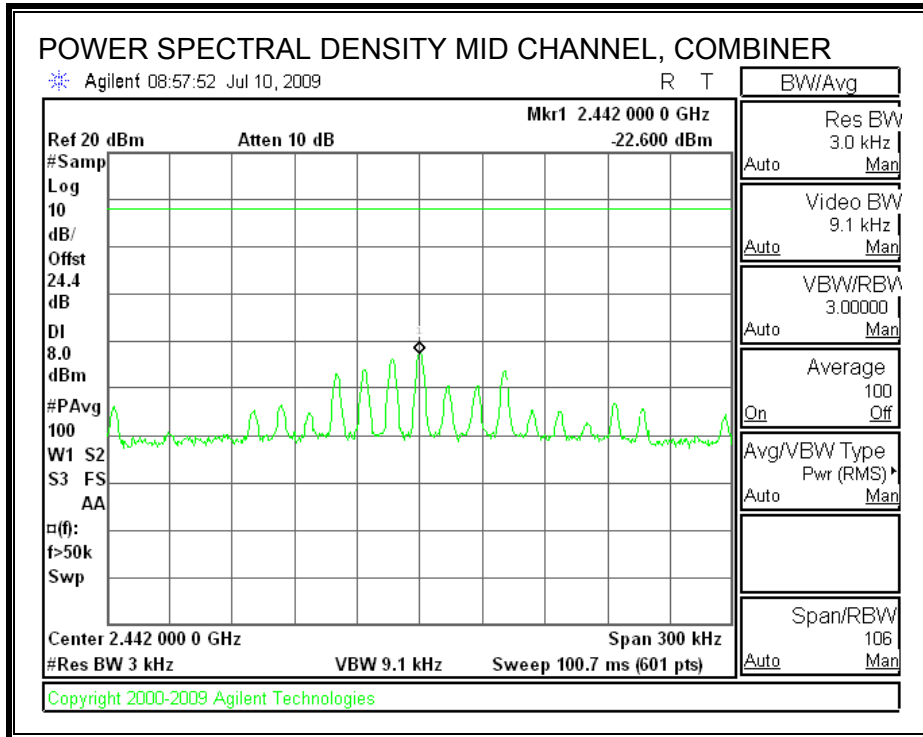
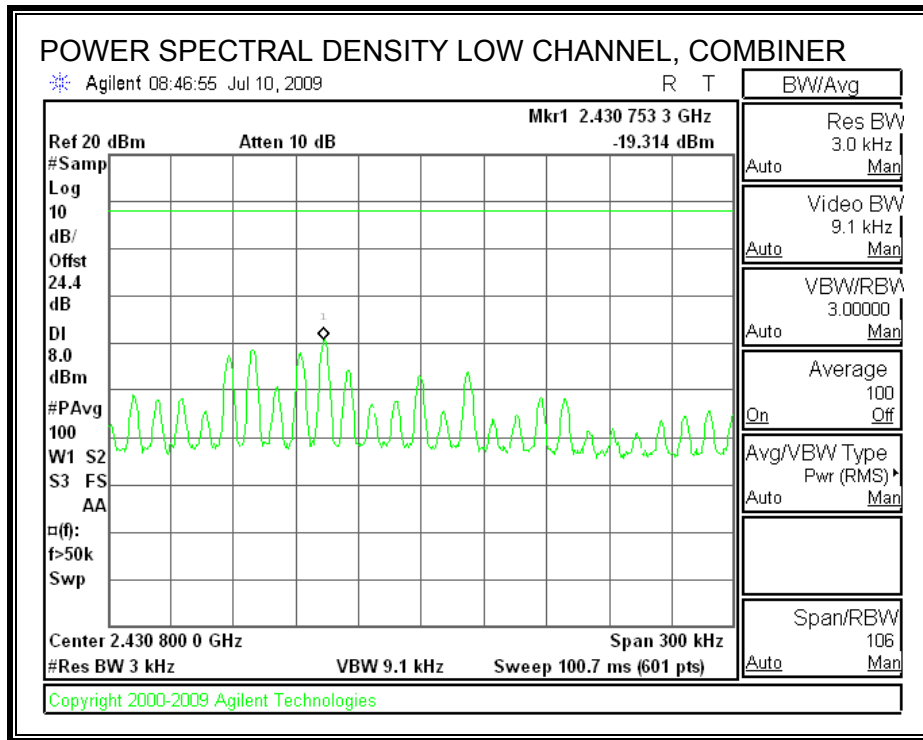

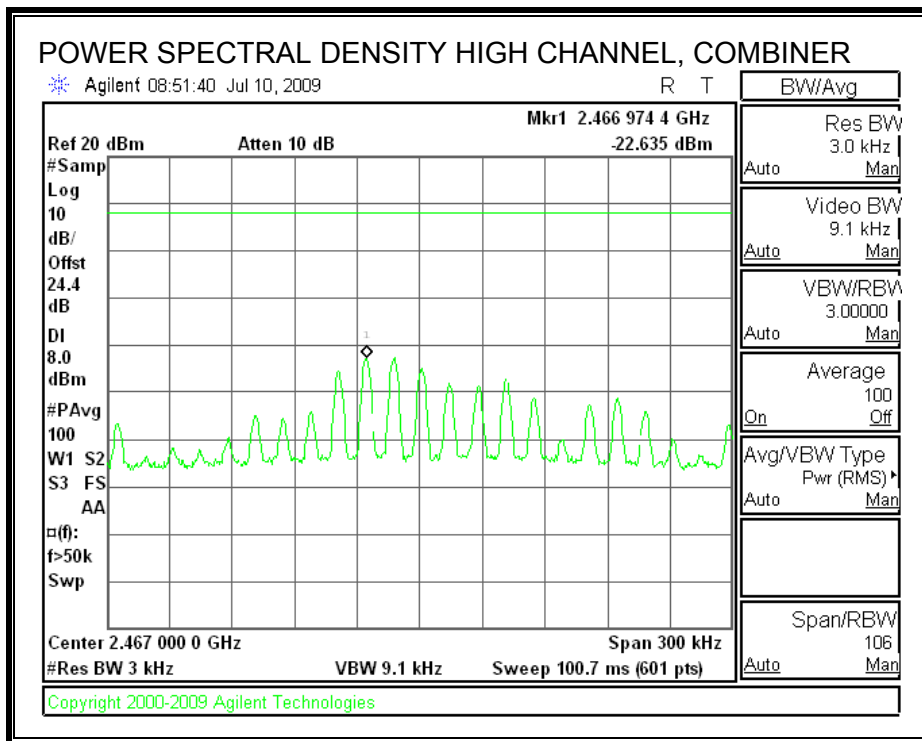

7.4.6. CONDUCTED SPURIOUS EMISSIONS

LIMITS

FCC §15.247 (d)

IC RSS-210 A8.5

Output power was measured based on the use of RMS averaging over a time interval, therefore the required attenuation is 30 dBc.

TEST PROCEDURE

The transmitter output is connected to a spectrum analyzer. The resolution bandwidth is set to 100 kHz. The video bandwidth is set to 300 kHz.

The spectrum from 30 MHz to 26 GHz is investigated with the transmitter set to the lowest, middle, and highest channels.

Preliminary tests on individual chains, and on all chains with a combiner, were performed. The worst-case configuration was with a combiner, therefore final test were performed with all chains feeding a combiner.

LOW CHANNEL SPURIOUS EMISSIONS

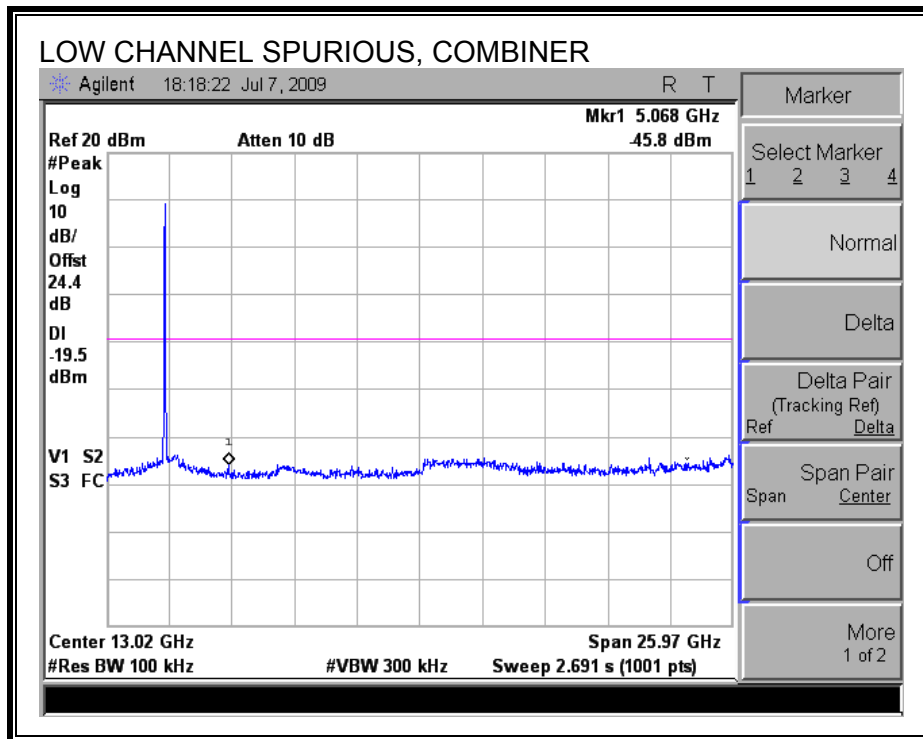
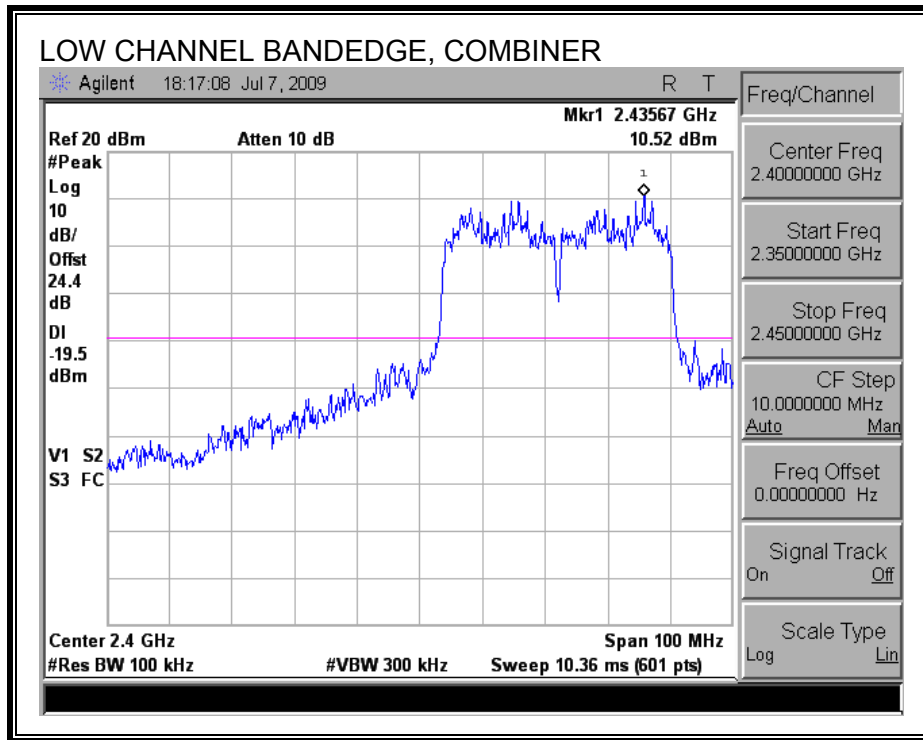

MID CHANNEL SPURIOUS EMISSIONS

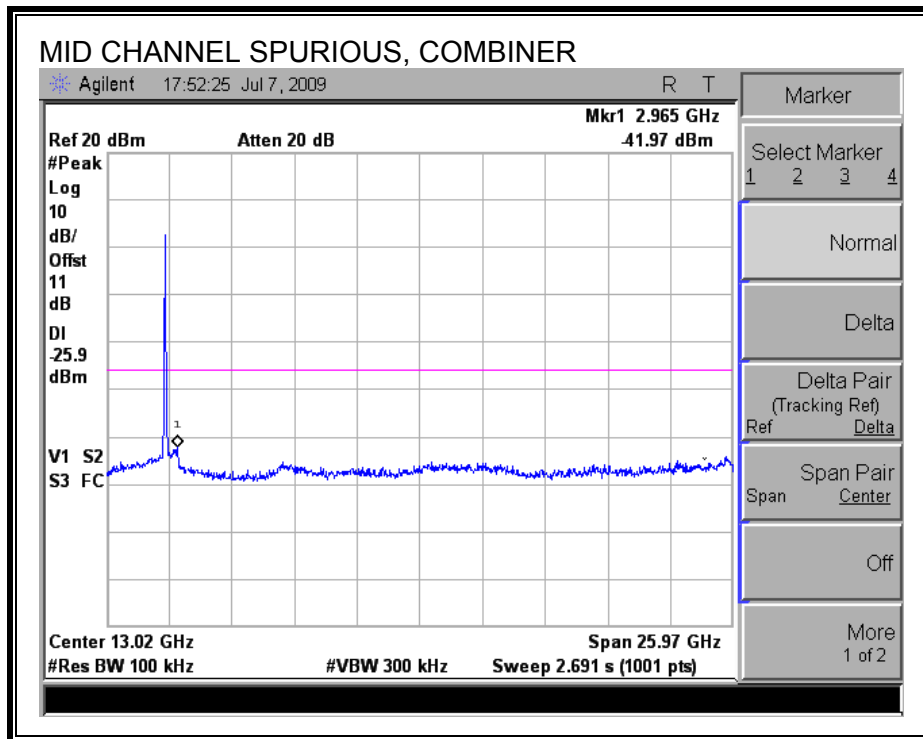
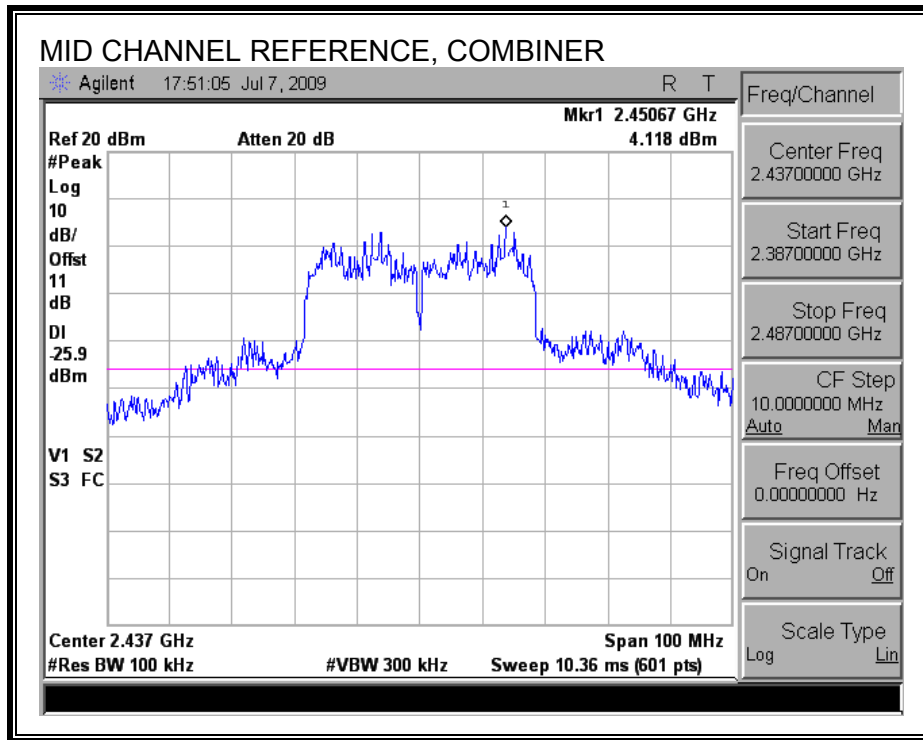

HIGH CHANNEL SPURIOUS EMISSIONS

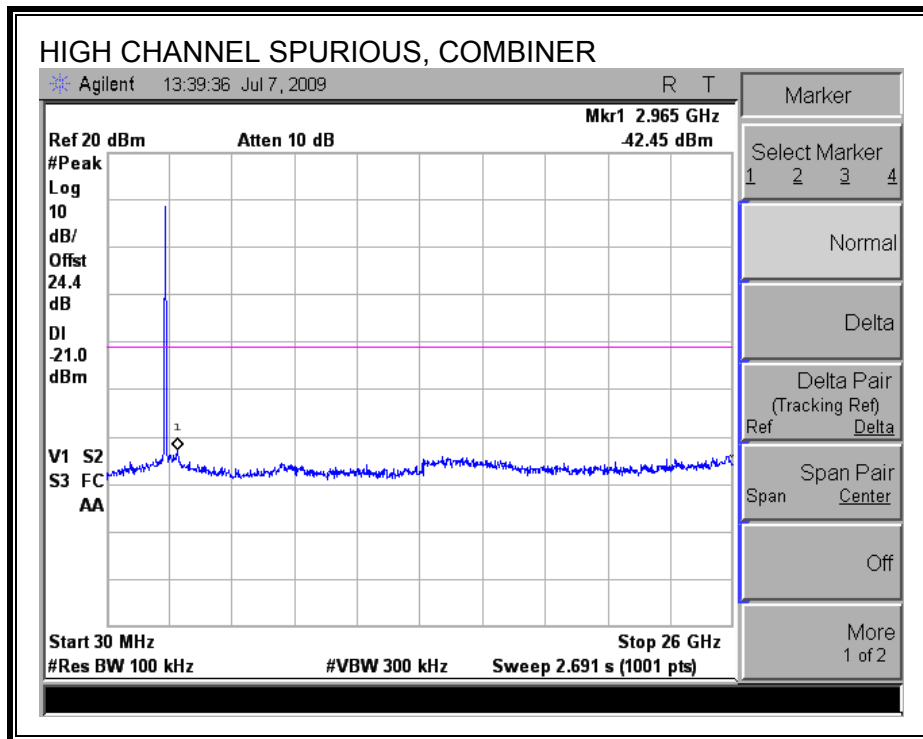
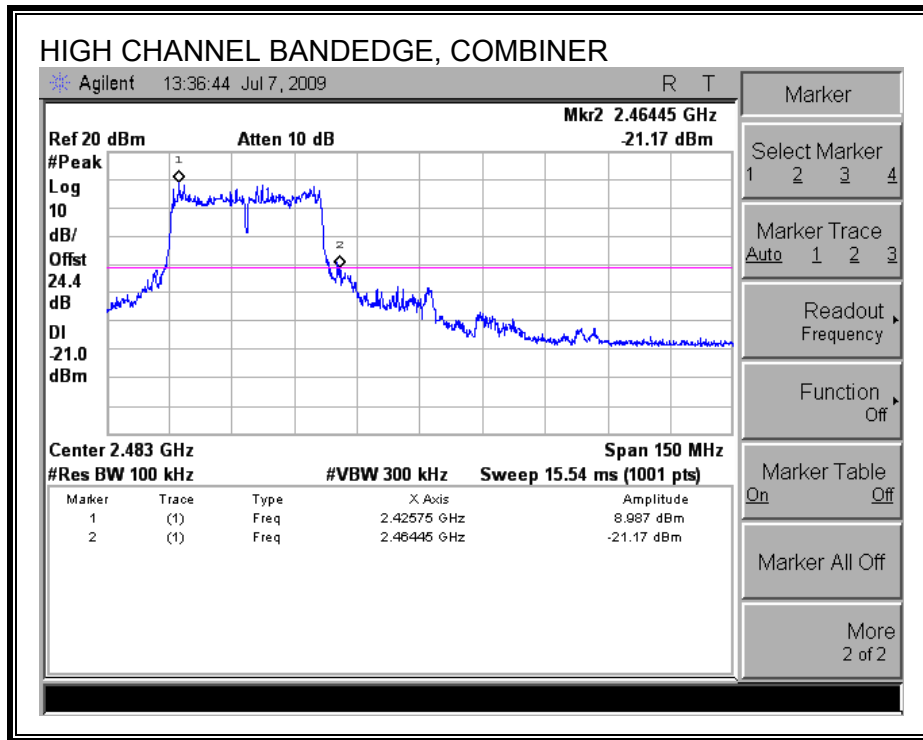

7.5. 5.8 GHz BAND CHANNEL TESTS FOR 802.11a MODE

7.5.1. 6 dB BANDWIDTH

LIMITS

FCC §15.247 (a) (2)

IC RSS-210 A8.2 (a)

The minimum 6 dB bandwidth shall be at least 500 kHz.

TEST PROCEDURE

The transmitter output is connected to a spectrum analyzer. The RBW is set to 100 kHz and the VBW is set to 300 kHz. The sweep time is coupled.

RESULTS

Channel	Frequency (MHz)	6 dB BW (MHz)	Minimum Limit (MHz)
Low	5745	15.58	0.5
Middle	5785	16.50	0.5
High	5825	16.50	0.5

6 dB BANDWIDTH

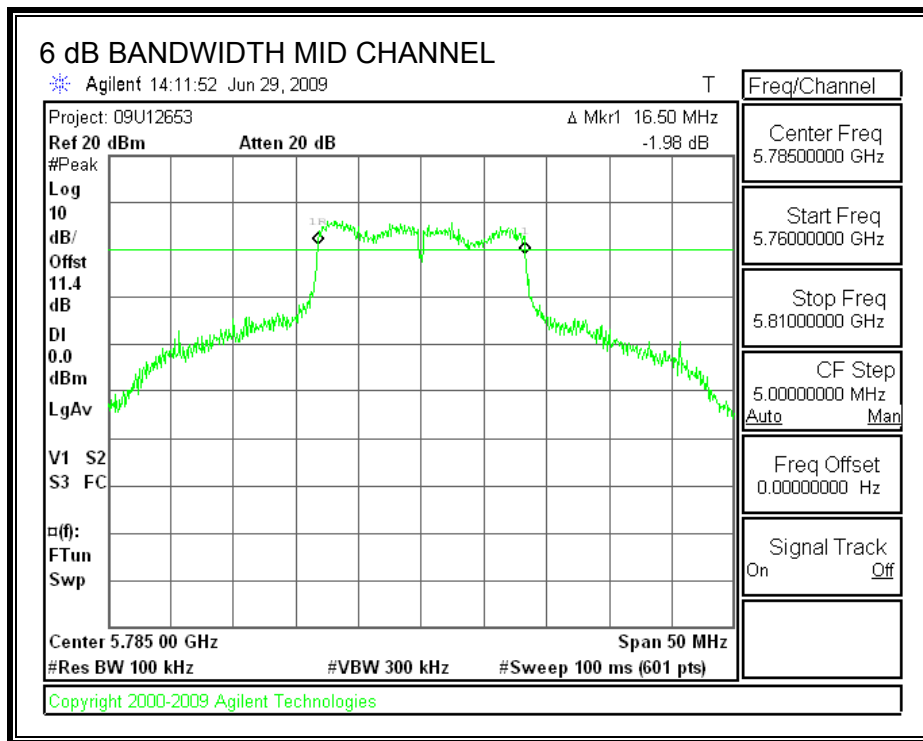
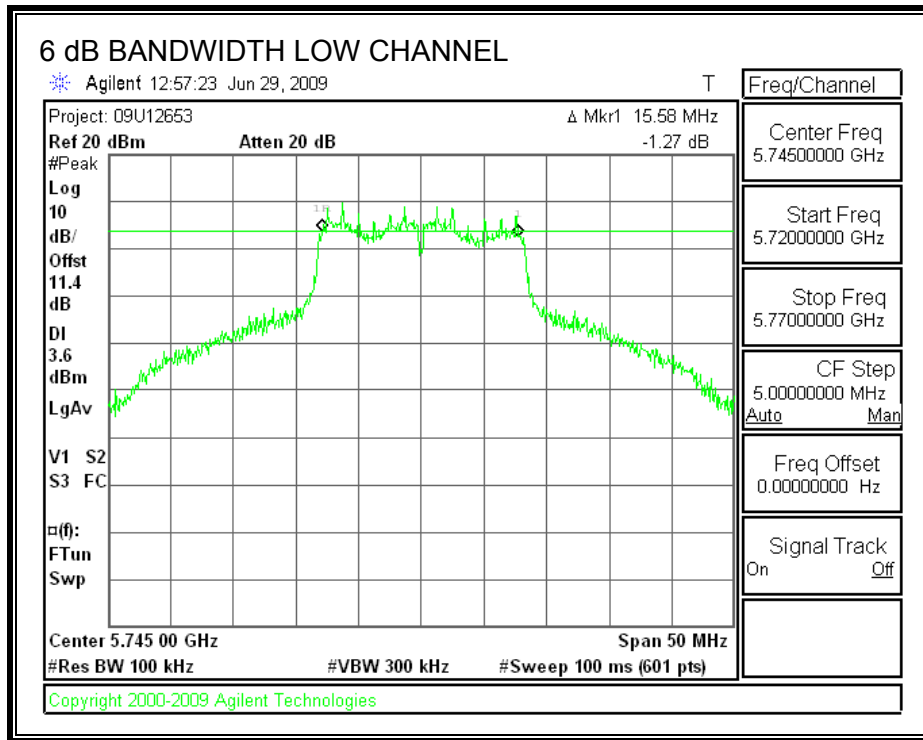

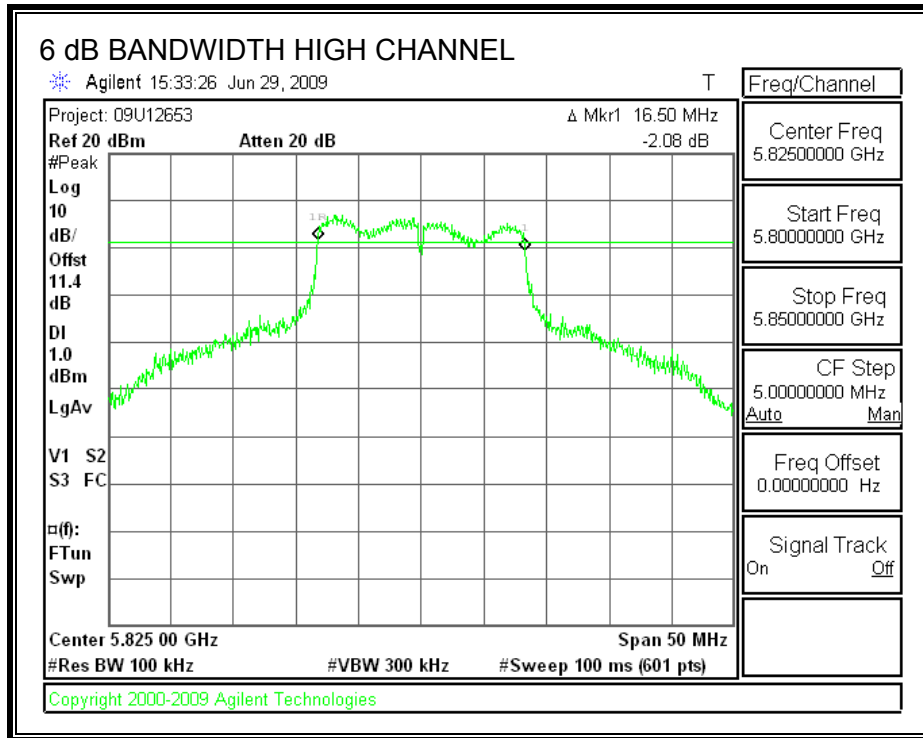

7.5.2. 99% & 26 dB BANDWIDTH

LIMITS

None; for reporting purposes only.

TEST PROCEDURE

The transmitter output is connected to the spectrum analyzer. The RBW is set to 1% to 3% of the bandwidth. The VBW is set to 3 times the RBW. The sweep time is coupled. The spectrum analyzer internal bandwidth measurement function is utilized.

RESULTS

Channel	Frequency (MHz)	99% OBW (MHz)	26 dB BW (MHz)
Low	5745	16.67	31.61
Middle	5785	16.67	31.93
High	5825	16.81	32.11

99% & 26 dB BANDWIDTH

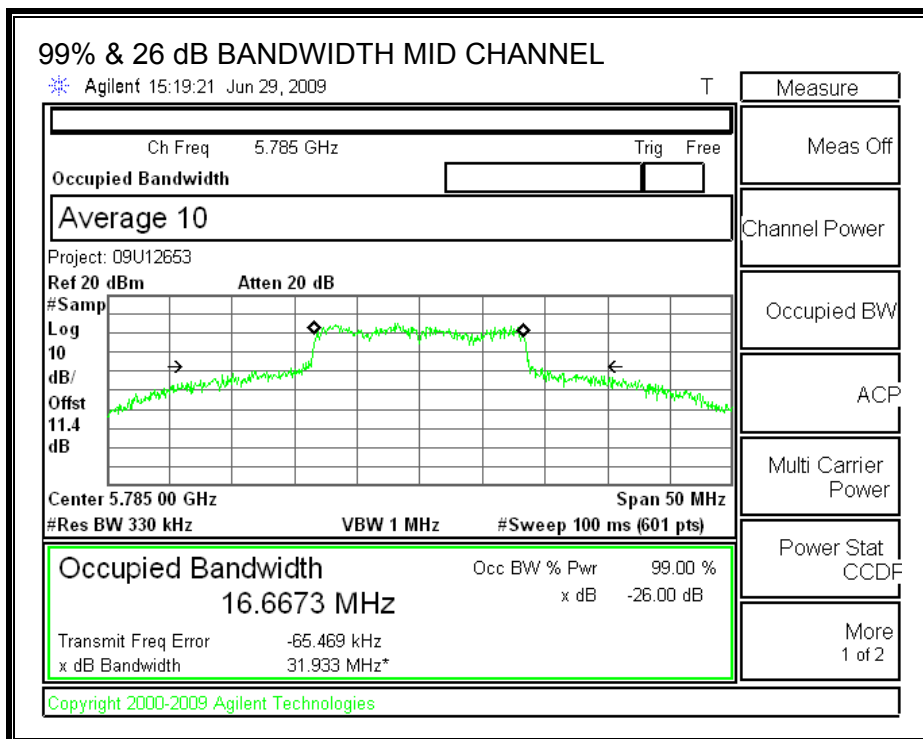
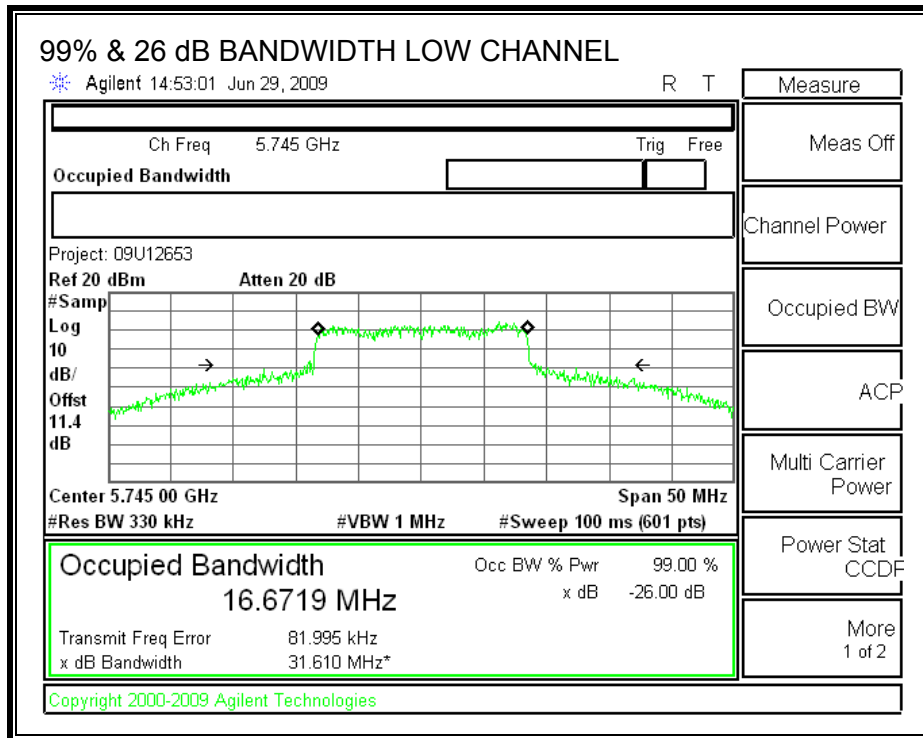

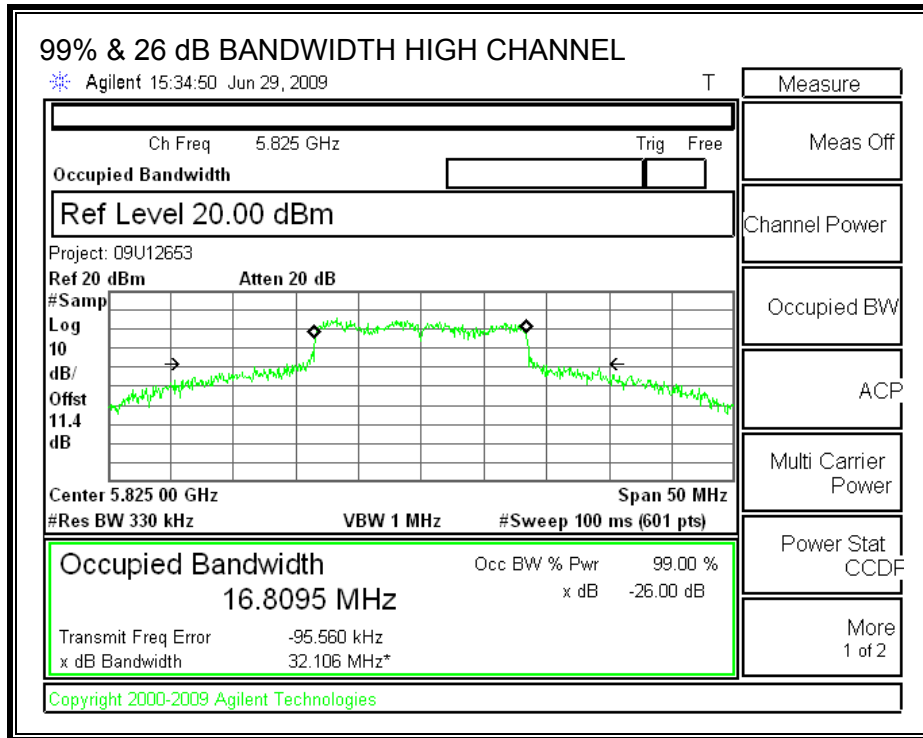

7.5.3. OUTPUT POWER

LIMITS

FCC §15.247 (b)

IC RSS-210 A8.4

TEST PROCEDURE

Output power was measured based on the use of RMS averaging over a time interval in accordance with FCC document "Measurement of Digital Transmission Systems Operating under Section 15.247", March 23, 2005.

RESULTS

Effective Legacy Mode Composite Gain of 4 Identical Antennas:

Antenna Gain (dBi)	10 Log (# Tx Chains) (dB)	Effective Legacy Gain (dBi)
3	6.02	9.02

The composite antenna gain is 9.02 dBi, therefore the limit is 26.98 dBm.

Channel	Frequency (MHz)	Chain 0 Power (dBm)	Chain 1 Power (dBm)	Chain 2 Power (dBm)	Chain 3 Power (dBm)	Total Power (dBm)	Limit (dBm)	Margin (dB)
Low	5745	19.26	19.15	19.18	19.19	25.22	26.98	-1.76
Mid	5785	18.95	18.97	18.98	19.08	25.02	26.98	-1.96
High	5825	19.17	19.18	19.09	19.12	25.16	26.98	-1.82

OUTPUT POWER, LOW CHANNEL

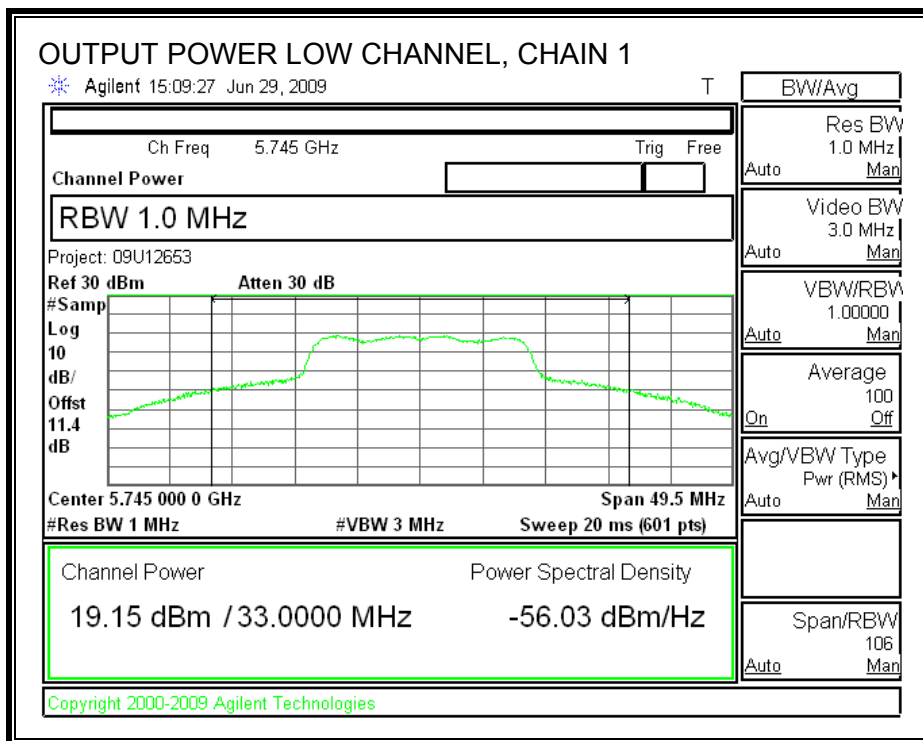
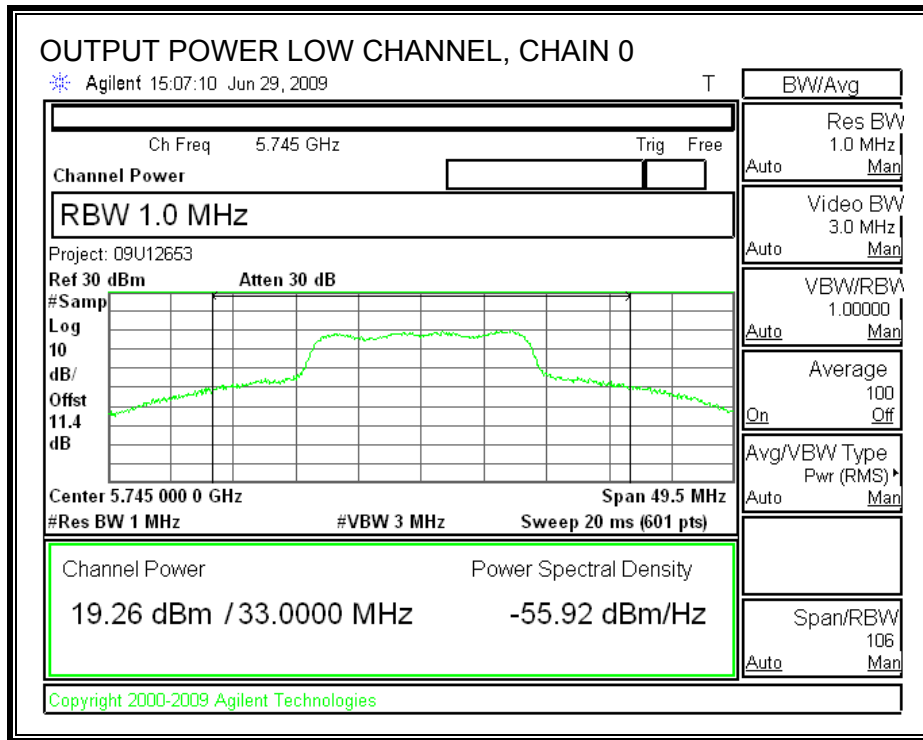

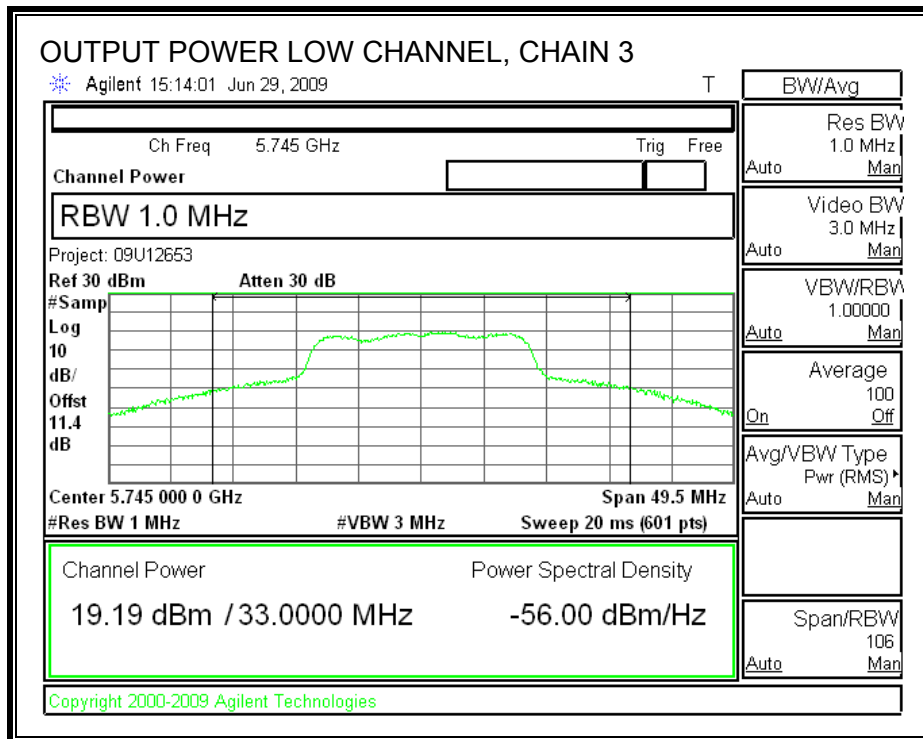
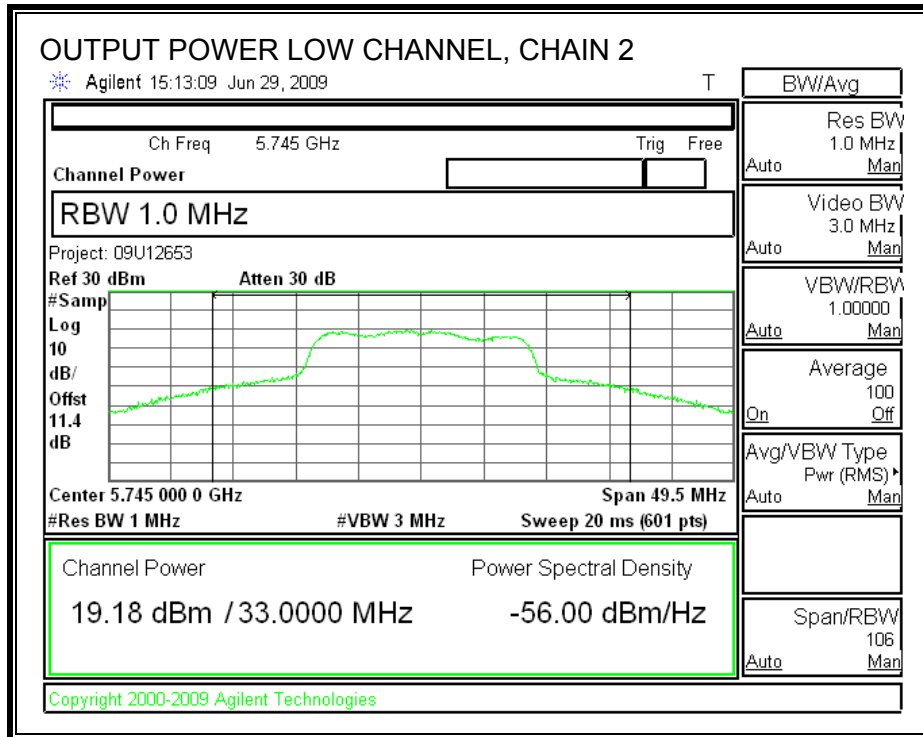

OUTPUT POWER, MID CHANNEL

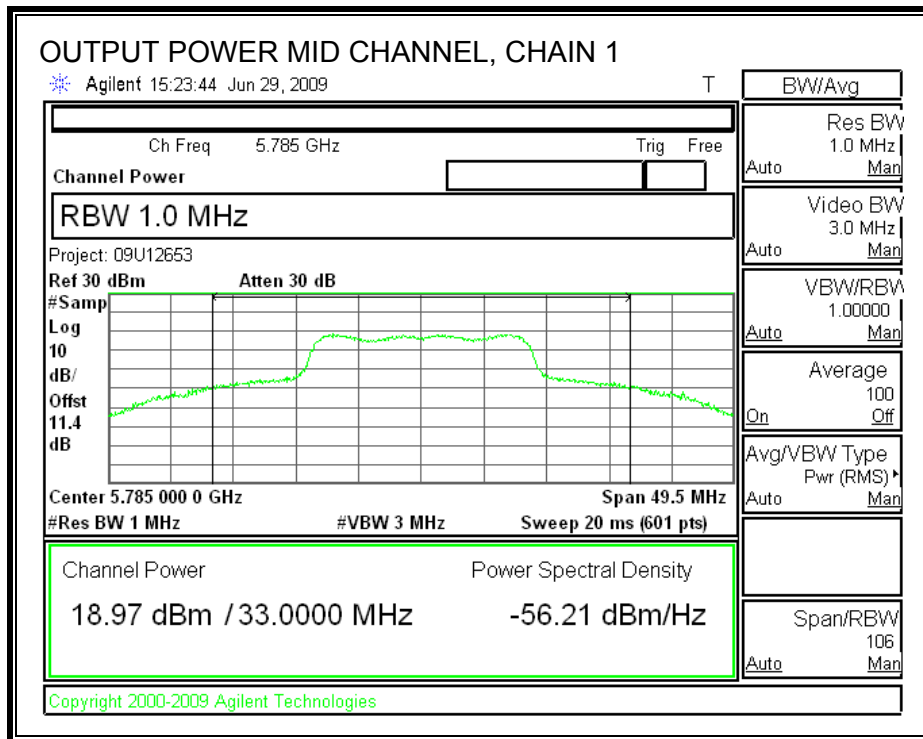
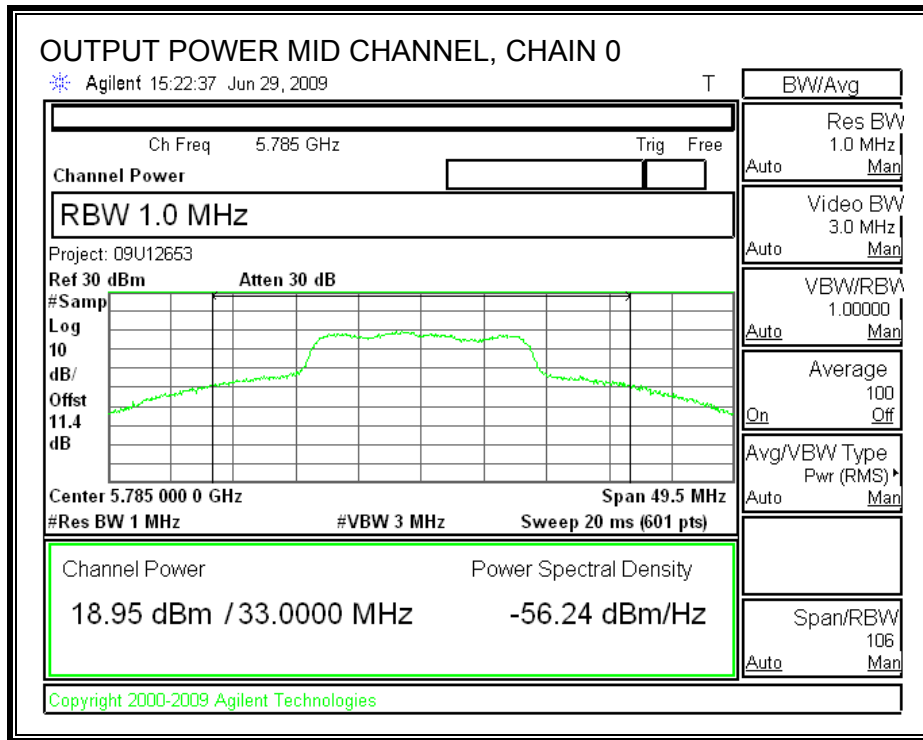

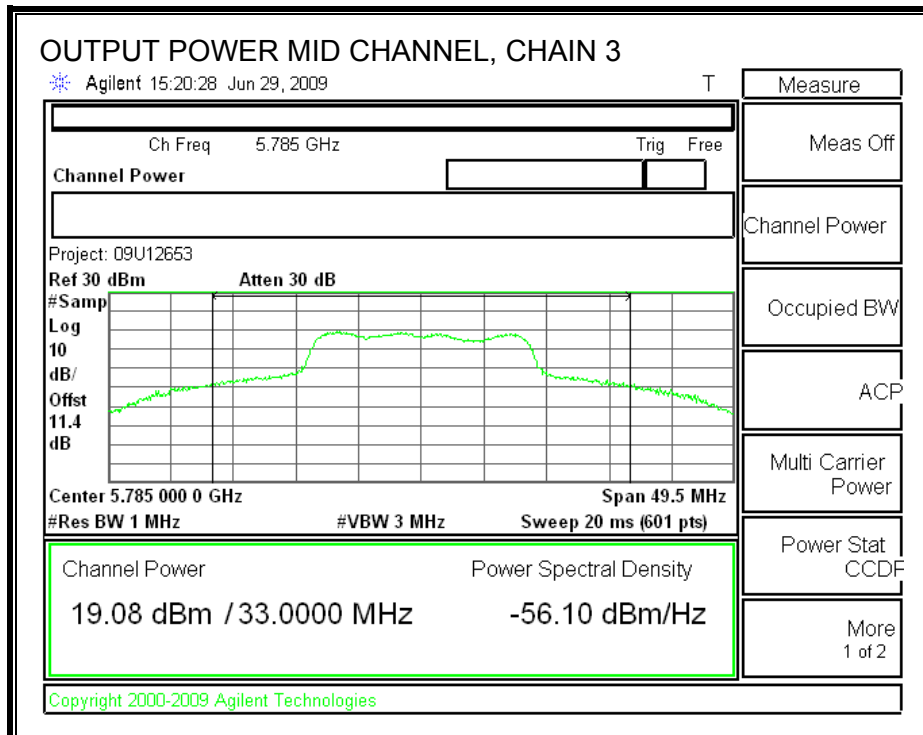
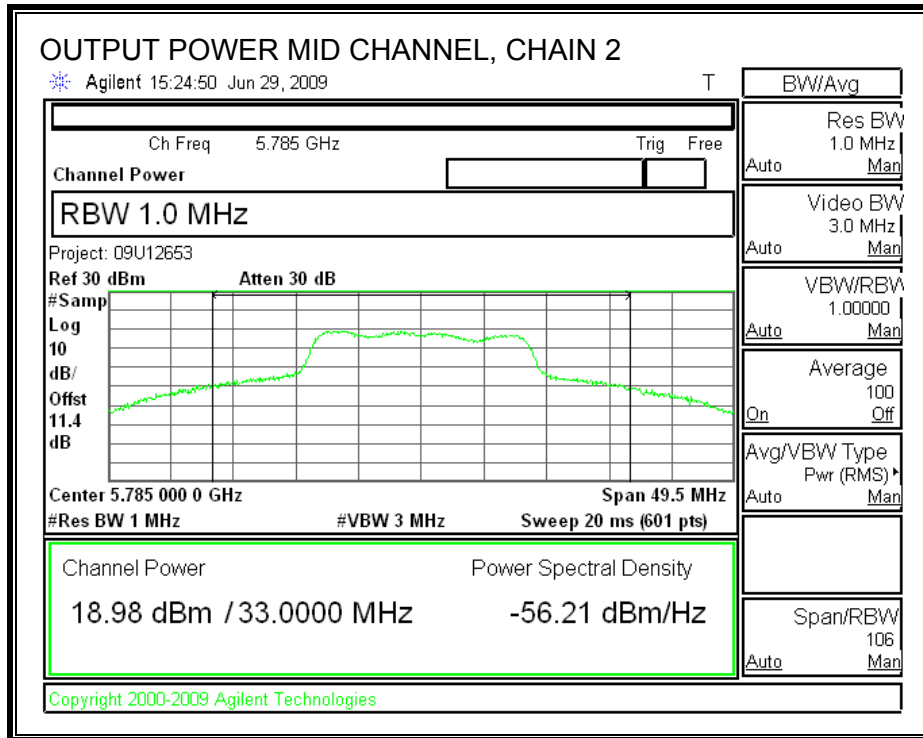

OUTPUT POWER, HIGH CHANNEL

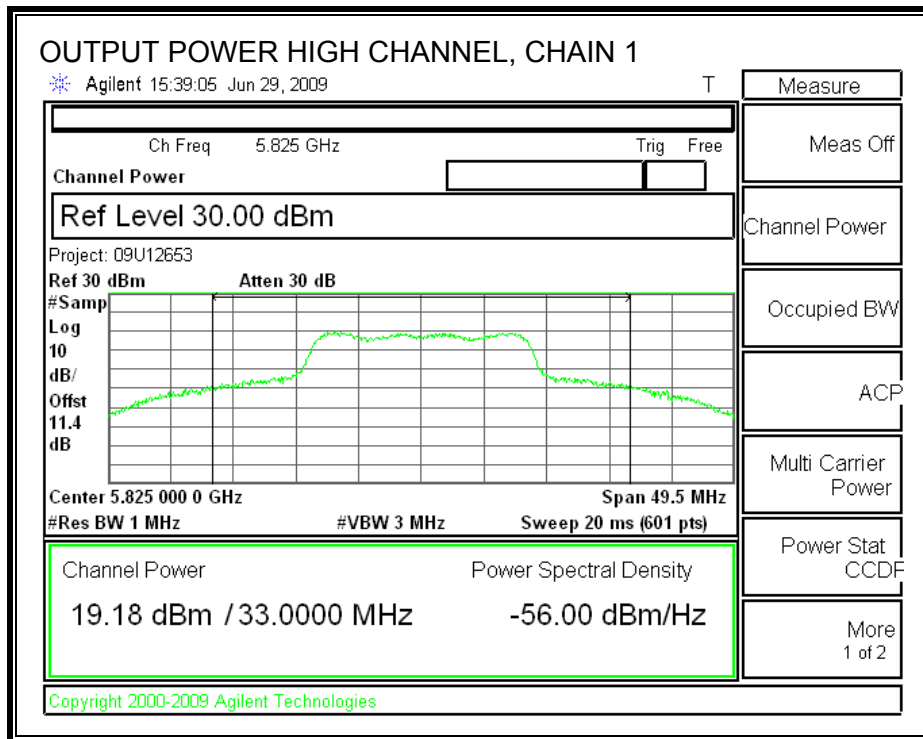
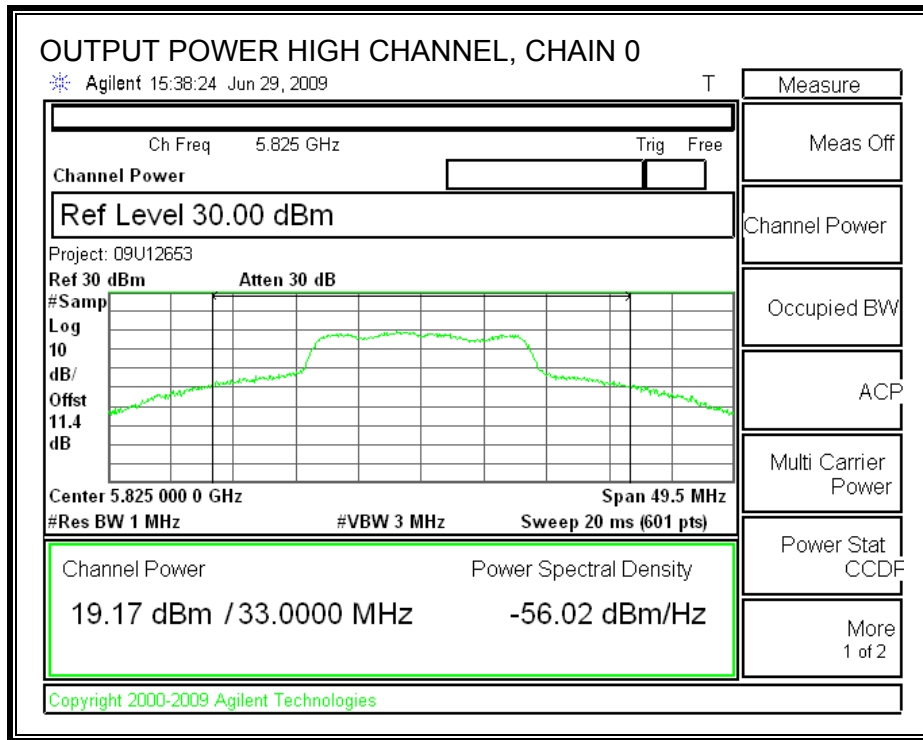

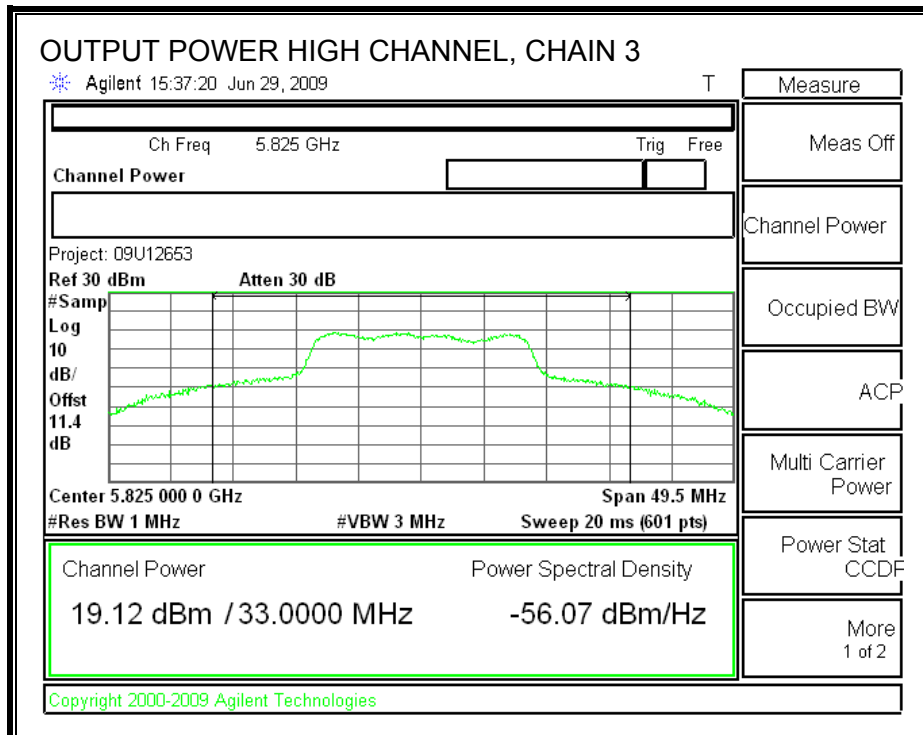
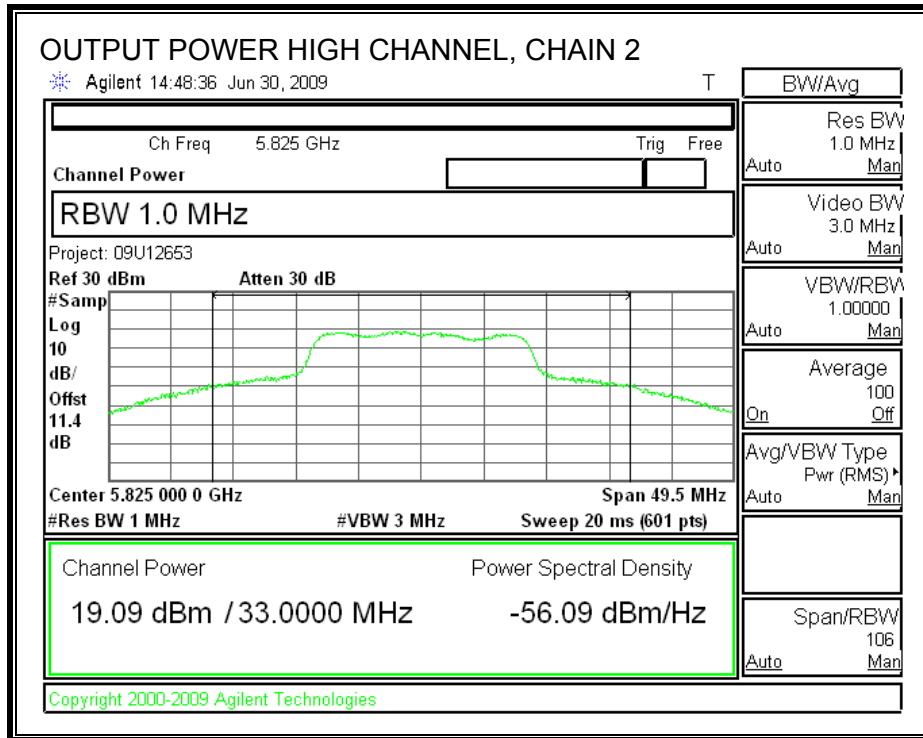

7.5.4. AVERAGE POWER

LIMITS

None; for reporting purposes only.

TEST PROCEDURE

The transmitter output is connected to a power meter.

The cable assembly insertion loss of 11.4 dB (including 10 dB pad and 1.4 dB cable) was entered as an offset in the power meter to allow for direct reading of power.

RESULTS

Channel	Frequency (MHz)	Chain 0 Power (dBm)	Chain 1 Power (dBm)	Chain 2 Power (dBm)	Chain 3 Power (dBm)
Low	5745	19.22	19.01	19.19	19.26
Middle	5785	19.15	19.23	19.14	19.02
High	5825	19.22	19.21	19.13	19.06

7.5.5. POWER SPECTRAL DENSITY

LIMITS

FCC §15.247 (e)

IC RSS-210 A8.2 (b)

The power spectral density conducted from the transmitter to the antenna shall not be greater than 8 dBm in any 3 kHz band during any time interval of continuous transmission.

TEST PROCEDURE

Output power was measured based on the use of RMS averaging over a time interval, therefore the power spectral density was measured using PSD Option 2 in accordance with FCC document "Measurement of Digital Transmission Systems Operating under Section 15.247", March 23, 2005.

Preliminary tests on individual chains, and on all chains with a combiner, were performed. The worst-case configuration was with a combiner, therefore final test were performed with all chains feeding a combiner.

RESULTS

Channel	Frequency (MHz)	PSD with Combiner (dBm)	Limit (dBm)	Margin (dB)
Low	5745	-7.057	8	-15.06
Middle	5785	-6.476	8	-14.48
High	5825	-4.968	8	-12.97

POWER SPECTRAL DENSITY

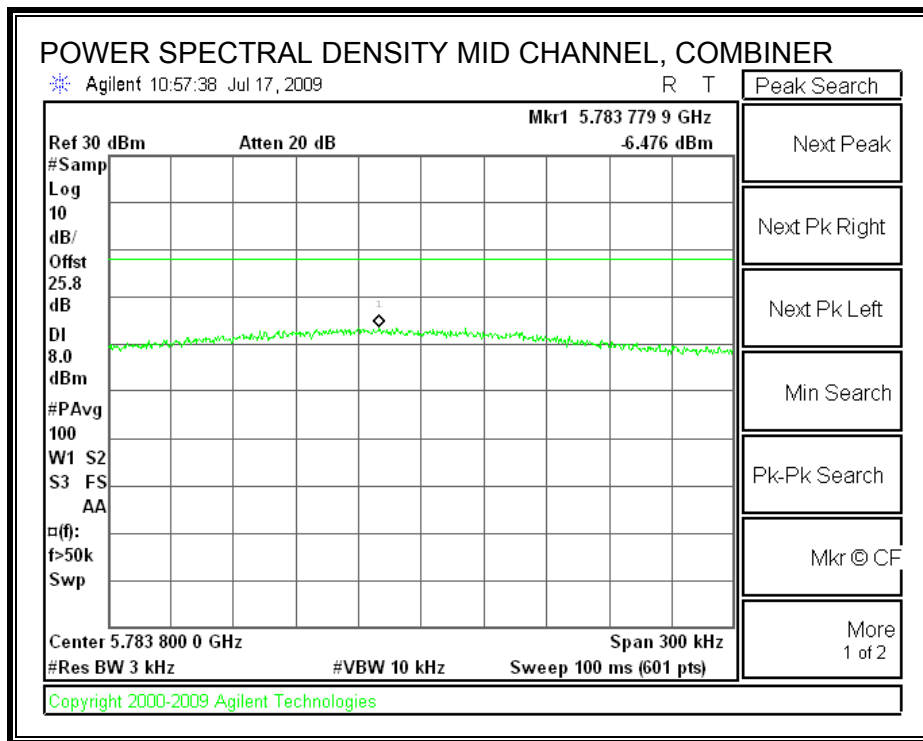
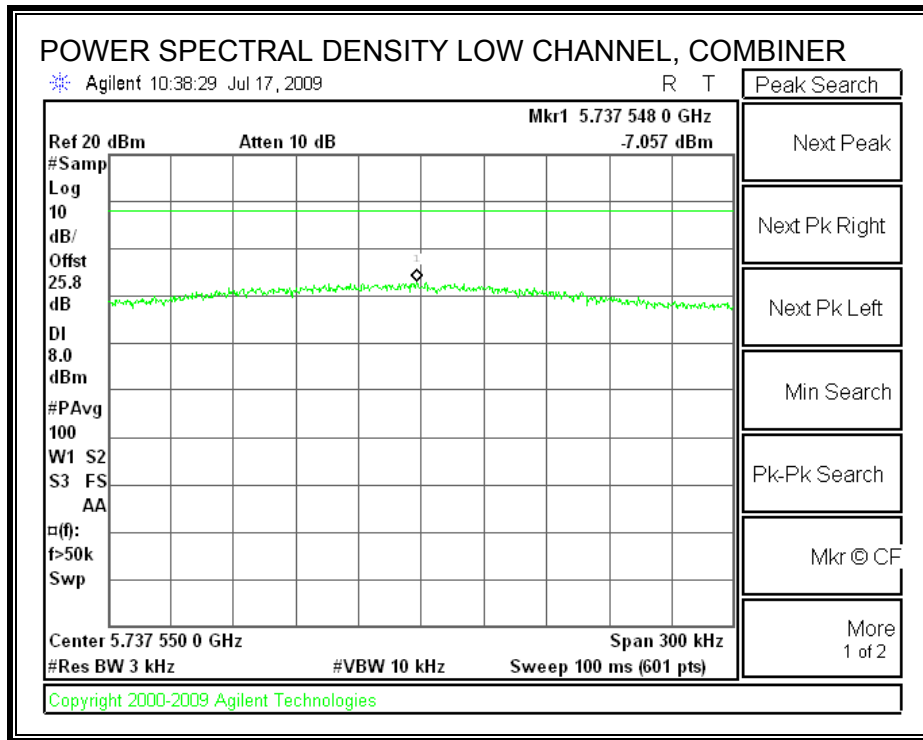

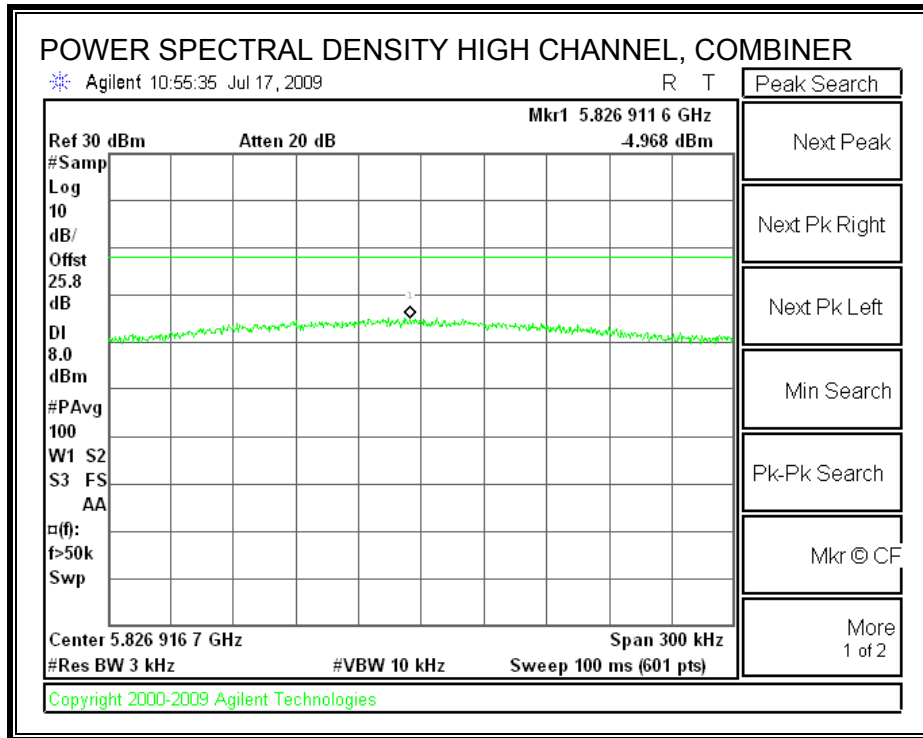

7.5.6. CONDUCTED SPURIOUS EMISSIONS

LIMITS

FCC §15.247 (d)

IC RSS-210 A8.5

Output power was measured based on the use of RMS averaging over a time interval, therefore the required attenuation is 30 dBc.

TEST PROCEDURE

The transmitter output is connected to a spectrum analyzer. The resolution bandwidth is set to 100 kHz. The video bandwidth is set to 300 kHz.

The spectrum from 30 MHz to 40 GHz is investigated with the transmitter set to the lowest, middle, and highest channels.

Preliminary tests on individual chains, and on all chains with a combiner, were performed. The worst-case configuration was with a combiner, therefore final test were performed with all chains feeding a combiner.

LOW CHANNEL SPURIOUS EMISSIONS

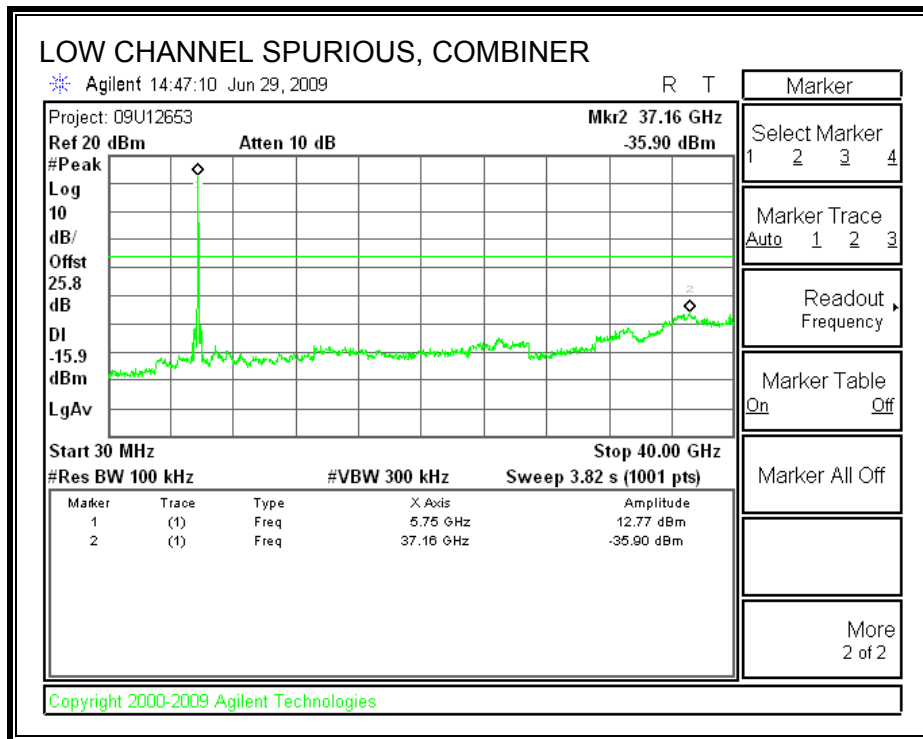
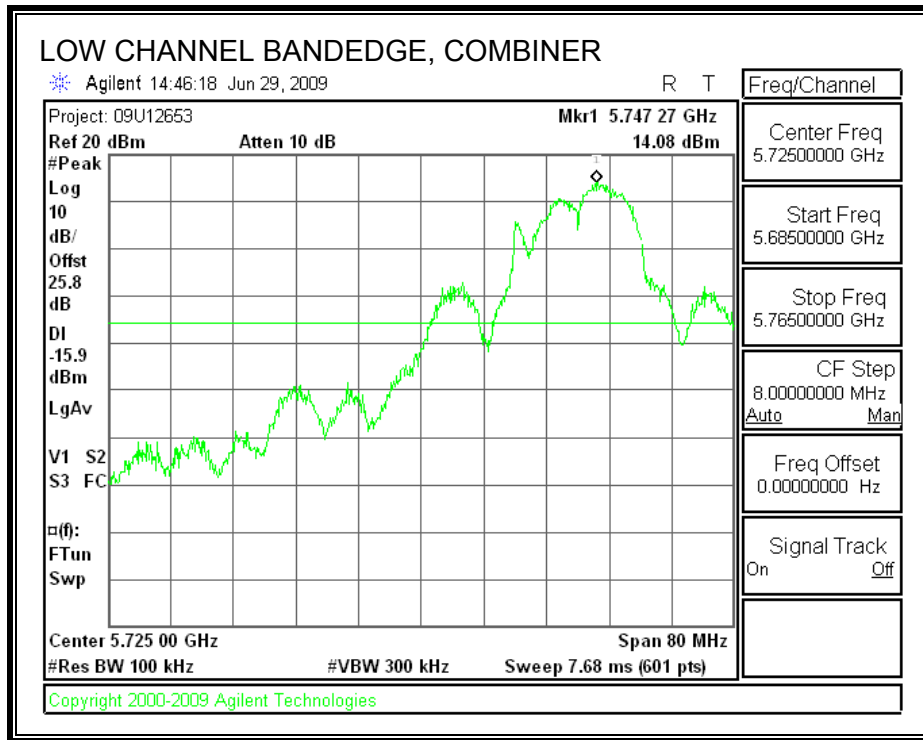

MID CHANNEL SPURIOUS EMISSIONS

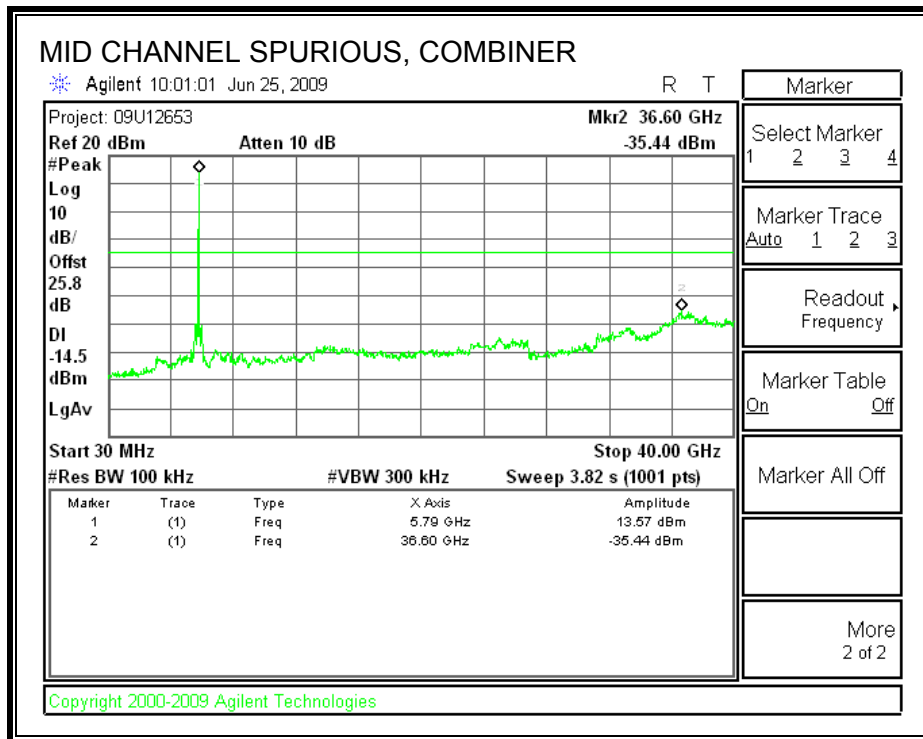
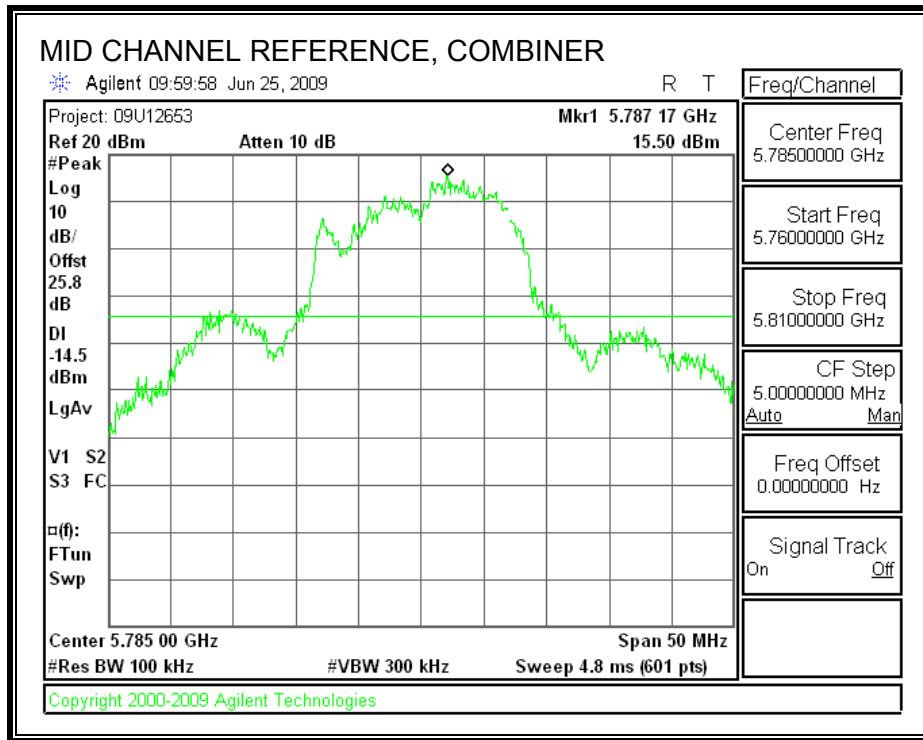

HIGH CHANNEL SPURIOUS EMISSIONS

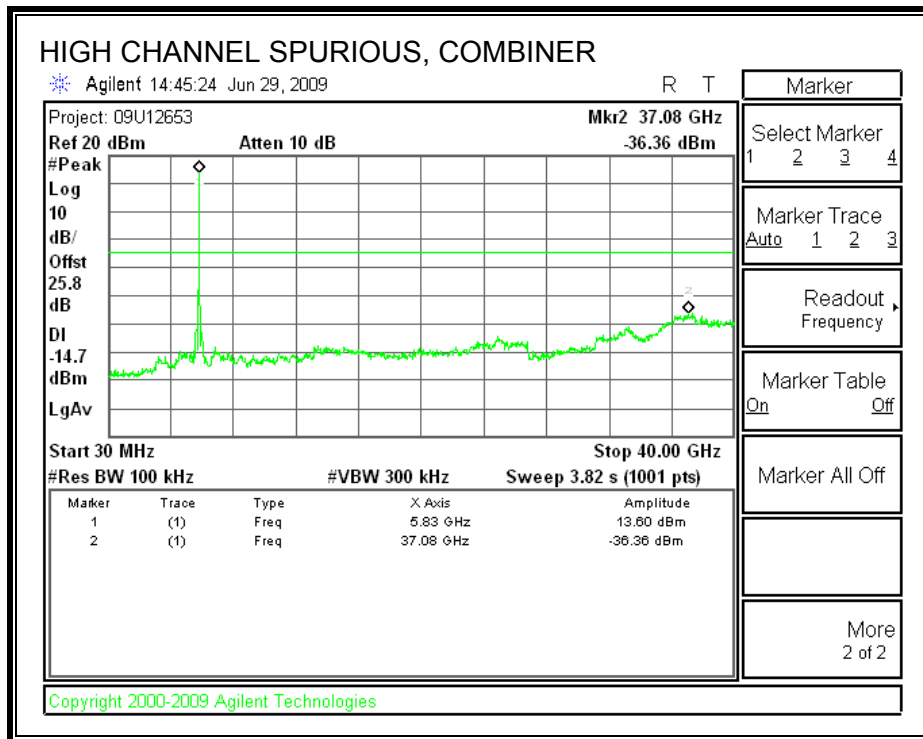
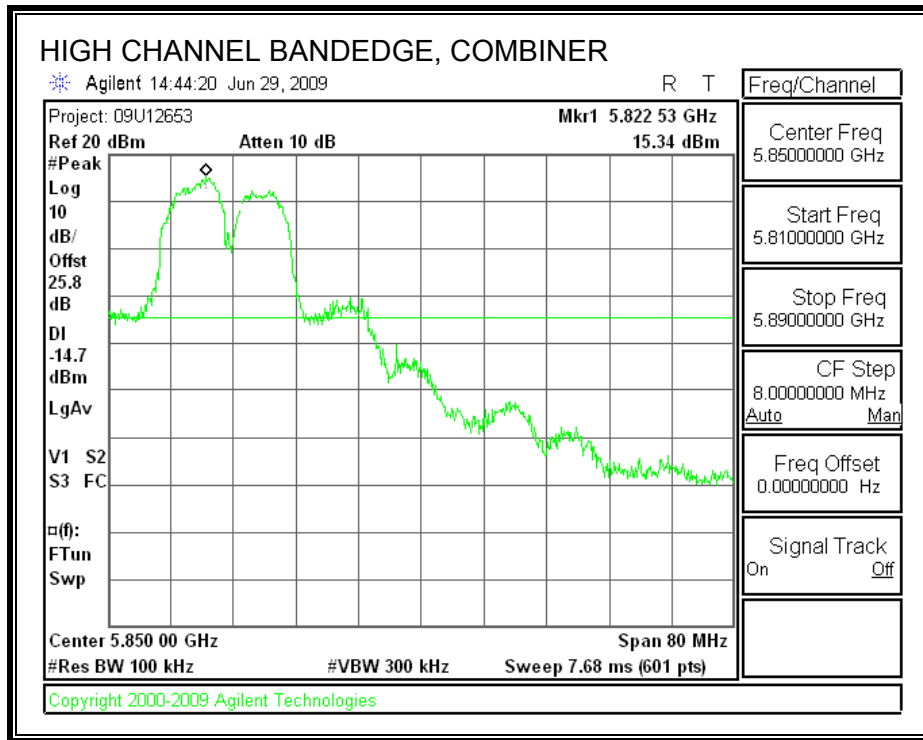

7.6. 5.8 GHz BAND CHANNEL TESTS FOR 802.11n HT20 MODE

7.6.1. 6 dB BANDWIDTH

LIMITS

FCC §15.247 (a) (2)

IC RSS-210 A8.2 (a)

The minimum 6 dB bandwidth shall be at least 500 kHz.

TEST PROCEDURE

The transmitter output is connected to a spectrum analyzer. The RBW is set to 100 kHz and the VBW is set to 300 kHz. The sweep time is coupled.

RESULTS

Channel	Frequency (MHz)	6 dB BW (MHz)	Minimum Limit (MHz)
Low	5745	17.33	0.5
Middle	5785	17.25	0.5
High	5825	16.92	0.5

6 dB BANDWIDTH

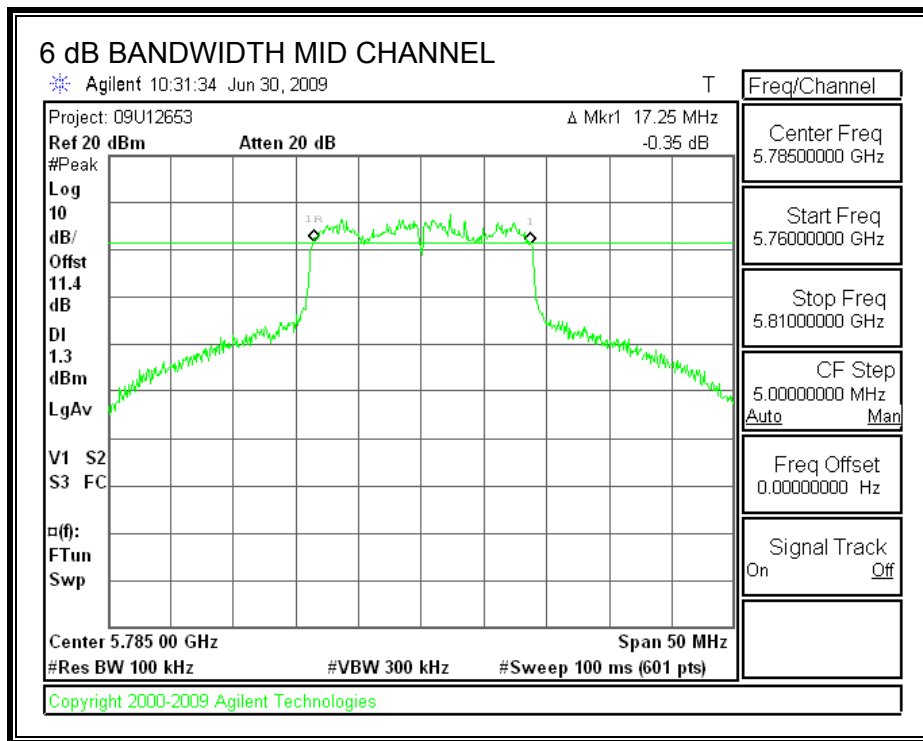
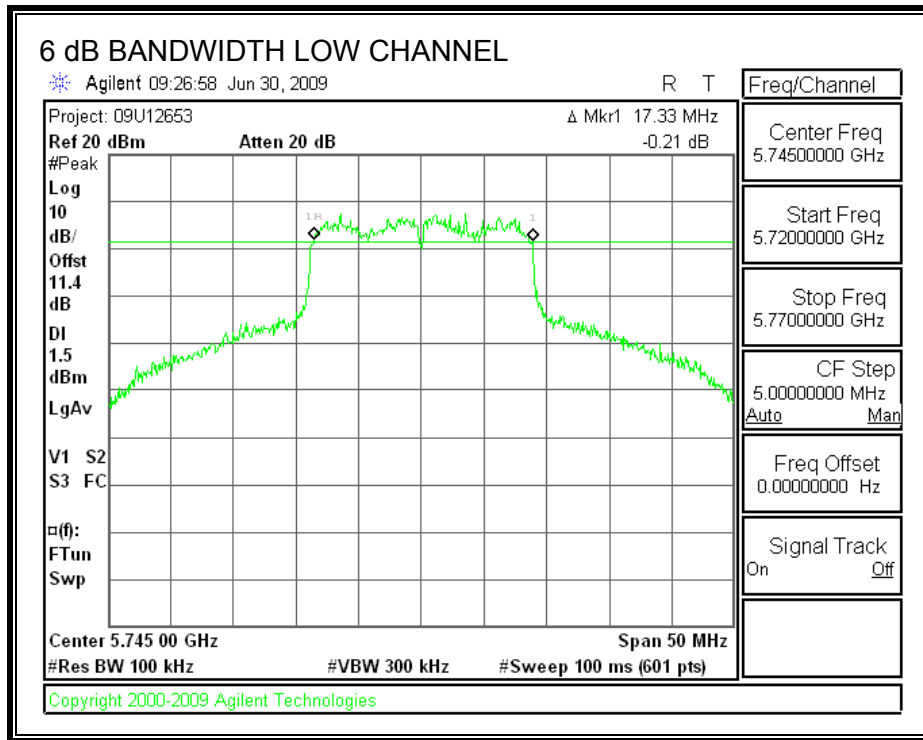

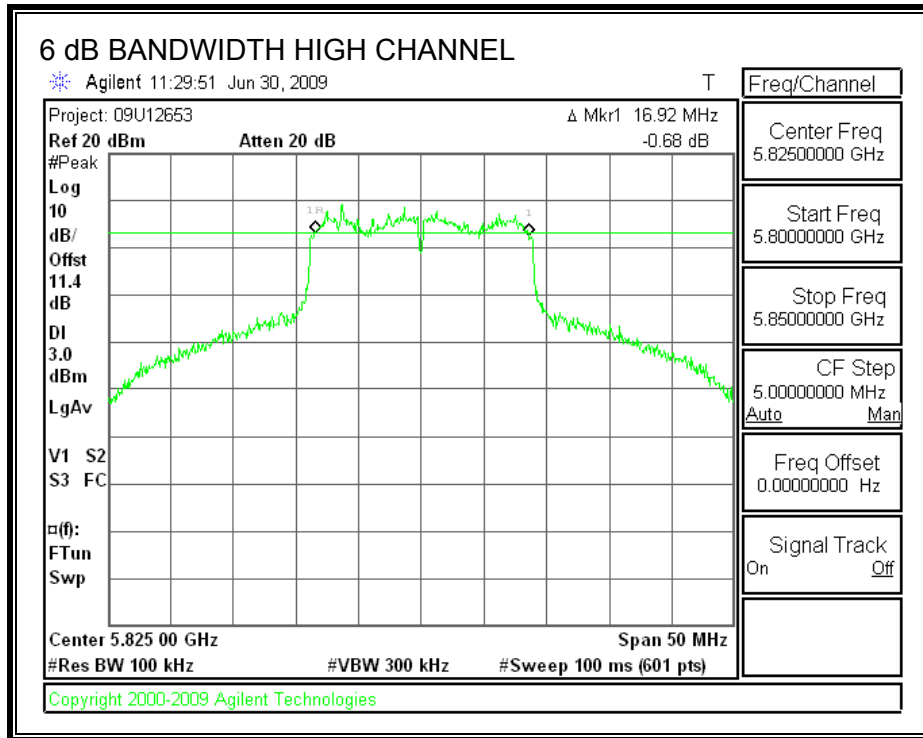

7.6.2. 99% & 26 dB BANDWIDTH

LIMITS

None; for reporting purposes only.

TEST PROCEDURE

The transmitter output is connected to the spectrum analyzer. The RBW is set to 1% to 3% of the bandwidth. The VBW is set to 3 times the RBW. The sweep time is coupled. The spectrum analyzer internal bandwidth measurement function is utilized.

RESULTS

Channel	Frequency (MHz)	99% OBW (MHz)	26 dB BW (MHz)
Low	5745	17.70	31.38
Middle	5785	17.70	31.96
High	5825	17.81	31.20

99% & 26 dB BANDWIDTH

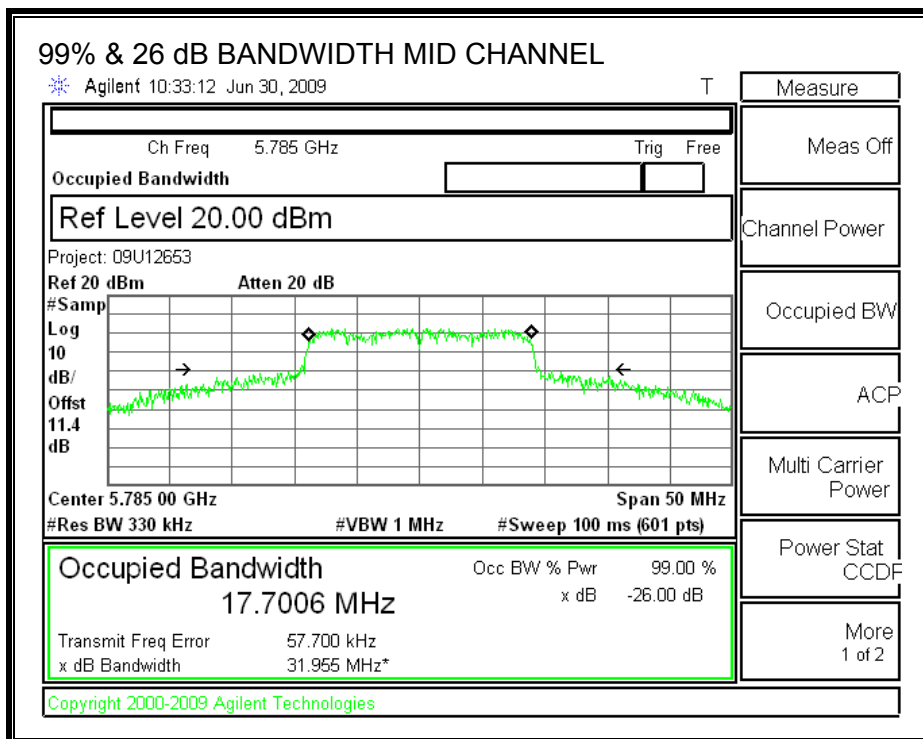
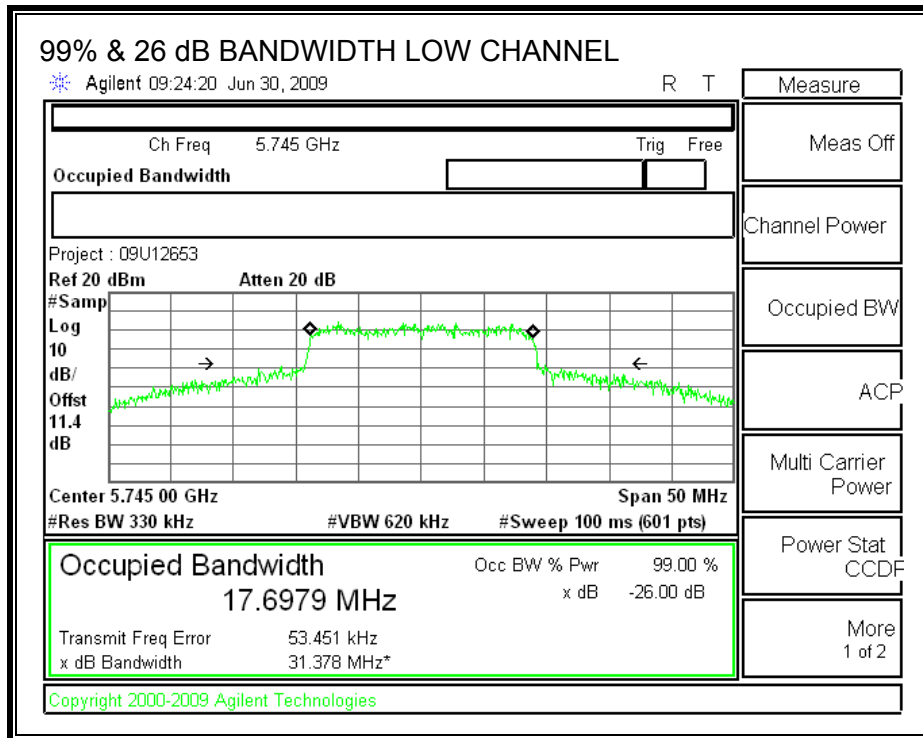

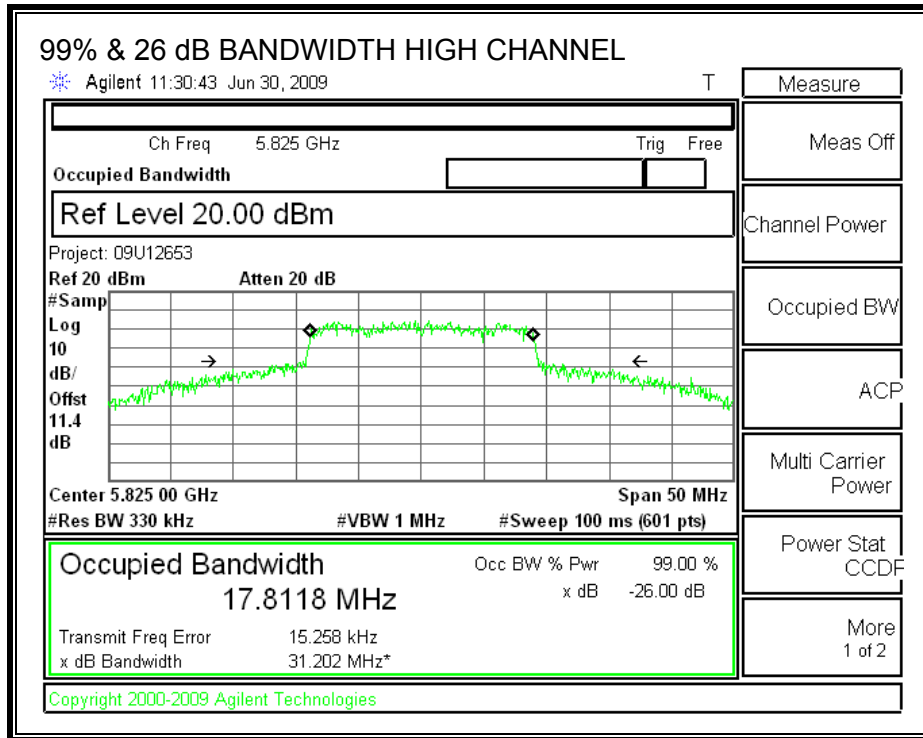

7.6.3. OUTPUT POWER

LIMITS

FCC §15.247 (b)

IC RSS-210 A8.4

TEST PROCEDURE

Output power was measured based on the use of RMS averaging over a time interval in accordance with FCC document "Measurement of Digital Transmission Systems Operating under Section 15.247", March 23, 2005.

RESULTS

The maximum antenna gain is less than 6 dBi, therefore the limit is 30 dBm.

Channel	Frequency (MHz)	Chain 0 Power (dBm)	Chain 1 Power (dBm)	Chain 2 Power (dBm)	Chain 3 Power (dBm)	Total Power (dBm)	Limit (dBm)	Margin (dB)
Low	5745	19.17	19.14	19.10	19.22	25.18	30.00	-4.82
Mid	5785	19.07	19.19	19.01	19.09	25.11	30.00	-4.89
High	5825	19.21	19.16	19.25	19.05	25.19	30.00	-4.81

OUTPUT POWER, LOW CHANNEL

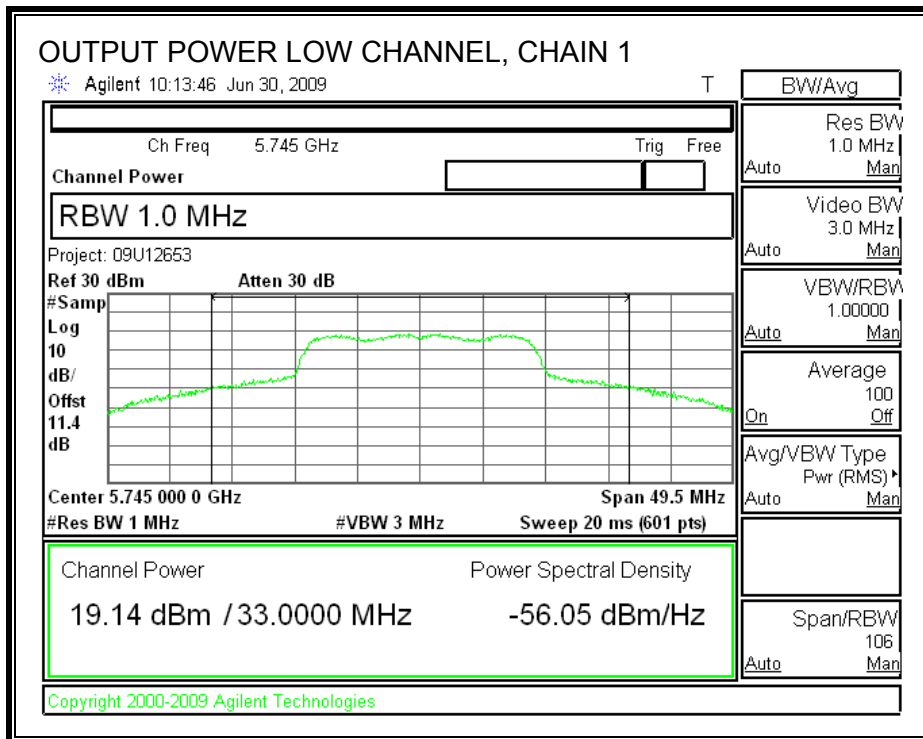
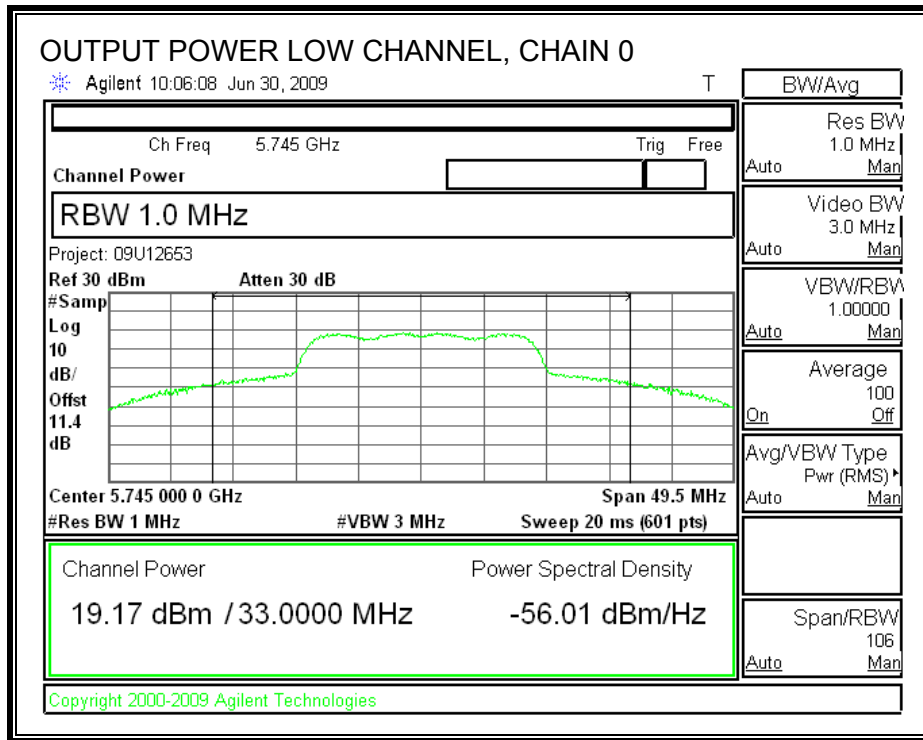

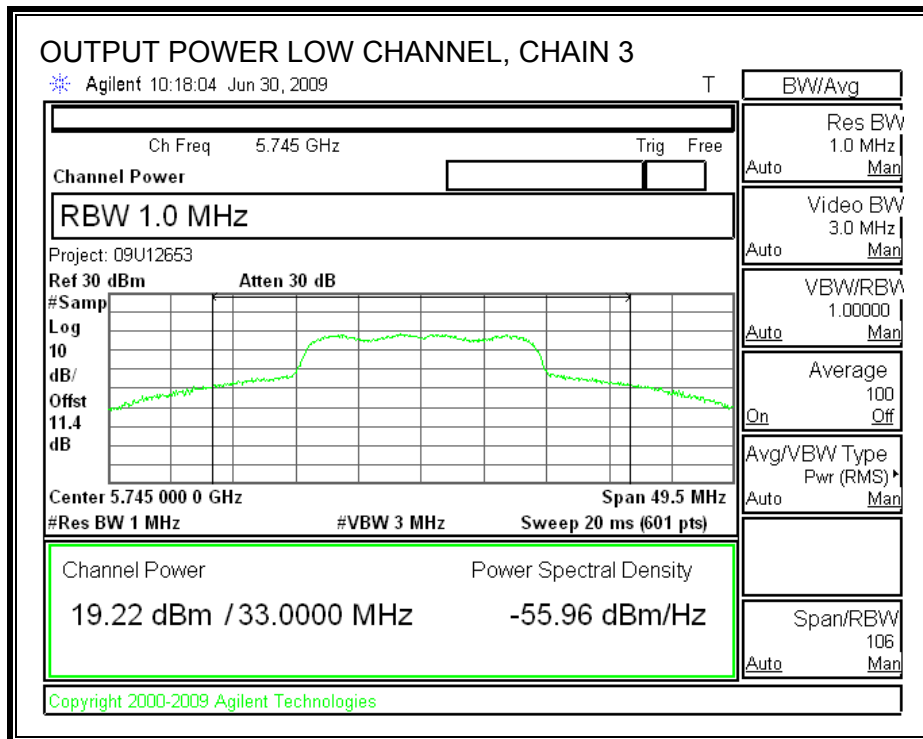
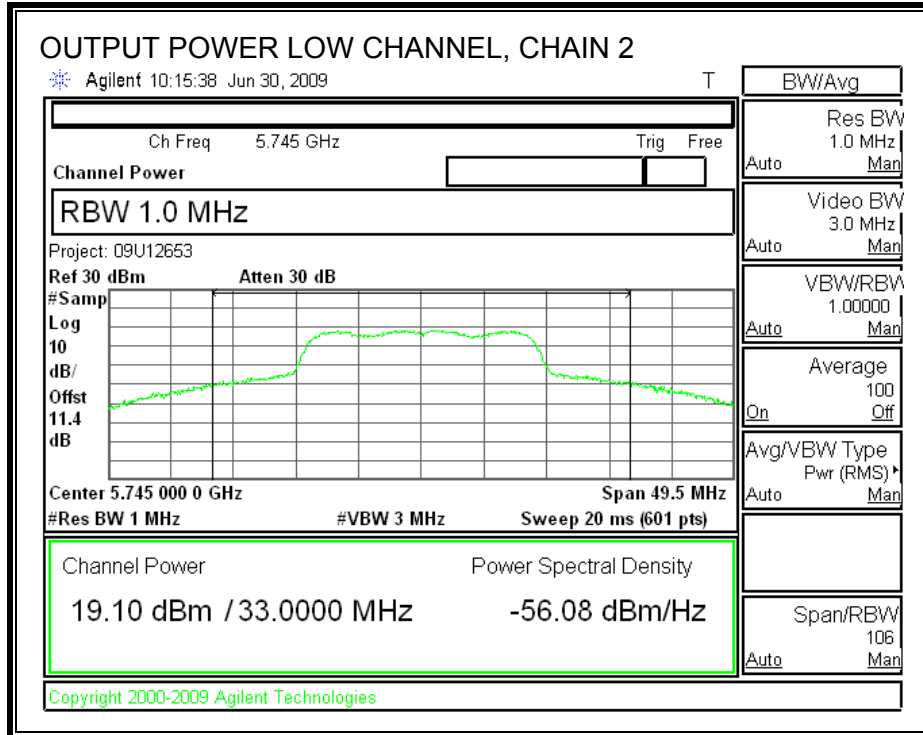

OUTPUT POWER, MID CHANNEL

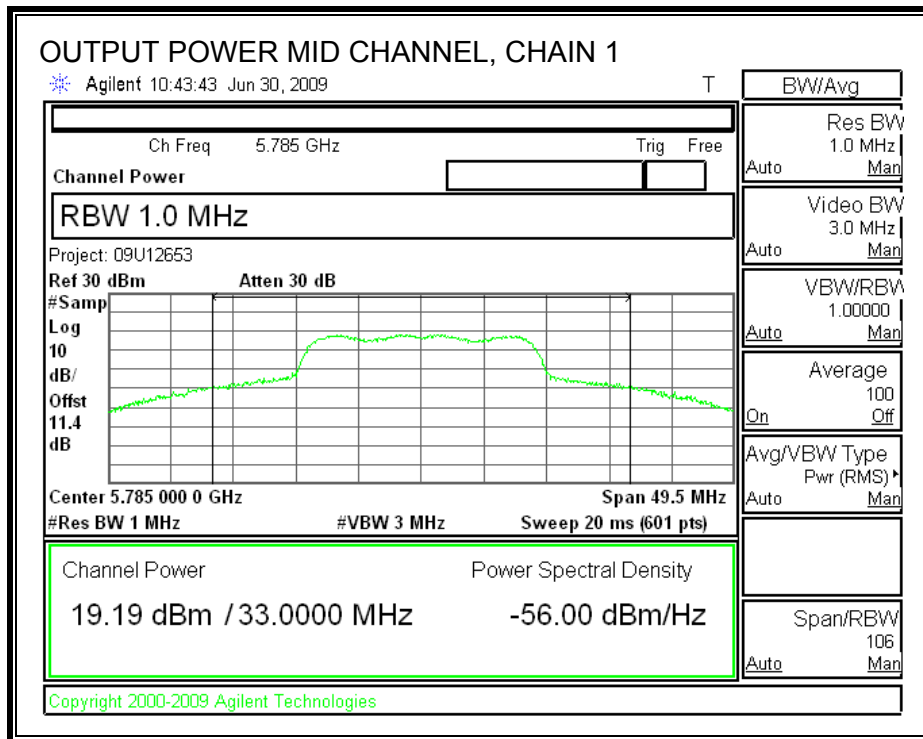
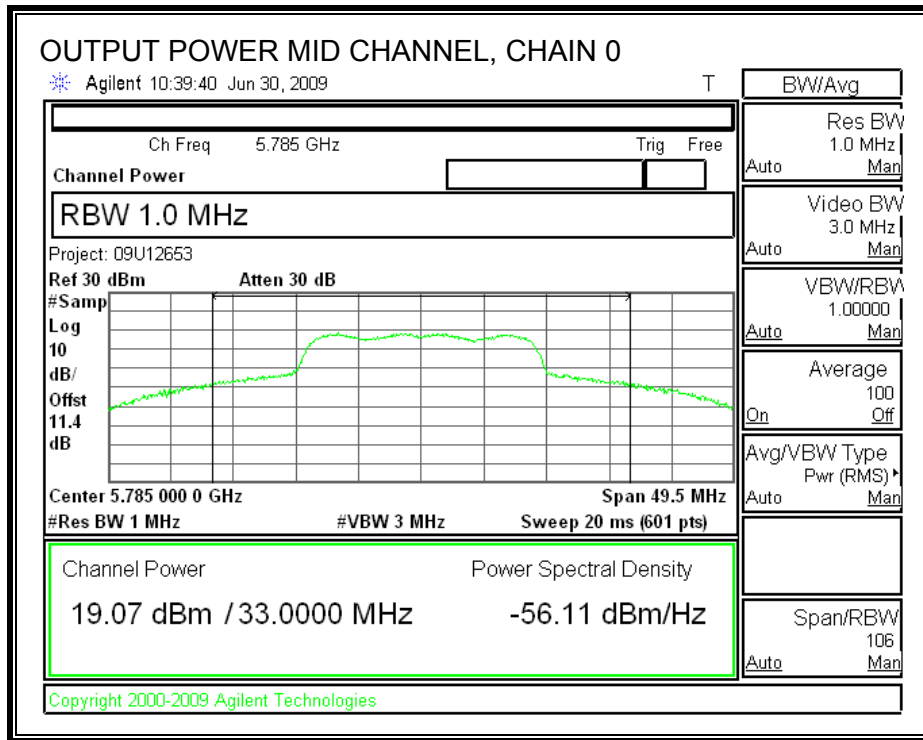

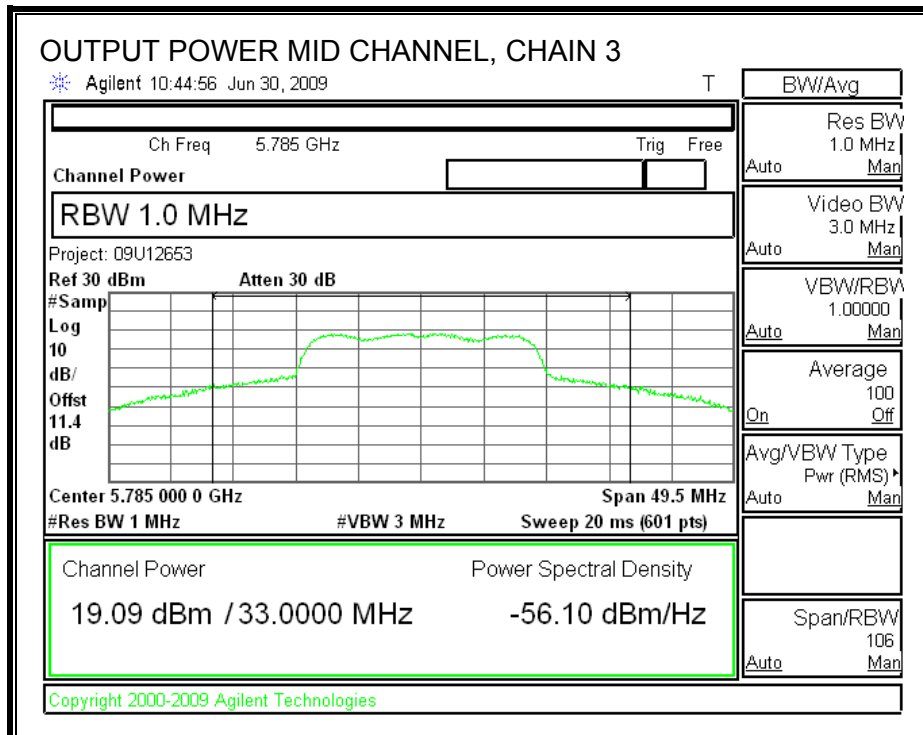
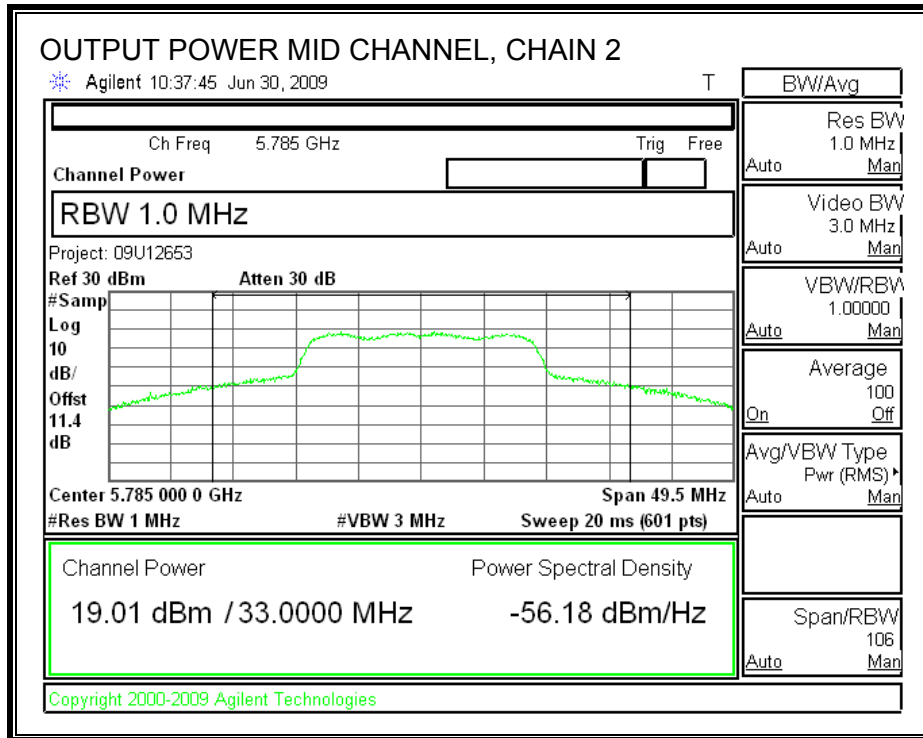

OUTPUT POWER, HIGH CHANNEL

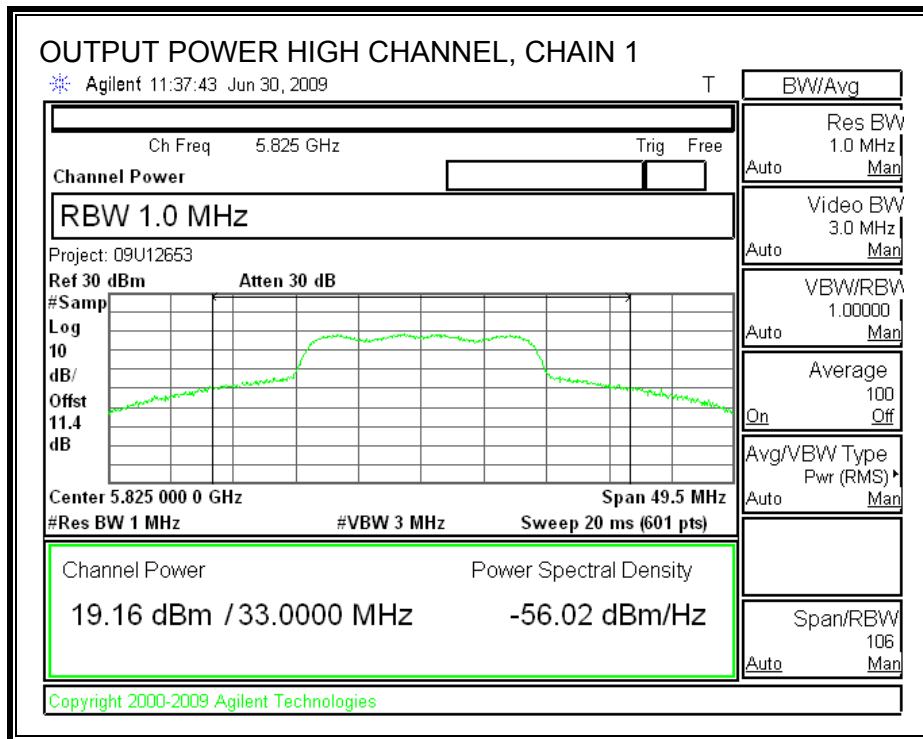
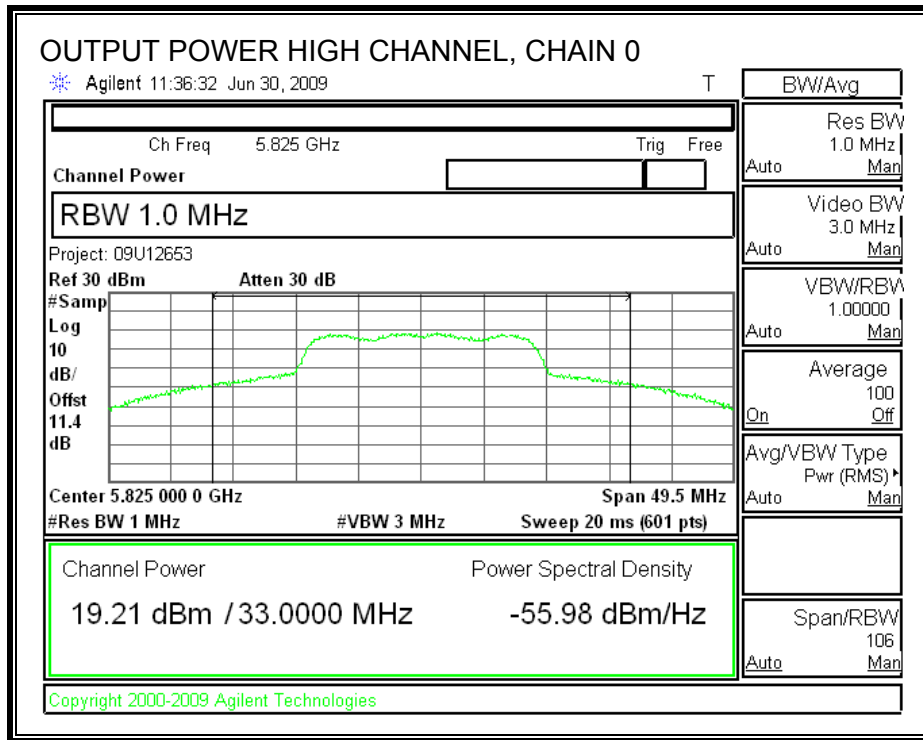

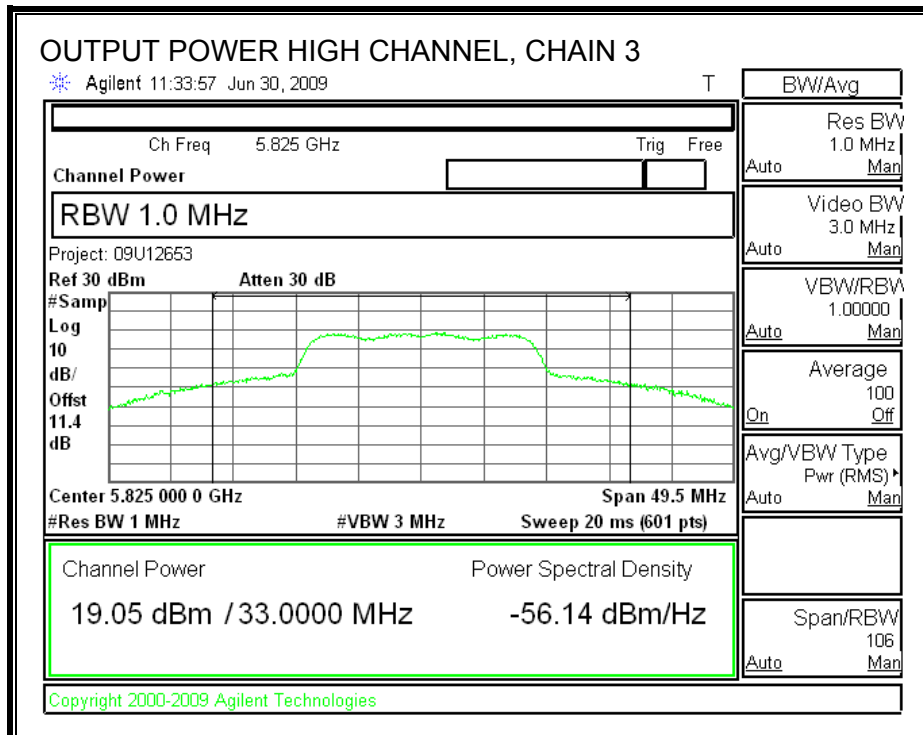
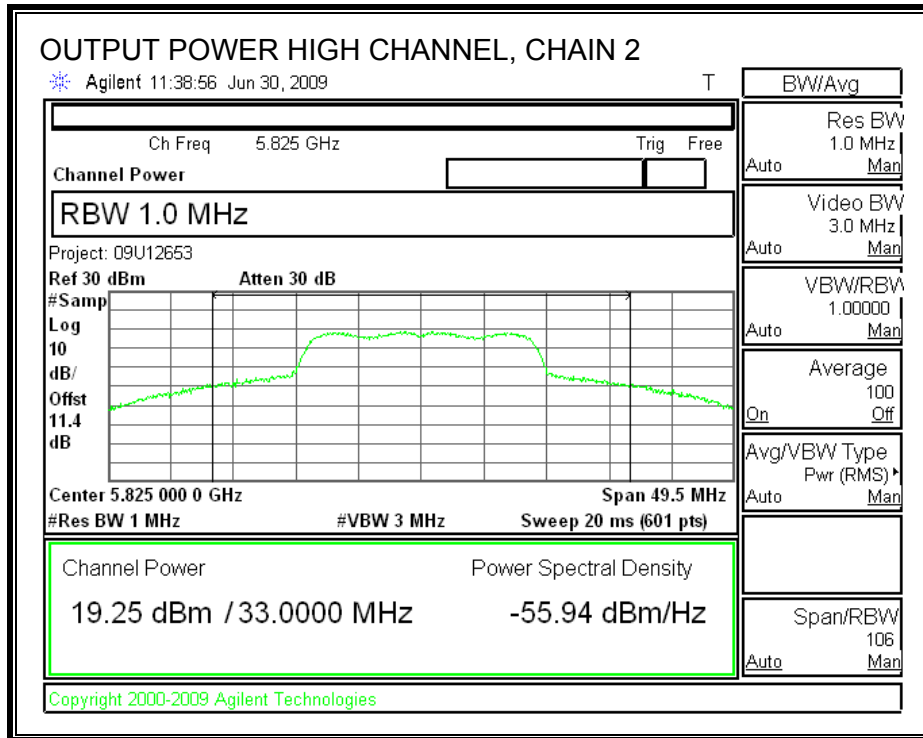

7.6.4. AVERAGE POWER

LIMITS

None; for reporting purposes only.

TEST PROCEDURE

The transmitter output is connected to a power meter.

The cable assembly insertion loss of 11.4 dB (including 10 dB pad and 1.4 dB cable) was entered as an offset in the power meter to allow for direct reading of power.

RESULTS

Channel	Frequency (MHz)	Chain 0 Power (dBm)	Chain 1 Power (dBm)	Chain 2 Power (dBm)	Chain 3 Power (dBm)
Low	5745	19.13	19.20	19.28	19.24
Middle	5785	19.28	19.11	19.17	19.14
High	5825	19.10	19.12	19.29	19.22

7.6.5. POWER SPECTRAL DENSITY

LIMITS

FCC §15.247 (e)

IC RSS-210 A8.2 (b)

The power spectral density conducted from the transmitter to the antenna shall not be greater than 8 dBm in any 3 kHz band during any time interval of continuous transmission.

TEST PROCEDURE

Output power was measured based on the use of RMS averaging over a time interval, therefore the power spectral density was measured using PSD Option 2 in accordance with FCC document "Measurement of Digital Transmission Systems Operating under Section 15.247", March 23, 2005.

Preliminary tests on individual chains, and on all chains with a combiner, were performed. The worst-case configuration was with a combiner, therefore final test were performed with all chains feeding a combiner.

RESULTS

Channel	Frequency (MHz)	PSD with Combiner (dBm)	Limit (dBm)	Margin (dB)
Low	5745	-1.956	8	-9.96
Middle	5785	0.101	8	-7.90
High	5825	1.807	8	-6.19

POWER SPECTRAL DENSITY

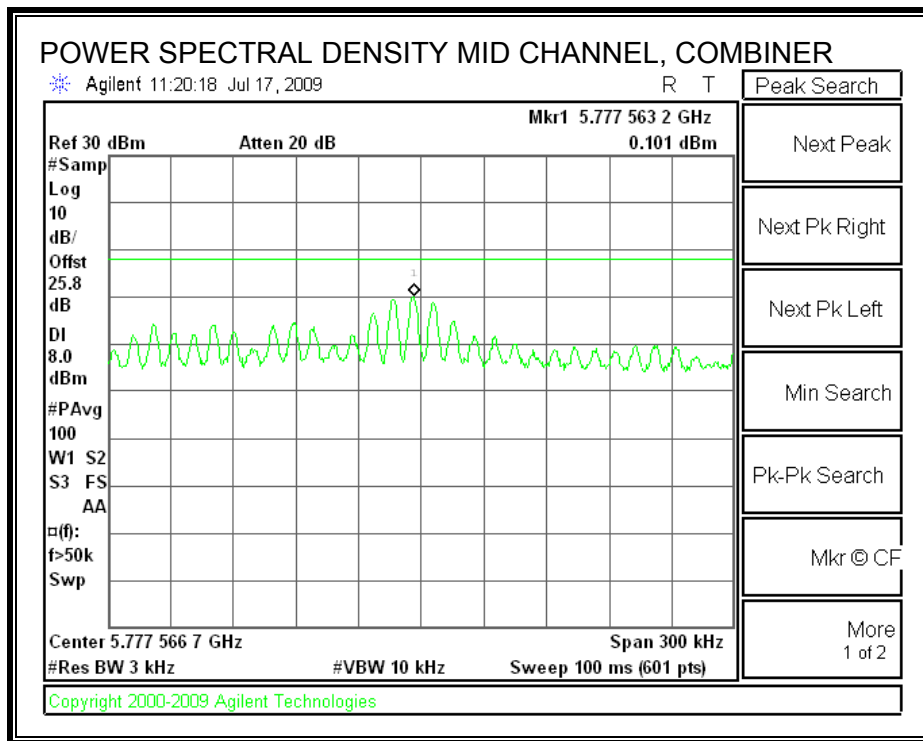
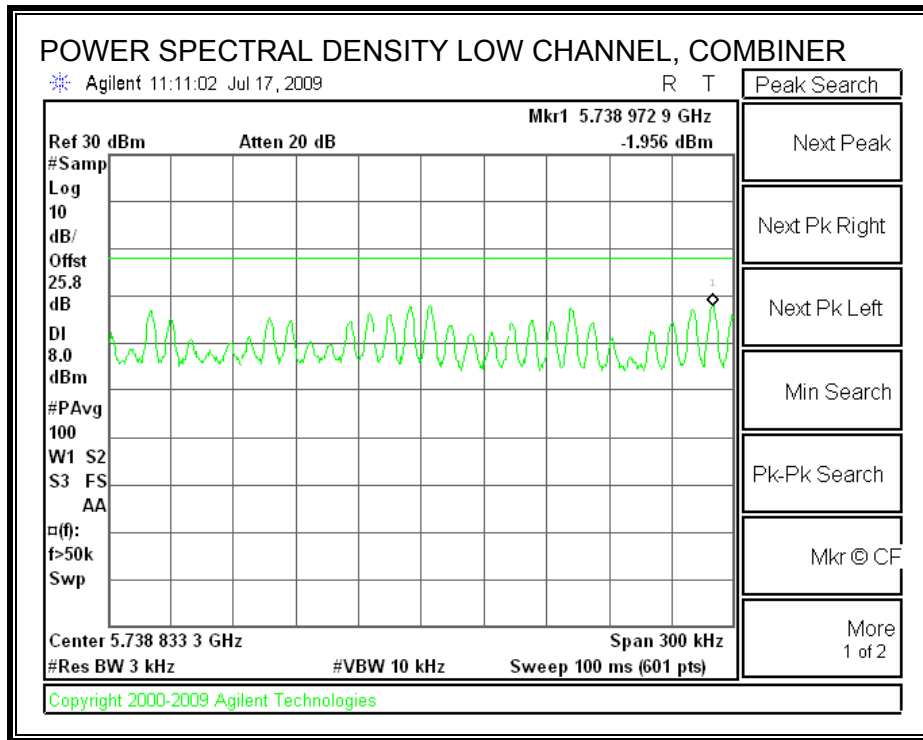

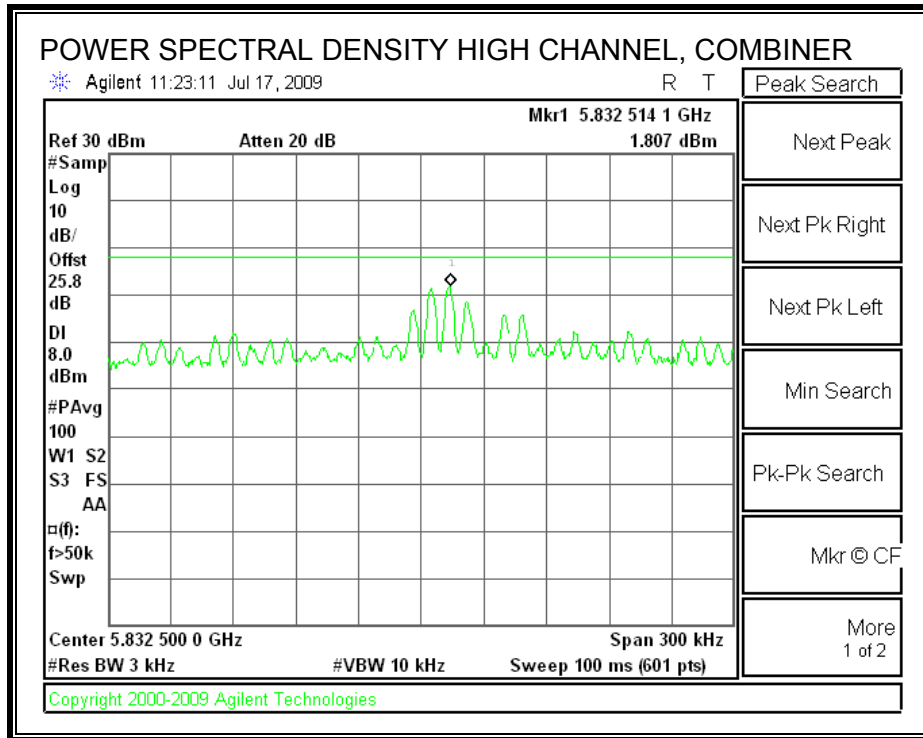

7.6.6. CONDUCTED SPURIOUS EMISSIONS

LIMITS

FCC §15.247 (d)

IC RSS-210 A8.5

Output power was measured based on the use of RMS averaging over a time interval, therefore the required attenuation is 30 dBc.

TEST PROCEDURE

The transmitter output is connected to a spectrum analyzer. The resolution bandwidth is set to 100 kHz. The video bandwidth is set to 300 kHz.

The spectrum from 30 MHz to 40 GHz is investigated with the transmitter set to the lowest, middle, and highest channels.

Preliminary tests on individual chains, and on all chains with a combiner, were performed. The worst-case configuration was with a combiner, therefore final test were performed with all chains feeding a combiner.

LOW CHANNEL SPURIOUS EMISSIONS

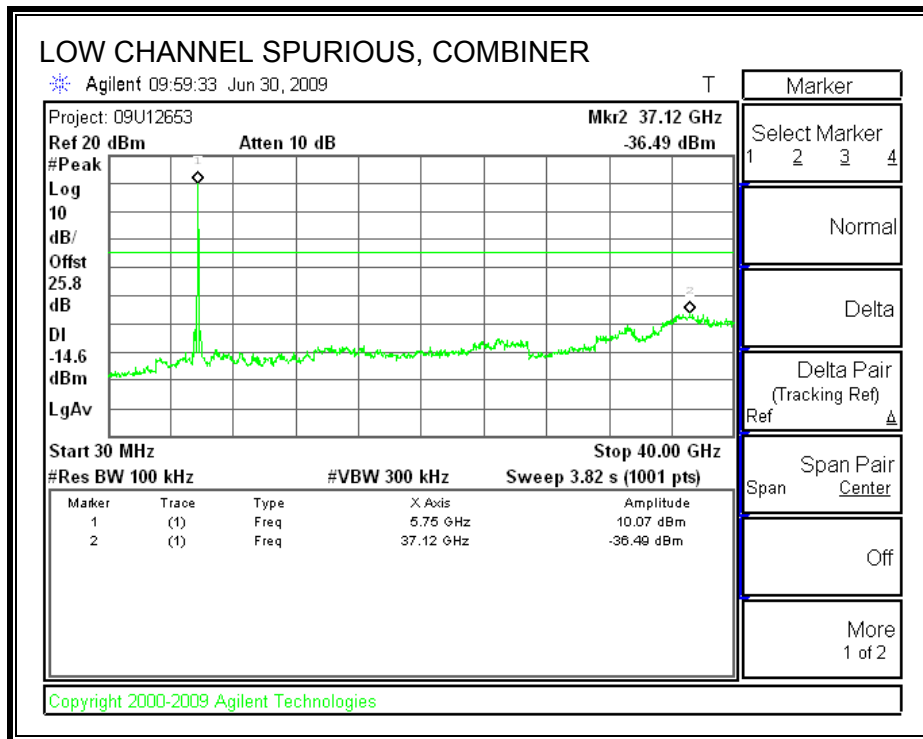
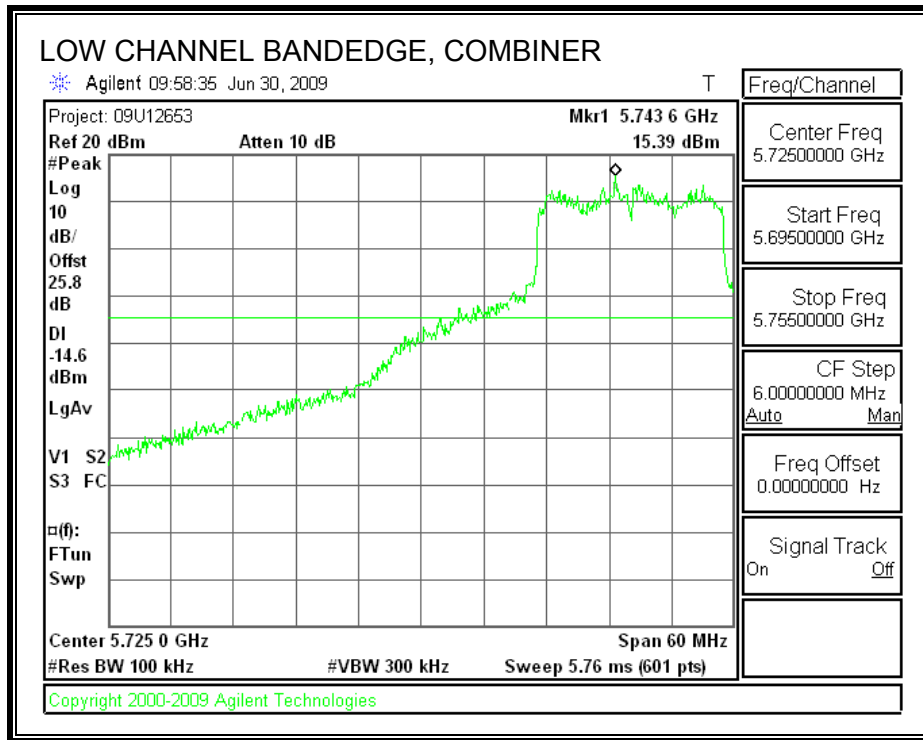

MID CHANNEL SPURIOUS EMISSIONS

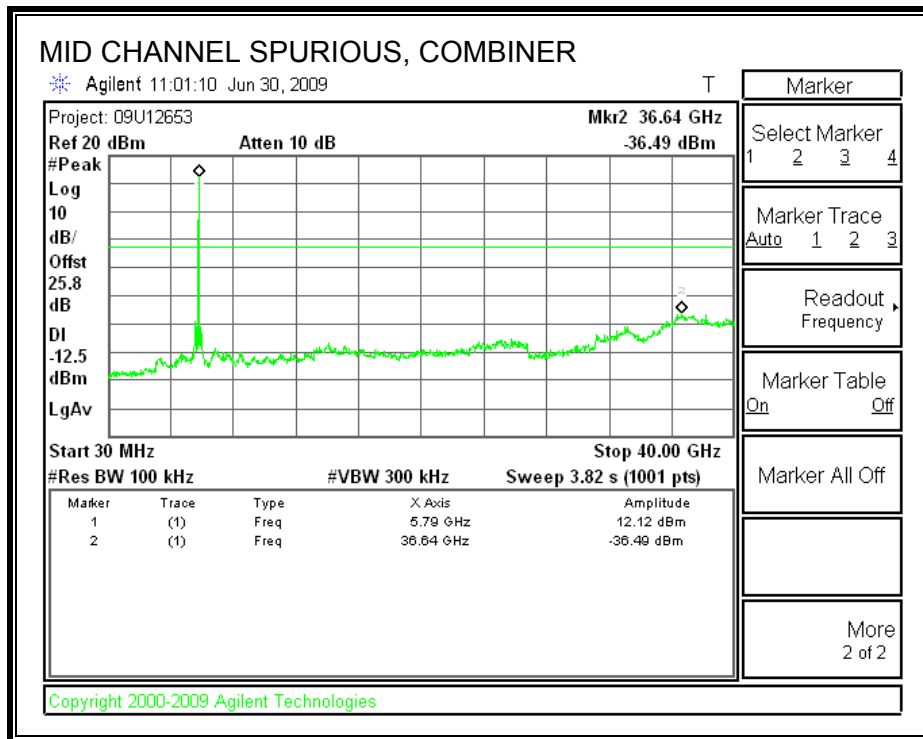
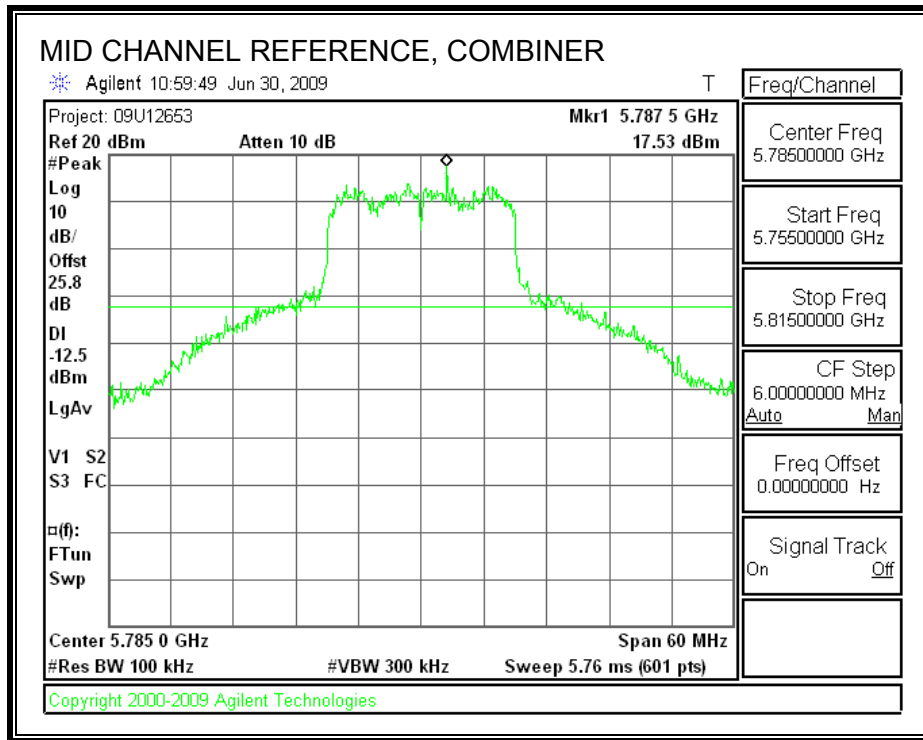

HIGH CHANNEL SPURIOUS EMISSIONS

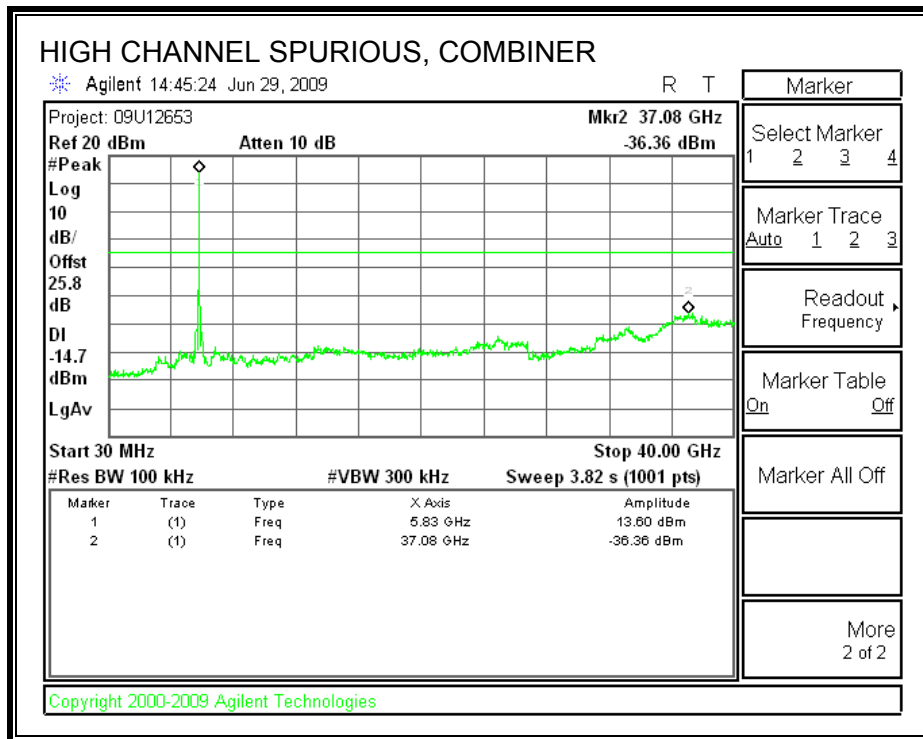
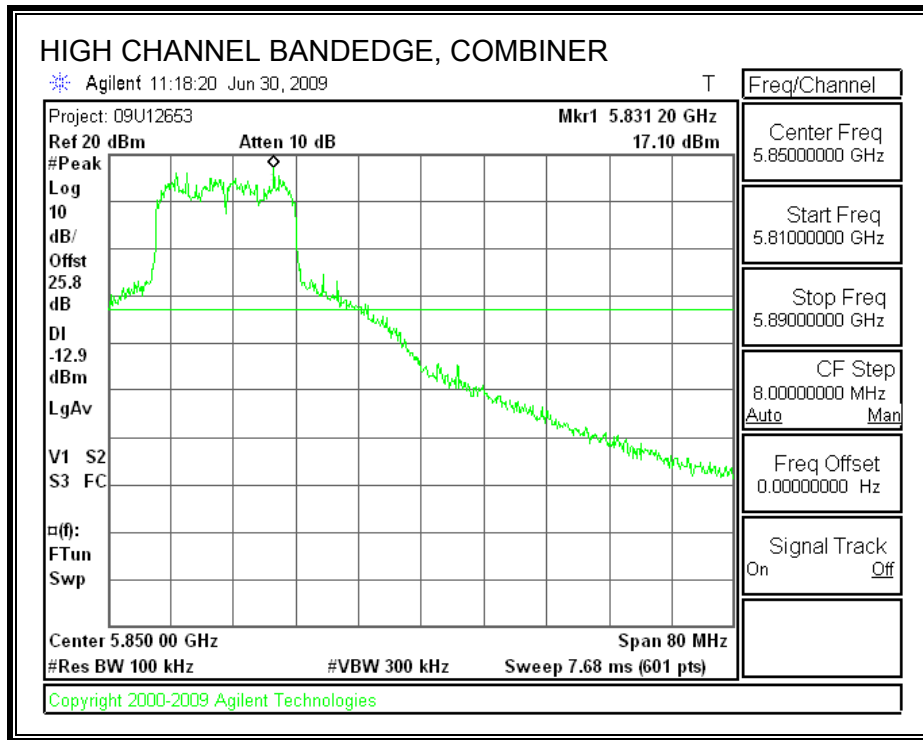

7.7. 5.8 GHz BAND CHANNEL TESTS FOR 802.11n HT40 MODE

7.7.1. 6 dB BANDWIDTH

LIMITS

FCC §15.247 (a) (2)

IC RSS-210 A8.2 (a)

The minimum 6 dB bandwidth shall be at least 500 kHz.

TEST PROCEDURE

The transmitter output is connected to a spectrum analyzer. The RBW is set to 100 kHz and the VBW is set to 300 kHz. The sweep time is coupled.

RESULTS

Channel	Frequency (MHz)	6 dB BW (MHz)	Minimum Limit (MHz)
Low	5755	34.53	0.5
High	5795	35.73	0.5

6 dB BANDWIDTH

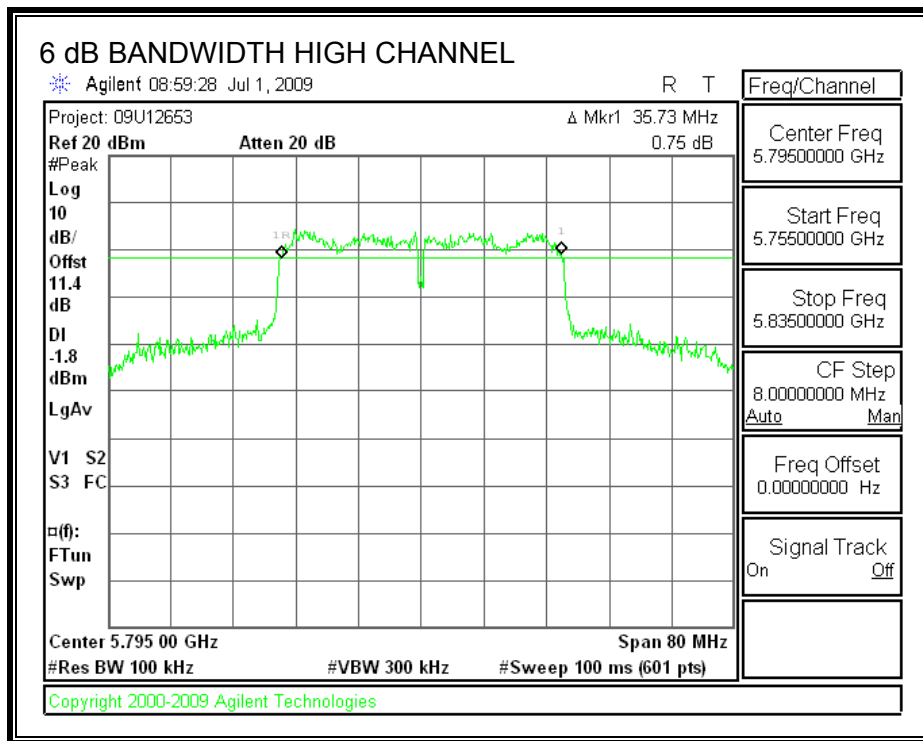
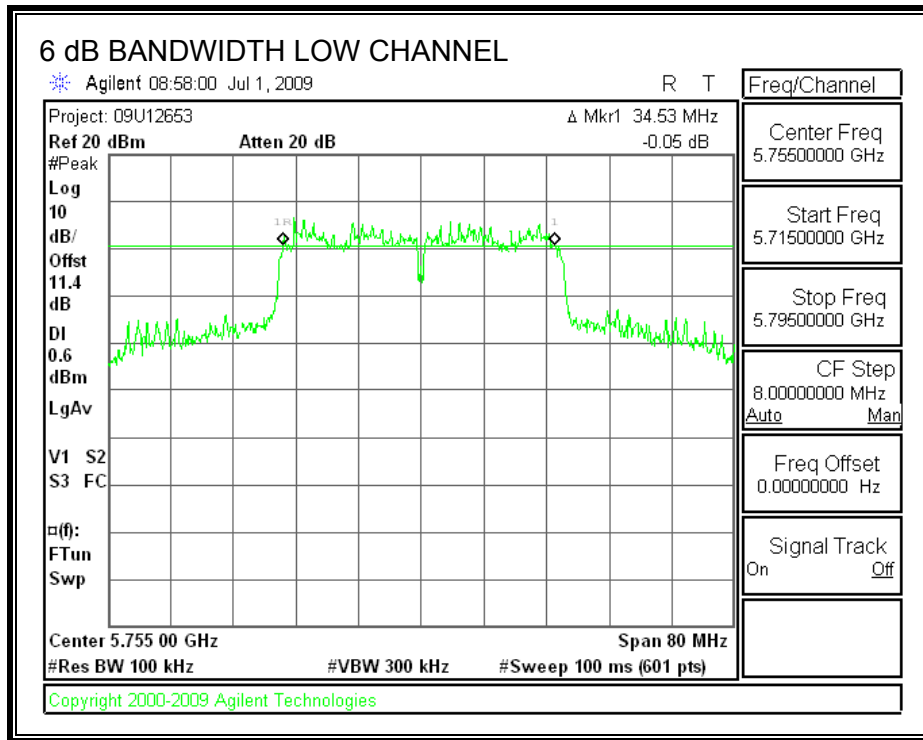

7.7.2. 99% & 26 dB BANDWIDTH

LIMITS

None; for reporting purposes only.

TEST PROCEDURE

The transmitter output is connected to the spectrum analyzer. The RBW is set to 1% to 3% of the bandwidth. The VBW is set to 3 times the RBW. The sweep time is coupled. The spectrum analyzer internal bandwidth measurement function is utilized.

RESULTS

Channel	Frequency (MHz)	99% OBW (MHz)	26 dB BW (MHz)
Low	5755	36.3794	56.15
High	5795	36.4502	57.57

99% & 26 dB BANDWIDTH

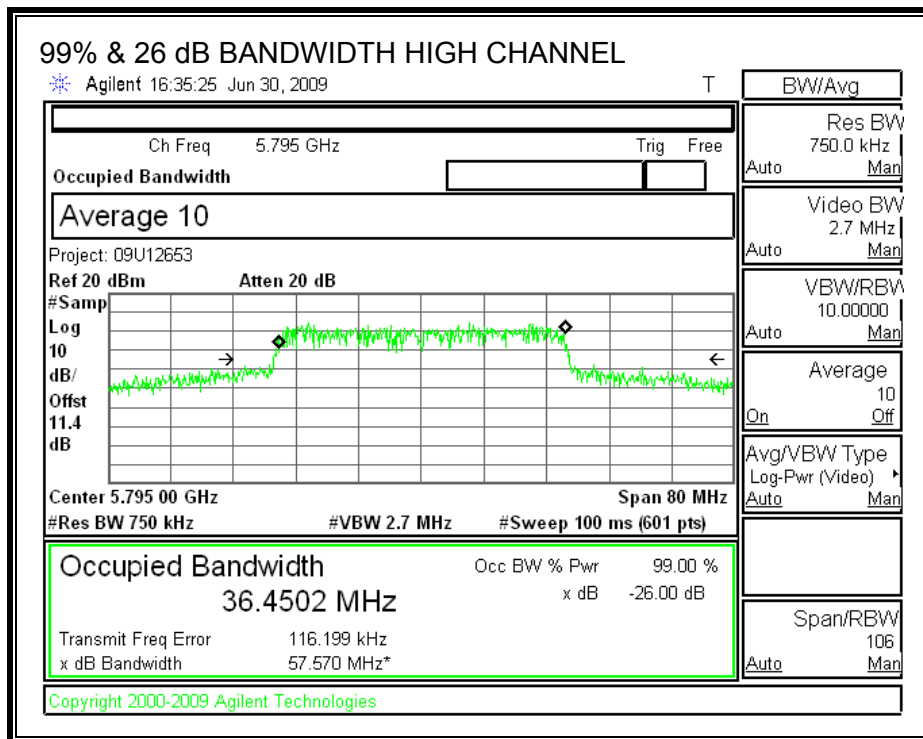
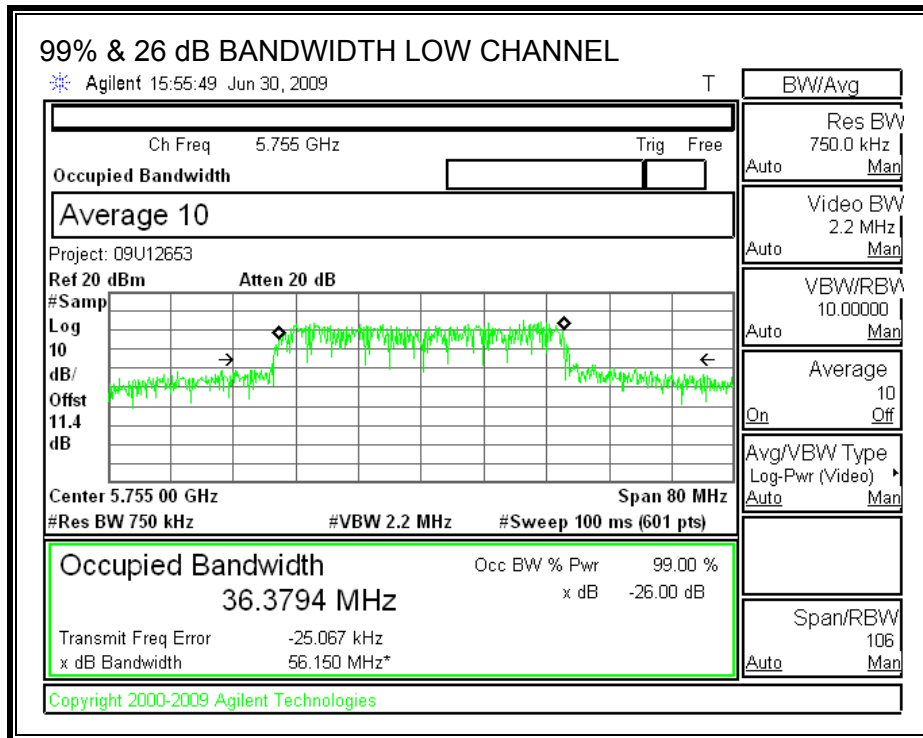

7.7.3. OUTPUT POWER

LIMITS

FCC §15.247 (b)

IC RSS-210 A8.4

TEST PROCEDURE

Output power was measured based on the use of RMS averaging over a time interval in accordance with FCC document "Measurement of Digital Transmission Systems Operating under Section 15.247", March 23, 2005.

RESULTS

The maximum antenna gain is less than 6 dBi; therefore the limit is 30 dBm.

Channel	Frequency (MHz)	Chain 0 Power (dBm)	Chain 1 Power (dBm)	Chain 2 Power (dBm)	Chain 3 Power (dBm)	Total Power (dBm)	Limit (dBm)	Margin (dB)
Low	5755	18.07	18.18	18.17	18.24	24.19	30.00	-5.81
High	5795	19.23	19.11	18.96	19.17	25.14	30.00	-4.86

OUTPUT POWER, LOW CHANNEL

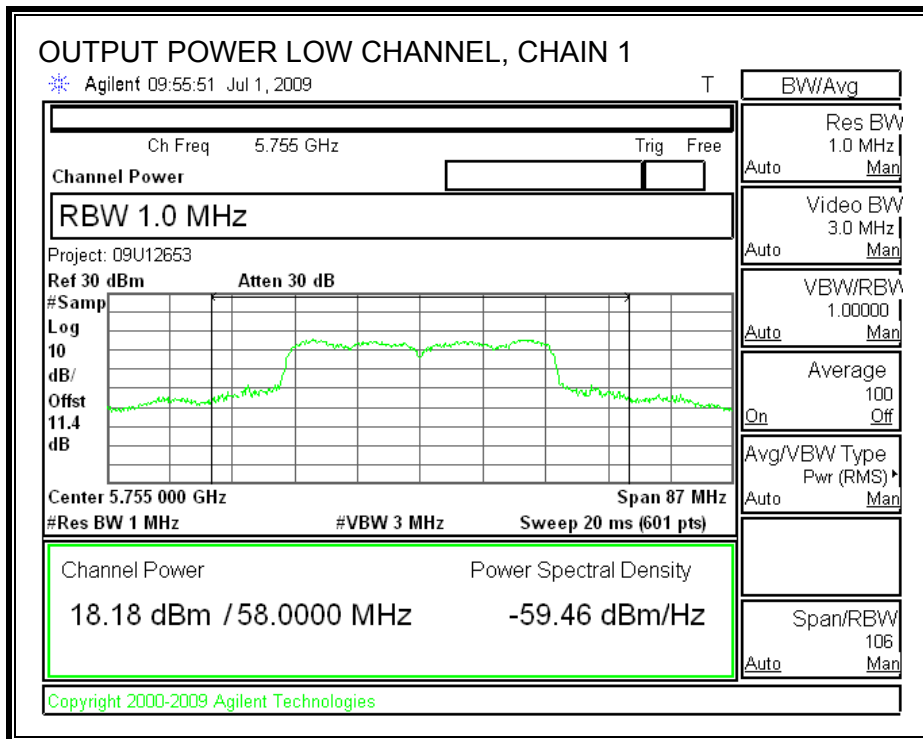
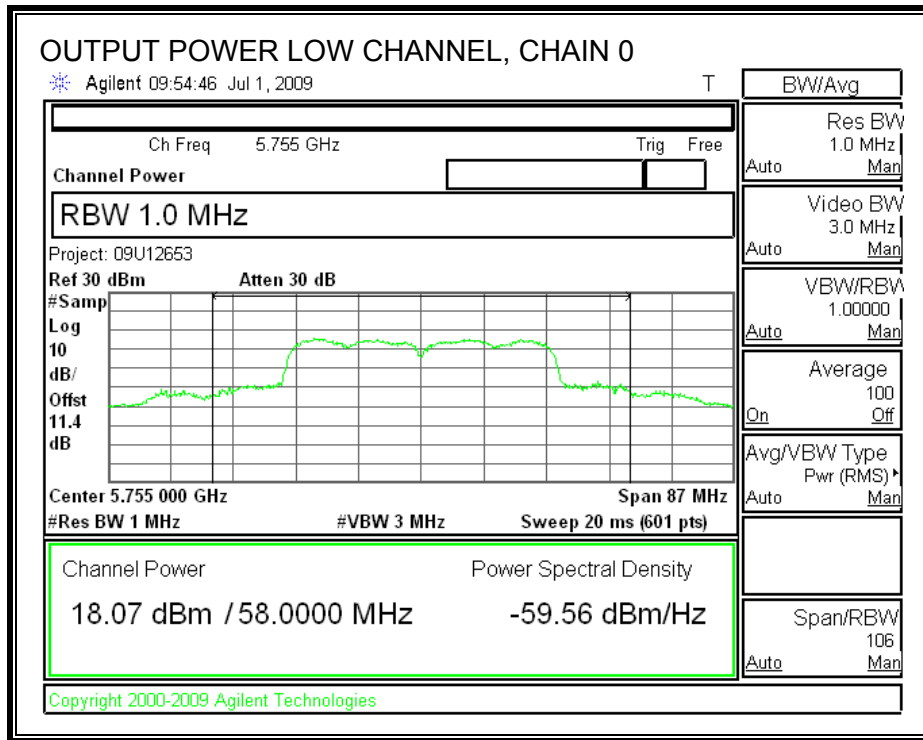

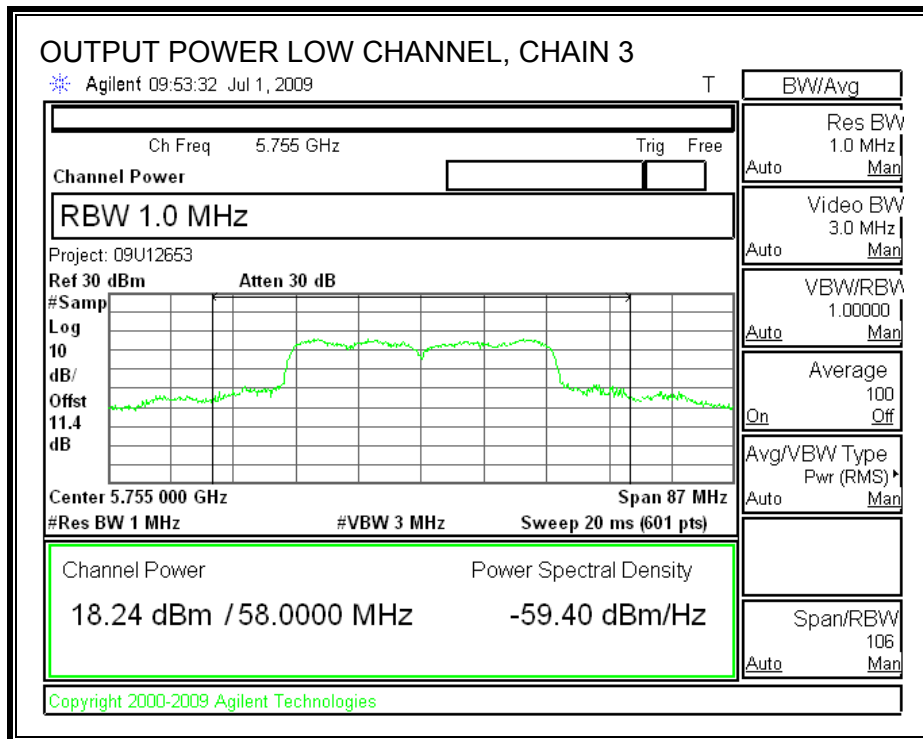
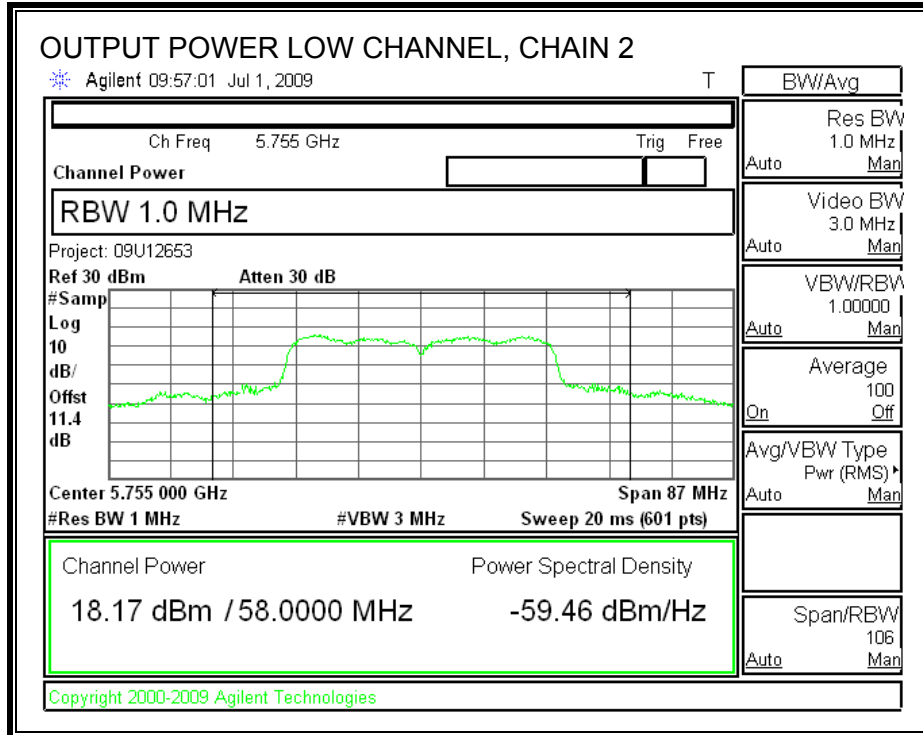

OUTPUT POWER, HIGH CHANNEL

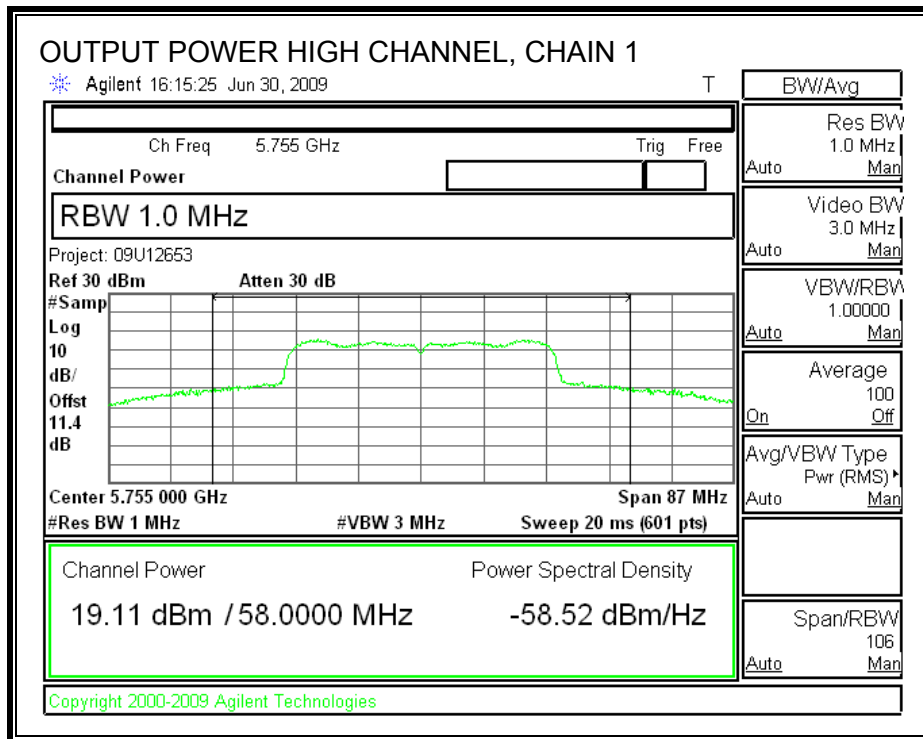
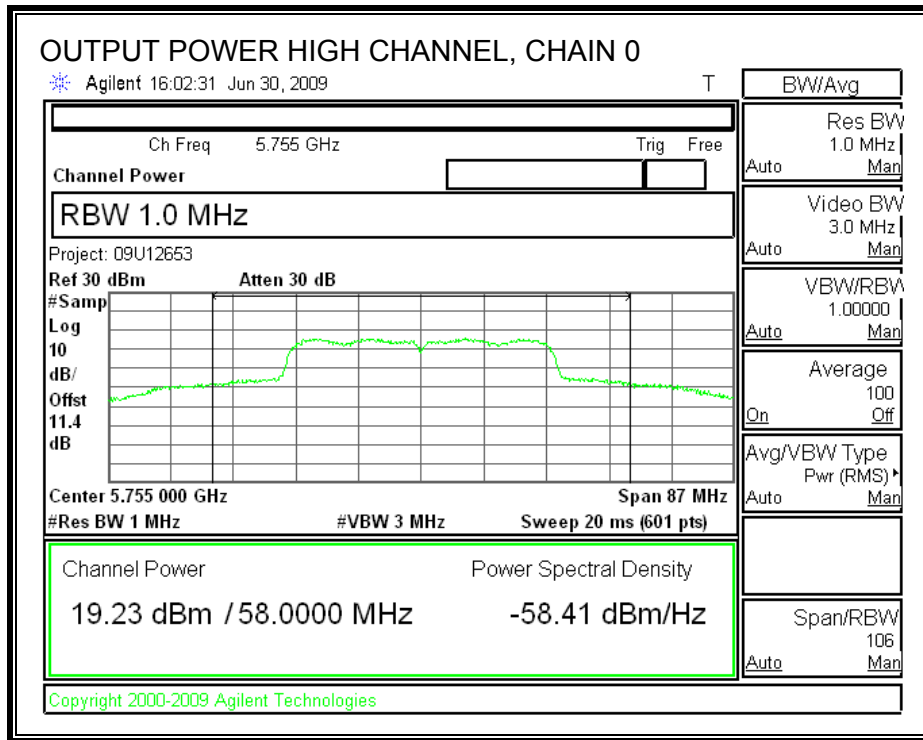

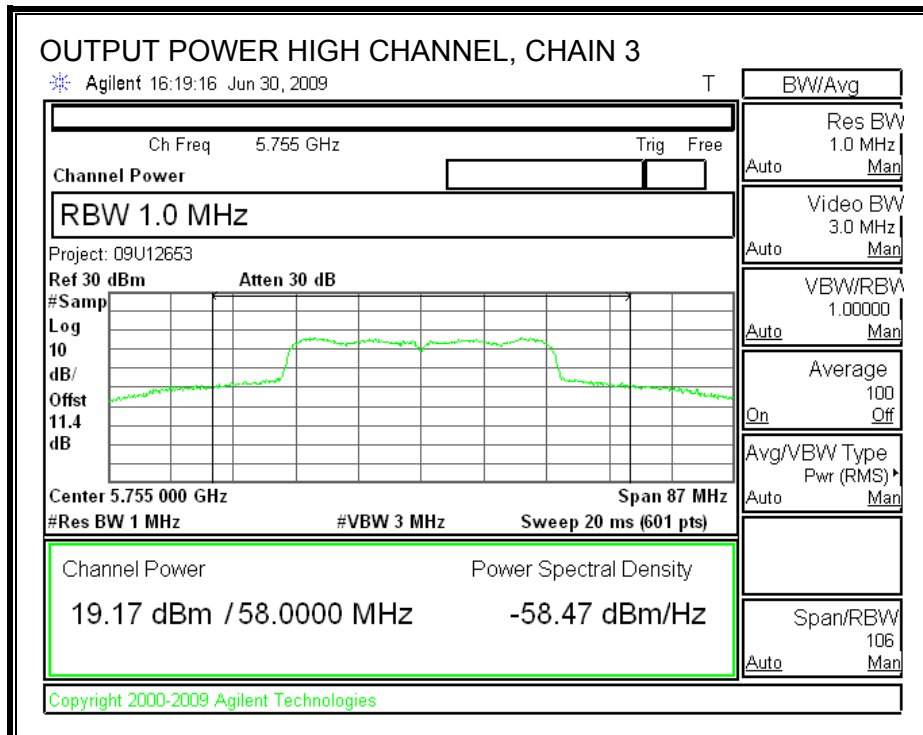
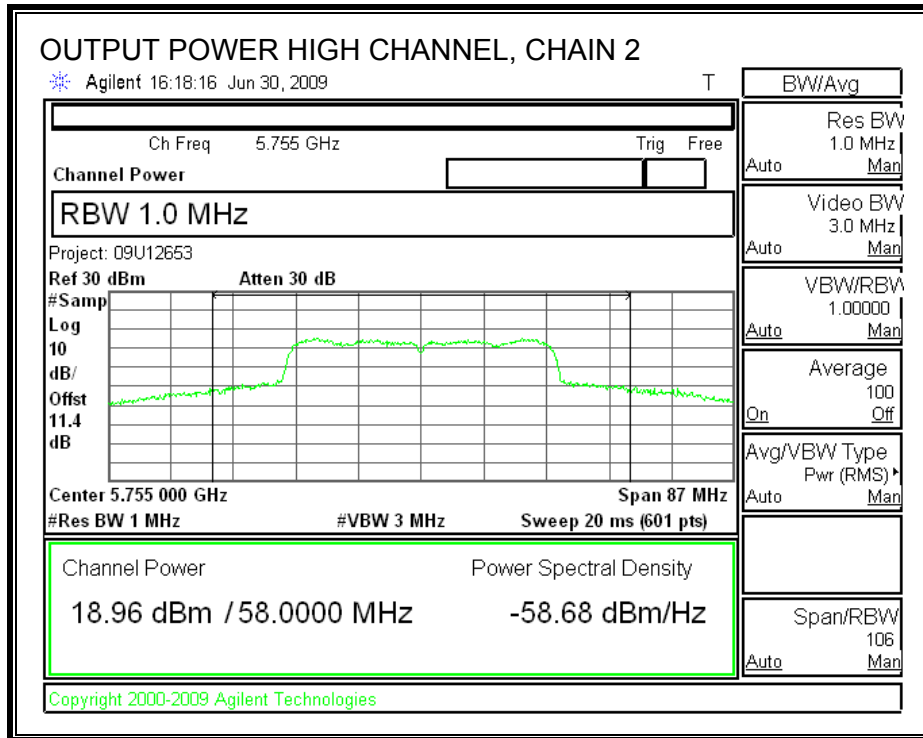

7.7.4. AVERAGE POWER

LIMITS

None; for reporting purposes only.

TEST PROCEDURE

The transmitter output is connected to a power meter.

The cable assembly insertion loss of 11.4 dB (including 10 dB pad and 1.4 dB cable) was entered as an offset in the power meter to allow for direct reading of power.

RESULTS

Channel	Frequency (MHz)	Chain 0 Power (dBm)	Chain 1 Power (dBm)	Chain 2 Power (dBm)	Chain 3 Power (dBm)
Low	5755	18.30	18.11	18.15	18.04
High	5795	19.11	19.25	19.09	19.27

7.7.5. POWER SPECTRAL DENSITY

LIMITS

FCC §15.247 (e)

IC RSS-210 A8.2 (b)

The power spectral density conducted from the transmitter to the antenna shall not be greater than 8 dBm in any 3 kHz band during any time interval of continuous transmission.

TEST PROCEDURE

Output power was measured based on the use of RMS averaging over a time interval, therefore the power spectral density was measured using PSD Option 2 in accordance with FCC document "Measurement of Digital Transmission Systems Operating under Section 15.247", March 23, 2005.

Preliminary tests on individual chains, and on all chains with a combiner, were performed. The worst-case configuration was with a combiner, therefore final test were performed with all chains feeding a combiner.

RESULTS

Channel	Frequency (MHz)	PSD with Combiner (dBm)	Limit (dBm)	Margin (dB)
Low	5755	-18.572	8	-26.57
High	5795	-16.24	8	-24.24

POWER SPECTRAL DENSITY

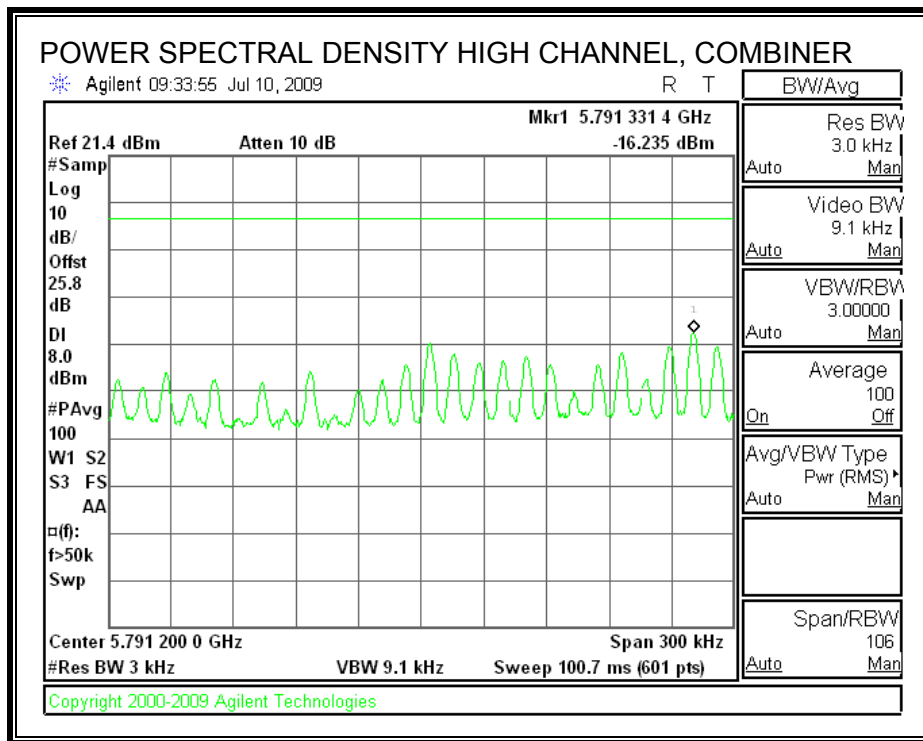
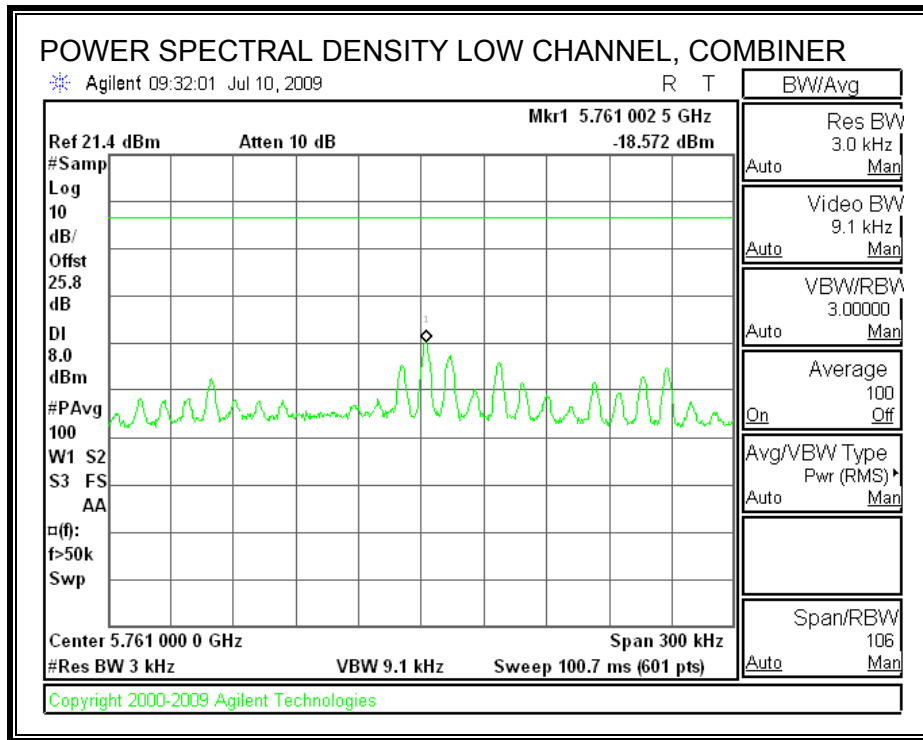

7.7.6. CONDUCTED SPURIOUS EMISSIONS

LIMITS

FCC §15.247 (d)

IC RSS-210 A8.5

Output power was measured based on the use of RMS averaging over a time interval, therefore the required attenuation is 30 dBc.

TEST PROCEDURE

The transmitter output is connected to a spectrum analyzer. The resolution bandwidth is set to 100 kHz. The video bandwidth is set to 300 kHz.

The spectrum from 30 MHz to 40 GHz is investigated with the transmitter set to the lowest, middle, and highest channels.

Preliminary tests on individual chains, and on all chains with a combiner, were performed. The worst-case configuration was with a combiner, therefore final test were performed with all chains feeding a combiner.

LOW CHANNEL SPURIOUS EMISSIONS

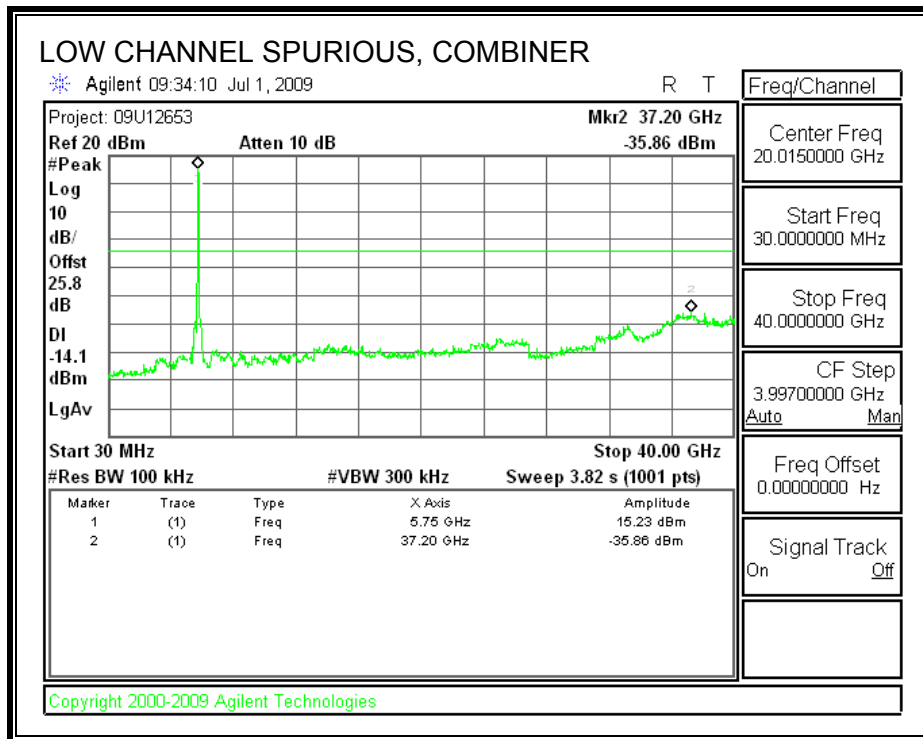
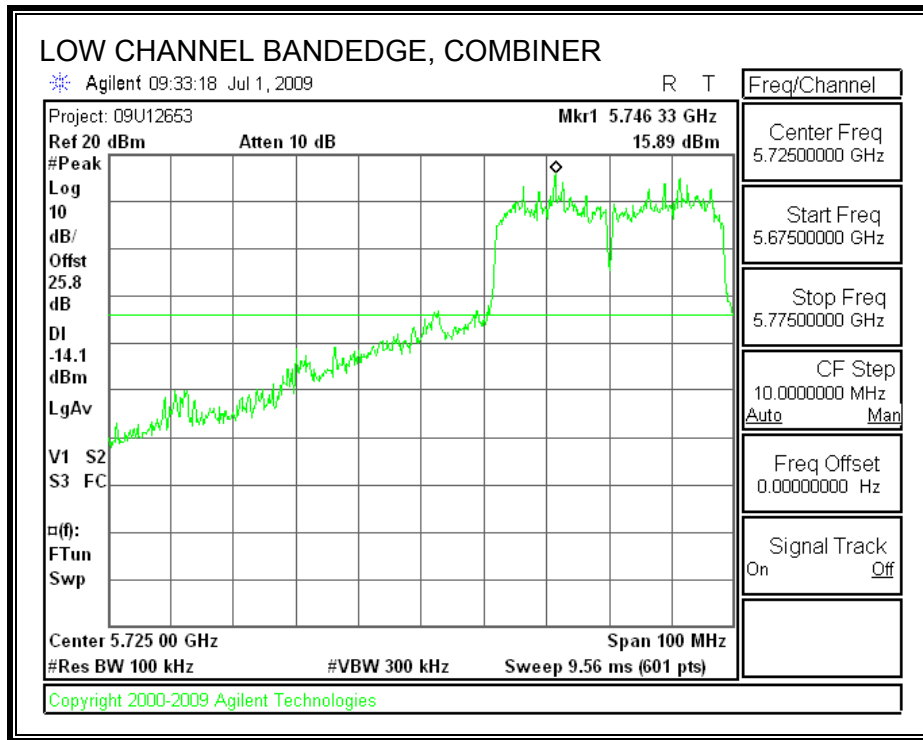

HIGH CHANNEL SPURIOUS EMISSIONS

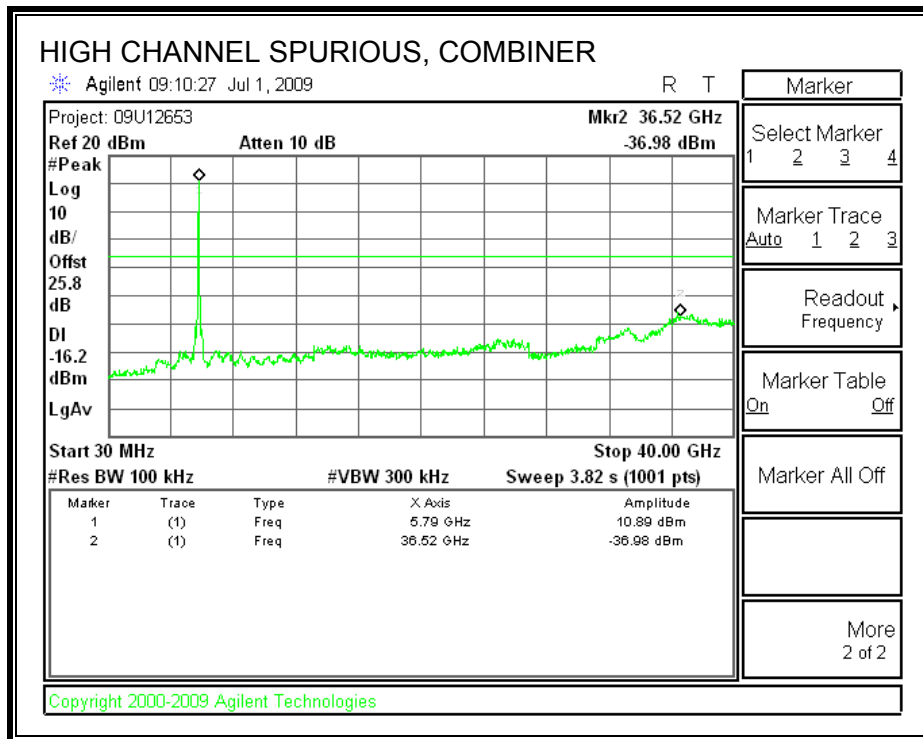
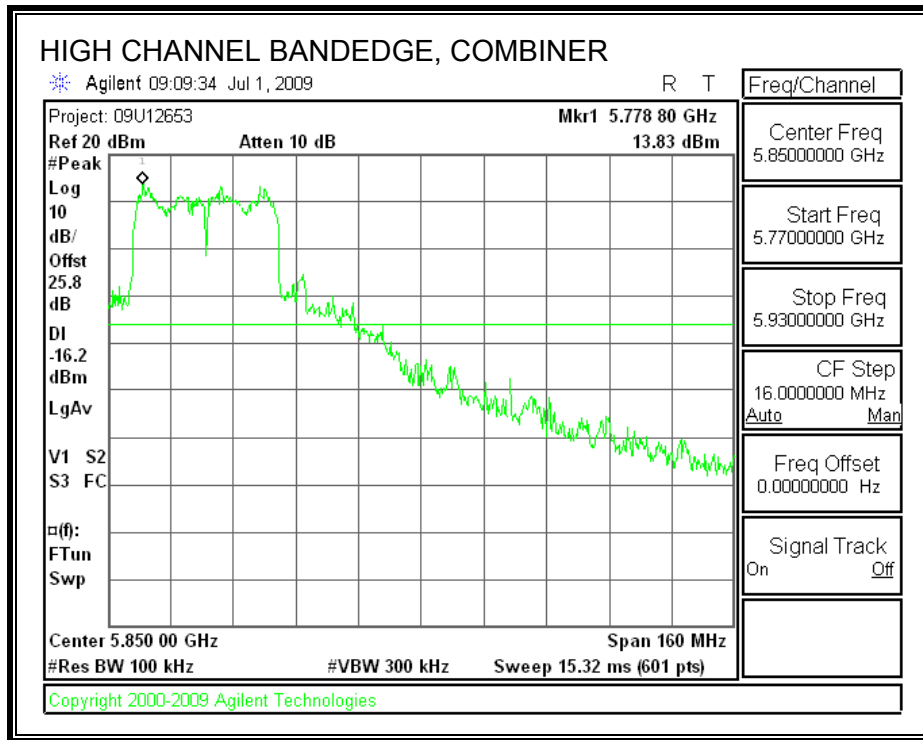

7.8. RECEIVER CONDUCTED SPURIOUS EMISSIONS

LIMITS

IC RSS-GEN 7.2.3.1

Antenna Conducted Measurement: Receiver spurious emissions at any discrete frequency shall not exceed 2 nanowatts (-57 dBm) in the band 30-1000 MHz, or 5 nanowatts (-53 dBm) above 1 GHz.

TEST PROCEDURE

IC RSS-GEN 4.10, Conducted Method

The receiver antenna port is connected to a spectrum analyzer.

The spectrum from 30 MHz to 8 GHz is investigated with the receiver set to the middle channel of the 2.4 GHz band.

The spectrum from 30 MHz to 18 GHz is investigated with the receiver set to the middle channel of each 5 GHz band.

Preliminary tests on individual chains, and on all chains with a combiner, were performed. The worst-case configuration was with a combiner, therefore final test were performed with all chains feeding a combiner.

RECEIVER SPURIOUS EMISSIONS IN THE 2.4 GHz BAND

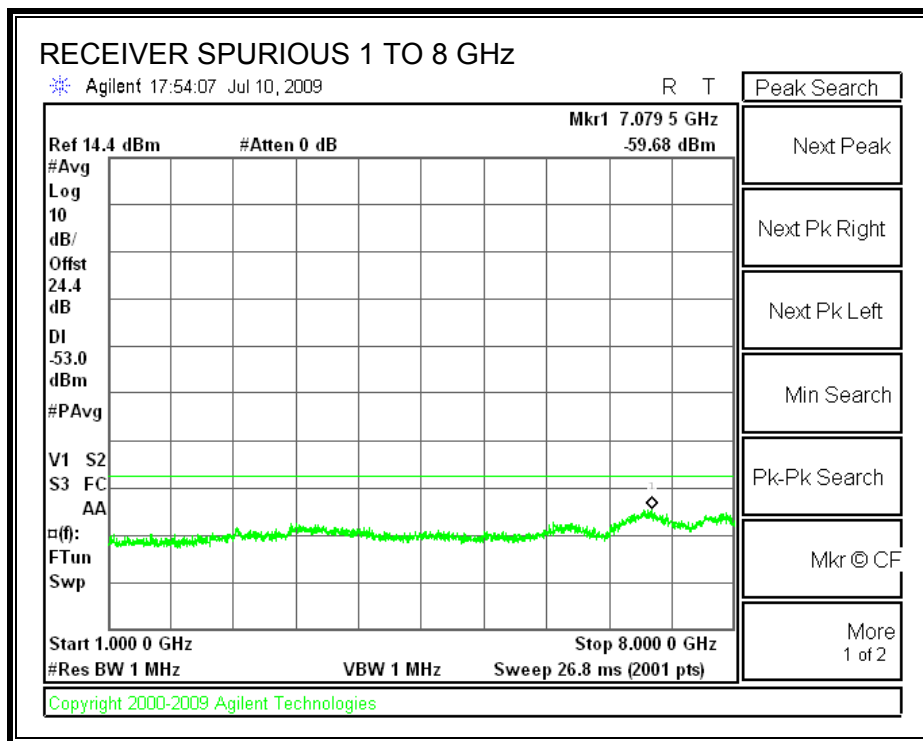
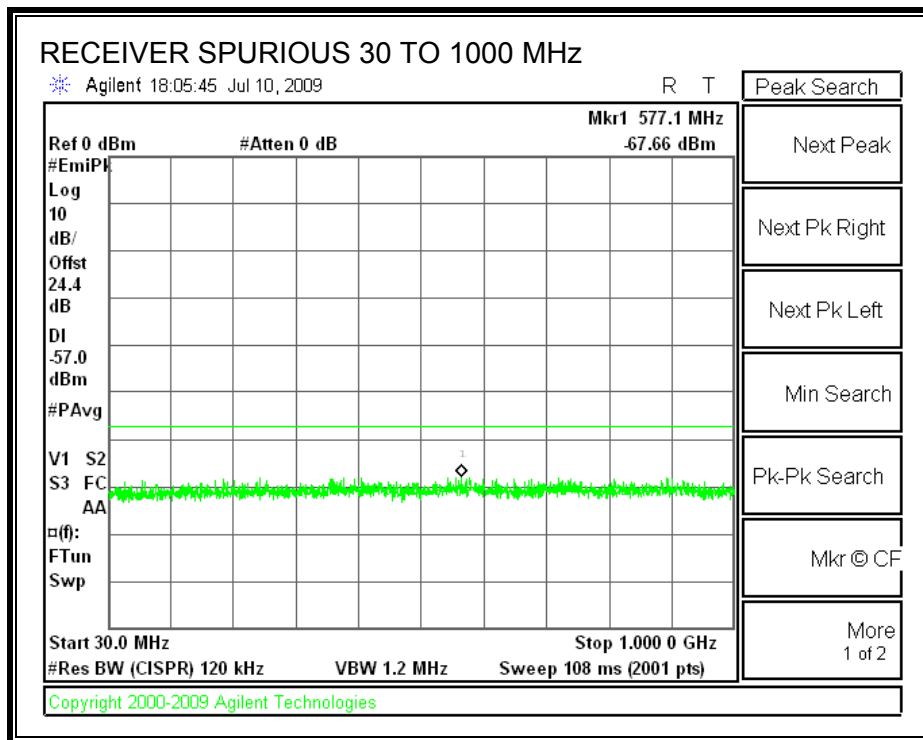

RECEIVER SPURIOUS EMISSIONS IN THE 5.8 GHz BAND

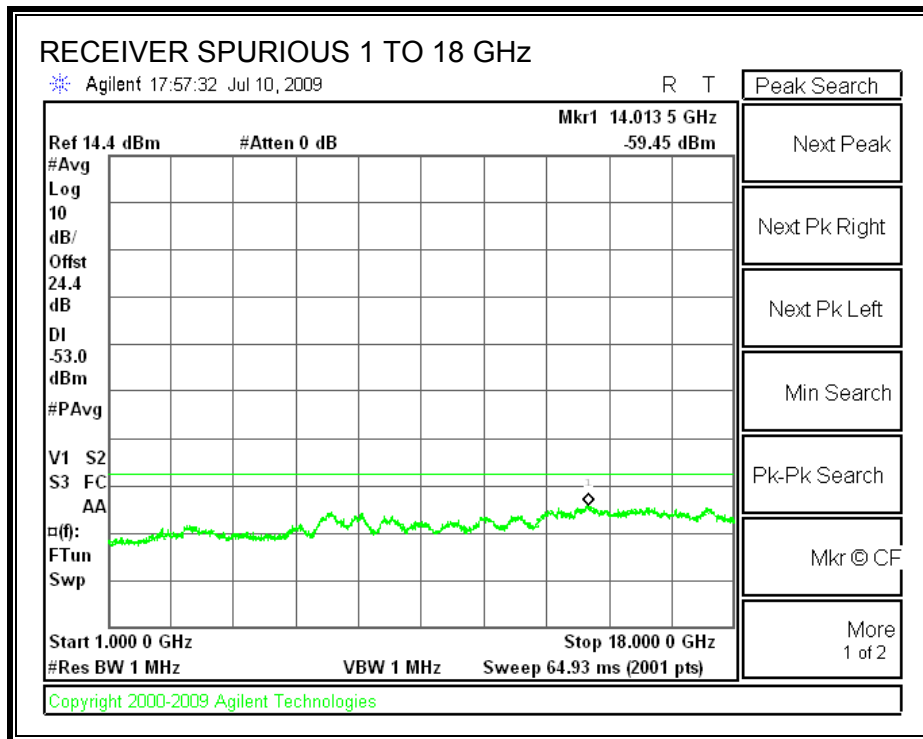
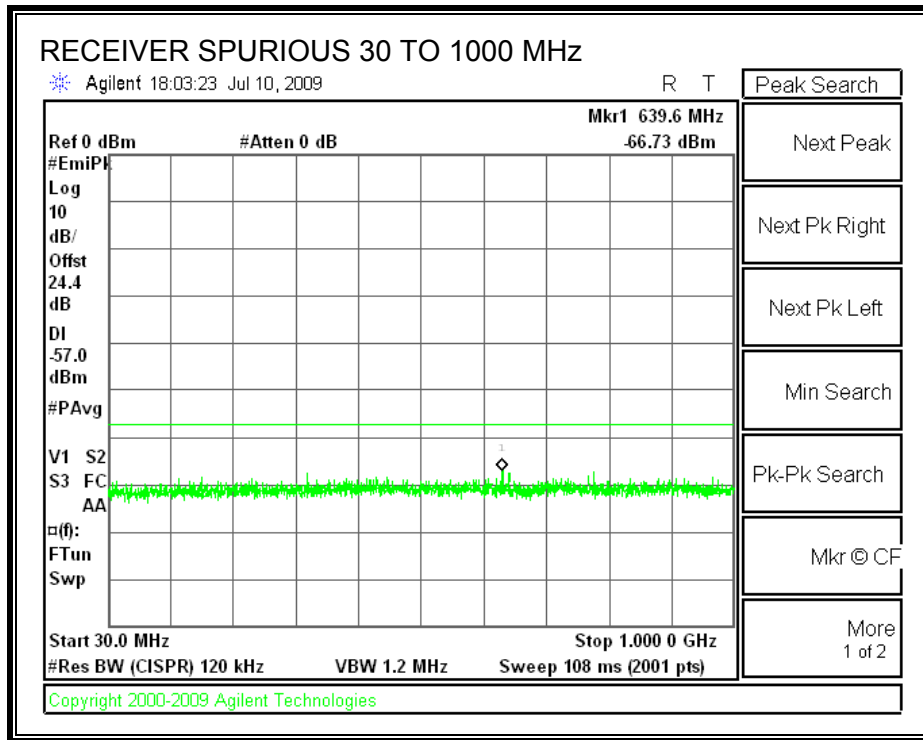

8. RADIATED TEST RESULTS

8.1. LIMITS AND PROCEDURE

LIMITS

FCC §15.205 and §15.209

IC RSS-210 Clause 2.6 (Transmitter)

IC RSS-GEN Clause 6 (Receiver)

Frequency Range (MHz)	Field Strength Limit (uV/m) at 3 m	Field Strength Limit (dBuV/m) at 3 m
30 - 88	100	40
88 - 216	150	43.5
216 - 960	200	46
Above 960	500	54

TEST PROCEDURE

The EUT is placed on a non-conducting table 80 cm above the ground plane. The antenna to EUT distance is 3 meters. The EUT is configured in accordance with ANSI C63.4. The EUT is set to transmit in a continuous mode.

For measurements below 1 GHz the resolution bandwidth is set to 100 kHz for peak detection measurements or 120 kHz for quasi-peak detection measurements. Peak detection is used unless otherwise noted as quasi-peak.

For measurements above 1 GHz the resolution bandwidth is set to 1 MHz, then the video bandwidth is set to 1 MHz for peak measurements and 10 Hz for average measurements.

The spectrum from 30 MHz to 26 GHz is investigated with the transmitter set to the lowest, middle, and highest channels in the 2.4 GHz band.

The spectrum from 30 MHz to 40 GHz is investigated with the transmitter set to the lowest, middle, and highest channels in each applicable band.

The frequency range of interest is monitored at a fixed antenna height and EUT azimuth. The EUT is rotated through 360 degrees to maximize emissions received. The antenna is scanned from 1 to 4 meters above the ground plane to further maximize the emission. Measurements are made with the antenna polarized in both the vertical and the horizontal positions.

8.2. TRANSMITTER ABOVE 1 GHz

8.2.1. 802.11b MODE IN THE 2.4 GHz BAND

RESTRICTED BANDEDGE (LOW CHANNEL, HORIZONTAL)

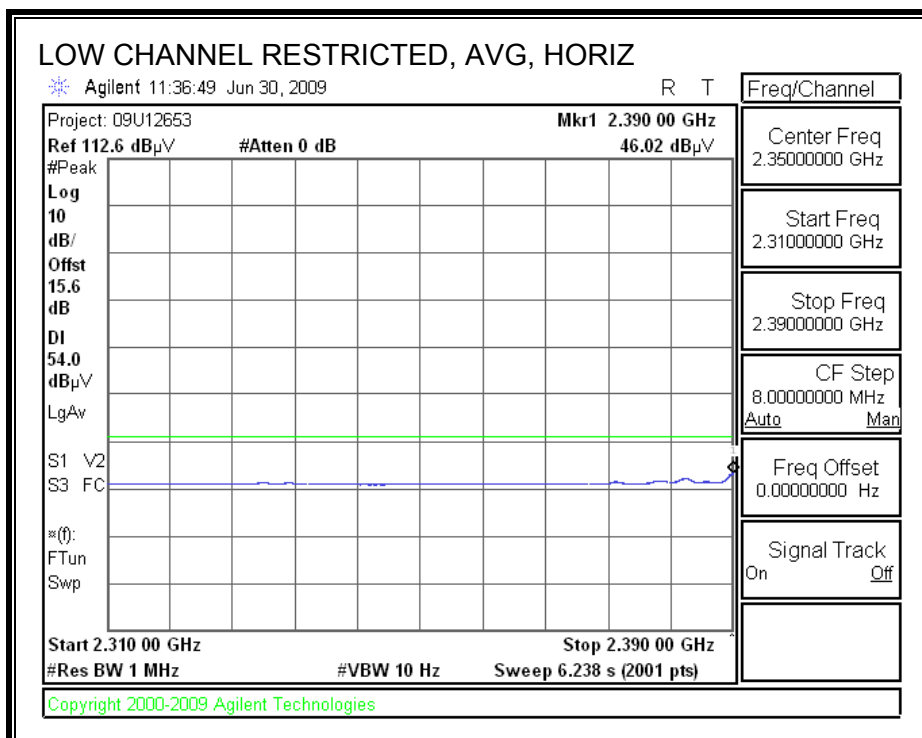
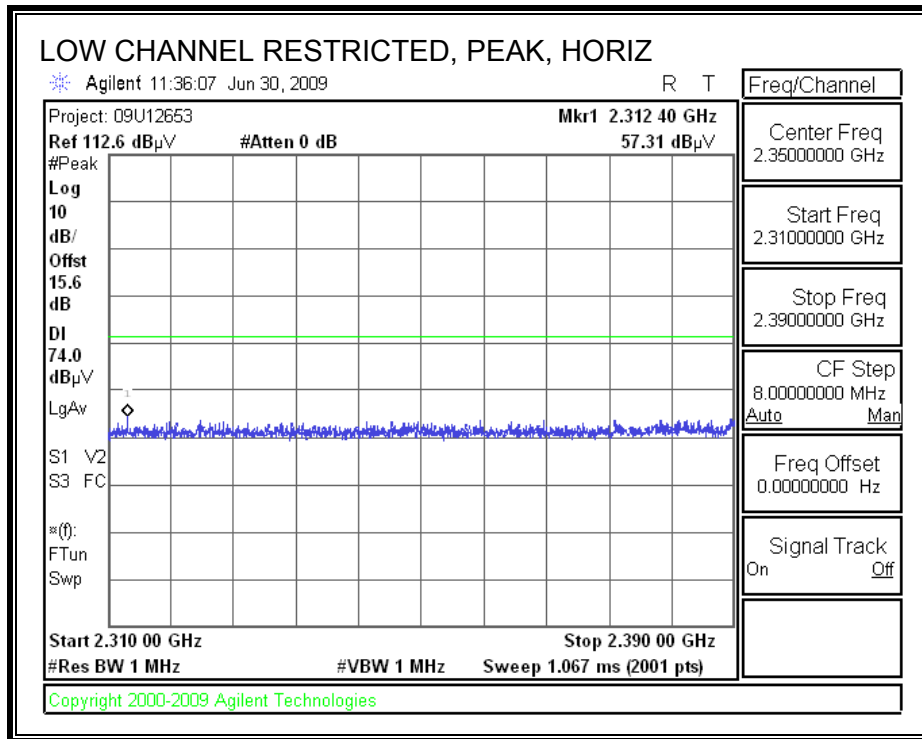

RESTRICTED BANDEDGE (LOW CHANNEL, VERTICAL)

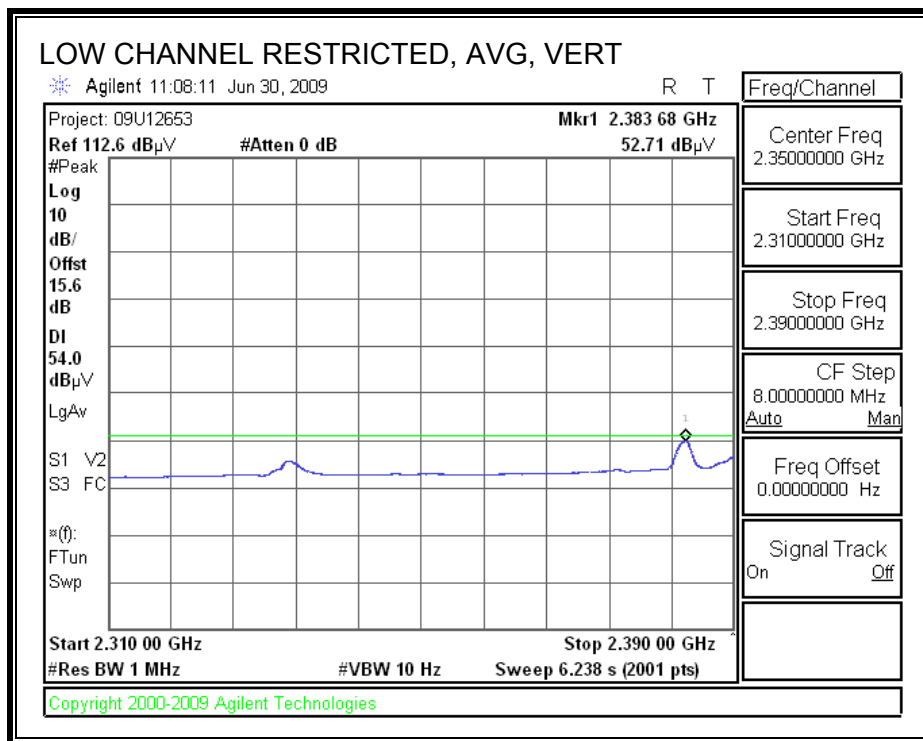
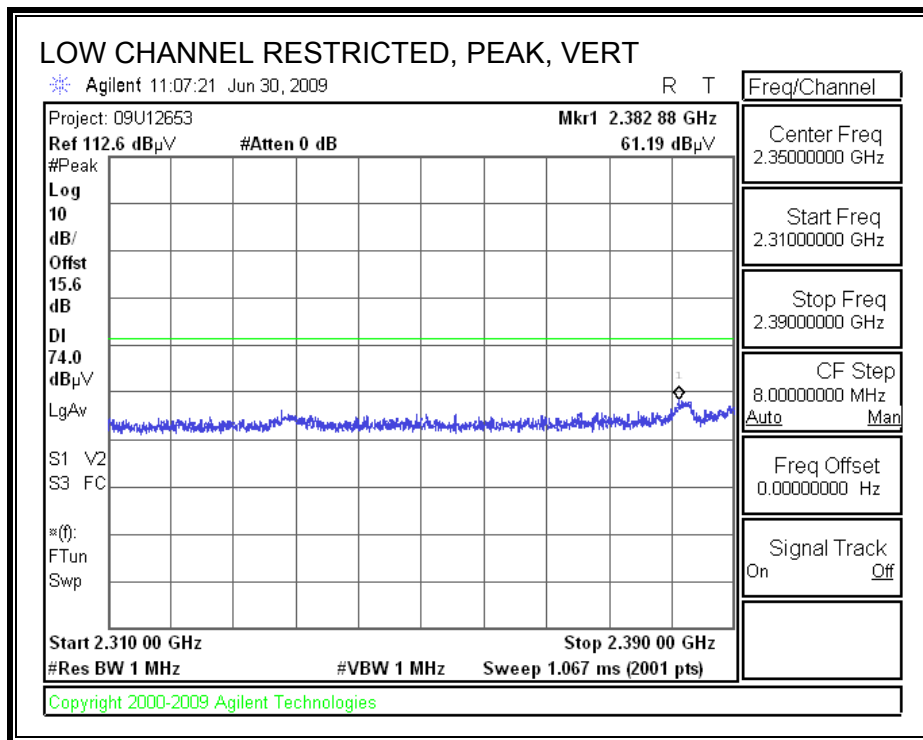

RESTRICTED BANDEDGE (HIGH CHANNEL, HORIZONTAL)

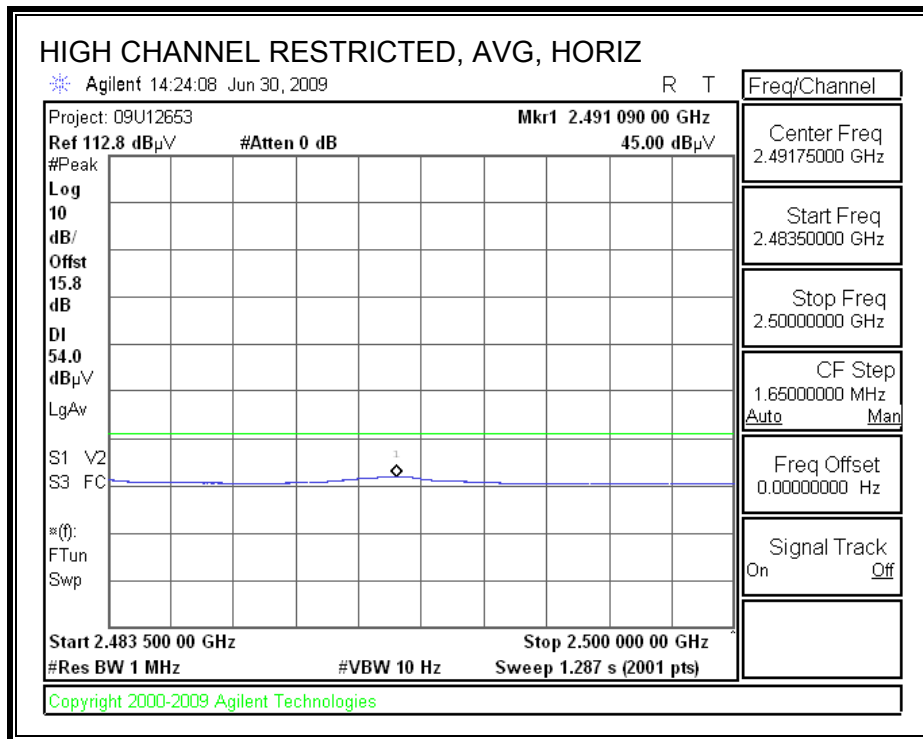
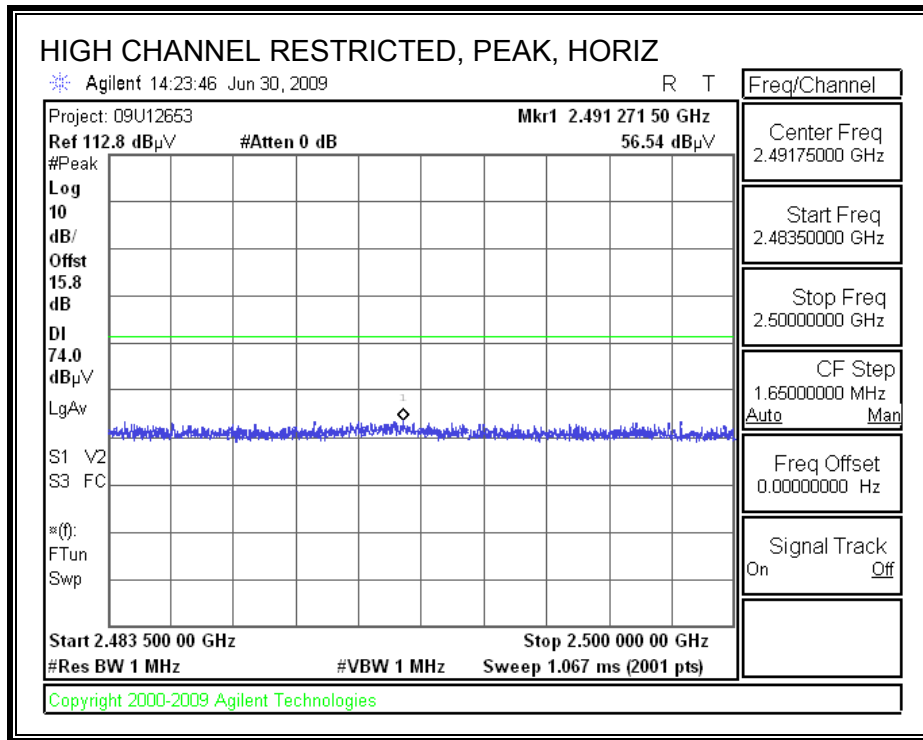

RESTRICTED BANEDGE (HIGH CHANNEL, VERTICAL)

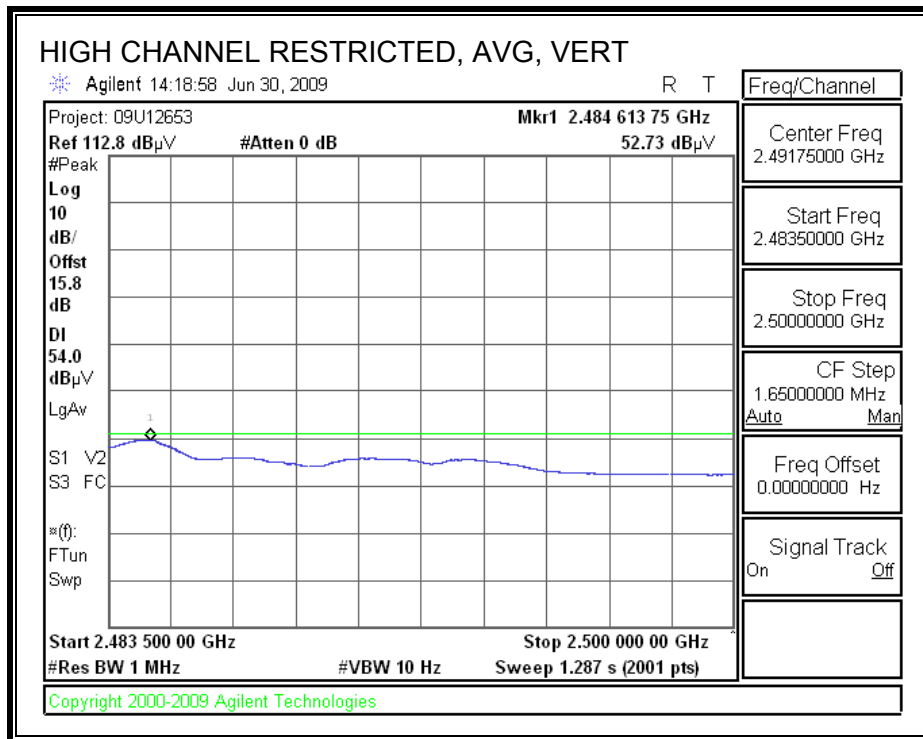
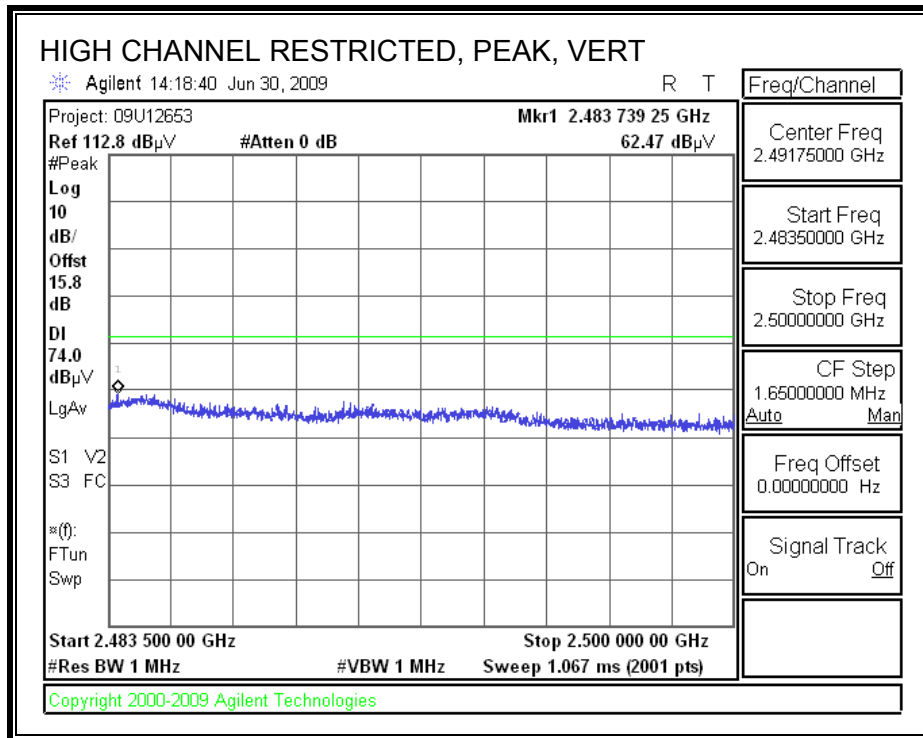

HARMONICS AND SPURIOUS EMISSIONS

High Frequency Measurement															
Compliance Certification Services, Fremont 5m Chamber															
Test Engr:		Thanh Nguyen													
Date:		07/02/09													
Project #:		09U12689													
Company:		Qualcomm Inc.													
EUT Description:		5000 series Ethernet Adapter card													
EUT M/N:		65-VN663-P2													
Test Target:		FCC15.247													
Mode Oper:		Transmit b mode													
f	Measurement Frequency	Amp	Preamp Gain	Average Field Strength Limit											
Dist	Distance to Antenna	D Corr	Distance Correct to 3 meters	Peak Field Strength Limit											
Read	Analyzer Reading	Avg	Average Field Strength @ 3 m	Margin vs. Average Limit											
AF	Antenna Factor	Peak	Calculated Peak Field Strength	Margin vs. Peak Limit											
CL	Cable Loss	HPF	High Pass Filter												
f	Dist	Read	AF	CL	Amp	D Corr	Fitr	Corr.	Limit	Margin	Ant. Pol.	Det.	Ant.High	Table Angle	Notes
GHz	(m)	dBuV	dB/m	dB	dB	dB	dB	dBuV/m	dBuV/m	dB	V/H	P/A/QP	cm	Degree	
Low ch 2412 set 17.5dbm															
4.824	3.0	44.5	33.0	5.8	-36.5	0.0	0.6	47.5	74.0	-26.5	V	P	173.1	101.0	
4.824	3.0	41.0	33.0	5.8	-36.5	0.0	0.6	44.0	54.0	-10.0	V	A	173.1	101.0	
4.824	3.0	38.2	33.0	5.8	-36.5	0.0	0.6	41.2	74.0	-32.8	H	P	170.4	153.9	
4.824	3.0	26.0	33.0	5.8	-36.5	0.0	0.6	28.9	54.0	-25.1	H	A	170.4	153.9	
Mid. Ch. 2437, Set 20.0dBm															
4.874	3.0	49.0	33.0	5.8	-36.5	0.0	0.6	52.0	74.0	-22.0	V	P	181.1	100.0	
4.874	3.0	43.9	33.0	5.8	-36.5	0.0	0.6	46.9	54.0	-7.1	V	A	181.1	100.0	
7.386	3.0	48.7	35.4	7.3	-36.2	0.0	0.6	55.6	74.0	-18.4	V	P	134.8	104.0	
7.386	3.0	41.3	35.4	7.3	-36.2	0.0	0.6	48.2	54.0	-5.8	V	A	134.9	104.0	
4.874	3.0	43.4	33.0	5.8	-36.5	0.0	0.6	46.4	74.0	-27.6	H	P	177.3	103.0	
4.874	3.0	33.0	33.0	5.8	-36.5	0.0	0.6	36.0	54.0	-18.0	H	A	177.3	103.0	
High Ch 2462MHz, set 18dbm															
4.924	3.0	44.7	33.1	5.9	-36.5	0.0	0.6	47.9	74.0	-26.1	V	P	100.4	159.3	
4.924	3.0	40.4	33.1	5.9	-36.5	0.0	0.6	43.6	54.0	-10.4	V	A	100.4	159.3	
7.386	3.0	40.2	35.4	7.3	-36.2	0.0	0.6	47.4	74.0	-26.6	V	P	157.0	113.7	
7.386	3.0	31.1	35.4	7.3	-36.2	0.0	0.6	38.3	54.0	-15.7	V	A	157.0	113.7	
12.310	3.0	36.5	39.0	9.9	-35.4	0.0	0.9	50.9	74.0	-23.1	V	P	100.0	0.0	Noise floor
12.310	3.0	23.8	39.0	9.9	-35.4	0.0	0.9	38.2	54.0	-15.8	V	A	100.0	0.0	Noise floor
4.924	3.0	43.0	33.1	5.9	-36.5	0.0	0.6	46.2	74.0	-27.8	H	P	103.4	239.9	
4.924	3.0	38.6	33.1	5.9	-36.5	0.0	0.6	41.8	54.0	-12.2	H	A	103.4	239.9	
7.386	3.0	37.4	35.4	7.3	-36.2	0.0	0.6	44.6	74.0	-29.4	H	P	165.4	247.4	Noise floor
7.386	3.0	24.7	35.4	7.3	-36.2	0.0	0.6	31.9	54.0	-22.1	H	A	165.4	247.4	Noise floor

Rev. 4.1.2.7

Note: No other emissions were detected above the system noise floor.

8.2.2. 802.11g MODE IN THE 2.4 GHz BAND

RESTRICTED BANEDGE (LOW CHANNEL, HORIZONTAL)

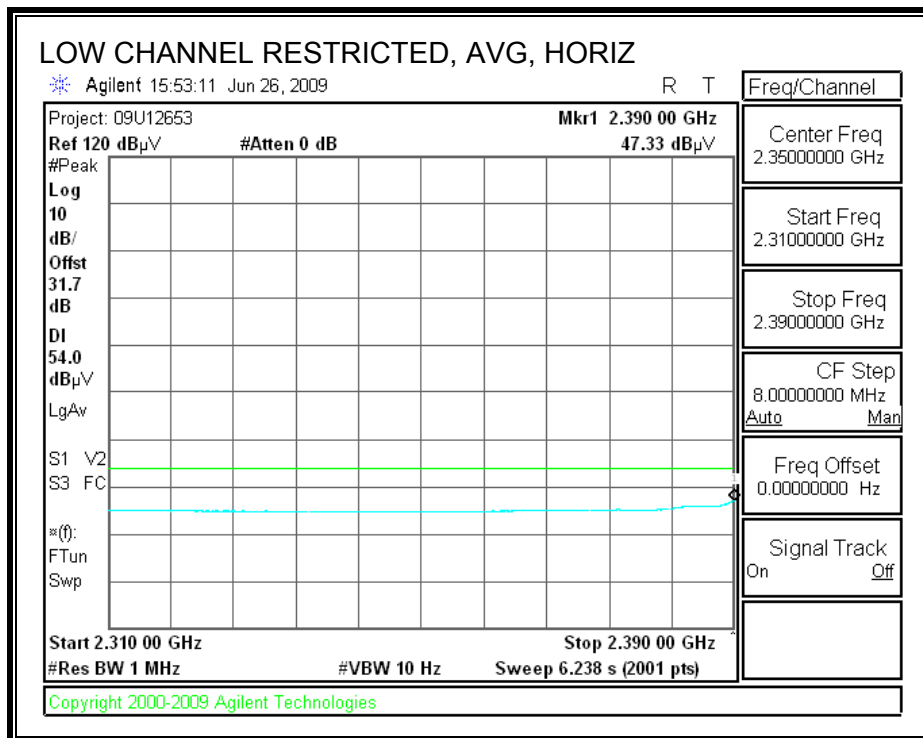
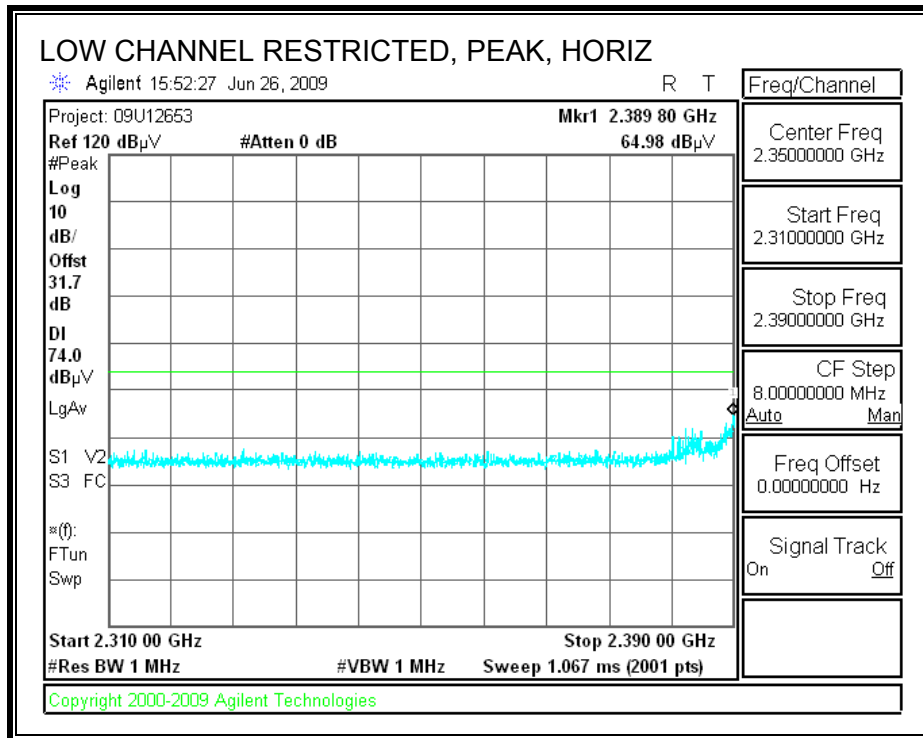

RESTRICTED BANDEDGE (LOW CHANNEL, VERTICAL)

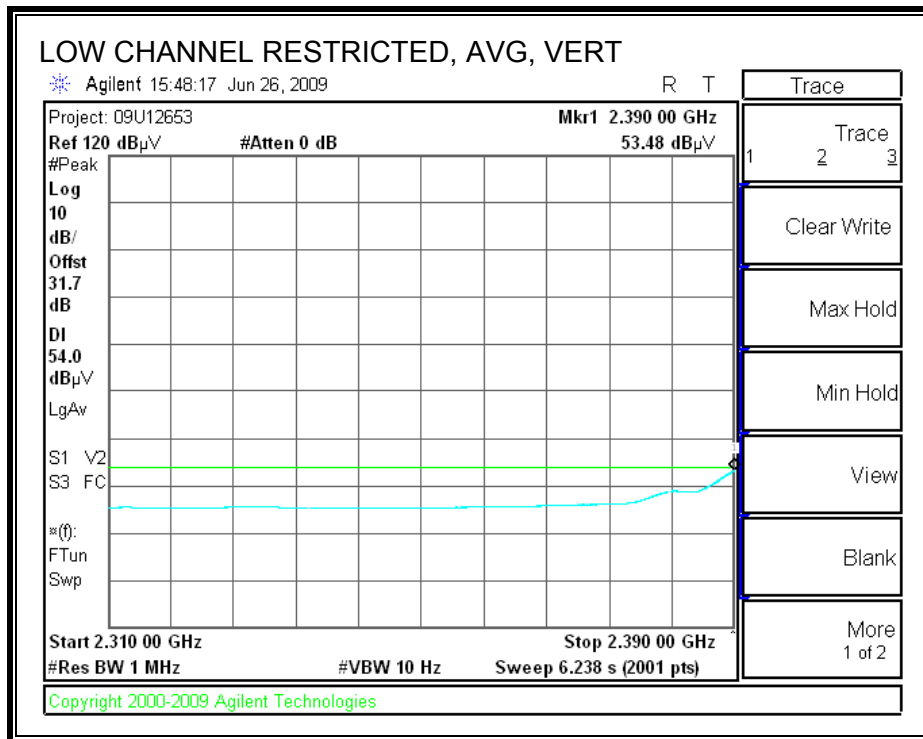
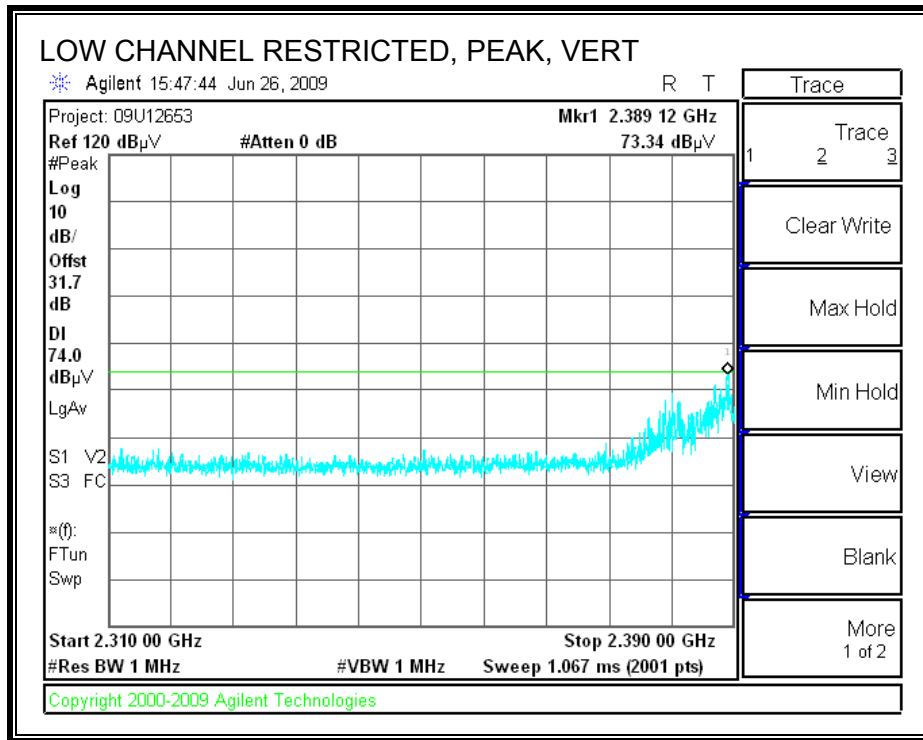

RESTRICTED BANDEDGE (HIGH CHANNEL, HORIZONTAL)

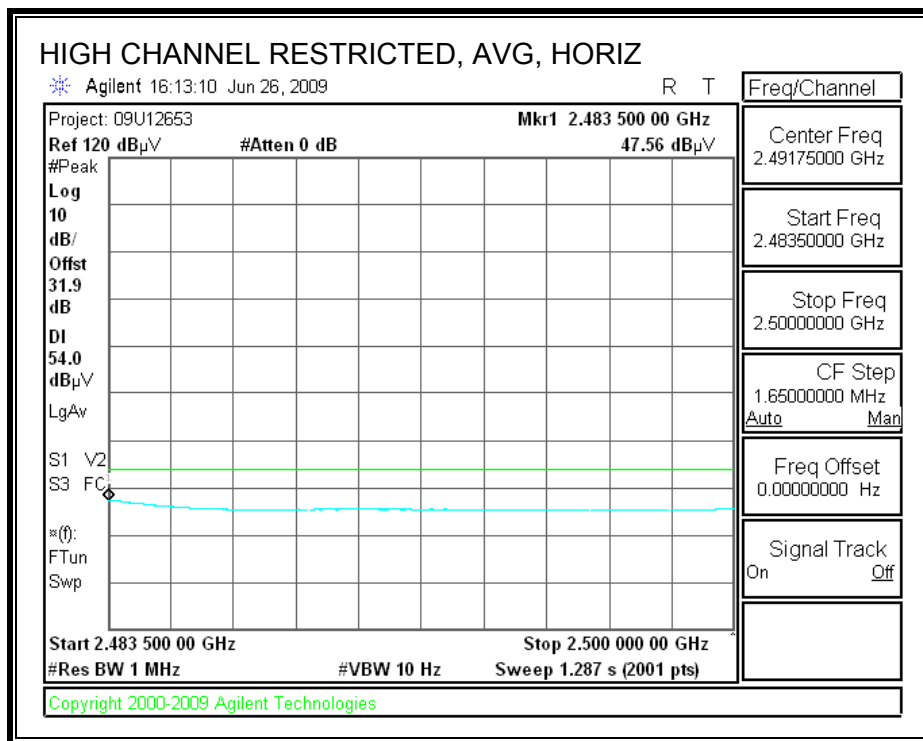
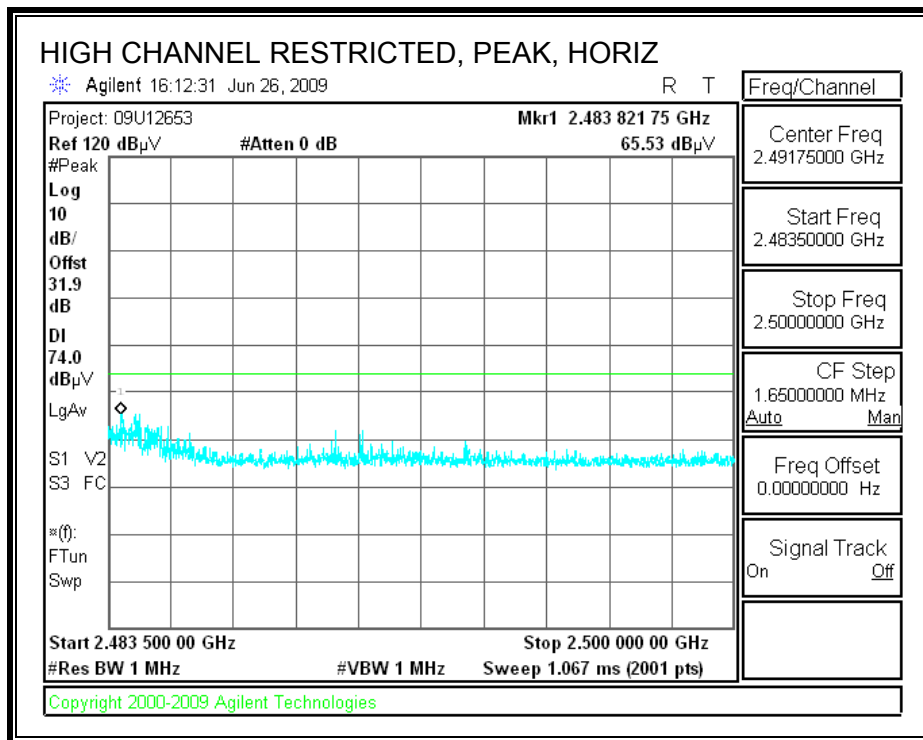

RESTRICTED BANDEDGE (HIGH CHANNEL, VERTICAL)

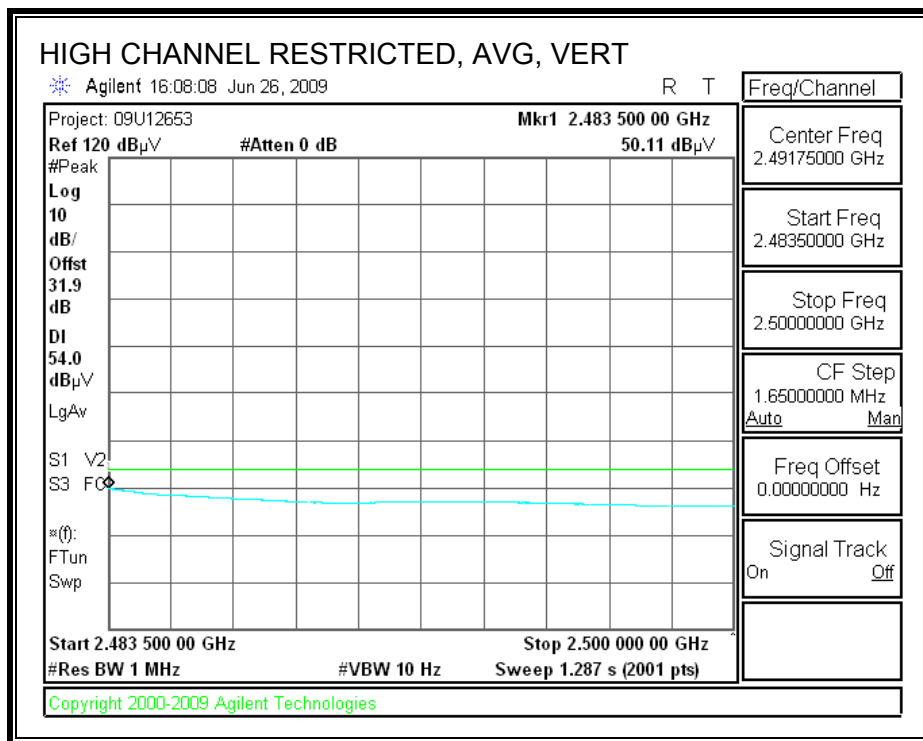
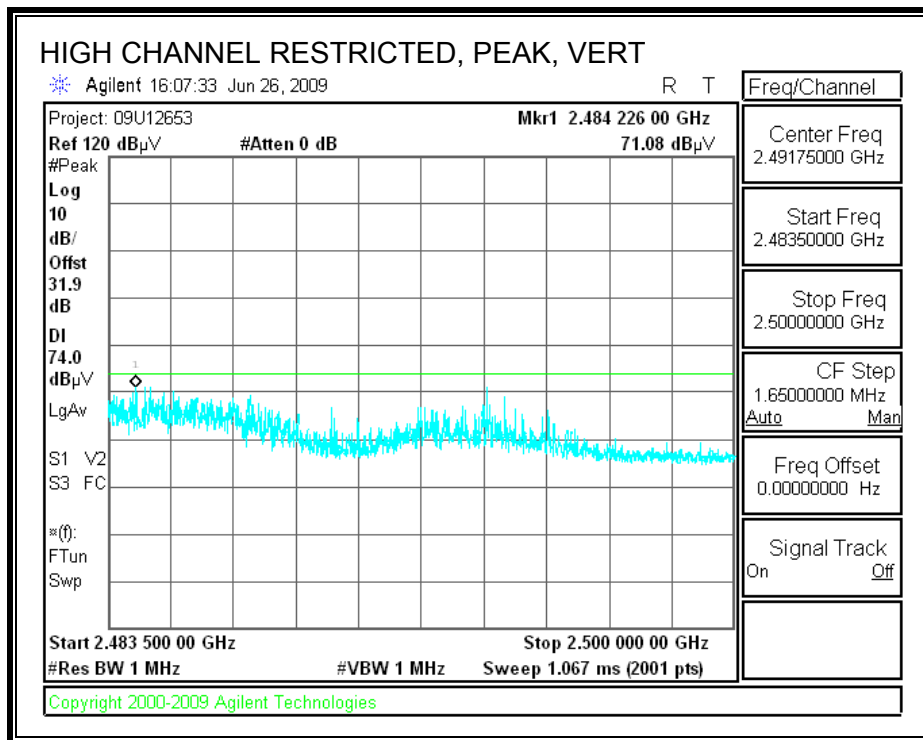

HARMONICS AND SPURIOUS EMISSIONS

High Frequency Measurement																
Compliance Certification Services, Fremont 5m Chamber																
Test Engr:		Thanh Nguyen														
Date:		07/02/09														
Project #:		09U12689														
Company:		Qualcomm Inc.														
EUT Description:		5000 series Ethernet Adapter card														
EUT M/N:		65-VN663-P2														
Test Target:		FCC15.247														
Mode Oper:		Transmit g mode														
f	Measurement Frequency			Amp	Preamplifier Gain			Average Field Strength Limit								
Dist	Distance to Antenna			D Corr	Distance Correct to 3 meters			Peak Field Strength Limit								
Read	Analyzer Reading			Avg	Average Field Strength @ 3 m			Margin vs. Average Limit								
AF	Antenna Factor			Peak	Calculated Peak Field Strength			Margin vs. Peak Limit								
CL	Cable Loss			HPF	High Pass Filter											
f GHz	Dist (m)	Read dBuV	AF dB/m	CL dB	Amp dB	D Corr dB	Fitr dB	Corr. dB	Limit dBuV/m	Margin dB	Ant. Pol. V/H	Det. P/A/QP	Ant.High cm	Table Angle Degree	Notes	
Low ch set 14.5dbm																
4.824	3.0	40.7	33.0	5.8	-36.5	0.0	0.6	43.7	74.0	-30.3	H	P	101.9	284.4		
4.824	3.0	34.0	33.0	5.8	-36.5	0.0	0.6	36.9	54.0	-17.1	H	A	101.9	284.4		
12.060	3.0	36.2	39.0	9.8	-35.4	0.0	0.9	50.5	74.0	-23.5	H	P	147.0	64.2	Noise floor	
12.060	3.0	23.4	39.0	9.8	-35.4	0.0	0.9	37.7	54.0	-16.3	H	A	147.0	64.2	Noise floor	
4.824	3.0	43.8	33.0	5.8	-36.5	0.0	0.6	46.7	74.0	-27.3	V	P	100.1	210.4		
4.824	3.0	39.3	33.0	5.8	-36.5	0.0	0.6	42.3	54.0	-11.7	V	A	100.1	210.4		
12.060	3.0	35.6	39.0	9.8	-35.4	0.0	0.9	49.9	74.0	-24.1	V	P	100.7	161.3	Noise floor	
12.060	3.0	23.2	39.0	9.8	-35.4	0.0	0.9	37.4	54.0	-16.6	V	A	100.7	161.3	Noise floor	
Mid ch set 19 dbm																
4.874	3.0	44.5	33.1	5.8	-36.5	0.0	0.6	47.5	74.0	-26.5	V	P	100.7	28.3		
4.874	3.0	39.3	33.1	5.8	-36.5	0.0	0.6	42.3	54.0	-11.7	V	A	100.7	28.3		
7.311	3.0	46.3	35.3	7.3	-36.2	0.0	0.6	53.3	74.0	-20.7	V	P	170.0	14.5		
7.311	3.0	32.6	35.3	7.3	-36.2	0.0	0.6	39.6	54.0	-14.4	V	A	170.0	14.5		
12.185	3.0	35.6	39.0	9.8	-35.4	0.0	0.9	49.9	74.0	-24.1	V	P	160.4	99.6	Noise floor	
12.185	3.0	23.5	39.0	9.8	-35.4	0.0	0.9	37.8	54.0	-16.2	V	A	160.4	99.6	Noise floor	
4.874	3.0	40.7	33.1	5.8	-36.5	0.0	0.6	43.7	74.0	-30.3	H	P	103.3	237.9		
4.874	3.0	34.4	33.1	5.8	-36.5	0.0	0.6	37.4	54.0	-16.6	H	A	103.3	237.9		
7.311	3.0	37.3	35.3	7.3	-36.2	0.0	0.6	44.3	74.0	-29.7	H	P	173.8	298.6	Noise floor	
7.311	3.0	24.7	35.3	7.3	-36.2	0.0	0.6	31.7	54.0	-22.3	H	A	173.8	298.6	Noise floor	
High ch set 13.5dbm																
4.924	3.0	42.5	33.1	5.9	-36.5	0.0	0.6	45.7	74.0	-28.3	V	P	100.0	291.8		
4.924	3.0	36.6	33.1	5.9	-36.5	0.0	0.6	39.8	54.0	-14.2	V	A	100.0	291.8		
7.386	3.0	37.7	35.4	7.3	-36.2	0.0	0.6	44.9	74.0	-29.2	V	P	167.4	294.7	Noise floor	
7.386	3.0	25.5	35.4	7.3	-36.2	0.0	0.6	32.7	54.0	-21.3	V	A	167.4	294.7	Noise floor	
4.924	3.0	40.5	33.1	5.9	-36.5	0.0	0.6	43.7	74.0	-30.3	H	P	101.6	283.7		
4.924	3.0	34.3	33.1	5.9	-36.5	0.0	0.6	37.5	54.0	-16.5	H	A	101.6	283.7		
7.386	3.0	37.8	35.4	7.3	-36.2	0.0	0.6	45.0	74.0	-29.0	H	P	100.0	352.6	Noise floor	
7.386	3.0	24.7	35.4	7.3	-36.2	0.0	0.6	31.9	54.0	-22.1	H	A	100.0	352.6	Noise floor	
Rev. 4.1.2.7																
Note: No other emissions were detected above the system noise floor.																

8.2.3. 802.11n HT20 MODE IN THE 2.4 GHz BAND

RESTRICTED BANDEDGE (LOW CHANNEL, HORIZONTAL)

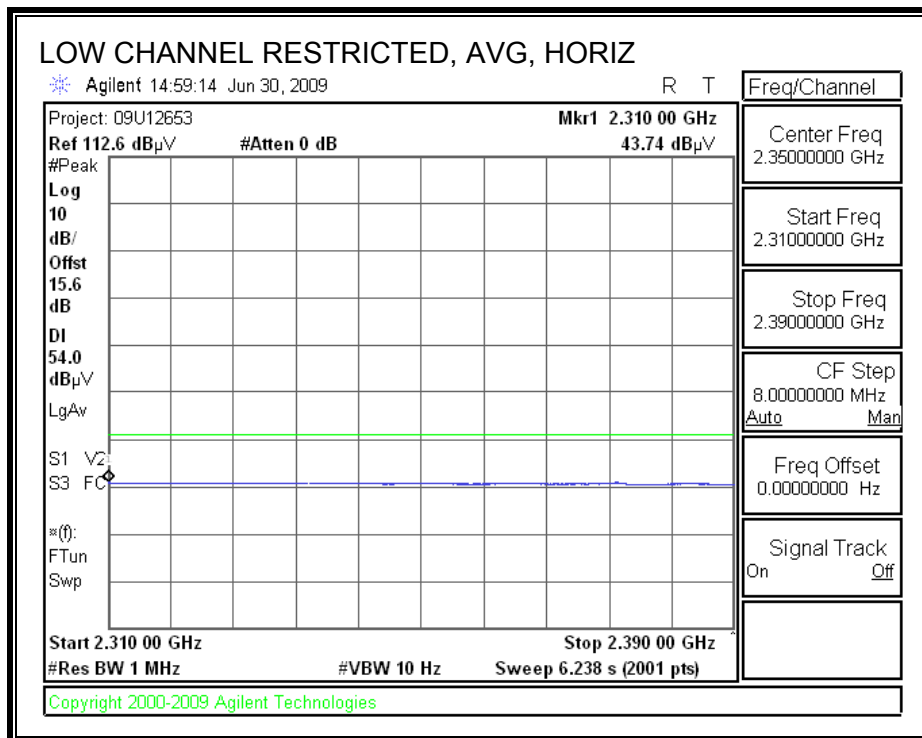
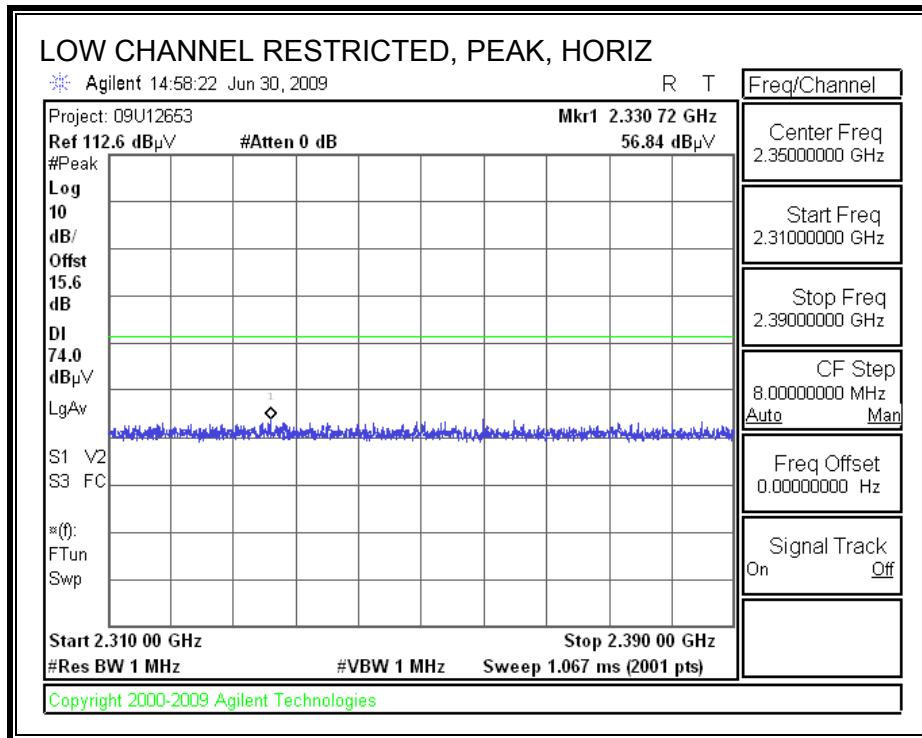

RESTRICTED BANDEDGE (LOW CHANNEL, VERTICAL)

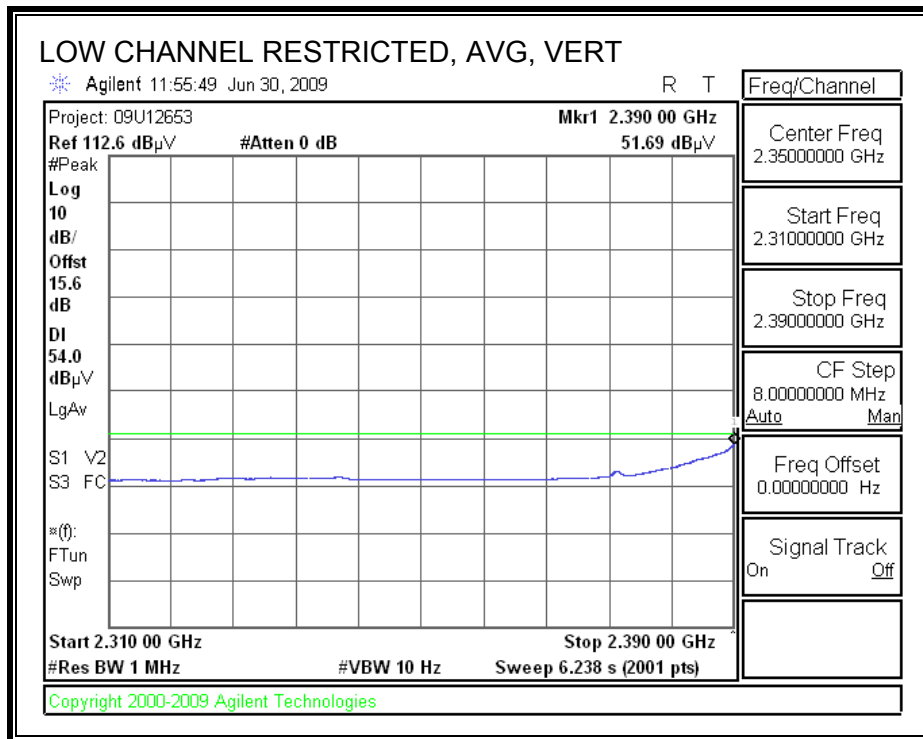
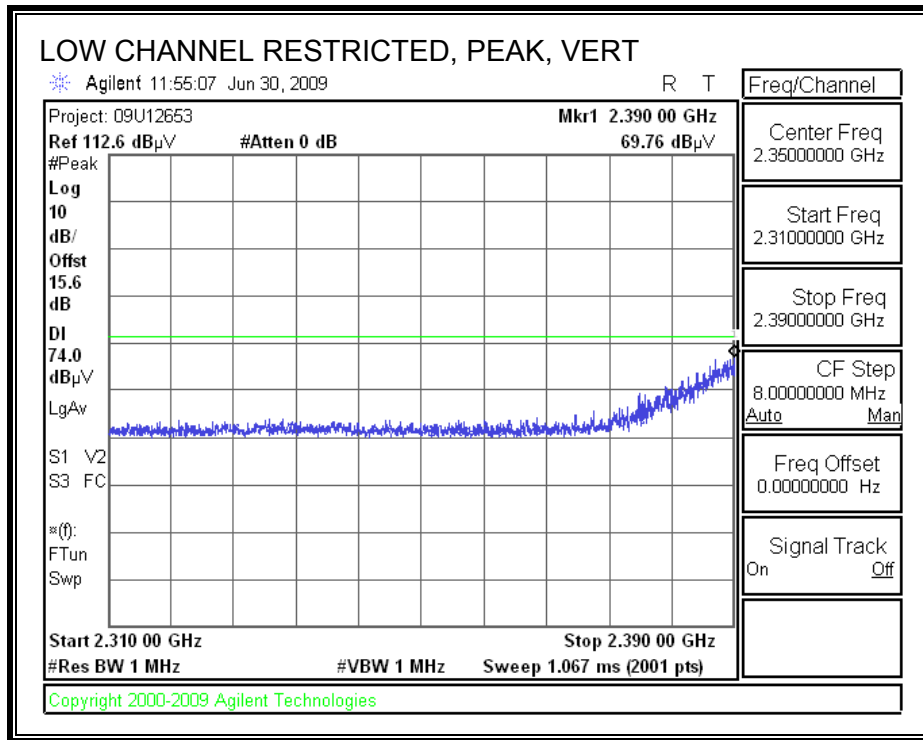

RESTRICTED BANDEGE (HIGH CHANNEL, HORIZONTAL)

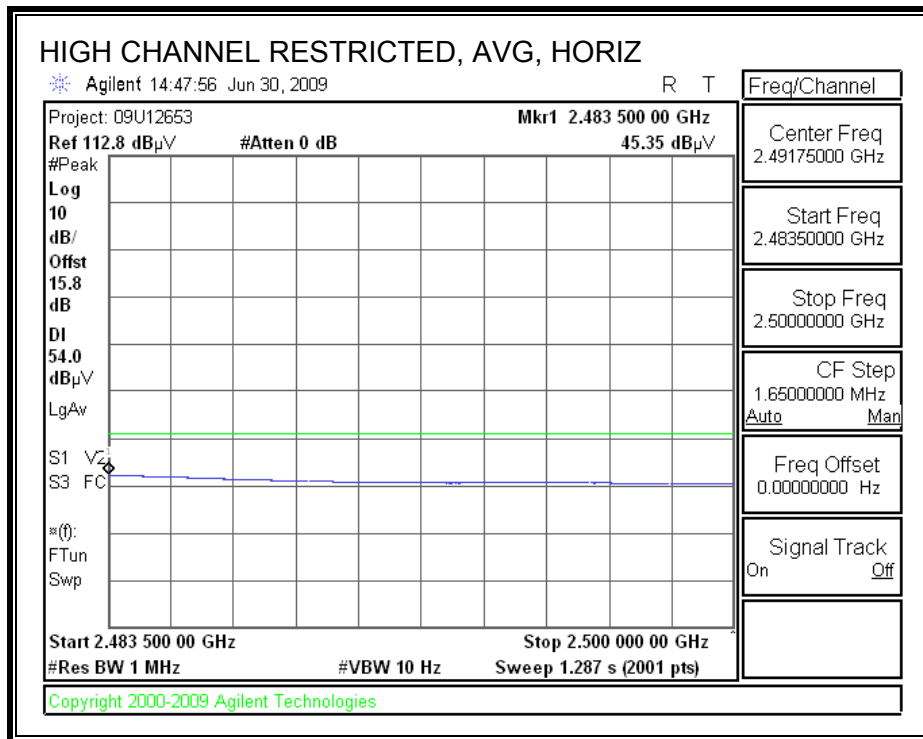
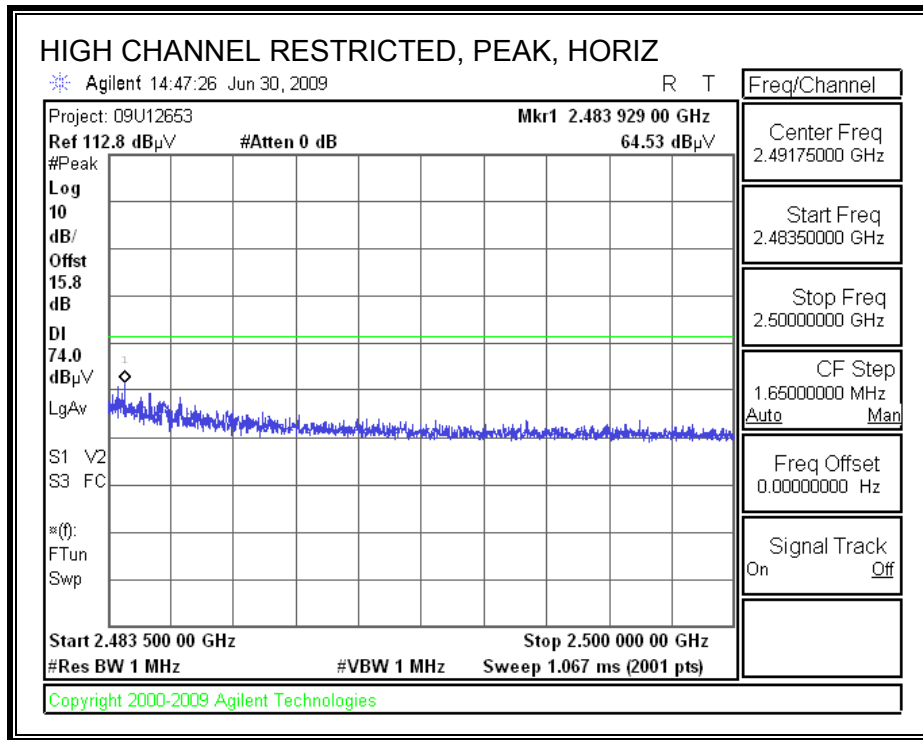

RESTRICTED BANDEDGE (HIGH CHANNEL, VERTICAL)

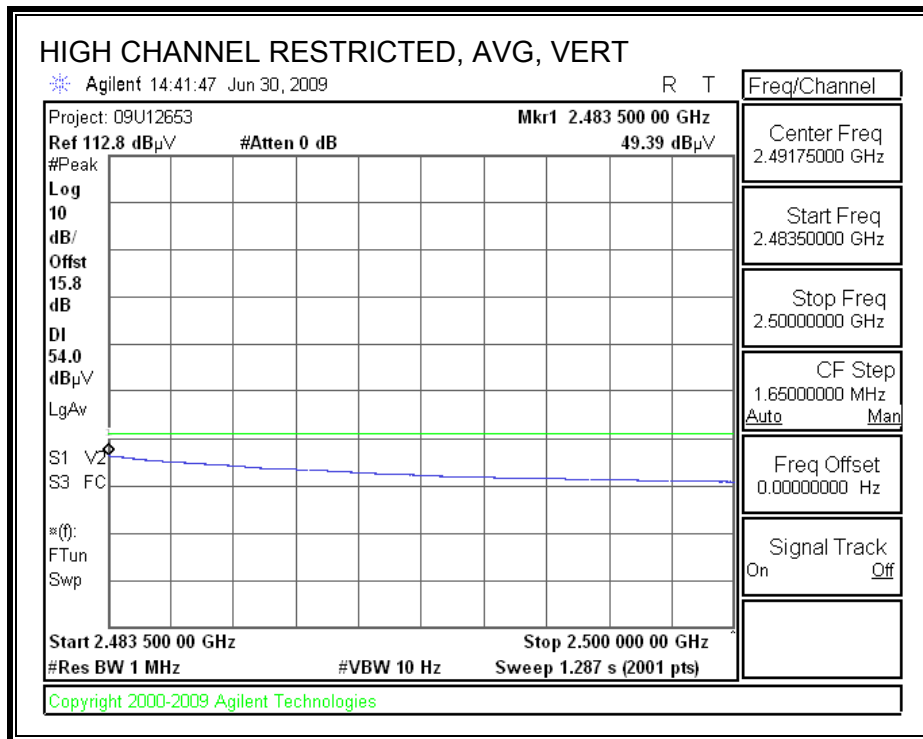
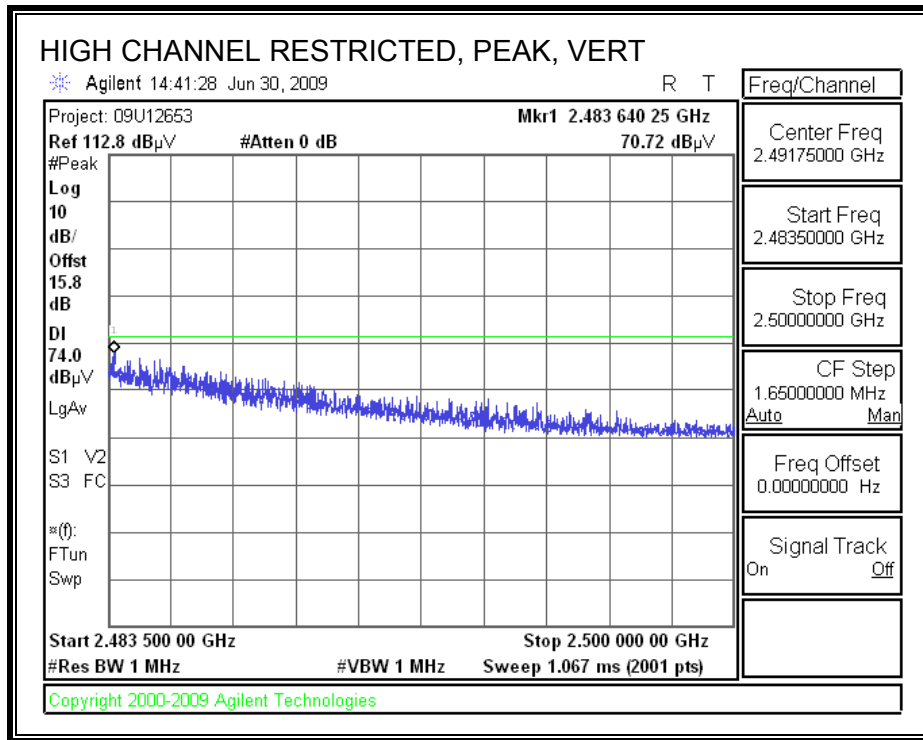

HARMONICS AND SPURIOUS EMISSIONS

High Frequency Measurement																
Compliance Certification Services, Fremont 5m Chamber																
Test Engr:		Thanh Nguyen														
Date:		07/02/09														
Project #:		09U12689														
Company:		Qualcomm Inc.														
EUT Description:		5000 series Ethernet Adapter card														
EUT M/N:		65-VN663-P2														
Test Target:		FCC15.247														
Mode Oper:		Transmit 2.4GHz band HT20 mode														
f	Measurement Frequency	Amp	Preamp Gain	Average Field Strength Limit												
Dist	Distance to Antenna	D Corr	Distance Correct to 3 meters	Peak Field Strength Limit												
Read	Analyzer Reading	Avg	Average Field Strength @ 3 m	Margin vs. Average Limit												
AF	Antenna Factor	Peak	Calculated Peak Field Strength	Margin vs. Peak Limit												
CL	Cable Loss	HPF	High Pass Filter													
f GHz	Dist (m)	Read dBuV	AF dB/m	CL dB	Amp dB	D Corr dB	Filtr dB	Corr. dB	Limit dBuV/m	Margin dB	Ant. Pol V/H	Det P/A/QP	Ant.High cm	Table Angle Degree	Notes	
T20 Low Ch set 15dbm																
4.824	3.0	43.6	33.0	5.8	-36.5	0.0	0.6	46.6	74.0	-27.4	V	P	100.0	210.3		
4.824	3.0	39.1	33.0	5.8	-36.5	0.0	0.6	42.0	54.0	-12.0	V	A	100.0	210.3		
12.060	3.0	35.4	39.0	9.8	-35.4	0.0	0.9	49.7	74.0	-24.3	V	P	100.3	199.4	Noise floor	
12.060	3.0	23.2	39.0	9.8	-35.4	0.0	0.9	37.5	54.0	-16.5	V	A	100.3	199.4	Noise floor	
4.824	3.0	40.2	33.0	5.8	-36.5	0.0	0.6	43.2	74.0	-30.8	H	P	102.3	283.6		
4.824	3.0	33.3	33.0	5.8	-36.5	0.0	0.6	36.3	54.0	-17.7	H	A	102.3	283.6		
HT20 Mid ch set 19 dbm																
4.874	3.0	44.3	33.1	5.8	-36.5	0.0	0.6	47.3	74.0	-26.7	V	P	100.3	26.5		
4.874	3.0	39.3	33.1	5.8	-36.5	0.0	0.6	42.3	54.0	-11.7	V	A	100.3	26.5		
7.311	3.0	47.8	35.3	7.3	-36.2	0.0	0.6	54.7	74.0	-19.3	V	P	158.6	9.6		
7.311	3.0	30.7	35.3	7.3	-36.2	0.0	0.6	37.6	54.0	-16.4	V	A	158.6	9.6		
4.874	3.0	39.2	33.1	5.8	-36.5	0.0	0.6	42.3	74.0	-31.7	H	P	123.7	253.1		
4.874	3.0	30.7	33.1	5.8	-36.5	0.0	0.6	33.8	54.0	-20.2	H	A	123.7	253.1		
7.311	3.0	36.7	35.3	7.3	-36.2	0.0	0.6	43.7	74.0	-30.3	H	P	154.5	299.1	Noise floor	
7.311	3.0	24.7	35.3	7.3	-36.2	0.0	0.6	31.7	54.0	-22.3	H	A	154.5	299.1	Noise floor	
HT20 High ch set 14.5dbm																
4.924	3.0	43.6	33.1	5.9	-36.5	0.0	0.6	46.8	74.0	-27.2	V	P	110.3	230.8		
4.924	3.0	39.5	33.1	5.9	-36.5	0.0	0.6	42.7	54.0	-11.3	V	A	110.3	230.8		
7.386	3.0	37.4	35.4	7.3	-36.2	0.0	0.6	44.5	74.0	-29.5	V	P	152.1	285.2	Noise floor	
7.386	3.0	24.9	35.4	7.3	-36.2	0.0	0.6	32.1	54.0	-21.9	V	A	152.1	285.2	Noise floor	
4.924	3.0	41.0	33.1	5.9	-36.5	0.0	0.6	44.1	74.0	-29.9	H	P	100.0	251.5		
4.924	3.0	33.5	33.1	5.9	-36.5	0.0	0.6	36.7	54.0	-17.3	H	A	100.0	251.5		
7.386	3.0	36.4	35.4	7.3	-36.2	0.0	0.6	43.5	74.0	-30.5	H	P	148.9	299.7	Noise floor	
7.386	3.0	24.7	35.4	7.3	-36.2	0.0	0.6	31.8	54.0	-22.2	H	A	148.9	299.7	Noise floor	
Rev. 4.1.2.7																
Note: No other emissions were detected above the system noise floor.																

8.2.4. 802.11n HT40 MODE IN THE 2.4 GHz BAND

RESTRICTED BANDEDGE (LOW CHANNEL, HORIZONTAL)

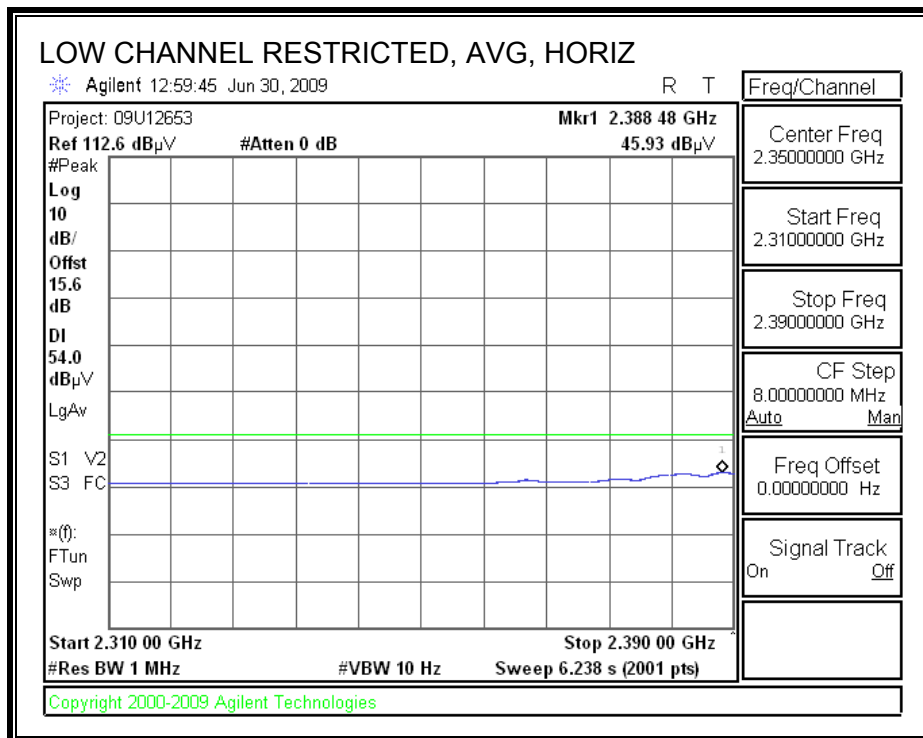
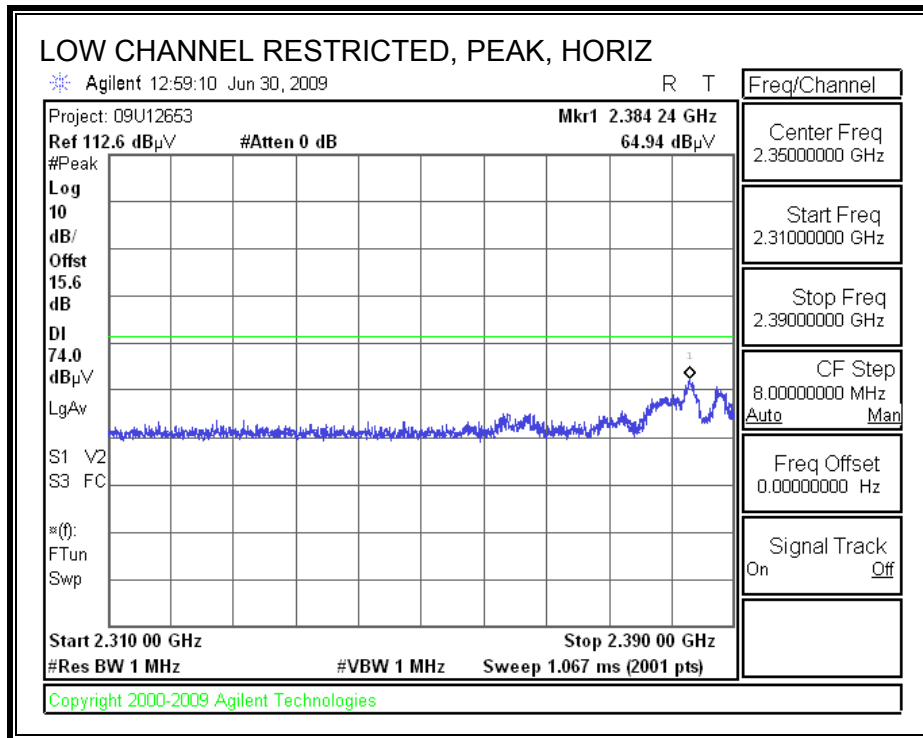

RESTRICTED BANDEDGE (LOW CHANNEL, VERTICAL)

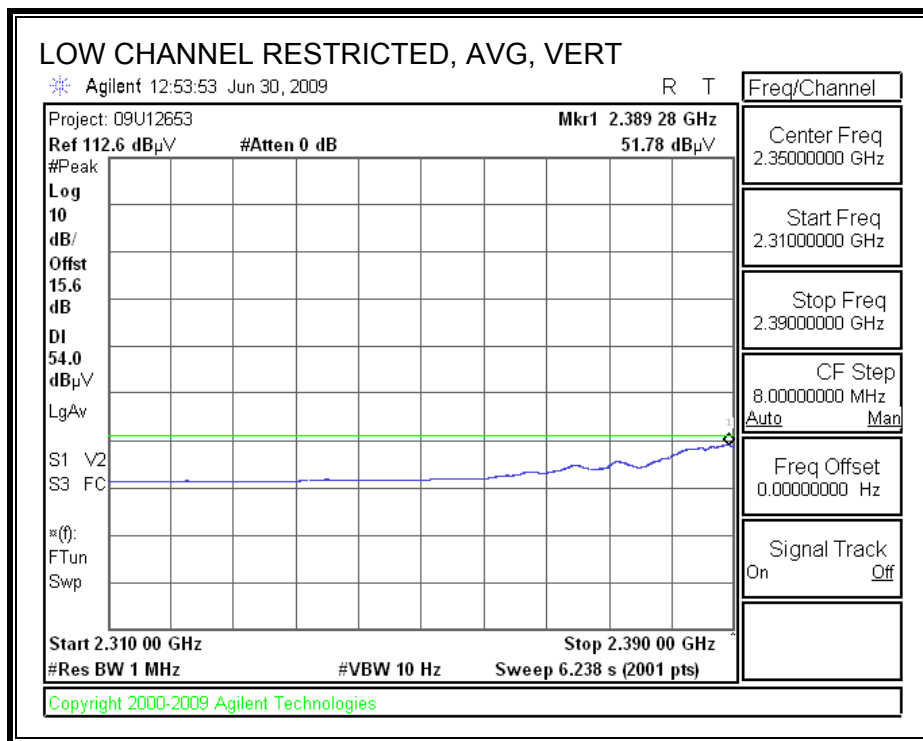
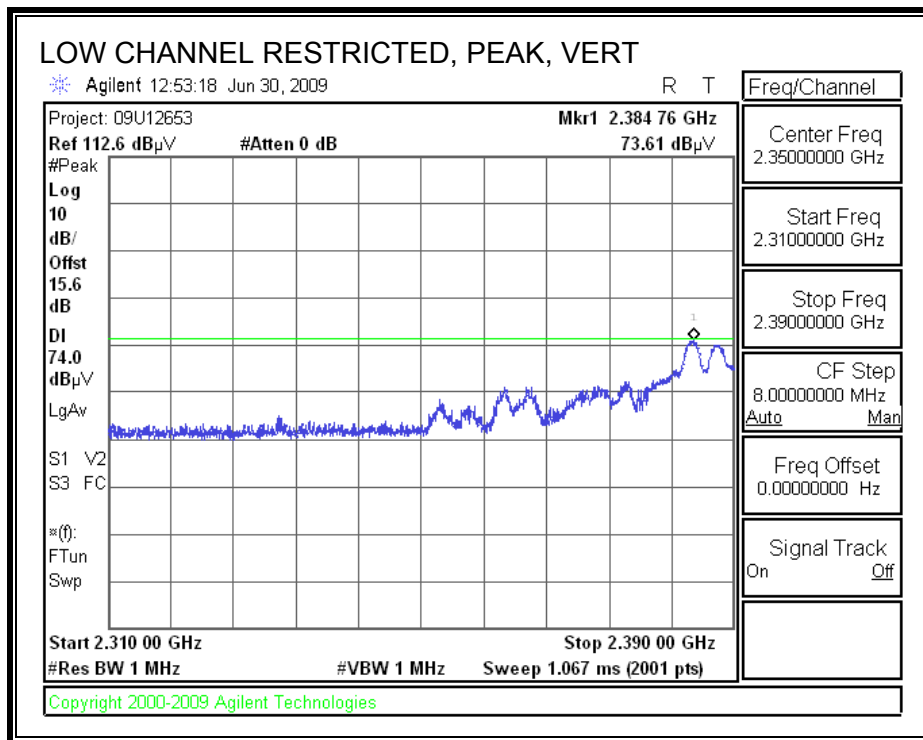

RESTRICTED BANDEGE (HIGH CHANNEL, HORIZONTAL)

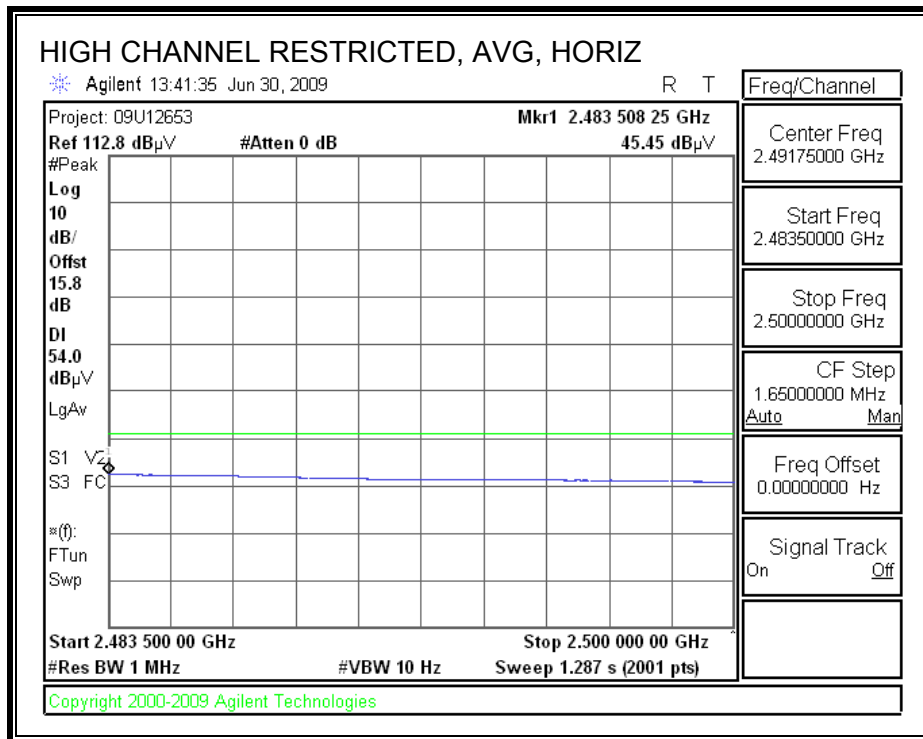
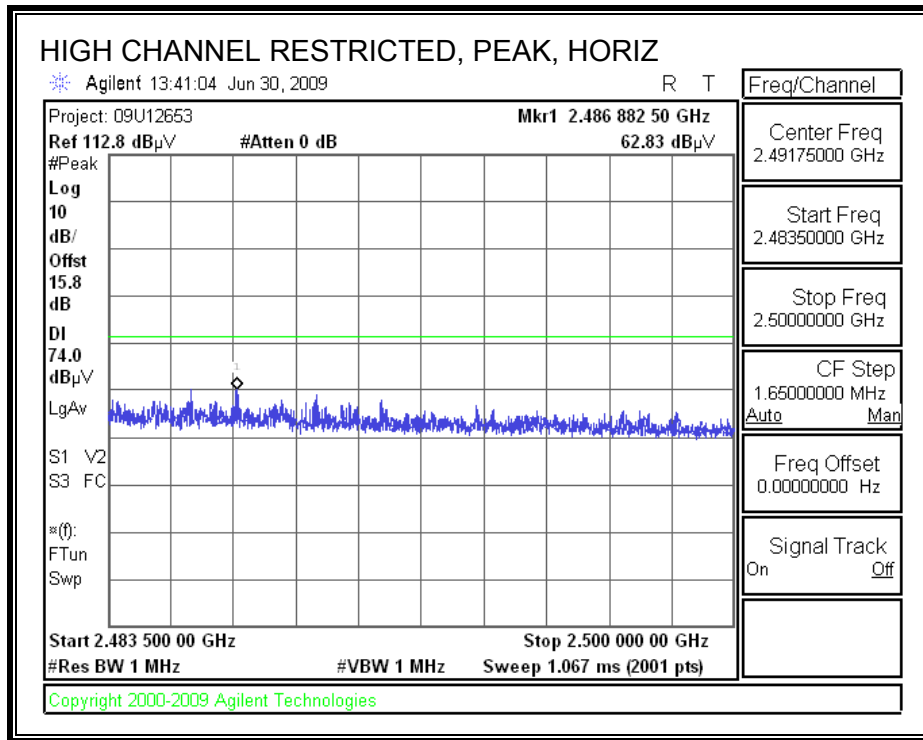

RESTRICTED BANDEDGE (HIGH CHANNEL, VERTICAL)

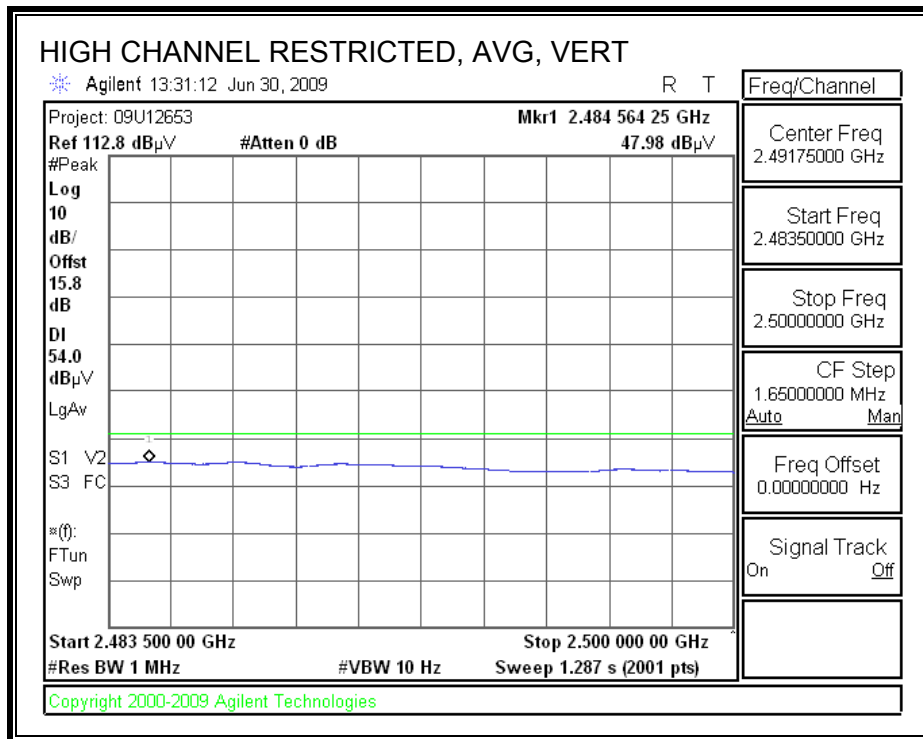
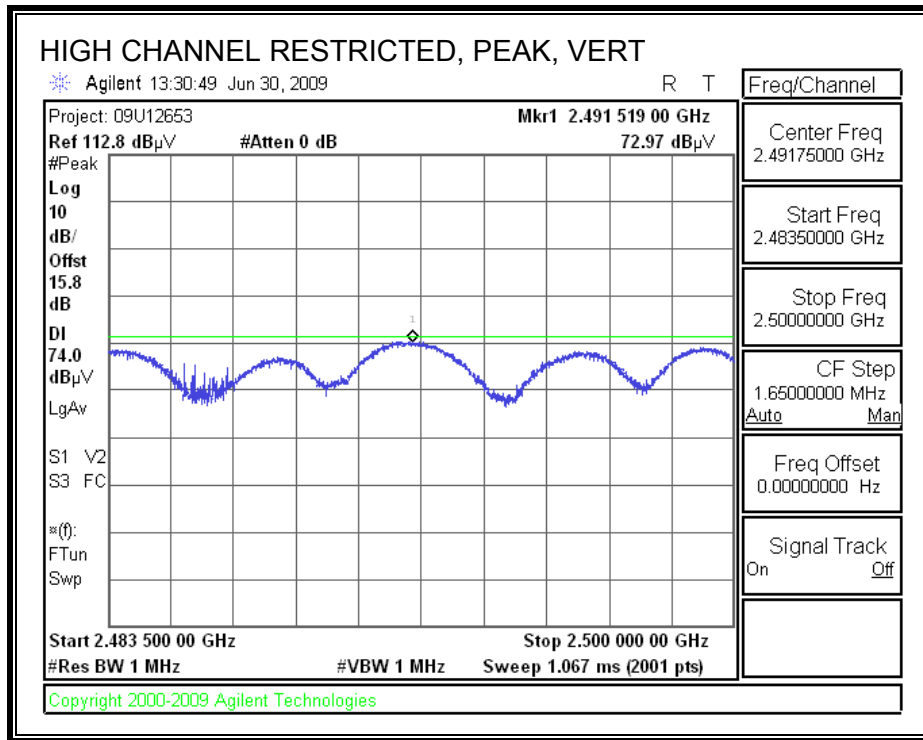

HARMONICS AND SPURIOUS EMISSIONS

High Frequency Measurement																
Compliance Certification Services, Fremont 5m Chamber																
Test Engr:		Thanh Nguyen														
Date:		07/02/09														
Project #:		09U12689														
Company:		Qualcomm Inc.														
EUT Description:		5000 series Ethernet Adapter card														
EUT M/N:		65-VN663-P2														
Test Target:		FCC15.247														
Mode Oper:		Transmit 2.4GHz band HT40 mode														
f	Measurement Frequency		Amp	Preamp Gain		Average Field Strength Limit										
Dist	Distance to Antenna		D Corr	Distance Correct to 3 meters		Peak Field Strength Limit										
Read	Analyzer Reading		Avg	Average Field Strength @ 3 m		Margin vs. Average Limit										
AF	Antenna Factor		Peak	Calculated Peak Field Strength		Margin vs. Peak Limit										
CL	Cable Loss		HPF	High Pass Filter												
f GHz	Dist (m)	Read dBuV	AF dB/m	CL dB	Amp dB	D Corr dB	Fltr dB	Corr. dB	Limit dBuV/m	Margin dB	Ant. Pol. V/H	Det. P/A/QP	Ant.High cm	Table Angle Degree	Notes	
2.4GHz band HT40 Low Ch																
4.844	3.0	43.9	33.1	5.8	-36.5	0.0	0.6	47.0	74.0	-27.0	V	P	100.2	230.8		
4.844	3.0	38.7	33.1	5.8	-36.5	0.0	0.6	41.7	54.0	-12.3	V	A	100.2	230.8		
7.266	3.0	37.1	35.2	7.2	-36.2	0.0	0.6	43.9	74.0	-30.1	V	P	150.2	104.8	Noise floor	
7.266	3.0	24.9	35.2	7.2	-36.2	0.0	0.6	31.8	54.0	-22.2	V	A	150.2	104.8	Noise floor	
4.844	3.0	38.9	33.1	5.8	-36.5	0.0	0.6	41.9	74.0	-32.1	H	P	100.0	252.7		
4.844	3.0	30.2	33.1	5.8	-36.5	0.0	0.6	33.2	54.0	-20.8	H	A	100.0	252.7		
7.266	3.0	37.2	35.2	7.2	-36.2	0.0	0.6	44.1	74.0	-29.9	H	P	179.7	289.1	Noise floor	
7.266	3.0	24.9	35.2	7.2	-36.2	0.0	0.6	31.8	54.0	-22.2	H	A	179.7	289.1	Noise floor	
2.4GHz band HT40 mid. ch																
4.874	3.0	50.6	33.1	5.9	-36.5	0.0	0.6	53.5	74.0	-20.5	V	P	100.0	228.0		
4.874	3.0	36.0	33.1	5.9	-36.5	0.0	0.6	39.0	54.0	-15.0	V	A	100.0	228.0		
7.311	3.0	47.5	35.4	7.3	-36.2	0.0	0.6	54.3	74.0	-19.7	V	P	155.3	171.6		
7.311	3.0	29.8	35.4	7.3	-36.2	0.0	0.6	36.7	54.0	-17.3	V	A	155.3	171.6		
12.185	3.0	41.4	39.0	9.9	-35.4	0.0	0.9	55.7	74.0	-18.3	V	P	168.7	159.4	Noise floor	
12.185	3.0	27.7	39.0	9.9	-35.4	0.0	0.9	41.9	54.0	-12.1	V	A	168.7	159.4	Noise floor	
4.874	3.0	43.1	33.1	5.9	-36.5	0.0	0.6	46.1	74.0	-27.9	H	P	100.0	247.0		
4.874	3.0	30.6	33.1	5.9	-36.5	0.0	0.6	33.6	54.0	-20.4	H	A	100.0	247.0		
7.311	3.0	40.7	35.4	7.3	-36.2	0.0	0.6	47.6	74.0	-26.4	H	P	125.6	100.0	Noise floor	
7.311	3.0	27.8	35.4	7.3	-36.2	0.0	0.6	34.7	54.0	-19.3	H	A	125.6	100.0	Noise floor	
12.185	3.0	41.0	39.0	9.9	-35.4	0.0	0.9	55.2	74.0	-18.8	H	P	159.2	105.3	Noise floor	
12.185	3.0	27.7	39.0	9.9	-35.4	0.0	0.9	41.9	54.0	-12.1	H	A	159.2	105.3	Noise floor	
2.4GHz band HT40 high ch																
4.904	3.0	42.6	33.1	5.9	-36.5	0.0	0.6	45.8	74.0	-28.2	V	P	100.3	231.0		
4.904	3.0	37.8	33.1	5.9	-36.5	0.0	0.6	41.0	54.0	-13.0	V	A	100.3	231.0		
7.356	3.0	36.8	35.4	7.3	-36.2	0.0	0.6	43.8	74.0	-30.2	V	P	158.8	168.9		
7.356	3.0	24.6	35.4	7.3	-36.2	0.0	0.6	31.7	54.0	-22.3	V	A	158.8	168.9		
12.260	3.0	38.0	39.0	9.9	-35.4	0.0	0.9	52.3	74.0	-21.7	V	P	171.9	163.5	Noise floor	
12.260	3.0	24.1	39.0	9.9	-35.4	0.0	0.9	38.5	54.0	-15.5	V	A	171.9	163.5	Noise floor	
4.904	3.0	38.7	33.1	5.9	-36.5	0.0	0.6	41.8	74.0	-32.2	H	P	100.0	251.0		
4.904	3.0	30.6	33.1	5.9	-36.5	0.0	0.6	33.7	54.0	-20.3	H	A	100.0	251.0		
7.356	3.0	36.3	35.4	7.3	-36.2	0.0	0.6	43.4	74.0	-30.6	H	P	142.9	101.2	Noise floor	
7.356	3.0	24.6	35.4	7.3	-36.2	0.0	0.6	31.7	54.0	-22.3	H	A	142.9	101.2	Noise floor	
Rev. 4.1.2.7																
Note: No other emissions were detected above the system noise floor.																

8.2.5. 802.11a MODE IN THE 5.8 GHz BAND

HARMONICS AND SPURIOUS EMISSIONS

High Frequency Measurement															
Compliance Certification Services, Fremont 5m Chamber															
Test Engr:		Thanh Nguyen													
Date:		07/01/09													
Project #:		09U12653													
Company:		Qualcomm Inc.													
EUT Description:		5000 series Ethernet Adapter card													
EUT M/N:		65-VN663-P2													
Test Target:		FCC15.407													
Mode Oper:		Transmit a mode													
f	Measurement	Frequency	Amp	Preamp	Gain						Average Field Strength Limit				
Dist	Distance to Antenna	D Corr	Distance Correct to 3 meters								Peak Field Strength Limit				
Read	Analyzer Reading	Avg	Average Field Strength @ 3 m								Margin vs. Average Limit				
AF	Antenna Factor	Peak	Calculated Peak Field Strength								Margin vs. Peak Limit				
CL	Cable Loss	HPF	High Pass Filter												
f GHz	Dist (m)	Read dBuV	AF dB/m	CL dB	Amp dB	D Corr dB	Fitr dB	Corr dBuV/m	Limit dBuV/m	Margin dB	Ant. Pol V/H	Det P/A/QP	Ant.High cm	Table Angle Degree	Notes
Low 5475Mhz 19dbm															
11.490	3.0	45.5	38.4	9.5	-35.9	0.0	0.0	57.6	74.0	-16.4	V	P	144.7	14.0	
11.490	3.0	33.5	38.4	9.5	-35.9	0.0	0.7	45.3	54.0	-8.7	V	A	144.7	14.0	
11.490	3.0	36.8	38.4	9.5	-35.9	0.0	0.7	49.5	74.0	-24.5	H	P	158.3	295.5	
11.490	3.0	24.3	38.4	9.5	-35.9	0.0	0.7	37.0	54.0	-17.0	H	A	158.3	295.5	
22.980	3.0	35.2	36.1	14.6	-34.3	0.0	0.0	51.5	74.0	-22.5	H	P	107.8	117.1	Noise floor
22.980	3.0	22.2	36.1	14.6	-34.3	0.0	0.0	38.6	54.0	-15.4	H	A	107.8	117.1	Noise floor
22.980	3.0	34.7	36.1	14.6	-34.3	0.0	0.0	51.0	74.0	-23.0	V	P	100.8	357.2	Noise floor
22.980	3.0	22.4	36.1	14.6	-34.3	0.0	0.0	38.7	54.0	-15.3	V	A	100.8	357.2	Noise floor
Mid ch 5785Mhz 19dbm															
11.570	3.0	43.8	38.5	9.5	-35.8	0.0	0.7	56.0	74.0	-18.0	V	P	158.4	23.6	
11.570	3.0	37.9	38.5	9.5	-35.8	0.0	0.7	50.2	54.0	-3.8	V	A	158.4	23.6	
11.570	3.0	39.4	38.5	9.5	-35.8	0.0	0.7	51.7	74.0	-22.3	H	P	149.9	298.2	
11.570	3.0	33.0	38.5	9.5	-35.8	0.0	0.7	45.2	54.0	-8.8	H	A	149.9	298.2	
High ch 5825Mhz 19dbm															
11.650	3.0	47.2	38.6	9.6	-35.7	0.0	0.7	59.6	74.0	-14.4	V	P	141.6	22.0	
11.650	3.0	31.0	38.6	9.6	-35.7	0.0	0.7	43.4	54.0	-10.6	V	A	141.6	22.0	
11.650	3.0	36.9	38.6	9.6	-35.7	0.0	0.7	49.3	74.0	-24.7	H	P	164.1	192.8	
11.650	3.0	24.7	38.6	9.6	-35.7	0.0	0.7	37.1	54.0	-16.9	H	A	164.1	192.8	
Note: No other emissions were detected above the system noise floor.															

8.2.6. 802.11n HT20 MODE IN THE 5.8 GHz BAND

HARMONICS AND SPURIOUS EMISSIONS

High Frequency Measurement																
Compliance Certification Services, Fremont 5m Chamber																
Test Engr:		Thanh Nguyen														
Date:		07/01/09														
Project #:		09U12653														
Company:		Qualcomm Inc.														
EUT Description:		5000 series Ethernet Adapter card														
EUT M/N:		65-VN663-P2														
Test Target:		FCC15.407														
Mode Oper:		Transmit HT20 mode														
f	Measurement Frequency			Amp	Preamp Gain			Average Field Strength Limit								
Dist	Distance to Antenna			D Corr	Distance Correct to 3 meters			Peak Field Strength Limit								
Read	Analyzer Reading			Avg	Average Field Strength @ 3 m			Margin vs. Average Limit								
AF	Antenna Factor			Peak	Calculated Peak Field Strength			Margin vs. Peak Limit								
CL	Cable Loss			HPF	High Pass Filter											
f GHz	Dist (m)	Read dBuV	AF dB/m	CL dB	Amp dB	D Corr dB	Filtr dB	Corr dB	Limit dBuV/m	Margin dB	Ant Pol V/H	Det P/A/QP	Ant.High cm	Table Angle Degree	Notes	
Low Ch 5745MHz, set 19dbm																
11.490	3.0	42.4	38.4	9.5	-35.9	0.0	0.7	54.4	74.0	-19.6	V	P	118.5	27.3		
11.490	3.0	37.5	38.4	9.5	-35.9	0.0	0.7	49.6	54.0	-4.4	V	A	118.5	27.3		
11.490	3.0	39.1	38.4	9.5	-35.9	0.0	0.7	51.1	74.0	-22.9	H	P	128.7	309.9		
11.490	3.0	31.9	38.4	9.5	-35.9	0.0	0.7	43.9	54.0	-10.1	H	A	128.7	309.9		
Mid Ch 5785MHz, set 19dbm																
11.570	3.0	43.1	38.5	9.5	-35.8	0.0	0.7	55.3	74.0	-18.7	V	P	119.1	25.5		
11.570	3.0	38.5	38.5	9.5	-35.8	0.0	0.7	50.7	54.0	-3.3	V	A	119.1	25.5		
11.570	3.0	37.8	38.5	9.5	-35.8	0.0	0.7	50.1	74.0	-23.9	H	P	162.2	130.3		
11.570	3.0	29.5	38.5	9.5	-35.8	0.0	0.7	41.7	54.0	-12.3	H	A	162.2	130.3		
High 5825MHz, set 19dbm																
11.650	3.0	49.4	38.6	9.6	-35.7	0.0	0.7	61.9	74.0	-12.1	V	P	149.3	35.4		
11.650	3.0	30.4	38.6	9.6	-35.7	0.0	0.7	42.8	54.0	-11.2	V	A	149.3	35.4		
11.650	3.0	37.6	38.6	9.6	-35.7	0.0	0.7	50.7	74.0	-23.3	H	P	199.0	226.8		
11.650	3.0	24.1	38.6	9.6	-35.7	0.0	0.7	37.3	54.0	-16.7	H	A	199.0	226.8		

Note: No other emissions were detected above the system noise floor.

8.2.7. 802.11n HT40 MODE IN THE 5.8 GHz BAND

HARMONICS AND SPURIOUS EMISSIONS

High Frequency Measurement
 Compliance Certification Services, Fremont 5m Chamber

Company: Qualcomm
 Project #: 09U12689
 Date: 07/07/09
 Test Engineer: Doug Anderson
 Configuration: EUT w/Support Notebook
 Mode: Tx / HT40

Test Equipment:

Horn 1-18GHz	Pre-amplifier 1-26GHz	Pre-amplifier 26-40GHz	Horn > 18GHz	Limit
T73; S/N: 6717 @3m	T144 Miteq 3008A00931			FCC 15.205

Hi Frequency Cables

3' cable 22807700	12' cable 22807600	20' cable 22807500	HPF	Reject Filter	Peak Measurements RBW=VBW=1MHz
3' cable 22807700	12' cable 22807600	20' cable 22807500	HPF_7.6GHz		Average Measurements RBW=1MHz, VBW=10Hz

f GHz	Dist (m)	Read Pk dBuV	Read Avg. dBuV	AF dB/m	CL dB	Amp dB	D Corr dB	Fltr dB	Peak dBuV/m	Avg dBuV/m	Pk Lim dBuV/m	Avg Lim dBuV/m	Pk Mar dB	Avg Mar dB	Notes (V/H)
Low Ch. 5755															
11.510	3.0	47.2	32.7	38.4	9.5	-35.8	0.0	0.7	60.0	45.4	74	54	-14.0	-8.6	V
11.510	3.0	39.8	27.7	38.4	9.5	-35.8	0.0	0.7	52.6	40.5	74	54	-21.4	-13.5	H (Noise Floor)
High Ch. 5795															
11.590	3.0	47.5	37.0	38.5	9.5	-35.8	0.0	0.7	60.5	50.0	74	54	-13.5	-4.0	V
11.510	3.0	40.3	28.3	38.4	9.5	-35.8	0.0	0.7	53.1	41.1	74	54	-20.9	-12.9	H (Noise Floor)

Rev. 11.10.08

f	Measurement Frequency	Amp	Preamp Gain	Avg Lim	Average Field Strength Limit
Dist	Distance to Antenna	D Corr	Distance Correct to 3 meters	Pk Lim	Peak Field Strength Limit
Read	Analyzer Reading	Avg	Average Field Strength @ 3 m	Avg Mar	Margin vs. Average Limit
AF	Antenna Factor	Peak	Calculated Peak Field Strength	Pk Mar	Margin vs. Peak Limit
CL	Cable Loss	HPF	High Pass Filter		

8.3. WORST-CASE BELOW 1 GHz

SPURIOUS EMISSIONS 30 TO 1000 MHz (WORST-CASE CONFIGURATION)

HORIZONTAL

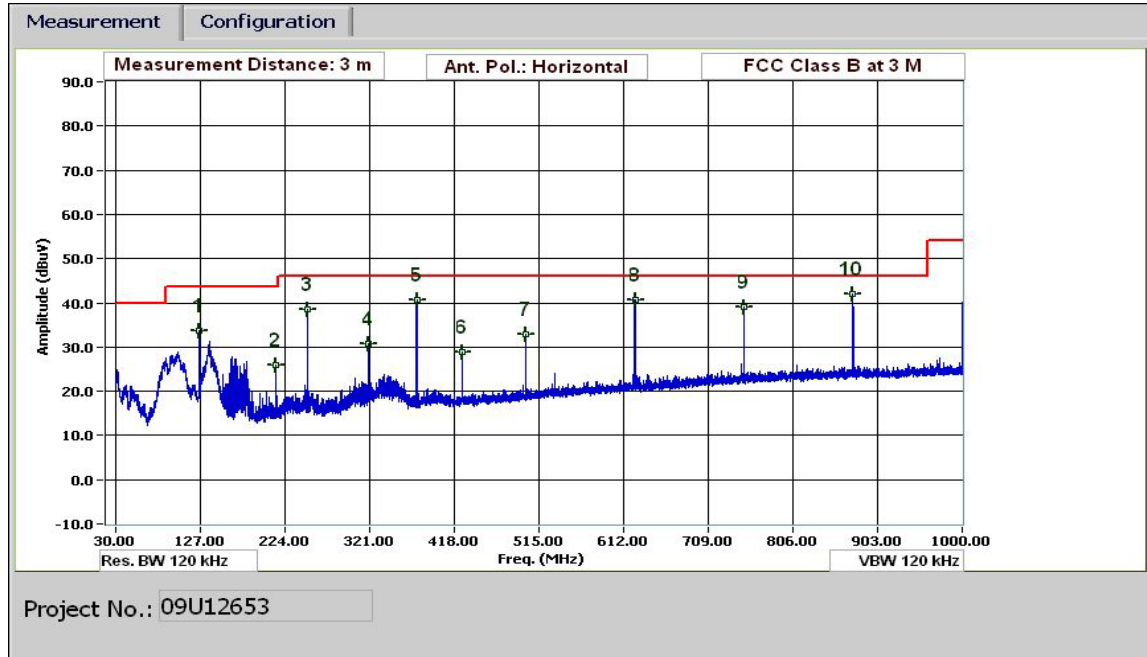

30-1000MHz Frequency Measurement
 Compliance Certification Services, Fremont 5m Chamber

Test Engr: Vien Tran
 Date: 06/26/09
 Project #: 09U12689
 Company: Qualcomm
 EUT Description: 802.11n 4x4 WLAN Ethernet Adapter
 EUT M/N: Non-DFS:65-VN663-P1
 Test Target: FCC Class B
 Mode Oper: Tx Worst-Case

f Measurement Frequency Amp Preamp Gain Margin Margin vs. Limit
 Dist Distance to Antenna D Corr Distance Correct to 3 meters
 Read Analyzer Reading Filter Filter Insert Loss
 AF Antenna Factor Corr Calculated Field Strength
 CL Cable Loss Limit Field Strength Limit

f MHz	Dist (m)	Read dBuV	AF dB/m	CL dB	Amp dB	D Corr dB	Filter dB	Corr. dB	Limit dBuV/m	Margin dB	Ant Pol V/H	Det P/A/Q/P	Notes
125.044	3.0	47.3	13.7	1.1	28.3	0.0	0.0	33.7	43.5	-9.8	H	EP	
213.368	3.0	40.9	11.9	1.3	28.2	0.0	0.0	25.9	43.5	-17.6	H	EP	
249.969	3.0	53.5	11.8	1.4	28.2	0.0	0.0	38.5	46.0	-7.5	H	EP	
319.932	3.0	43.6	13.7	1.6	28.1	0.0	0.0	30.8	46.0	-15.2	H	EP	
375.014	3.0	52.5	14.5	1.7	28.1	0.0	0.0	40.7	46.0	-5.3	H	EP	
426.616	3.0	39.5	15.4	1.9	28.0	0.0	0.0	28.8	46.0	-17.2	H	EP	
499.939	3.0	41.9	16.7	2.0	27.8	0.0	0.0	32.9	46.0	-13.1	H	EP	
624.985	3.0	47.2	18.7	2.3	27.4	0.0	0.0	40.7	46.0	-5.3	H	EP	
749.910	3.0	43.5	20.3	2.5	27.3	0.0	0.0	39.0	46.0	-7.0	H	EP	
874.955	3.0	45.4	21.6	2.8	27.7	0.0	0.0	42.1	46.0	-3.9	H	EP	

Rev. 1.27.09

Note: No other emissions were detected above the system noise floor.

VERTICAL

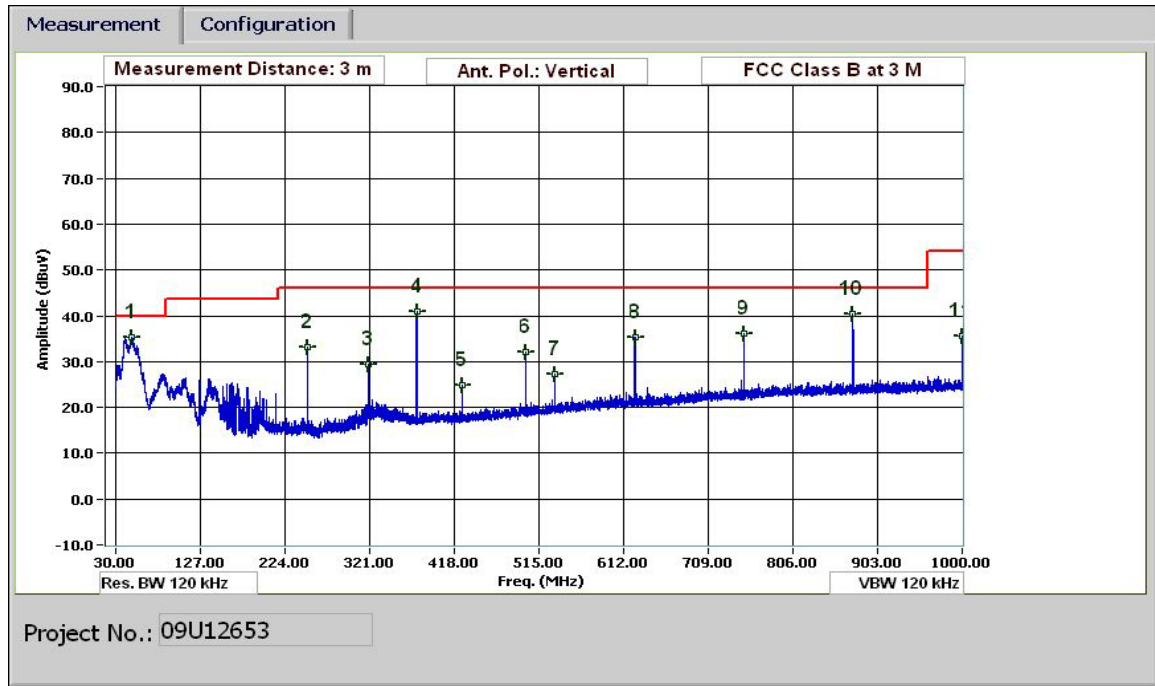

30-1000MHz Frequency Measurement
 Compliance Certification Services, Fremont 5m Chamber

Test Engr: Vien Tran
 Date: 06/26/09
 Project #: 09U12689
 Company: Qualcomm
 EUT Description: 802.11n 4x4 WLAN Ethernet Adapter
 EUT M/N: Non-DFS:65-VN663-P1
 Test Target: FCC Class B
 Mode Oper: Tx Worst-Case

f Measurement Frequency Amp Preamp Gain Margin Margin vs. Limit
 Dist Distance to Antenna D Corr Distance Correct to 3 meters
 Read Analyzer Reading Filter Filter Insert Loss
 AF Antenna Factor Corr. Calculated Field Strength
 CL Cable Loss Limit Field Strength Limit

f MHz	Dist (m)	Read dBuV	AF dB/m	CL dB	Amp dB	D Corr dB	Filter dB	Corr. dBuV/m	Limit dBuV/m	Margin dB	Ant. Pol. V/H	Det. P/A/QP	Notes
48.001	3.0	53.6	9.3	0.6	28.4	0.0	0.0	35.2	40.0	-4.8	V	EP	
249.969	3.0	48.3	11.8	1.4	28.2	0.0	0.0	33.2	46.0	-12.8	V	EP	
320.052	3.0	42.2	13.7	1.6	28.1	0.0	0.0	29.4	46.0	-16.6	V	EP	
375.014	3.0	52.8	14.5	1.7	28.1	0.0	0.0	41.0	46.0	-5.0	V	EP	
426.736	3.0	35.5	15.4	1.9	28.0	0.0	0.0	24.8	46.0	-21.2	V	EP	
499.939	3.0	41.2	16.7	2.0	27.8	0.0	0.0	32.1	46.0	-13.9	V	EP	
533.301	3.0	35.7	17.3	2.1	27.7	0.0	0.0	27.3	46.0	-18.7	V	EP	
624.985	3.0	41.8	18.7	2.3	27.4	0.0	0.0	35.4	46.0	-10.6	V	EP	
749.910	3.0	40.6	20.3	2.5	27.3	0.0	0.0	36.1	46.0	-9.9	V	EP	
874.955	3.0	43.7	21.6	2.8	27.7	0.0	0.0	40.4	46.0	-5.6	V	EP	
999.880	3.0	37.9	22.5	3.0	27.9	0.0	0.0	35.4	54.0	-18.6	V	EP	

Rev. 1.27.09

Note: No other emissions were detected above the system noise floor.

9. AC POWER LINE CONDUCTED EMISSIONS

LIMITS

FCC §15.207 (a)

RSS-Gen 7.2.2

Frequency of Emission (MHz)	Conducted Limit (dBuV)	
	Quasi-peak	Average
0.15-0.5	66 to 56*	56 to 46*
0.5-5	56	46
5-30	60	50

*Decreases with the logarithm of the frequency.

TEST PROCEDURE

ANSI C63.4

RESULTS

2.4 GHz BAND

6 WORST EMISSIONS

CONDUCTED EMISSIONS DATA (115VAC 60Hz)										
Freq. (MHz)	Reading			Class (dB)	Limit QP	FCC B		Margin		Remark L1 / L2
	PK (dBuV)	QP (dBuV)	AV (dBuV)			AV	QP (dB)	AV (dB)		
0.19	51.85	--	36.05	0.00	63.86	53.86	-12.01	-17.81	L1	
2.95	46.98	--	27.25	0.00	56.00	46.00	-9.02	-18.75	L1	
19.12	41.29	--	28.92	0.00	60.00	50.00	-18.71	-21.08	L1	
0.19	51.41	--	35.46	0.00	63.86	53.86	-12.45	-18.40	L2	
2.95	45.71	--	26.96	0.00	56.00	46.00	-10.29	-19.04	L2	
19.12	41.90	--	29.16	0.00	60.00	50.00	-18.10	-20.84	L2	
6 Worst Data										

LINE 1 RESULTS

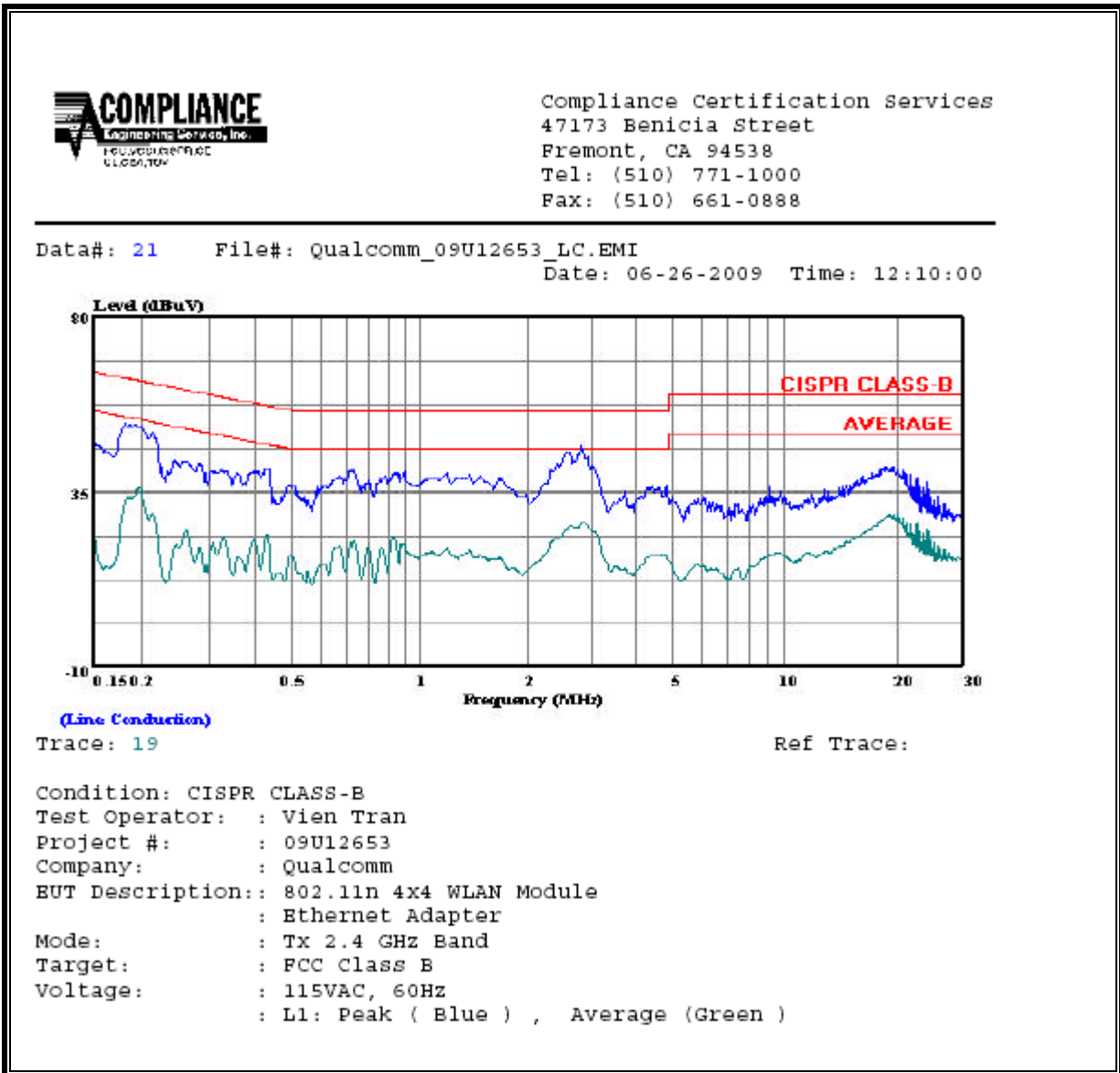

Compliance Certification Services
47173 Benicia Street
Fremont, CA 94538
Tel: (510) 771-1000
Fax: (510) 661-0888

Data#: 21 File#: Qualcomm_09U12653_LC.EMI
Date: 06-26-2009 Time: 12:10:00

(Line Conduction)
Trace: 19 Ref Trace:

Condition: CISPR CLASS-B
Test Operator: : Vien Tran
Project #: : 09U12653
Company: : Qualcomm
EUT Description: : 802.11n 4x4 WLAN Module
: Ethernet Adapter
Mode: : TX 2.4 GHz Band
Target: : FCC Class B
Voltage: : 115VAC, 60Hz
: L1: Peak (Blue) , Average (Green)

LINE 2 RESULTS

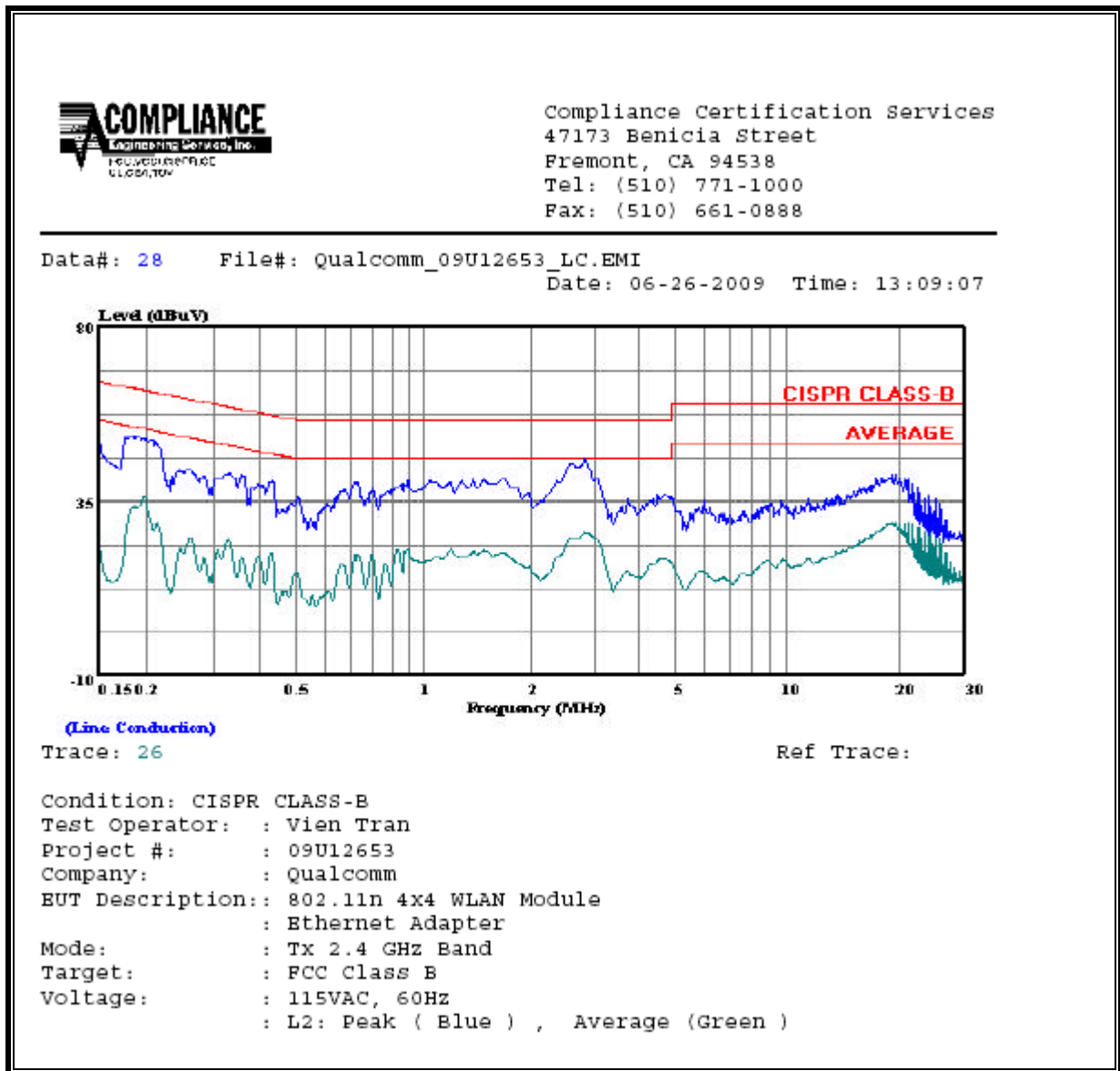

5.8 GHz BAND

6 WORST EMISSIONS

CONDUCTED EMISSIONS DATA (115VAC 60Hz)									
Freq. (MHz)	Reading			Class (dB)	Limit QP	FCC B AV	Margin		Remark L1 / L2
	PK (dBuV)	QP (dBuV)	AV (dBuV)				QP (dB)	AV (dB)	
0.19	51.41	--	33.87	0.00	63.86	53.86	-12.45	-19.99	L1
2.95	44.80	--	27.60	0.00	56.00	46.00	-11.20	-18.40	L1
19.12	41.71	--	30.40	0.00	60.00	50.00	-18.29	-19.60	L1
0.19	51.34	--	33.94	0.00	63.86	53.86	-12.52	-19.92	L2
2.95	44.13	--	27.56	0.00	56.00	46.00	-11.87	-18.44	L2
19.12	40.89	--	29.56	0.00	60.00	50.00	-19.11	-20.44	L2
6 Worst Data									

LINE 1 RESULTS

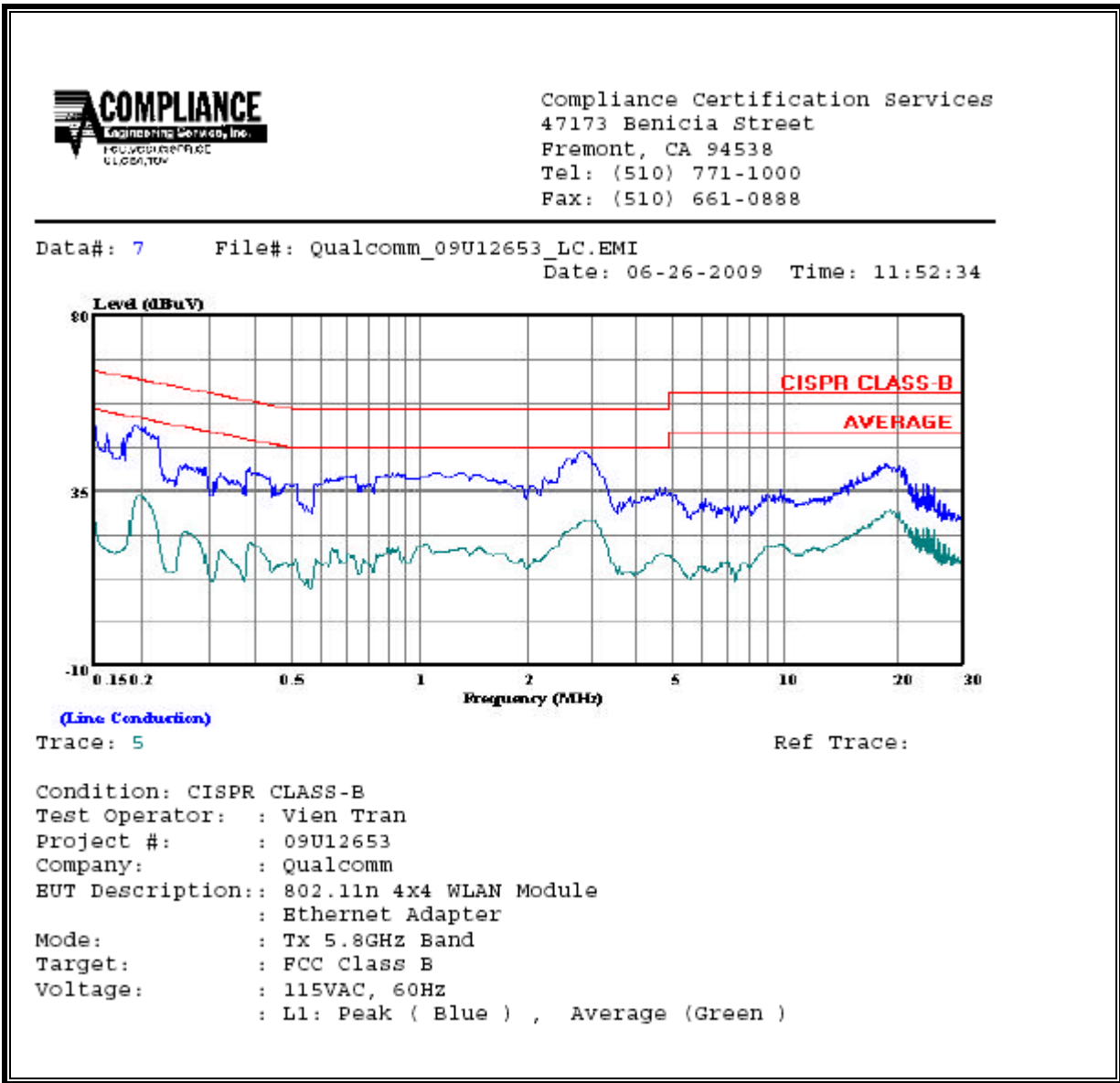

LINE 2 RESULTS

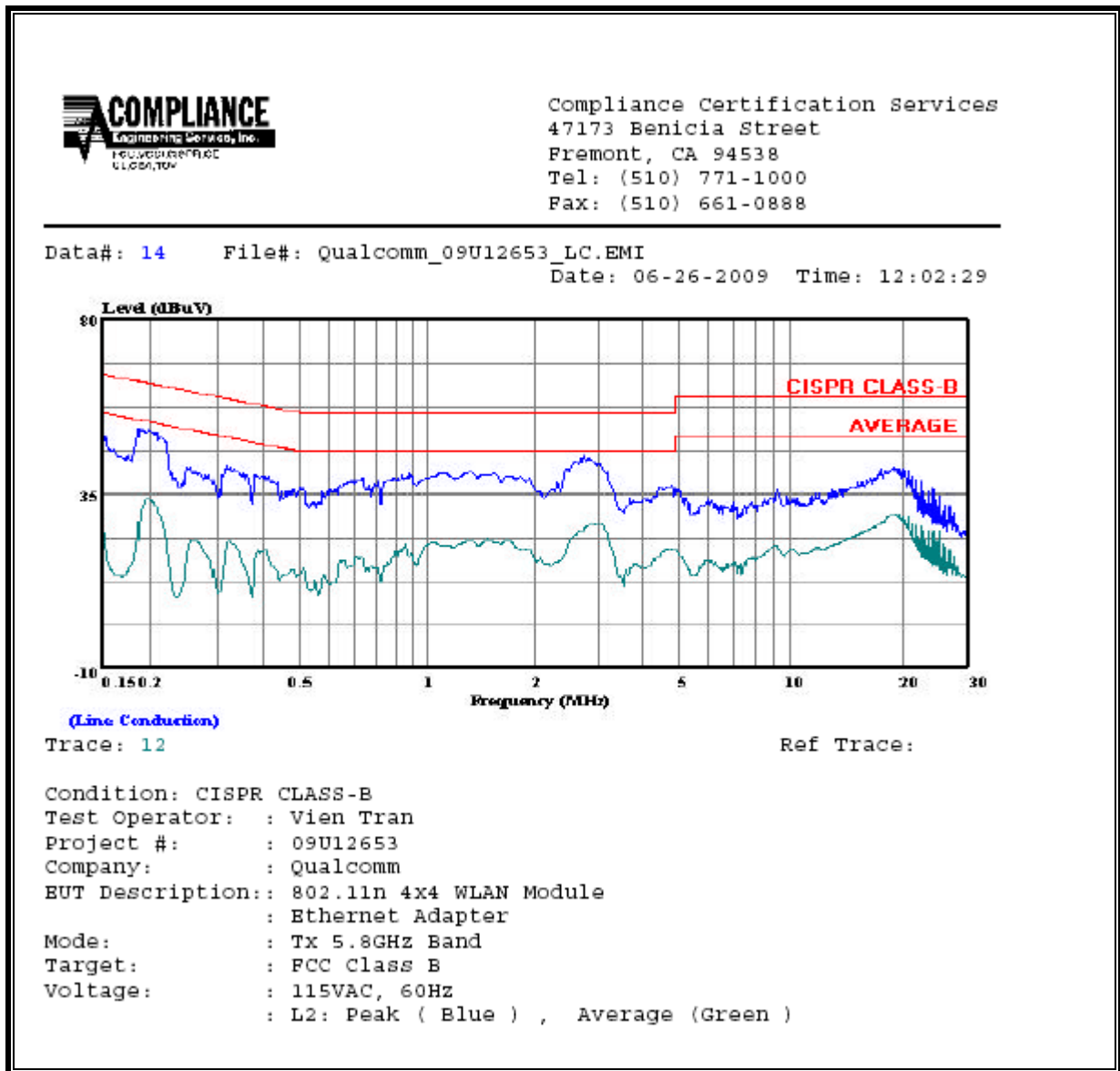

10. MAXIMUM PERMISSIBLE EXPOSURE

FCC RULES

§1.1310 The criteria listed in Table 1 shall be used to evaluate the environmental impact of human exposure to radio-frequency (RF) radiation as specified in §1.1307(b), except in the case of portable devices which shall be evaluated according to the provisions of §2.1093 of this chapter.

TABLE 1—LIMITS FOR MAXIMUM PERMISSIBLE EXPOSURE (MPE)

Frequency range (MHz)	Electric field strength (V/m)	Magnetic field strength (A/m)	Power density (mW/cm ²)	Averaging time (minutes)
(A) Limits for Occupational/Controlled Exposures				
0.3–3.0	614	1.63	*(100)	6
3.0–30	1842/f	4.89/f	*(900/f ²)	6
30–300	61.4	0.163	1.0	6
300–1500	f/300	6
1500–100,000	5	6
(B) Limits for General Population/Uncontrolled Exposure				
0.3–1.34	614	1.63	*(100)	30
1.34–30	824/f	2.19/f	*(180/f ²)	30

TABLE 1—LIMITS FOR MAXIMUM PERMISSIBLE EXPOSURE (MPE)—Continued

Frequency range (MHz)	Electric field strength (V/m)	Magnetic field strength (A/m)	Power density (mW/cm ²)	Averaging time (minutes)
30–300	27.5	0.073	0.2	30
300–1500	f/1500	30
1500–100,000	1.0	30

f = frequency in MHz

* = Plane-wave equivalent power density

NOTE 1 TO TABLE 1: Occupational/controlled limits apply in situations in which persons are exposed as a consequence of their employment provided those persons are fully aware of the potential for exposure and can exercise control over their exposure. Limits for occupational/controlled exposure also apply in situations when an individual is transient through a location where occupational/controlled limits apply provided he or she is made aware of the potential for exposure.

NOTE 2 TO TABLE 1: General population/uncontrolled exposures apply in situations in which the general public may be exposed, or in which persons that are exposed as a consequence of their employment may not be fully aware of the potential for exposure or can not exercise control over their exposure.

IC RULES

IC Safety Code 6, Section 2.2.1 (a) A person other than an RF and microwave exposed worker shall not be exposed to electromagnetic radiation in a frequency band listed in Column 1 of Table 5, if the field strength exceeds the value given in Column 2 or 3 of Table 5, when averaged spatially and over time, or if the power density exceeds the value given in Column 4 of Table 5, when averaged spatially and over time.

**Table 5
 Exposure Limits for Persons Not Classed As RF and Microwave Exposed Workers (Including the General Public)**

1 Frequency (MHz)	2 Electric Field Strength; rms (V/m)	3 Magnetic Field Strength; rms (A/m)	4 Power Density (W/m ²)	5 Averaging Time (min)
0.003–1	280	2.19		6
1–10	280/ <i>f</i>	2.19/ <i>f</i>		6
10–30	28	2.19/ <i>f</i>		6
30–300	28	0.073	2*	6
300–1 500	1.585 <i>f</i> ^{0.5}	0.0042 <i>f</i> ^{0.5}	<i>f</i> /150	6
1 500–15 000	61.4	0.163	10	6
15 000–150 000	61.4	0.163	10	616 000 / <i>f</i> ^{1.2}
150 000–300 000	0.158 <i>f</i> ^{0.5}	4.21 x 10 ⁻⁴ <i>f</i> ^{0.5}	6.67 x 10 ⁻⁵ <i>f</i>	616 000 / <i>f</i> ^{1.2}

* Power density limit is applicable at frequencies greater than 100 MHz.

- Notes:**
1. Frequency, *f*, is in MHz.
 2. A power density of 10 W/m² is equivalent to 1 mW/cm².
 3. A magnetic field strength of 1 A/m corresponds to 1.257 microtesla (μT) or 12.57 milligauss (mG).

EQUATIONS

Power density is given by:

$$S = \text{EIRP} / (4 * \text{Pi} * D^2)$$

where

- S = Power density in W/m²
- EIRP = Equivalent Isotropic Radiated Power in W
- D = Separation distance in m

Power density in units of W/m² is converted to units of mWc/m² by dividing by 10.

Distance is given by:

$$D = \text{SQRT} (\text{EIRP} / (4 * \text{Pi} * S))$$

where

- D = Separation distance in m
- EIRP = Equivalent Isotropic Radiated Power in W
- S = Power density in W/m²

In the table(s) below, Power and Gain are entered in units of dBm and dBi respectively and conversions to linear forms are used for the calculations.

LIMITS

From FCC §1.1310 Table 1 (B), the maximum value of S = 1.0 mW/cm²
 From IC Safety Code 6, Section 2.2 Table 5 Column 4, S = 10 W/m²

RESULTS

(MPE distance equals 20 cm)

Band	Mode	Separation Distance (m)	Output Power (dBm)	Antenna Gain (dBi)	IC Power Density (W/m ²)	FCC Power Density (mW/cm ²)
2.4 GHz	Legacy	0.20	26.62	8.02	5.79	0.579
2.4 GHz	MIMO	0.20	26.09	2	1.28	0.128
5.8 GHz	Legacy	0.20	25.22	9.02	5.28	0.528
5.8 GHz	MIMO	0.20	25.19	3	1.31	0.131